

---

**User's  
Manual**

CL250  
Clamp-on Tester  
クランプテスタ

IM CL250

---

保証書付

---

**YOKOGAWA** ◆

横河計測株式会社  
Yokogawa Test & Measurement Corporation

IM CL250  
2018.6 12 版 (KYOU)

# Contents

---

■ Precautions for Safety Use of the Instrument .....	i
1. Instrument Layout .....	1
2. Measurement .....	3
2.1 Preparation for Measurement .....	3
2.2 DC Current Measurement .....	3
2.3 AC Current Measurement .....	4
2.4 DC Voltage Measurement .....	5
2.5 AC Voltage Measurement .....	6
2.6 Resistance Measurement .....	7
2.7 Continuity Check (400Ω range fixed) .....	7
2.8 MAX Measurement .....	8
3. Other Functions .....	9
3.1 Sleep Function .....	9
3.2 Data Hold Function .....	9
3.3 OUTPUT Terminal (For current ranges only) .....	10
3.4 Optional Accessories .....	11
4. Battery Replacement .....	12
5. Specifications .....	13
6. Calibration and After-sales Service .....	16

## ■ Precautions for Safe Use of the Instrument

When handling the instrument, ALWAYS observe all of the cautionary notes on safety given below. Yokogawa M&C Corporation is not at all liable for damage resulting from misuse of this product by the user that is contrary to these cautionary notes.

Various symbols are used on the instrument and in this manual to ensure the product is used safely and to protect operators and property from possible hazards or damage. The following safety symbols are used where appropriate. Read the explanations carefully and familiarize yourself with the symbols before reading the text.

The instrument and this manual use the following safety symbols:

**Danger! Handle with Care.**



This symbol indicates that the operator must refer to an explanation in the User's Manual in order to avoid the risk of personal injury or death and/or damage to the instrument.



**Double Insulation**

This symbol indicates double insulation.



**AC Voltage/Current**

This symbol indicates AC voltage or current.



**DC Voltage/Current**

This symbol indicates DC voltage or current.



**AC/DC Voltage/Current**

This symbol indicates AC/DC voltage or current.



**Ground**

This symbol indicates ground (earth).



Indicates that this instrument can clamp on bare conductors when measuring a voltage corresponding to the applicable Measurement Category, which is marked next to this symbol.



### **WARNING**

---

---

Indicates that there is a possibility of serious personal injury or loss of life if the operating procedure is not followed correctly and describes the precautions for avoiding such injury or loss of life.

---

---



### **CAUTION**

---

---

Indicates that there is a possibility of serious personal injury or damage to the instrument if the operating procedure is not followed correctly and describes the precautions for avoiding such injury or damage.

---

---

## NOTE

Draws attention to information essential for understanding the operation and features.



## **WARNING**

---

---

- Never make measurement on a circuit above 750V AC or 1000V DC.
  - Do not use the instrument in an atmosphere where any flammable or explosive gas is present.
  - Do not attempt to make measurement in the presence of flammable gasses, fumes, vapor or dust. Otherwise, the use of the instrument may cause sparking, which can lead to an explosion.
  - Avoid using the instrument if it has been exposed to rain or moisture or if your hands are wet.
  - Do not exceed the maximum allowable input of any measurement range.
  - Never open the battery compartment cover when making measurement.
  - Do not use the instrument if there is any damage to the casing or when the casing is removed.
  - Do not turn the Function Selector switch with plugged in test leads connected to the circuit under test.
  - Do not install substitute parts or make any modification to the instrument. Return the instrument to Yokogawa Meters & Instruments or your distributor for repair or re-calibration.
  - Always switch off the instrument before opening the battery compartment cover for battery replacement.
  - Do not use the test leads that have deteriorated or are defective.
  - Check the test leads continuity
- 
-



## WARNING

To avoid damage to the instrument or electric shock!

The restrictions on the maximum voltage level for which the CL250 testers can be used, depend on the Measurement categories specified by the safety standards. These category specifications are formulated to protect operators against transient impulse voltages in power lines.

Function	Maximum Allowable Input	
	MEASUREMENT CATEGORY III	MEASUREMENT CATEGORY IV
$\sim A, \overline{\sim} A$	AC 2000A rms Measuring circuit voltage : AC 750V rms DC 1000V	AC 2000A rms Measuring circuit voltage : AC 600V rms DC 600V
$\sim V, \overline{\sim} V$	AC 750V rms/DC 1000V	AC 600V rms/DC 600V
Input terminal-to-ground voltage	AC 750V rms/DC 1000V	

0 (None, Other)

Other circuits that are not directly connected to MEAINS.

Measurement category II (CAT.II)

Local level, appliance, portable equipment etc., with smaller transient measurement than CAT.III.

Measurement category III (CAT.III):

Distribution level, fixed installation, with smaller transient measurement than CAT.IV.

Measurement category IV (CAT. IV):

Primary supply level, overhead lines, cable systems, and on.



## CAUTION

- Always make sure to insert each plug of the test leads fully into the appropriate terminal on the instrument.
- Make sure to remove the test leads from the instrument before making current measurement.
- Be sure to set the Function Selector switch to the "OFF" position after use. When the instrument will not be in use for a long period of time, place it in storage after removing the battery.
- Use a damp cloth and detergent for cleaning the instrument. Do not use abrasives or solvents..

## NOTE

- Radiation immunity affects the accuracy of CL250 testers under the conditions specified in EN61000-4-.
- If equipment generating strong electromagnetic interference is located nearby, the testers may malfunction.

# 1. Instrument Layout

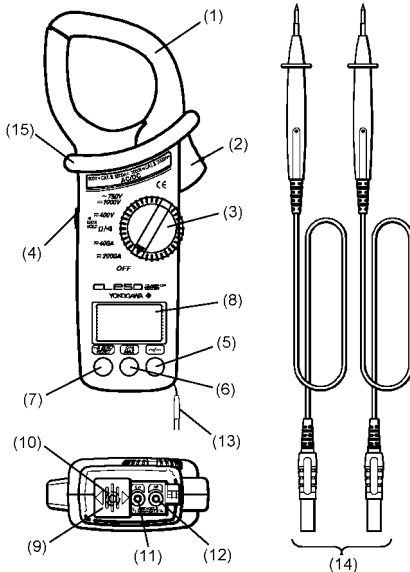

- (1)Transformer Jaws : Pick up current flowing through the conductor.  
 (2)Open/Close Lever : Used to open and close the transformer jaws.  
 (3)Function Selector Switch : Selects function to use. Also switches off the instrument when set to the "OFF" position.

(4)Data Hold Button : Freezes the display reading with "**H**" symbol shown on the display when pushed in.

Note : When the plug is inserted into the output terminal, Data Hold Switch operates as range selection switch. (See section 3.3 OUTPUT Terminal)

(5)  Button : Used to switch the instrument between the AC and DC modes. The instrument is set to the AC mode when it is powered on. Press this button to select the DC mode.

(6)  Button : A press of this button on a current or voltage range turns the instrument to the MAX measurement mode with "**MAX**" shown on the display. Press the button again to exit the MAX mode.

A press of the button on the resistance range turns the instrument to the continuity check mode with "**)))**" symbol shown on the display. In this mode,

the buzzer beeps when the reading is about  $50\Omega$  or less. Press the button again to exit the continuity check mode.

- (7) **ZERO/RESET** Button : Used for zero adjustment on 400A DC range or for resetting the reading in the MAX mode. "AUTO" symbol is shown on the display when zero adjustment is enabled on 400A DC range. (Zero adjustment is available only 400A DC range.)
- (8) LCD Display : Field effect type of liquid crystal display with maximum counts of 3999 and microprocessor-controlled annunciators and the decimal point.

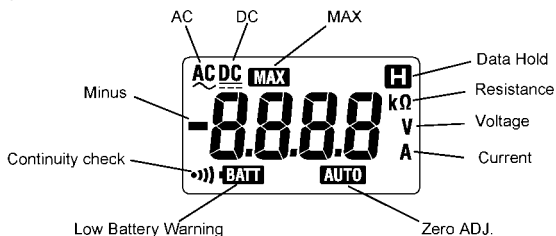

- (9) Terminal Cover : Used to enclose the input terminals (Lo and Hi) when the OUTPUT terminal is in use, thus avoiding accidental application of voltage to the instrument.
- (10) OUTPUT terminal (for current measurement only) : Provides DC voltage in proportion to the reading on an AC or DC current range. (See section 3.3, OUTPUT Terminal.) The voltage is used for such purposes as long term monitoring with a recorder or other recording devices. This terminal cannot be accessed on a voltage or resistance range.
- (11) Lo Terminal : Accepts the black test lead for voltage or resistance measurement.
- (12) Hi Terminal : Accepts the red test lead for voltage or resistance measurement.
- (13) Safety Hand Strap : Prevents the instrument from slipping off the hand during use.
- (14) Test Leads (Model 98072) : Connect to Lo and Hi terminals for voltage or resistance measurement.
- (15) Barrier: It is a part providing protection against electrical shock and ensuring the minimum required air and creepage distances.

## 2. Measurement

### 2.1 Preparation for Measurement



#### CAUTION

- The jaw section is a delicate, precision sensor. Do not subject the jaw to unreasonably strong shock, vibration, or force when using it.
- If dust gets into the tops of the jaws, remove it immediately. Do not close the jaws when dust is trapped in its joints as the sensor may break.
- Please check that the range and mode are set to the desired position before measurement.



### 2.2 DC Current Measurement

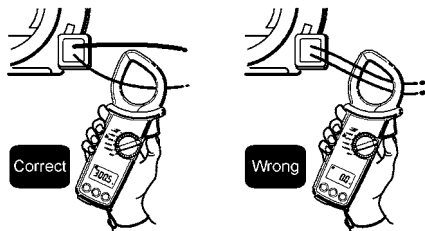

#### WARNING

- Do not make measurement on a circuit above 1000VDC. This may cause shock hazard.
- Do not make current measurement with the test leads connected to the instrument.
- Keep your fingers and hands behind the barrier during measurement.



- (1) Set the Function Selector switch to the " $\sim$  400A" position and press the  button to select the DC mode. "DC" should be shown on the upper left corner of the display.
- (2) With the transformer jaws closed without clamping them onto the conductor, press the  button for about one second to zero adjust the display. ( button is enabled only on 400A DC range.) "AUTO" should be shown on the display.
- (3) Set the Function Selector switch to the position appropriate for the order of the current under test.



- (4) Press the open/close lever to open the transformer jaws and clamp them onto the conductor under test and take the reading on the display. The most accurate reading will be obtained by keeping the conductor at the center of the transformer jaws.

#### NOTE

- During current measurement, keep the transformer jaws fully closed. Otherwise, accurate measurement cannot be made. The maximum measurable conductor size is approx. 55mm in diameter.
- When the current flows from the upside (the display side) to the underside of the instrument, the polarity of the reading is positive and vice versa.
- The output voltage from the OUTPUT terminal may not reduce to nil even if the display is zero adjusted with the  button. In this case, make zero adjustment on the recorder or other device that the output voltage is connected to.
- Turning the Function Selector switch to a position other than DCA cancels the zero adjustment.



### 2.3 AC Current Measurement

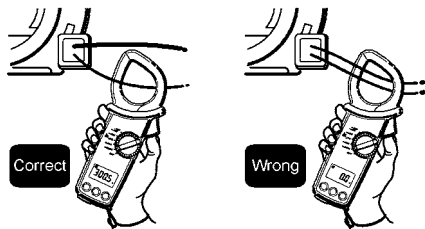

#### WARNING

- 
- Do not make measurement on a circuit above 750V AC. This may cause shock hazard.
  - Do not make current measurement with the test leads connected to the Hi and Lo terminals.
  - Keep your fingers and hands behind the barrier during measurement.
- 



- (1) Set the Function Selector switch to the "400A" or "2000A" position and select the AC mode. If the instrument is in the DC mode, press the  button once to select the AC mode. (The instrument is set to the AC mode when it is powered on.) "AC" should be shown on the upper left corner of the display.

(2) Press the open/close lever to open the transformer jaws and clamp them onto the conductor under test and take the reading on the display. The most accurate reading will be obtained by keeping the conductor at the center of the transformer jaws.

#### NOTE

- During current measurement, keep the transformer jaws fully closed. Otherwise, accurate measurement cannot be made. The Maximum measurable conductor size is 55mm in diameter.
- Unlike in DC current measurement, zero adjustment is not necessary in AC current measurement. There is no polarity in the reading either.
- The output voltage from the OUTPUT terminal may not reduce to nil even if the display is zero adjusted with the **A ZERO RESET** button. In this case, make zero adjustment on the recorder or other device that the output voltage is connected to.

## 2.4 DC Voltage Measurement



### WARNING

---

Do not make measurement on a circuit above 1000VDC. This may cause electric shock hazard.

---

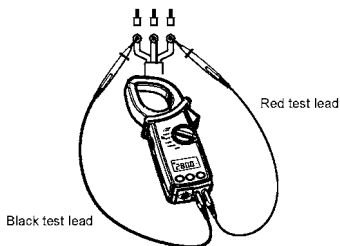

- (1) Set the Function Selector switch to the " $\sim$  400V" or " $\equiv$  1000V" position. If the instrument is in the AC mode, press the  $\sim/\equiv$  button once to select the DC mode. (The instrument is set to the AC mode when it is powered on.) "DC" should be shown on the upper left corner of the display.
- (2) Slide the terminal cover to the left. Plug the red test lead into the Hi terminal and the black test lead into the Lo terminal.

- (3) Connect the other end of the tip of the red test lead to the positive side of the circuit under test and the tip of the black test lead to the negative side. Take the reading on the display. If the test lead connection is reversed, the "-" sign is shown on the display.

## 2.5 AC Voltage Measurements



### WARNING

Do not make measurement on a circuit above 750V AC. This may cause electric shock hazard.

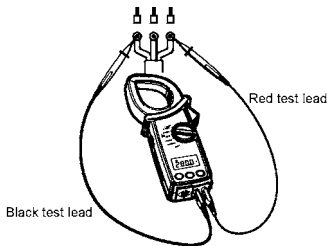

- (1) Set the Function Selector switch to the " $\sim$  400V" or " $\sim$  750V" position. If the instrument is in the DC mode, press the  button once to select AC mode. (The instrument is set to the AC mode when it is powered on.) The "AC" should be shown on the upper left corner of the display.
- (2) Slide the terminal cover to the left. Plug the red test lead into the Hi terminal and black test lead into the Lo terminal.
- (3) Connect the tip of the test leads to the circuit under test. Take the reading on the display.

## 2.6 Resistance Measurement



---

Never try to make measurement on a circuit that is not de-energized.

---

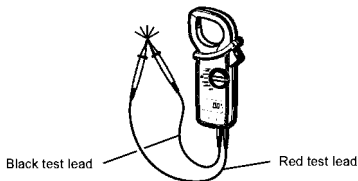

- (1) Set the Function Selector switch to the " $\Omega/\bullet$ " position. The " $\Omega$ " should be shown on the upper right corner of the display.
- (2) Slide the terminal cover to the left. Plug the red test lead into the Hi terminal and the black test lead into the Lo terminal.
- (3) Check that the display reads "OL". Then, short the tip of the test leads together and check that the display reads "0".
- (4) Connect the tip of the test leads to the circuit under test and take the reading on the display.

### NOTE

- When the tip of the test leads is shorted together, the display may read a very small resistance instead of "0". This is the resistance of the test leads, not fault.
- If one of the test leads has a break, the display reads "OL".

## 2.7 Continuity Check (400 $\Omega$ range fixed)



---

Never try to make measurement on a circuit that is not de-energized.

---

- (1) Set the Function Selector switch to the " $\Omega/\bullet$ " position.
- (2) Slide the terminal cover to the left. Plug the red test lead into the Hi terminal and the black test lead into the Lo terminal.
- (3) Press the  button to select the continuity check mode. The " $\bullet$ " symbol should be shown on the display.
- (4) Check that the display reads "OL". Then short together the tip of the test leads and make sure that the display reads "0" and the buzzer beeps.

(5) Connect the tip of the test leads to the circuit under test. The buzzer beeps when the resistance is about  $50\ \Omega$  or less.

#### NOTE

- When the tip of the test leads is shorted together, the display may read a very small resistance instead of "0". This is the resistance of the test leads, not a fault.
- If one of the test leads has a break, the display reads "OL".

### 2.8 MAX Measurement (Response time : 400ms)

The MAX measurement mode is used to display a maximum reading over a certain period of time. This function is available on all ranges other than  $\Omega$  ranges.





#### WARNING

---

---

- Do not make measurement on a circuit above 750VAC or 1000VDC. This may cause electric shock hazard.
  - Do not make measurement with the test leads connected to the instrument.
- 
- 

- (1) Set the Function Selector switch to the desired position.
- (2) Press the  button to select the MAX measurement mode. "MAX" should be shown on the display.
- (3) In order to take a correct reading, press the  button once after clamping the jaws onto the conductor or connecting the test leads to the circuit under test.
- (4) The display shows the maximum reading during measurement.
- (5) Press the  button once again to return to the normal measurement mode.

#### NOTE

- Data Hold function is disabled in MAX measurement mode.
- For measurement over a period more than 10 minutes, disable the Sleep function according to the User's Manual in section 3.1 Sleep Function. Otherwise, the instrument automatically turns itself off in about 10 minutes.

## 3. Other Functions

### 3.1 Sleep Function

This is a function to prevent the instrument from being left powered on in order to conserve battery life. This function causes the instrument to switch to the Sleep (powered-down) mode about 10 minutes after the last switch or button operation.

To exit the Sleep mode, press any button or turn the Function Selector switch back to "OFF", then to any other position.

#### <How to disable the Sleep function>

Powering the instrument on with the Data Hold button pressed disables the Sleep function. "P.OFF" is shown on the display for about 3 seconds to indicate this.

To enable the Sleep function, turn the Function Selector switch back to "OFF", then to any other position.

#### NOTE

The Sleep function is disabled while the output plug is inserted into the OUTPUT terminal. When the output plug is disconnected from the terminal, the Sleep function is enabled in about 10 minutes.

### 3.2 Data Hold Function

This is a function used to freeze the measured value on the display. Press the Data Hold button to freeze the reading. The reading will be held regardless of subsequent variation of current, voltage or resistance under test. "**H**" is shown on the upper right corner of the display.

To exit the Data Hold mode, press the Data Hold button again.

#### NOTE

- The Data Hold mode is disabled when the instrument switches to the Sleep mode.
- The Data Hold function is disabled in the MAX measurement mode.

### 3.3 OUTPUT Terminal (For current measurement only)



#### WARNING

- Do not make measurement on a circuit above 750VAC or 1000VDC. This may cause electric shock hazard.
- Never apply voltage to the OUTPUT terminal.

- (1) To obtain output voltage from the OUTPUT terminal, connect a suitable cord to the output plug cable (sold separately: 98076 or 98077).
- (2) Slide the terminal cover to the right to enclose the Lo and Hi terminals. Insert the output plug into the OUTPUT terminal for connection with a recorder or other recording device.

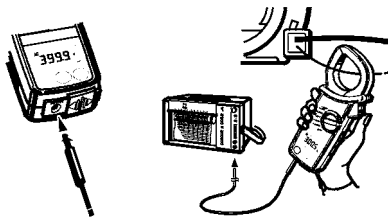

- (3) Set the Function Selector switch to the " $\approx$  400A" or " $\approx$  2000A" position. (The output is available only in the two ranges.) Proceed to measurement in the DC or AC mode.

#### NOTE

- In the DC mode, the output voltage from the OUTPUT terminal may not reduce to nil even if the display is zero adjusted with the  button. In this case, make zero adjustment on the recorder or other device that the output voltage is connected to.
- The Sleep function is disabled while the output plug is inserted into the OUTPUT terminal. When the output plug is disconnected from the terminal, the Sleep function is enabled in about 10 minutes.
- Set the appropriate sensitivity on the recorder or other recording device. (See chapter 5. Specifications.)

### 3.4 Optional Accessories

MODEL: 99025 (For AC current measurement only)

The clamp adapter (99025) has been discontinued.

The clamp adapter (99025) is designed to increase the measuring capability of a clamp meter. With the use of the Clamp Adapter, you can not only extend current range over 3000A, but also clamp on a large bus-bar or conductor.

(1) Set the Function Selector switch to the " $\sim$  400A" position.

(2) Select the AC mode with the  button.

(3) As shown in the figure below, clamp MODEL CL250 onto the pickup coil of MODEL 99025.

(4) Clamp MODEL 99025 onto the bus-bar or conductor under test.

(5) Take the reading on MODEL CL250 and multiply it by 10.

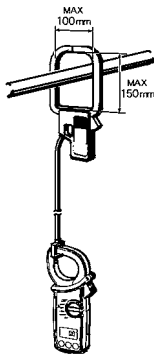



## 4. Battery Replacement



### WARNING

---

---

To avoid electric shock hazard, make sure to set the Function Selector switch to "OFF" and remove the test leads from the instrument before trying to replace batteries.

---

---



### CAUTION

---

---

- Do not mix new and old batteries.
  - Make sure to install batteries in correct polarity as indicated in battery compartment.
- 
- 

If the instrument is powered on, but the display blanks or "**BATT**" is shown on the lower left corner of the display, replace the batteries.

Note that when the battery is completely exhausted, the display blanks without "**BATT**" shown.

- (1) Set the Function Selector switch to the "OFF" position.
- (2) Unscrew and remove the battery compartment cover on the bottom of the instrument.
- (3) Replace the batteries observing correct polarity. Make sure to use two new R6P batteries.
- (4) Replace and screw the battery compartment cover.

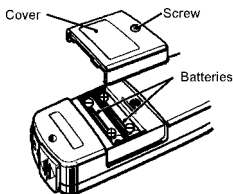

## 5. Specifications

### ■ Instrument Specifications

#### ● Measuring Ranges and Accuracy (at 23±5°C, 45 to 85% relative humidity)

##### DC Current $\overline{\text{---}}\text{A}$

Range	Measuring Ranges	Accuracy
400A	0 to ± 399.9A	± 1.5% rdg ± 2dgt
2000A	0 to ± 1999A	

##### AC Current $\sim$ A

Range	Measuring Ranges	Accuracy
400A	0 to 399.9A	± 1.5% rdg ± 2dgt (50/60Hz)
2000A	0 to 1000A	± 3.0% rdg ± 4dgt (40 to 500Hz)
	1001 to 1999A	± 5.0% rdg ± 4dgt (500 to 1kHz)
		± 3.0% rdg ± 2dgt (50/60Hz)

##### DC Voltage $\overline{\text{---}}\text{V}$ (Input impedance: 2M $\Omega$ )

Range	Measuring Ranges	Accuracy
400A	0 to ± 399.9A	± 1.0% rdg ± 2dgt
1000A	0 to ± 999A	

##### AC Voltage $\sim$ V (Input impedance: 2M $\Omega$ )

Range	Measuring Ranges	Accuracy
400A	0 to 399.9A	± 1.5% rdg ± 2dgt (50/60Hz)
750A	0 to 749A	± 1.5% rdg ± 4dgt(40 to 1kHz)

##### Resistance $\Omega$ (Auto-ranging)

Range	Measuring Ranges	Accuracy
400 $\Omega$	0 to 3999 $\Omega$	± 1.5% rdg ± 2dgt
4000 $\Omega$		

##### Resistance, Continuity check $\Omega/\text{diode}$ (Range Fixed)

レンジ	測定範囲	精度 (周波数範囲)
400 $\Omega$	0 to 399.9 $\Omega$	± 1.5% rdg ± 2dgt (Buzzer beeps at 50 ± 35 $\Omega$ or less)

## OUTPUT (Output impedance: about 10k $\Omega$ )

Measuring Range		Input voltage	Accuracy
DC	400A	0 to 400.0mV	$\pm 1.5\%$ rdg $\pm 3$ mV
	2000A	0 to 200.0mV	
AC	400A	0 to 400.0mV	1.5% rdg $\pm 3$ mV (50/60Hz) $\pm 3.0\%$ rdg $\pm 3$ mV (40 to 500Hz) $\pm 5.0\%$ rdg $\pm 3$ mV (500 to 1kHz)
	2000A	0 to 100.0mV	
			100.1 ~ 200.0mV

\*Electromagnetic compatibility (IEC61000-4-3)

: RF field strength = <math>1\text{V/m}</math>, total accuracy = specified accuracy

: RF field strength =  $3\text{V/m}$ , total accuracy = specified accuracy +2% of range

### ◆General Specifications

- Operating System : Dual integration
- Measurement Function : DC Current, AC Current, DC Voltage, AC Voltage, Resistance, Continuity Check
- Display : Liquid crystal display with maximum counts of 3999
- Overrange Indication : "OL" is displayed on each range.
- Response Time : Approx. 2 seconds.
- Sample Rate : Approx. 2.5 times per second.
- Temperature and Humidity for Guaranteed Accuracy :  $23^{\circ}\text{C} \pm 5^{\circ}\text{C}$ , relative humidity up to 85% without condensation
- Operating Temperature and Humidity : 0 to  $40^{\circ}\text{C}$ , relative humidity up to 85% without condensation
- Storage Temperature and Humidity :  $-20$  to  $60^{\circ}\text{C}$ , relative humidity up to 85% without condensation
- Effect of conductor position : Within  $\pm 1.5\%$ rdg  $\pm 3$ dgt of indicated value at the center to a 10 mm-dia conductor carrying 100A, at every part inside the jaws
- Effect of external magnetic field : 4A or less in AC or DC magnetic field of 400 A/m
- Power Source : Two R6P(DC1.5V) batteries or equivalent
- Battery Life : Approx. 100 hours (continuity)
- Current Consumption : About 9mA max.

- Sleep Function : Automatically switches to the Sleep mode in Approx. 10 minutes after the last switch or button operation (current consumption in the Sleep mode: Approx. 20  $\mu$  A)
- Withstanding Voltage : 8200V AC for 5sec. (between electrical circuit and housing cases or metal parts of jaws)
- Insulation Resistance : 10M $\Omega$  or greater at 1000V (between electrical circuit and housing cases, or metal parts of the jaws)
- Conductor Size : Approx. 55mm diameter max.
- Dimensions : Approx. 105(W) x 250(H) x 49(D) mm
- Weight : Approx. 530g (with batteries)
- Safety Standard :EN 61010-1, EN 61010-2-033  
     EN 61010-031, EN 61010-2-032  
     AC/DC 600V CAT IV, AC/DC 1000V CAT III,  
     Pollution degree 2, indoor use altitude 2000m or less
- EMC Standard :EN 61326-1,EN 61326-2-1, EN 55011
- Radiation immunity : EN61000-4-3
- Environmental standard: EN 50581
- Accessories : Test leads Model 98072 ..... 1 set  
     R6P (SUM3) batteries ..... 2  
     Carrying case Model 93034 ..... 1  
     User' s Manuall ..... 1
- Optional Accessories : Output cable Model 98076  
     Output cable (for terminal screw) Model 98077

## 6. Calibration and After-sales Service

Should any failure occur while you are using the tester, follow the instructions given below. If the tester still fails to operate correctly and needs repair, contact the vendor from whom you purchased the instrument or the nearest Yokogawa Meters & Instruments sales office.

- Turn off the POWER switch once, then turn it back on again.
- If the tester does not turn on, replace the battery with a new one.

### Calibration

It is recommended that the instrument be calibrated once every year.

### **Waste Electrical and Electronic Equipment (WEEE), Directive**

(This directive is valid only in the EU.)

This product complies with the WEEE directive marking requirement.

This marking indicates that you must not discard this electrical/electronic product in domestic household waste.

#### **Product Category**

With reference to the equipment types in the WEEE directive, this product is classified as a "Monitoring and control instruments" product.

When disposing products in the EU, contact your local Yokogawa Europe B.V. office.

Do not dispose in domestic household waste.



This User's Manual explains the Prevention of Pollution Control of Electronic Equipmen Method in China. This manual is valid only in China.

#### 产品中有害物质的名称及含量

部件名称	有害物质					
	铅 (Pb)	汞 (Hg)	镉 (Cd)	六价铬 (Cr (VI))	多溴联苯 (PBB)	多溴二苯醚 (PBDE)
框架 (塑料)	○	○	○	○	○	○
线路板 ASSY	×	○	×	○	○	○
导线	×	○	○	○	○	○
电池	×	○	○	○	○	○

- ：表示该有害物质在该部件所有均质材料中的含量均在GB/T 26572规定的限量要求以下。
- ×：表示该有害物质至少在该部件的某一均质材料中的含量超出GB/T 26572规定的限量要求。

环保使用期限：



该标识适用于 SJ/T11364 中所述，在中华人民共和国销售的电子电气产品的环保使用期限。

只要您遵守该产品相关的安全及使用注意事项，在自制造日起算的年限内，则不会因产品中有害物质泄漏或突发变异，而造成对环境的污染或对人体及财产产生恶劣影响。

