

950 L HF L-key, metric, chrome-plated, with holding function, 4 x 140 mm

L-Keys for Hexagon Socket Screws



EAN:	4013288207265	Size:	140x25x4 mm
Part number:	05022121001	Weight:	17 g
Article number:	950 L HF	Country of origin:	CZ
		Customs tariff number:	82041100

- The holding function on the long arm keeps screws securely on the tool
- Hex-Plus allows socket head screws to live longer
- Extra-long arm
- High corrosion protection thanks to chrome-plating
- Metric

High-quality L-key for hexagon socket screws with high corrosion protection and extra long lever for high power transmission and working in low positions. The Hex-Plus profile offers larger contact surfaces at the screw head. The notch effect is thereby reduced to a minimum, the destruction of the screw head almost eliminated. Tools from size 3 onwards offer a holding function through a pressed resilient ball.

Web link

https://products.wera.de/en/l-keys_l-keys_for_hexagon_socket_screws_950_l_hf.html

Wera - 950 L HF
05022121001 - 4013288207265

Wera Werkzeuge GmbH
Korzter Straße 21-25
D-42349 Wuppertal
Tel: +49 (0)2 02 / 40 45-0
E-Mail: info@wera.de

L-Keys for Hexagon Socket Screws

L-Keys



We questioned the classic L-key design, since all too often the screw head recess is rounded out, meaning screws can no longer be tightened or loosened - and so the user finds the L-key slipping out of the recess. Wera Hex-Plus tools have a larger contact surface in the screw head. The notching effects are reduced and thereby the deformation of the screws. At the same time, as much as 20 % more torque can be applied.

With retaining function on long arm

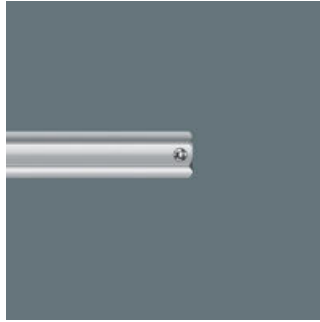

The clamping of the screw is achieved by a flexible locking ball. The holding function is especially helpful in confined, hard-to-reach spaces, where there is no room for a second hand to secure the screw on the tool.

Hex-Plus



Hexagon screws can endure a problem because the contact surfaces delivering the power from the conventional tool, is transferred to the screw via very small surface areas. The consequence: the screw can become damaged (rounding out). Hex-Plus tools have a greater contact surface that prevents this from happening! At the same time, as much as 20 % more torque can be applied. Good to know: Hex-Plus tools fit into every standard hexagon socket screw!

Surface protection



Chrome-plated hexagon L-keys for outstanding surface protection and long service life. High corrosion protection.

Size identification



The size of each L-keys has been engraved by a laser. In addition Take it easy L-keys have a colour coding according to sizes - for simple and rapid accessing of the required tool. Making it easy to find the right tool.

Web link





https://products.wera.de/en/l-keys_l-keys_for_hexagon_socket_screws_950_l_hf.html

Wera - 950 L HF
05022121001 - 4013288207265

Wera Werkzeuge GmbH
Korzter Straße 21-25
D-42349 Wuppertal
Tel: +49 (0)2 02 / 40 45-0
E-Mail: info@wera.de

L-Keys for Hexagon Socket Screws

Further versions in this product family:

	 mm	 mm	 mm	 inch	 inch
05022120001	3.0	126	20	5"	25/32"
05022121001	4.0	140	25	5 1/2"	1"
05022122001	5.0	160	28	6 5/16"	1 3/32"
05022123001	6.0	180	32	7 1/16"	1 1/4"
05022124001	8.0	200	36	8"	1 7/16"
05022125001	10.0	219	40	8 11/16"	1 9/16"

Web link

https://products.wera.de/en/l-keys_l-keys_for_hexagon_socket_screws_950_l_hf.html

Wera - 950 L HF
05022121001 - 4013288207265

Wera Werkzeuge GmbH
Korzter Straße 21-25
D-42349 Wuppertal
Tel: +49 (0)2 02 / 40 45-0
E-Mail: info@wera.de