

UNI-T[®]

Instruments.uni-trend.com



User's Manual

UTE310 Digital Power Meter

Table of Contents

Perface	6
Copyright	6
Warranty Service.....	6
Limited Warranty and Liability	7
Chapter 1 Safety Instruction	8
1.1 Safety Information	9
1.2 Environmental Condition	11
Chapter 2 Inspection and Installment	12
2.1 Check Packing List	12
2.2 Handle	16
Chapter 3 Product Introduction	16
3.1 Product Overview	16
3.2 Features	17
3.3 Application System	19
3.4 Technical Index.....	19
3.5 Front Panel	21
3.5.1 Key Function on Front Panel	22
3.5.2 Key Combination	23
3.5.3 Description of Display Screen.....	24
3.6 Rear Panel	26
Chapter 4 Operation Preparation and Wire Connection.....	27
4.1 Operation Preparation	27
4.1.1 Connecting Power Cable	27
4.2 Wire Connection	28
4.2.1 Direct Input Voltage and Wire Connection of Current (①).....	29
4.2.2 Direct Input Voltage and Wire Connection of CT Transformer (②).....	30
4.2.3 Direct Input Voltage and Wire Connection of EXT (③).....	31
4.2.4 Direct Input Voltage and Wire Connection of CT Transformer + EXT (④).....	31
4.2.5 VT Transformer and Wire Connection of Direct Input Current (⑤).....	32
4.2.6 VT Transformer and Wire Connection of CT Transformer (⑥).....	32
4.2.7 VT Transformer and Wire Connection of EXT (⑦).....	34
4.2.8 VT Transformer and Wire Connection of CT + EXT (⑧).....	34
4.2.9 Connecting Power Supply	35

Chapter 5 Measurement Settings	36
5.1 Range Settings	36
5.1.1 Voltage Range Settings	36
5.1.2 Current Range Settings	36
5.1.3 Range Switching	37
5.2 Measurement Mode	38
5.3 Meter Common Measurement and Settings	39
5.3.1 VIEW-1	40
5.3.2 VIEW-2	41
5.3.3 VIEW-3	41
5.4 Harmonic Measurement	43
5.4.1 BAR Graph	44
5.4.2 LIST Mode	44
5.4.3 HARMONIC SET	45
5.5 Wave Display	47
5.5.1 Time Axis	48
5.5.2 Vertical Axis	48
5.6 Integration	48
5.6.1 Normal Integration	49
5.6.2 Continuous Integration	50
5.6.3 Comparison of Integration Mode	51
5.6.4 Integration Method	53
5.6.5 Integration Settings	53
5.6.6 Integration Operation	55
5.6.7 Limitations during Integration	56
Chapter 6 Setup Menu	57
6.1 SETUP	58
6.1.1 Sync Source	58
6.1.2 Line Filter	60
6.1.3 Frequency Filter	61
6.1.4 Crest Factor	62
6.1.5 Data Update Interval	62
6.1.6 Auto Timer (Timeout)	63
6.1.7 Auto Rate Sync (Automatic data synchronization)	64

6.1.8	Reset Init (Initialization).....	64
6.2	Average Filter (AVG).....	65
6.2.1	Average State (Turn on/off)	66
6.2.2	Average Type.....	66
6.2.3	Count (Average factor)	67
6.3	External Current Sensor (EXT).....	67
6.3.1	Ext Sensor CH.....	67
6.3.2	Ext1 Ratio (mV/A)	68
6.3.3	Ext2 Ratio (mV/A).....	68
6.4	SCALE (VT and CT Ratio).....	69
6.4.1	SCALE State (Turn on/off scaling transformation).....	69
6.4.2	VT/CT/PT (Scaling coefficient)	70
6.5	JUMP (Range skipping)	71
6.5.1	Skipping Configuration	72
6.5.2	U/I Peak Over (Peak-over jump).....	72
6.6	D/A Output and Control	73
6.6.1	D/A Output Format.....	73
6.6.2	D/A Output Range Mode	74
6.6.2	D/A Output Interface Remote Control	77
6.6.3	Pin Definition of D/A Output	79
Chapter 7	System Menu	80
7.1	INFO (System Information)	80
7.2	SET (System Setting).....	80
7.2.1	Brightness	81
7.2.2	Key Sound	81
7.2.3	Comm Protocol (Communication Protocol)	81
7.2.4	Storage	82
7.2.5	Time Interval.....	82
7.2.6	TIMER (System Time)	83
7.3	RS232 Setting	83
7.3.1	Baud Rate	83
7.4	IP Setting	84
7.4.1	IP Model	84
7.4.2	IP Address	84

7.4.3 Subnet Mask	85
7.4.4 Gateway	85
7.5 USB (Load and Save).....	85
Chapter 8 Communication	85
8.1 RS-232 Interface	85
8.1.1 RS-232 Settings.....	86
8.1.2 PC Connect to UTE310 via RS-232	87
8.2 LAN Interface	87
8.2.1 LAN Setting	88
8.2.2 PC Connect to UTE310 via LAN	88
8.3 USB Interface	89
8.3.1 PC Connect to UTE310 via USB.....	90
8.4 GPIB Interface (Optional)	90
8.4.4 PC Connect to UTE310 via GPIB Interface.....	91
Chapter 9 Storage and Calibration	93
9.1 Notices for Storage	93
9.2 Trouble-shooting	93
9.3 Notices for Calibration	93
Chapter 10 Replace Fuse.....	95
Appendix 1 Symbol and Formula of Measurement	96
Appendix 2 Measurement Accuracy and Measurement Error	97

Preface

Thank you for choosing this brand new UNI-T instrument. In order to use this instrument safely and correctly, please read this manual thoroughly, especially the Safety Requirements part.

After reading this manual, it is recommended to keep the manual at an easily accessible place, preferably close to the device, for future reference.

Copyright

Copyright is owned by Uni-Trend Technology(China)Co., Ltd.

UNI-T products are protected by patent rights in China and other countries, including issued and pending patents. Uni-Trend reserves the rights to any product specification and pricing changes.

Uni-Trend Technology (China) Co., Ltd. all rights reserved. Trend reserves all rights. Information in this manual supersedes all previously published versions. No part of this manual may be copied, extracted or translated by any means without the prior permission of Uni-Trend.

UNI-T is the registered trademark of Uni Trend Technology(China)Co., Ltd.

Warranty Service

The instrument has a warranty period of one year from the date of purchase. If the instrument is damaged due to improper operation by the user during the warranty period, the maintenance fee and the costs caused by the maintenance shall be borne by the user, and the instrument shall be maintained by the company for life.

If the original purchaser sells or transfers the product to a third party within one year from the date of purchase of the product, the warranty period of one year shall be from the date of the original purchase from UNI-T or an authorized UNI-T distributor. Power cords, accessories and fuses, etc. are not included in this warranty.

If the product is proved to be defective within the warranty period, UNI-T reserves the rights to either repair the defective product without charging of parts and labor, or exchange the defected product to a working equivalent product (determined by UNI-T). Replacement parts, modules and products may be brand new, or

perform at the same specifications as brand new products. All original parts, modules, or products which were defective become the property of UNI-T.

The "customer" refers to the individual or entity that is declared in the guarantee. In order to obtain the warranty service, "customer" must inform the defects within the applicable warranty period to UNI-T, and perform appropriate arrangements for the warranty service.

The customer shall be responsible for packing and shipping the defective products to the individual or entity that is declared in the guarantee. In order to obtain the warranty service, customer must inform the defects within the applicable warranty period to UNI-T, and perform appropriate arrangements for the warranty service. The customer shall be responsible for packing and shipping the defective products to the designated maintenance center of UNI-T, pay the shipping cost, and provide a copy of the purchase receipt of the original purchaser. If the products is shipped domestically to the purchase receipt of the original purchaser. If the product is shipped to the location of the UNI-T service center, UNI-T shall pay the return shipping fee. If the product is sent to any other location, the customer shall be responsible for all shipping, duties, taxes, and any other expenses.

Limited Warranty and Liability

The warranty is inapplicable to any defects, failures or damages caused by accident, normal wear of components, use beyond specified scope or improper use of product, or improper or insufficient maintenance. UNI-T is not obliged to provide the services below as prescribed by the warranty:

- a) Repair damage caused by installation, repair or maintenance of personnel other than service representatives of UNI-T;
- b) Repair damage caused by improper use or connection to incompatible equipment;
- c) Repair any damages or failures caused by using power source not provided by UNI-T;
- d) Repair products that have been changed or integrated with other products (if such change or integration increases time or difficulty of repair).

The warranty is formulated by UNI-T for this product, replacing any other express or implied warranties. UNI-T and its distributors refuse to give any implied warranty for marketability or applicability for special purpose. For violation of the warranty, repair or replacement of defective products is the only and all remedial measure UNI-T provides for customers.

No matter whether UNI-T and its distributors are informed of any possible indirect, special, occasional or inevitable damage in advance, they assume no responsibility for such damage.

Chapter 1 Safety Instruction

To ensure the personal safety and to prevent damage to the instrument, please read and obey the safety instructions carefully before using the instrument. Failure to follow these precautions and the specific warnings described in this manual may result in a violation of the safety regulations governing the design, manufacture, and use of the instrument, and UNI-T assumes no responsibility for the user's failure to comply.

1. Do not use damaged equipment. Before using the device, check its outer shell. Check whether has cracks or missing plastic. Do not operate the equipment in an environment containing explosive gases, vapors or dust.
2. Only professionally trained personnel can perform maintenance procedures, to avoid fire and personal injury; personnel must be supervised during use, and the instrument and its power supply should be turned off when not supervised.
3. Before connecting the device, please carefully observe all markings on the device and consult the manual for detailed information on ratings, read through all warnings and cautions in this manual.
4. The operating power of the instrument is 100 to 240 VAC, 50/60 Hz.
5. The factory is equipped with a three-core power cord, only use the power cord provided by the manufacturer to avoid accidental injury; do not plug or unplug the power cord with electricity; do not place other objects on the power cord when using it and make sure that the power cord is away from heat sources.
6. The product should reliably ground. This product is grounded through the grounding conductor of the power supply. To avoid electric shock, the grounding conductor must be reliably connected to ground.
7. Do not install substitute parts on the instrument by yourself or perform any unauthorized modifications; do not open the casing for operation, and do not use the equipment with the cover or panel open or loose.
8. During the test, do not touch the terminals and test wires of the instrument to prevent electric shock; do not plug or unplug the communication ports with electricity; do not place any objects on the instrument to avoid damage to the instrument, especially pay attention to not let the metal shavings and liquid (such as water and oil) into the internal of the instrument, otherwise it will cause unpredictable







and serious consequences.







9. The circuits shall not be exposed. Do not touch exposed connectors and components after power is turned on.
10. Use the appropriate fuse, only use the fuse type and rating indicator specified for this product.
11. Do not operate the product if you suspect it has malfunctioned; if you suspect the product has malfunctioned, please consult the qualified maintenance personnel.
12. If the instrument will not be used for a long time, please unplug the power cord from the power outlet, please do not pull the power plug by pulling the power cord.
13. Before carrying the instrument, make sure that the power cord and other connecting cables have been unplugged. When carrying the instrument, please use the carrying handle on the side of the instrument, and put it down gently to prevent collision.

1.1 Safety Information

- Use a standard three-prong flat-plug power cord and plug the instrument into an electrical outlet that grounded in good condition.
- Please use the instrument in a safe manner according to the instructions in this manual.
- Do not remove or modify the instrument by yourself.
- If you encounter any instrument failure, please contact the original manufacturer for maintenance.

Safety Sign

	Danger	"Danger" indicates the presence of a hazard. It reminds users to pay attention to a certain operation process, operation method or similar. Personal injury or death may occur if the rules in the "Danger" statement are not properly executed or observed. Do not proceed to the next step until you fully understand and meet the conditions stated in the "Danger" statement.
	Warning	"Warning" indicates the presence of a hazard. It reminds users to pay attention to a certain operation process, operation method or similar. Product damage or loss of important data may occur if the rules in the "Warning" statement are not properly executed or observed. Do not proceed to the next step until you fully understand and meet the conditions stated in the "Warning" statement.
	Caution	It indicates possible danger, which may cause damage to this device or other equipment if you fail to follow a certain procedure or condition. If the "Caution" sign is present, all conditions must be met before you proceed to operation.
	Note	It indicates potential problems, which may cause failure of this device if you fail to follow a certain procedure or condition. If the "Note" sign is present, all conditions must be met before this device will function properly.
	AC	Alternating current of device. Please check the region's voltage range.
	DC	Direct current of device. Please check the region's voltage range.

	Grounding	Frame and casing cover grounding terminal
	Grounding	Protective grounding terminal
	Grounding	Measurement grounding terminal
CAT 0		This instrument is suitable for measurements on circuits that are not directly connected to the grid power supply and circuits that are specially protected to be powered from the (internal) grid. In the latter case, the transient stresses are different, and the instrument should be used for this type of measurement to ensure that the peak transient voltage is less than 3000 V.
CAT I		Secondary electrical circuit connected to wall sockets through transformers or similar equipment, such as electronic instruments and electronic equipment; electronic equipment with protective measures, and any high-voltage and low-voltage circuits, such as the copier in the office.
CAT II		Primary electrical circuit of the electrical equipment connected to the indoor socket via the power cord, such as mobile tools, home appliances, etc. Household appliances, portable tools (e.g. electric drill), household sockets, sockets more than 10 meters away from CAT III circuit or sockets more than 20 meters away from CAT IV circuit.
CAT III		Primary circuit of large equipment directly connected to the distribution board and circuit between the distribution board and the socket (three-phase distributor circuit includes a single commercial lighting circuit). Fixed equipment, such as multi-phase motor and multi-phase fuse box; lighting equipment and lines inside large buildings; machine tools and power distribution boards at industrial sites (workshops).
CAT IV		Three-phase public power unit and outdoor power supply line equipment. Equipment designed to "initial connection", such as power distribution system of power station, power instrument, front-end overload protection, and any outdoor transmission line.
	Certification	CE indicates a registered trademark of EU
	Certification	UKCA indicates a registered trademark of UK
	Waste	This product complies with the marking requirements of WEEE Directive (2002/96/EC). This additional label indicates that this electrical / electronic product must not be discarded in household waste.
	EFUP	This environment-friendly use period (EFUP) mark indicates that dangerous or toxic substances will not leak or cause damage within this indicated time period. The environment-friendly use period of this product is 40 years, during which it can be used safely. Upon expiration of this period, it should enter the recycling system.

Warning

The UTE310 Digital Power Meter only supports measurement of power supplies under CAT II (600V) type overvoltage conditions, so please use the instrument strictly in accordance with this measurement environment.

General Instructions

The following instructions are listed for personal safety and equipment protection.

- Defective protection function

Before using the instrument, check the protection function and do not use the instrument if you find a protective ground or fuse is defective.

- **Do not remove the instrument's casing**

High voltage is present inside the instrument, which is very dangerous. If it is necessary to check and adjust the inside of the instrument, please consult the original manufacturer's instructions before operation.

- **When an abnormal odor or smoke appears**

If the product is in an abnormal condition, such as smoke or odor, turn off the power and plug out the power supply, and disconnect the power supply of the measuring circuit connected to the input terminal.

- **Do not operate the instrument in a flammable environment**

Do not use the instrument in an environment containing flammable or explosive liquids or gases.

- **Do not damage the power cord**

Do not place objects on the power cord and keep the power cord away from heat sources.

- **Cut off the power supply**

If the instrument is not to be used for a long time, unplug the power cord of the instrument. Do not pull the power plug straight, swinging it slightly from side to side to pull out. And disconnect all circuits connected to the input terminals.

- **Do not place stuff on the instrument**

Do not place heavy objects or containers with liquids on the instrument as this may cause malfunction.

- **Do not operate the instrument in a humid environment**

To avoid the interior short-circuit or electric shock, do not operate the instrument in a humid environment.

- **Do not carry or clean the instrument with electricity**

Before handling and cleaning the instrument, please disconnect the instrument from the power supply to avoid danger, and use a clean dry cloth to wipe the instrument.

1.2 Environmental Condition

UTE310 digital power meter can only use indoors and non-condensing area, the general environmental requirements are shown as below table.

Environmental Condition	
Operating Environment	5°C ~ 40°C, 20% ~ 80%RH (non-condensing)
Accuracy guaranteed temperature and humidity	23°C±5°C, 30% ~ 75% R.H.
temperature	

Storage temperature	-10°C ~ 50°C , non-condensing below 80% R.H.
Operating altitude	≤2000 meters

Note: In order to ensure the measurement accuracy, it is recommended to start the operation after half an hour to warm-up the machine.

Chapter 2 Inspection and Installment

2.1 Check Packing List

Check with packing list to confirm that accessories has no loss or abnormal. If there have any problem, please contact with UNI-T distributor or manufacture.

Product

Model	Product Name	Size (Width x Height x Depth)	Packing Quantity
UTE310	Digital Power Meter	254.2mm X 113.2mm X 403.08mm	1 piece

Standard Accessories and Manual







No.	Name	Quantity	Remarks
1	French elbow two-pin round power cable	1 piece	
2	Safety double banana connector cable	1 pair	One red and one black
3	Fork type insulated cold-pressing terminal	2 pairs	Two red and two black
4	Product calibration certificate	1 piece	
5	Download guide of product manual and software	1 piece	

Explanation

After confirming that the contents of the package are the same and there is no problem, please keep the packing box and related contents properly. It is the packing requirements for returning to the factory for service.

Except the standard accessories, user can also purchase the following accessories.

Option Tong Head (Sold separately, not in the same box as the instrument)

No.	Brand	Model	Sensor	Current	Transformation ratio	Accuracy	Bandwidth	Pore Size	Interface	Appearance
1	CYBER TEK	ZCP20	AC and DC current clamp	20Arms	0.1V/A	0.30%	1MHz	20mm	12 pin	
2	CYBER TEK	ZCP20 0	AC and DC current clamp	200Arms	10mV/A	0.30%	500kHz	20mm	12 pin	
3	CYBER TEK	ZCP50 0	AC and DC current clamp	500Arms	4mV/A	0.30%	100kHz	50mm	12 pin	
4	CYBER TEK	ZCP10 00	AC and DC current clamp	1000Arms	2mV/A	0.30%	20kHz	50mm	12 pin	
5	CA	C116	AC current clamp	1000Arms	1mV/A	0.30%	30Hz-10kHz	52mm	4mm banana plug	
6	CA	C112	AC current clamp	1000Arms	1:1000	0.30%	30Hz-10kHz	52mm	4mm banana plug	





Option Current Sensor (Sold separately, not in the same box as the instrument)

IN Series High Precision Current Sensor

No.	Brand	Model	Sensor	Current	Transformation ratio	Accuracy	Bandwidth	Pore Size	Interface	Appearance
1	LEM	IN 500-S	AC and DC sensor	AC/DC: 500A	1:750	0.0018%	520kHz	38.2mm	DB9	
2	LEM	IN 1000- S	AC and DC sensor	AC/DC: 1000A	1:1500	0.0018%	440kHz	38.2mm	DB9	
3	LEM	IN 1200- S	AC and DC sensor	AC/DC: 1200A	1:1500	0.0018%	440kHz	38.2mm	DB9	





4	LEM	IN 2000- S	AC and DC sensor	AC/DC: 2000A	1:2000	0.0018%	140kHz	70mm	DB9	
---	-----	------------------	------------------------	-----------------	--------	---------	--------	------	-----	-------------------------------------------------------------------------------------

AIT Series High Precision Current Sensor





No	Brand	Model	Sensor	Current	Transformation ratio	Accuracy	Bandwidth	Pore Size	Interface	Appearance
1	Hangzh i	AIT3000- D90	AC and DC sensor	DC:3000A, AC:2121A	1: 3000	0.0050%	300kHz	90mm	Current terminal	
2	Hangzh i	AIT5000- D160	AC and DC sensor	DC:5000A, AC:3535A	1: 5000	0.0050%	300kHz	160m m	Current terminal	
3	Hangzh i	AIT8000- D120	AC and DC sensor	DC:8000A, AC:5600A	1: 4000	0.0050%	300kHz	120m m	Current terminal	
4	Hangzh i	AIT10000 -D120	AC and DC sensor	DC:10000A , AC:7072A	1: 5000	0.0050%	200kHz	120m m	Current terminal	

LEM Series Low Precision Current Sensor

No.	Brand	Model	Sensor	Current	Transformation ratio	Accuracy	Bandwidth	Pore Size	Interface	Appearance
-----	-------	-------	--------	---------	----------------------	----------	-----------	-----------	-----------	------------

1	LEM	LF205-S/SP3	AC and DC sensor	100Arms (DC/AC)	1: 1000	±0.5%	100kHz	15.5mm	3 PIN	
2	LEM	LF205-S	AC and DC sensor	200Arms (DC/AC)	1: 2000	±0.5%	100kHz	15.5mm	3 PIN	
3	LEM	LF505-S	AC and DC sensor	500Arms (DC/AC) (maximum 800A)	1: 5000	±0.6%	100kHz	32.2mm	3 PIN	
4	LEM	LF1005-S	AC and DC sensor	1000Arms	1: 5000	±0.4%	150kHz	40.5mm	3 PIN	

Option Test Wire and Plug (Sold separately, not in the same box as the instrument)

No.	Description	Brand	Appearance
1	Safety BNC male head Φ 4mm banana socket convertor, rated voltage of 1000V	MC	
2	DB9 interface current sensor connecting wire is used for ZCS/ IN series sensor. -0: bare wire -4: 4mm plug	/	
3	3PIN interface current sensor connecting wire is used for LF series sensor. -0: bare wire -4: 4mm plug	/	
4	Test wire of electrical machinery. Safety level: CAT II (600 V), CAT III (300V) 0.65m	STAUBLI	

2.2 Handle

The instrument's handle can adjust to four positions by appropriate strengths. Hold the handle and pull to two sides to remove it. Adjusting the handle to the position as shown in the following figure.

1. Original position

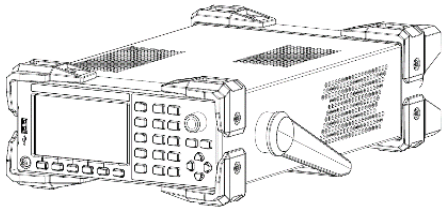

2. Testing position

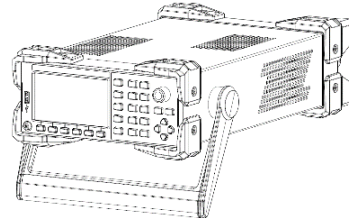

3. Removal position

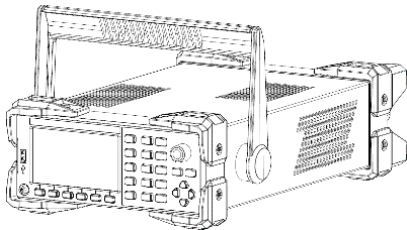

4. Lifting position

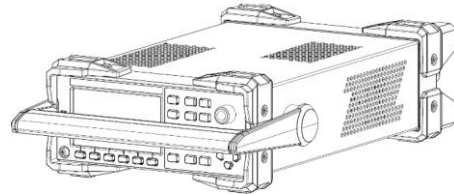

Chapter 3 Product Introduction

3.1 Product Overview

With the continuous introduction of new energy-efficiency standards, many companies are prepare to researching and developing the white home appliance as the representative of the household appliances, and large air conditioners as the representative of industrial equipment. They are centered around how to improve the energy-saving performance and the fierce competition, which requires that the power measurement instruments used to assess the energy-saving performance of the equipment should be characterized by high-precision, ultra-low standby power consumption measurements and so on.

UTE310 is a high precision and high performance digital power meter. The current measurement range is 25uA~20A, which meets the requirement of production, test and R&D.

UTE310 digital power meter is suitable for the power measurement from production line to R&D field.

- The measurement of DC and single phase two-wire system;
- The measurement of the household appliances with high power, such as the air condition and the induction stove;
- The measurement of the office equipment, such as the display and the printer;
- The measurement of the energy equipment, such as LED, the power supply and the battery;
- The measurement of energy-saving performance of industrial equipment, such as the frequency converter and the large air condition.

3.2 Features

- **Oscillography**

Observe the change of the measured signal in peak-to peak and waveform.

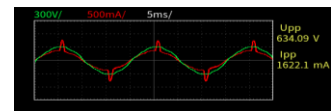

- **Basic power parameter measurement**

Measure the basic power parameters of voltage, current, power factor, and support for measuring the AC and DC signals.

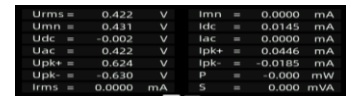

- **Harmonic measurement**

Support the harmonic measurement of IEC61000-4-7, which can analysis the harmonic component in signal, such as voltage, current, power and phase angle.

Order	U(V)	I(mA)	PI(W)
1	227.23	53.39	12.069
2	0.153	2.182	0.001
3	1.255	93.83%	-0.359
4	0.066	3.83%	1.1882
5	30.1%	~:J9%	~:~:~
6	-98.2	716.1	

The maximum measured results of 50 harmonic can be displayed.

- **Mathematical operation**

The measured parameters can be added, subtracted, multiplied, and divided.

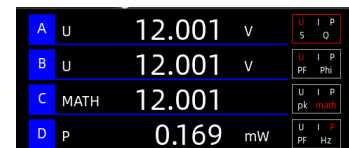

- **Current integral and power integral**

The integration of q, q+, q-, WP, WP+, WP-, which can be set to continuous integral or normal integral mode.

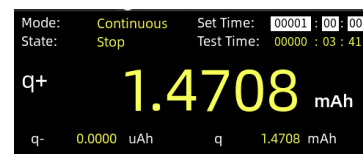

- **Multiple interfaces**

The user can remote control the instrument via USB, RS-232/GPIB and LAN interfaces.



- **Automatic range**

This function can automatically select or change the range within the specified range.

- **Load and access the external memorizer**

The instrument can connect the external memorizer to save the data of voltage, current, power and harmonic. And it can also export and import the configuration parameter of the instrument.

- **Built-in digital filter**

The instrument has line filter and frequency filter function. The user can enable the line filter or frequency filter to restrain unwanted noise and harmonic components during fundamental measurements.

- **PC analysis software**

The software is used to remote control and set the UTE 310 digital power meter, for acquiring, displaying, analyzing and saving the measured value, harmonic and waveform data.

- **Holding the maximum value**

RMS/Peak of voltage and current, active power P, relative power Q and apparent power S.

- **Sampling frequency**

The sampling frequency of the UTE310 is 1MHz.

- **Bandwidth**

The bandwidth of the UTE310 is DC, 0.1Hz~300kHz.

- **25 μ A low current measurement**

This function can accurately measure the stand-by power loss of the household appliance.

- **Input range of wide current sensor**

50mV~10V, this sensor can be compatible with more sensors, and is very suitable for the power consumption measurement of intermittent operation equipment.

- **Input range of wide current**

25mA~20A

- **The data update interval can up to 0.1s**

UTE310 digital power meter can freely set the data update interval: 0.1s, 0.25s, 0.5s, 1s, 2s, 5s, 10s, 20s, Auto, to meet the measurement needs of different frequency signals.

3.3 Application System

The application system chart of the UTE310 digital power meter is shown in the following figure.

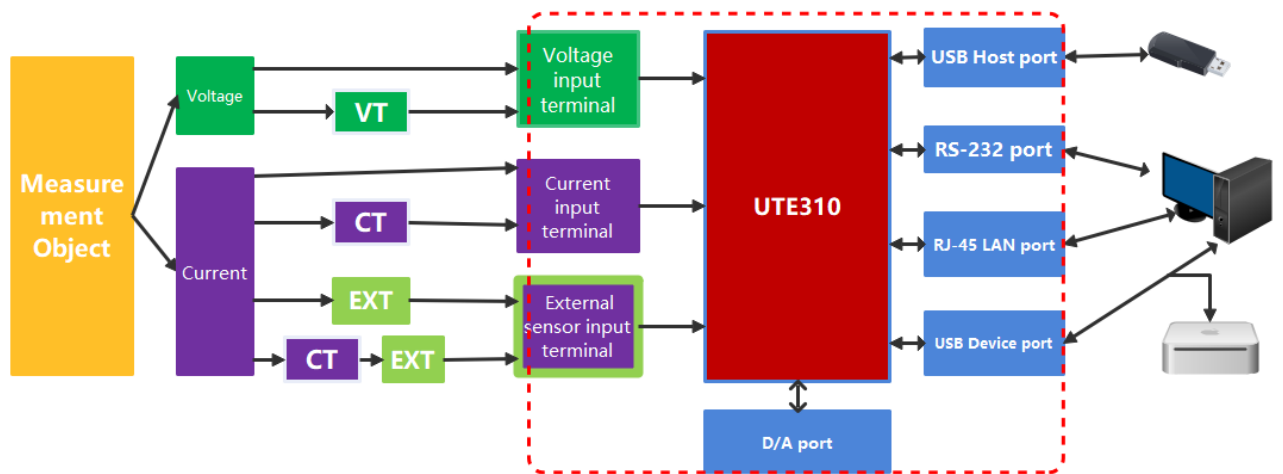

3.4 Technical Index

f: Frequency Rate: Data update interval CF: Crest factor

Model	UTE310	
Bandwidth	DC, 0.1Hz ~ 300kHz	
Sampling Rate	1MHz	
Voltage Range	CF=3	CF=6 or 6A
	15V	7.5V
	30V	15V
	60V	30V
	150V	75V
	300V	150V
	600V	300V
Voltage Resolution	0.001V/0.01V	

Current Range	CF=3	CF=6 or 6A
	5mA	2.5mA
	10mA	5mA
	20mA	10mA
	50mA	25mA
	100mA	50mA
	200mA	100mA
	500mA	250mA
	1A	0.5A
	2A	1A
	5A	2.5A
	10A	5A
	20A	10A
	Current Resolution	0.0001mA/0.001mA/0.01mA/0.1mA/1mA
Ext1 Sensor CH Range	CF=3	CF=6 or 6A
	2.5V	1.25V
	5V	2.5V
	10V	5V
Ext1 Sensor CH Resolution	100uV/1mV	
Ext2 Sensor CH Range	CF=3	CF=6 or 6A
	50mV	25mV
	100mV	50mV
	200mV	100mV
	500mV	250mV
	1V	0.5V
	2V	1V
Ext2 Sensor CH Resolution	1uV/10uV/100uV	
Frequency Measurement	Data Update Interval	Frequency
Range	0.1S	20Hz≥f≤300kHz









	0.25 S	$10\text{Hz} \geq f \leq 300\text{kHz}$
	0.5 S	$5.0\text{Hz} \geq f \leq 300\text{kHz}$
	1 S	$2.0\text{Hz} \geq f \leq 300\text{kHz}$
	2 S	$1.0\text{Hz} \geq f \leq 300\text{kHz}$
	5 S	$0.5\text{Hz} \geq f \leq 300\text{kHz}$
	10 S	$0.2\text{Hz} \geq f \leq 300\text{kHz}$
	20 S	$0.1\text{Hz} \geq f \leq 300\text{kHz}$
	Auto	$0.1\text{Hz} \geq f \leq 300\text{kHz}$
Power Range	75mW ~ 12000W	
Waveform Display	Display the waveform of U/I	
Line Filter	√	
Frequency Filter	√	
Harmonic Measurement	1 ~ 50 times	
Integrating Function	Average active power integral, current integral	
Mathematical Operation	√	
DA Output and Control	√	
Communication Interface	RS-232/GPIB, LAN, USB	







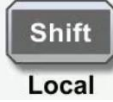

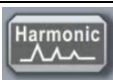
3.5 Front Panel

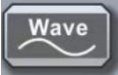
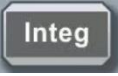
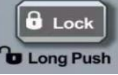
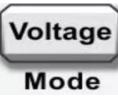
This section is to introduce the panel and key function of the UTE310 digital power meter.

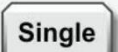

3.5.1 Key Function on Front Panel

Key	Function
	The power switch ON/OFF: Press one time to turn on the instrument, press it again to shut down the instrument.
	Common function key This indicates the different functions according to the corresponding parameters of the display.
	Up/Down selection key Use the up/down key to select an item when setting the parameters. For the sake of simplicity, the up/down keys are indicated by the two buttons [▲][▼].
	Left/Right selection key Use the left/right key to select an item to the left or right when setting the parameters. It is usually used to move the editing bit in numerical editing. For the sake of simplicity, the left/right keys are indicated by the two buttons [◀][▶].
	Enter key Save the current settings and exit.
	Esc key Exit the current setting page; Return to the previous step
	Encoder knob When editing the numerical value, clockwise rotating the encoder knob to increasing the value, anticlockwise rotating the encoder knob to decreasing the value;
	Second function auxiliary key Press this key and press other key with the second function to enabling auxiliary function.
	General parameter measurements This function page includes three measurement/display styles, VEW-1, VEW-2 and VEW-3, measuring total of 24 parameters.
	Harmonic measurements Harmonic measurement and harmonic settings (including harmonic display and mode settings)

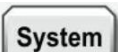
	Waveform display Display the waveform of voltage and current.
	Integral key The average active power and current can be integrated.
	Lock key Press this key to disable other keys, long press 1 second to unlock keys.
	Voltage settings Press this key to set the voltage, use "▲, ▼" to select the range, and press the "Enter" key to save the selected range and exit (or wait for 10 seconds to automatically save the settings and exit); The second function of this key is measurement mode switching, which can switch to DC, RMS or MN.
	Current settings Press this key to set the current, use "▲, ▼" to select the range, and press the "Enter" key to save the selected range and exit (or wait for 10 seconds to automatically save the settings and exit); The second function of this key is zero calibration.
	Max hold Hold the maximum value, the data is updated only when a measured value that is larger than the value that has been held.
	Data hold Hold the measured data that test by the input terminal.
	Start key Press this key to starting the integral.
	Stop key Press this key to pausing the integral. Press the Shift key with this key is to reset the integral or zeroing the integral.
	Single measurement In data hold, press the Single key to measure one time, the measured data is kept after the measurement is finished.
	Function settings Press this key to set the synchronous source, line filter, frequency filter, crest factor, data update interval (SETUP), average filter (AVG), external current sensor input (EXT), VT/CT scale factor (SCALE), range jump (JUMP), D/A output and control.
	System settings System information (INFO), SET, RS232, IP and USB.

3.5.2 Key Combination

[Shift + Mode]

Each time the [Shift + Mode] key is pressed, the measurement mode will be switched once, and there are three measurement modes, DC, RMS, and MN.

[Shift + Cal]

Zero calibration



[Shift +Reset]

Rest the integral

3.5.3 Description of Display Screen

Display Contents	Function Description
U-RANGE 15V /30V /150V /300V /600V	Indicates that the voltage is a fixed range of 15V /30V /150V /300V /600V respectively (each range is one-half of the current range when CF=6 or 6A).
U-AUTO 15V /30V /150V /300V /600V	Indicates that the voltage is an automatic range of 15V /30V /150V /300V /600V respectively (each range is one-half of the current range when CF=6 or 6A).
I-RANGE 5mA/10mA/20mA/50mA /100mA/200mA/500mA/1A/2A/5A/10A/20A	Indicates that the current is a fixed range of 5mA /10mA /20mA /50mA /100mA /200mA /500mA /1A /2A /5A /10A / 20A (each range is one-half of the current range when CF=6 or 6A).
I-AUTO 5mA/10mA/20mA/50mA /100mA/200mA/500mA/1A/2A/5A/10A/20A	Indicates that the current is an automatic range of 5mA/ 10mA /20mA /50mA /100mA /200mA /500mA /1A /2A /5A /10A / 20A respectively (each range is one-half of the current range when CF=6 or 6A).
EXT1	Indicates that the current selection is EXT1 (the external current sensor 1).
EXT2	Indicates that the current selection is EXT2 (the external current sensor 2).
I-RANGE 2.5V/5V/10V	Indicates that the current is fixed range 2.5V /5V /10V of EXT1 respectively (each range is one-half of the current range when CF=6 or 6A).
I-AUTO 2.5V/5V/10V	Indicates that the current is automatic range 2.5V /5V /10V of EXT1 respectively 2.5V/ 5V/ 10V (each range is one-half of the current range when CF=6 or 6A).
I-RANGE 50mV/100mV/200mV/500mV/1V/2V	Indicates that the current is fixed range 50mV/ 100mV/ 200mV/ 500mV/ 1V/ 2V of EXT2 respectively. 50mV/100mV/200mV/500mV/1V/2V (each range is one-half of the current range when CF=6 or 6A).
I-AUTO 50mV/100mV/200mV/500mV/1V/2V	Indicates that the current is automatic range 50mV/ 100mV/ 200mV/ 500mV/ 1V/ 2V of EXT2 respectively. 50mV/100mV/200mV/500mV/1V/2V (each range is one-half of the current range when CF=6 or 6A).
SCALE	Indicates that the scaling transformation is enabled.
L.F	Indicates that the line filter is enabled.

F.F	Indicates that the frequency filter is enabled.
RMS/DC/MN	Indicates that the measurement mode is RMS/DC/MN.
SYNC.OFF	Indicates that the synchronous source is not set.
SYNC.U	Indicates that the voltage is set as a synchronous source.
SYNC.I	Indicates that the current is set as a synchronous source.
	Indicates that the measured voltage is lower than the rated range of 30%.
	Indicates that the measured voltage is at the rated range of 30% ~ 130% (not include 130%) when CF=3; Indicates that the measured voltage is at the rated range of 30% ~ 260% (not include 260%) when CF=6 or 6A.
	Indicates that the measured voltage is at the rated range of 130% ~ 140% (not include 140%) when CF=3; Indicates that the measured voltage is at the rated range of 260% ~ 280% (not include 280%) when CF=6 or 6A.
	Indicates that the measured voltage is at the rated range of 140% ~ 300% (not include 300%) when CF=3; Indicates that the measured voltage is at the rated range of 280% ~ 600% (not include 600%) when CF=6 or 6A.
	Indicates that the measured voltage is greater than or equal to the rated range of 300% when CF=3; Indicates that the measured voltage is greater than or equal to the rated range 600% when CF=6 or 6A.
	Indicates that the measured current is lower than the rated range of 30%.
	Indicates that the measured voltage is at the rated range of 30% ~ 130% (not include 130%) when CF=3; Indicates that the measured voltage is at the rated range of 30% ~ 260% (not include 260%) when CF=6 or 6A.
	Indicates that the measured voltage is at the rated range of 130% ~ 140% (not include 140%) when CF=3;

	<p>Indicates that the measured voltage is at the rated range of 260% ~ 280% (not include 280%) when CF=6 or 6A.</p>
	<p>Indicates that the measured voltage is at the rated range of 140% ~ 300% (not include 300%) when CF=3; Indicates that the measured voltage is at the rated range of 280% ~ 600% (not include 600%) when CF=6 or 6A.</p>
	<p>Indicates that the measured current is greater than or equal to the rated range of 300% when CF=3; Indicates that the measured current is greater than or equal to the rated range 600% when CF=6 or 6A.</p>







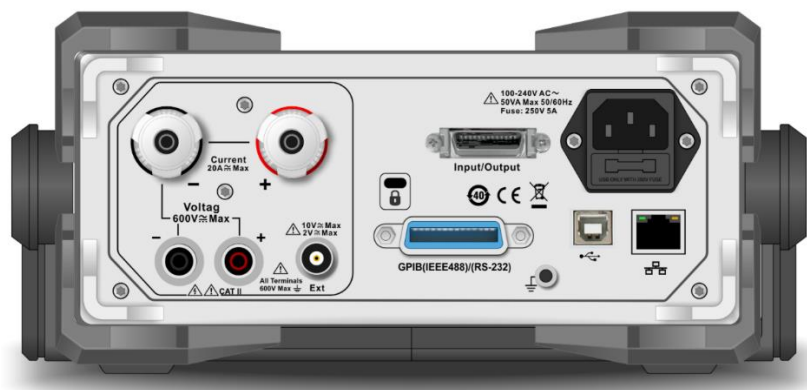

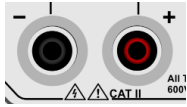

3.6 Rear Panel

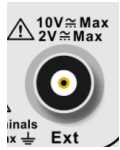
Various interfaces such as voltage and current measurement input terminals, instrument power supply socket, D/A output and control interface, RS-232/GPIB communication interface, USB communication interface, LAN Ethernet communication interface, and safety grounding are integrated on the rear panel structure of the digital power meter as shown below.

The rear panel of the UTE310 digital power meter is integrated various interfaces, such as the voltage and current measurement input terminals, the power supply socket of instrument, D/A output and control interface, the communication interface of RS-232/GPIB, USB and LAN, and safety grounded, as shown in the following figure.



Rear Panel of UTE310

No.	Picture	Function Description
1		Voltage input terminal The maximum allowable input voltage is 600V.
2		Current input terminal The maximum allowable input current is 20A.
3		External current sensor input terminal The maximum allowable input voltage is 10V when EXT1 is selected. The maximum allowable input voltage is 2V when EXT2 is selected.
4		RS-232/GPIB communication interface The default interface is S-232.
5		D/A output and control interface
6		USB communication interface
7		LAN communication interface
8		Anti-theft lock hole
9		Three-wire power socket and fuse Fuse specification: AC 250V 5A.
11		Safety grounded M4 screw hole

Chapter 4 Operation Preparation and Wire Connection

4.1 Operation Preparation

4.1.1 Connecting Power Cable

The voltage range of the instrument is 100V~240V AC (50/60Hz), please make sure the power supply is within

the rated voltage range of the instrument, and make sure the instrument is well grounded.



Warning

1. Please make sure that the power supply voltage matches the supply voltage before turning on the power, otherwise the instrument will be burned out.
2. The instrument should be used under the recommended working conditions, never use the instrument in flammable or explosive environments. Otherwise, it may cause safety injury.

4.2 Wire Connection

UTE310 digital power meter only supports a single two-wire power supply measurement. The measurement can be in accordance with the several wiring methods described in this subsection for wire connection, and to ensure that the measurement of the voltage and current is within the input range of the instrument. The UTE310 has two input methods for voltage measurement, four input methods for current measurement, and a total of eight input methods for power measurement. These are shown in the table below.

Current Voltage	Direct Input	CT Transformer	EXT (External Current Sensor Input)	CT Transformer + EXT (External Current Sensor Input)
Direct Input	①	②	③	④
VT Transformer	⑤	⑥	⑦	⑧

Explanation

VT: voltage transformer

CT: output current type current sensor, such as current transformer, current output clamp current sensor

EXT: current sensor/shunt of output voltage type



Notes

1. The load current flows along the thicker wires in the wiring diagram below, so that these wires need have a sufficiently large safe current-carrying capacity.

2. Turn off the power supply of the load and the instrument when the load end is wiring.
3. When measuring large currents/voltages or the current containing high frequency components, special attention should be paid to the possibility of mutual interference and noise problems when wiring.
4. To avoid stray capacitance affecting the measurement results, the test leads should be as short as possible.
5. In order to minimize the distributed capacitance to ground, the wire and grounding line should be as far away from the casing as possible.

4.2.1 Wire Connection of Direct Input Voltage and Current (①)

- Wire connection schematic diagram when measuring the signal with large current

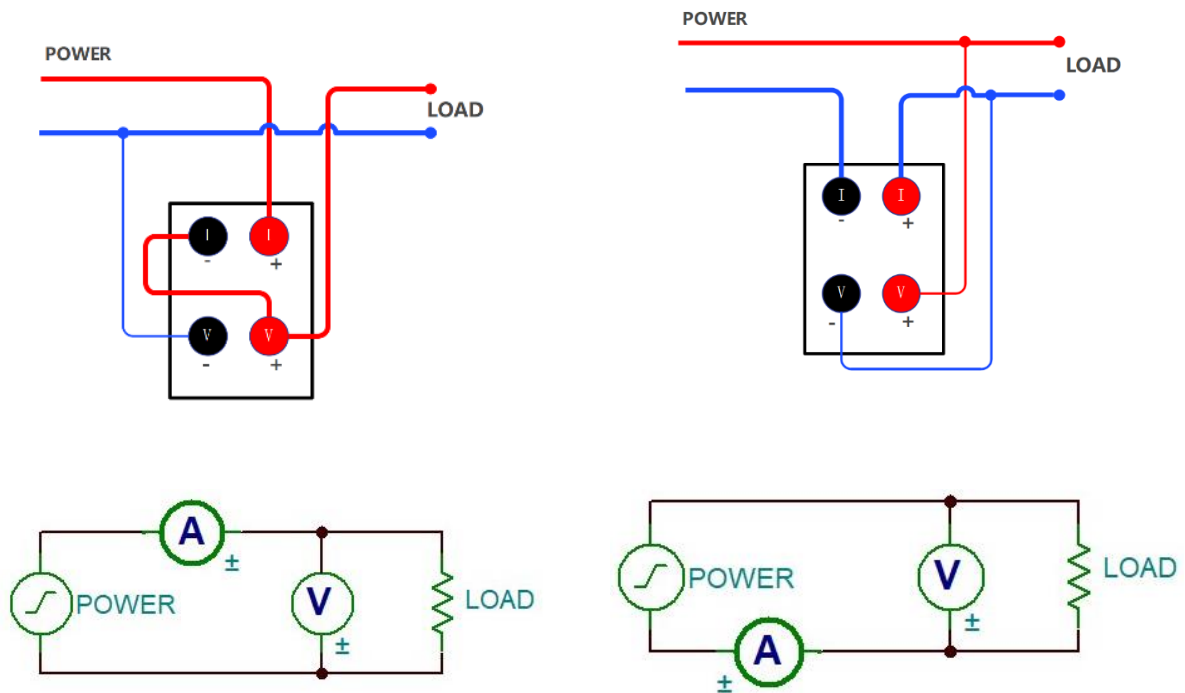

- Wire connection schematic diagram when measuring the signal with small current

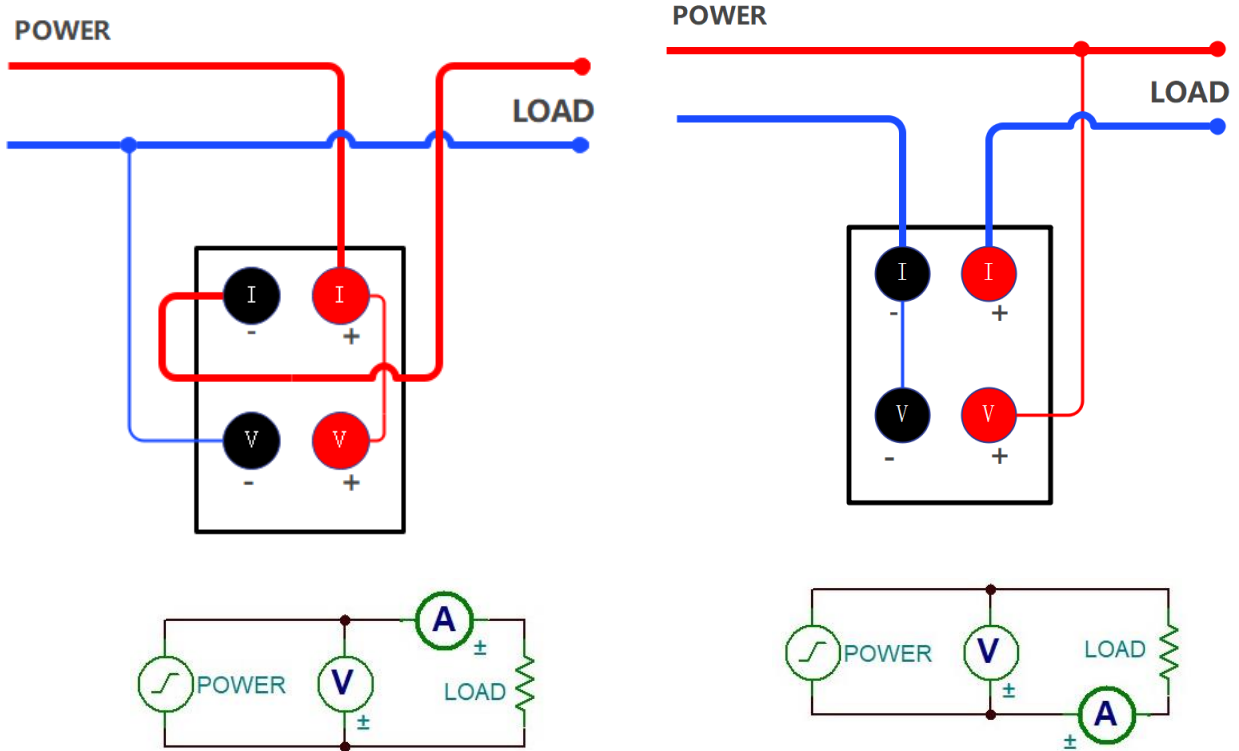

Explanation

In order to minimize the effect of stray capacitance on the measurement results, the measurement can be connected to the current input of the power meter as close as possible to the power supply ground, and use the thicker and shorter wires for the wire connection.

4.2.2 Wire Connection of Direct Input Voltage and of CT Transformer Input Current (②)

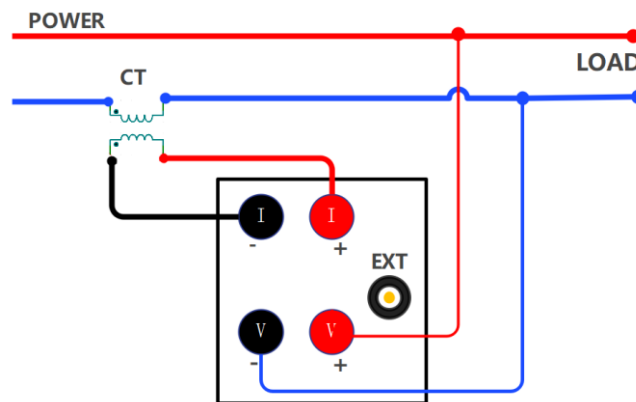

Do not use bare wire and sensor. It is important to avoid leaving the secondary side of a

current transformer (CT) open-circuited, as it can cause high voltage transients and electric shock.

4.2.3 Wire Connection of Direct Input Voltage and EXT Input Current (③)

The current sensor of output voltage type must be selected when using EXT CH. The measurement circuit connecting method is shown in the following figure.

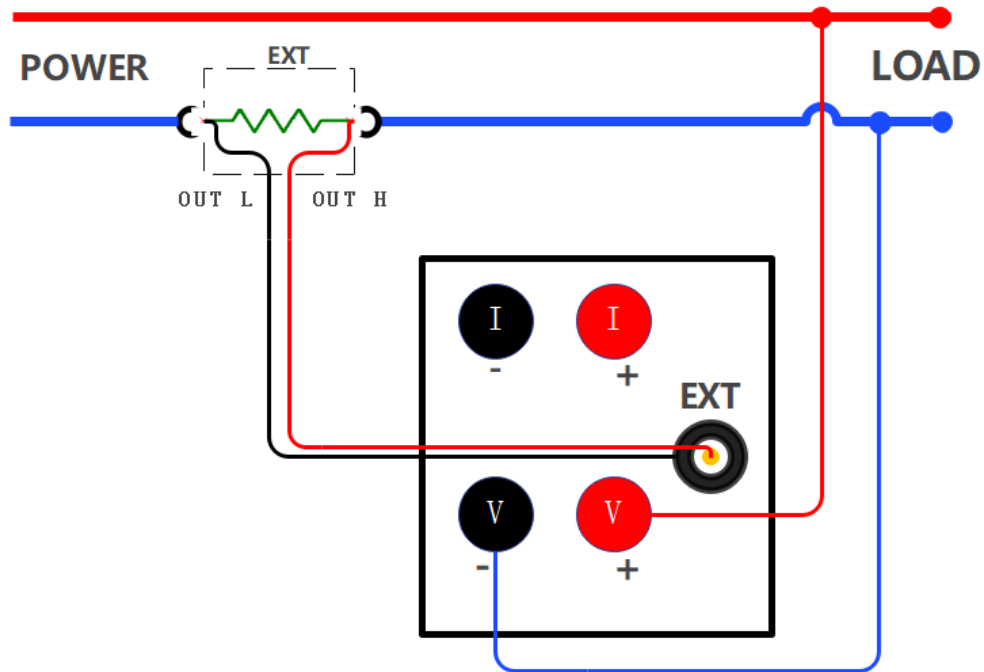

4.2.4 Wire Connection of Direct Input Voltage and (CT Transformer + EXT) Input Current (④)

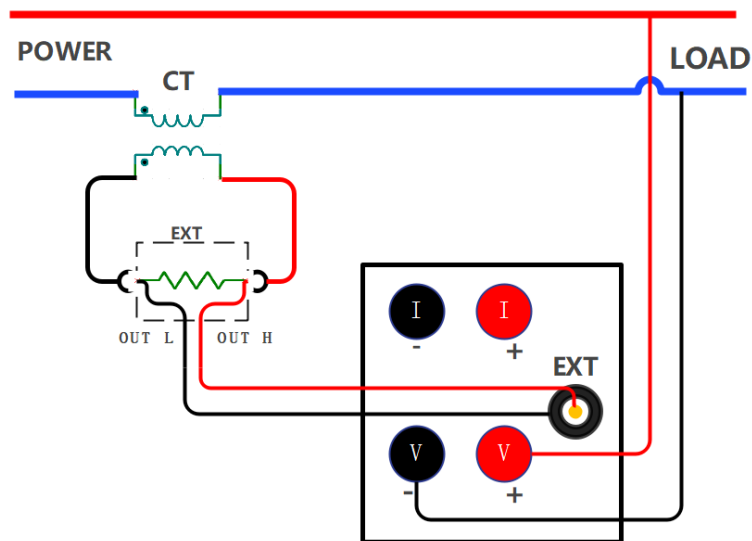

Warning

When using this wire connection for measurement, connecting the secondary side of CT to the

input terminal of EXT, and then connecting the input terminal of EXT to the sensor input of the instrument, and finally connecting CT to the circuit to be tested.



Cautions

The measurement accuracy of this method is very rely on the accuracy of external sensor. If use this way to measure the equivalent accuracy of current sensor, the measured data error will be enlarged, so do not use this measurement method unless it is necessary.

4.2.5 Wire Connection of VT Transformer Input Voltage and Direct Input Current (⑤)

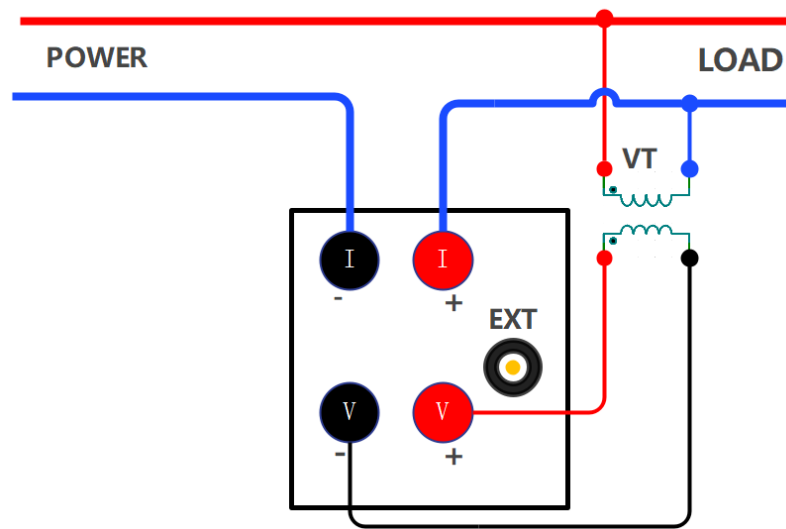

4.2.6 Wire Connection of VT Transformer Input Voltage and CT Transformer Input Current (⑥)

When the maximum current or voltage of the measuring object is over than the maximum measurement range of the instrument, it must use the CT and VT before measuring.

When using this wire connection for measurement, connecting the secondary side of CT to the current input terminal of power meter, and the secondary side of VT to the voltage input terminal of power meter, and finally connecting CT and VT to the circuit to be tested.

The wire connection example is shown in the following figure.

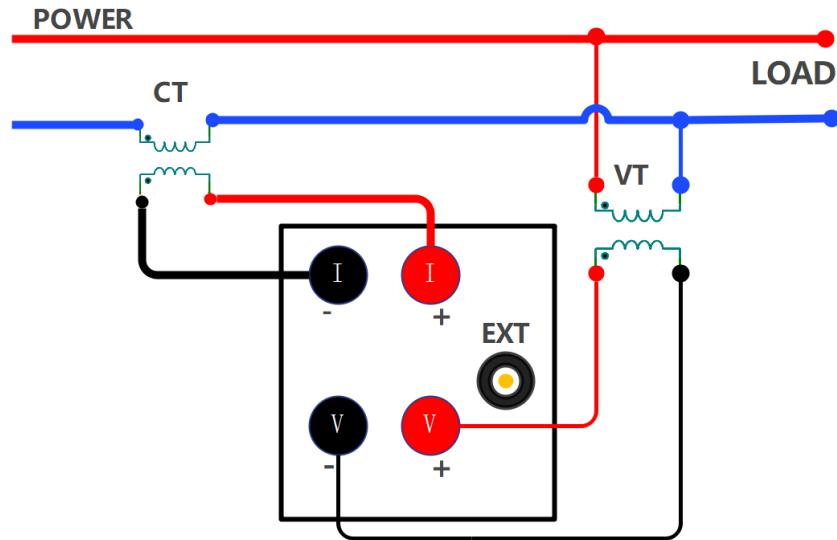

Warning

The secondary side of CT will produce high voltage when using the CT. When the current is flowing on the primary side, please avoid the secondary side of CT is open-circuit, otherwise, it will be very dangerous. Connecting the common port (-) on the secondary side of VT/CT to ground to ensure security, as shown in the following figure.

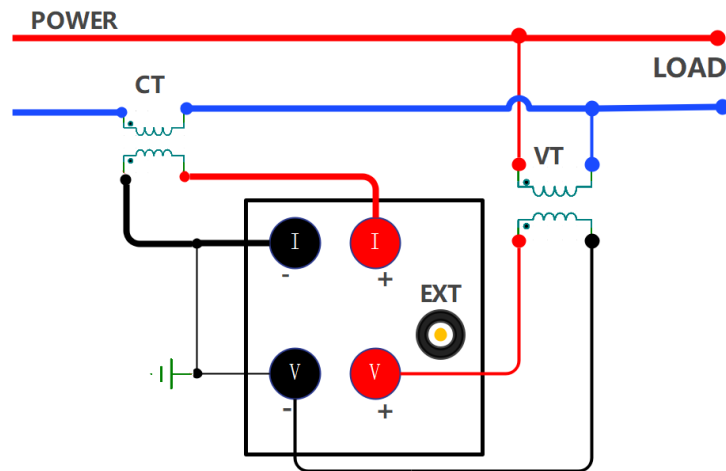

4.2.7 Wire Connection of VT Transformer Input Voltage and EXT Transformer Input Current (⑦)

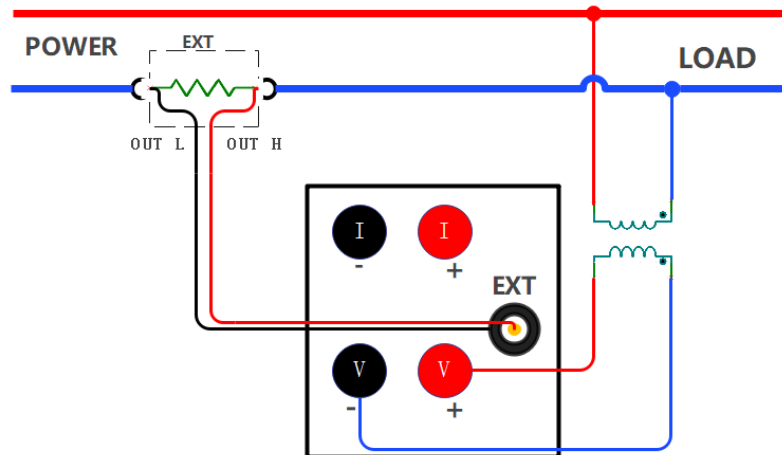

Warning

Do not use bare sensor, it may cause electric shock. Please make sure that the sensor is intact and the energized parts of the sensor are insulated from the box, and the sensor need have sufficient voltage-resistant for the voltage used in the measuring circuit.

When using EXT, do not wiring in the state of power-on. Do not touch the circuit, there is voltage on EXT when it is power on. The power of the measuring circuit must be disconnected when wiring.

4.2.8 Wire Connection of VT Transformer Input Voltage and (CT + EXT) Input Current (⑧)

The measurement accuracy of this method is very rely on the accuracy of external sensor. If use this way to measure the equivalent accuracy of current sensor, the error in the measured data will be larger than the error in using a single current sensor alone, so do not use this measurement method unless it is necessary.

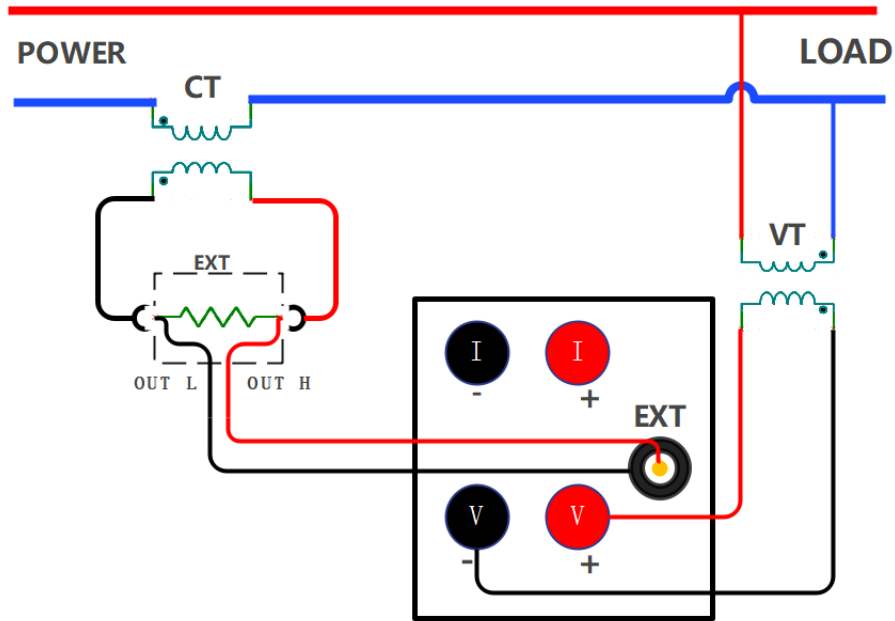

Warning

When using the CT, be sure to fully understand the specification of voltage and clamp current sensor, the operating method and the dangerous factors (such as electric shock).

When using the EXT, do not touch the CT or connecting test cables. When the power of measuring circuit on EXT is enabled, the CT will produce the voltage, so it is dangerous.

Please use the connector that has safety design to connect the EXT of the instrument. In the event that a connector is dislodged, a voltage is generated at the conductive part, which is very dangerous.

4.2.9 Connecting Power Supply

Plug the power socket on the rear panel and use the specified power voltage, the power socket should be with ground wire. After checking that the wiring is correct, open the instrument switch on the front panel, the instrument will enter to the measurement state.



Cautions

In order to ensure the stability of the instrument measurement data, the instrument should be warmed up for 30 minutes before starting the measurement. After cutting off the power supply of the instrument, it should be waited for more than 5 seconds before powering up again. It is strictly prohibited to switch the power supply repeatedly within a short period of time, or else it will shorten the life of the instrument, and may cause the instrument to malfunction. After use, please turn off the instrument power and unplug it to prevent the instrument from being damaged by possible lightning strikes.

Chapter 5 Measurement Settings

5.1 Range Settings

5.1.1 Voltage Range Settings

·Steps

1. In any interface, press the **[Voltage]** key to pop out the selection window of voltage range;
2. Press the **[▲]** or **[▼]** key to select the voltage range;
3. Press the **[Enter]** key to save the selected voltage range and exit the selection window or wait for 10s to automatically save and then exit.

·Explanations

Selection range: Auto, 15V, 30V, 60V, 150V, 300V, 600V (CF=3)

Auto represents the automatic range.

When CF=6 or 6A, all ranges will be reduced to half of the original, i.e. 7.5V, 15V, 30V, 75V, 150V, 300V.

5.1.2 Current Range Settings

·Steps

1. In any interface, press the **[Current]** key to pop out the selection window of current range;
2. Press the **[▲]** or **[▼]** key to select the current range;
3. Press the **[Enter]** key to save the selected current range and exit the selection window or wait for 10s to automatically save and then exit.

Common Measurement

Selection range: Auto, 5mA, 10mA, 20mA, 50mA, 100mA, 200mA, 500mA, 1A, 2A, 5A, 10A, 20A.

The display interface will synchronize the currently selected current range.

Auto represents the automatic range.

When CF=6 or 6A, all ranges will be reduced to half of the original, i.e. 2.5mA, 5mA, 10mA, 25mA, 50mA, 100mA, 250mA, 500mA, 1A, 2.5A, 5A, 10A.

When use EXT CH (the external current sensor) to measure

When using Ext1, the range can select to Auto, 2.5V, 5V, 10V

When using Ext2, the range can select to Auto, 50mV, 100mV, 200mV, 500mV, 1V, 2V.

The display interface will synchronize the currently selected current range.

Auto represents the automatic range.

When CF=6 or 6A, all ranges will be reduced to half of the original, i.e. Ext1: Auto, 1.25V, 2.5V, 5V.

Ext2: Auto, 25mV, 50mV, 100mV, 250mV, 500mV, 1V.

5.1.3 Range Switching

Manual Range

If the measurement range is set to manual range, the selected range will not be change even if the size of input signal changes.

Auto Range

If the measurement range is set to auto range, the instrument will synchronous switch range according to the size of input signal.

Voltage Range Automatic Increasing

When any one the following condition is met, the voltage range will be increased.

- The measured voltage U_{rms} exceeds the rated range of 130% (CF=3 or 6).
- The measured voltage U_{rms} exceeds the rated range of 260% (CF=6).
- Transient sampling voltage or voltage peak U_{pk} exceeds the rated range about 300% (CF=3).
- Transient sampling voltage or voltage peak U_{pk} exceeds the rated range about 600% (CF=6 or 6A).

Voltage Range Automatic Decreasing

When any one the following condition is met, the voltage range will be decreased.

- The measured voltage U_{rms} is less than or equal to the rated range of 30% and less than the previous scale of 125%, and the voltage peak U_{pk} is less than or equal to the previous scale of 300% (CF=3).
- The measured voltage U_{rms} is less than or equal to the rated range of 30% and less than the previous scale of 125%, and the voltage peak U_{pk} is less than or equal to the previous scale of 600% (CF=6 or 6A).

Current Range Automatic Increasing

When any one the following condition is met, the current range will be increased.

- The measured current Irms exceeds the rated range of 130% (CF=3 or 6).
- The measured current Irms exceeds the rated range of 260% (CF=6).
- Transient sampling current or current peak Ipk exceeds the rated range about 300% (CF=3).
- Transient sampling current or current peak Ipk exceeds the rated range about 600% (CF=6 or 6A).

Current Range Automatic Decreasing

When any one the following condition is met, the current range will be decreased.

- The measured current Irms is less than or equal to the rated range of 30% and less than the previous scale of 125%, and the current peak Ipk is less than or equal to the previous scale of 300% (CF=3).
- The measured current Irms is less than or equal to the rated range of 30% and less than the previous scale of 125%, and the current peak Ipk is less than or equal to the previous scale of 600% (CF=6 or 6A).

5.2 Measurement Mode

UTE310 series has three measurement modes. The user can set the mode according to the signal type or the value to be displayed.

Setting Steps

1. Press the **[Shift]** key and then press the **[Voltage/Mode]** key to switch the measurement mode;
2. Repeat the first step can step through the measurement mode to RMS, DC or MN;
3. Press the **[Enter]** key to select the current option and save.

Explanations

Display value in different measurement mode

Measurement Mode	Voltage	Current
RMS	Display RMS	Display RMS
DC	Display the simple average value	Display the simple average value
MN	Display the voltage calibration average value	Display the voltage calibration average value

RMS mode: select this mode to display the RMS of voltage and current, the calculation formula is as

follows.

$$\sqrt{\frac{1}{T} \int_0^T f(t)^2 dt}$$

f(t): Input signal

T: Period of input signal

DC mode: select this mode when input DC voltage and current, calculating the simple average for the input signal. The calculation formula is as follows.

$$\frac{1}{T} \int_0^T f(t) dt$$

f(t): Input signal

T: Period of input signal

MN: select this mode to display the rectified average value calibrated to the RMS value, calculated by the following formula.

$$\frac{\pi}{2\sqrt{2}} \times \frac{1}{T} \int_0^T |f(t)| dt$$

f(t): Input signal

T: Period of input signal

5.3 Meter Common Measurement and Settings

Meter common measurement has three display styles, VIEW-1, VIEW-2 and VIEW-3. The user can select the style according to the parameter to be displayed. The meter menu is shown in the following.



5.3.1 VIEW-1

Press the [Meter] key to select Meter common measurement function (Meter indicator will be illuminated), the default selection is VIEW-1. VIEW-1 has four test interfaces, the first interface displays the voltage (such as RMS voltage, voltage calibration average value, voltage AC component, voltage DC component, voltage positive peak value, voltage negative peak value); the second interface displays the current (such as RMS current, current calibration average value, current AC component, current DC component, current positive peak value, current negative peak value); the third interface displays the power (such as average active power, apparent power, reactive power, positive peak value of average active power, negative peak value of average active power, power factor); the fourth interface displays the frequency, crest factor, phase and synchronizing frequency of measurement parameter.

Each of the measurement interfaces can also set a parameter as the main display parameter (displayed in blue background with large font), which can be configured by the [CONFIG] key under the corresponding interface, and the four display interfaces can be switched by the [◀] or [▶] key, as shown in the following figure.



Voltage



Current



Power, Power Factor



Frequency, Power Factor, Phase Angle, Synchronizing

Frequency

5.3.2 VIEW-2

VIEW-2 can display 14 parameters at the same time. The user can choose this display style when they need to observe several parameters at the same time. Press the **[Meter]** key to enter the Meter measurement menu, and then press the function key below VIEW-2 to switch to the VIEW-2 display style, as shown in the following figure.

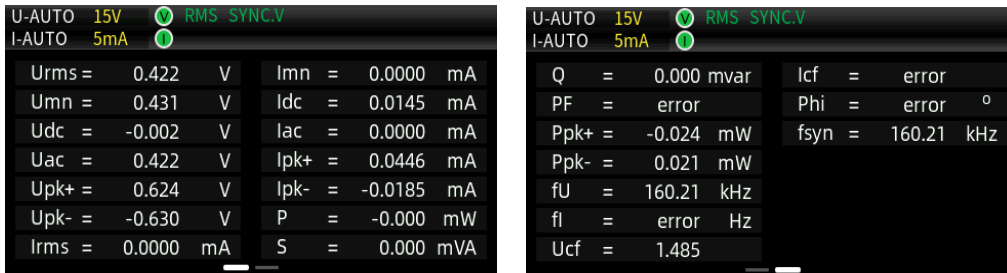

VIEW-2 has two display interfaces, press the [◀] or [▶] key to switch.

5.3.3 VIEW-3

Under VIEW-3 display style, mathematical operation can be carried out according to the user's demand, supporting the display of four areas A, B, C, D. Each area can be set and displayed independently, and the parameters displayed in A, B area can also be set to be displayed in the C area after arithmetic operation. Press the **[Meter]** key to enter the Meter measurement menu, then press the function key below VIEW-3 to switch to VIEW-3 display style, as shown in the following figure.

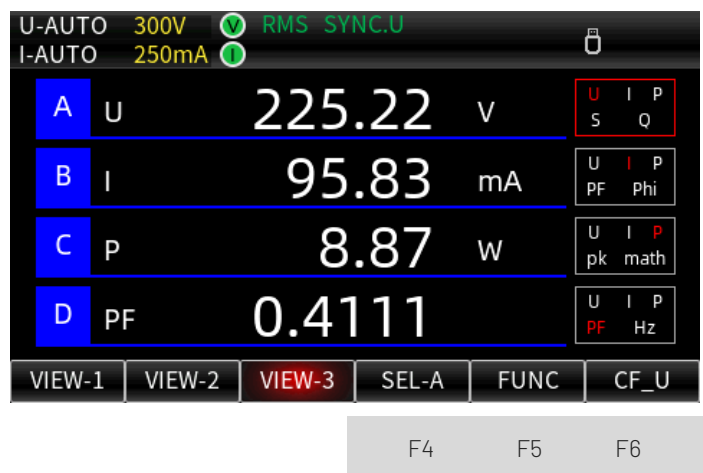

When selecting the VIEW-3 display style, the measurement window will be increased by three positions of F1,

F2, F3 corresponding to the function indication. For the sake of simplicity, respectively, use F1, F2, and F3 to describe its function in this subsection.

Explanation

F4: Press the "F4" key to display SEL-A, SEL-B, SEL-C, SEL-D in sequence, which means the display area A, B, C, D is selected, and then press "F5" to edit the selected area, and the border of the window will change from white to red when the window is selected;

F5: FUNC, switch the displayed parameter, when math is selected in the C area, the parameter displayed in the C area is the result of the operation of the A area and the B area, and the mathematical operation formula is determined by the mathematical formula in "F6";

F6: Press the "F6 key to display CF_U (voltage crest factor), CF_I (current crest factor), A+B, A-B, AxB, A/B, A/BB, AA/B, AV_P (average active power during integration, the specified average active power will only be displayed when the integration in the start/stop state) in sequence.

- Example of mathematical operation

AxB: Display the result of multiplying area A with area B

This function can be used to display apparent power S in the C area in VIEW-3 style.

Display Area A	Display Area B	Display Area C	Wiring Method
U	I	$U \cdot I = S$	No limit

A/B: Display the result of dividing area A with area B

Calculating the absolute value of impedance (Z)

Display Area A	Display Area B	Display Area C	Wiring Method
U	I	$\frac{U}{I} = Z $	

A/BB: Display the result of dividing the square of area A with area B

Calculating the impedance (Z), the resistance (R) and the reactance (X)

Display Area A	Display Area B	Display Area C	Wiring Method
----------------	----------------	----------------	---------------

S	I	$\frac{S}{I^2} = Z $	Arbitrary
P	I	$\frac{P}{I^2} = R$	
Q	I	$\frac{Q}{I^2} = X $	

AA/B: Display the result of dividing the square of area A by the area B

Calculating the resistance (R)

Display Area A	Display Area B	Display Area C	Wiring Method
U	P	$\frac{U^2}{P} = R$	

5.4 Harmonic Measurement

Harmonic measurement is fully compliant with the international standard for harmonic measurement IEC61000-4-7:2002. Depending on the fundamental frequency, voltage, current and power can be measured up to the 50th harmonic, regardless of the total harmonic distortion (THD), the fundamental component, the harmonic content of each number of harmonics, the phase difference, the harmonic distortion factor, etc., can all be measured.

In addition, the upper limit of harmonic analysis times can freely set between 1~50, and if the upper limit of THD operation is specified, it can also be operated according to its specification.

Note: The IEC 61000-4-7:2002 standard strictly defines the harmonic calculation methods, such as time windows, synchronization, window functions, etc. And it specifies the performance of standard measurement instruments.

The harmonic measurement has two display modes, one is a bar graph (BAR) mode and the other is a list mode (LIST), the default is displayed as a bar graph, as shown in the following.

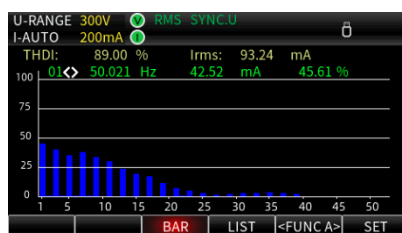

Bar Graph Mode

List Mode

Explanation

FUNC U/A/P can only be displayed at bar graph. In the list mode, if there is no input signal or the harmonic measurement is abnormal (no analyzed times), the value of each harmonic is displayed as -----, e.g. in IEC mode, the 41st to 50th harmonics are displayed as -----, and the rest of the times can be displayed as actual.

5.4.1 BAR Graph

BAR graph mode can simultaneously display the RMS value of each harmonic and harmonic distortion factor (harmonic content rate), press the [◀] or [▶] key to select the number of harmonics need to be measured, after the harmonic time is selected, the current harmonics of frequency, RMS and distortion factor (distortion rate) can be viewed. Pressing the FUNC U/A / P function keys to switch the displayed parameter, there are a total of three kinds of parameter in the mode. That is,

FUNC U: voltage harmonic can measure the voltage frequency, RMS, distortion factor and total harmonic distortion factor from each harmonic component of 1~50.

FUNC A: voltage harmonic can measure the current, RMS, distortion factor and total harmonic distortion factor from each harmonic component of 1~50.

FUNC P: average active power harmonic can measure the frequency, RMS, power factor and distortion factor of average active power for each harmonic component of 1 to 50.



FUNC U Interface

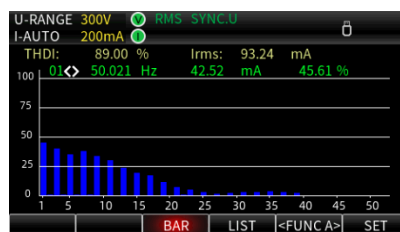

FUNC A Interface



FUNC P Interface

5.4.2 LIST Mode

The RMS, harmonic distortion factor and the phase angle voltage and current of each harmonic component of 1~50 can be displayed in the list mode, as shown in the following figure.

Order	U(V)	I(mA)	P(W)
1	225.53	52.55	10.803
2	0.47	1.88	-0.000
3	3.26	47.98	-0.043
4	0.18	1.84	0.000
5	6.09	42.54	0.184
6	0.17	1.57	-0.000

Display the voltage, current and RMS of power of each harmonics

Order	U(%)	I(%)	P(%)
1	100.00	100.00	100.00
2	0.209	3.581	-0.001
3	1.445	91.312	-0.395
4	0.079	3.502	0.000
5	2.702	80.962	1.699
6	0.074	2.997	-0.001

Display the distortion factor of each harmonics

Order	U(°)	I(°)
1	-20.9	-20.9
2	154.2	43.2
3	57.6	101.7
4	168.1	179.5
5	19.7	-127.6
6	-132.5	-47.9

Display the phase angle of voltage and current of each harmonics

Pressing the [◀] or [▶] key to switch to the display mode (display the harmonic content or harmonic ratio), pressing the [▲] or [▼] key to turn the page to display the harmonic component of different orders.

5.4.3 HARMONIC SET

In the harmonic setting menu, it can set the harmonic analysis mode, PLL source, the maximum harmonic analysis time and the calculation formula of THD. In the harmonic measurement interface, press the "SET" key to enter the harmonic setting, the setting interface is shown as follows.

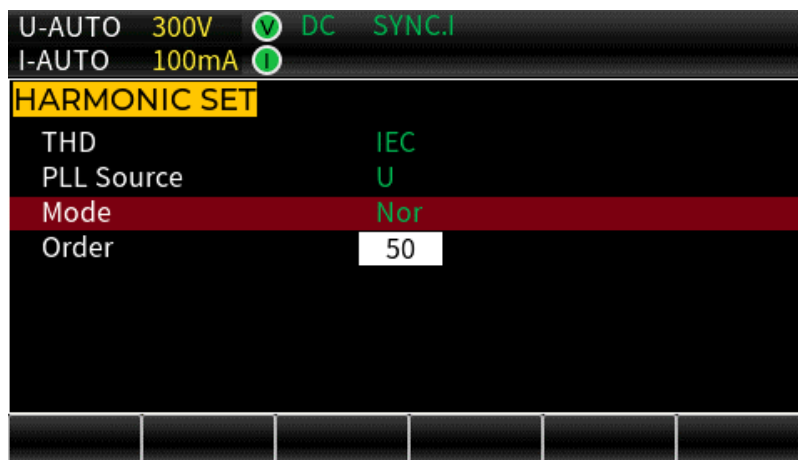

- THD

The calculation formula of THD has two methods, IEC and CSA. The default method is IEC.

IEC: Calculating the ratio of the RMS of the 2-50 harmonic components to the RMS of the fundamental waveform, the formula is as follows.

$$THD = \frac{\sqrt{\sum_{k=2}^n (C_k)^2}}{C_1}$$

CSA: Calculating the ratio of the RMS of the 2~50 harmonic components to the RMS of the 1~50 harmonic components, the formula is as follows.

$$\text{THD} = \frac{\sqrt{\sum_{k=2}^n (C_k)^2}}{\sqrt{\sum_{k=1}^n (C_k)^2}}$$

C_1 : Fundamental wave component

C_k : Fundamental wave component and harmonic content

k: Harmonic analysis time

n: The maximum of harmonic analysis time is determined by the fundamental frequency of PLL source.

- **PLL Source**

To enable the harmonic measurement function, you need to select the PLL source. It is used to determine the frequency of the fundamental waveform, which is the reference for harmonic measurement. The default PLL source is U (voltage frequency). The signal period of the PLL source should be the same as the signal period of the harmonic measurement to be performed, and the input signal with less distortion should be selected as the PLL source signal, so as to ensure the stability of harmonic measurement.

- **Harmonic Mode**

The user can select Nor (normal mode) or IEC mode. In the different measurement mode, the calculate count of the time window and of FFT (Fast Fourier Transform) are different. In the harmonic setting interface, press the [▲] or [▼] key to select Mode, and press the [◀] or [▶] key to select the Nor or IEC mode.

Nor measurement mode: use the fixed 1024 count to calculating FFT, and it will adjust with the fundamental frequency, the measurement method is shown the following table.

Fundamental Frequency (f)	Sampling Rate	Window Width	Upper Limit of Analysis Time
10Hz≤f<75Hz	f×1024	1	50

75Hz≤f<150Hz	f×512	2	32
150Hz≤f<300Hz	f×256	4	16
300Hz≤f<600Hz	f×128	8	8
600Hz≤f≤1200Hz	f×64	16	4

IEC measurement mode: (measured by the standard IEC61000-4-7:2002), use the time window of 200ms to calculating FFT, the maximum number of THD calculations is 40. The measurement method is shown the following table.

Signal System	Sampling Rate	Window Width	Upper Limit of Analysis Time
50Hz system	f×512	10	40
60Hz system	f×512	12	40

- **Order: the maximum of harmonic analysis time**

The user can select the upper limit of harmonic measurement, and the range is 1~50.

Since the upper limit of harmonic time depends on the fundamental frequency: when the fundamental frequency is 50Hz, the upper limit of the harmonic analysis time is 50; when the fundamental frequency is 1.2 kHz, the upper limit of the harmonic analysis time is 4.

5.5 Wave Display

The wave display mode supports display the voltage and current, the display grid is 300. In the wave display mode, the peak-to-peak of the voltage and current can be measured, as shown in the following.

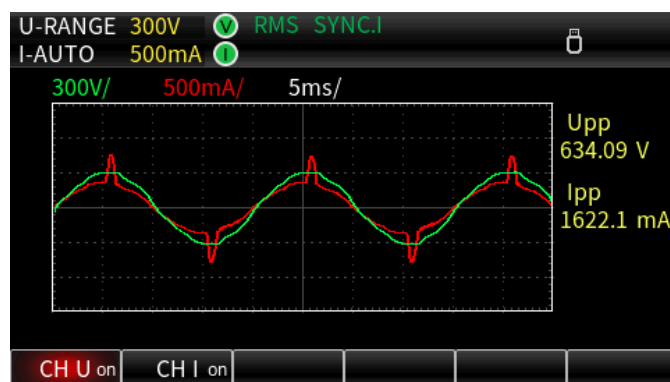

CH U_{on} : enable the voltage waveform display

CH U_{off} : disable the voltage waveform display

CH I_{on} : enable the current waveform display

CH I_{off} : disable the current waveform display

5.5.1 Time Axis

The user can use the encoder knob to adjust the displayed time axis, so that the waveform of multiple signal period can be observed. The time axis can select to 100us/div, 200us/div, 500us/div, 1ms/div, 2ms/div, 5ms/div, 10ms/div, 25ms/div, 50ms/div, 100ms/div, 200ms/div, 500ms/div, 1s/div, and 2s/div.

5.5.2 Vertical Axis

The vertical axis scale of the UTE310 waveform display is automatically selected by the instrument and cannot be changed by the user through the key setting. The vertical axis scale for voltage and current is (rated range/3)/div.

5.6 Integration

UTE310 supports the average active power integration and the current integration.

The integrated value and integration time can be displayed during integration. The instrument has three integration modes, manual integration, standard integration (Normal) and continuous integration. The integration interface is shown in the following figure.



Power integration in manual mode



Power integration in standard mode



Current integration in continuous mode

Integration mode can select to Normal or Continuous. The default mode is Normal.

Integration state includes three states, the start, stop and reset state.

Start represents that the integration is processing.

Stop represents that the integration is stopped.

Reset represents that reset the integration.

Set Time: integration timer

The user can set the integration timer according to the test needs. The instrument will stop integration or enter the next integration period when it reaches to the set time. The maximum can be set to 10000:00:00.

Test Time: integration counter

The integration counter will start to count the time when the integration is enabled. It indicates the actual time of integration, the maximum display is 10000:00:00.

5.6.1 Normal Integration

The default integration mode is manual integration. In standard integration mode, if the time of integration timer is set to 00000:00:00 (0 hours, 0 minutes and 0 seconds), it will automatically switch to manual integration mode. In the manual integration mode, the user can use the key to start, stop or reset the integration. When the integration time reaches the maximum value (10000:00:00) or the integration reaches the maximum/minimum display value, the integration will be stopped automatically. When the timer time is set, this mode is the integration mode. In the standard integral mode, the integration mode can only be a single integration, press the **[Start]** key to start the integration, press the **[Stop]** key to stop the integration, at this time, if the integration time does not reach the time set by the timer, press the **[Start]** key again will

continue to integration, the integration will automatically stop and keep the integrated value and integration time when the integration time reaches the set time of the timer. Pressing the combination key **[Shift + Reset]** to reset the integrated value and integration time, and then press the **[Start]** key again to start the next integration. The integration schematic of standard integration mode is as follows.

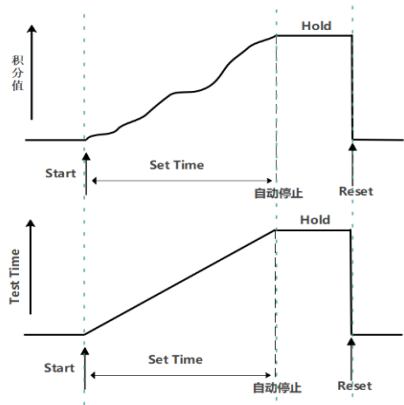

Standard Integration Process

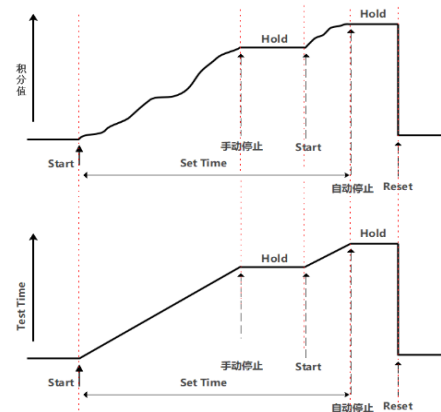

Standard Integration Process (including manual stop and reset)

5.6.2 Continuous Integration

In the continuous integration mode, the integration time and integrated value will be cleared automatically after the integration time reaches to the set time, and the next integration will be restarted.

Setting Method

Press the **[SET]** key in the integration interface to enter the integration mode setting, switch the mode by pressing **[◀]** or **[▶]** key, and then jump to the integration timer setting by pressing the **[▼]** key, and increase or decrease the value by rotating the encoder knob when editing the integration timer, and then press the **[Enter]** key to save the set parameters after the setting is completed. The integration schematic of the continuous integration mode (including the process of manual stop, start, and reset) is as follows.

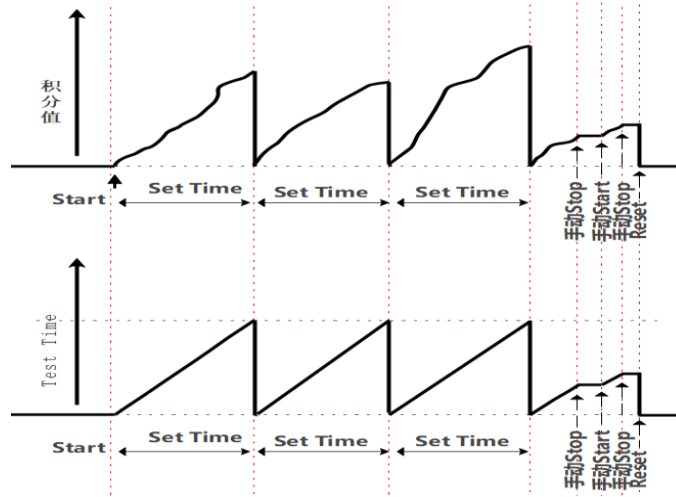

Set Time: time of integration timer

Test Time: integration time

 **Cautions**

In the continuous integration mode, the time if timer cannot be 0, pressing the **[Start]** key when the timer sets to 00000:00:00, the instrument will pop out "Error, the integration time of continuous mode must be more than..." and the integration will not be performed.

5.6.3 Comparison of Integration Mode

Integration Mode	Start Condition	Stop Condition	Integration Hold	Repeat Integration
Manual Integration	Press the [Start] key	Press the [Stop] key	Hold the integration time and the integrated value during the integration is stopped, until press the [Reset] key.	/
		The integration will be stopped when the integrated value reaches to the maximum value or the minimum value. Explanation The minimum value is negative value.		
		The integration will be		

		stopped when the integration time reaches to the maximum value.	
Standard Integration (Normal)	Press the [Start] key	Press the [Stop] key	/
		The integration will be stopped when the integration reaches to the set time of timer.	
		The integration will be stopped when the integrated value reaches to the maximum value or the minimum value. Explanation The minimum value is negative value.	
Continuous Integration (Continuous)	Press the [Start] key	The integration will be stopped when the integrated value reaches to the maximum value or the minimum value. Explanation The minimum value is negative value.	The integration will be repeated when the timer is overflow.
	The integrated value and integration time will be cleared automatically after	The integration will be stopped when the integrated value reaches to the maximum value or the minimum value.	

	the integration time reaches to the set time, and the next integration will be restarted.	Explanation The minimum value is negative value.		
		Press the [Stop] key		

5.6.4 Integration Method

The integration is calculated differently for different measurement modes. If the measurement mode is DC, the instantaneous values of power and current are integrated; when the measurement mode is set to RMS, the current is measured in each data update cycle will be integrated, as shown in the table below.

Power Integration	RMS	$\sum_{i=1}^n U_i \times I_i$
	MN	
	DC	
Current Integration	RMS	$\sum_{I=1}^N I_I$
	MN	
	DC	$\sum_{i=1}^n I_i$

Explanation

- U_i : the instantaneous value of voltage
- I_i : the instantaneous value of current
- I_I : the measured current in each data update cycle
- n: the point of data sampling
- N: the number of data update

5.6.5 Integration Settings

Please ensure that the integral state is **Reset** before setting the integral, otherwise, the integration setting cannot be set.

- **Integration Mode**

1. Press the **[SET]** key in the integration interface, the character will be highlight with blue color in the Mode option, as shown in the following figure.

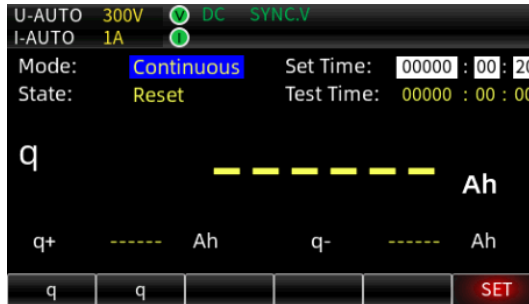

2. Select the integration mode “Continuous” or “Normal” by pressing the [◀] or [▶] key.
3. Save the selected mode and exit the integration mode settings by pressing the [Enter] key.

● Integration Timer

1. Press the [SET] key in the integration interface, and select “Set Time” by pressing [▲] or [▼] key, the editing digital bit will be highlight with black color, as shown in the following figure.

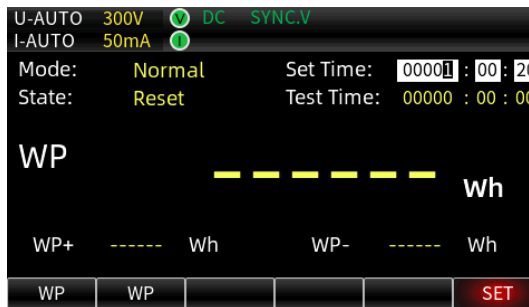

00001 : 00 : 20
Hour Minute Second

2. Increase or decrease the numerical value by pressing the encoder knob.
3. Press the [Enter] key to save the setting and exit after the numerical value is set.

● Integration Parameter

For the sake of simplicity, the function key at the bottom of the instrument display are partially customized here, and the definitions of each function key are shown in the following figure.



1. In the integration interface, press the “F1” key to switch to the power integration WP or the

current integration q.

2. Press the "F2" key to switch to the parameter with big font.

When WP is selected by the "F1" key, the integration interface displays WP, WP+ and WP-.

When q is selected by the "F1" key, the integration interface displays q, q+ and q-.

WP: total watt hour

WP+: positive watt hour

WP-: negative watt hour

q: total ampere hour

q+: positive ampere hour

q-: negative ampere hour

5.6.6 Integration Operation

1. Starting Integration

Press the **[Start]** key to start the integration, the **[Start]** indicator will be illuminated, and the "Start" character will display at the measurement interface.

2. Stopping Integration

Press the **[Stop]** key to stop the integration, the **[Start]** indicator will be extinguished and the **[Stop]** indicator will be illuminated. The "Stop" character will display at the measurement interface.

The display interface keeps the integrated value and the integration time before stop.

3. Resetting Integration

After the integration is stop, if the integration need to run a new round, the integrated value and the integration time should be reset, press the **[Shift + Reset]** rest key to reset, the "Reset" character will display at the measurement interface. The **[Stop]** indicator will be extinguished and the integrated value and the integration time will be zeroed, as shown in the following figure.

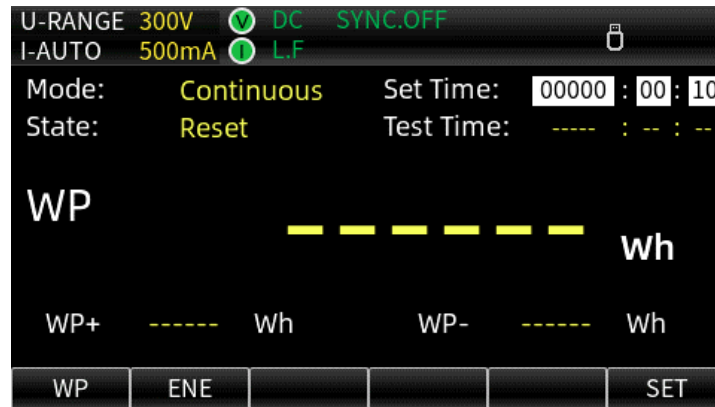

5.6.7 Limitations during Integration

During integration, these settings will be limited. "√" indicates the setting can be operated. "/" indicates the setting cannot be operated.

Function	Integrating	Integration Stopped	Integration Reset
Meter	√	√	√
Harmonic	√	√	√
Wave display	√	√	√
Scale setting	/	/	√
Measurement mode switching	√	√	√
Zero calibration	√	√	√
Data Hold	√	√	√
Max Hold	√	√	√
Power/current integration switching	√	√	√
Integration mode	/	/	√
Integration timer	/	/	√
Starting integration	/	√	√
Stopping integration	√	/	/
Resetting integration	/	√	/
Synchronization source	/	√	√
Line filter	/	√	√

Frequency filter	/	√	√
Crest factor	/	√	√
Data update	/	√	√
Automatic time-out	/	√	√
Automatic data synchronization source	/	√	√
Initialization	√	√	√
Average filter	/	√	√
External sensor CH	/	√	√
Ratio setting	/	√	√
D/A setting	/	√	√
Skipping range	/	√	√
System information	√	√	√
Key brightness	√	√	√
Key sound	√	√	√
Communication protocol	√	√	√
Data storage	√	√	√
Storage time interval	√	√	√
RS232	√	√	√
IP setting	√	√	√
Storage device	√	√	√

Chapter 6 Setup Menu

The setup menu includes measurement data synchronization source, filter, crest factor, data update interval, automatic timeout, automatic data synchronization source, average filter (AVG), external current sensor input (EXT) and external proportional converter VT/CT/PT, JUMP (skipping range), D/A Output and Control, etc. This chapter is to introduce the setting method of each function in the Setup menu.

6.1 SETUP

Pressing the [SETUP] key in any interface to enter the Setup menu, press the arrow key [▲], [▼], [◀], [▶] to select or switch to the parameter setting, as shown in the following figure.

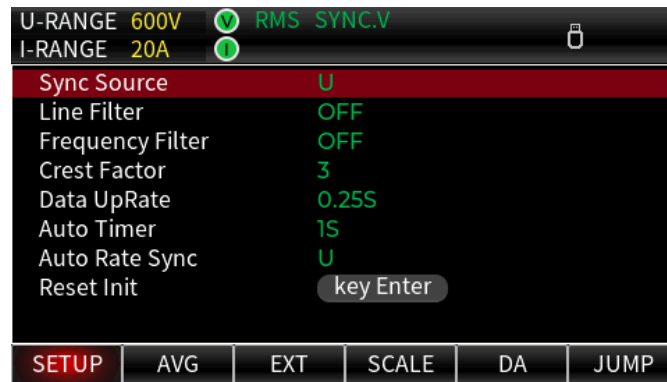

6.1.1 Sync Source

The synchronization source determines the measurement interval of the input signal, which will be the interval in the data update cycle from the initial point of the rising or falling slope through zero to the final point of the rising or falling slope through zero, as shown in the following figure

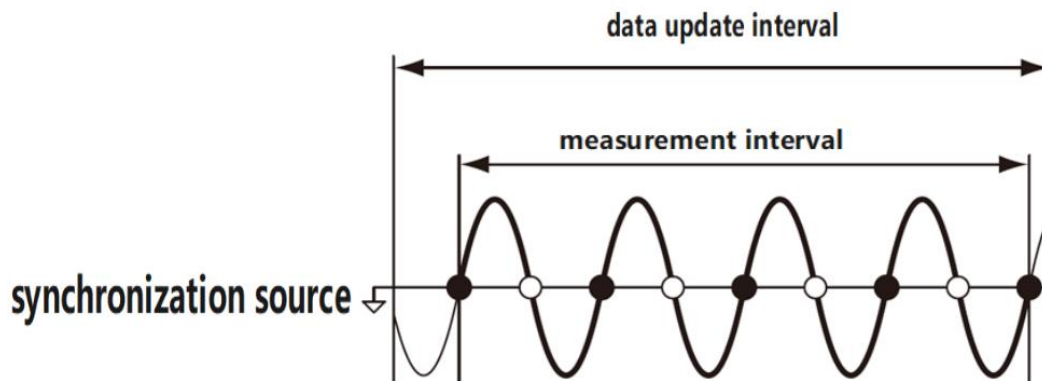

- : rising through zero
- : falling through zero

If there is no or only one rising slope or falling slope in the data update interval, the entire data update interval is used as the measurement interval.

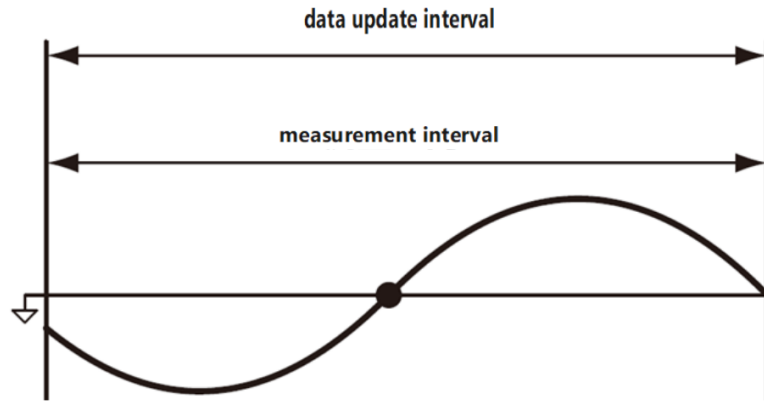

The UTE310 digital power meter finds the measurement data by averaging the sampled data over the measurement interval. The period of the input signal is detected from the voltage signal and current signal, and the user can set the voltage signal (U) or current signal (I) as the synchronization source.

- U (voltage): The period of the voltage signal is preferentially measured and set as the synchronization source, and the voltage signal becomes the synchronization source for each input unit; if the period of the voltage signal cannot be measured, the current signal is set as the synchronization source.

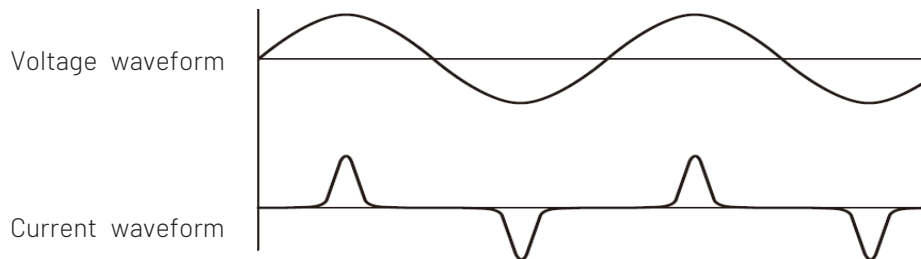

If the measurement object is a switching power supply, the voltage and current waveforms are shown in the figure, and from the waveforms, it can be seen that the voltage waveform has less distortion compared to the current signal, so the voltage signal should be set as a synchronous source at this time.

- I (current): The period of the current signal is preferentially measured and set as the synchronization source, and the current signal becomes the synchronization source for each input unit, or the voltage signal is set as the synchronization source if the period of the current signal cannot be measured.

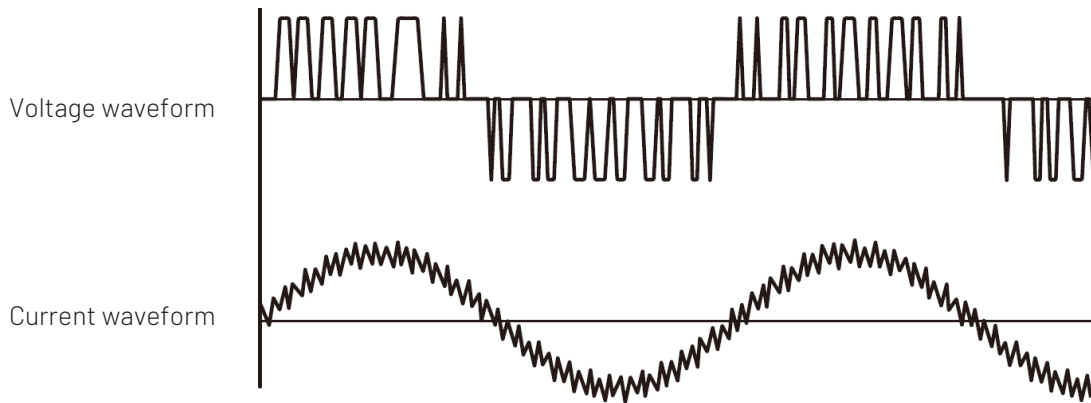

If the measurement object is a converter, the voltage and current waveforms are shown in the figure, and from the waveforms, it can be seen that the current waveform has less distortion compared to the voltage signal, so the current signal should be set as a synchronous source at this time.

- OFF (not use voltage and current signals as a synchronization source): When measuring a DC signal, if a pulse noise with small variations crosses the zero level on the DC signal, the point is detected as a zero crossing, and thus the measurement interval is detected incorrectly. As a result, sample data within the unconscious measurement interval is averaged, and voltage and current measurements may be unstable. This type of false detection can be prevented by averaging the data sampled during the entire data update cycle when the synchronization source is set to OFF.

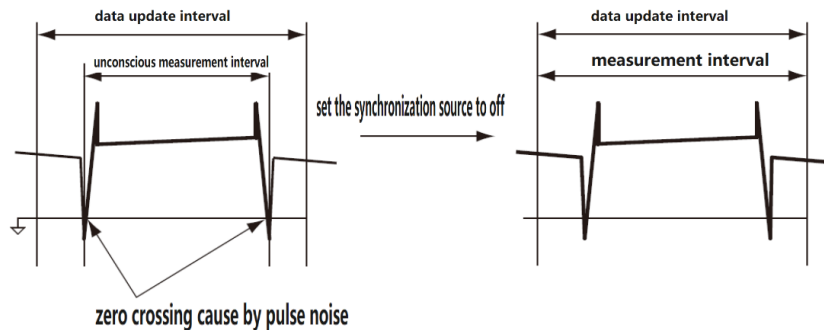

Synchronization Source Setup

1. Using the [▲] or [▼] key in the SETUP menu to select "Sync Source" (the option is fill with red shading which means it is selected).
2. Pressing the [◀] or [▶] key to select "U", "I" or "OFF", the corresponding icon "SYNC.U", "SYNC.I", "SYNC.OFF" will display on the top of the screen.
3. Using the [▲] or [▼] key to select other setting option or pressing the [ESC] key to go back to the measurement interface.

6.1.2 Line Filter

The line filter can remove the high frequency component in measurement circuit. The UTE310's line filters are designed to be used in the measurement circuits of voltage, current and power, and when the line filters

are enabled the measurements do not contain high frequency components. To suppress unwanted noise and harmonic components during measurements, the user can enable the line filter, especially when measuring small current signals of 1mA or less, to obtain more stable measurement results.

Enabling/disabling Line Filter

1. Using the [▲] or [▼] key in the SETUP menu to select "Line Filter" (the option is fill with red shading which means it is selected).
2. Pressing the [◀] or [▶] key to select OFF (disable the line filter) or ON (enable the line filter). The icon "L.F" will display on the top of the screen when the line filter is enabled.
3. Using the [▲] or [▼] key to select other setting option or pressing the [ESC] key to go back to the measurement interface.

6.1.3 Frequency Filter

The UTE310's frequency filter is designed for frequency detection circuit, the cut-off frequency is 500Hz. It is used to accurately detect zero crossing points of synchronized source signals when detecting measurement intervals. The frequency filter has an effect both on the frequency measurement and on the measurement interval for detecting voltage, current and power.

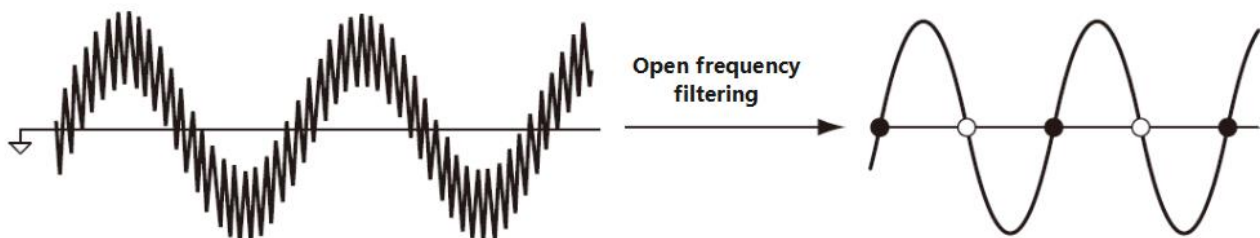

Note: The frequency filter is not inserted in the measurement circuit of voltage and current, and even if the frequency filter is enabled, the measured values contain high frequency components.

Enabling/disabling Frequency Filter

1. Using the [▲] or [▼] key in the SETUP menu to select "Frequency Filter" (the option is fill with red shading which means it is selected).
2. Pressing the [◀] or [▶] key to select OFF (disable the frequency filter) or ON (enable the frequency filter). The icon "F.F" will display on the top of the screen when the line filter is enabled.
3. Using the [▲] or [▼] key to select other setting option or pressing the [ESC] key to go back to the measurement interface.

6.1.4 Crest Factor

The crest factor is defined as the ratio of the peak value of the waveform to the RMS value. It is also referred to as the peak-to-rms ratio.

$$\text{Crest factor} = \frac{\text{Peak value}}{\text{RMS value}}$$

The crest can be set to 3, 6, or 6A. When different crest factors are selected, the conditions for measuring range and automatic range switching are different, and the default setting of the device's crest factor is 3.

Within the same rated range, the input range is greater when the crest factor is set to 6A than when the crest factor is set to 6 (see Section 5.1.3), and measuring distorted waveforms under auto ranging and setting the crest factor to 6A prevents frequent range switching.

Crest Factor Setup

1. Using the [▲] or [▼] key in the SETUP menu to select "Crest Factor" (the option is fill with red shading which means it is selected).
2. Pressing the [◀] or [▶] key to select 3, 6 or 6A.
3. Using the [▲] or [▼] key to select other setting option or pressing the [ESC] key to go back to the measurement interface.

6.1.5 Data Update Interval

The data update is the period at which sampling data for determining measurement functions is acquired. The data is updated, stored, and converted to analog signal output or output through the communication interface in each update interval. The data update interval can be set to 0.1s, 0.25s, 0.5s, 1s, 2s, 5s, 10s, 20s or Auto. The default settings is 0.25s. The user can select different update interval for measuring the signal in different interval, thus improving the efficiency of measurement and the accuracy of measured results. A faster data update interval can be used to measure the load with fast-changing. A slower data update interval can be used to measure the signal with a longer interval. The measuring frequency range under different data update interval are different, as shown in the following table.

Data Update Interval	Measuring Frequency Range
0.1s	DC, 20Hz~300kHz
0.25s	DC, 10Hz~300kHz
0.5s	DC, 5Hz~300kHz
1s	DC, 2Hz~300kHz

2s	DC,1Hz~300kHz
5s	DC,0.5Hz~300kHz
10s	DC,0.2Hz~300kHz
20s	DC,0.1Hz~300kHz
Auto	DC,0.1Hz~300kHz

A slower data update interval can capture the low frequency signal. A faster data update interval can capture the fast-changing signal, such as a rapidly changing load in a power system. If the period of the input signal varies greatly, set the data update period to Auto.

- **Data Update Interval Setup**

1. Using the [▲] or [▼] key in the SETUP menu to select "Data UpRate" (the option is fill with red shading which means it is selected).
2. Pressing the [◀] or [▶] key to select 0.1s, 0.25s, 0.5s, 1s, 2s, 5s, 10s, 20s, Auto.
3. Using the [▲] or [▼] key to select other setting option or pressing the [ESC] key to go back to the measurement interface.

- **Functional Limitations**

The following limitations apply when the data update interval is set to Auto.

1. The integration function cannot be used. If you try to start it, an error will pop out "The integration cannot be enabled in Data UpRate AUTO mode".

6.1.6 Auto Timer (Timeout)

The timeout is a time limit for detecting the waveform of the input signal. When the data update period is set to Auto, if the frequency of the input signal is low and the period of the synchronized source cannot be detected within the timeout period, the frequency data will be out of the measurement range and result in an error. The measurement function of common measurement uses the entire period up to the timeout period as the measurement interval to acquire the measurement value. The timeout determines the lower limit of the measured signal frequency, and the lower frequency limit for different timeouts is shown in the table below.

Auto Timer	Lower Limit of Frequency
1s	2.0Hz
5s	0.5Hz
10s	0.2Hz
20s	0.1Hz

Timeout Setup

1. Using the [▲] or [▼] key in the SETUP menu to select "Auto Timer" (the option is fill with red shading which means it is selected).
2. Pressing the [◀] or [▶] key to select 1s, 2s, 5s, 10s, 20s.
3. Using the [▲] or [▼] key to select other setting option or pressing the [ESC] key to go back to the measurement interface.

6.1.7 Auto Rate Sync (Automatic data synchronization)

Auto Rate Sync is a dedicated sync source when the data update interval is Auto, and this setting is only valid when the data update interval is set to Auto.

Auto Rate Sync Setup

1. Using the [▲] or [▼] key in the SETUP menu to select "Auto Rate Sync" (the option is fill with red shading which means it is selected).
2. Pressing the [◀] or [▶] key to select U or I.
3. Using the [▲] or [▼] key to select other setting option or pressing the [ESC] key to go back to the measurement interface.

6.1.8 Reset Init (Initialization)

After the instrument is initialized, the setting parameter will restore to the factory settings. The factory setting is shown in the table below.

Parameter	Factory Setting
Measuring Range	Auto
Measurement Mode	RMS
Sync Source	U
Line Filter	OFF
Frequency Filter	OFF
Crest Factor	3
Data UpRate	0.25S
Auto Timer	1S
Auto Rate Sync	U
Average state	OFF

EXT	OFF
SCALE	OFF
JUMP	OFF

Initialization Setup

1. Using the [**▲**] or [**▼**] key in the SETUP menu to select "Reset Init" (the option is fill with red shading which means it is selected).
2. Pressing the [**Enter**] key to perform the initialization.
3. Using the [**▲**] or [**▼**] key to select other setting option or pressing the [**ESC**] key to go back to the measurement interface.

Explanation

The communication setting (such as communication protocol, baud rate) will not be initialized.

6.2 Average Filter (AVG)

The averaging function includes exponential averaging and moving averaging. The different averaging method has different averaging depths. When there is a sudden change in the power supply, load, or low frequency input signal, the sampled data may fluctuate greatly, resulting in severe word skipping in the displayed data. The averaging function is useful to deal with this situation. Enabling the average filter function to averaging the sampled data, the measurement parameters that can be directly averaging are U, I, P, S and Q. The rest of the measurement parameters PF, U_{cf} and I_{cf} can be calculated by using the average values of U_{rms} , I_{rms} , P, S and Q.

Pressing the [**Setup**] key in any interface to enter the Setup menu, and use the function key AVG below the screen to enter the AVG menu, and the use the [**▲**], [**▼**], [**◀**] or [**▶**] key to select or switch to the parameter setting, as shown in the following figure.

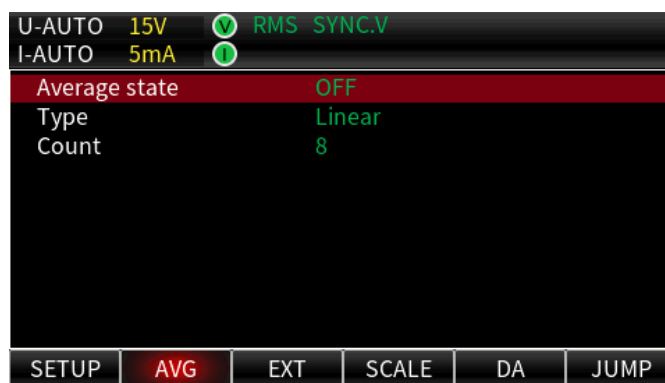

6.2.1 Average State (Turn on/off)

Setting Steps

1. Using the [▲] or [▼] key in the AVG menu to select "Average state" (the option is fill with red shading which means it is selected).
2. Pressing the [◀] or [▶] key to select OFF or ON, the icon AVG-8 (the average factor selects 8) will be displayed when it selects ON.
3. Using the [▲] or [▼] key to select other setting option or pressing the [ESC] key to go back to the measurement interface.

6.2.2 Average Type

Setting Steps

1. Using the [▲] or [▼] key in the AVG menu to select "Type" (the option is fill with red shading which means it is selected).
2. Pressing the [◀] or [▶] key to select Linear or EP.

- **Linear** (Moving Average)

$$D_n = \frac{M_{n-(m-1)} + M_{n-(m-2)} + M_{n-2} + M_{n-1} + M_n}{m}$$

D_n : Displayed value that has been averaged n^{th} times

M : Average factor (average count)

$M_{n-(m-1)}$: Numeric data at the $n-(m-1)^{\text{th}}$ time

$M_{n-(m-2)}$: Numeric data at the $n-(m-2)^{\text{th}}$ time

M_{n-2} : Numeric data at the $n-2^{\text{th}}$ time

M_{n-1} : Numeric data at the $n-1^{\text{th}}$ time

M_n : Numeric data at the n^{th} times

- **EP** (Exponential Averaging)

$$D_n = D_{n-1} + \frac{M_n + D_{n-1}}{K}$$

D_n : Displayed value that has been averaged n^{th} times

D_{n-1} : Displayed value that has been exponentially averaged $n-1$ times.

M_n : Numeric data at the n^{th} times

K : Average factor (attenuation constant)

- Using the [▲] or [▼] key to select other setting option or pressing the [ESC] key to go back to the measurement interface.

6.2.3 Count (Average factor)

Setting Steps

- Using the [▲] or [▼] key in the AVG menu to select "Count" (the option is fill with red shading which means it is selected).
- Pressing the [◀] or [▶] key to select 8, 16, 32 or 64.
- Using the [▲] or [▼] key to select other setting option or pressing the [ESC] key to go back to the measurement interface.

6.3 External Current Sensor (EXT)

This section is to introduce the external current sensor settings and application example. When the current of the signal to be measured is greater than the maximum current supported by the instrument, the external current sensor can be enabled for measurement. The external sensor converts the large current into a small voltage, and the instrument inputs and detects the small voltage through the sensor and then converts it, so as to display the actual size of the measured current.

Pressing the [Setup] key in any interface to enter the Setup menu, and press the function key EXT below the screen to enter the EXT menu, and then use the [▲], [▼], [◀] or [▶] key to select or switch to the parameter setting, as shown in the following figure.

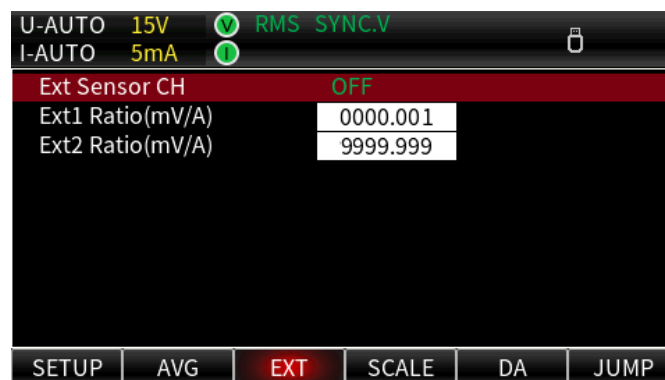

6.3.1 Ext Sensor CH

Setting Steps

- Using the [▲] or [▼] key in the EXT menu to select "Ext Sensor CH" (the option is fill with red shading which means it is selected).

2. Pressing the [◀] or [▶] key to select Ext1, Ext2 or OFF. When the Ext1 is selected, the screen displays the icon EXT1; when the Ext2 is selected, the screen displays the icon EXT2; when OFF is selected, it indicates that the current sensor input is disabled, and the signal collected from the current input terminal is used as the current input signal.
3. Using the [▲] or [▼] key to select other setting option or pressing the [ESC] key to go back to the measurement interface.

6.3.2 Ext1 Ratio (mV/A)

Setting Steps

1. Using the [▲] or [▼] key in the EXT menu to select "Ext1 Ratio (mV/A)" (the option is fill with red shading which means it is selected).
2. Pressing the [◀] or [▶] key to select the data bit to be edited.
3. Rotating the encoder knob to increase or decrease the numerical value, the range is 0000.001~9999.999.
4. Using the [▲] or [▼] key to select other setting option or pressing the [ESC] key to go back to the measurement interface.
- 5.

6.3.3 Ext2 Ratio (mV/A)

Setting Steps

1. Using the [▲] or [▼] key in the EXT menu to select "Ext2 Ratio (mV/A)" (the option is fill with red shading which means it is selected).
2. Pressing the [◀] or [▶] key to select the data bit to be edited.
3. Rotating the encoder knob to increase or decrease the numerical value, the range is 0000.001~9999.999.
4. Using the [▲] or [▼] key to select other setting option or pressing the [ESC] key to go back to the measurement interface.

·Explanations

The coefficients of the sensors mentioned in this subsection is corresponding to the variable ratio of the external sensor.

Application Example 1

Using the AC current clamp CTS5 of ZLG brand to measure the current signal of 30A, CTS5 ratio is 10mV/A (that is, 1A current signal can be converted to 10mV voltage signal). Using CTS5 to measure the 30A current will be output 300mV voltage, so the sensor channel (Ext Sensor CH) should select Ext2. The current range select to Auto or 500mV is more appropriate, the sensor coefficient Ext2 Ratio (mV / A) is set to "0010.000", that is, 10mV/A, connecting the BNC interface of the current clamp to the instrument's

EXT input interface, the screen will display the actual value of the measured current 30A when measuring.

Application Example 2

Using the AC current clamp CTS6000 of ZLG brand to measure the current signal of 4500A, CTS6000 ratio is 0.5mV/A. Using CTS6000 to measure the 4500A current will be output 2.25V voltage, so the sensor channel (Ext Sensor CH) should select Ext1. The current range select to Auto or 2.25V is more appropriate, the sensor coefficient Ext2 Ratio (mV / A) is set to "0000.500", that is, 0.5mV/A, connecting the BNC interface of the current clamp to the instrument's EXT input interface, the screen will display the actual value of the measured current 4.5000kA when measuring.

6.4 SCALE (VT and CT Ratio)

When the amplitude of the voltage or current to be measured exceeds the maximum permissible input value of the instrument, and the sensor channel is not satisfied with the measurement, the voltage and current to be measured can be scaled by the voltage sensor (VT) and the current sensor (CT) in accordance with the scaling ratio of the sensor, and the secondary output side of the voltage sensor (VT) or the current sensor (CT) is connected to the input terminal of the instrument, and then it can be directly display the actual measured voltage or current by setting the conversion ratio. The instrument can set the proportional constant of VT, CT or PT.

Pressing the [**Setup**] key in any interface to enter the Setup menu, and press the function key SCALE below the screen to enter the SCALE menu, and then use the [**▲**], [**▼**], [**◀**] or [**▶**] key to select or switch to the parameter setting, as shown in the following figure.

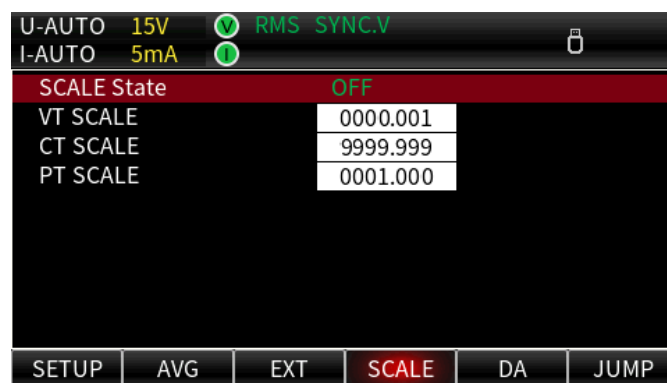

6.4.1 SCALE State (Turn on/off scaling transformation)

Setting Steps

- Using the [**▲**] or [**▼**] key in the SCALE menu to select "SCALE State" (the option is fill with red shading which means it is selected).

2. Pressing the [◀] or [▶] key to select OFF or ON. The screen displays the SCALE when it sets ON.
3. Using the [▲] or [▼] key to select other setting option or pressing the [ESC] key to go back to the measurement interface.

6.4.2 VT/CT/PT (Scaling coefficient)

Setting Steps

1. Using the [▲] or [▼] key in the SCALE menu to select "VT SCALE", "CT SCALE" or "PT SCALE" (the option is fill with red shading which means it is selected).
2. Pressing the [◀] or [▶] key to select the data bit to be edited.
3. Rotating the encoder knob to increase or decrease the numerical value, the range is 0000.001~9999.999.
4. Using the [▲] or [▼] key to select other setting option or pressing the [ESC] key to go back to the measurement interface.

Explanation

1. VT: Voltage Transformer
2. CT: Current Transformer

Application Example 1

Using the ZCS400 AC/DC current transformer of ZLG brand to measure the current of 380A. The ratio of ZCS400 is 1:2000, and use the voltage transformer with ratio of 1:2 to measure the voltage of 600V. The instrument's scaling coefficient should be set, CT sets to 2000.000, VT sets to 0002.000 and PT set to 0001.000. During the measurement, the secondary side of the ZCS400 will be output the scaled current. Connecting the secondary side of the ZCS400 to the instrument's current input terminals, and the secondary side of the VT connect to the voltage input terminals, at this time, the instrument displays the current of 380A, the voltage of 600V and the power of 228kW, while the actual current size of the input terminal is $380 \times 1/2000 = 0.19A$ and the voltage is 300V.

Application Example 2

When the user has used both voltage and current transformer measurements, and needs to view both the actual value of the output of the secondary side of the voltage transformer and current transformer, as well as the actual power in the circuit being measured, the need can be met by setting the PT.

Using the ZCS400 AC and DC current transformer of ZLG brand to measure the current of 380A. The ratio of ZCS400 is 1:2000, and use the ratio of 1:2 voltage transformer to measure the voltage of 600V. At this

time, set the scaling coefficient of CT to 0001.000, VT sets to 0001.000, and PT sets to 4000.000. During the measurement, the secondary side of the ZCS400 will be output the scaled current. Connecting the secondary side of the ZCS400 to the instrument's current input terminals, and the secondary side of the VT connect to the voltage input terminals, at this time, the instrument displays the current of 0.19A, the voltage of 300V and the power of 228kW. The displayed voltage and current are the actual values of the input terminal, and the displayed power is the actual power in the measured line.



Cautions

1. When only using the scaling ratio function, please disable the EXT CH. Otherwise, the current value displayed by the instrument is the signal collected from the EXT CH interface.
2. When using VT and CT at the same time, if user need to check the actual power and the actual output value of VT and CT, the coefficient of VT and CT should be set to 1, and set the coefficient of PT equal to the multiplied results of VT and CT.

6.5 JUMP (Range skipping)

UTE310 has multiple ranges for voltage and current. When selecting automatic range measurement, the instrument will switch ranges one by one until it switches to the appropriate range. If the input signal amplitude is large, or the input suddenly jumps from a large amplitude signal to a small amplitude signal, switching the ranges one by one will take more time to wait and during the waiting period, important measurement data may be lost.

The user can configure the range. When the auto-range measurement is activated, the instrument will skip the unused ranges, thus minimizing the loss of measurement data due to range-by-range switching. This function is disabled by default and will be effective only after it is enabled. The peak-over range jump can also be set, when the peak of the measured signal exceeds 300% of the rated range (600% when CF=6 or 6A), it will be prioritized to jump to the range set by the user, and after jumping, if the range is not the optimal range, it will be switched again until it is switched to the optimal range.

Pressing the **[Setup]** key in any interface to enter the Setup menu, and press the function key JUMP below the screen to enter the JUMP menu, and then use the **[▲]**, **[▼]**, **[◀]** or **[▶]** key to select or switch to the parameter setting, as shown in the following figure.

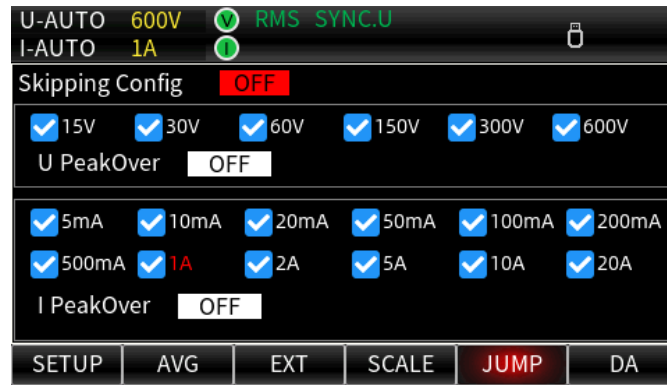

6.5.1 Skipping Configuration

The skipping range function is disabled by default and will be effective only after it is enabled.

Setting Steps

1. Using the [▲] or [▼] key to select "Skipping Config" (the option is fill with red shading which means it is selected).
2. Pressing the [◀] or [▶] key to select OFF or ON.
3. Using the [▲] or [▼] key to select the voltage or current scale (the selected will become red), and rotating the encoder knob to left or right to select the scale.
4. Press the [Enter] key to select or not select the scale, the check box displays "√" when the scale is selected.

Explanation

The user can set this function by sending communication commands through the communication interface or by using the UTE310's upper PC software. When range skipping is configured and auto-range is enabled, the range will only switch between the selected ranges.

6.5.2 U/I Peak Over (Peak-over jump)

The peak-over range jump is disabled (OFF) by default. When the peak of the measured signal exceeds 300% of the rated range (600% when CF=6 or 6A), the instrument will switch to the set range automatically when the automatic range is enabled.

Setting Steps

1. Using the [▲] or [▼] key and encoder knob in the JUMP menu to select "U PeakOver" or "I PeakOver" (the option is fill with red shading which means it is selected).
2. Pressing the [◀] or [▶] key to select OFF or U/I peak-over range.
3. Pressing the [ESC] key to exit the setting interface.

Explanation

Except setting by the instrument's panel, the user can also set this function by sending communication commands through the communication interface or by using the UTE310's upper PC software.

Application Example

The current voltage measurement is 15V of the auto range, and set the switch range of peak-over range to 60V. If a voltage signal with a peak value greater than 45V (90V when CF=6 or 6A) is input at this time, the instrument will prioritize jumping to the voltage range of 60V, and if it is still not the optimal range after jumping, the instrument will be switched again until it is switched to the optimal range.

6.6 D/A Output and Control

UTE310 D/A interface is located on the rear panel of the instrument and can be used to connect the D/A terminal outputs or to control the instrument via the D/A cable. UTE310 digital power meter can use four channels $\pm 5V_{rms}$ DC analog voltage to output the voltage, current, active power, apparent power, reactive power, power factor, phase angle, voltage frequency, current frequency, voltage peak, current peak, power integral value, current integral value.

Pressing the [Setup] key in any interface to enter the Setup menu, and press the function key DA below the screen to enter the DA menu, which includes the output channel, range mode and channel selection. The parameter can be set by SCPI or the upper computer software, as shown in the following figure.

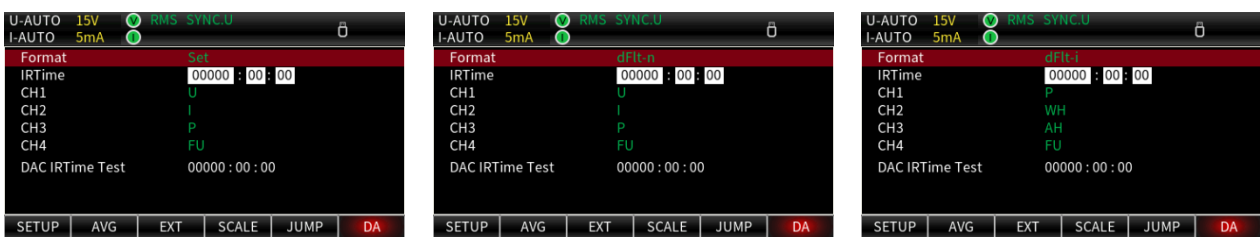

6.6.1 D/A Output Format

The user can quickly select the configured output parameter of each channel. The output format has two modes, dFlt-n and dFlt-i. In the output format, the output parameters are fixed in each channel. The user can also set the output parameters by manual, as shown in the following table.

Output Channel	Format	dFlt-n	dFlt-i	Set
----------------	--------	--------	--------	-----

CH1	U	P	Select the output parameter: U、I、P、S、 Q、LAMBda、PHI、FU、 FI、UPK、IPK、WH、 WHP、WHM、AH、AHP、 AHM、MATH
CH2	I	WH	
CH3	P	AH	
CH4	FU	FU	

6.6.2 D/A Output Range Mode

The user can select the D/A output range mode from the following options. The default setting is Fixmode.

This feature can be set by sending communication commands through the communication interface or the upper computer software.

- **Fixmode (Fixed range mode)**

When this mode is selected, if the full-scale input value of the rated range is input, then the D/A output will be +5 V.

For example, if the voltage measurement range is 15 V, then the voltage input will be 15 V, then the D/A output will be +5 V, and if the voltage input is 1.5 V, then the D/A output will be +0.5 V. Note that, when the measurement mode is DC, if the corresponding input voltage is -15 V to 0 V, then the DA output will be -5 V to 0 V.

The relationship between fixed-range input signal and D/A output is shown as follows 5V~0V, the relationship between fixed-range input signal and D/A output is shown below.

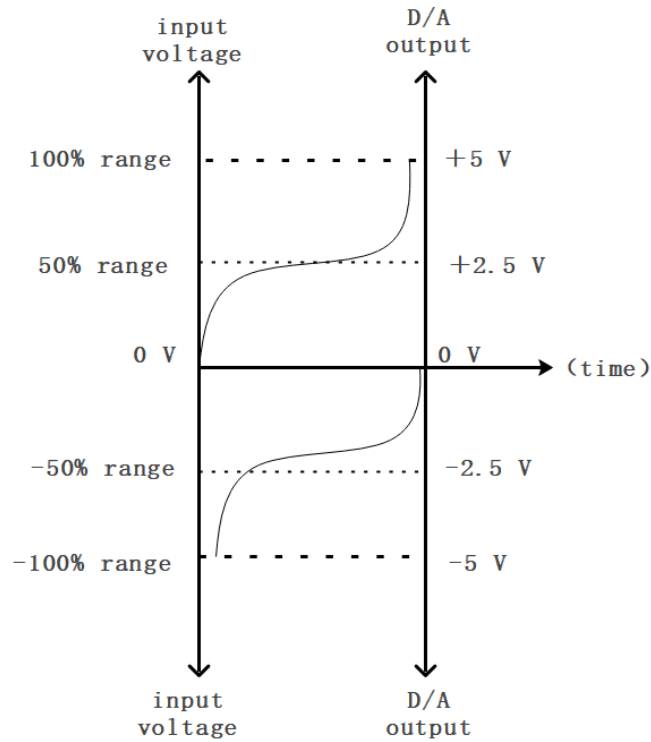

- **Manual (Manual range mode)**

When the manual range mode is selected, the measurement function display value of D/A output -5V to $+5\text{V}$ can be set arbitrarily. With this setting, the D/A output for each channel can be enlarged or reduced.

For example, when measuring a current (20A range) that fluctuates between 10A and 12A , if the range mode of the D/A output is set to fixmode, the D/A output voltage will fluctuate between 2.5V and 3V . Using the D/A scaling function to observe this fluctuation further. If the D/A output mode is set to Manual and the Lower value is set to 10 and the Upper value is set to 12, the instrument will output -5V when the measured current value is 10A and $+5\text{V}$ when the measured current value is 12A .

The output of the fluctuation comparison between Fixmode and Manual mode is shown below.

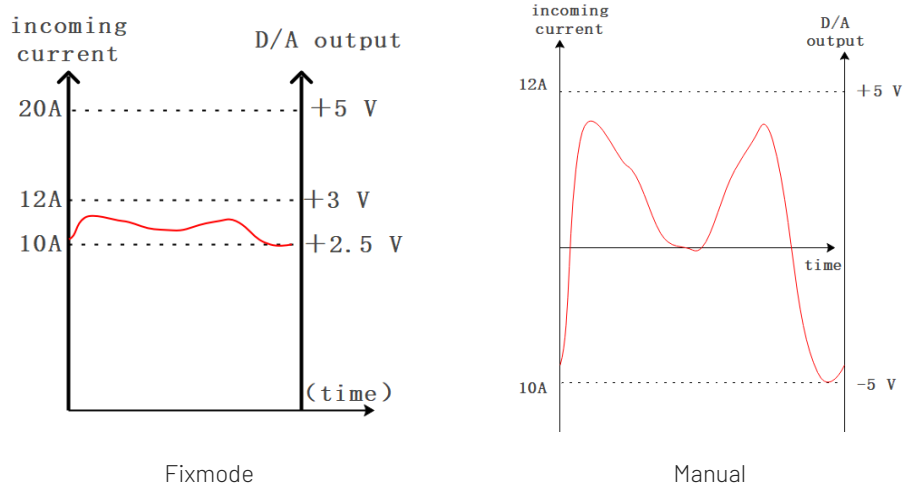

Explanation

Before selecting the manual range mode, the manual range channel should be set in "channel", after the channel is selected, the set range mode will be valid for the selected channel.

● **Comparator Mode**

By comparing with the comparator limit value, the D/A can output -5V, 0V or +5V, as shown below.

- The input value is below than the lower limit, the D/A outputs -5V
- The input value is between the lower and upper limits, the D/A outputs 0V
- The input value is higher than the upper limit, the D/A outputs +5V

Explanation

Before selecting the manual range mode, the manual range channel should be set in "channel", after the channel is selected, the set range mode will be valid for the selected channel.

Relationship between Output Items and D/A Output Voltage

Integrated Value

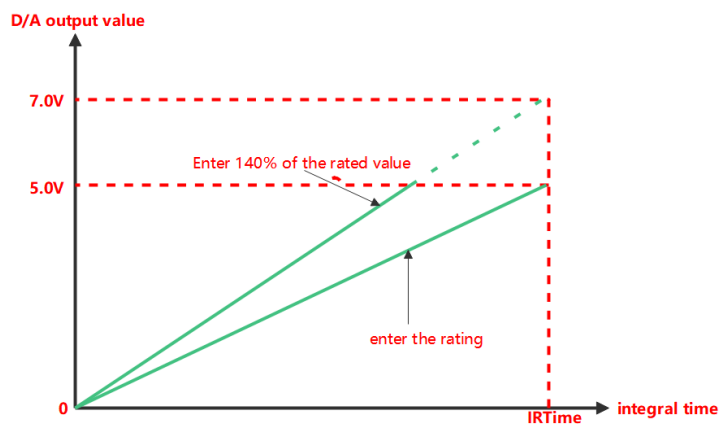

IRTime (the rated integration time)

Output Frequency

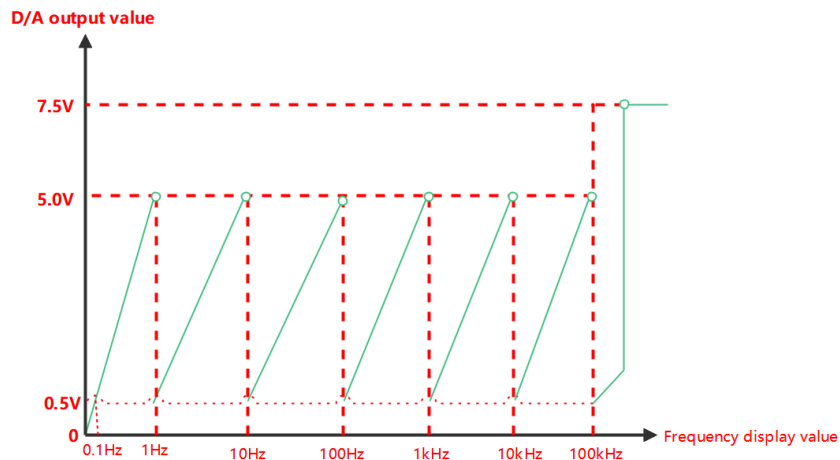

Other Output Parameters

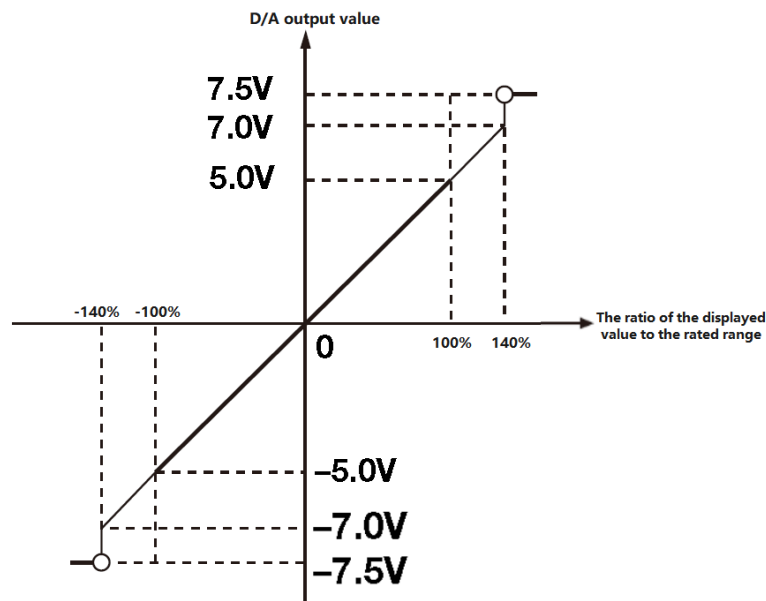

- When output PF (power factor) and LAMBda (phase angle), the maximum range of D/A output is $-5V \sim +5V$. When an error occurs, the output is approximately $\pm 7.5V$.
- For Upk and Ipk, D/A output $\pm 5V$ represents the 3 times of the input rated range value (6 times of the input rated range value when CF=6 or 6A).
- When the output parameter displays "----" or there is no numerical data. The D/A output is 0V.

6.6.2 D/A Output Interface Remote Control

Except output the measured data with $\pm 5V$ analog signal, the D/A output interface can also support EXT CH to control the integration and data hold.

- **EXTI HOLD** (Measured data hold)

As shown in below, the measured data can be held by input the signal **EXTI HOLD** remotely or pressing the [Hold] key.

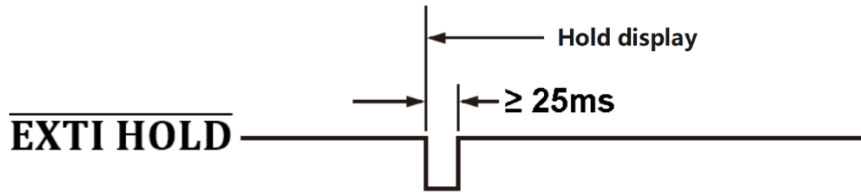

- **EXTI TRIG** (Update measured data)

As shown in below, the measured data can be updated by input the signal **EXTI TRIG** remotely or pressing the [Single] key.

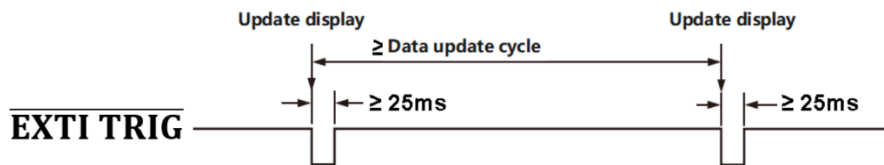

- Remote Control Integration

EXTI START (Starting integration)

EXTI STOP (Stopping integration)

EXTI RESET (Resetting integration)

INTEG BUSY (Integrating, the integration continues output its signal)

Sequence chart of integration remote control is shown the following figure.

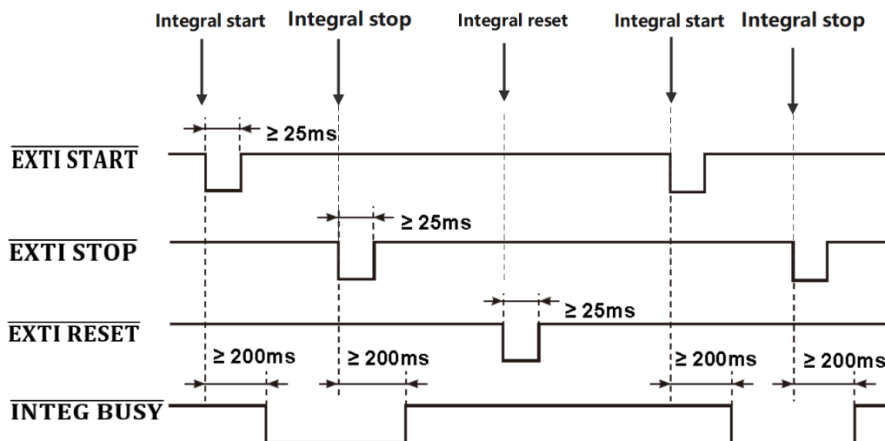

Explanation

When start integrating, the signal **INTEG BUSY** outputs low level, the signal **INTEG BUSY** outputs high level in other situations. The user can directly read its signal level to monitor integration.

6.6.3 Pin Definition of D/A Output

The D/A output interface of UTE310 is located on the rear panel, with total of 26 pins. The pins of the D/A interface is shown the following figure.

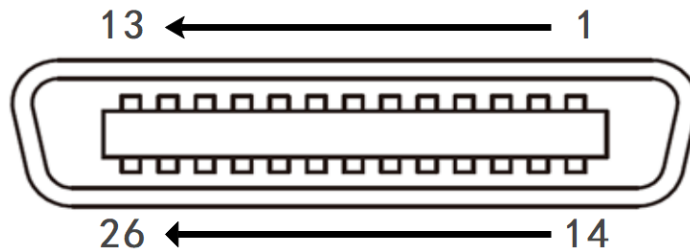

Electrical feature of Pin

No.	Feature	No.	Feature	No.	Feature
1	GND	10	CH 3(output)	19	NC
2	EXTI HOLD(input)	11	CH 1(output)	20	NC
3	EXTI START(input)	12	GND	21	NC
4	EXTI RESET(input)	13	GND	22	CH 4(output)
5	NC	14	EXTI TRIG(input)	23	CH 2(output)
6	NC	15	EXTI STOP(input)	24	GND
7	NC	16	INTEG BUSY(output)	25	NC
8	NC	17	NC	26	NC
9	NC	18	NC	/	/

Cautions

- Do not short circuit the pins of D/A output terminals and not apply an external voltage to them. Otherwise, the instrument may be damaged.
- When the D/A output terminal connecting to other device, do not connect the wrong signal pin. Otherwise, the instrument and connected equipment may be damaged.
- Do not apply other than 0-5V to the remote control pins. Otherwise, the instrument may be damaged.
- The instrument should be turned off before connecting the D/A output terminal.

Chapter 7 System Menu

7.1 INFO (System Information)

Pressing the **[System]** key in any interface to enter the system settings, which includes the system information, display brightness, key sound, communication protocol and RS-232. The system interface is shown in the following figure.

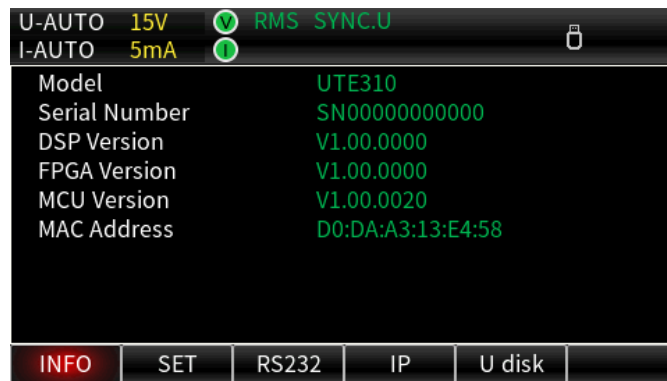

- Model: UTE310
- Serial Number
- DSP Version
- FPGA Version
- MCU Version
- MAC Address

7.2 SET (System Setting)

The system setting interface is shown in the following figure. The display brightness, key sound, communication protocol, turn on/off storage and storage interval can be set in this page.

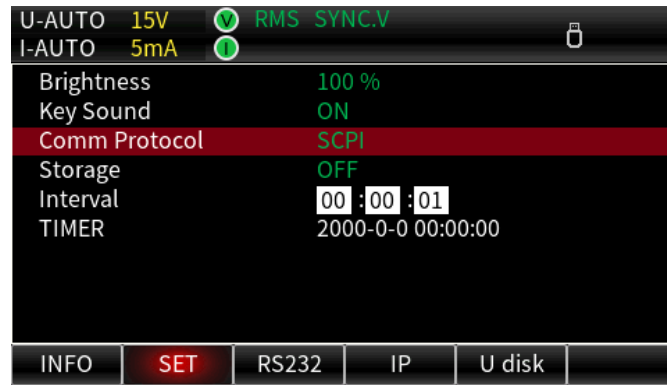

7.2.1 Brightness

The user can set different display brightness according to the light intensity of the measurement environment. In the SET setting interface, select the Brightness by [▲] or [▼] key (the red underline filling indicates that it is selected), and then clockwise rotating the encoder knob or pressing the [▶] key to increase the brightness, and counterclockwise rotating the encoder knob or pressing the [◀] key to decrease the brightness. The minimum of brightness is 10%, the maximum is 100%.

7.2.2 Key Sound

The user can mute the key sound according to the requirement of measurement environment. In the SET setting interface, select the Key Sound by [▲] or [▼] key (the red underline filling indicates that it is selected), pressing the function key [▲] or [▼] key to turn on/off the key sound.

7.2.3 Comm Protocol (Communication Protocol)

UTE310 digital power meter supports the communication protocol of SCPI and Modbus. In the SET setting interface, select the Comm Protocol by [▲] or [▼] key (the red underline filling indicates that it is selected), pressing the function key [▲] or [▼] key to select SCPI or Modbus.

- **Modbus**

Modbus communication only supports Modbus-TCP communication mode. When using Modbus-TCP to communicate with other devices, the maximum connection is 4. TCP communication uses port 502.

- **SCPI**

The user can use the RS-232 serial interface to control the instrument remotely via SCPI commands, see the UTE310 Digital Power Meter Programming Manual for detailed control commands.

7.2.4 Storage

UTE310 digital power meter supports storing all displayable measurement data to external storage device. In the SET interface, select Storage by [**▲**] or [**▼**] key (red underline filling means it is selected), then pressing the [**▶**] key to set it to "ON" to start storing data. The saved measurement data is saved in .csv format.

For example, UTE310 start to save the data on February 17, 2023, at 8:25:22, and the UTE310 automatically creates the folder UTE310_Data_20230217/H_08 and the file UTE310_2522.csv in the storage device. The user can use the software Excel to edit and analyze the data.

Explanation

The storage function can only be used when external storage is inserted.

7.2.5 Time Interval

Before enabling the storage function, the user can set the storage interval, the default is 00:00:01, that is, save the data by 1 per second. The storage interval can also be set during the storage process, and the device will store the measurement data in accordance with the latest time interval setting.

Settings Steps

1. In the SET interface, pressing the [**▲**] or [**▼**] key to select Interval (red underline filling means it is selected).
2. Using the function key [**▲**] or [**▼**], [**◀**], [**▶**] to select the data bit to edit (the selected data bits are filled with a black background).
3. Rotating the encoder knob to increase/decrease the numerical value.
4. Pressing the [**ESC**] key to exit after the setting is completed or pressing the [**▲**] or [**▼**] key to select other setting options. The definition of each data bit is shown in the following table.

00	:	00	:	01
Hour		Minute		Second

Notes

- For harmonic measurement items, the user can specify the corresponding number of harmonics for each measurement item, e.g. only the measurement data of the 1st, 3rd, 29th harmonics of voltage are stored. When the harmonic mode is turned off, the storage harmonic measurement term is specified at this time, the obtained results are meaningless.
- When storing measurement data, if the [**HOLD**] key has been pressed to enable the data

hold function, the measurement operation is temporarily held, and the held data is stored at this time.

- During the maximum value hold function is operated, the stored measurement data is the maximum value currently being held.

7.2.6 TIMER(System Time)

User can use this parameter to check the system time. The system time cannot manually set, it can only set by SCPI. The definition of each data bit is shown in the following table.

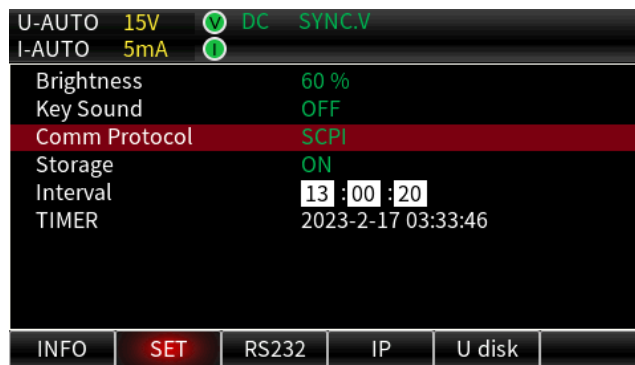

2023	-	2	-	17	03	:	33	:	46
Year		Month		Date	Hour		Minute		Second

7.3 RS232 Setting

In the RS232 interface, the user can set the baud rate, as shown in the following figure.

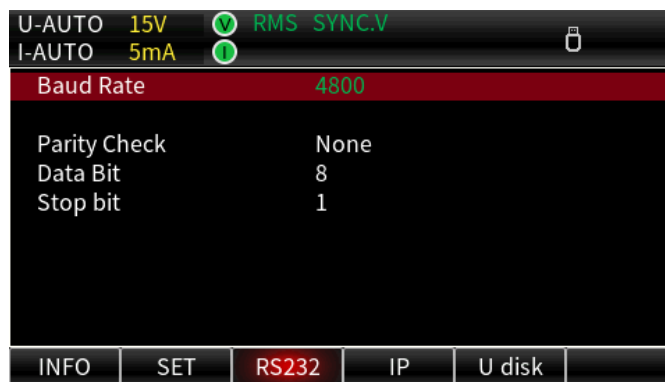

7.3.1 Baud Rate

The communication baud rate of UTE310 digital power meter can be selected from 1200、2400、

4800, 9600, 19200, 38400, 57600, 115200, and the default setting is 9600.

Only the baud rate setting is supported in RS232 interface. Pressing the [◀] or [▶] to select the baud rate, and the rest of the parameters are all fixed values.

- Parity Check: the default is None (fixed value)
- Data Bit: the default is 8-bit (fixed value)
- Stop bit: the default is 1-bit (fixed value)

7.4 IP Setting

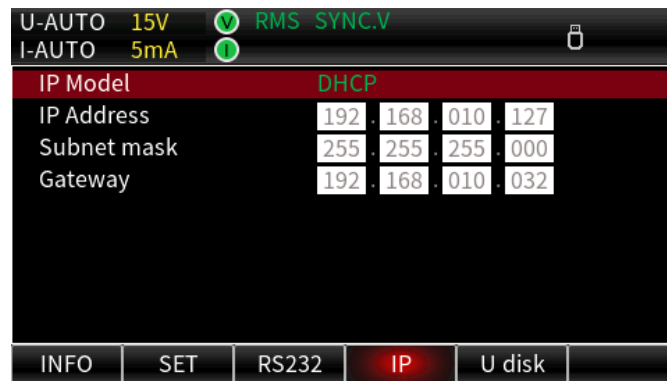

7.4.1 IP Model

UTE310 digital power meter supports both DHCP and MANU (Manual Mode) modes to obtain IP information. The default is DHCP.

DHCP is a protocol that temporarily assigns necessary information for devices to connect to the Internet. If the instrument need to connect to a network with a DHCP server, IP Model should select "DHCP", and when the instrument connects to the network, the IP address will be automatically assigned to the UTE310. After the DHCP mode is selected, the instrument will get the address information automatically without manual setting. If MANU is selected, the IP address, subnet mask address, gateway should set manually.

7.4.2 IP Address

The IP address is the location of the device in the network. When the IP mode of the instrument sets to MANU, the IP address need to be set manually.

7.4.3 Subnet Mask

A subnetmask is a technique used in conjunction with an IP address to mask a portion of an IP address to differentiate between a network identification and a host identification, and indicate whether the IP address is on a LAN or a WAN. When the IP Model of the instrument sets to MANU, the subnet mask should be set.

7.4.4 Gateway

The gateway is the channel address for a network to transfer information with other networks. When the IP Model of the instrument sets to MANU, the gateway address should be set.

7.5 USB (Load and Save)

The user can store the setup parameters to the instrument's internal memory and external USB memory through the memory function. The parameters that can be stored are the scale, measurement mode, synchronization source, ratio setting, average function setting, input filter, maximum hold, mathematical operation, data update interval, crest factor, integration setting, harmonic setting, memory setting, and communication setting.

Chapter 8 Communication

UTE310 digital power meter supports USB, Ethernet, GPIB (optional) and RS-232 communication interface. This chapter mainly introduces the relevant features of the communication interface and setup process.

8.1 RS-232 Interface

UTE310 digital power meter has an RS-232 communication interface, which allows the user to remotely send SCPI commands to the power meter via the RS-232 interface. The power meter receives the relevant SCPI commands and executes the functions corresponding to the power meter's front panel keys, which can return measurement and calculation data, setup parameters and status bytes of control panel and error codes.

UTE310 communication interface is DB9 male head, and the definition of pin as shown in the following figure.

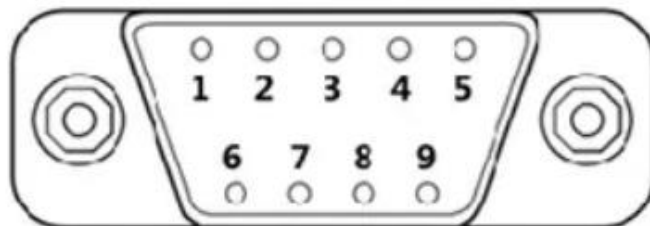

1	NC
2	RXD (RS-232 data input)
3	TXD (RS-232 data output)
4	NC
5	GND (RS-232 signal ground)
6	NC
7	NC
8	NC
9	NC

Notes

Before operating communication, UTE310 should match with the following parameters of the control host.

- (1) Baud rate: 1200、2400、4800、9600、19200、38400、57600、115200.
- (2) Check bit: NONE (fixed value)
- (3) Data bit: 8 (fixed value)
- (4) Stop bit: 1 (fixed value)

8.1.1 RS-232 Settings

1. **Communication protocol:** set the communication protocol of power meter to SCPI, the setting method see subsection 7.2.3.
2. **Baud rate:** the baud rate of UTE310 and the control host should be the same, the setting method see subsection 7.3.1.

8.1.2 PC Connect to UTE310 via RS-232

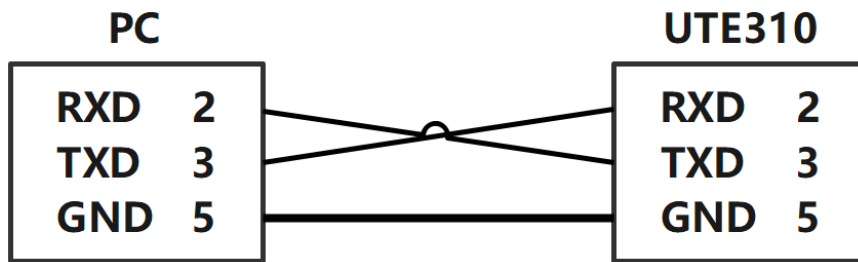

Explanation

- In order to ensure stable communication, it is forbidden to use other interfaces for communication when using RS-232 interface.
- The number 2, 3, 5 mentioned in the above schematic indicates the pin numbers of DB9 interface, other pins not listed are not used.
- The above schematic is using a cross-serial cable, please use a cross-serial cable to connect the PC to the UTE310.
- The above wiring method only supports a PC with RS-232 interface. If the PC has no RS-232 interface, please use USB convert RS-232 serial line to connect a PC to UTE310.
- This wiring method only supports SCPI.

8.2 LAN Interface

UTE310 is equipped with a LAN port, so the user can send commands to the power meter by LAN port. When the power meter receives the command, the power meter will execute the function which corresponding to the key on the front panel and return the measured and calculated data, the setting parameters and state bytes of control panel and the error codes.

Port number	1
Interface type	RJ-45
Electrical and mechanical specifications	IEEE802.3
Transmission system	LAN (100BASE-TX, 10BASE-T)
Transmission rate	Maximum 100Mbps
Communication protocol	TCP/IP

Support services	DHCP, Remote control
------------------	----------------------

8.2.1 LAN Settings

1. **Communication protocol:** set the communication protocol of power meter to Modbus, the setting method see subsection.
2. **Selecting IP mode:** DHCP (automatic acquire) or MANU (manually acquire).

Explanation

The user should correctly set the IP address, subnet mask and gateway for the power meter when the IP mode is MANU.

8.2.2 PC Connect to UTE310 via LAN

- PC Connect to a Single UTE310

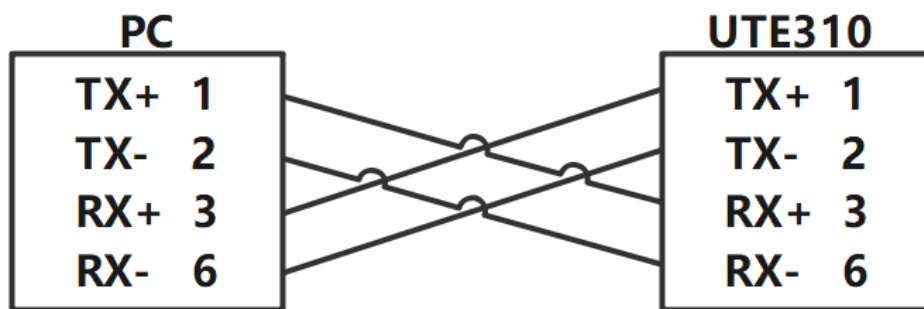

- PC Connect to Multi-UTE310

A PC connects to multiple UTE310 should through the concentrator or switch, as shown in the following figure.

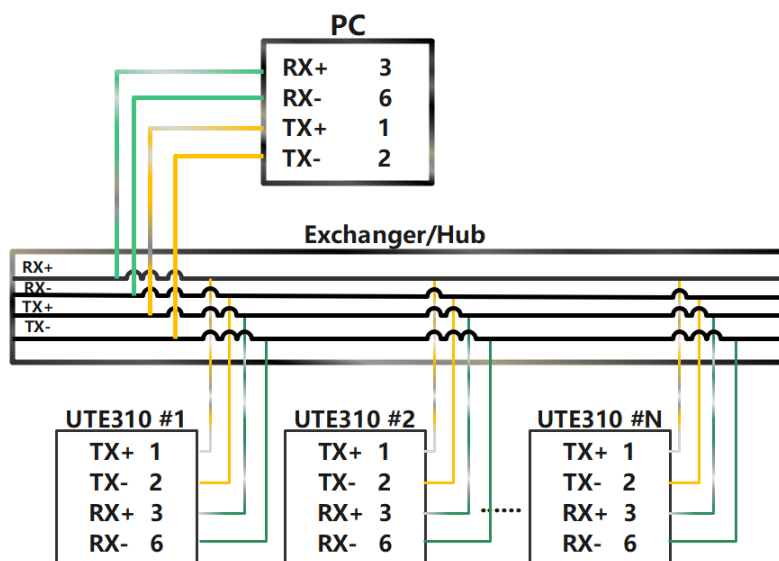

Explanation

- The above communication method only supports Modbus TCP/IP.
- In order to ensure stable communication, it is forbidden to use other interfaces for communication when using RJ-45 interface.
- The number mentioned in the above schematic indicates the pin numbers of RJ-45 interface, other pins not listed are not used.
- When a PC directly connect to a single UTE310, please use a cross-cable (one port is T586A and the other port is T586B).
- The above wiring represents the connection between the send end and the receive end of the data, and does not fully represent the actual physical connection.

8.3 USB Interface

When use USB interface to communication, it is not necessary to set USB parameters on the instrument.

Port number	1
Interface type	B type USB (plug)
Electrical and mechanical specifications	USB 2.0
Transmission system	HS(high speed;480Mbps)and FS(full speed;12Mbps)
Transmission rate	User-defined
PC requirement	32-bit or 64-bit Windows 7 and higher systems with USB ports

USB Connecting Figure

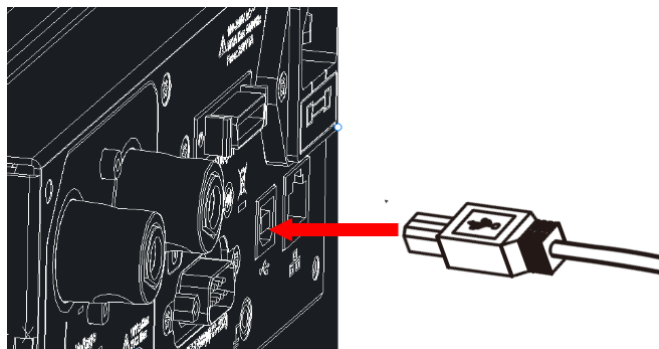

8.3.1 PC Connect to UTE310 via USB

- PC Connect to a Single UTE310

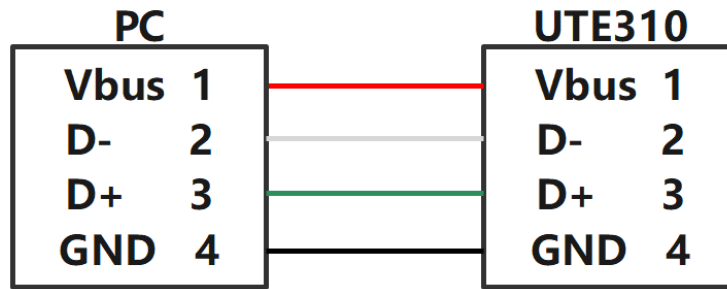

- PC Connect to Multi-UTE310

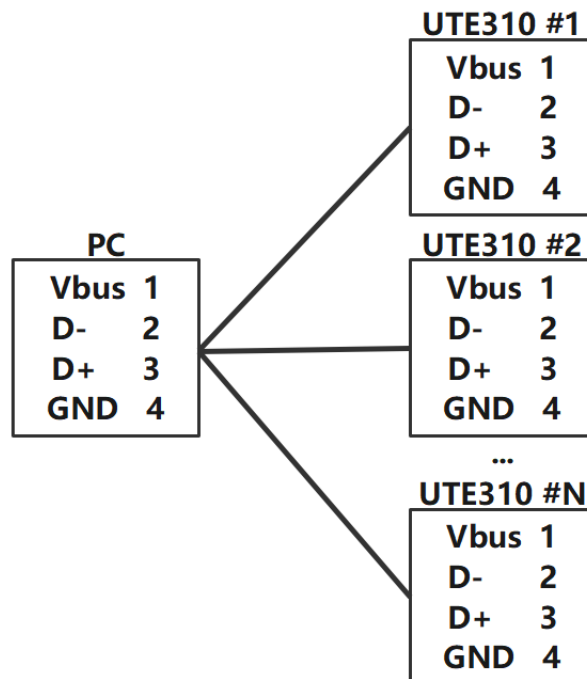

Cautions

- When use USB interface to communication, do not connect other interface to the PC.
- USB cable should reliably connect to the instrument and the PC.
- If the PC uses USB interface to connect multiple devices, the instrument should be connected to the USB interface closest to the PC side.

8.4 GPIB Interface (Optional)

UTE310's optional interface is GPIB. If the optional GPIB interface is selected, the RS-232 will not be equipped. When the optional GPIB interface is selected, the user can send the command to the power meter via GPIB, the power meter will execute the function which corresponding to the key on the front panel and return the

measured and calculated data, the setting parameters and state bytes of control panel and the error codes.

Applicable Equipment	American National Instrument PCI-GPIB or PCI-GPIB+, PCIe-GPIB or PCIe-GPIB+ PCMCIA-GPIB or PCMCIA-GPIB+ (Windows Vista or not support Windows 7) GPIB-USB-HS uses NI-488.2M Ver. 2.8.1 or update drive
Electrical and Mechanical Specifications	IEEE-488

Explanation

To ensure reliable and stable GPIB communication, please use genuine GPIB cables. Each GPIB device has a unique GPIB address, which is used to distinguish different GPIB devices. Therefore, when using the GPIB interface of the power meter, the user needs to set the GPIB address of the power meter first.

8.4.4 PC Connect to UTE310 via GPIB

When using the GPIB interface for communication, please use genuine GPIB cable and do not use the longer wire. The connection is shown in the following figure.

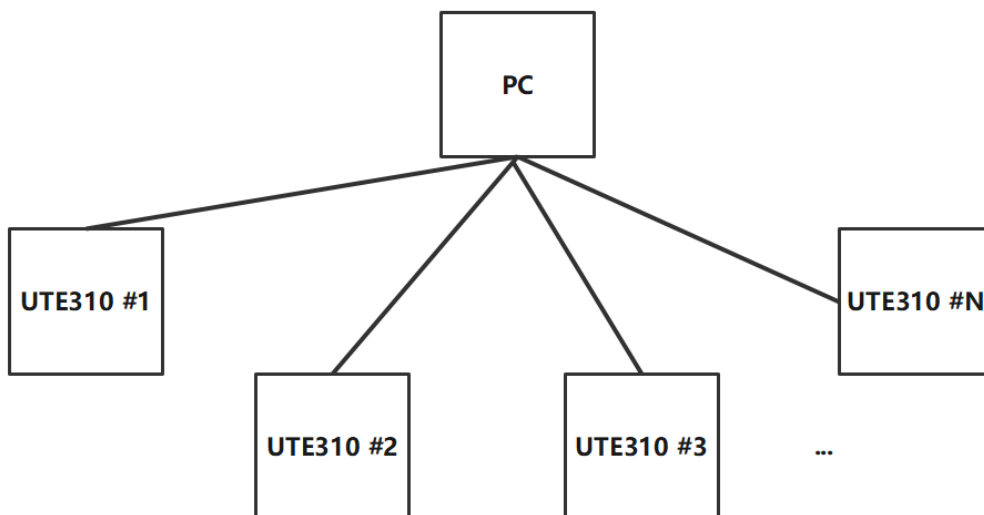

or

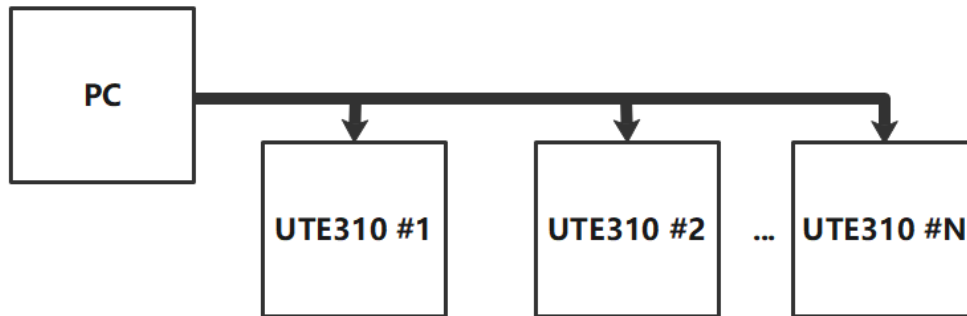

In normal condition, PC has no GPIB interface, the user can connect through the GPIB to USB converter card, as shown in the following figure.

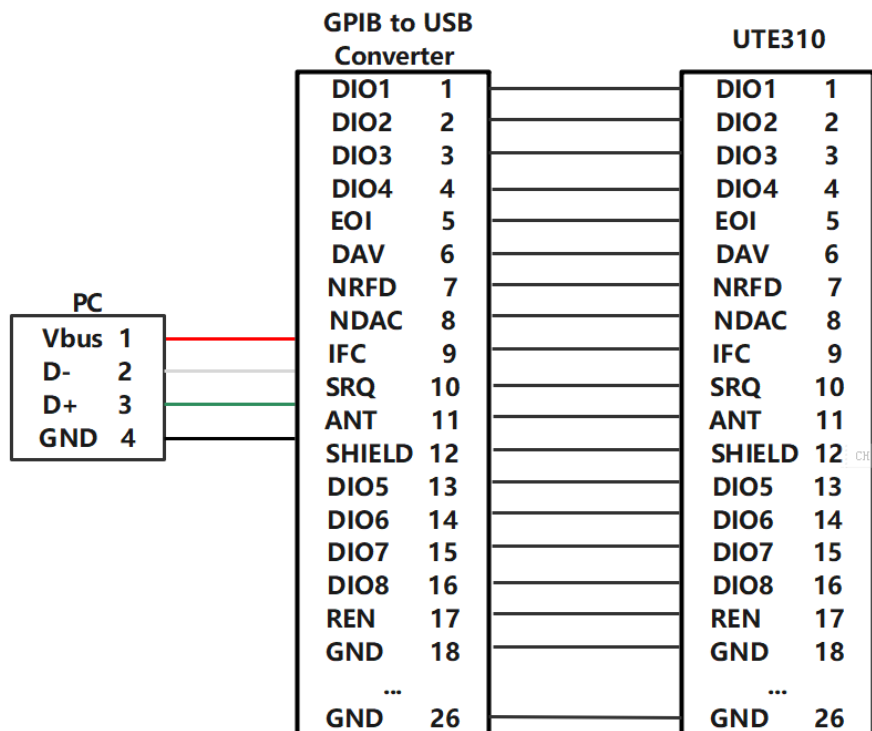

Explanation

- To ensure stable communication, when using the GPIB interface to communicate, other interface is forbidden.
- The number in the above block diagram indicates the pin numbers of the computer's USB or the pin numbers of the GPIB.
- When using the GPIB interface for communication, please use genuine GPIB cable.

Chapter 9 Storage and Calibration

9.1 Notices for Storage

- The instrument should be stored in the environment which specified in the user manual, refer to the subsection 1.2 in chapter 1 Environmental Condition. Do not store the instrument in a place with high temperature, high humidity, temperature rapid change or easy condensation. The recommended storage environment is dry and at a temperature of about 20°C.
- Keep product's packaging materials (cardboard boxes, padding, plastic bags, etc.) for later delivery of instruments. Using packaging materials to transport instruments can protect them from sudden temperature changes, shocks and vibrations, and protect them from damage during transportation.
- Do not store the instrument in an environment with dust, fumes or chemical gases.
- Avoid direct sunlight.

9.2 Trouble-shooting

No.	Problem	Solution
1	The instrument has no display when pressing the power switch	<ol style="list-style-type: none"> 1. Make sure the power cable is well connected. 2. Make sure the power supply is within the allowable power range. 3. Make sure the fuse is not broken.
2	Measured data displays error	<ol style="list-style-type: none"> 1. Make sure the operating temperature and humidity within the allowable range. 2. Make sure the display is away from noise interference. 3. Check whether the test wire is well connected. 4. Check whether the wiring method is correctly connected. 5. Check whether the data display is under the hold state. 6. Reboot the instrument to check whether the measurement is normal.
3	Key function failure	<ol style="list-style-type: none"> 1. Check whether the key is stuck.
4	Communication failure	<ol style="list-style-type: none"> 1. Check whether the communication cable is well connected and use the cross/direct lines as required. 2. Check whether the instrument's address, communication mode and baud rate corresponds to the upper computer.

* Others situation refers to Note in each chapter.

9.3 Notices for Calibration

Verification and Calibration

The precision of standard power meter should over a grade than measured meter. The calibration source of the standard power meter should be stable. All the instrument power on 30 minute and wait it to stabilize, and then slowly adjust the output voltage or current of the standard AC power source. Using the power

meter to read out the required value, and record the data of the standard meter and UTE310 after the data is stable, and then calculating the measuring error value to judge whether is within the error range. The requirements of environment temperature of verification and calibration is shown the following table.

Item	Reference Value or Range	Reference Value or Range
Environment temperature °C	23	±5
Environment humidity % RH	45~75	
Barometric pressure KPa	86~106	
AC power supply voltage (V)	100~240	±2%
AC power supply frequency (Hz)	50/60	±1%
Ac power supply waveform	Sine waveform	$\beta=0.05$
External electromagnetic field interference	Avoid	
Ventilation	Well-condition	
Sunlight	Avoid direct sunlight	

Notes: The inspect equipment should meet the specifications of the regular metrological verification, and the measurement period is one year.

Wiring scheme of verification and calibration as shown in the following figure.

Calibration of Voltage and Current

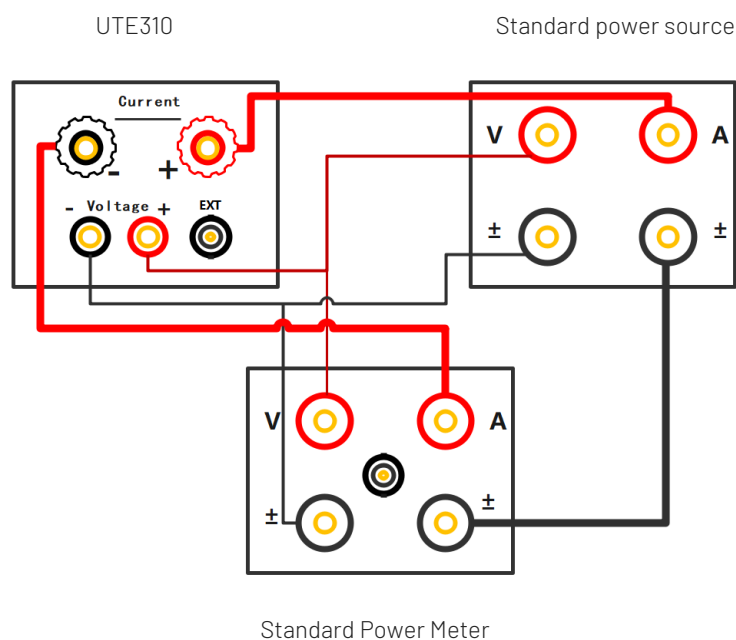

Calibration of Sensor CH

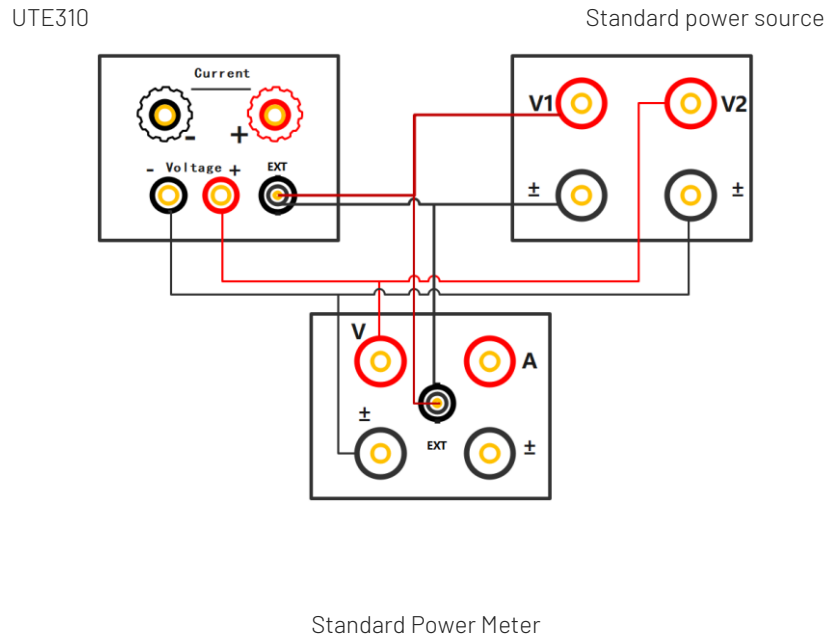

Chapter 10 Replace Fuse

This instrument has 1 spare fuse stored in the fuse box. If the fuse was burned out, replace the fuse as the follow steps.

- 1) Pull out the power cable, use small screwdriver to take out the fuse box, as shown in the following figure.



If the fuse was burned out, please replace the same specification fuse with the instrument.

The specification fuse with the instrument, see the following table.

Model	Specification of Fuse
UTE310	AC 250V F5A

- 3) After the replacement, please put the fuse box back , as shown in the following figure.

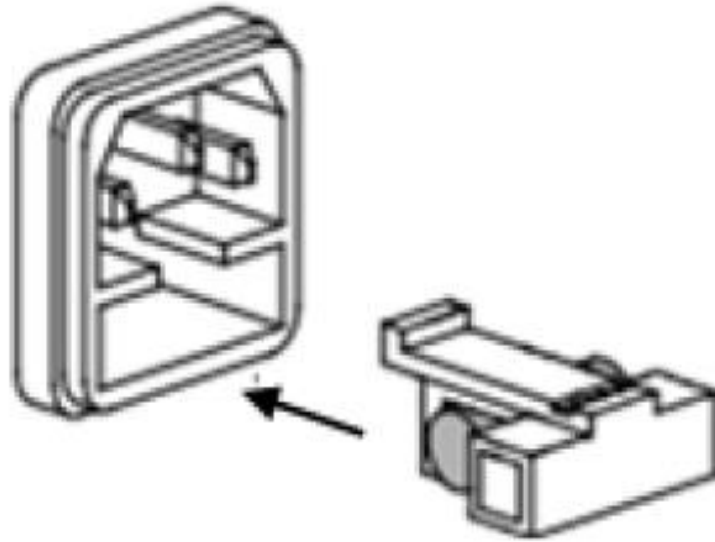

Appendix 1 Symbol and Formula of Measurement

Measurement Function (Unit)	Operation Formula	Explanation
Voltage TRMS (Urms /V)	$U_{rms} = \sqrt{\frac{1}{N} \cdot \sum_{n=1}^N u(n)^2}$	<p>u(n) represents the instantaneous value of voltage.</p> <p>i(n) represents the instantaneous value of current.</p> <p>N represents ADC sampling time within the measurement range.</p> <p>θ represents the phase difference between the voltage and current.</p>
Voltage Calibrated Average Value (Umn /V)	$U_{mn} = \frac{\pi}{2\sqrt{2}} \times \frac{1}{N} \cdot \sum_{n=1}^N u(n) $	
Voltage DC Component (Udc /V)	$U_{dc} = \frac{1}{N} \cdot \sum_{n=1}^N u(n)$	
Voltage AC Component (Uac /V)	$U_{ac} = \sqrt{U_{rms}^2 - U_{dc}^2}$	
Current TRMS (Irms /A)	$I_{rms} = \sqrt{\frac{1}{N} \cdot \sum_{n=1}^N i(n)^2}$	
Current Calibrated Average Value (Imn /A)	$I_{mn} = \frac{\pi}{2\sqrt{2}} \times \frac{1}{N} \cdot \sum_{n=1}^N i(n) $	
Current DC Component (Idc /A)	$I_{dc} = \frac{1}{N} \cdot \sum_{n=1}^N i(n)$	
Current AC Component (Iac /A)	$I_{ac} = \sqrt{I_{rms}^2 - I_{dc}^2}$	
Active Power (P /W)	$P = \frac{1}{N} \cdot \sum_{n=1}^N [u(n) * i(n)]$	

Apparent Power (S /VA)	$S=U_{rms} \cdot I_{rms}$	
Reactive Power (Q /var)	$Q=-\sqrt{S^2 - P^2}$, 或 $Q=\sqrt{S^2 - P^2}$	
Power Factor (PF)	$PF = \frac{P}{U_{rms} \cdot I_{rms}}$	
Frequency (fU, fI /Hz)	Measuring the voltage frequency (fU) and current frequency (fI) by zero crossing.	
Peak Factor (Ucf, Icf)	$U_{cf} = \frac{U_{PK}}{U_{rms}}, I_{cf} = \frac{I_{PK}}{I_{rms}}$	UPK= Upk+ or Upk- , take the larger value between the both. IPK= Ipk+ or Ipk- , take the larger value between the both.

Appendix 2 Measurement Accuracy and Measurement Error

The measurement instruments have certain requirements for measurement accuracy or measurement error. The measurement accuracy of UTE310 digital power meter has different requirements for different frequency measurement signals.

For example, the voltage and current accuracy in the range of 45 Hz to 66Hz is $\pm(0.1\%$ of reading + 0.05% of range).

- **Measurement error of voltage and current**

Example 1 Using 1A range to measure the current of 60Hz 1A

Reading error: $1 \times 0.1\% = 0.001A$

Range error: $1 \times 0.05\% = 0.0005A$

The displayed error of measuring 1A current is the sum of reading error and range error, which is $\pm 0.0015A$, so the displayed value between 0.9985A ~1.0015A are within the error allowable range.

Example 2 Using 5A range to measure the current of 60Hz 1A

Reading error: $1 \times 0.1\% = 0.001A$

Range error: $5 \times 0.05\% = 0.0025A$

The displayed error of measuring 1A current is the sum of reading error and range error, which is $\pm 0.0035A$, so the displayed value between 0.9965A~1.0035A are within the error allowable range.

Example 3 Using 1A range to measure the current of 60Hz 0.5A

Reading error: $0.5 \times 0.1\% = 0.001A$

Range error: $5 \times 0.05\% = 0.0025A$

The displayed error of measuring 1A current is the sum of reading error and range error, which is $\pm 0.0035A$, so the displayed value between 0.9965A~1.0035A are within the error allowable range.

- **Measurement error of power**

When the frequency of input signal is within the range of 45Hz~66Hz, the active power accuracy of UTE310 is $\pm(0.1\%$ of reading + 0.05% of range).

Example 4 Using 150V, 1A range to measure the power of 80W (100V, 0.8A, 60Hz)

Power range equals to voltage range x current range, that is $150V \times 1A = 150W$,

When λ (Power factor) equals to 1

Reading error: $80 \times 0.1\% = 0.08W$

Range error: $150 \times 0.05\% = 0.075W$

The display error of measuring 800W power is the sum of reading error and range error, which is $\pm 0.155W$, remain two decimal places for $\pm 0.16W$, so the display value between 79.84W ~ 80.16W are within the error allowable range.

When λ (Power factor) equals to 0

When $\lambda=0$ (the phase difference of voltage and current is 90°), in theory, the active power $P=0W$, apparent power $S=80VA$, reactive power $Q=80var$. The power error of UTE310 is defined as follows.

When $45Hz \leq f \leq 66Hz$, the accuracy of apparent power is 0.1% of $\pm S$, that is $\pm (80VA \times 0.1\% = 0.08VA)$, the display value between 79.92VA~80.08VA are within the error allowable range.

When $0 < \lambda < 1$, such as when $\lambda=0.5$ (the phase difference of voltage and current is $\Phi=60^\circ$)

In theory,

The measured value of apparent power is 80.00VA.

The measured value of active power is 40.00W.

The measured value of reactive power is 69.28var.

When $0 < \lambda < 1$, the power error of UTE310 is defined as follows.

(Power reading) \times [(Power reading error %) + (Power range error %) \times (Power range/indicated apparent power) + $[\tan \Phi \times (\text{influence when } \lambda=0) \%]$], that is

$$P = 40 * \{0.1\% + 0.05\% * \frac{150}{80} + [\tan 60^\circ * 0.1\%]\}$$

$$= 40 * \{0.1 + 0.05 * 1.875 + \sqrt{3} * 0.1\}\%$$

$$= 40 * 0.367\%$$

$$= 0.1468W, \text{ remain two decimal places for } 0.15W$$

So the power between 39.85W~40.15W are within the error allowable range.

UNI-TREND TECHNOLOGY(CHINA) CO., LTD.

No.6, Industrial North 1st Road, Songshan Lake Park, Dongguan City, Guangdong Province, China

Postal Code: 523 808

www.uni-trend.com