Table of Contents

1. Introduction	4
2. Safety.....	5
3. Specification	6
4. Installation.....	16
4.1 Mains Operating Voltage.....	16
4.2 Mains Lead	16
4.3 Mounting	16
4.4 Ventilation	16
4.5 Handle/stand.....	16
5. Connections.....	17
5.1 Front Panel Connections	17
5.2 Rear Panel Connections.....	17
6. General	19
6.1 Initial Operation.....	19
6.2 Switching On.....	19
6.3 Keyboard	20
6.4 Display	20
6.5 Numeric Editing	21
6.6 Editing Principles	22
6.7 Information, Warning and Error Messages	22
6.8 General Soft-Keys.....	23
6.9 Maintenance	23
7. Continuous Carrier Waveform Operation	24
7.1 Waveform Selection.....	24
7.2 Waveform editing.....	24
7.3 Square-wave Duty Cycle	25
7.4 Ramp Symmetry	26
7.5 Output	26
7.6 Arb Waves	28
7.7 Arb Arbs	28
7.8 Sync Output.....	30
8. Pulse Generator.....	31
8.1 Pulse Width	31
8.2 Edge Times.....	32
9. Noise Generator	33
9.1 Carrier Wave Noise	33
9.2 Noise Modulation	33
10. PRBS Generator	34
10.1 Carrier Wave PRBS.....	34
10.2 PRBS Modulation.....	34
11. Modulation	35
11.1 AM	36
11.2 FM.....	38
11.3 PM	40

11.4	SUM.....	42
11.5	PWM.....	44
11.6	FSK.....	46
11.7	BPSK.....	48
11.8	ASK.....	50
12.	Sweep.....	52
12.1	Sweep Type.....	53
12.2	Start and Stop Frequency.....	53
12.3	Sweep Time.....	54
12.4	Sweep Mode.....	54
13.	Burst.....	57
13.1	Burst Type.....	58
13.2	Burst Count.....	58
13.3	Burst Phase.....	59
13.4	Burst Triggering.....	59
14.	Dual Channel Operation.....	61
14.1	Channel Selection.....	61
14.2	Linked Channels.....	61
15.	External Counter.....	64
15.1	Counter Menu.....	64
15.2	Counter Source.....	64
15.3	Counter Type.....	65
15.4	Measurement.....	65
16.	Harmonic Waveforms.....	66
16.1	Selecting arb location to store harmonic waveform.....	66
16.2	Editing harmonic waveform.....	67
17.	Utility Menu.....	69
17.1	System.....	69
17.2	Instrument Settings.....	71
17.3	I/O.....	73
17.4	Calibration.....	73
17.5	Dual Channel Operation.....	73
17.6	Help.....	73
18.	Stores Menu.....	74
18.1	Flash Drive Files and Folders.....	74
18.2	Using the Stores Menu.....	74
18.3	Operations on Set-up Files.....	76
18.4	Operations on Waveform files.....	79
19.	Help Operations.....	82
19.1	Help menu.....	82
19.2	Help Topics.....	82
20.	Editing Arbitrary Waveforms.....	83
20.1	Selecting an Arbitrary Waveform for Editing.....	83
20.2	Editing an Arbitrary waveform.....	83
21.	Calibration.....	87
21.1	Equipment Required.....	87
21.2	Calibration Procedure.....	87

21.3	Calibration Routine	88
21.4	Remote Calibration	90
22.	Remote Interface Operation	91
22.1	Address Selection	91
22.2	Remote/Local Operation	92
22.3	USB Interface	92
22.4	LAN Interface	92
22.5	GPIB Interface	94
22.6	Status Reporting	96
23.	Remote Commands.....	99
23.1	USB/LAN Remote Command Format	99
23.2	GPIB Remote Command Formats	99
23.3	Command List.....	100
24.	Appendix 1. Information, Warning and Error Messages	108
24.1	Error Messages	108
24.2	Warning Messages	112
24.3	Information Messages	113
24.4	Other Information Messages	113
25.	Appendix 2. Factory Default Settings.....	114
26.	Appendix 3. Waveform Manager Plus V4.11 -Arbitrary Waveform Creation and Management Software	116

The latest revisions of this manual, device drivers and software tools can be downloaded from: <http://www.aimtti.com/support>.

This manual is 48591-1370 Issue 1

1. Introduction

This manual is for the TGF3082 and TGF3162 dual channel generators. Wherever there are differences in the specification, the limits for the TGF3082 are shown in square brackets [] after the TGF3162 limits.

These programmable function/arbitrary generators use direct digital synthesis techniques to provide high performance and extensive facilities in a compact instrument. They can generate a wide variety of waveforms between 1 μ Hz and 160MHz [80MHz] with high resolution and accuracy.

Sine waves are produced with low distortion to 160MHz [80MHz]. Square waves have fast rise and fall times at up to 50MHz [25MHz]. Linear ramp waves are produced to 5MHz. Ramp and square waves also have variable symmetry.

The instruments can generate high resolution, low jitter, variable edge time pulses to 20MHz with variable period, pulse width and amplitude. Complex custom waveforms can be generated with 16-bit [14-bit] resolution and a sampling rate of 800MSa/s [400MSa/s]. Up to four waveforms can be stored in internal memory. Waveforms can also be generated by the supplied Waveform Manager Plus V4.11 Windows application and downloaded to the instrument via USB, LAN or optional GPIB interfaces or via a USB flash drive.

Front panel operation is straightforward and user friendly with all major parameters shown at all times on the large bright LCD. All major functions can be accessed with a single key or two. The knob or numeric keypad can be used to adjust frequency, amplitude, offset, and other parameters. Voltage values can be entered directly in Vpp or as high and low levels. Timing parameters can be entered in Hertz (Hz) or seconds.

Internal AM, FM, PM, ASK, FSK, BPSK, SUM* and PWM modulation make it easy to modulate waveforms without the need for a separate modulation source. Linear and logarithmic sweeps are also built in, with sweep rates selectable from 1 μ s to 500s. Burst mode operation allows for a user-selected number of cycles at each trigger event.

LAN and USB interfaces are standard and there is full compliance to LXI Core 2011 specification.

The instruments use a high stability temperature compensated internal oscillator and the external frequency reference input lets you synchronize to an external 10 MHz frequency standard for even greater accuracy.

- Sine waves up to 160MHz [80MHz], square waves up to 50MHz [25MHz]
- 17 standard waveforms available plus pulse, noise, PRBS*, harmonics* and arbitrary
- User defined pulses with 100ps resolution
- 16 bit [14 bit] resolution arbitrary waveforms with 800MHz [400MHz] sampling frequency
- Up to 4 arbitrary waveforms of 2 to 8192 points.
- Fully compliant to LXI Core 2011 specification
- AM, FM, PM, ASK, FSK, BPSK, SUM and PWM modulation types
- Linear & logarithmic sweeps
- 3 burst types; Gated, Counted and Infinite
- 10 mVpp to 10 Vpp amplitude range (into 50 Ω)
- Two identical channels with phase control, coupling* and tracking*
- Visual representation of the output waveform shown at all times on the LCD
- Connect via USB and LAN
- USB host port for connection of USB flash drives for waveform and set-up storage

Features marked * are standard on the TGF3162 and optional on the TGF3082 by adding GU3082.

2. Safety

This generator is a Safety Class I instrument according to IEC classification and has been designed to meet the requirements of EN61010–1 (Safety Requirements for Electrical Equipment for Measurement, Control and Laboratory Use). It is an Installation Category II instrument intended for operation from a normal single phase supply.

This instrument has been tested in accordance with EN61010–1 and has been supplied in a safe condition. This instruction manual contains some information and warnings which have to be followed by the user to ensure safe operation and to retain the instrument in a safe condition.

This instrument has been designed for indoor use in a Pollution Degree 2 environment in the temperature range 5°C to 40°C, 20% – 80% RH (non–condensing). It may occasionally be subjected to temperatures between +5° and –10°C without degradation of its safety. Do not operate while condensation is present.

Use of this instrument in a manner not specified by these instructions may impair the safety protection provided. Do not operate the instrument outside its rated supply voltages or environmental range.

WARNING! THIS INSTRUMENT MUST BE EARTHED

Any interruption of the mains earth conductor inside or outside the instrument will make the instrument dangerous. Intentional interruption is prohibited. The protective action must not be negated by the use of an extension cord without a protective conductor.

When the instrument is connected to its supply, terminals may be live and opening the covers or removal of parts (except those to which access can be gained by hand) is likely to expose live parts. The apparatus shall be disconnected from all voltage sources before it is opened for any adjustment, replacement, maintenance or repair.

Any adjustment, maintenance and repair of the opened instrument under voltage shall be avoided as far as possible and, if inevitable, shall be carried out only by a skilled person who is aware of the hazard involved.

If the instrument is clearly defective, has been subject to mechanical damage, excessive moisture or chemical corrosion the safety protection may be impaired and the apparatus should be withdrawn from use and returned for checking and repair.

Make sure that only fuses with the required rated current and of the specified type are used for replacement. The use of makeshift fuses and the short–circuiting of fuse holders is prohibited.

This instrument uses a Lithium button cell for non–volatile memory battery back–up; typical life is 5 years. In the event of replacement becoming necessary, replace only with a cell of the correct type, i.e. 3V Li/MnO₂ 20mm button cell type 2032. Exhausted cells must be disposed of carefully in accordance with local regulations; do not cut open, incinerate, expose to temperatures above 60°C or attempt to recharge.

Do not wet the instrument when cleaning it and in particular use only a soft dry cloth to clean the LCD window. The following symbols are used on the instrument and in this manual:



Caution –refer to the accompanying documentation, incorrect operation may damage the instrument.



terminal connected to chassis ground.



mains supply OFF.



mains supply ON.



alternating current.

3. Specification

General specifications apply for the temperature range 5°C to 40°C. Accuracy specifications apply for the temperature range 18°C to 28°C after 30 minutes warm-up, at maximum output into 50Ω. Typical specifications are determined by design and are not guaranteed.

TGF3082 limits, where different, are shown in square brackets [] after the TGF3162 limits.

Waveforms

Standard Waveforms

Sine, Square, Ramp (Variable Symmetry), Triangle (50% Ramp symmetry), Positive Ramp (100% Ramp symmetry), Negative Ramp (0% Ramp symmetry), Pulse, Noise (Gaussian), PRBS (only available in TGF3082 with Option GU3082), DC, Sin(x)/x, Exponential Rise, Exponential Fall, Logarithmic Rise, Logarithmic Fall, Haversine, Cardiac, Gaussian, Lorentz, D-Lorentz and 4 User Defined Arbitrary Waveforms. Dozens of useful pre-built arbitrary waveforms are also supplied on CD.

Sine

Frequency Range:	1μHz to 160MHz [1μHz to 80MHz]
Frequency Resolution:	1μHz, 15 digits [14 digits]
Output Level:	≤ 50MHz 10mVp-p to 10Vp-p into 50Ω ≤ 100MHz 10mVp-p to 5Vp-p into 50Ω ≤ 160MHz 10mVp-p to 2.5Vp-p into 50Ω
Amplitude Flatness (1 Vp-p, relative to 10kHz):	≤10MHz ±0.1dB ≤100MHz ±0.2dB ≤160MHz ±0.6dB
Harmonic Distortion (1Vp-p):	≤ 10MHz -65dBc ≤ 50MHz -50dBc ≤ 80MHz -40dBc ≤ 160MHz -35dBc
Total Harmonic Distortion DC to 20kHz (Typical):	0.05% [0.07%]
Non-Harmonic Spuri:	-65dBc
Phase Noise (10MHz, 1Vp-p, 10kHz offset):	-113dBc/Hz

Square

Frequency Range:	1μHz to 50MHz [1uHz to 25MHz]
Frequency Resolution:	1μHz, 14 digits
Output Level:	10mVp-p to 10Vp-p into 50Ω
Duty Cycle	0.001% to 99.999%, 0.001% resolution
Rise and Fall Times (Typical):	5ns, Fixed [10ns, Fixed]
Aberrations (Typical):	±5% of amplitude
Jitter (RMS):	<30ps (cycle to cycle)

Ramp

Frequency Range:	1 μ Hz to 5MHz
Frequency Resolution:	1 μ Hz, 13 digits
Output Level:	10mVp-p to 10Vp-p into 50 Ω
Linearity Error:	<0.1% to 200kHz [<0.1% to 100kHz]
Variable Symmetry:	0.00 % to 100.00 %, 0.01% resolution

Pulse

Frequency Range:	1mHz to 20MHz
Frequency Resolution:	1mHz, 11 digits
Output Level:	10mVp-p to 10Vp-p into 50 Ω
Aberrations (Typical):	\pm 3% of amplitude [\pm 5% of amplitude]
Jitter RMS:	<30ps (cycle to cycle)
Rise and Fall Times:	Rise and Fall times can only be varied together simultaneously
	Range: 10ns to 1ms (10% to 90%)
	Resolution: 100ps
	Accuracy: \pm 500ps \pm 0.01% of period
Width:	Range: 25ns to 999.999999975s
	Resolution: 100ps
	Accuracy: \pm 200ps \pm 0.01% of period
Duty:	0.001% to 99.999%, 0.01% resolution

Arbitrary

In built arbitrary waveforms (Sin(x)/x, Exponential Rise, Exponential Fall, Logarithmic Rise, Logarithmic Fall, Haversine, Cardiac, Gaussian, Lorentz and D-Lorentz). Up to 4 user-defined waveforms may be stored in non-volatile memory. Waveforms can be defined by downloading of waveform data via remote interfaces or from the instrument's front panel.

Waveform Memory Size:	8192 points
Vertical Resolution:	16 bits [14 bits]
Frequency Range:	In built arbitrary waveforms 1 μ Hz to 4MHz [1 μ Hz to 2MHz] User defined arbitrary waveforms 1 μ Hz to 80MHz [1 μ Hz to 40MHz]
Frequency Resolution:	In built arbitrary waveforms 1 μ Hz, 13 digits User defined arbitrary waveforms 1 μ Hz, 14 digits
Output Level:	\leq 50MHz 10mVp-p to 10Vp-p into 50 Ω \leq 80MHz 10mVp-p to 5Vp-p into 50 Ω
Sampling rate:	800MSa/s [400MSa/s]
Point to Point Jitter (Typical):	1.25ns [2.5ns]
Rise and Fall Times:	<5ns for 100MHz filter [$<$ 8ns] <8ns for 62.5MHz filter
Effective Analogue Bandwidth (-3dB):	62.5MHz, 100MHz, User Selectable [62.5MHz fixed]

Noise

Gaussian White Noise: Noise can also be used as modulating waveform.

Bandwidth (-3dB): 100MHz [62.5MHz]

Noise crest factor
(Vp/Vrms): 5.16 [6.4]

Output Level: 10mVp-p to 10Vpp into 50Ω

PRBS (only available in TGF3082 with Option GU3082)

Bit Rate: 1μbps to 50Mbps [1μbps to 25Mbps], 1μbps resolution

Sequence Length: $2^m - 1$, where $m = 7, 9, 11, 15, 20, 23, 29$ or 31

Rise and Fall Times
(Typical): 5ns Fixed [10ns Fixed]

Output Level: 10mVp-p to 10Vpp into 50Ω

Harmonic Output (only available in TGF3082 with Option GU3082)

Harmonic waveforms can be defined and stored in user-defined arbitrary waveform locations.

Frequency Range: 1μHz to 80MHz [1μHz to 40MHz]

Frequency Resolution: 1μHz, 14 digits

Harmonic Order: 1 to 50, Up to 16 different harmonics order can be defined

Harmonic Amplitude: 0.0% to 100.0% of output amplitude, 0.1% resolution

Harmonic Phase: -360.0 to +360.0 degrees, 0.1 degree resolution

Output Level: ≤ 50MHz 10mVp-p to 10Vp-p into 50Ω
≤ 80MHz 10mVp-p to 5Vp-p into 50Ω

Internal Frequency Reference

Initial Setting Error: <± 1ppm

Oscillator Ageing Rate: <± 1ppm first year

Temperature Stability: <1ppm over the specified temperature range

Modulation

AM (Amplitude Modulation) Normal & Suppressed Carrier

Carrier Waveforms: Sine, Square, Ramp, Pulse, Noise, PRBS (only available in TGF3082 with Option GU3082), Arb

Maximum Carrier
Frequency: 50MHz [25MHz], subject to carrier waveform.

Modulation Source: Internal/External

Internal Modulating
Waveforms: Sine, Square, Positive Ramp, Negative Ramp, Triangle, Gaussian Noise, DC, Sinc, Exponential Rise, Exponential Fall, Logarithmic Rise, Logarithmic Fall, Haversine, Gaussian, Lorentz, D-Lorentz, Cardiac, PRBS-PN7, PN9, PN11, PN15, PN20, PN23, PN29, PN31 and User Defined Arbs (PRBS waveforms only available in TGF3082 with Option GU3082).

Internal Modulating
Frequency: 1μHz to 10MHz, 1μHz resolution

Amplitude Depth: 0.00% to 100.00%, 0.01% resolution

FM (Frequency Modulation)

Carrier Waveforms:	Sine, Square, Ramp, Arb
Modulation Source:	Internal/External
Internal Modulating Waveforms:	Sine, Square, Positive Ramp, Negative Ramp, Triangle, Gaussian Noise, DC, Sinc, Exponential Rise, Exponential Fall, Logarithmic Rise, Logarithmic Fall, Haversine, Gaussian, Lorentz, D-Lorentz, Cardiac, PRBS-PN7, PN9, PN11, PN15, PN20, PN23, PN29, PN31 and User Defined Arbs (PRBS waveforms only available in TGF3082 with Option GU3082).
Internal Modulating Frequency:	1 μ Hz to 10MHz, 1 μ Hz resolution
Frequency Deviation:	DC to Fmax/2, 1 μ Hz resolution

PM (Phase Modulation)

Carrier Waveforms:	Sine, Square, Ramp, Arb
Modulation Source:	Internal/External
Internal Modulating Waveforms:	Sine, Square, Positive Ramp, Negative Ramp, Triangle, Gaussian Noise, DC, Sinc, Exponential Rise, Exponential Fall, Logarithmic Rise, Logarithmic Fall, Haversine, Gaussian, Lorentz, D-Lorentz, Cardiac, PRBS-PN7, PN9, PN11, PN15, PN20, PN23, PN29, PN31 and User Defined Arbs (PRBS waveforms only available in TGF3082 with Option GU3082).
Internal Modulating Frequency:	1 μ Hz to 10MHz, 1 μ Hz resolution
Phase Deviation:	-360.000 to +360.000 degrees, 0.001 degree resolution

ASK (Amplitude Shift Keying)

Carrier Waveforms:	Sine, Square, Ramp, Pulse, Noise, PRBS (only available in TGF3082 with Option GU3082), Arb
Maximum Carrier Frequency:	50MHz [25MHz], subject to carrier waveform.
Source:	Internal/External (via TRIG IN)
Internal Modulation:	2mHz to 10MHz (50% duty cycle square)

FSK (Frequency Shift Keying)

Carrier Waveforms:	Sine, Square, Ramp, Arb
Source:	Internal/External (via TRIG IN)
Internal Modulation:	2mHz to 10MHz (50% duty cycle square)

BPSK (Binary Phase Shift Keying)

Carrier Waveforms:	Sine, Square, Ramp, Arb
Modulation Source:	Internal/External (via TRIG IN)
Internal Modulation:	2mHz to 10MHz (50% duty cycle square)

PWM (Pulse Width Modulation)

Carrier Waveforms:	Pulse
Modulation Source:	Internal/External
Internal Modulating Waveforms:	Sine, Square, Positive Ramp, Negative Ramp, Triangle, Gaussian Noise, DC, Sinc, Exponential Rise, Exponential Fall, Logarithmic Rise, Logarithmic Fall, Haversine, Gaussian, Lorentz, D-Lorentz, Cardiac, PRBS-PN7, PN9, PN11, PN15, PN20, PN23, PN29, PN31 and User Defined Arbs (PRBS waveforms only available in TGF3082 with Option GU3082).
Internal Modulating Frequency:	1 μ Hz to 10MHz, 1 μ Hz resolution
Pulse Width Deviation:	0% to 100% of pulse width, 0.01% resolution

SUM (Additive Modulation) (only available in TGF3082 with Option GU3082)

Carrier Waveforms:	Sine, Square, Ramp, Pulse, Noise, PRBS, Arb
Maximum Carrier Frequency:	50MHz [25MHz], subject to carrier waveform.
Modulation Source:	Internal/External
Internal Modulating Waveforms:	Sine, Square, Positive Ramp, Negative Ramp, Triangle, Gaussian Noise, DC, Sinc, Exponential Rise, Exponential Fall, Logarithmic Rise, Logarithmic Fall, Haversine, Gaussian, Lorentz, D-Lorentz, Cardiac, PRBS-PN7, PN9, PN11, PN15, PN20, PN23, PN29, PN31 and User Defined Arbs.
Internal Modulating Frequency:	1 μ Hz to 10MHz, 1 μ Hz resolution
Ratio:	0% to 100%, 0.01% resolution

Triggered Burst

Each active edge of the trigger signal will produce one burst of the waveform.

Carrier Waveforms:	Sine, Square, Ramp, Pulse, Noise, PRBS, Arb
	Sine, Square, Ramp, Pulse, Arb: A fixed number of cycles, specified as number of cycles are generated at every trigger event.
	PRBS: A fixed number of bits, specified as number of cycles are generated at every trigger event (PRBS waveforms only available in TGF3082 with Option GU3082).
	Noise: Noise is reset to its start condition at every trigger event. Allows generating same random noise sequence.
Maximum Carrier Frequency:	50MHz [25MHz] (finite cycles), Fmax(infinite), subject to carrier waveform.
Number of Cycles:	1 to 2147483647 and infinite.
Trigger Repetition Rate:	2mHz to 50MHz [2mHz to 25MHz] internal DC to 1MHz external.
Trigger Signal Source:	Internal from keyboard or trigger generator. External from TRIG IN or remote interface.
Trigger Start/Stop Phase:	-360.000 to +360.000 degrees, 0.001 degree resolution. Phase offset cannot be set for Noise and PRBS waveforms.

Gated

Waveform will run while the Gate signal is true and stop while false.

Carrier Waveforms:	Sine, Square, Ramp, Pulse, Noise, PRBS (only available in TGF3082 with Option GU3082), Arb
Maximum Carrier Frequency:	50MHz [25MHz], subject to carrier waveform.
Trigger Repetition Rate:	2mHz to 50MHz [2mHz to 25MHz] internal DC to 1MHz external.
Gate Signal Source:	Internal from keyboard or trigger generator. External from TRIG IN or remote interface.
Gate Start/Stop Phase:	-360.000 to +360.000 degrees, 0.001 degree resolution. Phase offset cannot be set for Noise and PRBS waveforms.

Sweep

Frequency sweep capability is provided for both standard and arbitrary waveforms.

Carrier Waveforms:	Sine, Square, Ramp, Arb
Sweep Mode:	Linear or logarithmic, triggered or continuous.
Sweep Direction:	Up or Down
Sweep Range:	From 1 μ Hz to Fmax. Phase continuous. Independent setting of the start and stop frequency.
Sweep Time:	1 μ s to 500s (9 digit resolution).
Sweep Trigger Source:	The sweep may be free run or triggered from the following sources: Internal from keyboard or trigger generator. Externally from TRIG IN input or remote interface. External trigger repetition rate: DC to 1MHz

Trigger Generator

Internal source 20ns to 500s or 2mHz to 50MHz [40ns to 500s or 2mHz to 25MHz] square wave adjustable in 10ns steps, 11 digit resolution. Each channel has its own trigger generator. Channel 1 trigger is available for external use from the MAIN OUT 2 socket when Channel 2 is configured to output Channel 1 sync waveform and sync source is set to trigger.

Dual-channel Operations (only available in TGF3082 with Option GU3082)

Tracking

Independent (Off):	The channels are independent of each other.
Equal:	The two channels are identical and behave identically.

Coupling

Frequency coupling:	The frequencies of the two channels can be coupled. Changing the frequency of one channel changes the frequencies of both channels.
Amplitude (and DC Offset) coupling:	Amplitude (and DC offset) of the two channels can be coupled. Changing the amplitude and offset on one channel changes the amplitude and offset of both channels.
Output coupling:	Output On/Off can be coupled. Switching the output On/Off on one channel switches the output On/Off of both channels.

Characteristics

Relative phase:	-360.000 to 360.000 degrees, 0.001 degree resolution (Phase offset cannot be set for Noise)
Channel to channel Skew (typical):	<1ns (when performing identical operations)
Crosstalk (typical):	<-80db

External Frequency Measurement

Function:	Frequency, Period, Positive Width, Negative Width, Duty Cycle
Frequency Range:	AC coupled 3Hz to >125MHz DC coupled 100mHz to >125MHz
Source:	AC coupled REF / COUNT (AC) IN DC coupled TRIG / COUNT (DC) IN
Frequency Resolutuion:	Up to 7 digits displayed.
Measurement Time:	Automatic
Input Range and Sensitivity:	AC coupled ≤50MHz 100mVpp - 5Vpp >50MHz 250mVpp - 5Vpp Maximum input ±10V DC coupled Threshold typically 1.2V; Sensitivity 100mVpp (≤50MHz), 250mVpp (<50MHz) maximum input +5V, -1V
Hysteresis:	Input hysteresis voltage 10mV
Accuracy:	±1 digit ± timebase accuracy.
Timebase Accuracy:	<± 1ppm initial settling error, <± 1ppm oscillator ageing rate in the first year, <1ppm over the specified temperature range

Outputs

Main Outputs

Output Impedance:	50Ω
Amplitude:	≤ 50MHz 20mV to 20Vp-p open circuit (10mV to 10Vp-p into 50Ω) ≤ 100MHz 20mV to 10Vp-p open circuit (10mV to 5Vp-p into 50Ω) ≤ 160MHz 20mV to 5Vp-p open circuit (10mV to 2.5Vp-p into 50Ω) Amplitude can be specified open circuit (hi Z) or into an assumed load of 1Ω to 10kΩ in Vpp.
Amplitude Accuracy:	1.5% ±5mV at 1kHz into 50Ω
DC Offset Range:	±10V. DC offset plus signal peak limited to ±10V from 50Ω.
DC Offset Accuracy:	Typically 1% ±50mV.
Resolution:	3 digits or 1mV for both Amplitude and DC Offset.

Sync Output

Channel 2 can be configured to output Channel 1 sync from its MAIN OUT 2 socket. Sync is a multi function output which is automatically selected to be any of the following. Alternatively, the user can choose Sync to always be carrier referenced, to output the currently used trigger signal or turn it off.

Carrier Waveform Sync:	Sine / Square / Ramp / Pulse / Arbs	$\leq 50\text{MHz}$ [$\leq 25\text{MHz}$]	A square wave with 50% duty cycle at the waveform frequency.
		$\leq 160\text{MHz}$ [$\leq 80\text{MHz}$]	A sine wave at the waveform frequency.
	Pattern		A positive pulse which is 1 bit rate wide at the beginning of the sequence
	Noise		No sync associated with noise.
Modulation Sync:	AM/FM/PM/SUM/PWM		A square wave with 50% duty cycle referenced to the internal modulation waveform when modulation source is internal, or a square wave referenced to the carrier waveform when modulation source is external. No sync is associated with Noise and DC waveforms as the modulation source .
	ASK		A square wave referenced to the trigger rate. The sync is a TTL high when hop amplitude is the output amplitude and TTL low when carrier amplitude is the output amplitude for positive slope and vice versa for negative slope.
	FSK		A square wave referenced to the trigger rate. The sync is a TTL high when hop frequency is the output frequency and TTL low when carrier frequency is the output frequency for positive slope and vice versa for negative slope.
	BPSK		A square wave referenced to the trigger rate. The sync is a TTL high when the hop phase is the output phase and TTL low when carrier phase is the output phase for positive slope and vice versa for negative slope.
Sweep Sync:			A square wave that is a TTL high from the beginning of the sweep and a TTL low from the midpoint of the sweep
Burst Sync:	Internal Trigger		A square wave with 50% duty cycle at the trigger frequency.
	External Trigger		A square wave with same duty cycle and frequency as the external source.
	Manual Trigger		A positive pulse which is approximately 18us wide at the beginning of the event.
Trigger:			Selects the current trigger signal.
Output Signal Level:			Logic level nominally 3V
Output Impedance:			50 Ω

Ref Clock Output

Buffered version of the 10MHz clock currently in use (internal or external)

Output Level: Nominally 3V logic level from 50 Ω .

Inputs

Trigger / Count (DC) Input

For ASK, FSK, BPSK, triggered sweep, gated burst, triggered burst and DC coupled external frequency measurement.

Frequency Range:	Trigger Input	DC – 1MHz
	Counter Input	100mHz to >125MHz
Signal Range:	Threshold typically 1.2V; Sensitivity 100mVpp (≤ 50 MHz), 250mVpp (> 50 MHz) Maximum input +5V / -1V.	
Minimum Pulse Width (Trigger Input):	50ns	
Polarity (Trigger Input):	Selectable as high/rising edge or low/falling edge.	
Input Impedance:	10k Ω	

External Modulation Input

For AM, FM, PM, SUM and PWM

Voltage Range:	± 2.5 V full scale
Input Impedance:	5k Ω typical
Bandwidth:	DC to 5MHz

Ref Clock / Count (AC) Input

Input for an external 10MHz reference clock and AC coupled external frequency measurement.

Voltage Range:	≤ 50 MHz	100mVpp – 5Vpp
	> 50 MHz	250mVpp – 5Vpp
Maximum Voltage:	+10V	
Minimum Voltage:	-10V	

Interfaces

Full digital remote control facilities are available through LAN, USB and optional GPIB interfaces.

LAN Interface	Ethernet 100/10base – T hardware connection. 1.4 LXI Core 2011
USB Interface	Standard USB 2.0 hardware connection. Implemented as virtual-COM port.
USB Flash Drive	For waveform and set-up storage/recall.
GPIB (optional)	Conforming with IEEE488.1 and IEEE488.2

General

Display:	256 x 112 pixel monochrome graphics display. White LED backlight with adjustable brightness and contrast. Black-on-white or inverse modes.
Data Entry:	Keyboard selection of mode, waveform etc.; value entry direct by numeric keys or by rotary control.
Stored Settings:	Up to 9 complete instrument set-ups may be stored and recalled from internal memory.
Size:	Bench Top: 97mm height; 250mm width; 295mm long Rack mount: 86.5mm (2U) height; 213.5mm (½-rack) width; 269mm long
Weight:	3.2kg
Power:	100-240VAC ±10% 50/60Hz; 100-120VAC ±10% 400Hz; 60VA max. Installation Category II.
Operating Range:	+5°C to 40°C, 20–80% RH.
Storage Range:	–20°C to + 60°C.
Environmental:	Indoor use at altitudes up to 2000m, Pollution Degree 2.
Options:	19 inch rack mounting kit.
Safety & EMC:	Complies with EN61010–1 & EN61326-1. For details, request the EU Declaration of Conformity for this instrument via http://www.aimtti.com/support (serial no. needed).

4. Installation

4.1 Mains Operating Voltage

This instrument has a universal input range and will operate from a nominal 115V or 230V mains supply without adjustment. Check that the local supply meets the AC input requirement given in the Specification.

4.2 Mains Lead

Connect the instrument to the AC supply using the mains lead provided. Should a mains plug be required for a different mains outlet socket, a suitably rated and approved mains lead set should be used which is fitted with the required wall plug and an IEC60320 C13 connector for the instrument end. To determine the minimum current rating of the lead-set for the intended AC supply, refer to the power rating information on the equipment or in the Specification.

WARNING! THIS INSTRUMENT MUST BE EARTHED.

Any interruption of the mains earth conductor inside or outside the instrument will make the instrument dangerous. Intentional interruption is prohibited.

4.3 Mounting

This instrument is suitable both for bench use and rack mounting. It is delivered with soft protective front and rear bezels which have integral moulded feet; this is the most suitable configuration for bench use.

For rack mounting the protective bezels and handle/stand can be removed such that the instrument can be fitted beside any other standard 2U half-rack instrument in a 19" rack. A suitable 2U 19" rack kit is available from the Manufacturers or their overseas agents; full details of how to remove the handle and bezels are included with the kit.

4.4 Ventilation

The generator uses a small fan fitted to the rear panel. Take care not to restrict the rear air exit or the inlet vents at the front (sides and underneath). In rack-mounted situations allow adequate space around the instrument and/or use a fan tray for forced cooling.

4.5 Handle/stand

The instrument is fitted with a 4-position handle/stand. Pull out both sides of the handle at the case pivot points, to free the position locking pegs, and rotate the handle from the stowed position to the required stand or handle position. Release the sides of the handle to lock it in the new position.

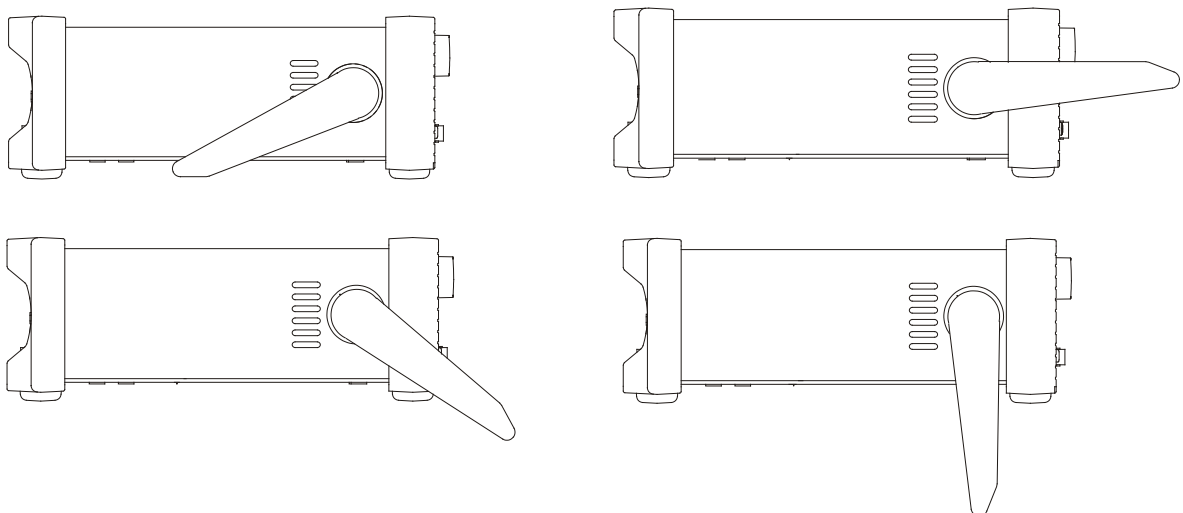

5. Connections

5.1 Front Panel Connections

5.1.1 MAIN OUT (One for each channel)

This is the 50Ω output from main generator. It will provide up to 20V peak-to-peak e.m.f. which will yield 10V peak-to-peak into a matched 50Ω load. To maintain waveform integrity only 50Ω cable should be used and the receiving end should be terminated with a 50Ω load. It can tolerate a short circuit for 60 seconds.

 Do not apply an external voltage to this output.

Channel 2 can also be configured to output Channel 1 sync from its MAIN OUT 2 socket. See 'specification' section 3 for more details.

Sync is a multi function output which is automatically selected to be any of the following. Alternatively, the user can choose Sync to always be carrier referenced, to output the currently used trigger signal or turn it off.

5.1.2 FLASH DRIVE

This is a USB Host port for the connection of most types of flash drive which conform to the Mass Storage Class specification. The instrument will accept drives formatted with the FAT16 or FAT32 filing systems.

5.2 Rear Panel Connections

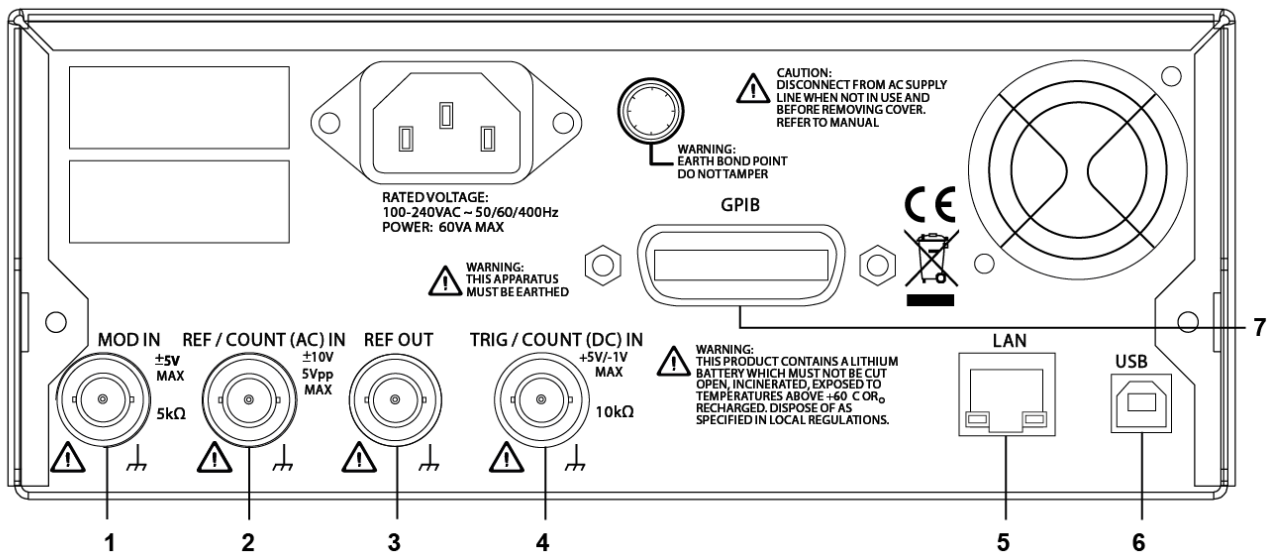

1. MOD IN

This is the external modulation input socket for AM, FM, PM, SUM or PWM. Full-scale input is $\pm 2.5V$, frequency DC to 5MHz.

 Do not apply an external voltage exceeding $\pm 5V$.

2. REF / COUNT (AC) IN

Input for an external 10MHz reference clock and AC coupled external frequency measurement. Input range 100mVpp – 5Vpp.

 Do not apply external voltages exceeding $\pm 10V$ to this signal connection.

3. REF OUT

Buffered version of the 10MHz clock currently in use (internal or external). Output level nominally 3V logic from 50Ω.



Do not apply external voltages to this output.

4. TRIG / COUNT (DC) IN

This is the external input for ASK, FSK, BPSK, triggered sweep, gated burst, triggered burst and DC coupled external frequency measurement. Threshold is typically 1.2V and input sensitivity is 100mVpp.



Do not apply external voltages exceeding + 5V or –1V to this signal connection.

5. LAN

The LAN interface is designed to meet LXI (Lan eXtensions for Instrumentation) Core 2011. Remote control using the LAN interface is possible using the TCP/IP Socket protocol. The instrument also contains a basic Web server which provides information on the unit and allows it to be configured. Since it is possible to misconfigure the LAN interface, making it impossible to communicate with the instrument over LAN, a LAN Configuration Initialise (LCI) mechanism is provided via the user interface to reset the unit to the factory default.

Further details are given in the Remote Operation chapter. For more information on LXI standards refer to www.lxistandard.org

6. USB

The USB port is connected to instrument ground. It accepts a standard USB cable. If the USB driver has been installed from the CD, the Windows plug-and-play function should automatically recognise that the instrument has been connected. See the USB folder on the CD for information on installing the driver on a PC.

Further details are given in the Remote Operation chapter 22.

7. GPIB (IEEE–488) - optional

The GPIB interface is not isolated; the GPIB signal grounds are connected to the instrument ground.

The implemented subsets are:

SH1 AH1 T6 TE0 L4 LE0 SR1 RL1 PP1 DC1 DT1 C0 E2

The default GPIB address is 5.

Further details are given in 'Remote Operation' section 22.

6. General

6.1 Initial Operation

This section is a general introduction to the organisation of the instrument and is intended to be read before using the generator for the first time.

In this manual front panel keys and sockets are shown in capitals, e.g. SWEEP, MAIN OUT; all soft-key labels, entry fields and messages displayed on the LCD are shown in a different type-face, e.g. *Offset*, *Sine*.

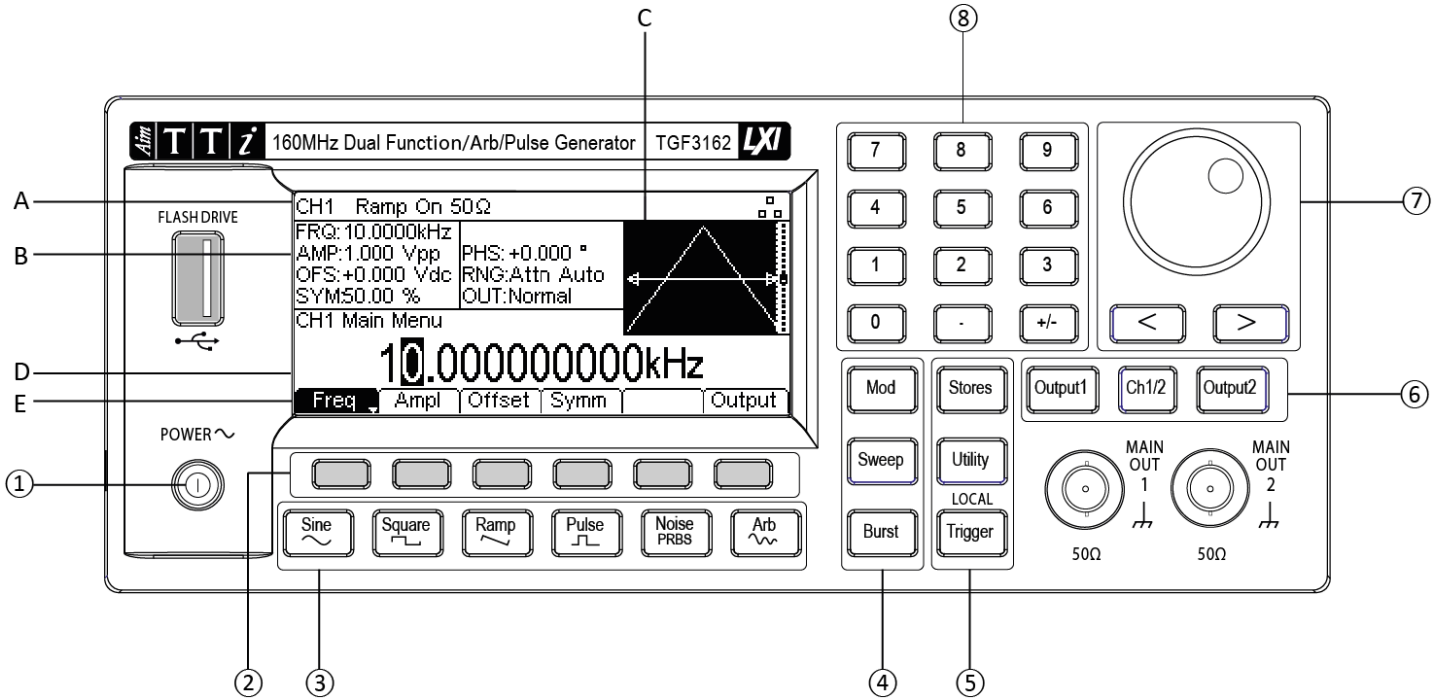

6.2 Switching On

① The power switch - At power up the generator displays a start-up message whilst initialising the application; if an error is encountered the message

Firmware Update / Battery Fail. Initialised to factory default state.

will be displayed, see 'Warnings and Error Messages' section 6.7

Loading takes a few seconds, after which the carrier waveform set-up screen is displayed, showing the generator parameters set to their default values, with the MAIN OUT output set to off. Refer to 'Utility Operations' section 17.1.1 for how to change the power up settings to either those at power down or to the defaults.

WARNING- To fully disconnect from the AC supply unplug the mains cord from the back of the instrument or switch off at the AC supply outlet; make sure that the means of disconnection is readily accessible. Disconnect from the AC supply when not in use.

6.3 Keyboard

The front panel contains the liquid crystal display (LCD) and the keyboard which are used together to control all instrument functions.

The keys are grouped as follows:

- ② Six soft keys under the display. The function of these keys change as the instrument is operated. The current function is shown on the LCD in a box above each key. An empty box means that the key currently has no function.
- ③ SINE, SQUARE, RAMP, PULSE, NOISE/PRBS and ARB select the carrier waveform. The selected key glows green. Selecting any of these waveforms will cancel the previously selected waveform.
- ④ MOD (modulation), SWEEP and BURST select the operating mode. The selected key glows orange. If all keys are unlit the mode will be continuous carrier wave.
- ⑤ TRIGGER/LOCAL key. Used to issue a manual trigger signal. This key is also used to return to local from remote mode.
- UTILITY key gives access to menus for a variety of functions such as sync out set-up, power-up parameters, error message settings, frequency counter and dual channel functions.
- STORES key allows access to the built in storage for waveforms and set-ups and to a connected flash drive.

⑥ The OUTPUT keys simply switch the selected MAIN OUT on or off. The key glows green when the output is on. There are two OUTPUT keys, one for each channel and an additional key between these marked CH1/2 which is used to select between the channels for parameter editing; the selected channel is indicated at the top left of the Status Line

NOTE: The display colour scheme of channel 2 is the inverse of the display colour scheme of channel 1 for ease of identification of the currently selected channel.

⑦ KNOB and left and right cursor keys. Used during numeric entry. The left and right keys move the edit position left or right and the knob increments or decrements the value of the selected digit.





⑧ Numeric keys permit direct entry of a value for the parameter currently selected.

NOTE: Press and hold down any key, including soft-keys, for two seconds to access the Help page for that key

6.4 Display

A- The Status Line. indicates the status of the instrument as follows:

- The Channel field indicates which channel is currently selected for editing (**CH1** or **CH2**). If the channels are Tracking the field will change to **Track** . If the channels are Tracking with inversion the field will show **InvTk** .
- The Waveform field shows the currently selected waveform (e.g. **SINE**).
- The Output signal status for the channel is displayed as **On** or **Off**.
- The selected load impedance is shown in Ohms.
- If the output is set to be inverted **Inv** will be displayed.
- The next field indicates the external clock status. If the internal clock is being used, nothing is displayed. If an external clock is being applied or is being used, the **Ext**  symbol appears. If the clock is in use the symbol is followed by an arrow. If a valid clock signal is detected (but not used), the symbol is followed by **DET** . If the clock source is set to external and a valid external clock signal is not detected, the symbol is followed by **ERR** .

- When the instrument is under remote control via any interface **REM** will be displayed.
- The  field indicates the status of the Local Area Network interface. As shown, there is no LAN connection. When connected the field will change to . While a connection is being established the indicator will flash. If the LAN is connected but not enabled the field will show as . Finally an unsuccessful attempt to connect will show . See remote control section 22.4 for more detailed information.

B- Parameters Boxes, show the waveform parameter settings for the selected channel. These always include **FRQ** (frequency), **AMP** (amplitude) and **OFS** (offset). Additional parameters shown will depend upon the waveform type. When a waveform modifier (Modulation, Sweep or Burst) is enabled, the right hand section will show parameters of the modifier.

C- Graph Box, shows a representation of the waveform which the instrument is generating on the selected channel. The parameter currently being edited is indicated by arrows.

D- Edit Box, shows the value of the parameter currently being edited on the selected channel. This will be a numeric value or a parameter string.

E- Soft-key Labels, change as editing proceeds.

NOTE: A Pop-up Box may also appear to provide error or warning messages or to give other information to the user.

6.5 Numeric Editing

Any numeric parameter may be changed in one of the following ways:

- Enter a new value from the numeric key pad.
- Use the left and right cursor keys to select a digit position then use the knob to increment/decrement the value at that position.

Examples of each method are shown below.

6.5.1 Using the Numeric Key Pad

Pressing a number key will erase the current parameter value in the Edit Box and replace it with the current entry. The Soft-key Labels will also change to a list of units applicable to the parameter being edited.

The examples below show frequency units and period (time) units respectively.

4					
uHz	mHz	Hz	kHz	MHz	Cancel

2.55					
	ns	us	ms	s	Cancel

During the numeric data entry a decimal point and, if appropriate, a sign may be entered. The +/- key is used to alternately change the sign between + and -. The left cursor key may be used to erase the last digit entered. The entry may be cancelled by pressing the **Cancel** key

Once the entry is complete it may be terminated by pressing the soft-key below the required units. The value will be checked and accepted as the new value for the relevant parameter.

6.5.2 Using the Knob and Cursor Keys

A numeric parameter will be displayed with an inverse edit cursor over one of the digits. The left and right cursor keys may be used to move the edit cursor to any digit in the value. Values are always shown with enough digits to the right of the decimal point to show the best resolution for the parameter. For example the right-most digit in a frequency value will be μHz . Depending on the actual value one or more digits to the left of the most significant digit displayed may be zero and will not be shown. It is possible to move the edit cursor into these digit positions and the suppressed zeros will be shown as in the example below.



With the edit cursor positioned at the required digit the knob may be rotated left or right to decrement or increment the digit. As the value passes between 9 and 0 the digits to the left will also change. In this way it is possible to set any legal value for the parameter.

NOTE: Changes made by turning the knob are applied immediately to the parameter as long as the value remains legal.

6.6 Editing Principles

The instrument parameters are edited using the keyboard in conjunction with the Soft-key Labels and the Edit Box.

Generally, the required parameter is selected by pressing waveform keys, modulation keys or soft-keys or a combination of these to show the parameter in the Edit Box. The parameter is then edited using the numeric keys, the soft-keys, the knob and cursor keys or a combination of these.

Example 1: Press the SQUARE key to select square-wave then press the **Duty** soft-key to select the square-wave duty cycle parameter which will show in the Edit Box. Now use the numeric keys and Soft-keys to change the parameter as described in Numeric Editing 6.5.

Example 2: Press the SINE key to select sinewave then press the MOD key to access modulation parameters. Press the **Type** soft-key to select the modulation type parameter. Use the soft-keys to select the required type from **AM, FM, PM, ASK, FSK, SUM** or **BPSK**. Press the **Done** soft-key to exit **Type** menu. Press the **On/Off** soft-key to turn on modulation.

Example 3: Press the ARB key followed by the **Waves** soft-key. Now select one of the built in waveforms from the soft-keys. The Edit Box will show the loaded waveform.

6.7 Information, Warning and Error Messages

Three classes of message are displayed on the screen in a Pop-up Box.

INFORMATION messages are shown to inform the user of actions that are being taken, for example:

Please wait... the current settings are being saved

WARNING messages are shown when the entered setting causes some change which the user might not necessarily expect. For example:

With square-wave selected at 1MHz and a Duty cycle of 25%, select sinewave and change the frequency to 50 MHz. Then select square-wave again and the message **Duty cycle set to default 50%** will pop up.

ERROR messages are shown when an illegal setting is attempted, most generally a number outside the range of values permitted. In this case the entry is rejected and the parameter setting is left unchanged.

Examples are:

1. Entering a frequency of 10MHz for a ramp waveform. The error message **"Frequency / Period invalid for Ramp. Frequency Upper limit 5.00MHz. Period lower limit 200.00ns"** is shown.
2. Entering a sinewave amplitude of 25Vpp. The error message **"Invalid entry. Amplitude Upper limit 10.000 Vpp"** is shown
3. Entering a DC offset of 20V on a sinewave with an amplitude of 1.000 Vpp. The error message **"Invalid entry. Offset Upper limit 4.500 Vdc"** is shown.

The messages are shown on the display for approximately four seconds; however, pressing any key will immediately remove the Pop-up Box and execute the function of the key which is pressed. The last two messages can be viewed again by pressing the **UTILITY**, then **Help** key and selecting the first or second entries from the Help menu, see 'Help Operations' section 17.6 for more information.

Each warning and error message is accompanied by a beep. The beep may be enabled or disabled in the **UTILITY** menu, under **System**. See 'Beep State' section 17.1.2 for more information.

6.8 General Soft-Keys

↵ often appears when editing and it always perform the same function. The ↵ key is known as **BACK** and will move the soft-key labels and Edit Box up one level in the hierarchy.

The ➡ soft-key indicates that there are more options to show, press this key to show them. In this case there is one more list of options which will show when the ➡ soft-key is pressed. One more press of the ➡ soft-key will show the first list again.

The **Done** key will move back to the top level in the hierarchy.



When a soft key features a white triangle, successive presses will give further options.

6.9 Maintenance

The Manufacturers or their agents overseas will provide a repair service for any unit developing a fault. Where owners wish to undertake their own maintenance work, this should only be done by skilled personnel in conjunction with the service guide which may be obtained directly from the Manufacturers or their agents overseas.

6.9.1 Cleaning

If the instrument requires cleaning use a cloth that is only lightly dampened with water or a mild detergent.

WARNING! TO AVOID ELECTRIC SHOCK, OR DAMAGE TO THE INSTRUMENT, NEVER ALLOW WATER TO GET INSIDE THE CASE. TO AVOID DAMAGE TO THE CASE NEVER CLEAN WITH SOLVENTS.

7. Continuous Carrier Waveform Operation

The instrument can generate seven types of carrier waveform: sine, square, ramp, pulse, noise, PRBS and arbitrary.

This section deals with the use of the instrument as a simple function generator, i.e. generating sine, square, ramp and arbitrary waveforms continuously with no modulation.

7.1 Waveform Selection

Pressing any of the carrier waveform keys, SINE, SQUARE, RAMP or ARB, will immediately switch to that waveform making it available at the MAIN OUT connector if the output is on, indicated by the OUTPUT key glowing green. If the output is not on press the OUTPUT key to turn output on.

The screen below shows the effect of pressing the RAMP key.

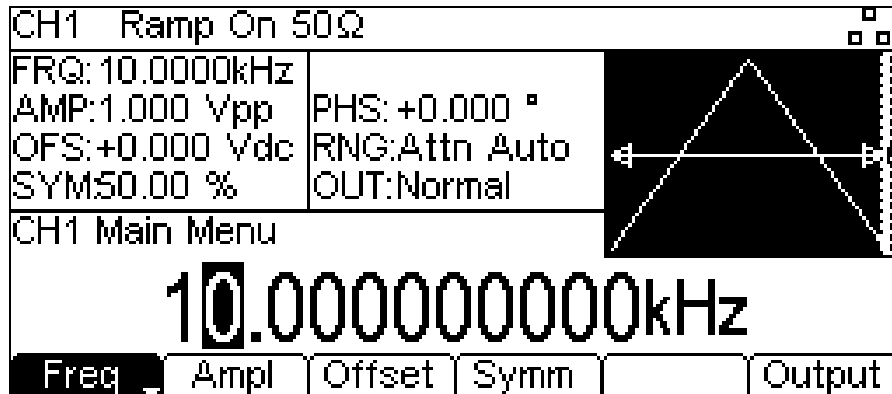

The RAMP key now glows green, the Waveform field in the Status line shows **Ramp** and the Graph Box has changed to show the ramp waveform.

7.2 Waveform editing

7.2.1 Frequency

Pressing the **Freq** soft-key while it is highlighted will change the label to **Period** and time units will be used to edit the parameter.

NOTE: The upper frequency limits vary for the different waveform types; see 'Specifications' section 3 for details.

7.2.2 Amplitude

Press SINE key to return to a sine wave. Pressing the **Ampl** soft-key shows the amplitude parameter in the Edit Box and the Graph Box changes to show that amplitude is being edited.

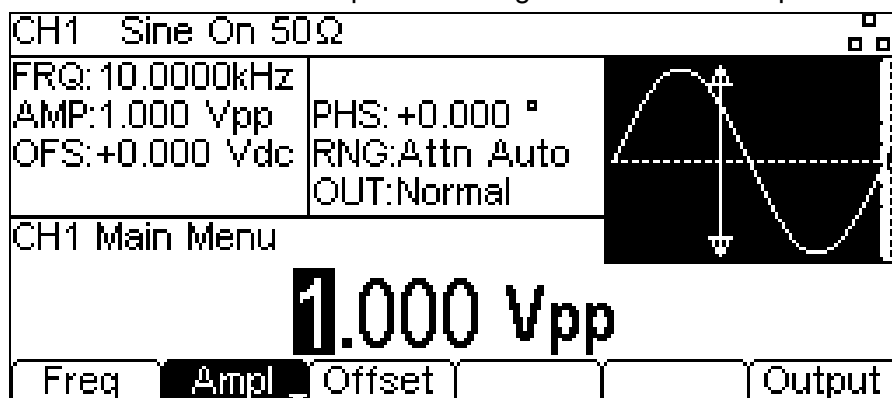

The amplitude can be set in terms of peak-to-peak Volts (Vpp). The level can be set assuming that the output is either open-circuit or terminated.

NOTE: The actual generator output impedance is always 50Ω; the displayed amplitude values for other load values take this into account.

7.2.3 DC Offset

Pressing the **Offset** soft-key shows the dc offset parameter in the Edit Box and the Graph Box changes to show that offset is being edited.

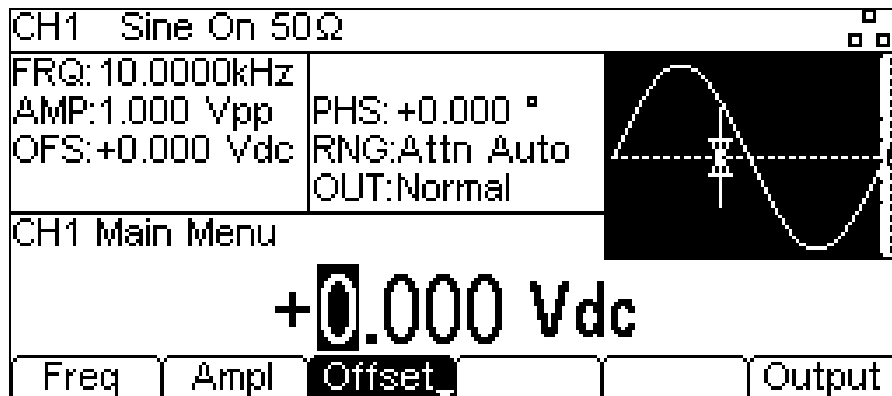

7.2.3.1 High Level and Low Level

The instrument allows the amplitude and offset parameters to be entered in terms of high level and low level. Pressing either the **Ampl** or **Offset** soft-key while it is highlighted will switch the mode from amplitude/offset to high/low level. To return to amplitude/offset mode press the highlighted **HiLvl** or **LoLvl** soft-key.

With high/low level mode selected the Edit Box shows the parameter, the Parameters Box shows **HIL** and **LOL** in place of **AMP** and **OFS** and the Graph Box changes to show the parameter which is being edited.

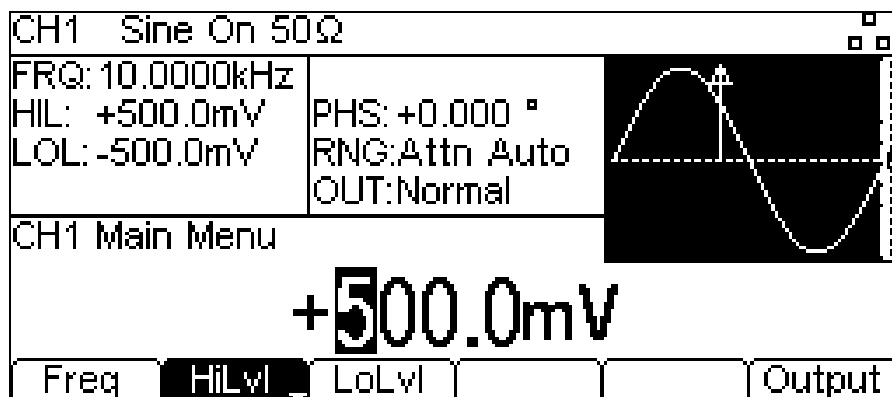

7.3 Square-wave Duty Cycle

With square-wave as the selected waveform pressing the **Duty** soft-key shows the duty cycle parameter in the Edit Box and the Graph Box changes to show that duty cycle is being edited.

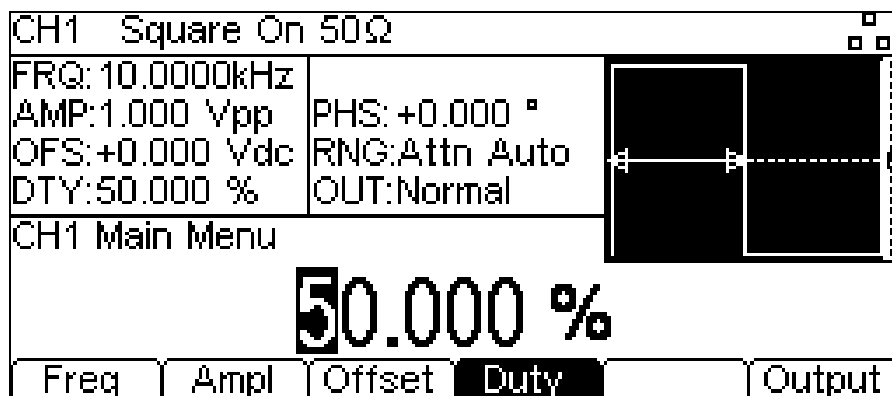

7.4 Ramp Symmetry

With ramp as the selected waveform pressing the **Symm** soft-key shows the symmetry parameter in the Edit Box. The Ramp waveform in the Graph Box changes to show that symmetry is being edited.

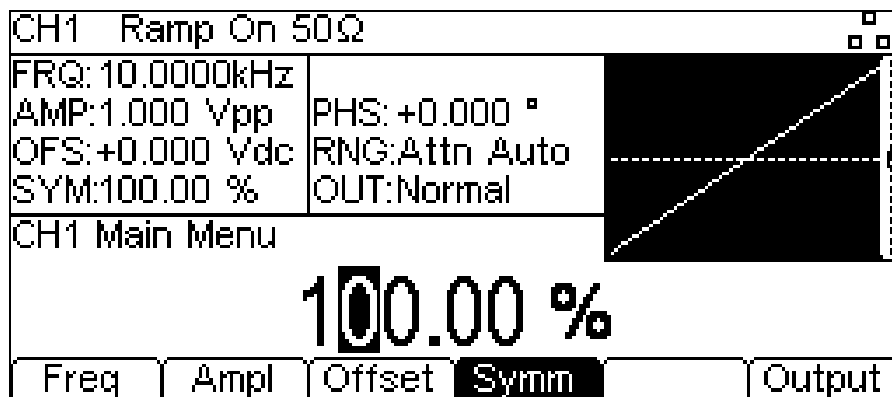

NOTE: To produce a triangle waveform set the symmetry to 50%.

7.5 Output

Pressing the **Output** soft-key allows access to control the output parameters.

7.5.1 Phase

In the **Output** menu, press the **Phase** soft-key to change the start phase of the waveform. The phase parameter will appear in the Edit Box.

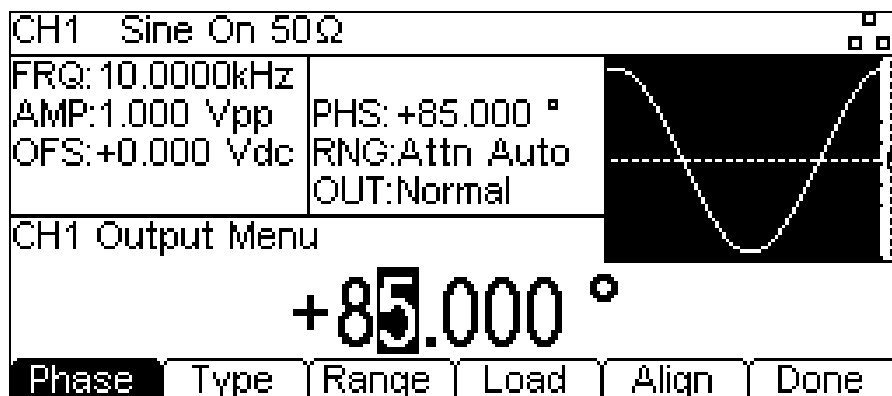

The setting may be used to determine the phase difference between the two channels or between channel 1 waveform and its carrier sync. The channels may be phase aligned by pressing the **Align** soft-key. The Phase parameter is also used to set Burst Phase.

7.5.2 Output Type

Pressing the **Type** soft-key on the **Output** menu will alternate between **Normal** and **Inverse**.

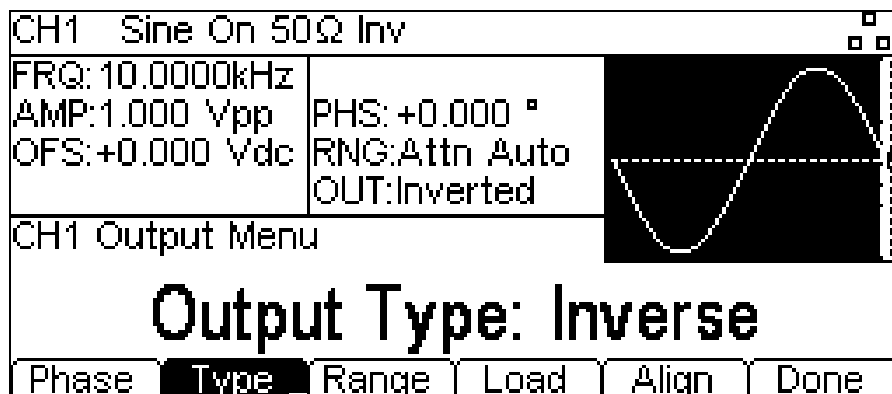

Inverse will invert the carrier waveform at the MAIN OUT connector. This is shown by **Inv** in the Status Line and the carrier waveform in the Graph Box will be inverted.

7.5.3 Range

Pressing the **Range** soft-key will alternate between **Auto** and **Hold**.

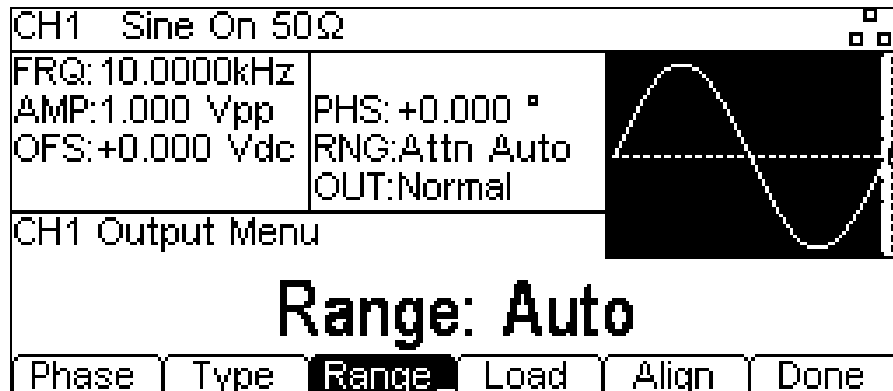

The instrument, by default, is in **Auto** mode; it auto-ranges in 6dB attenuator steps (i.e. 'range' maximums of 10Vpp, 5Vpp, 2.5Vpp, etc., into 50Ω), with the amplitude vernier range limited to 6dB to maintain waveform quality. Selecting **Hold** mode disables auto-ranging; the attenuator setting is fixed and the amplitude vernier range is no longer limited. This can be useful in eliminating momentary disruptions in the output waveform in Auto mode caused by the switching of the attenuators while changing the amplitude around an attenuator change point. However, waveform quality will start to deteriorate when the optimum 6dB operating range of the amplitude vernier is exceeded.

With range set to **Auto** the amplitude and attenuators will switch automatically and optimal performance will be realised. With range set to **Hold** a fixed attenuator setting is used for all amplitude settings. The **Range** field in the Parameters Box will show **AttHld** while range is held.

7.5.4 Load

Pressing the **Load** soft-key will show the current load value in the Edit Box.

This is the value that is assumed to be loading at the instrument MAIN OUT connector. The value is used to calculate the actual values of amplitude and dc offset. Note that the output impedance of the instrument MAIN OUT connector is fixed at 50Ω.

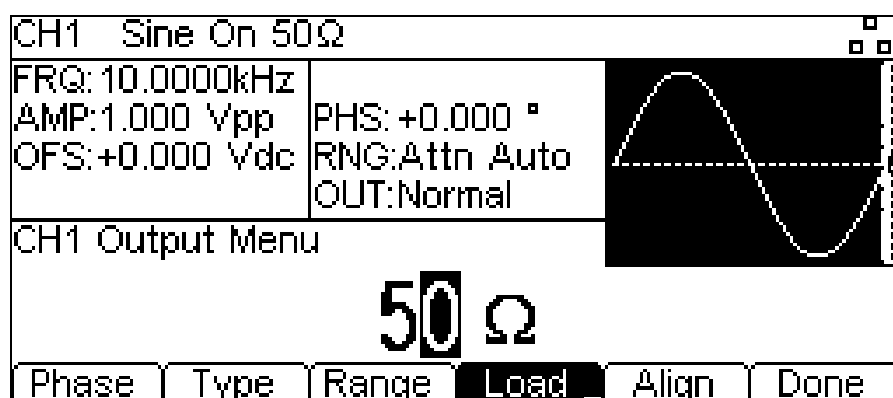

Pressing the **Load** soft-key will alternate between **High-Z** and the last value entered. With **High-Z** selected the load impedance will be assumed infinite.

Press the **Done** soft-key to return to the top level waveform menu.

7.6 Arb Waves

The instrument contains a total of sixteen arbitrary waveforms, Twelve fixed:

Exponential Rise (**ExpRis**), Exponential Fall (**ExpFal**), Logarithmic Rise (**LogRis**), Logarithmic Fall (**LogFal**), Sinc (**Sinc**), Gaussian (**Gauss**), Lorentz (**Lrntz**), D-Lorentz (**DLrntz**), HaverSine (**HvrSin**), Cardiac (**Crdiac**), DC (**DC**), & Triangle (**Triang**) and four user defined.

There are more waveforms available on the supplied CD.

With arb as the selected waveform, pressing the **Waves** soft-key switches to the Arb **Waves** menu. The name of the selected arb is shown in the Edit Box and the Graph Box shows the arb waveform.

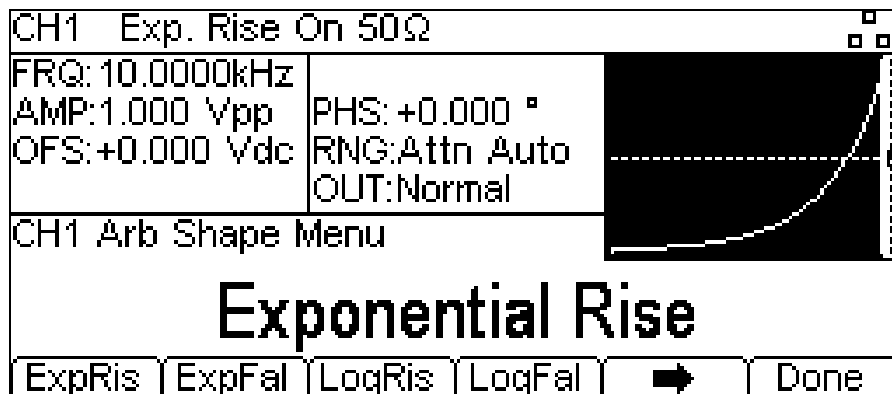

The soft-keys allow access to all of the arbitrary waveforms in the instrument.

To select an arbitrary waveform press the appropriate soft-key.

Pressing the **DC** soft-key produces a dc only waveform at the MAIN OUT connector. The screen shows the result of pressing the **ARB** key with **DC** as the selected waveform.

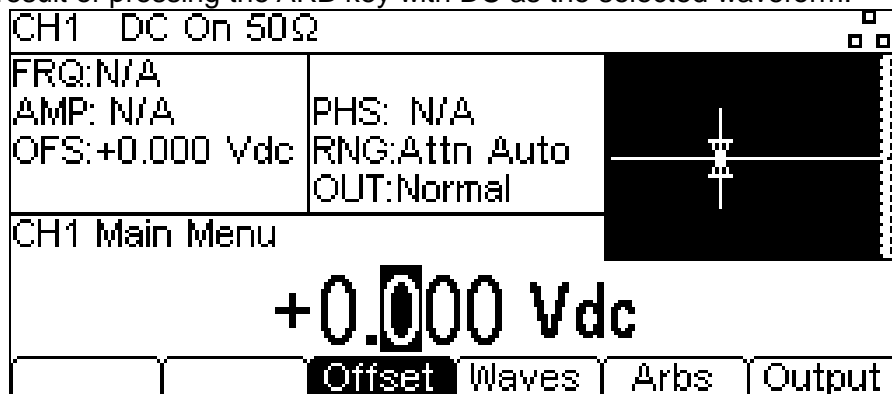

The Status line shows **DC** in the Waveform field, the Graph Box shows a dc waveform with dc offset arrows and the Edit Box contains the dc voltage menu.

7.7 Arb Arbs

With arb as the selected waveform, pressing the **Arbs** soft-key switches to the **Arb Arbs** menu.



Pressing the **Load** soft-key opens the load sub-menu.

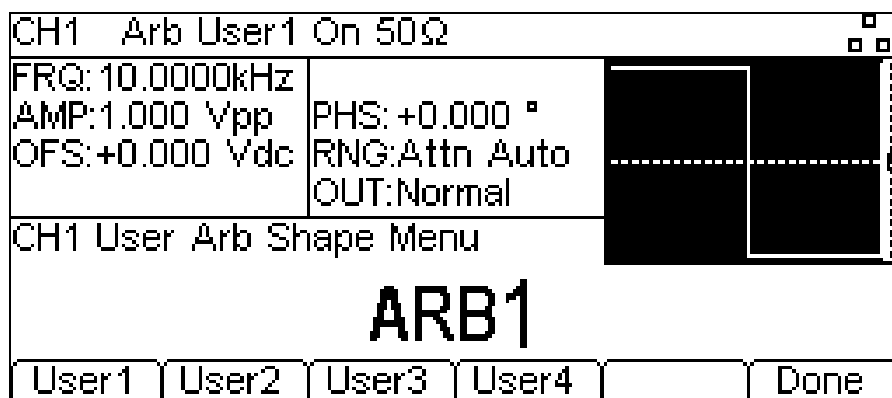

The four soft-keys **User1** through **User4** allows direct access to the user-defined arbitrary waveforms in the instrument. To select an arbitrary waveform press the appropriate soft-key. Press the **Done** soft-key to return to the top level **Arb** menu.

7.7.1 Editing Arbs

Pressing the **Arbs** soft-key and then **Edit** soft-key opens the edit sub-menu.

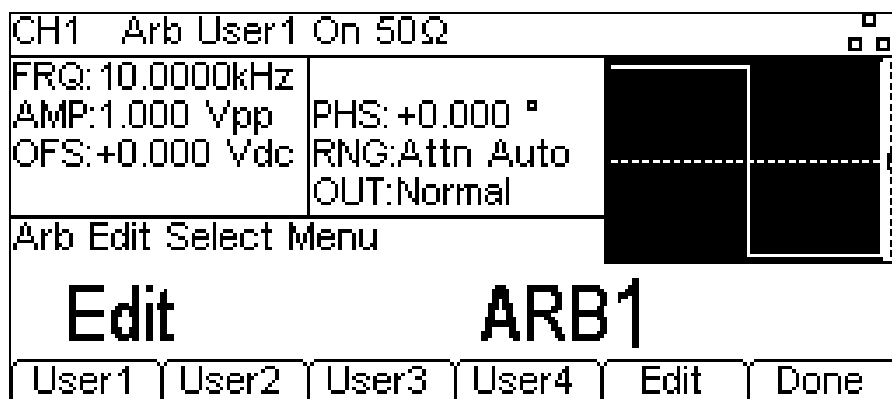

The instrument is capable of performing simple editing of stored arbitrary waveforms. For more complex editing and creation of waveforms see the Waveform Manager Plus V4.11 Windows application supplied on the CD.

The name of the arb selected for editing is shown in the Edit Box. To select an arbitrary waveform for editing press the appropriate soft-key.

The selected waveform is edited by pressing the **Edit** soft-key. For a full description of the editing capabilities see 'Editing Arbitrary Waveforms' section 7.6. Press the **Done** soft-key to return to the top level **Arb** menu.

7.7.2 Harmonics

Pressing the **Arbs** soft-key and then **Harmonic** soft-key opens the harmonic waveform sub-menu.

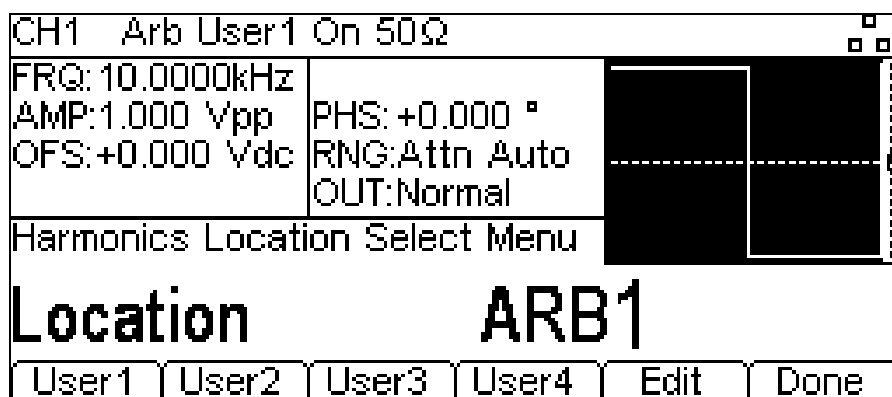

The instrument is capable of creating waveforms by the addition of sine wave harmonics. Up to 16 harmonics can be used, chosen from up to the 50th order. The amplitude and phase can be individually set for each harmonic. Harmonic waveforms can also be created or edited in the Waveform Manager Plus V4.11 Windows application supplied on the CD.

The created harmonic waveform will be stored in one of the four user-defined arbitrary waveform locations. The name of the arb selected for storing the harmonic waveform is shown in the Edit Box. To select an arbitrary waveform location for storing the harmonic waveform press the appropriate soft-key. For a full description of the harmonic waveform capabilities see the Harmonic Waveforms section.

NOTE: Any previous waveform stored in the same location will be erased.

Press the **Done** soft-key to return to the top level **Arb** menu.

7.7.3 Filter

Pressing the **Arbs** soft-key and then **Filter** soft-key opens the arbitrary waveform filter menu.

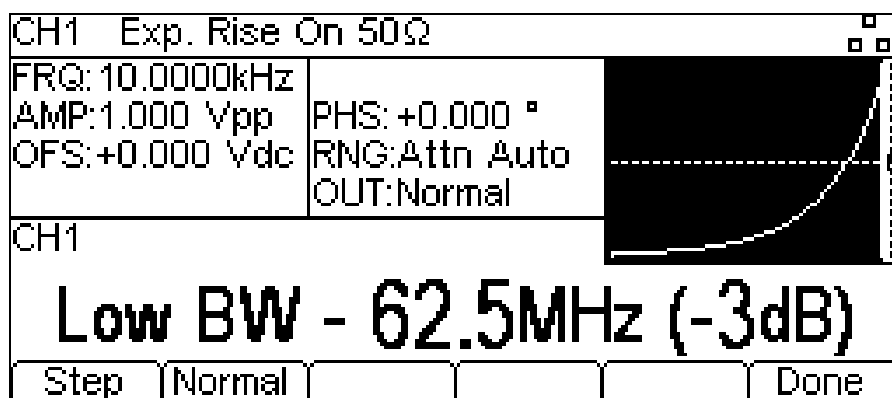

The instrument includes two filters to smooth transitions between points as arbitrary waveforms are generated. The Step filter has a nearly ideal step response, but with more roll-off in its frequency response than the Normal filter. The Normal filter has a wide, flat frequency response, but its step response exhibits overshoot and ringing.

The current filter band-width is shown in the Edit Box. To select between the two available filters press the appropriate soft-key.

Press the **Done** soft-key to return to the top level **Arb** menu.

7.8 Sync Output

Channel 2 can be configured to output Channel 1 sync from its MAIN OUT 2 socket. Sync is a multi function output which is automatically selected based on the current instrument set-up. Alternatively, user can choose Sync to always be carrier referenced, to output the currently used trigger signal or turn it off.

- **Carrier Sync :** A square wave at the same frequency as the carrier waveform. Available for all waveforms except Noise.
- **Modulation Sync:** A square-wave at the same frequency as the internal modulation waveform with a duty of 50%. Not available for external modulation.
- **Sweep Sync:** A square wave at the sweep rate.
- **Burst Sync :** A square wave coincident with a burst output.
- **Trigger :** A buffered version of the Trigger signal .

The selection of the signals themselves and configuration of channel 2 as channel 1 sync is discussed in the Utility menu. By default the automatic selection is enabled which will choose the most relevant output for the instrument set-up. However, it is possible to override the automatic setting. See 'Utility menu' 17 for more information.

8. Pulse Generator

The pulse generator can produce a wide range of pulses with adjustable period, width, and edge speed. It may also be set in Gated or Burst mode, or modulated using PWM; for more information see 'Modulation' section 11 and 'Burst' section 13.

Each channel has an independent pulse generator. These may be set to any combination of period, width and modulation or burst. However, when the channels are linked by one of the dual-channel functions there are some restrictions between the parameters of the two channels; see the Dual-Channel Operations in 'Specification' section 3 for details.

Pressing the PULSE carrier waveform key will switch to the pulse waveform. The screen below shows the effect of pressing the PULSE key.

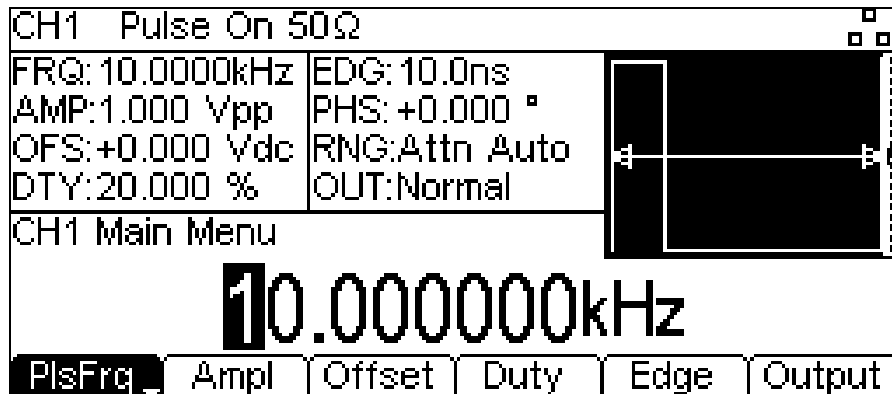

The **PlsFrq** soft-key allows setting of the pulse frequency. Pressing the key while it is highlighted will change it to **PlsPer** and the pulse period may be entered. The pulse generator uses its own value for pulse frequency/pulse period. Changing it will not affect the frequency/period value of the other carrier waveforms.

Amplitude and dc offset are adjusted in the same way as for sinewaves and they may also be set in terms of high level and low level.

Pressing the **Duty/Width** soft-key allows the pulse duty or width to be set as shown below.

8.1 Pulse Width

Pressing the **Duty** soft-key while it is highlighted will show the Width parameter in the Edit Box and the Graph Box changes to show that width is being edited.

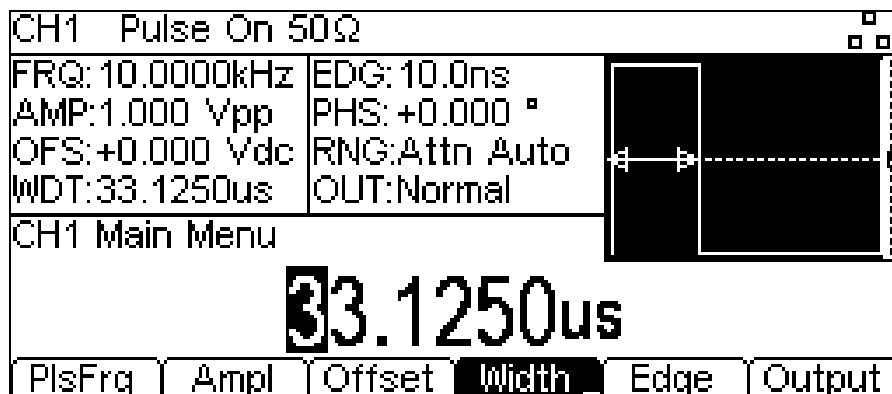

Pressing the **Width** soft-key while it is highlighted will change it to **Duty** and the duty cycle may be changed in terms of the percentage of the pulse period.

8.2 Edge Times

Pressing the **Edge** soft-key shows the edge parameter in the Edit Box and the Graph Box changes to show that edge is being edited. Note that the edges are always coupled and will be adjusted together.

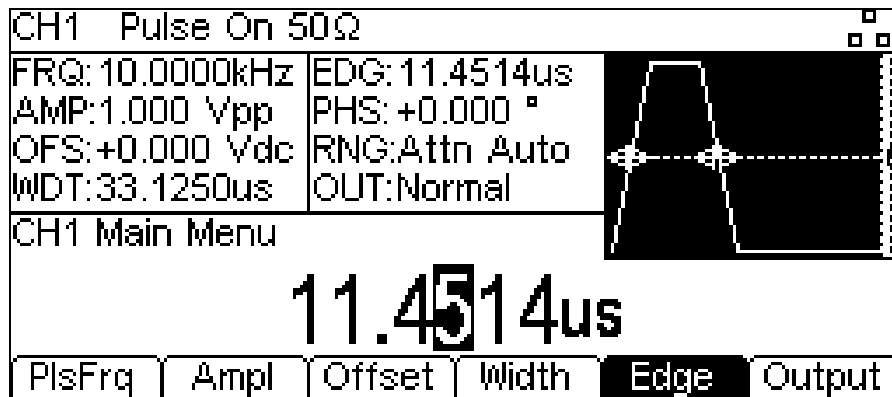

9. Noise Generator

The instrument contains a wide-band Gaussian white noise generator for each channel which may be used in the following ways:

- As the main output from the carrier wave generator
- As a modulating waveform
- Added as a percentage to the current output waveform using SUM modulation.

These options are described in the following sections. In dual channel mode there are some restrictions on Noise; see 'Dual-Channel Operations' in Specification section 3 for details.

9.1 Carrier Wave Noise

Pressing the NOISE/PRBS key will switch to the Noise/PRBS function and show the screen below.

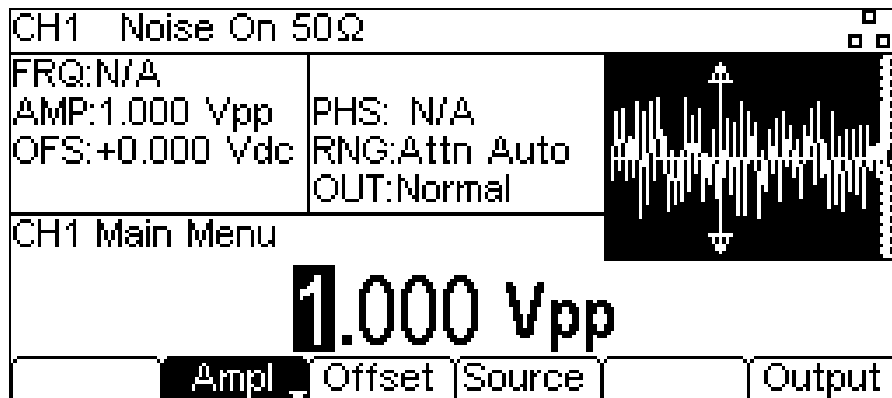

It is possible to edit these parameters in terms of high level and low level by pressing the **Ampl** key.

Pressing the **source** soft-key shows the following and allows either noise or the PRBS function to be selected. Press **Noise** to select the Noise function. Press **Done** to exit the **Source** menu.

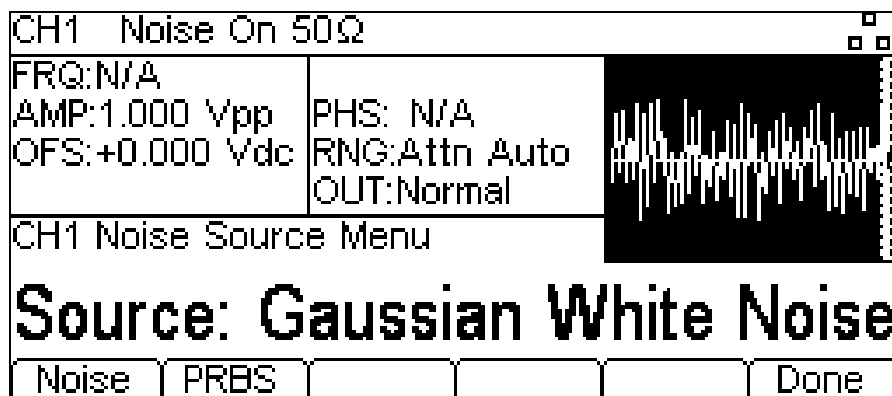

9.2 Noise Modulation

Noise may be used as a modulation shape in the same way as sine or ramp etc. Noise can also be used as a carrier wave for amplitude and sum modulation and for amplitude shift keying. See 'Modulation' section 11 for more information.

10. PRBS Generator

The instrument contains a PRBS (Pseudo Random Binary Sequence) generator for each channel which may be used in the following ways:

- As the main output from the carrier wave generator
- As a modulating waveform

These options are described in the following sections. In dual channel mode there are some restrictions on PRBS; see Dual-Channel Operations in 'Specification' setion 3 for details.

10.1 Carrier Wave PRBS

Pressing the Noise/PRBS key will switch to the Noise/PRBS function.

Pressing the **Source** soft-key shows the following. Press **PRBS** to select the PRBS function. Press **Done** to exit the **Source** menu.

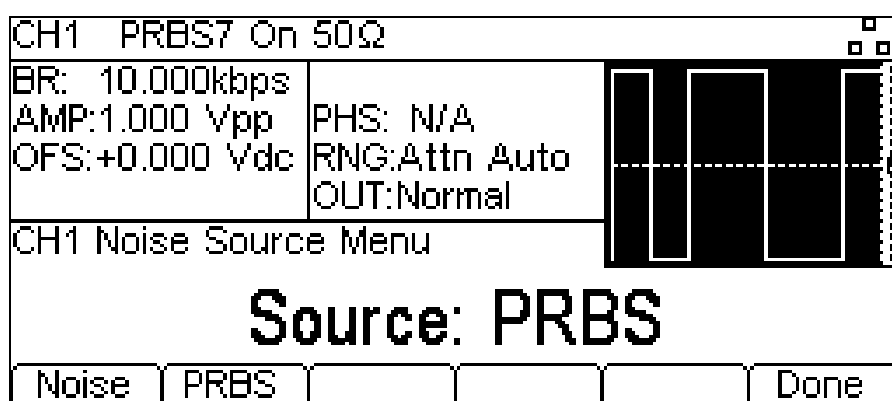

Press the **Type** soft-key to set PRBS type. The soft-keys **PN7**, **PN9**, **PN11**, **PN15**, **PN20**, **PN23**, **PN29** and **PN31** set the number of bits used to generate the PRBS.

Choosing a PRBS type and pressing the **Done** soft-key shows the PRBS edit menu.

Use the **Bit Rate** soft-key to set the rate at which the PRBS generator is clocked.

Use the **Ampl** and **Offset** soft-keys to set these parameters as for any other carrier wave.

10.2 PRBS Modulation

PRBS may be modulated or used as a modulation shape in the same way as sine or ramp, etc. See 'Modulation' section 11 for more information.

11. Modulation

The instrument can apply nine types of modulation:

- AM (Amplitude Modulation),
- AM-SC (Amplitude Modulation – Suppressed Carrier),
- FM (Frequency Modulation),
- PM (Phase Modulation),
- PWM (Pulse Width Modulation),
- BPSK (Binary Phase Shift Keying),
- SUM (Carrier plus Modulating signal),
- ASK (Amplitude Shift Keying) and
- FSK (Frequency Shift Keying).

NOTE: Only one modulation type may be applied at any one time.

NOTE: Not all modulation types can be applied to a selected carrier waveform.

For example, PWM cannot be applied to sine or FM cannot be applied to noise. However, sine and noise may be used as the modulation shape for any type of modulation except FSK.

Pressing the MOD key will allow access to control the modulation parameters. Pressing the **On/Off** soft-key will apply the currently selected modulation to the currently selected carrier waveform and the MOD key will glow orange.

The screen below shows the effect of pressing the **On/Off** soft-key when Sine is the selected waveform, Internal is the selected (default) source and the selected modulation type is AM.

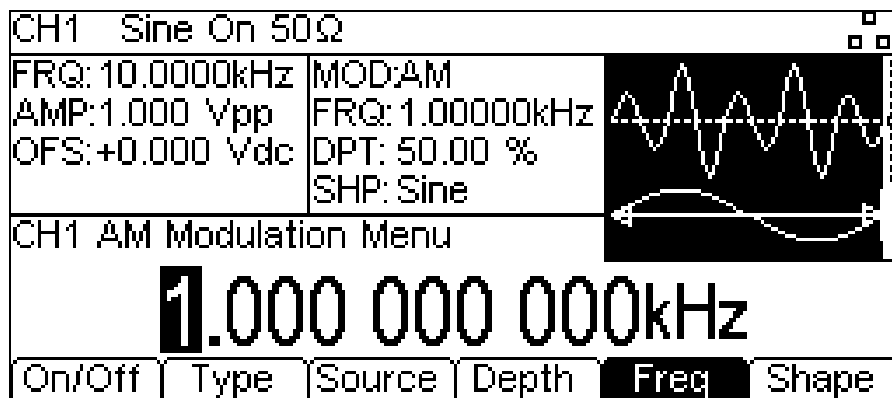

The Parameters Box on the right hand side now shows **AM** in the **MOD** field and the current modulation parameters of **FRQ**, **DPT** and **SHP**. The Graph Box shows the modulating waveform below a representation of the modulated carrier waveform.

To change the carrier waveform parameters press the highlighted carrier waveform key, notice that **AM** still shows in the **MOD** field of the Parameters Box and the MOD key still glows orange indicating that modulation is still active. To return to the modulation menu to edit the modulation parameters press the MOD key again. To turn off modulation press the **On/Off** soft-key in the modulation menu.

11.1 AM

To select AM press the MOD key to access the modulation menu and then press the **Type** soft-key to show the display below.

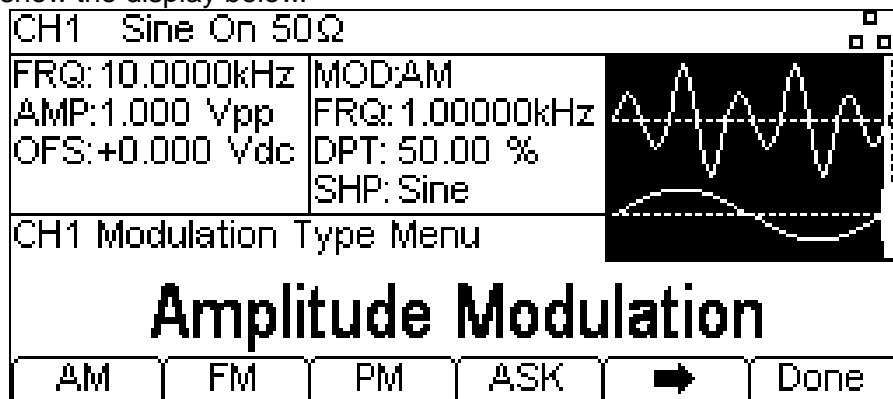

The soft-keys present all of the available modulation types **AM**, **FM**, **PM**, **ASK**, **FSK**, **BPSK**, **SUM** & **PWM**

If **AM** is not already selected press the **AM** soft-key to access the amplitude modulation sub-menu.

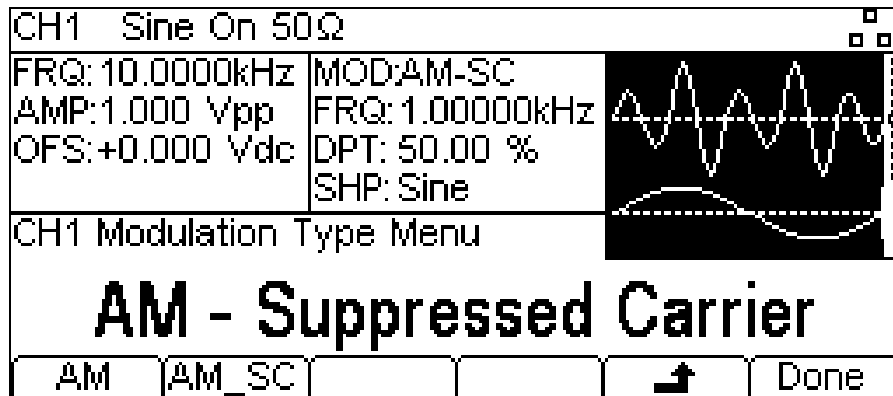

The instrument support two types of amplitude modulation, 'normal' and double sideband suppressed carrier. In suppressed carrier amplitude modulation, the carrier is not present unless the modulating signal has an amplitude greater than zero.

Select from the two types of amplitude modulation and then press **↵** soft-key.

Press the **Done** key to return to the top level modulation menu.

To select the modulation source press the **Source** soft-key. The options are **Internal** or **External**. Internal will use the waveform specified in the shape parameter and the Graph Box will show that shape as the modulating waveform. External will use the signal present at the MOD IN connector and the **Freq** and **Shape** soft-keys will disappear. The Graph Box will always show a sinewave as the modulating waveform if the source is set to External.

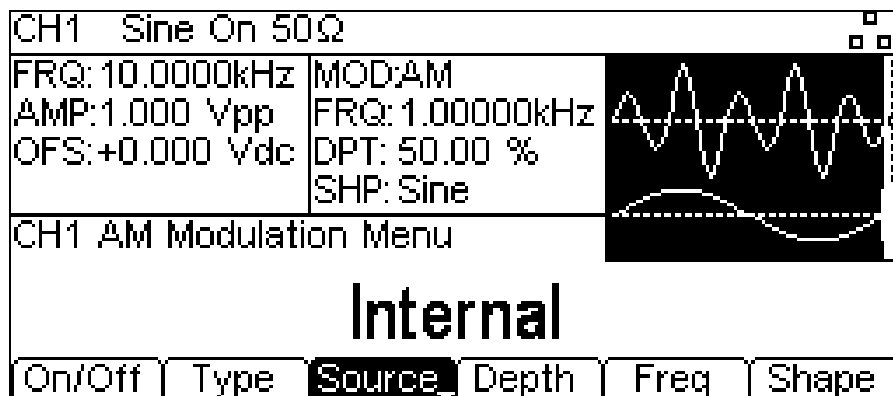

To set the modulation depth press the **Depth** soft-key. The Depth parameter will appear in the Edit Box and the modulating waveform in the Graph Box will show that depth is being edited.

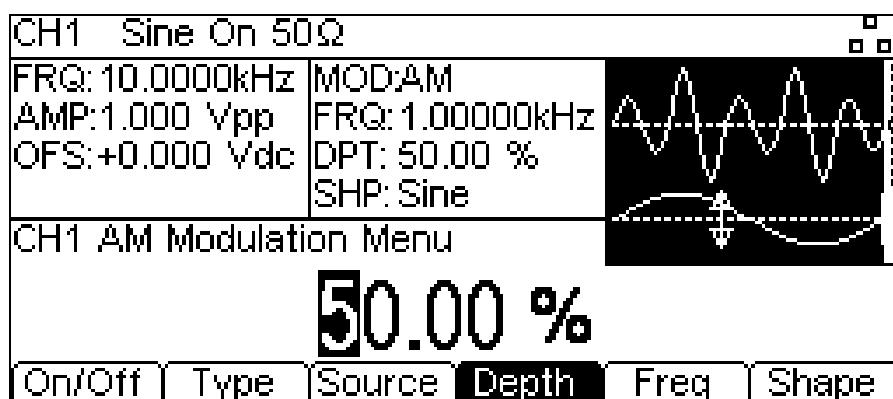

To set the modulation frequency press the **Freq** soft-key. The frequency parameter will appear in the Edit Box and the modulating waveform in the Graph Box will show that frequency is being edited.

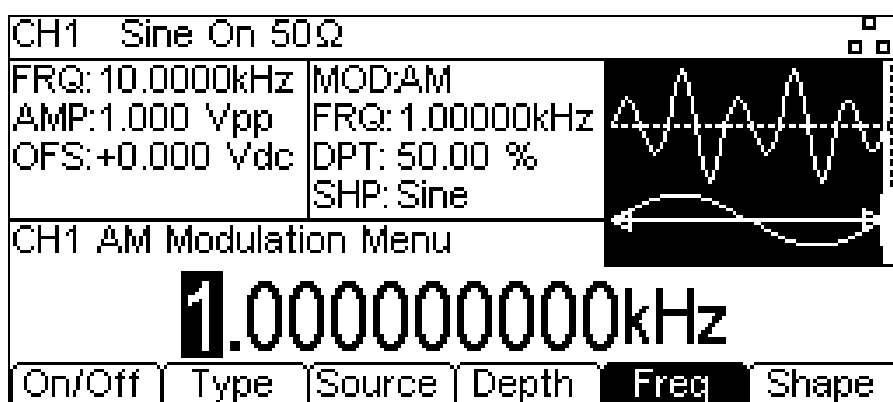

To set the modulation shape press the **Shape** soft-key. The currently selected shape will appear in the Edit Box and the soft-keys will change to a list of shapes available.

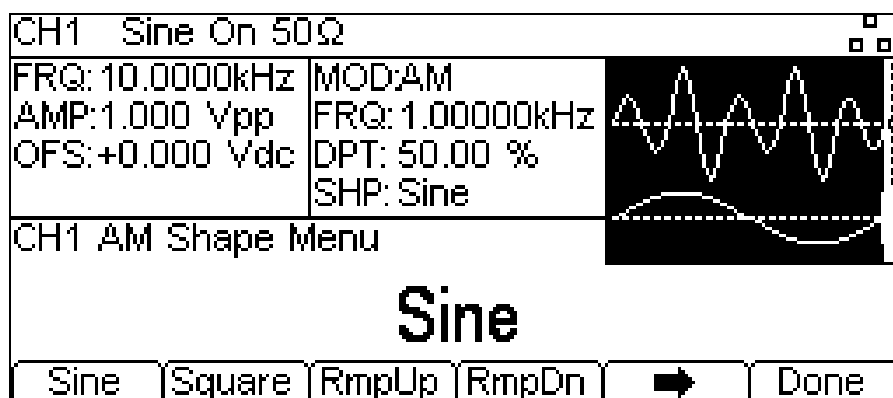

Select the modulation shape required by pressing the appropriate key then press the **Done** soft-key to return to the top level modulation menu. All the parameters for AM are now set. If not already on, Press the **On/Off** soft-key to turn on modulation.

11.2 FM

To select FM press the MOD key to access the modulation menu and then press the **Type** soft-key to show the display below.

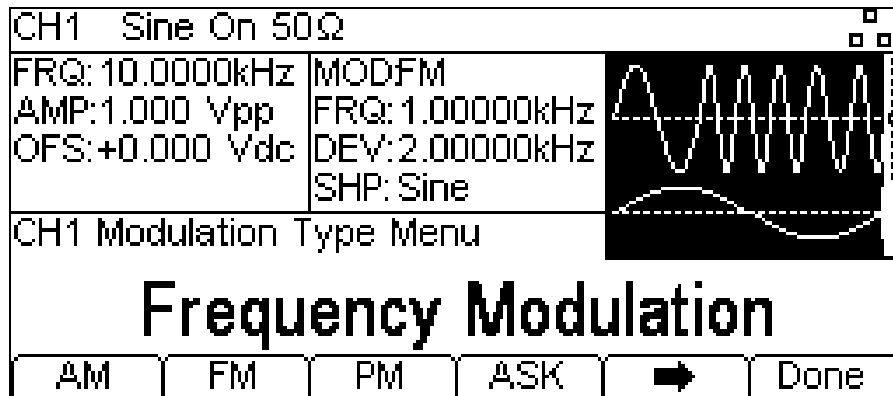

The soft-keys present all of the available modulation types.

If **FM** is not already selected press the **FM** soft-key followed by the **Done** key to return to the top level modulation menu.

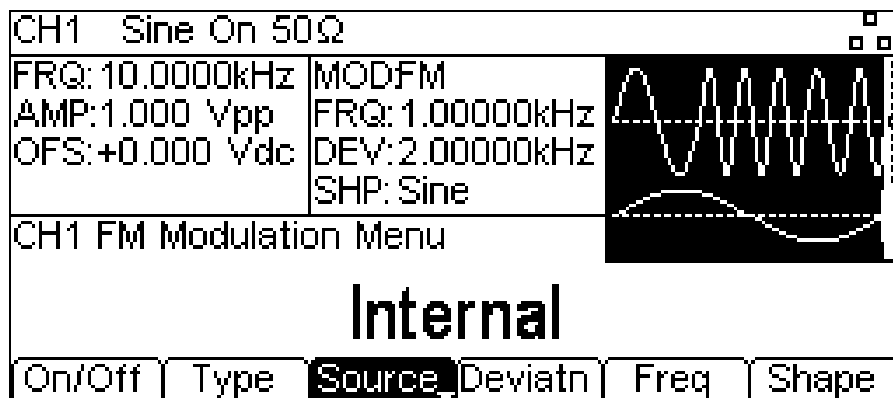

To select the modulation source press the **Source** soft-key. The options are **Internal** or **External**. Internal will use the waveform specified in the shape parameter and the Graph Box will show that shape as the modulating waveform. External will use the signal present at the MOD IN connector and the **Freq** and **Shape** soft-keys will disappear. The Graph Box will always show a sinewave as the modulating waveform if the source is set to External.

To set the frequency deviation press the **Deviatn** soft-key. The deviation parameter will appear in the Edit Box and the modulating waveform in the Graph Box will show that deviation is being edited.

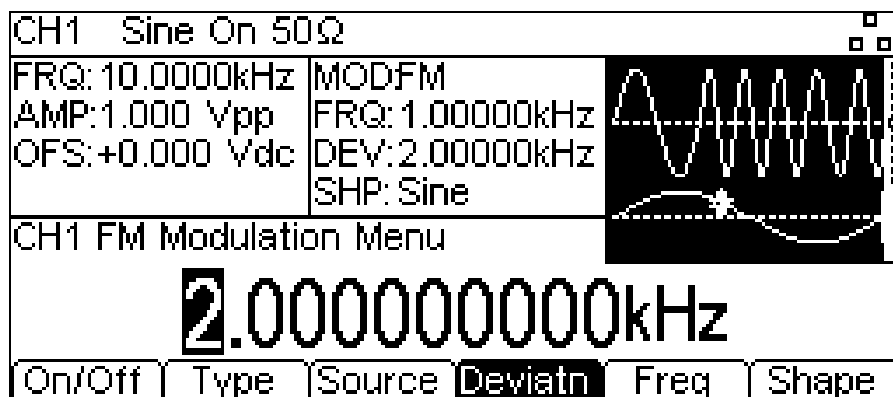

To set the modulation frequency press the **Freq** soft-key. The frequency parameter will appear in the Edit Box and the modulating waveform in the Graph Box will show that frequency is being edited.

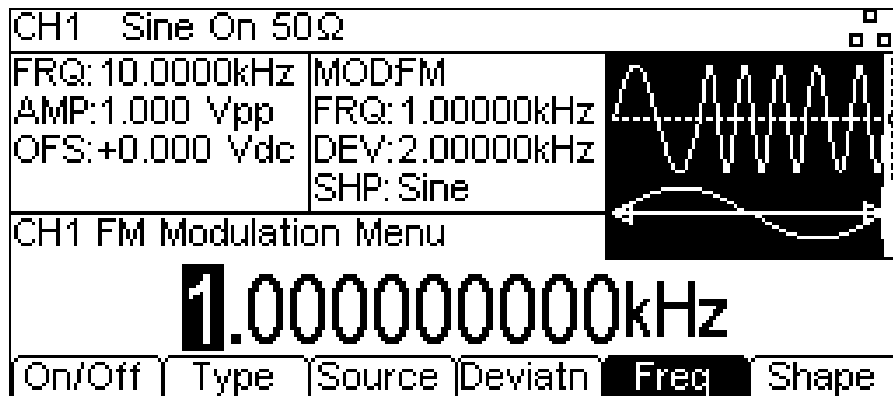

To set the modulation shape press the **Shape** soft-key. The currently selected shape will appear in the Edit Box and the soft-keys will change to a list of shapes available.

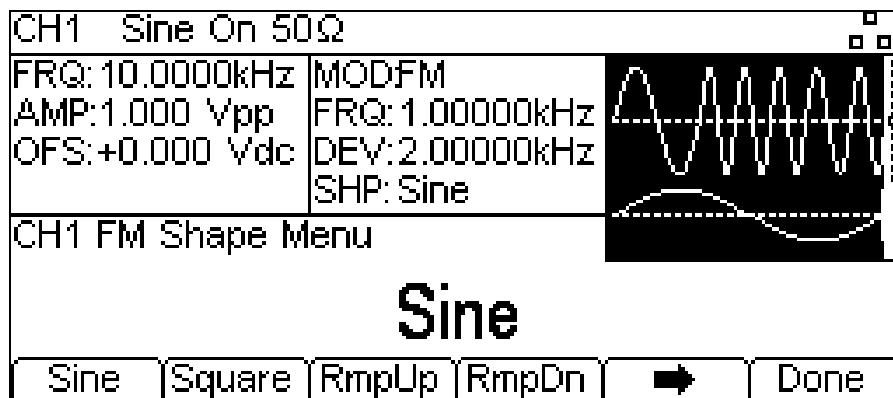

Select the modulation shape required by pressing the appropriate key then press the **Done** soft-key to return to the top level modulation menu.

All the parameters for FM are now set. If not already on, Press the **On/Off** soft-key to turn on modulation.

11.3 PM

To select PM press the MOD key to access the modulation menu and then press the **Type** soft-key to show the display below.

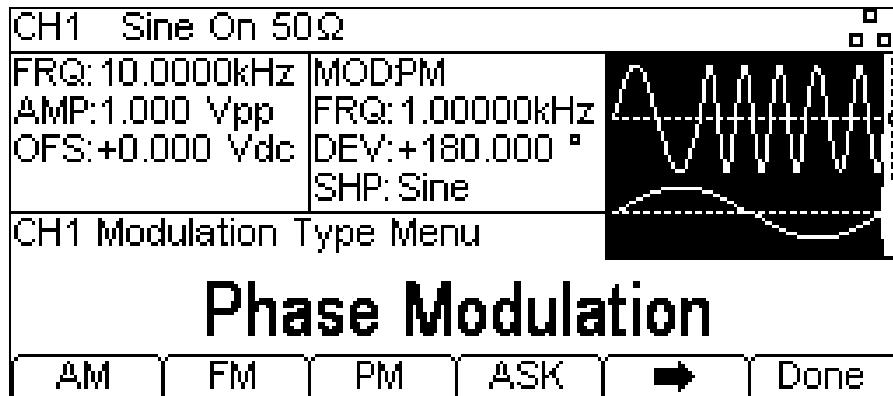

The soft-keys present all of the available modulation types.

If **PM** is not already selected press the **PM** soft-key followed by the **Done** key to return to the top level modulation menu.

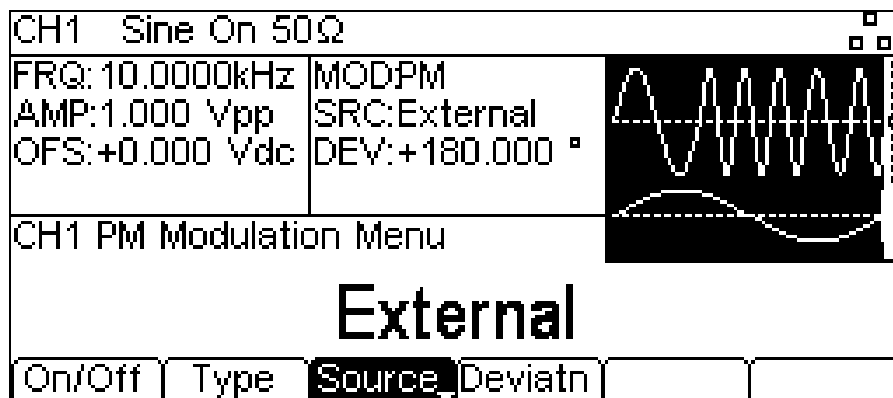

To select the modulation source press the **Source** soft-key. The options are **Internal** or **External**. Internal will use the waveform specified in the shape parameter and the Graph Box will show that shape as the modulating waveform. External will use the signal present at the MOD IN connector and the **Freq** and **Shape** soft-keys will disappear. The Graph Box will always show a sinewave as the modulating waveform if the source is set to External.

To set the phase deviation press the **Deviatn** soft-key. The deviation parameter will appear in the Edit Box and the modulating waveform in the Graph Box will show that deviation is being edited.

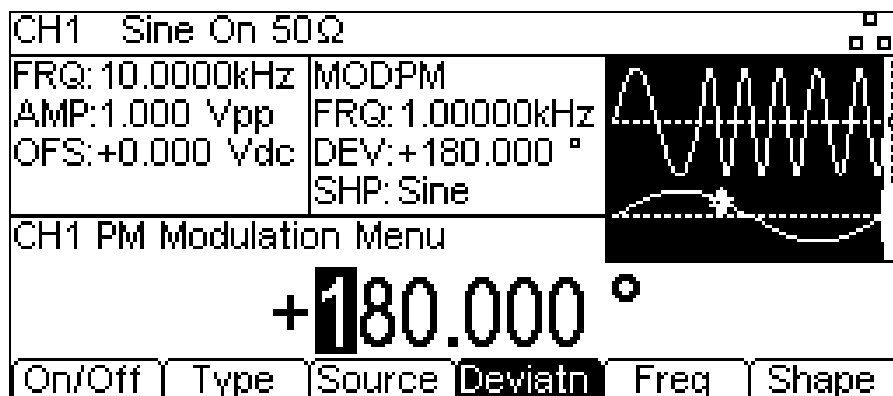

To set the modulation frequency press the **Freq** soft-key. The frequency parameter will appear in the Edit Box and the modulating waveform in the Graph Box will show that frequency is being edited.

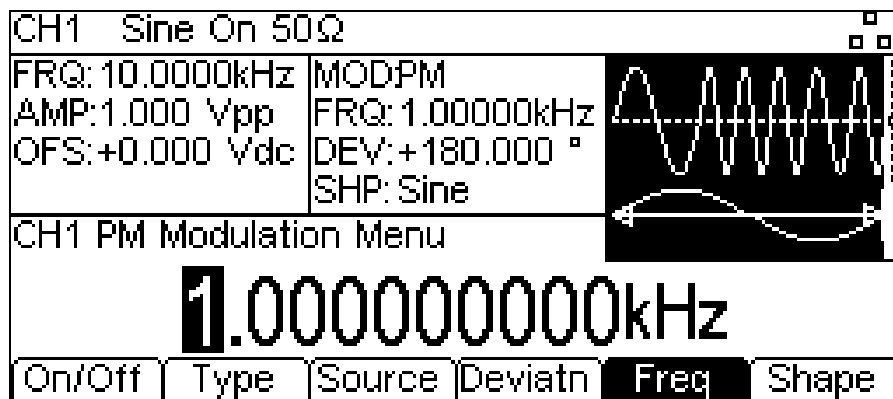

To set the modulation shape press the **Shape** soft-key. The currently selected shape will appear in the Edit Box and the soft-keys will change to a list of shapes available.

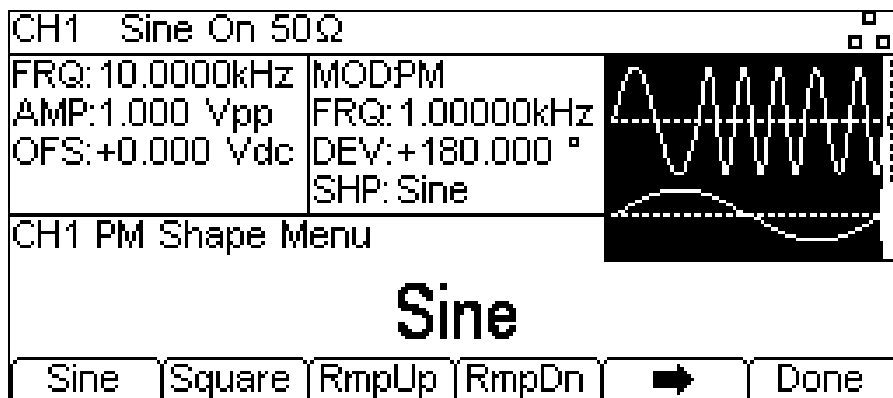

Select the modulation shape required by pressing the appropriate key then press the **Done** soft-key to return to the top level modulation menu.

All the parameters for PM are now set. If not already on, Press the **On/Off** soft-key to turn on modulation.

11.4 SUM

To select SUM press the MOD key to access the modulation menu and then press the **Type** soft-key to show the display below.

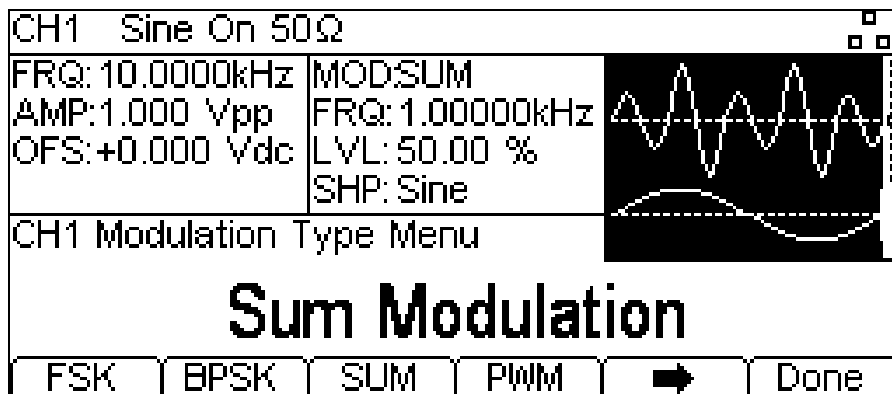

The soft-keys present all of the available modulation types.

If **SUM** is not already selected press the **SUM** soft-key followed by the **Done** key to return to the top level modulation menu.

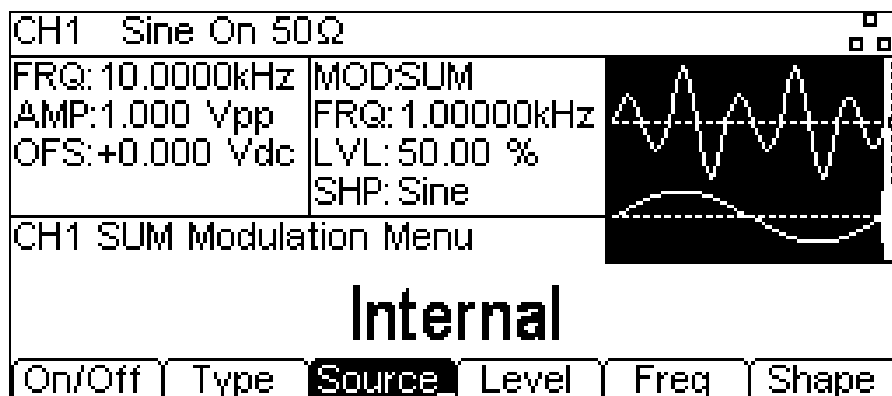

To select the modulation source press the **Source** soft-key. The options are **Internal** or **External**. Internal will use the waveform specified in the shape parameter and the Graph Box will show that shape as the modulating waveform. External will use the signal present at the MOD IN connector and the **Freq** and **Shape** soft-keys will disappear. The Graph Box will always show a sinewave as the modulating waveform if the source is set to External.

To set the modulation Level press the **Level** soft-key. The parameter will appear in the Edit Box and the modulating waveform in the Graph Box will show that Modulation Level is being edited.

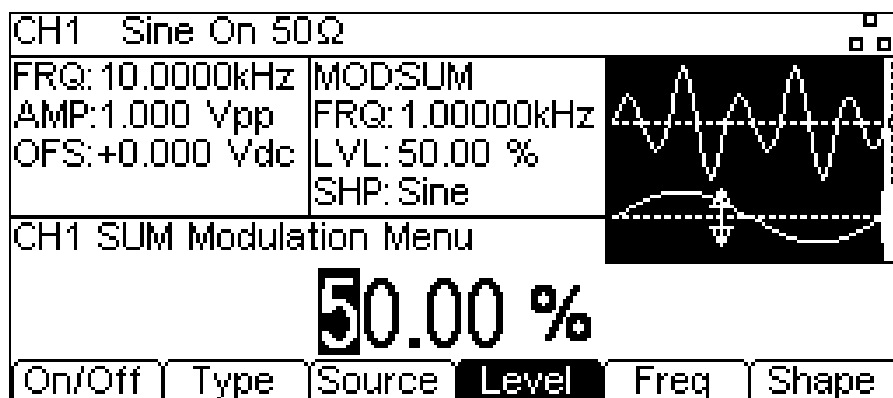

To set the modulation frequency press the **Freq** soft-key.

The frequency parameter will appear in the Edit Box and the modulating waveform in the Graph Box will show that frequency is being edited.

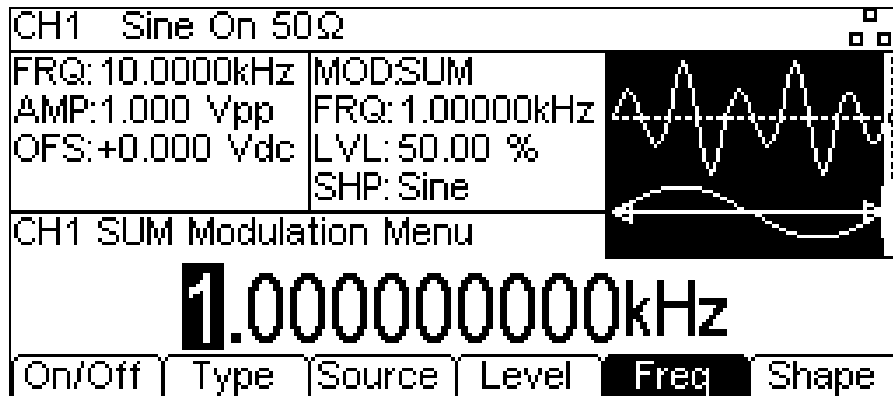

To set the modulation shape press the **Shape** soft-key. The currently selected shape will appear in the Edit Box and the soft-keys will change to a list of shapes available.

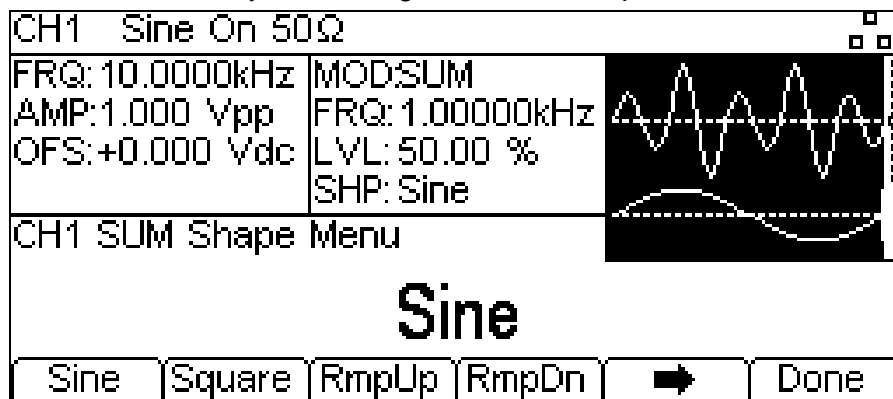

Select the modulation shape required by pressing the appropriate key then press the **Done** soft-key to return to the top level modulation menu.

All the parameters for SUM are now set. If not already on, Press the **On/Off** soft-key to turn on modulation.

11.5 PWM

PWM is applicable to pulse only so select Pulse then select PWM by pressing the MOD key to access the modulation menu and then press the **Type** soft-key to show the display below.

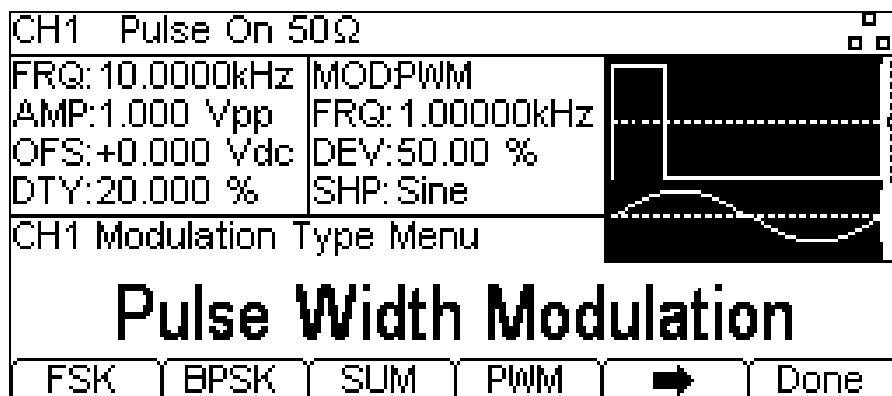

The soft-keys present all of the available modulation types.

NOTE: PWM can only be applied to Pulse carrier waveform.

If **PWM** is not already selected press the **PWM** soft-key followed by the **Done** key to return to the top level modulation menu.

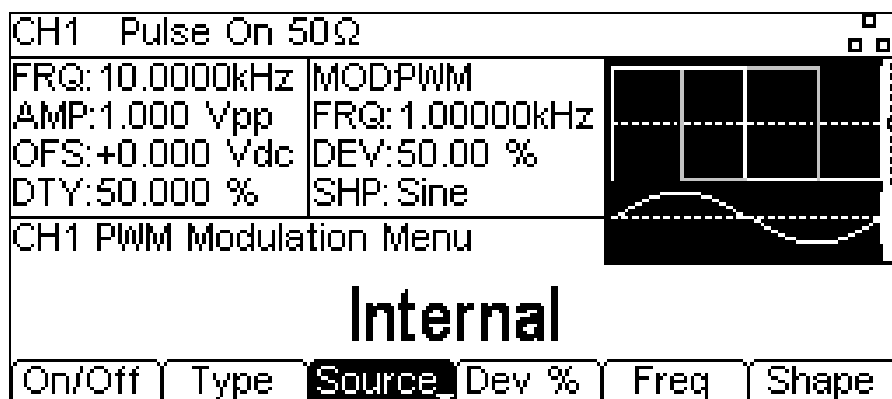

To select the modulation source press the **source** soft-key. The options are **Internal** or **External**. Internal will use the waveform specified in the shape parameter and the Graph Box will show that shape as the modulating waveform. External will use the signal present at the MOD IN connector and the **Freq** and **Shape** soft-keys will disappear. The Graph Box will always show a sinewave as the modulating waveform if the source is set to external.

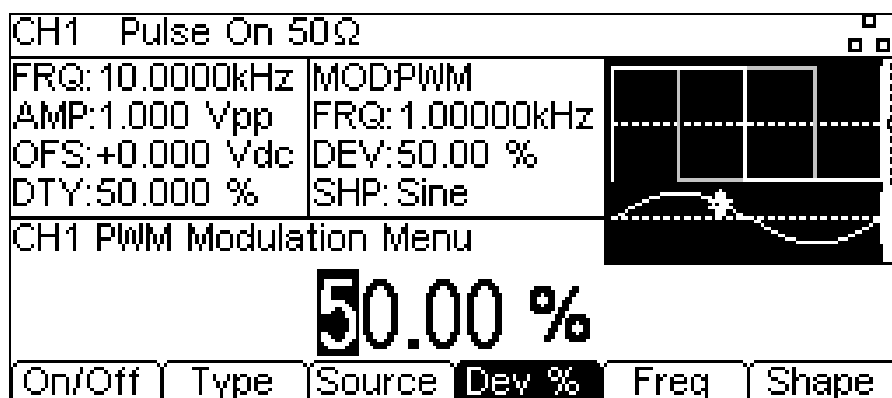

To set the pulse width deviation press the **Dev %** soft-key. The deviation parameter will appear in the Edit Box and the modulating waveform in the Graph Box will show that deviation is being edited.

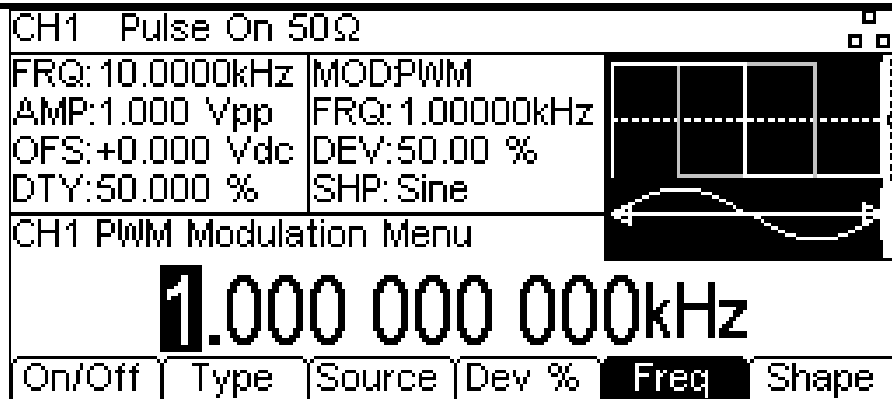

To set the modulation frequency press the **Freq** soft-key. The frequency parameter will appear in the Edit Box and the modulating waveform in the Graph Box will show that frequency is being edited.

To set the modulation shape press the **Shape** soft-key. The currently selected shape will appear in the Edit Box and the soft-keys will change to a list of shapes available.

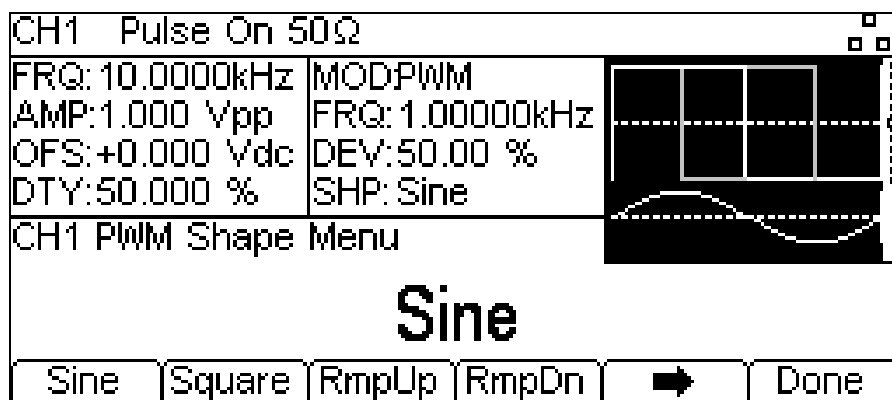

Select the modulation shape required by pressing the appropriate key then press the **Done** soft-key to return to the top level modulation menu.

All the parameters for PWM are now set. If not already on, Press the **On/Off** soft-key to turn on modulation.

11.6 FSK

To select FSK press the MOD key to access the modulation menu and then press the **Type** soft-key to show the display below.

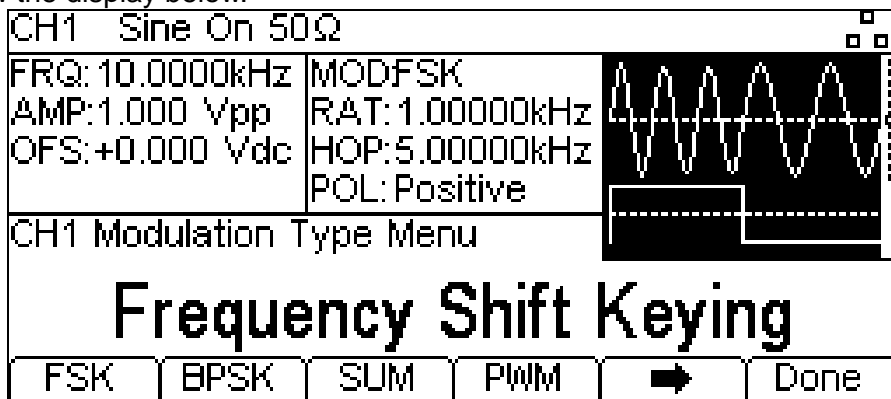

The soft-keys present all of the available modulation types.

If **FSK** is not already selected press the **FSK** soft-key followed by the **Done** key to return to the top level modulation menu.

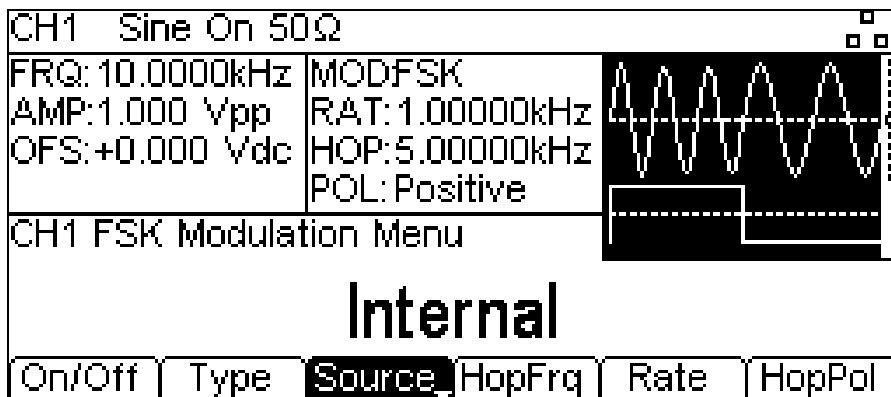

To select the modulation source press the **Source** soft-key. The options are **Internal** or **External**. Internal will use an internally generated trigger signal, external will use the signal present at the TRIG / COUNT (DC) IN connector and the **Rate** soft-key will disappear. The Graph Box will show a switching carrier and a square-wave as the modulating waveform irrespective of the source of the switching signal.

FSK will generate the carrier frequency while the switching signal is false and the hop frequency while the switching signal is true. To set the hop frequency press the **HopFrq** soft-key. The hop frequency parameter will appear in the Edit Box and the modulating waveform in the Graph Box will show that hop frequency is being edited.

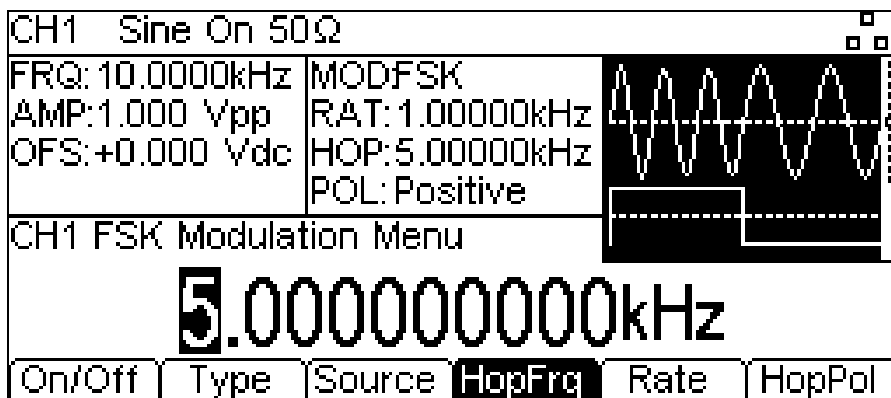

To set the switching rate press the **Rate** soft-key. The rate parameter will appear in the Edit Box and the modulating waveform in the Graph Box will show that the switching rate is being edited.

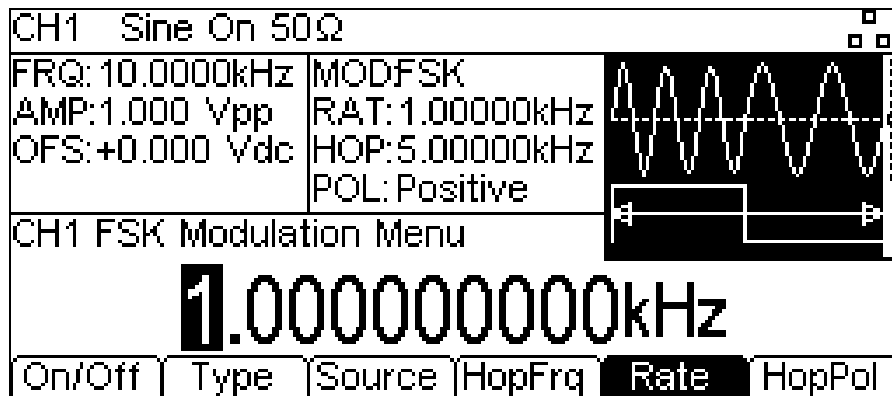

To set which level of the switching signal will output the hop frequency press the **HopPol** soft-key. The currently selected polarity will appear in the Edit Box.

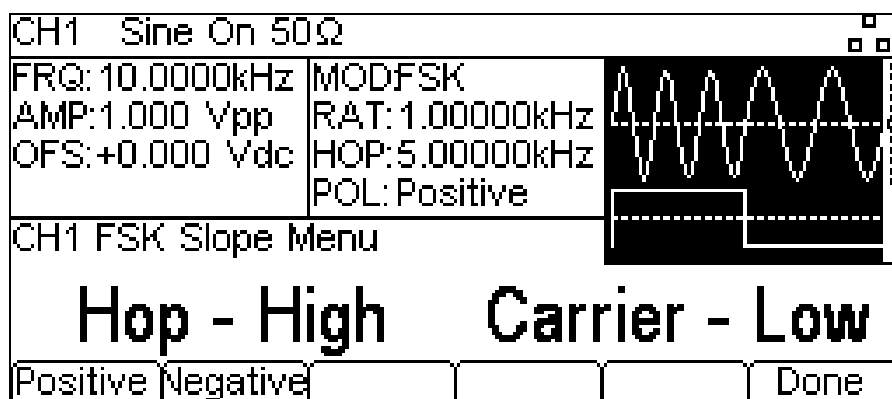

The options are **Positive** or **Negative**. Setting positive will cause FSK to generate the hop frequency while the switching signal is high and the carrier frequency while the switching signal is low. Setting negative will cause FSK to generate the hop frequency while the switching signal is low and the carrier frequency while the switching signal is high.

All the parameters for FSK are now set. If not already on, Press the **On/Off** soft-key to turn on modulation.

11.7 BPSK

To select BPSK press the MOD key to access the modulation menu and then press the **Type** soft-key to show the display below.

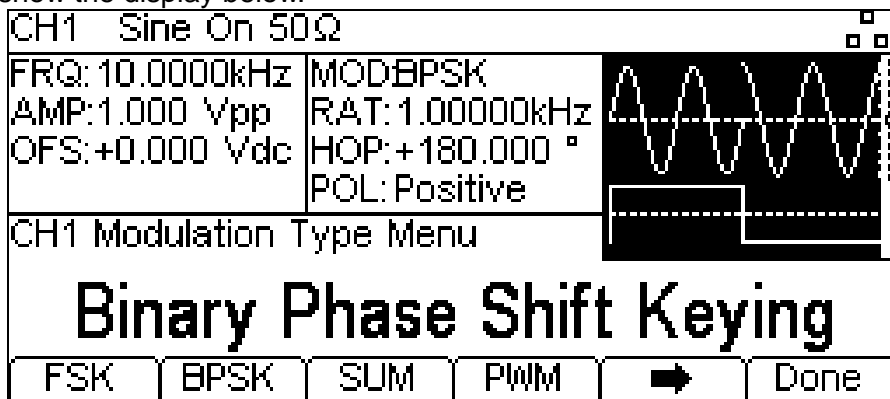

The soft-keys present all of the available modulation types.

If **BPSK** is not already selected press the **BPSK** soft-key followed by the **Done** key to return to the top level modulation menu.

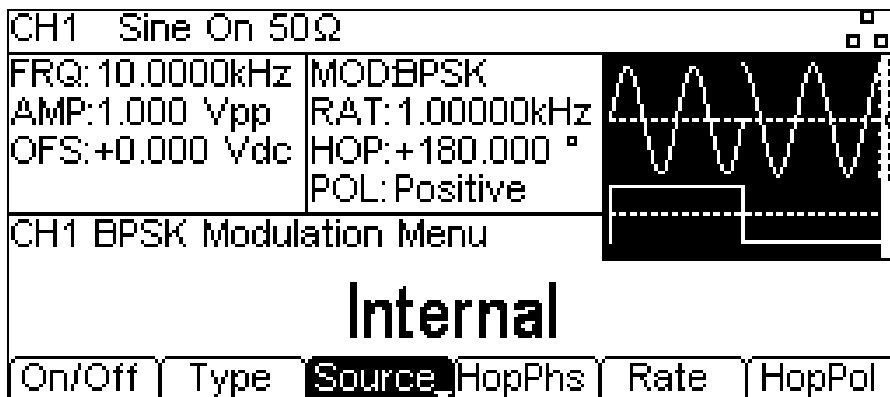

To select the modulation source press the **Source** soft-key. Internal will use an internally generated trigger signal, external will use the signal present at the TRIG / COUNT (DC) IN connector and the **Rate** soft-key will disappear. The Graph Box will show a switching carrier and a square-wave as the modulating waveform irrespective of the source of the switching signal.

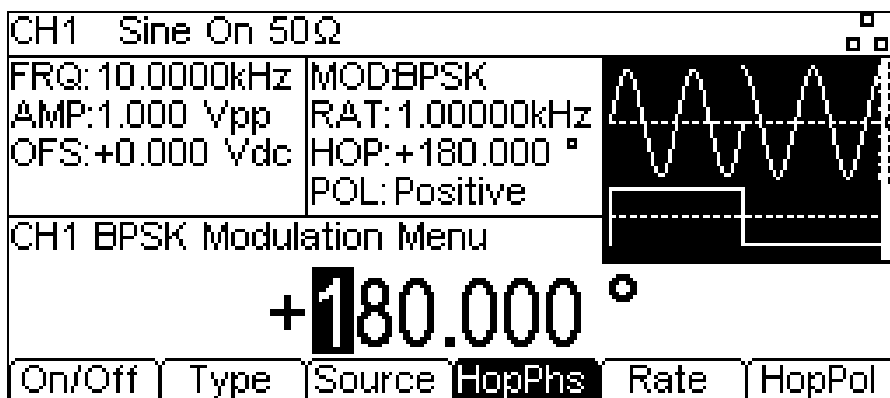

BPSK will generate the carrier phase while the switching signal is false and the hop phase while the switching signal is true. To set the hop phase press the **HopPhs** soft-key. The hop phase parameter will appear in the Edit Box.

To set the switching rate press the **Rate** soft-key. The rate parameter will appear in the Edit Box and the modulating waveform in the Graph Box will show that the switching rate is being edited.

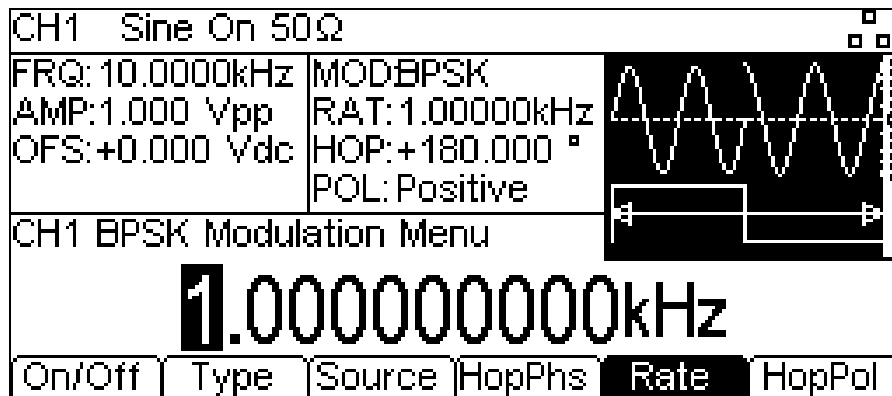

To set which level of the switching signal will output the hop phase press the **HopPol** soft-key. The currently selected polarity will appear in the Edit Box.

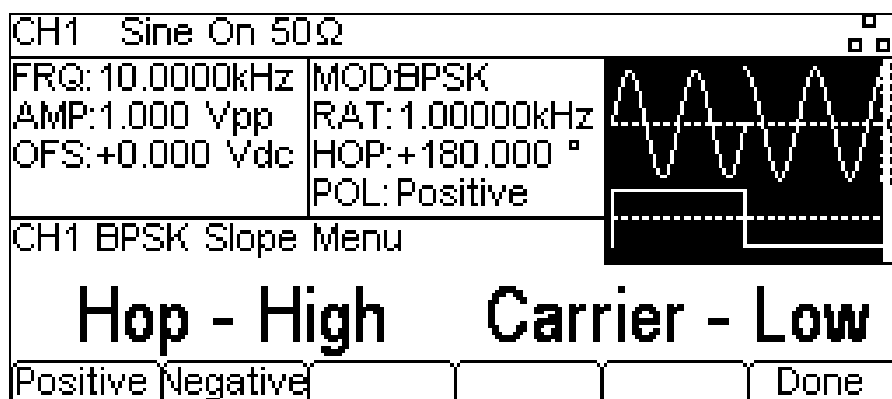

The options are **Positive** or **Negative**. Setting positive will cause BSPK to generate the hop phase while the switching signal is high and the carrier phase while the switching signal is low. Setting negative will cause BSPK to generate the hop phase while the switching signal is low and the carrier phase while the switching signal is high.

All the parameters for BSPK are now set. If not already on, Press the **On/Off** soft-key to turn on modulation.

11.8 ASK

To select ASK press the MOD key to access the modulation menu and then press the **Type** soft-key to show the display below.

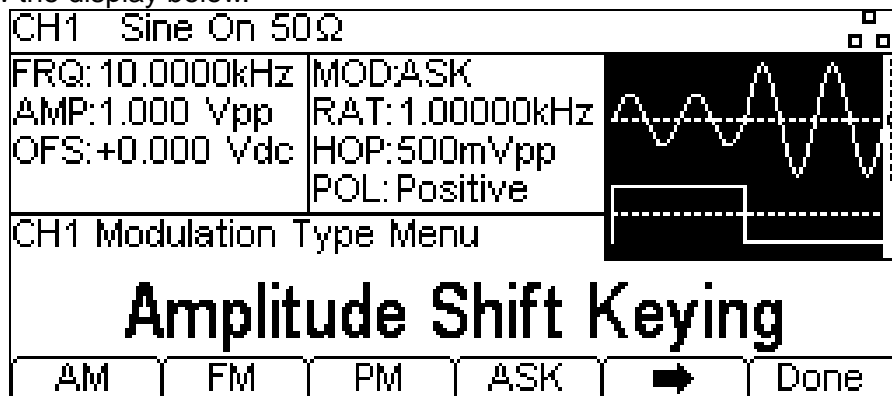

The soft-keys present all of the available modulation types.

If **ASK** is not already selected press the **ASK** soft-key followed by the **Done** key to return to the top level modulation menu.

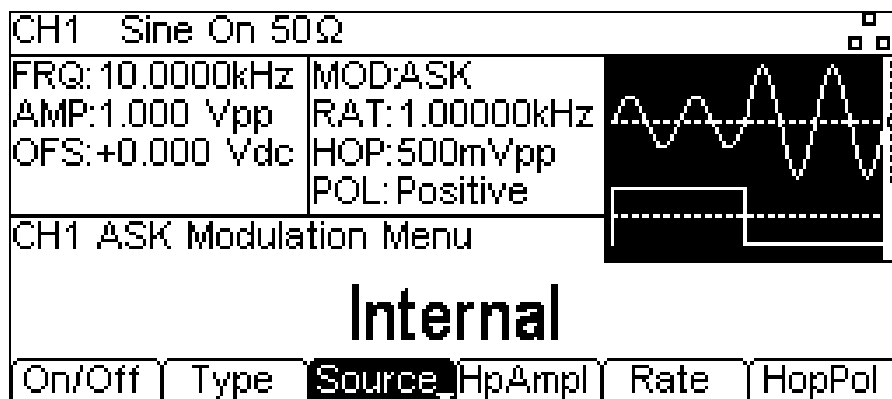

To select the modulation source press the **Source** soft-key. Internal will use an internally generated trigger signal, external will use the signal present at the TRIG / COUNT (DC) IN connector and the **Rate** soft-key will disappear. The Graph Box will show a switching carrier and a square-wave as the modulating waveform irrespective of the source of the switching signal.

ASK will generate the carrier amplitude while the switching signal is false and the hop amplitude while the switching signal is true. To set the hop amplitude press the **HopAmpl** soft-key. The hop amplitude parameter will appear in the Edit Box.

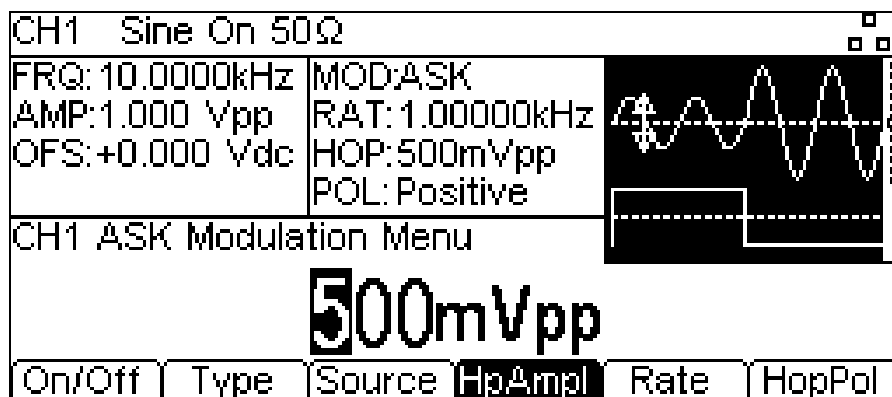

To set the switching rate press the **Rate** soft-key. The rate parameter will appear in the Edit Box and the modulating waveform in the Graph Box will show that the switching rate is being edited.

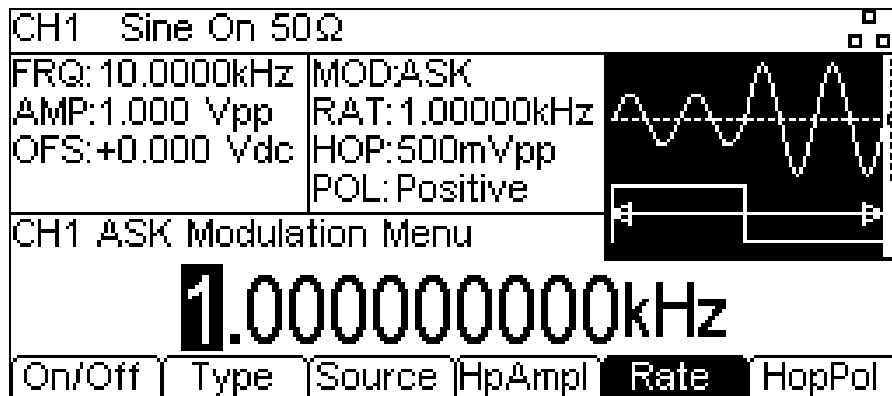

To set which level of the switching signal will output the hop amplitude press the **HopPol** soft-key. The currently selected polarity will appear in the Edit Box.

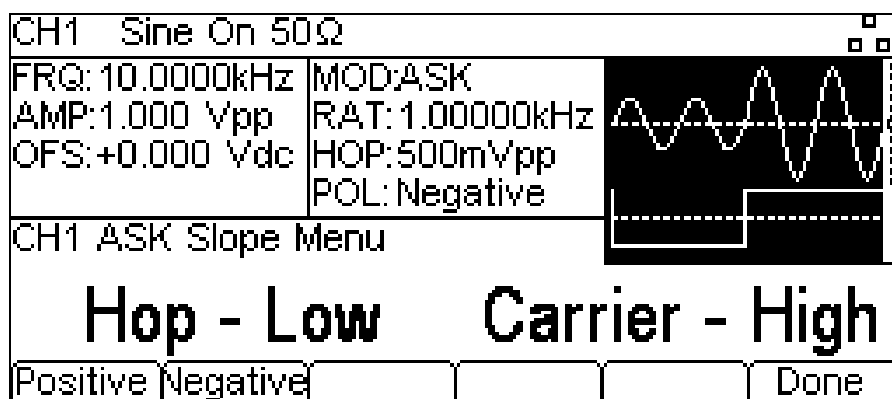

The options are **Positive** or **Negative**. Setting positive will cause ASK to generate the hop amplitude while the switching signal is high and the carrier amplitude while the switching signal is low. Setting negative will cause ASK to generate the hop amplitude while the switching signal is low and the carrier amplitude while the switching signal is high.

All the parameters for ASK are now set. If not already on, Press the **On/Off** soft-key to turn on modulation.

12. Sweep

The sweep function allows the carrier frequency to be swept using small frequency steps from the start frequency to the stop frequency. There are over 4000 steps and this remains constant for all sweep times and frequency spans.

NOTE: All waveforms can be swept with the exception of Pulse, Noise and PRBS

To select sweep, press the SWEEP key to access the sweep menu and then press the **On/Off** soft-key to apply the currently selected sweep parameters to the currently selected carrier waveform. The SWEEP key will glow orange.

The screen below shows the effect of enabling sweep when sine is the selected waveform.

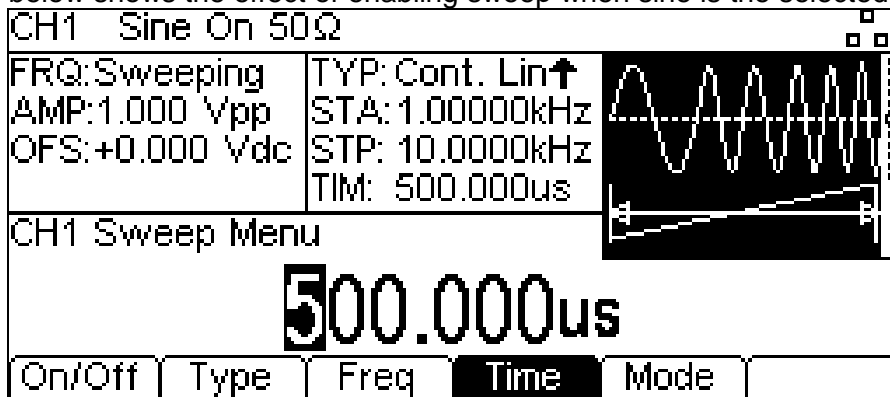

The Parameters Box now shows the current sweep parameters of **On/Off**, **Type**, **Freq**, **Time** and **Mode**, and **Sweeping** is shown in the **FRQ** field. The Graph Box shows the sweep waveform type below a representation of the swept carrier waveform. The Edit Box contains the selected parameter, in this case sweep time.

To change the carrier waveform parameters press the highlighted carrier waveform key which will return the display to the carrier menu as shown below.

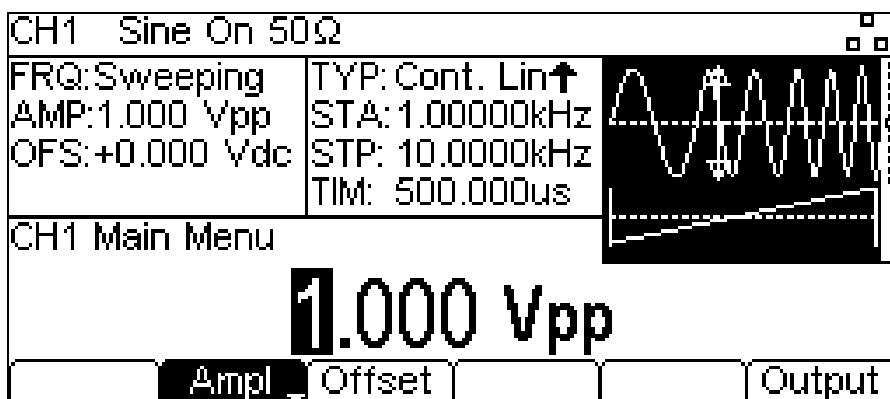

Notice that **Sweeping** still shows in the **FRQ** field of the Parameters Box and the SWEEP key still glows orange indicating that sweep is still active. To return to the Sweep menu to edit the sweep parameters press the SWEEP key again. To turn off sweep press the **On/Off** soft-key in the sweep menu.

The start and stop frequencies are set in the sweep menu. It is still possible to edit amplitude and dc offset.

Press the SWEEP key access the sweep menu again.

12.1 Sweep Type

To set the sweep type press the **Type** soft-key. The currently selected type will appear in the Edit Box and soft-keys will change to a list of sweep types available.

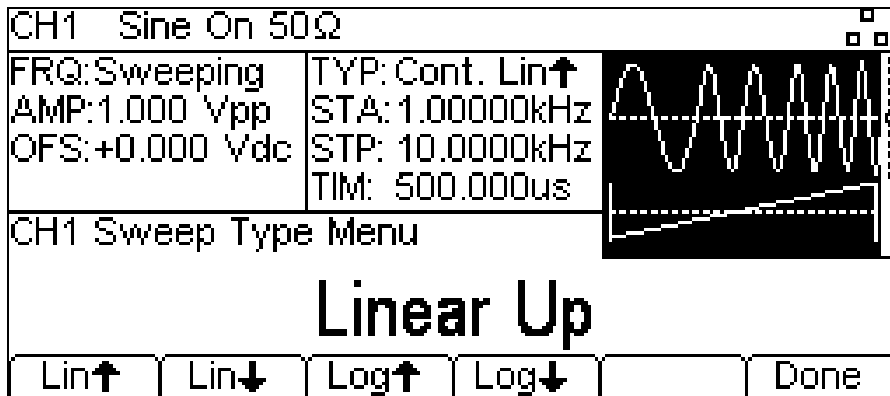

The arrows indicate up or down sweeps. With any of the **Lin** types selected the sweep changes the frequency at a linear rate; with **log** types selected the sweep spends an equal time in each frequency decade. The up arrows indicate a sweep from start frequency to stop frequency. The down arrows indicate a sweep from stop frequency to start frequency.

Select the sweep type required by pressing the appropriate key then press the **Done** soft-key to return to the top level sweep menu.

12.2 Start and Stop Frequency

Press **Freq** soft-key to access sweep frequency parameters. To set the start or stop frequency press the **Start** or **Stop** soft-keys. The frequency parameter will appear in the Edit Box and the sweep waveform type in the Graph Box will show that start or stop frequency is being edited.

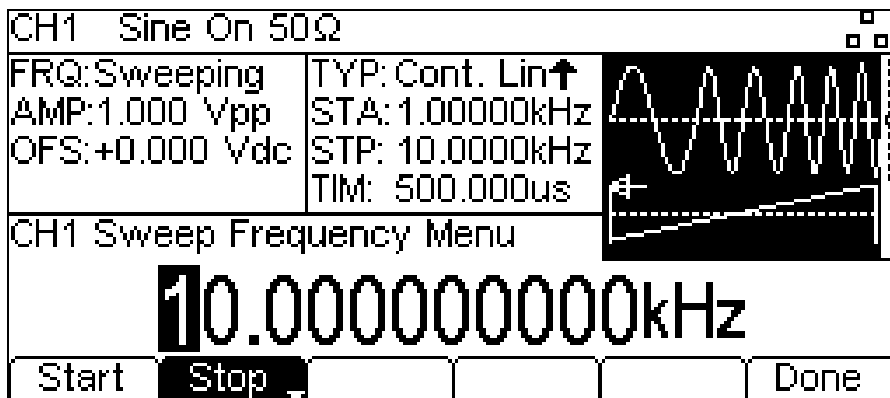

The start frequency must be lower than the stop frequency, if this is not the case an error will be generated.

12.2.1 Centre and Span

The instrument also allows the start and stop frequency parameters to be entered in terms of centre and span. Pressing either the **Start** or **Stop** soft-key while it is highlighted will switch the mode from start/stop to centre/span. To return to start/stop mode press the highlighted **Centre** or **Span** soft-key.

With centre/span mode selected the Edit Box shows the parameter, the Parameters Box shows **CTR** and **SPN** in place of **STA** and **STP** and the Graph Box changes to show the parameter which is being edited.

Press the **Done** soft-key to return to the top level sweep menu.

12.3 Sweep Time

To set the sweep time press the **Time** soft-key. The time parameter will appear in the Edit Box and the Graph Box will show that sweep time is being edited.

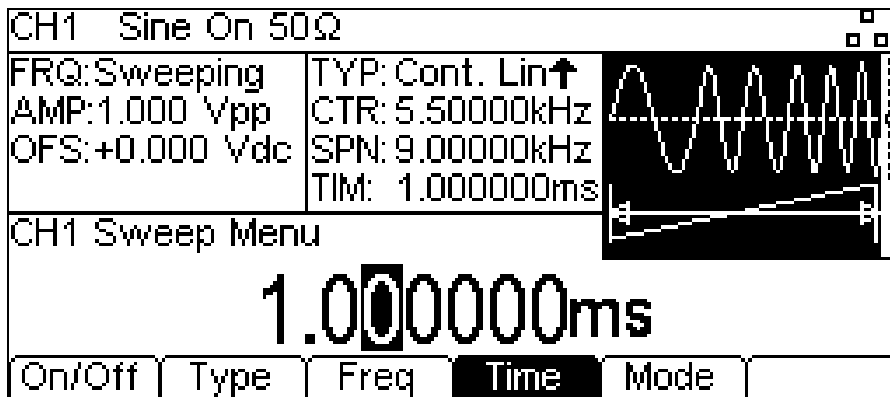

12.4 Sweep Mode

The sweep mode specifies how the sweep will be started. This may be continuous or triggered. The trigger signal for the sweep can be internal from the trigger generator, external from the TRIG / COUNT (DC) IN connector or manual by pressing the TRIGGER key.

To set the mode press the **Mode** soft-key. The mode parameter will appear in the Edit Box.

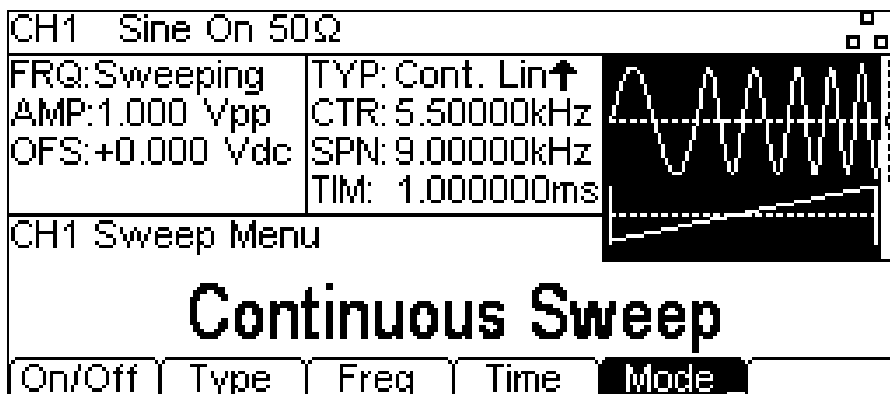

The default mode is continuous sweep. In this mode the sweep will proceed to the end and immediately start again with no pause.

Pressing the **Mode** soft-key again will change the mode to triggered sweep. In this mode the sweep will proceed to the end and then waits for a trigger to start again. The soft-keys will change and a trigger waveform will be added to the Graph Box. The **TYP** field in the Parameters Box will show that the sweep is now triggered.

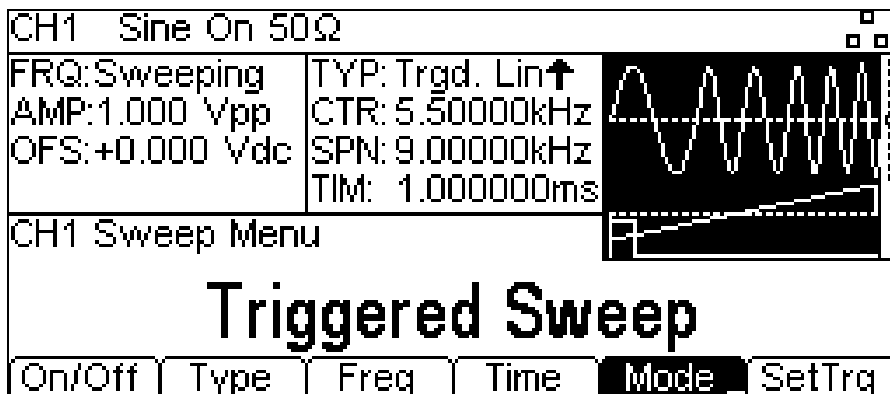

Pressing the **Mode** soft-key again while it is highlighted will return to continuous mode.

When the mode is set to triggered mode, **SetTrg** soft-key appears in the sweep main menu to allow access to control and set the sweep trigger parameters. Press the **SetTrg** soft-key to set trigger parameters.

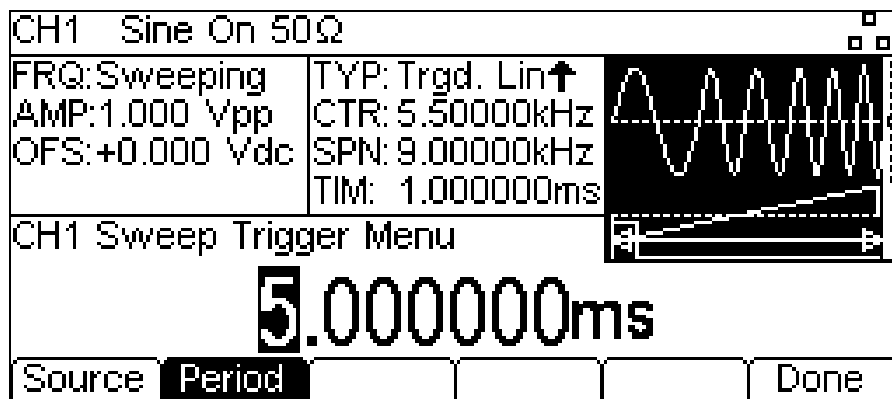

Press the **Source** key to set trigger source. The three possible trigger sources are: **Internal Trigger** (using the internal trigger generator), **External Trigger** (using the signal at the TRIG / COUNT (DC) IN connector) and **Manual Trigger** (from the Trigger key).

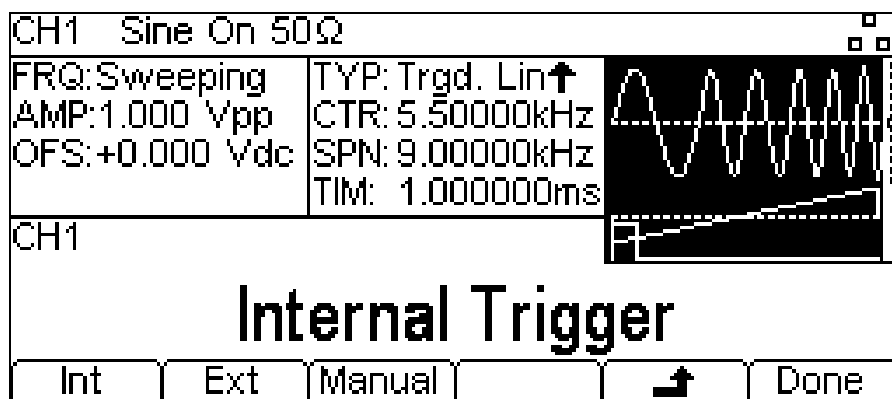

Select the trigger source then press **↑** soft-key.

Pressing the **Period** soft-key allows the period of the internal trigger generator to be set. The Edit Box shows the current period and the Graph Box changes to show that the trigger period is being edited.

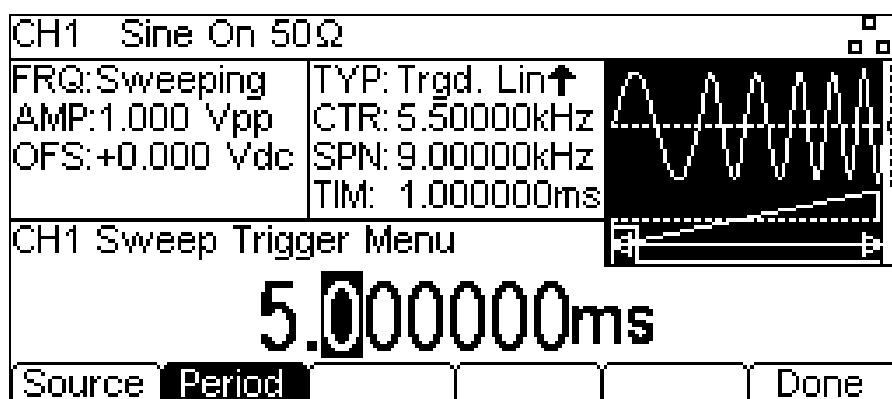

When the source is external trigger, the **Period** soft-key is replaced by **Slope** soft-key.

Repeated presses of the **Slope** soft-key key selects between **Positive Slope** and **Negative Slope**. The trigger waveform in the Graph Box changes to show the edge in use.

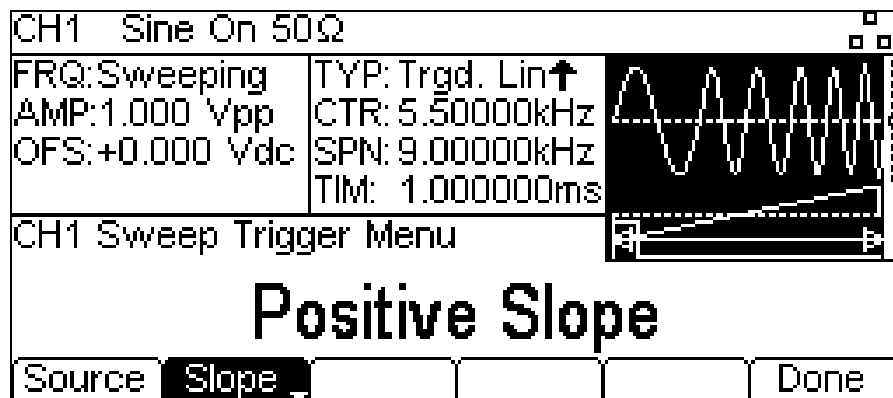

When the source is manual trigger, there are no additional parameters to be set. Press the TRIGGER key to send a manual trigger. Press the **Done** soft-key to return to the top level sweep menu.

All the parameters for sweep are now set. If not already on, Press the **On/Off** soft-key to turn on sweep.

13. Burst

The burst function allows the carrier waveform to be triggered, produce a user specified number of cycles and then stop and wait for the next trigger. For a PRBS waveform burst the count is the PRBS bit-rate and not the PRBS cycles. This allows the generation of incomplete or multiple sequences. A new trigger always restarts the PRBS from the start.

Alternatively the number of cycles may be Infinite. In this case the trigger starts the waveform. As above, PRBS waveforms will be triggered from the start.

For a noise waveform, the noise generation will be reset to its start condition when triggered. This allows it to generate the same random noise sequence again without the need to wait for the repetition time to elapse.

The Gated Burst function causes the carrier waveform to run while the trigger is true and stop while the trigger is false. The gated function is also available with Noise as the carrier waveform.

In all the above cases, except Noise and PRBS, the operation will always produce an exact number of cycles of the carrier waveform.

The trigger signal for the burst can be internal from the trigger generator, external from the TRIG / COUNT (DC) IN connector or manual by pressing the TRIGGER key.

To select burst, press the BURST key to access the burst menu and then press the **On/Off** soft-key to apply the currently selected burst parameters to the currently selected carrier waveform. The BURST key will glow orange.

The screen below shows the effect of enabling burst when sine is the selected waveform.

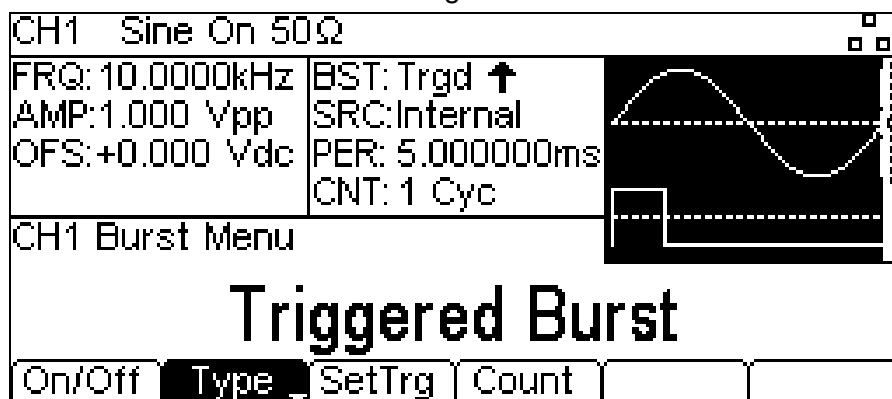

The Parameters Box now shows the current burst parameters of **Type**, **SetTrg**, and **Count**, and **Trgd** is shown in the **BST** field. The Graph Box shows the burst waveform trigger below a representation of the carrier waveform. The Edit Box contains the selected parameter, in this case **Type**. To change the carrier waveform parameters press the highlighted carrier waveform key which will return the display to the carrier menu as shown below.

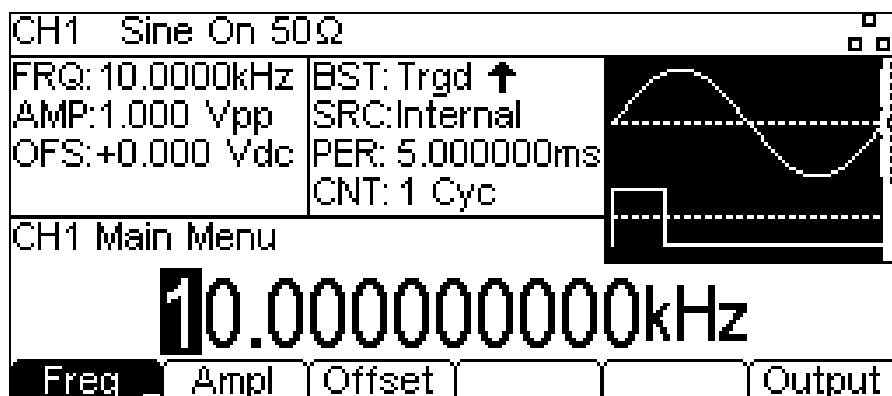

Notice that **Trgd** still shows in the **BST** field of the Parameters Box and the BURST key still glows orange indicating that burst is still active. To return to the Burst menu to edit the burst parameters press the BURST key again. To turn off burst press the **On/Off** soft-key in the burst menu.

13.1 Burst Type

To set the burst type press the **Type** soft-key. Pressing the **Type** soft-key while it is highlighted will change the type from **Triggered Burst** to **Gated Burst** and vice-versa. The currently selected type will appear in the Edit Box, the **BST** field in the Parameters Box will show the type and the Graph Box will show the trigger waveform below a representation of the carrier waveform with the burst type applied.

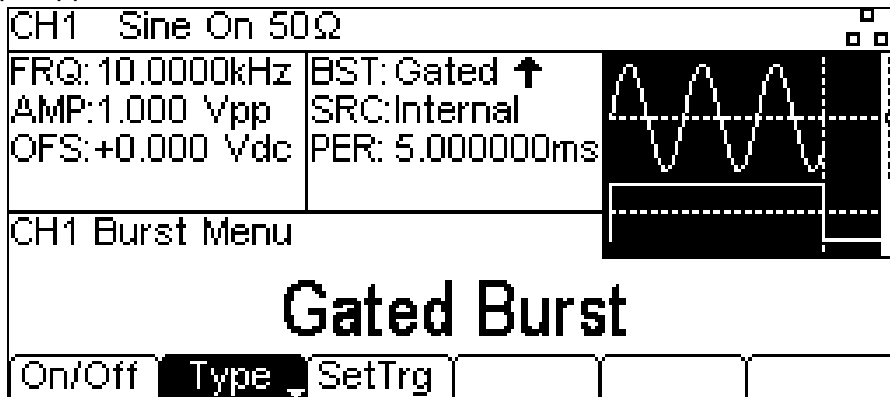

13.2 Burst Count

To set the burst count press the **Count** soft-key. The burst count parameter will appear in the Edit Box. Only **Triggered Burst** has a **Count** soft-key.

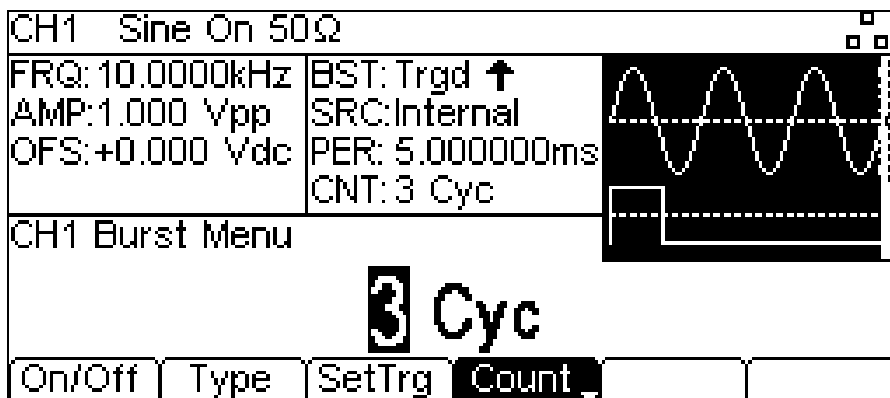

The carrier waveform in the Graph Box will show a representation of the burst as the count is edited.

Press the **Count** soft-key again to change the count from a finite number to infinite count.

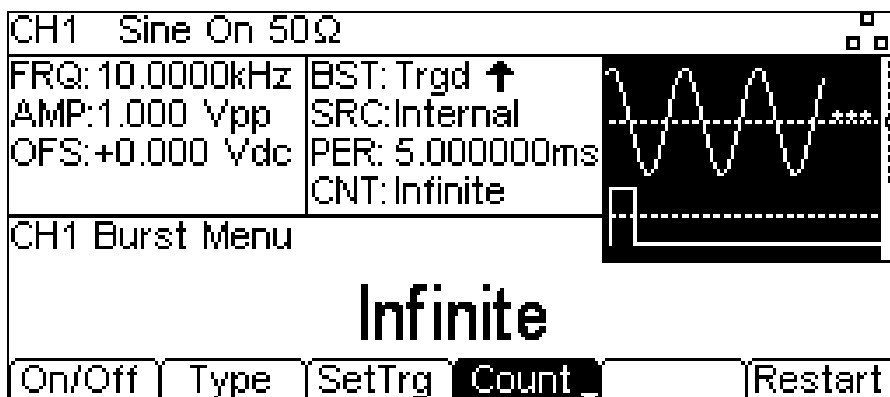

When the number of cycles is infinite, the trigger starts the waveform. Press the **Restart** soft-key to stop the waveform and wait for a trigger to re-start the waveform.

Press the **Count** soft-key again to change the count back to finite count.

13.3 Burst Phase

To set the carrier start phase, press the highlighted carrier waveform key which will return the display to the carrier menu and then press the **Output** soft-key. In the Output menu, press the **Phase** soft-key to change the start phase of the waveform. The phase parameter will appear in the Edit Box.

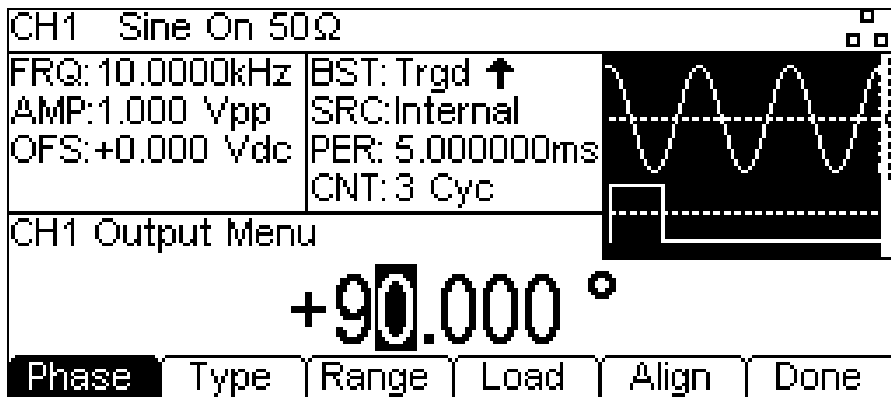

The carrier waveform in the Graph Box will show a representation of the carrier start phase as the phase is edited.

Press the highlighted BURST key to return the display to the burst menu.

13.4 Burst Triggering

Press the **SetTrg** soft-key in the burst menu to allow access to control and set the burst trigger parameters.

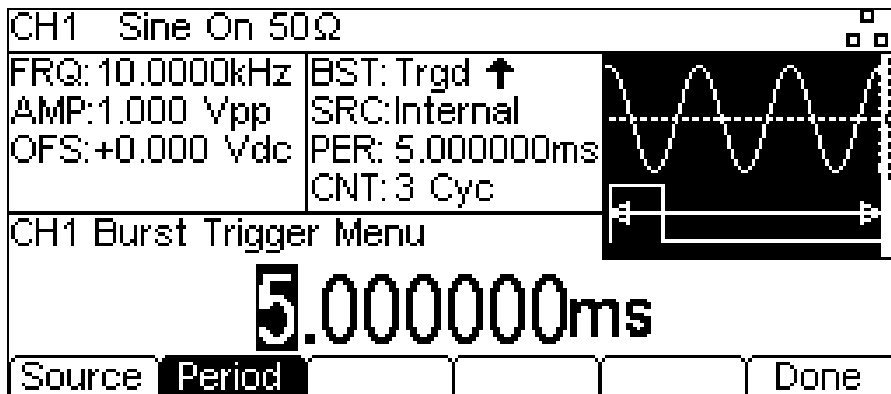

Press the **Source** key to set trigger source. The three possible trigger sources are: **Internal Trigger** (using the internal trigger generator), **External Trigger** (using the signal at the TRIG / COUNT (DC) IN connector) and **Manual Trigger** (from the Trigger key).

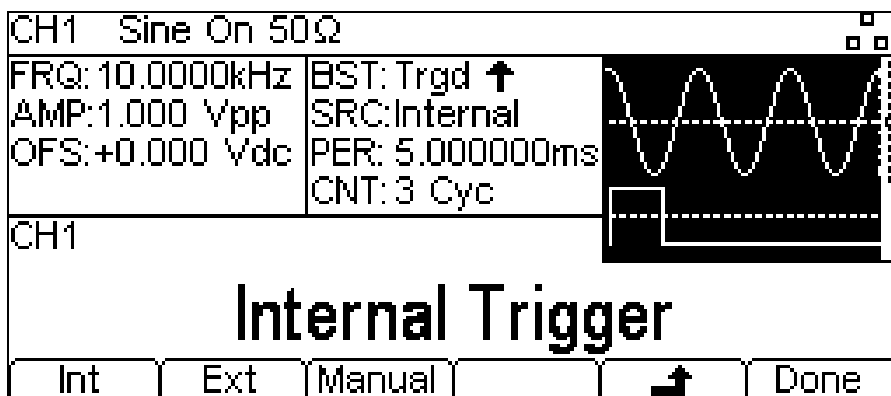

Select the trigger source then press **↕** soft-key.

Pressing the **Period** soft-key allows the period of the internal trigger generator to be set. The Edit Box shows the current period and the Graph Box changes to show that the trigger period is being edited.

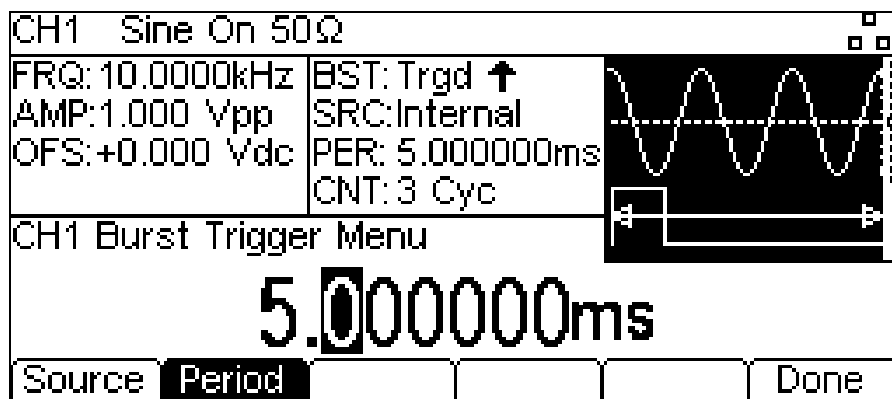

When the source is external trigger, the **Period** soft-key is replaced by **Slope** soft-key. Repeated presses of the **Slope** soft-key key selects between **Positive Slope** and **Negative Slope**. The trigger waveform in the Graph Box changes to show the edge in use.

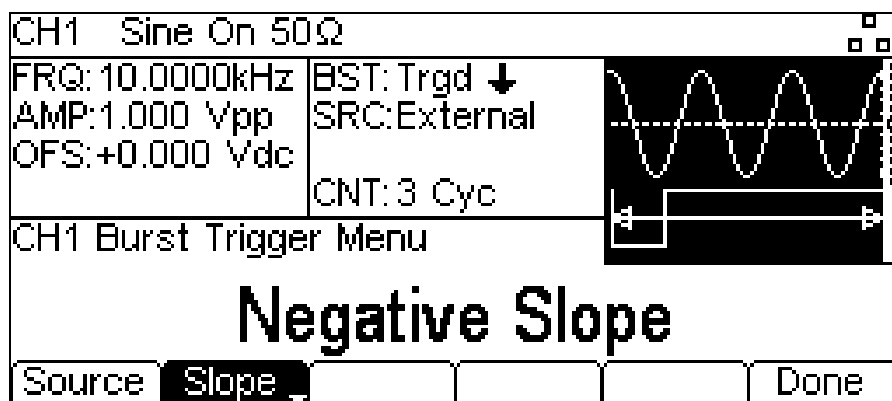

When the source is manual trigger, there are no additional parameters to be set. Press the TRIGGER key to send a manual trigger. Press the **Done** soft-key to return to the top level burst menu.

All the parameters for burst are now set. If not already on, Press the **On/Off** soft-key to turn on burst.

14. Dual Channel Operation

The instrument incorporates two separate generators in which all parameters can be set independently of each other. However, the two generators use the same system clock and share a single Trigger Input and Modulation Input on the rear panel.

14.1 Channel Selection

Press CH1/2 key to select between channels for parameter editing.

The selected channel is indicated at the top left of the Status Line.

The display colour scheme of channel 2 is the inverse of the display colour scheme of channel 1 for ease of identification of the currently selected channel.

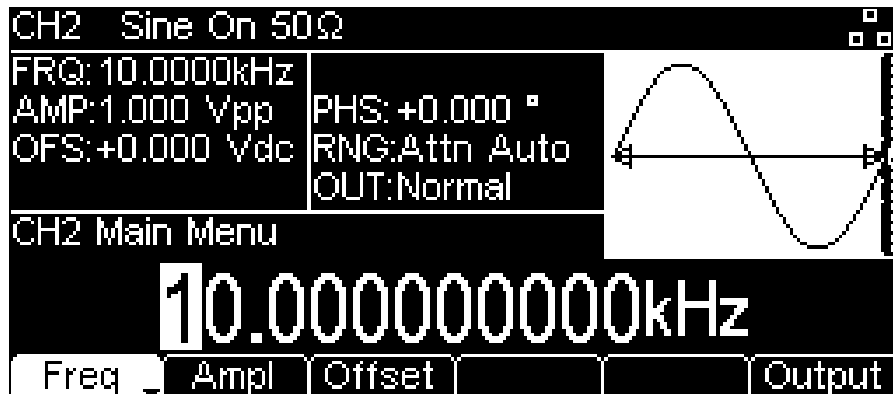

14.2 Linked Channels

The two channels can be linked in a variety of ways. All of the options are available from the Dual Channel menu which is accessed by pressing the UTILITY key.

The utility menu presents several further menus which allow control of instrument and system capabilities not available directly from the menus described so far.

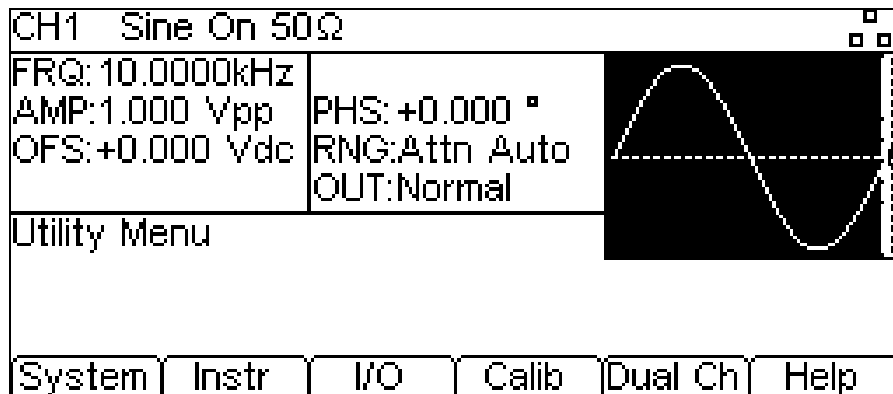

This section explains the options available by pressing the **Dual Ch** soft-key; the options accessed via the other soft-keys are described in the following sections.

Pressing the **Dual Ch** soft-key gives access to the dual channel capabilities of the instrument.

14.2.1 Coupled Operation

It is possible to set any combination of Frequency, Amplitude and Output coupling.

NOTE: When a parameter is coupled it may be changed on either channel and the other channel will also change.

To enable or disable frequency coupling press the **Freq** soft-key.

NOTE: **Coupled** is shown in the Graph Box when either frequency, amplitude or output coupling is enabled. The selected coupled parameter section will become inverted on the screen as shown.

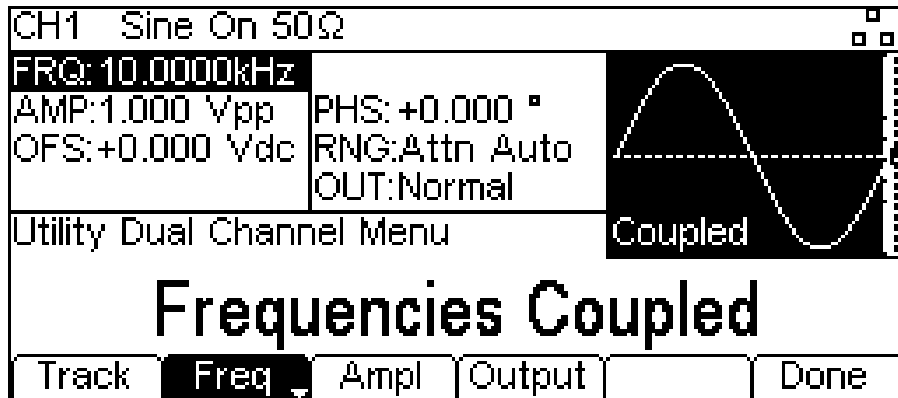

When entering frequency coupling modes the instrument will automatically phase align the channels. The phases may become misaligned by subsequent parameter changes. To realign the phase at any time, press the **Align** soft-key from the carrier - output menu.

To enable or disable amplitude coupling press the **Amp1** soft-key.

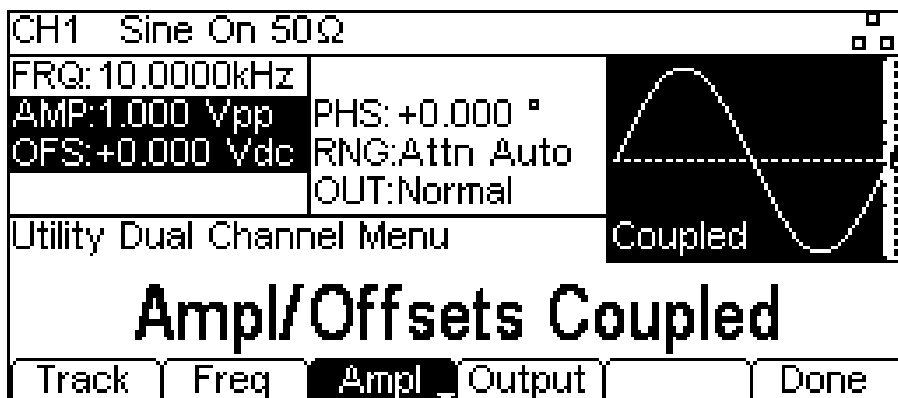

To enable or disable output coupling press the **Output** soft-key.

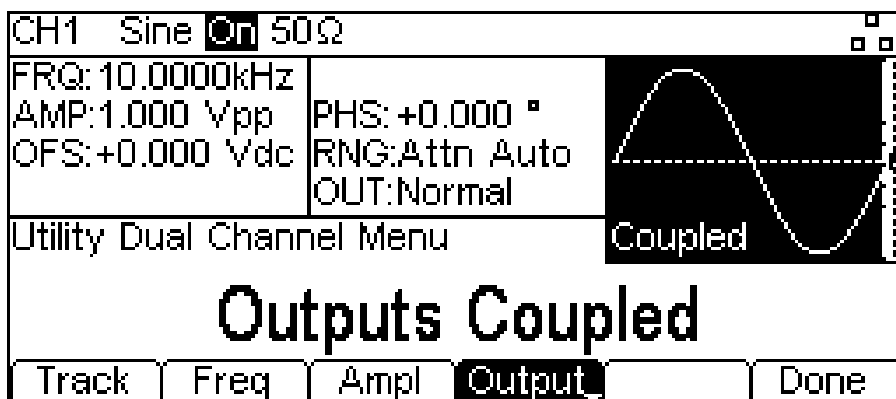

14.2.2 Tracking Options

Pressing the **Track** soft-key shows tracking menu.

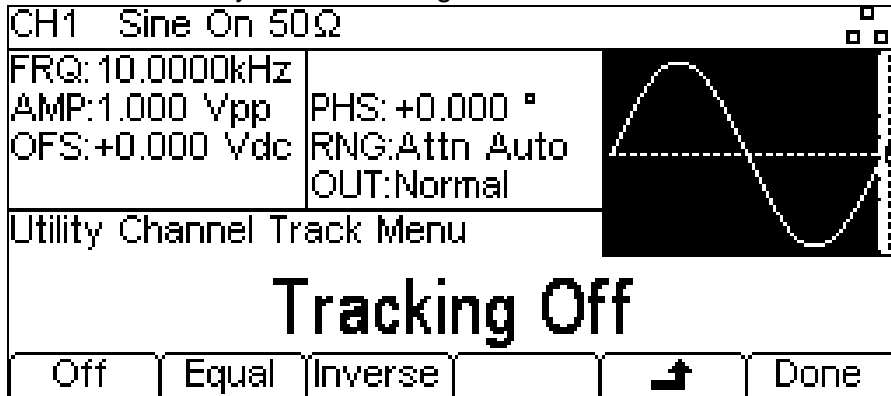

With Tracking Off the two channels behave independently and changes in parameters on one channel do not affect the other channel.

When Tracking is On, any parameter change is applied to both channels. It is not possible to switch between channels with the **Ch1/2** key. While tracking is selected **Track** or **InvTk** is shown in place of the normal **CH1/CH2** indicator.

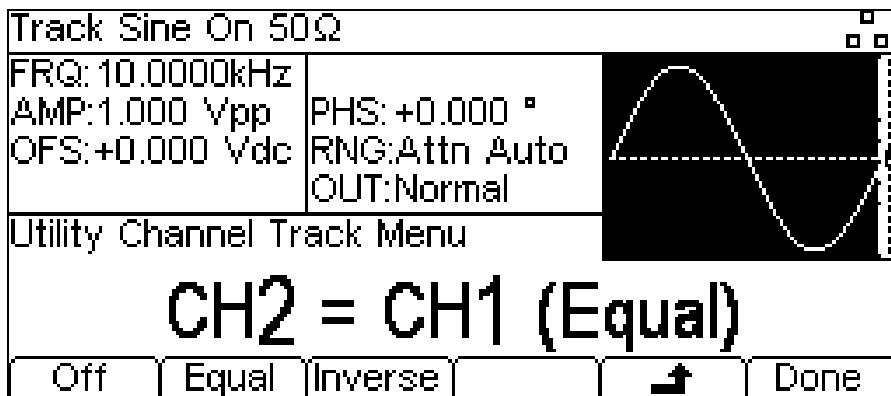

The channels can be set to track exactly by pressing the **Equal** soft-key, or Channel 2 may be inverted by pressing the **Inverse** soft-key to produce a differential pair of signals.

When either tracking option is enabled the waveforms will remain aligned at a phase of 0°.

To exit tracking mode press the **Off** soft-key.

NOTE: Tracking and coupled options are mutually exclusive.

15. External Counter

The instrument offers the functionality of a counter. It can measure various parameters such as frequency, period, duty cycle, width and negative pulse width of an external input signal. The generator continues to perform normally when counter is enabled.

15.1 Counter Menu

To access counter related menus, press the UTILITY key. The utility menu presents several further menus which allow control of instrument and system capabilities.

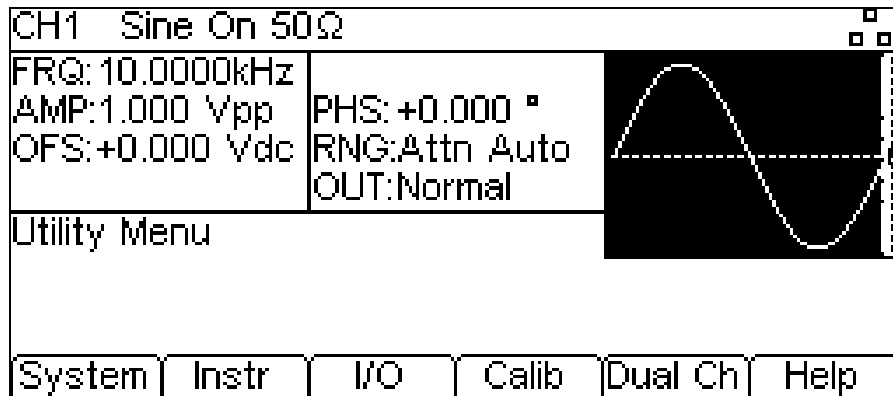

Press **Instr** soft-key and then press **FrCntr** soft-key to access the counter capabilities of the instrument.

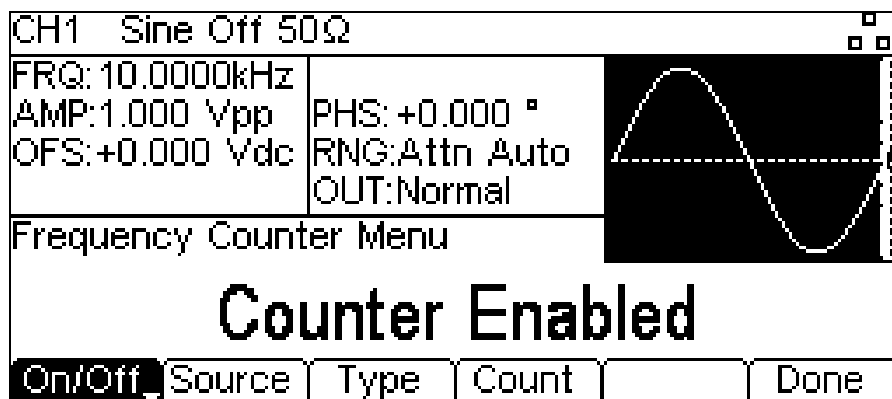

To enable or disable the counter, press the **On/Off** soft-key.

15.2 Counter Source

The counter can either count the signal present at the TRIG / COUNT (DC) IN socket or the signal present at the REF / COUNT (AC) IN socket at the rear panel of the instrument. To select from the two counter sources, press the **Source** soft-key.

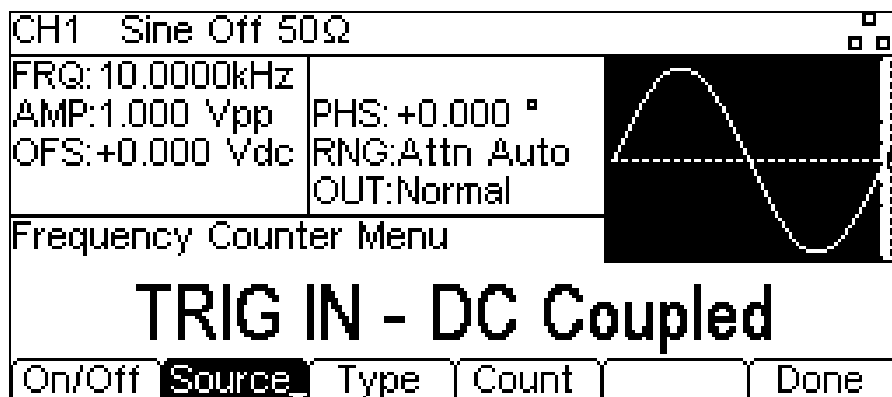

The TRIG / COUNT (DC) IN socket is DC coupled and has an input impedance of 10kΩ. The threshold is fixed at 1.2V to cater for 1.8V, 2.5V as well as 3.3V logic inputs. Select this input to count signals from 100mHz to >125MHz (typically 150MHz). The input sensitivity is 100mV.

The REF / COUNT (AC) IN socket is AC coupled. Select this input to count signals from 3Hz to >125MHz (typically 150MHz). The input sensitivity is 100mV.

15.3 Counter Type

Press the **Type** key to set counter type. The options are: frequency, period, duty cycle, width and negative width.

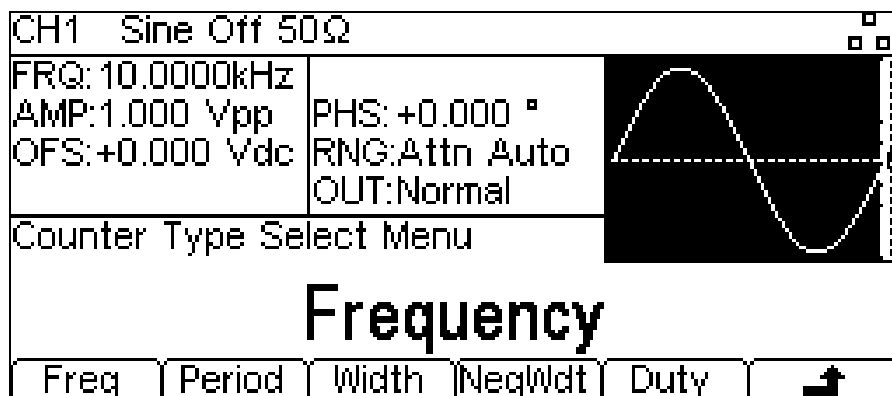

Select the counter type then press **↗** soft-key.

15.4 Measurement

To display the measurement value, press the **Count** key. The Edit Box shows the current measurement. With no input signal at the selected input, the counter displays 'No signal' until an adequate input signal is applied.

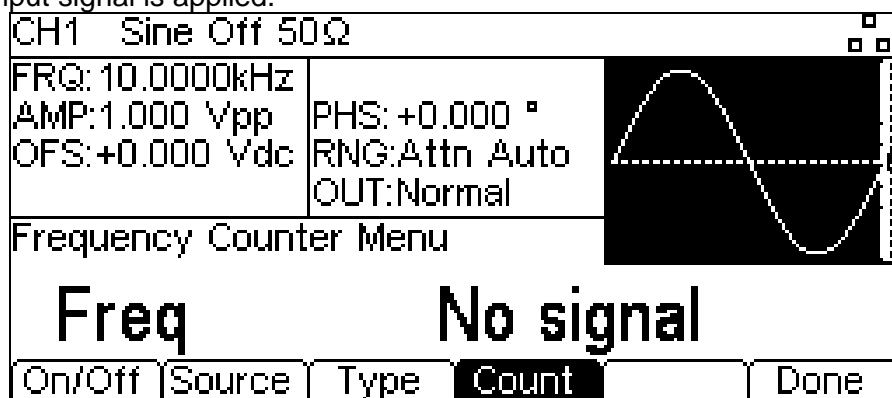

When an adequate input signal is applied, the counter constantly measures and displays the reading in the Edit Box.

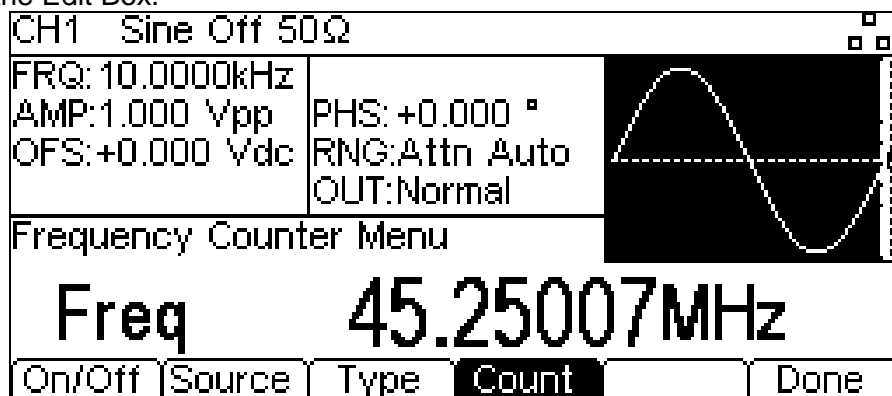

To exit the counter menu. Press the **Done** soft-key.

16. Harmonic Waveforms

The instrument is capable of creating waveforms by the addition of sine wave harmonics.

Up to 16 harmonics can be used, chosen from up to the 50th order.

The amplitude and phase can be individually set for each harmonic.

Harmonic waveforms can also be created or edited in the Waveform Manager Plus V4.11 Windows application supplied on the CD.

The created harmonic waveform is stored in one of the four user-defined arbitrary waveform locations.

NOTE: Any previous waveform stored in the same location is erased.

To output the harmonic waveform, select ARB as the carrier waveform and then select the user-defined arbitrary waveform where the harmonic is stored as the output either from **Waves** menu or **Arbs** menu under **Load**.

16.1 Selecting arb location to store harmonic waveform

With arb as the selected waveform, pressing the **Arbs** soft-key switches to the **Arb Arbs** menu.

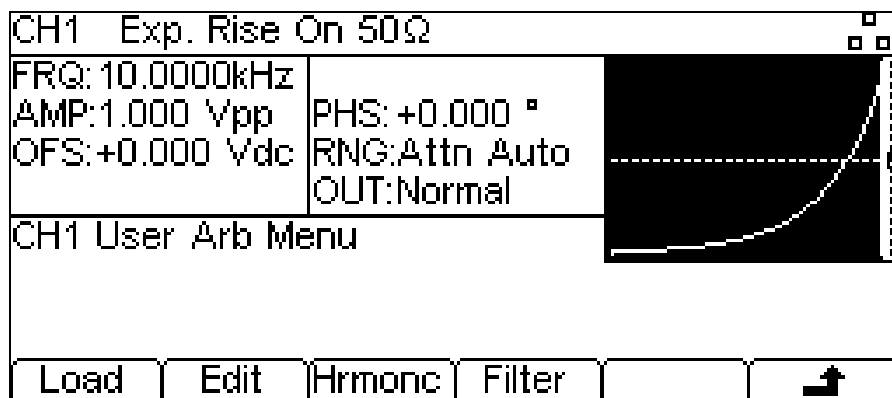

Pressing the **Hrmonic** soft-key opens the harmonic waveform sub-menu.

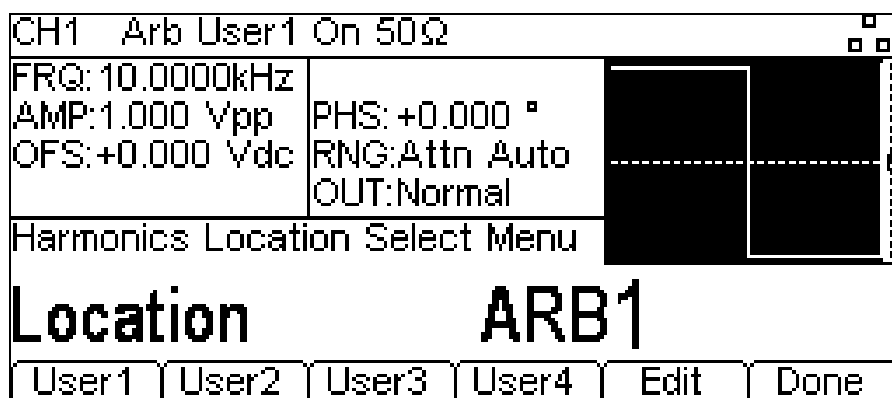

The name of the arb selected for storing the harmonic waveform is shown in the Edit Box. To select an arbitrary waveform location for storing the harmonic waveform press the appropriate soft-key.

16.2 Editing harmonic waveform

Press the **Edit** soft-key to show the harmonic waveform edit menu. The Edit Box shows all the parameters of the first harmonic content.

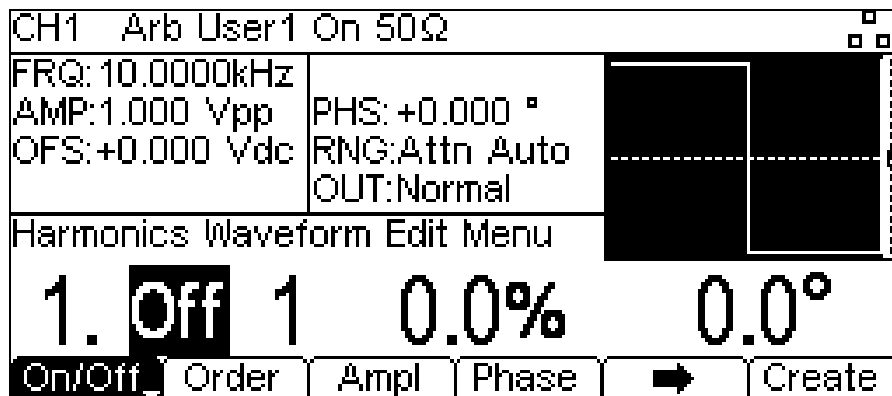

16.2.1 Enable / Disable

To enable or disable the current harmonic, press the **On/Off** soft-key.

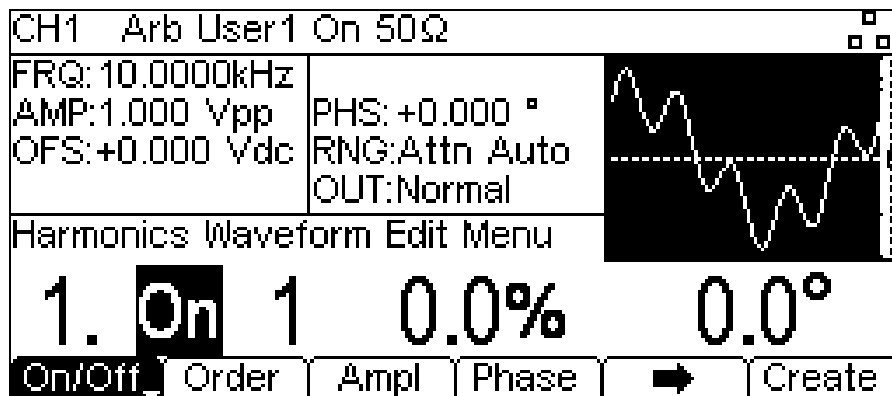

16.2.2 Order

To set the order of the current harmonic, press the **Order** soft-key. Harmonic order can be set between 1 and 50.

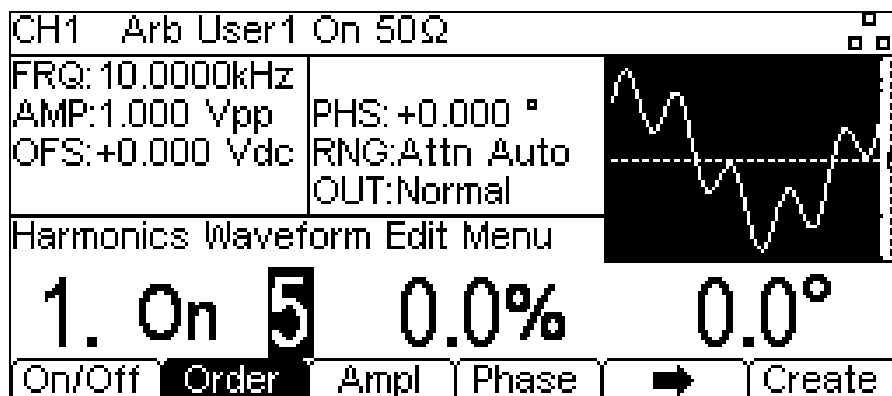

16.2.3 Amplitude

To set the amplitude of the current harmonic, press the **Amp1** soft-key.

The amplitude is set as a percentage of the carrier waveform amplitude. Care should be taken when setting the amplitudes of the harmonic contents. The amplitude of the created harmonic waveform will be the phase sum of all components specified in the waveform. If the amplitudes are set such that the sum of all components exceed 100% at any point in the creation of the harmonic waveform, then the waveform at that point will be clipped.

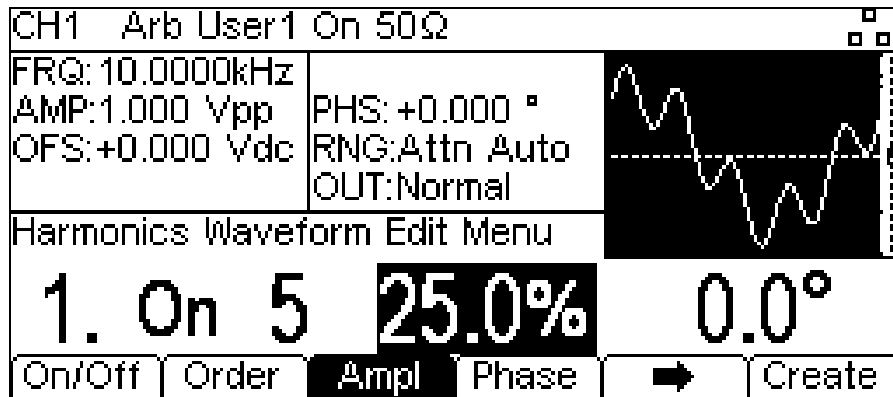

16.2.4 Phase

To set the phase of the current harmonic, press the **Phase** soft-key.

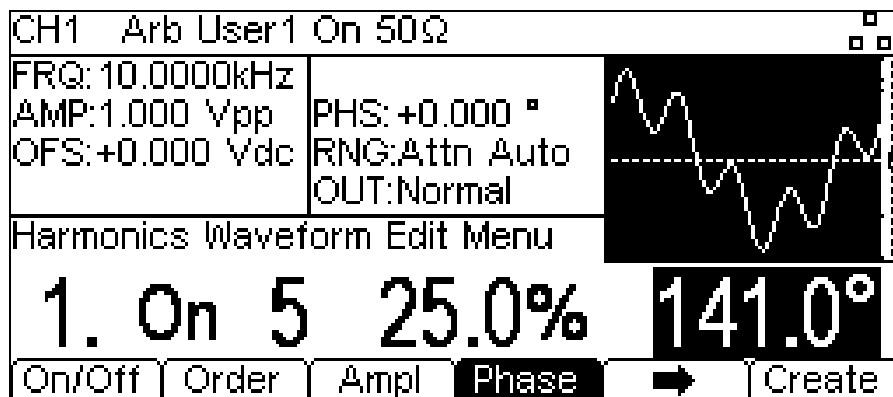

To set the parameters of the next harmonic content press the **➡** soft-key. Up to 16 harmonic contents can be defined, the parameters of which will show with successive presses of the **➡** soft-key. One more press of the **➡** soft-key will show the parameters of the first harmonics again. Once all harmonics are defined, press the **Create** soft-key to create the harmonic waveform and store it in the chosen user-defined arbitrary waveform location. Pressing the **Create** soft-key also exits from the harmonic waveform edit menu.

17. Utility Menu

Pressing the UTILITY key presents several further menus which allow control of instrument and system capabilities not available directly from the menus described so far.

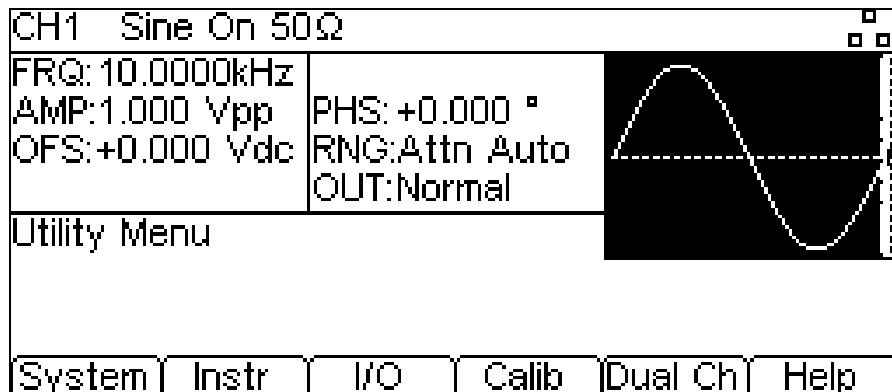

Each of the soft-key selected menus is discussed in the following sections.

17.1 System

Pressing the **System** soft-key gives control of some system level functions.

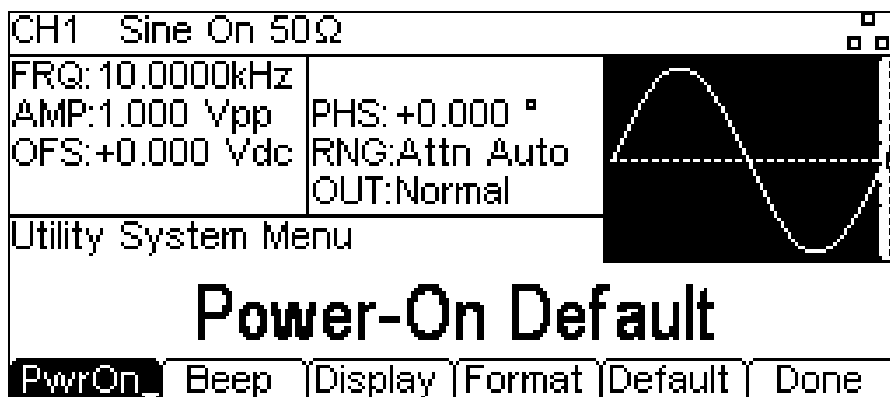

17.1.1 Power On State

Pressing the **PwrOn** soft-key will alternate between **Power-On Default** and **Power-On Latest**.

With **Power-On Default** selected the instrument will power up with the factory default parameters loaded.

With **Power-On Latest** selected the instrument will power up with the parameters as they were at the last power down.

17.1.2 Beep State

Pressing the **Beep** soft-key will alternate between **Beep On** and **Beep Off**. With beep on the error and warning messages will be accompanied by a sound. These sounds are suppressed with beep off.

17.1.3 Display Control

Pressing the **Display** soft-key will show the display control menu.

Pressing the **Contra** soft-key allows the display contrast to be adjusted.

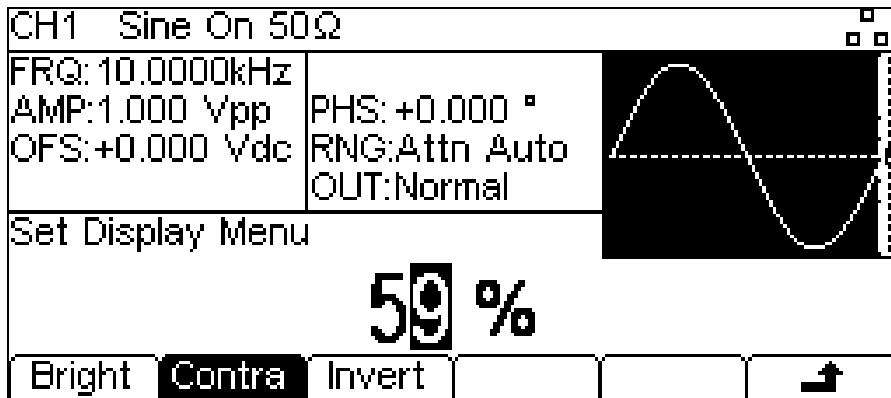

Pressing the **Bright** soft-key allows the display backlight brightness to be adjusted.

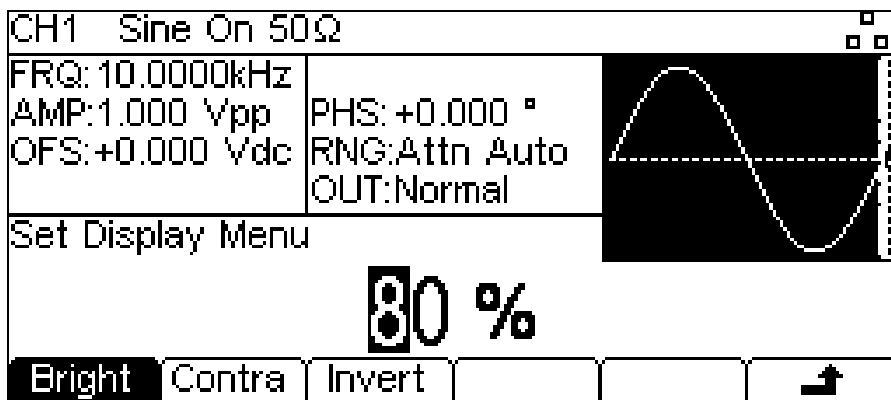

Pressing the **Invert** soft-key will alternately set the display scheme of channel 1 between black-on-white (the default) and white-on-black.

NOTE: The display colour scheme of channel 2 will always be the inverse of the display colour scheme of channel 1 for ease of identification of the currently selected channel.

Press the **↑** soft-key to return to the top level System menu.

17.1.4 Number Format

Pressing the **Format** soft-key will show the Format menu.

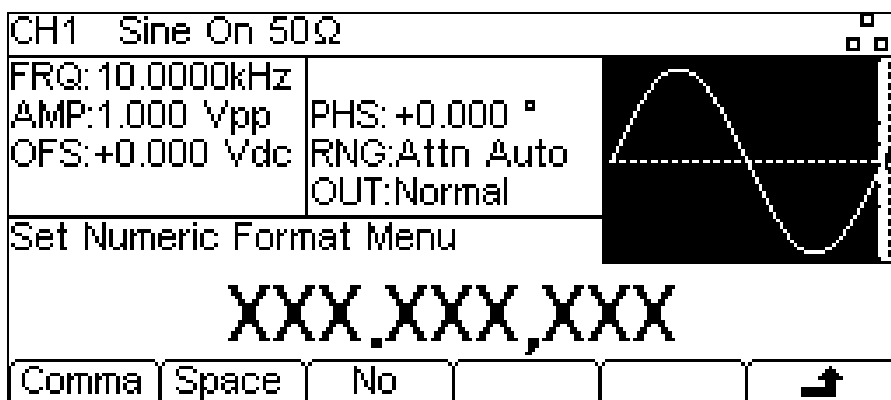

This menu allows the number format used in the Edit Box to be customised. The default is comma format which is selected by pressing the **Comma** soft-key.

In comma format, digits after the decimal point are arranged in groups of three with the groups separated by a comma.

Pressing the **Space** soft-key will change to space format.



In space format digits after the decimal point are arranged in groups of three with the groups separated by a space.

Pressing the **No** soft-key will change to no format.



In no format digits after the decimal point are not grouped.

Press the **↗** soft-key to return to the top level system menu.

17.1.5 Restore Factory Defaults

Pressing the **Default** soft-key allows all instrument parameters (except remote interface configuration parameters) to be restored to their factory settings as detailed in 23 Appendix 1: Factory Default Settings.

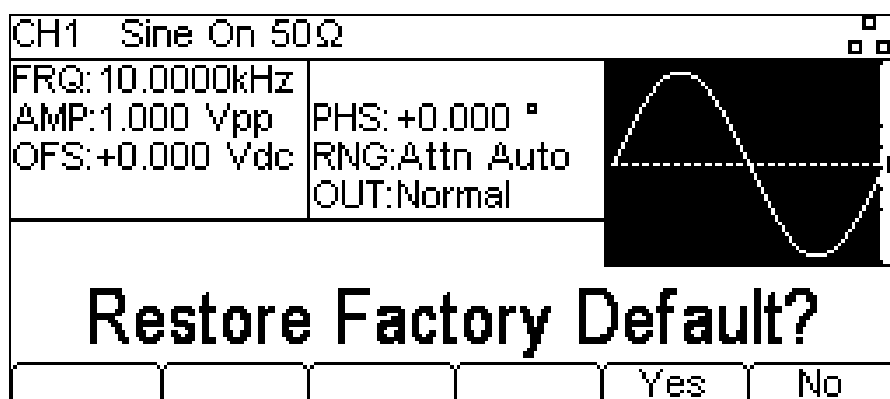

Once system parameters are set, press the **Done** soft-key to return to the utility menu.

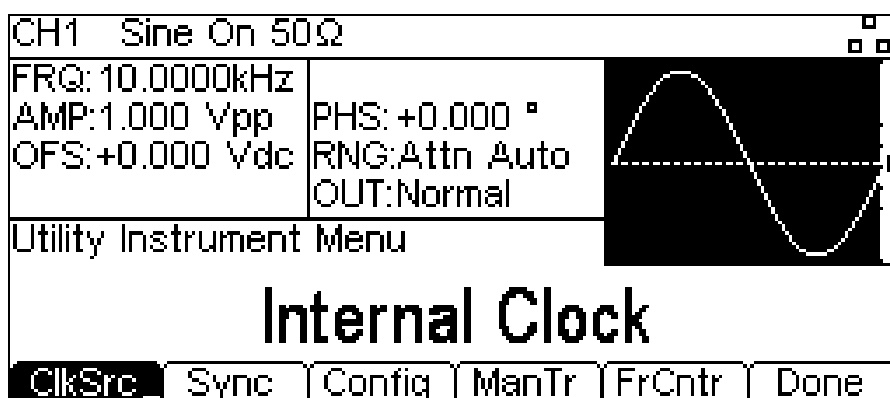

17.2 Instrument Settings

Pressing the **Instr** soft-key opens the Utility Instrument sub-menu.



17.2.1 Reference Clock Source

Alternate presses of the **ClkSrc** soft-key change between using the Internal Clock and the External Clock. An external clock must have a frequency of 10MHz (+/-50kHz) and is applied to the rear panel socket 10MHz REF IN.

When a valid external clock is in use, (clock source = external), **Ext**  is shown on the top line of the display and the symbol is followed by an arrow. If a valid external clock is present but not in use (clock source = internal), **Ext**  **Det** is shown on the top line of the display. If the clock source is set to external but the external clock signal is not valid, **Ext**  **Err** is shown on the top line of the display.

17.2.2 Sync Type Control

Pressing the **Sync** soft-key will show the sync type control menu.

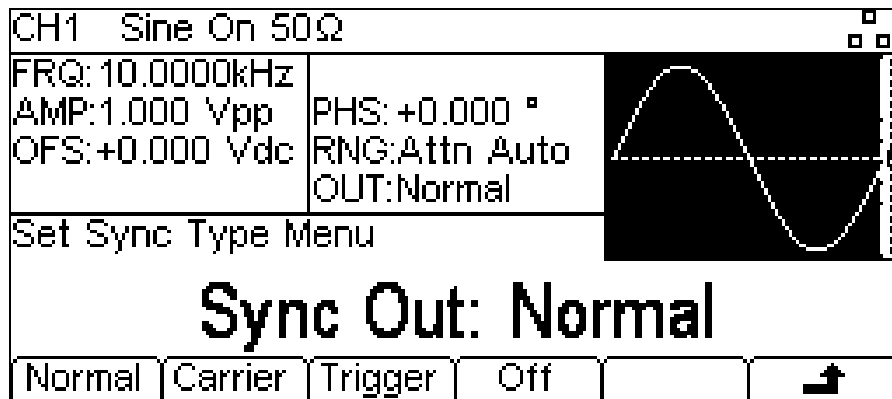

The currently selected type will appear in the Edit Box and the soft-keys will change to a list of Sync types available.

The available Sync types are explained below:

Normal: Automatically sets the most relevant Sync output for the instrument set-up.

Carrier: A square wave at the same frequency and duty as the carrier waveform. Available for all waveforms except noise.

Trigger: A buffered version of the Trigger signal.

Off: Sync is turned off.

Please note that sync type is only relevant when channel 2 is configured to output channel 1 sync. Press the  soft-key to return to the top level instrument menu.

17.2.3 Channel 2 Configuration

Alternate presses of the **Config** soft-key changes the configuration of channel 2 between a separate independent output and channel 1 sync.

17.2.4 Manual Trigger Select

The TRIGGER key can be set to send a manual trigger signal to just the current channel (single) or to both channels simultaneously (dual).

Pressing the **ManTr** soft-key alternates between Manual Trigger Setup: Single and Manual Trigger Setup: Dual.

17.2.5 External Counter

Press **FrCntr** soft-key to access the counter capabilities of the instrument. Please see the External Counter section for more information.

Once instrument parameters are set, press the **Done** soft-key to return to the utility menu.

17.3 I/O

Pressing the **I/O** soft-key shows the remote interface menu. This allows activation and control of the installed interfaces.

See 'Remote Interface Operation' section 22 for full details of the use of the interfaces.

17.4 Calibration

Pressing the **Calib** soft-key shows the opening screen for instrument calibration.

Full details on calibration may be found in 'Calibration' section 21.2.

17.5 Dual Channel Operation

Pressing the **Dual Ch** soft-key gives access to the dual channel capabilities of the instrument.

See Dual Channel Operation in 'Specification' section 3 for full details of these capabilities.

17.6 Help

This soft-key gives access to the Help menu which is explained in the 'Help Operations' section 19.

18. Stores Menu

The stores menu gives access to both the instrument's local storage of arbitrary waveforms and parameter set-ups and to the external storage of a connected USB flash drive. There are facilities for saving and recalling set-ups to and from local stores, deleting set-ups and arbitrary waveforms and copying waveforms and set-up files to and from a USB flash drive. It is possible to save a waveform from a PC to a USB flash drive and then copy the waveform into the instrument for use.

18.1 Flash Drive Files and Folders

The instrument uses the folder called \TGF3XX2 for all file storage. This folder contains up to three more folders used as follows:

1. \TGF3XX2\WAVES. This folder is used to store arbitrary waveforms. It is the only place where the instrument will look for waveform files. A waveform file has a file extension of .WFM. Files with any other extension will be ignored.
2. \TGF3XX2\SETUPS. This folder is used to store set-ups. It is the only place where the instrument will look for set-up files. A set-up file has a file extension of .SU. Files with any other extension will be ignored.
3. \TGF3XX2\FIRMWARE. This folder, if present, is used to store instrument firmware updates. This is the only place where the instrument will look for firmware update files. There are several types of file that may be in this folder. They should not be tampered with as they are checked by the firmware during use and, if corrupt, could render the instrument non-functional. After a successful update it is safe to delete the files in this folder. This option is offered by the boot-loader code in the instrument.

The instrument is able to read and write flash drives formatted FAT16 or FAT32. The instrument does not generate or use long filenames. A filename can only be up to eight characters in length.

When a new flash drive is attached to the instrument the required folders will be created automatically.

18.2 Using the Stores Menu

Pressing the STORES key will show the stores menu.

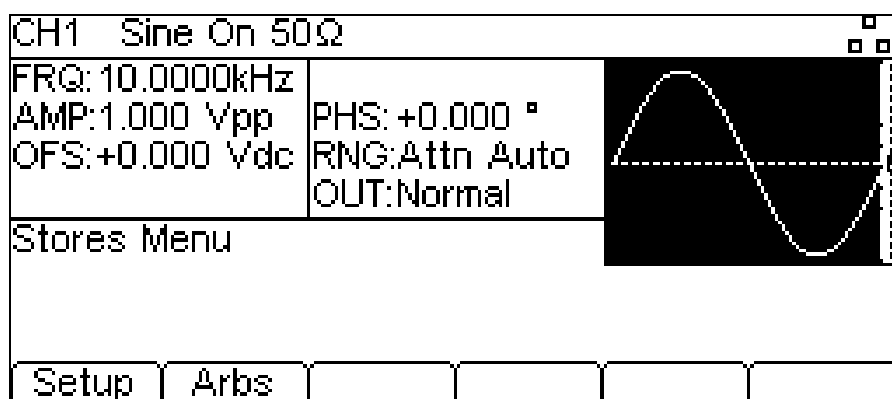

Pressing the **Setup** soft-key displays the setup sub-menu.

The complete settings of the instrument can be saved to internal memory. Up to nine instrument set-ups can be stored internally as files under default or user-defined names. Set-up files can be copied to and from a USB Flash drive.

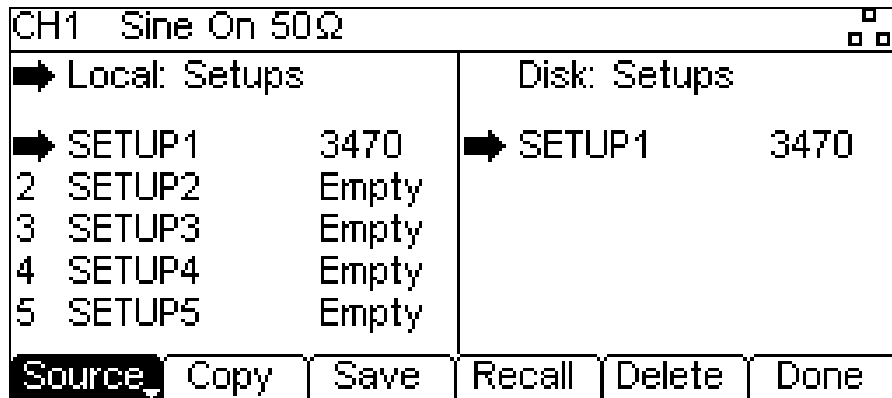

There are now two screen boxes between the Status Line and the Soft-key Labels:

The **Local:** Box on the left contains a list of appropriate local files.

The **Disk:** Box on the right contains a list of the appropriate files on an attached USB flash drive.

If no flash drive is attached the list will read **Please insert the disk**. It is not necessary to attach a flash drive for local only operations.

The top line of each box indicates which file type that the list contains and one box has ➡ (the selection arrow) pointing at the top line. The lists both show ➡ pointing at their selected file. One box is selected and one file from each list is selected. Moving the three selection arrows around defines the file or files that will be operated on by soft-key presses and the direction that data will flow between the files.

The files are listed by name and the number indicates the size of the file in bytes for a set-up file or the number of points in a waveform file.

There are nine local set-up stores and four local arbitrary waveform stores. The respective lists always show all of the stores even if they are empty. An empty store shows **Empty** instead of a size.

Press the **Done** soft-key to return to the top level stores menu.

18.2.1 Selections

The **Source** soft-key selects between local and disk. When local is selected, the selection arrow is in the **Local:** Box. When disk is selected, the selection arrow is in the **Disk:** Box.

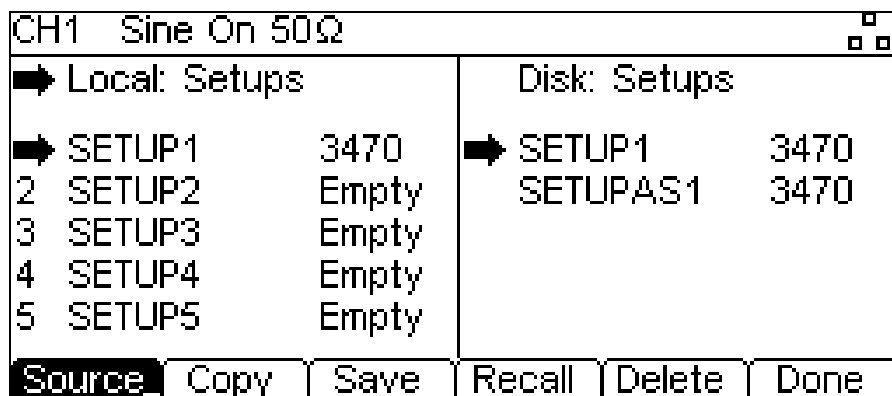

The file selection arrows are moved by first selecting the required box, as above. A file is then selected by turning the KNOB until the selection arrow is next to the required filename. If there are more files than will fit on the screen the list will scroll when the arrow reaches the top or bottom of the box.

18.3 Operations on Set-up Files

There are nine local set-up stores numbered 1 to 9. The number is shown next to the filename in the **Local:** Box. Initially the files will all be empty. The file names are **SETUP1** to **SETUP9** by default but they may be changed as they are used.

There are four operations available for set-up files as shown by the soft-key labels **Copy**, **Save**, **Recall** and **Delete**.

NOTE: The copy operation will not be available if no flash drive is attached.

18.3.1 Copy

The copy operation allows set-up files to be copied between local storage and an attached USB flash drive.

To copy a file from local to disk:

1. Select the **Local:** Box by pressing the **Source** soft-key.
2. Select the file to be copied.
3. Press the **Copy** soft-key.
4. Optionally modify the name of the file to receive the copy. This will default to the name of the file selected in step 2 above if it is not modified.

The screen below shows an example after performing the above actions. Here the file in store 3 will be saved to a set-up file on disk. The name will be **SETUP3** unless it is changed.

CH1		Sine On 50Ω			
➔ Local: Setups		Disk: Setups			
1	SETUP1	3470	➔	SETUP1	3470
2	SETUP2	Empty		SETUPAS1	3470
➔	SETUP3	3470			
4	SETUP4	Empty			
5	SETUP5	Empty			
Source		Copy	Save	Recall	Delete Done

Pressing the **Copy** soft-key will then show the following:

CH1		Sine On 50Ω			
Copy from:		Local	Disk		
Local	Setup:	Setup:			
Copy to:	SETUP3	SETUP3			
Disk	Size: 3470	Size: 3470			
Copy Setup Menu		↓			
Edit Name:		SETUP3			
		Space	↑	Execute	

The **Copy:**Box shows that the source is **Local** and the destination is **Disk**.

The **Local:** Box shows the file that will be written to **Disk**.

The **Disk:** Box and the Edit Box shows the name of the file that will be written and the soft-key labels, the KNOB and cursor keys allow the name to be edited.

NOTE: A name with a length of up to 8 characters can be used.

The cursor keys < > are used to select the character and the KNOB is used to change the character. When the wheel is turned clockwise the characters change in the following order:

0 to 9, A to Z, ^ _ ' { } ~ (space) ! # \$ % & ' () -

Characters can be deleted or spaces created using the **Space** soft-key.

The **↵** key cancels the copy operation and returns to the set-up sub-menu.

The **Execute** soft-key starts the copy operation and returns to the set-up sub-menu when complete.

To copy a file from disk to local:

1. Select the **Local:** Box by pressing the **Source** soft-key.
2. Select the local store to receive the file from disk.
3. Select the **Disk** Box by pressing the **Source** soft-key.
4. Select the file to be copied.
5. Press the **Copy** soft-key.
5. Optionally modify the name of the local store to receive the copy. This will default to the name of the file selected in step 4 above if it is not modified.

The screen below shows an example after performing the above actions. Here the set-up in store 4 will be overwritten by the disk file **SETUPAS1**.

CH1 Sine On 50Ω		Disk: Setups	
Local: Setups		SETUP1	3470
1 SETUP1	3470	➔ SETUPAS1	3470
2 SETUP2	Empty		
3 SETUP3	3470		
➔ SETUP4	Empty		
5 SETUP5	Empty		
Source	Copy		Done

Pressing the **Copy** soft-key will then show the following.

CH1 Sine On 50Ω		
Copy from:	Disk	Local
Disk	Setup:	Setup:
Copy to:	SETUPAS1	SETUPAS1
Local	Size: 3470	Size: 3470
Copy Setup Menu ↓		
Edit Name: SETUPAS1		
	Space	↵ Execute

The **Copy:** Box shows that the source is **Disk** and the destination is **Local**.

The **Disk:** Box shows the file that will be written to **Local** store.

The **Local:** Box and the Edit Box shows the name of the file that will be written and the soft-key labels, KNOB and cursor keys allow the name to be edited as before.

18.3.2 Save

The save operation allows the current instrument set-up to be saved to a local set-up store.

NOTE: Save will function with or without an attached USB flash drive.

To perform a save operation first select the set-up store for the current instrument state to be saved to. Pressing the **Save** soft-key will show a screen similar to that below.

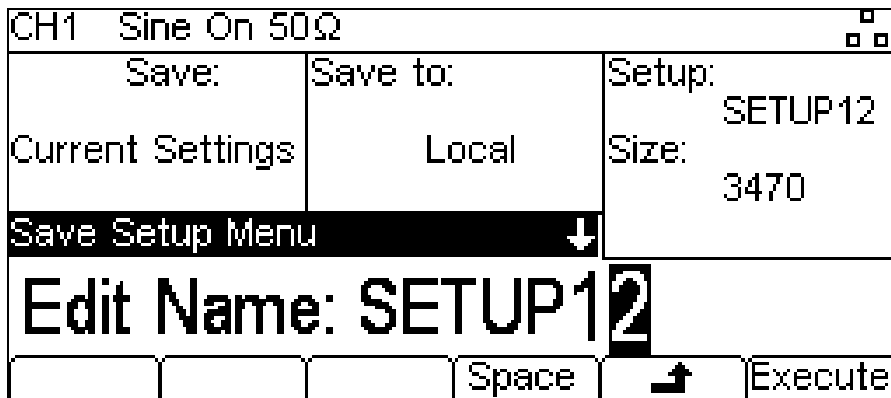

The name offered will be the same as the name in the selected set-up store when the **Save** soft-key was pressed. The Edit Box shows the name of the file that will be saved and the soft-key labels. The KNOB and cursor keys allow the name to be edited.

A name of up to 8 characters can be used.

The cursor keys < > are used to select the character and the KNOB is used to change the character. When the KNOB is turned clockwise the characters change in the following order:

0 to 9, A to Z, ^ _ ' { } ~ (space) ! # \$ % & ' () -

Characters can be deleted or spaces created using the **Space** soft-key.

The **↩** key cancels the save operation and returns to the set-up sub-menu.

The **Execute** soft-key starts the save operation and returns to the set-up sub-menu when complete.

18.3.3 Recall

The recall operation allows the current instrument set-up to be replaced with the set-up from a local store.

NOTE: Recall will function with or without an attached USB flash drive.

To perform a recall operation first select the set-up store containing the instrument state to recall.

Pressing the **Recall** soft-key will then recall the data and load it as the current instrument set-up.

18.3.4 Delete

The delete operation allows the set-up in the selected store to be deleted.

The store will then be marked empty.

Press the **Done** soft-key to return to the top level stores menu.

18.4 Operations on Waveform files

CH1 Sine On 50Ω	
➔ Local: Waveforms	Disk: Waveforms
➔ ARB1 4	➔ ARB1 4
2 ARB2 4	ARBWAVE 8192
3 ARB3 4	
4 ARB4 4	
Source Copy	Delete Done

Pressing the **Arbs** soft-key displays the waveform sub-menu.

There are four local arbitrary waveform stores numbered **1** to **4**. The number is shown next to the file name in the **Local:** Box. Initially the files are all set to the default four point square-wave. The file names are set as **ARB1** to **ARB4** by default but they may be changed as they are used.

Each arbitrary waveform store can hold a waveform with a maximum of 8192 points.

There are two operations available for waveform files as shown by the soft-key labels **Copy** and **Delete**.

NOTE: The copy operation will not be available if no USB flash drive is attached.

18.4.1 Copy

The copy operation allows waveform files to be copied between local storage and an attached USB flash drive.

To copy a file from local to disk:

1. Select the **Local:** Box by pressing the **Source** soft-key.
2. Select the file to be copied.
3. Press the **Copy** soft-key.
4. Optionally modify the name of the file to receive the copy. This will default to the name of the file selected in step 2 above if it is not modified.

The screen below shows an example after performing the above actions. Here the file in store **3** will be saved to a waveform file on disk. The name will be **ARB3** unless it is changed.

CH1 Sine On 50Ω	
➔ Local: Waveforms	Disk: Waveforms
1 ARB1 4	➔ ARB1 4
2 ARB2 4	ARBWAVE 8192
➔ ARB3 4	
4 ARB4 4	
Source Copy	Delete Done

Pressing the **Copy** soft-key will then show the following.

CH1 Sine On 50Ω		
Copy from: Local	Local Waveform: ARB3 Points: 4	Disk Waveform: ARB3 Points: 4
Copy to: Disk	Copy Waveform Menu ↓	
Edit Name: ARB3		
	Space	Execute

The **Copy**: Box shows that the source is **Local** and the destination is **Disk**.

The **Local**: Box shows the file that will be written to **Disk**.

The **Disk**: Box and the Edit Box shows the name of the file that will be written and the soft-key labels, the KNOB and cursor keys allow the name to be edited.

NOTE: A name with a length of up to 8 characters can be used.

The cursor keys < > are used to select the character and the KNOB is used to change the character. When the KNOB is turned clockwise the characters change in the following order:

0 to 9, A to Z, ^ _ ' { } ~ (space) ! # \$ % & ' () -

Characters can be deleted or spaces created using the **Space** soft-key.

The ↵ key cancels the copy operation and returns to the arbs sub-menu.

The **Execute** soft-key starts the copy operation and returns to the arbs sub-menu when complete.

To copy a file from disk to local:

1. Select the **Local**: Box by pressing the **Source** soft-key.
2. Select the local store to receive the file from disk.
3. Select the **Disk**: Box by pressing the **Source** soft-key.
4. Select the file to be copied.
5. Press the **Copy** soft-key.
6. Optionally modify the name of the file to receive the copy. This will default to the name of the file selected in step 4 above if it is not modified

The screen below shows an example after performing the above actions. Here the waveform in store 4 will be overwritten by the disk file ARBWAVE.

CH1 Sine On 50Ω		
Local: Waveforms	➡	Disk: Waveforms
1 ARB1 4		ARB1 4
2 ARB2 4	➡	ARBWAVE 8192
3 ARB3 4		
➡ ARB4 4		
Source	Copy	Done

Pressing the **Copy** soft-key will then show the following.

CH1 Sine On 50Ω		
Copy from: Disk	Disk Waveform: ARBWAVE Points: 8192	Local Waveform: ARBWAVE Points: 8192
Copy to: Local		
Copy Waveform Menu ↓		
Edit Name: ARBWAVE		
	Space	↑ Execute

The **Copy:** Box shows that the source is **Disk** and the destination is **Local**.

The **Disk:** Box shows the file that will be written to **Local** store.

The **Local:** Box and the Edit Box shows the name of the file that will be written and the soft-key labels, the KNOB and cursor keys allow the name to be edited.

A name with a length of up to 8 characters can be used.

The cursor keys < > are used to select the character and the KNOB is used to change the character. When the KNOB is turned clockwise the characters change in the following order:

0 to 9, A to Z, ^ _ ' { } ~ (space) ! # \$ % & ' () -

Characters can be deleted or spaces created using the **Space** soft-key.

The **↑** key cancels the copy operation and returns to the set-up sub-menu.

The **Execute** soft-key starts the copy operation and returns to the set-up sub-menu when complete.

18.4.2 Delete

The delete operation allows the waveform in the selected store to be deleted.

The store will contain the default four point square-wave after waveform deletion.

Press the **Done** soft-key to return to the top level stores menu.

19. Help Operations

The instrument has a comprehensive help system which allows easy access to any Help page.

It is possible to get help in two ways:

1. Help menu. Press the UTILITY and then press **Help** soft-key to access a list of help topics which give general information about instrument operations.
2. Context sensitive help. Press and hold down any key, including soft-keys, for two seconds to access the Help page for that key.

There are two types of help screen.

1. The Help menu. This is the screen that gives a list of general help topics.
2. The Help topic screen. This is the screen that displays actual help texts.

19.1 Help menu

Pressing Utility key and then **Help** soft-key will display the Help menu.



The Help menu uses all the screen space between the Status Line and the Soft-key Labels and contains a list of help topics. To show a topic use the **←** and **→** soft-keys to move the highlight back or forward through the list to select the required topic, then press the **Select** soft-key to show the topic screen.

Press the **Done** soft-key to exit from the Help menu.

19.2 Help Topics

Selecting a Help topic from the Help menu or initiating context sensitive help will show a Help topic screen similar to that shown below.

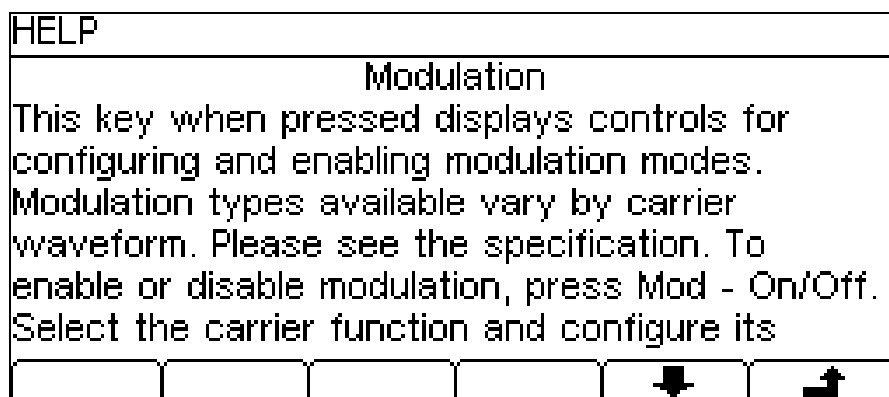

Below the topic heading is the topic text. If there is more text than will fit on the screen press the **↓** soft-key to scroll the text up one line. Continue scrolling until there is no more text indicated by the **↓** soft-key label disappearing. Once the text has been scrolled the **↑** soft-key may be used to scroll the text up one line. Pressing the **↑** soft key will return to the previous screen.

20. Editing Arbitrary Waveforms

The instrument contains some basic editing capabilities for arbitrary waveforms. The supplied Waveform Manager Plus V4.11 Windows application may be used when more comprehensive capabilities for creation and editing are required. Waveforms created in Waveform Manager Plus may be downloaded to the instrument via a remote control interface or they may be transferred using a USB flash drive.

20.1 Selecting an Arbitrary Waveform for Editing

To use the instrument to edit an existing arbitrary waveform press the **ARB** key then press the **Arbs** soft-key followed by the **Edit** soft-key.

The existing arbitrary waveforms appear on the first four soft-keys; the name is shown in the Edit Box and the selected arb is shown in the Graph Box if it is the currently selected arbitrary waveform. Select the required waveform.

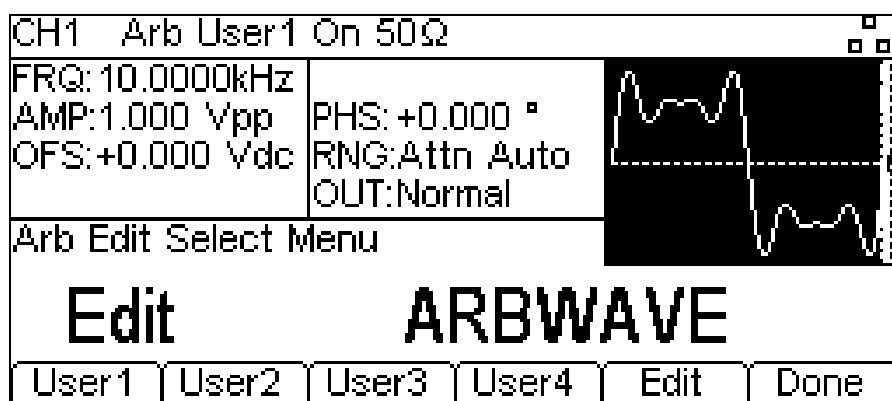

Press the **Edit** Soft-key to show the edit menu.

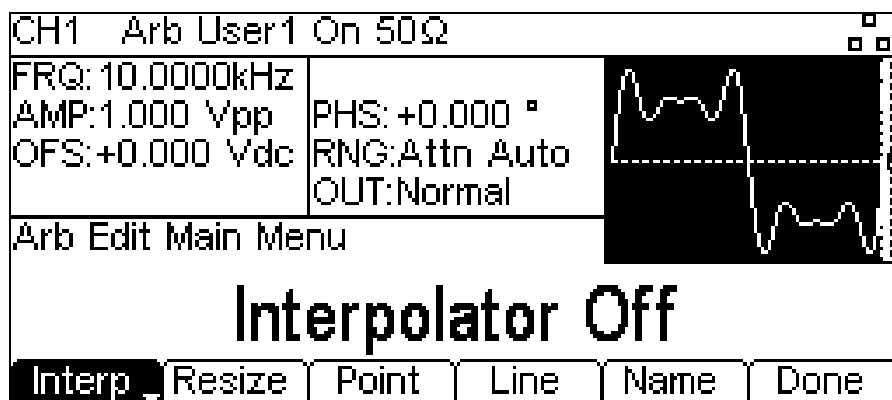

While editing an arbitrary waveform, if the same arbitrary waveform is also currently selected to be the output, then the changes made to the arbitrary waveform can be observed in real time. The waveform will be available at the MAIN OUT connector of the selected channel for display on an oscilloscope. There will also be a representation shown in the Graph Box.

20.2 Editing an Arbitrary waveform

There are five editing options for arbitrary waveforms.

20.2.1 Interpolation

Interpolation is toggled on and off by the **Interp** soft-key. Although the instrument can handle arbitrary waveforms of any length they are always played back using DDS. This requires that they must be forced to a suitable length. The instrument can play a waveform of 8192 (8k) points. If a waveform is less than or equal to 8k points it will be played back using 8k points. So in order to play the waveform it may be necessary to expand it.

This expansion may be performed in 2 possible ways. Either the extra points may be created by repeating the same points or linear interpolation may be used.

The **Interp** soft-key allows the type of expansion to be specified. With **Interpolator Off** selected points will be repeated, this is most appropriate for waveforms with fast rising or falling edges. With **Interpolator On** selected linear interpolation will be used as points are added, this is most appropriate for waveforms which are more sinusoidal in nature.

NOTE: For a truly complex waveform it should be created with 8k points so that expansion is not required.

20.2.2 Resizing a waveform

A waveform may have its length changed by using the resize option. When a waveform is increased in size new points are added between existing points. The way that the values of these new points are calculated depends on the resize method setting. When a waveform is reduced in size points are simply dropped to achieve the new length.

Pressing the **Resize** soft-key will show the resize menu in the Edit Box and the soft-keys will show the resize options.

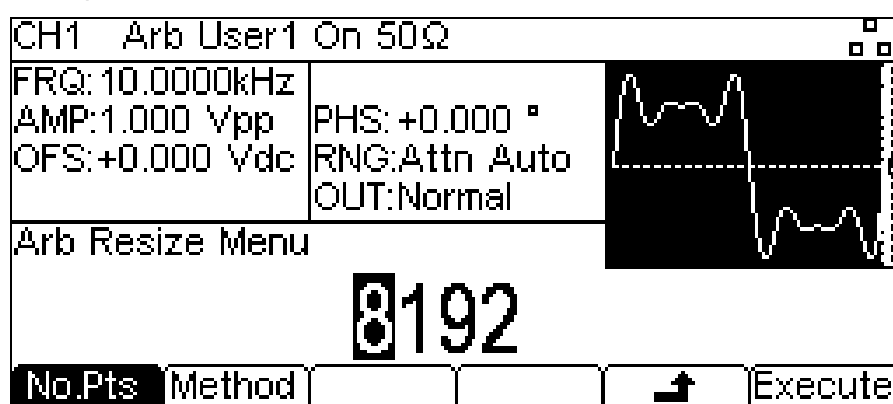

The **No.Pts** soft-key allows the new size to be specified. Press the **Execute** soft-key to resize the waveform and return to the top level edit menu. Pressing the **↕** soft-key will return without resizing.

Pressing the **Method** soft-key will allow the resize method to be set.

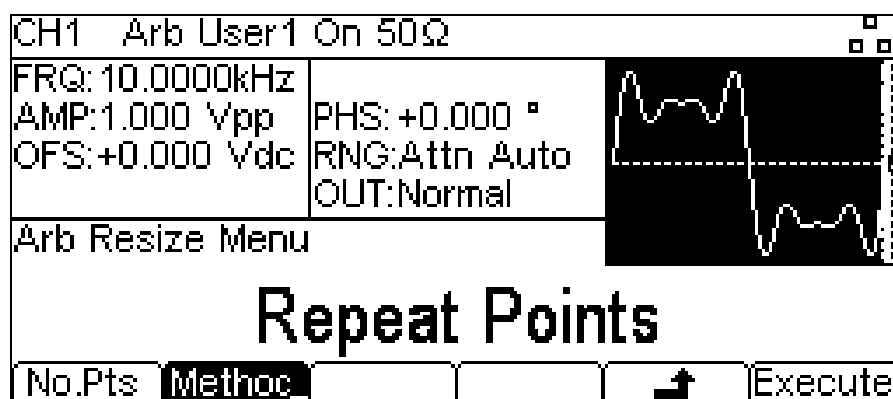

When a waveform is increased in size new points are added between existing points. The way that the values of these new points are calculated depends on the resize method setting, The **Repeat Points** method adds points of the same value as the original point in the waveform. The **Interpolate** method draws a straight line between the existing points.

When a waveform is reduced in size points are simply dropped to achieve the new length and the resize method setting has no effect.

20.2.3 Point Editing

Pressing the **Point** soft-key shows the point edit menu in the Edit Box.

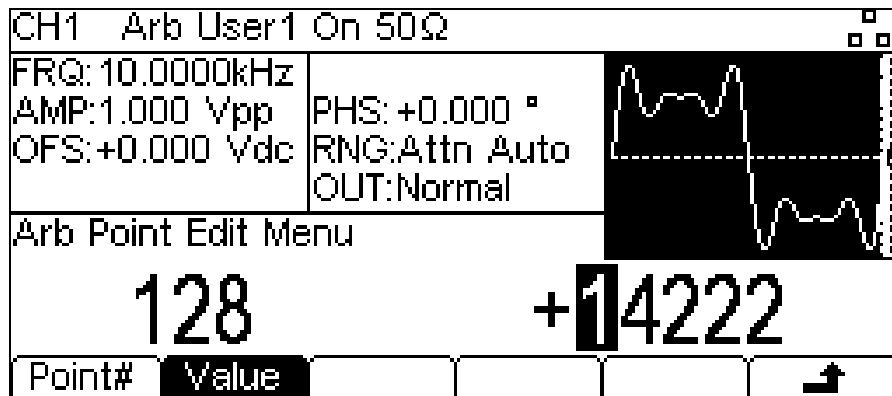

The point edit menu allows individual points in the waveform to be set to any vertical level value. The **Point#** soft-key selects setting of the point number; pressing the **Value** soft-key then enables the value to be changed.

NOTE: The point value is changed in the actual waveform immediately after it is edited.

20.2.4 Line Drawing

Pressing the **Line** soft-key shows the line edit menu in the Edit Box.

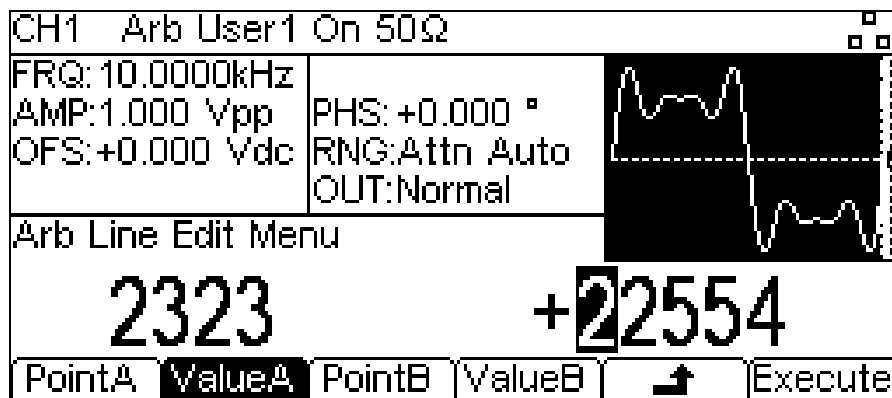

The Line edit menu allows a line to be drawn between any two points in the waveform. The end points of the line may be set to any vertical level value.

The **PointA** soft-key selects setting of the first point number; pressing the **ValueA** soft-key then enables the value to be changed. The **PointB** and **ValueB** soft-keys are used to set the second point. The line is drawn in the actual waveform by pressing the **Execute** soft-key after which the instrument will return to the top level edit menu.

Pressing the **↕** soft-key will return without drawing the line.

20.2.5 Naming a Waveform

Pressing the **Name** soft-key shows the name edit menu in the Edit Box.

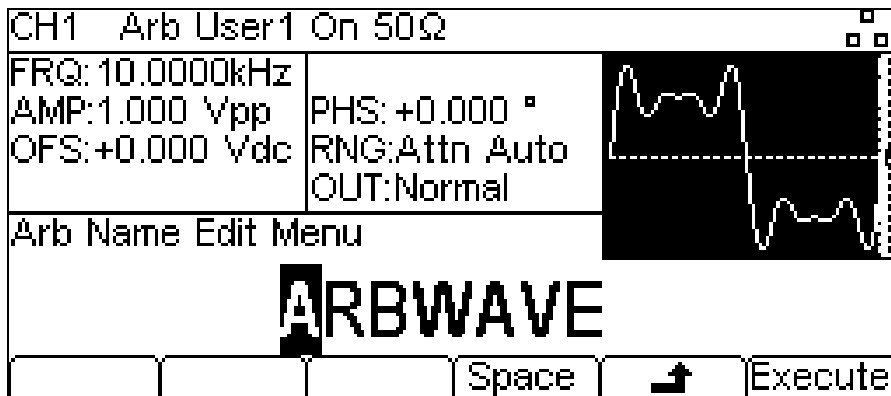

The soft-key labels, KNOB and cursor keys allow the name to be edited.

The **Space** soft-key enters a space character at the cursor position.

The **↑** soft-key cancels the operation and returns to the top level edit menu.

The **Execute** soft-key changes the name and returns to the top level edit menu when complete

The cursor keys will move the edit cursor through the name and turning the KNOB will cycle through all valid characters, numbers and symbols.

Press the **Done** soft-key to exit the edit menu.

21. Calibration

All parameters can be calibrated without opening the case, i.e. the generator offers 'closed-box' calibration. All adjustments are made digitally with calibration constants stored in flash memory. The calibration routine requires only a DVM, power meter and a frequency counter and takes no more than a few minutes.

Calibration should be carried out only after the generator has been operating for at least 30 minutes in normal ambient conditions.

21.1 Equipment Required

- 3½ digit DVM with 0.25% DC accuracy and 0.5% AC accuracy at 1kHz.
- Universal counter capable of measuring 10-00000MHz with an accuracy of ±0.1ppm.
- Power meter with frequency range of 10kHz to 160MHz, capable of measuring up to a +5dBm signal with linearity better than 0.1dB

21.2 Calibration Procedure

Pressing the UTILITY key followed by the **Calib** soft-key shows the opening screen for instrument calibration.

CH1 Sine On 50Ω		□ □ □
Calibration. Are you sure? Yes - 'Cont'n'. No - 'Done'.	You will need 3.5 digit DVM and power & frequency meter	Press 'Tests' to test Keys, Knob and RAM or 'Pswrd' to set / edit password
Utility Calibration Menu		
Cont'n	Tests	Pswrd
		Done

The software asks for a 4-digit password in the range 0000 to 9999 to be used to access the calibration procedure. If the password is left at the factory default of 0000 no messages are shown and calibration can proceed as described in the Calibration Routine section; only if a non-zero password has been set will the user be prompted to enter the password.

21.2.1 Setting the Password

On opening the Calibration screen press the **Pswrd** soft-key to show the password screen:

New Password					
					↩

Enter a 4-digit password from the keyboard; the Edit Box will show the message Confirm. Re-enter the password and the message **NEW PASSWORD STORED** will pop up for two seconds before returning to the top level calibration menu.

21.2.2 Using the Password to Access Calibration or Change the Password

With the password set, pressing **calib** on the utility screen will now show:

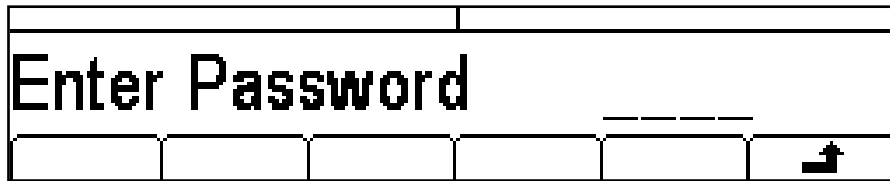

When the correct password has been entered from the keyboard the display changes to the opening screen of the calibration routine and calibration can proceed as described in the Calibration Routine section. If an incorrect password is entered the message **Incorrect Password Please Try Again** will pop up for two seconds before the display reverts to the Utility menu.

With the opening screen of the calibration routine displayed after correctly entering the password, the password can be changed by pressing the **Pswrd** soft-key and following the procedure described in Setting the Password. If the password is set to 0000 again, password protection is removed.

The password is held in flash memory and will not be lost when the memory battery back-up is lost. In the event of the password being forgotten, contact the manufacturer for help in resetting the instrument.

21.3 Calibration Routine

The calibration procedure proper is entered by pressing **Cont'n** on the top level Calibration menu; pressing **Done** returns the display to the Utility menu. Pressing **Tests** calls a menu of basic hardware checks used at production test; these are largely self-explanatory.

At each calibration step the display changes to prompt the user to adjust the KNOB or cursor keys, until the reading on the specified instrument is at the value given. The cursor keys provide coarse adjustment, and the KNOB fine adjustment. Pressing **➡** increments the procedure to the next step; pressing **⬅** decrements back to the previous step. Alternatively, pressing **Cancel** returns the display to the final calibration screen at which the user can choose to either **Save**, **recall** or **Restart**.

Each calibration step allows a calibration value to be calibrated. The screen messages specify the instrument to use for measurement, the connector to connect it to, the value to adjust for and the method of adjustment

The full procedure is as follows:

STEP 1	CH1 DC offset zero.	Adjust for 0V ± 5mV
STEP 2	CH1 DC offset at + full scale.	Adjust for + 10V ± 10mV
STEP 3	CH1 DC offset at – full scale.	Check for –10V ± 50mV
STEP 4	CH1 output level at full scale	Adjust for 10V ± 10mV
STEP 5	CH1 6dB attenuation	Adjust for 5V ± 5mV
STEP 6	CH1 12dB attenuation	Adjust for 2.5V ± 3mV
STEP 7	CH1 18dB attenuation	Adjust for 1.25V ± 3mV
STEP 8	CH1 24dB attenuation	Adjust for 625mV ± 3mV
STEP 9	CH1 30dB attenuation	Adjust for 312.5mV ± 3mV
STEP 10	CH1 36dB attenuation	Adjust for 156.25mV ± 3mV
STEP 11	CH1 42dB attenuation	Adjust for 78.125mV ± 3mV
STEP 12	CH1 Sine amplitude flatness	Note reading

STEP 13	CH1 level 200kHz	Adjust for same reading
STEP 14	CH1 Level 10MHz	Adjust for same reading
STEP 15	CH1 Level 40MHz	Adjust for same reading
STEP 16	CH1 Level 50MHz	Adjust for same reading
STEP 17	CH1 Level 90MHz	Adjust for same reading
STEP 18	CH1 Level 100MHz	Adjust for same reading
STEP 19	CH1 Level 125MHz	Adjust for same reading
STEP 20	CH1 Level 135MHz	Adjust for same reading
STEP 21	CH1 Level 145MHz	Adjust for same reading
STEP 22	CH1 Level 160MHz	Adjust for same reading
STEP 23	CH2 DC offset zero.	Adjust for $0V \pm 5mV$
STEP 24	CH2 DC offset at + full scale.	Adjust for $+ 10V \pm 10mV$
STEP 25	CH2 DC offset at – full scale.	Check for $-10V \pm 50mV$
STEP 26	CH2 output level at full scale	Adjust for $10V \pm 10mV$
STEP 27	CH2 6dB attenuation	Adjust for $5V \pm 5mV$
STEP 28	CH2 12dB attenuation	Adjust for $2.5V \pm 3mV$
STEP 29	CH2 18dB attenuation	Adjust for $1.25V \pm 3mV$
STEP 30	CH2 24dB attenuation	Adjust for $625mV \pm 3mV$
STEP 31	CH2 30dB attenuation	Adjust for $312.5mV \pm 3mV$
STEP 32	CH2 36dB attenuation	Adjust for $156.25mV \pm 3mV$
STEP 33	CH2 42dB attenuation	Adjust for $78.125mV \pm 3mV$
STEP 34	CH2 Sine amplitude flatness	Note reading
STEP 35	CH2 level 200kHz	Adjust for same reading
STEP 36	CH2 Level 10MHz	Adjust for same reading
STEP 37	CH2 Level 40MHz	Adjust for same reading
STEP 38	CH2 Level 50MHz	Adjust for same reading
STEP 39	CH2 Level 90MHz	Adjust for same reading
STEP 40	CH2 Level 100MHz	Adjust for same reading
STEP 41	CH2 Level 125MHz	Adjust for same reading
STEP 42	CH2 Level 135MHz	Adjust for same reading
STEP 43	CH2 Level 145MHz	Adjust for same reading
STEP 44	CH2 Level 160MHz	Adjust for same reading
STEP 45	MOD offset	Adjust for $5V \pm 50mV$
STEP 46	MOD full scale	Adjust for $8V \pm 50mV$
STEP 47	Ref clock calibration	Adjust for $10.00000 \text{ MHz} \pm 1\text{ppm}$

21.4 Remote Calibration

Calibration of the instrument may be performed over the LAN, USB or GPIB interface. To completely automate the process the multimeter, power meter and universal counter will also need to be remote controlled and the controller will need to run a calibration program unique to this instrument.

The remote calibration commands allow a simplified version of manual calibration to be performed by issuing commands from the controller. The controller must send the CALADJ command repeatedly and read the DVM, power meter or frequency meter until the required result for the selected calibration step is achieved. The CALSTEP command is then issued to accept the new value and move to the next step.

While in remote calibration mode very little error checking is performed and it is the controllers responsibility to ensure that everything progresses in an orderly way. Only the following commands should be used during calibration.

WARNING: Using any other commands while in calibration mode may give unpredictable results and could cause the instrument to lock up, requiring the power to be cycled to regain control.

CALIBRATION <cpd>, [nr1] : The calibration control command. <cpd> can be one of three sub-commands:-

START - Enter calibration mode; this command must be issued before any other calibration commands will be recognised.

SAVE - Finish calibration, save the new values and exit calibration mode.

ABORT - Finish calibration, do not save the new values and exit calibration mode.

[nr1] represents the 4-digit calibration password. The password is only required with CALIBRATION START and then only if a non-zero password has been set from the instrument's keyboard. The password will be ignored, and will give no errors, at all other times.

It is not possible to set or change the password using remote commands.

CALADJ <nr1> Adjust the selected calibration value by <nr1>. The value must be in the range -100 to +100. Once an adjustment has been completed and the new value is as required the CALSTEP command must be issued for the new value to be accepted.

CALSTEP Step to the next calibration point.

For general information on remote operation and command formats, refer to the following remote sections.

22. Remote Interface Operation

The instrument can be remotely controlled via its USB, LAN or (optional) GPIB interfaces.

USB remote control operates in a similar way to an RS232 interface but via the USB connector. Software supplied with the instrument sets up the controlling computer to treat the USB connection as a virtual COM port. Application software on the computer can then access the instrument via that COM port.

The LAN interface is designed to meet LXI (LAN eXtensions for Instrumentation) Core 2011. Remote control using the LAN interface is possible using the TCP/IP Sockets protocol. The instrument also contains a basic Web server which provides information on the instrument and allows it to be configured from a web browser. Simple command line control from the browser is also possible.

The instrument is supplied with USB and LAN as standard; GPIB is an option. All interfaces are live at initial power up but access to individual interfaces may be restricted using the menus on the front panel or the configuration options on the web pages. To control the restriction of interfaces from the front panel select UTILITY, then the I/O soft-key to show the screen below.

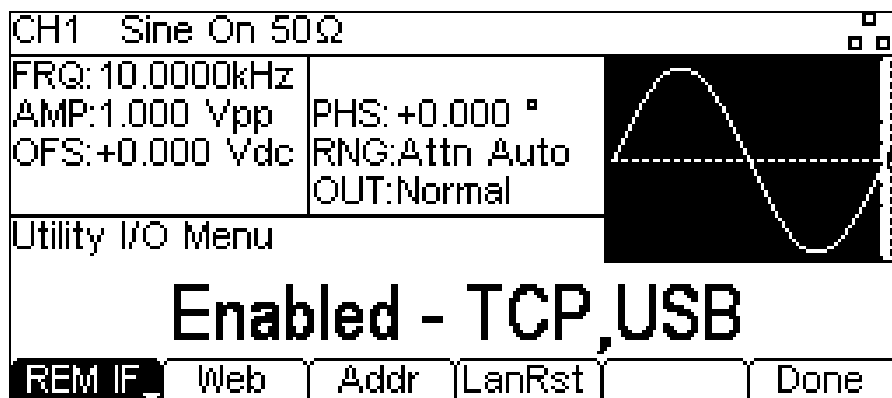

The default is for all available interfaces to be enabled as shown. The **REM IF** softkey may be used to select the interfaces required. Pressing the **REM IF** key will cycle round the possibilities, in this case **Enabled - TCP, USB**, **Enabled - TCP only** and **Enabled - USB Only**. TCP is used instead of LAN because the LAN itself is not disabled and could still be used to access the instrument web server, Disabling TCP does, however, disable the web page command line control of the instrument.

The web page access may also be disabled independently by pressing the Web soft-key. Alternate presses will produce **Enabled - WEBPAGE** and **Disabled - WEBPAGE**.

22.1 Address Selection

The instrument address capability is strictly required only by the GPIB interface. However, use can be made of the ADDRESS? command over any of the interfaces to easily identify which instrument is being controlled by a particular COM port (for USB) or TCP socket (for LAN). Note that the LAN interface also has a separate 'Identify' function, accessible from the instrument's web pages, that flashes the instrument's display until the function is cancelled.

The address is set from the instrument's front panel or web pages. To set the address from the front panel press the **Addr** soft-key on the Utility-I/O menu which will show the following.

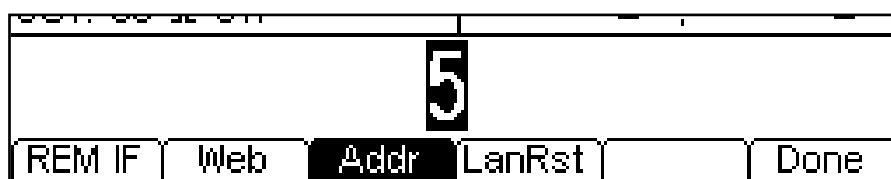

22.2 Remote/Local Operation

At power-on the instrument will be in the local state so the REM indicator is not displayed on the Status Line. In this state all front panel operations are possible. When the instrument receives a command from an interface the remote state will be entered and the REM indicator will be displayed on the Status Line. In this state the front panel is locked out and remote commands only will be processed. The instrument may be returned to the local state by pressing the LOCAL key; however, the effect of this action will only remain until the instrument receives another character from the interface, when the remote state will once again be entered. Returning to Local by this action will keep the settings at their last remotely set values.

22.3 USB Interface

Using the USB interface for remote control requires a Communications Device Class driver on the PC to provide a virtual COM port instance. In Windows a suitable driver is provided by Microsoft, but it is not installed by default. The data (.INF) file to control the installation is provided on the Product Documentation CD delivered with the unit; however the same driver is also used by many other instruments from this manufacturer and may already be known to the PC.

In Windows 10, the driver is automatically installed by the operating system.

To install the driver for the first time, first switch the unit on, and then connect the USB port to the PC. The Windows plug and play functions should automatically recognise the attachment of new hardware to the USB interface and (possibly after searching the internet for some time) prompt for the location of a suitable driver. Follow the Windows prompts and point to the CD, then the sub-directory for this product, and then to the USB Driver sub-directory below that. The file is named USB_ARM_VCP_xxx.INF, where xxx is a version number. (A readme.pdf file will also be found in that directory if further assistance is needed.)

In some cases Windows will not complete this procedure (especially recent versions which search the internet first, looking for the unique Vendor ID and Product ID), in which case the instrument will show in Device Manager as “not working properly”. If this happens, select this device, right click and choose “update driver software...” and then “browse this computer for driver software...” and then locate the .INF file on the CD as described above.

Once Windows has installed the device driver it will assign a COM port number to this particular unit. This number will depend on previous COM port assignments on this PC, and it may be necessary to use Device Manager to discover it. Each instrument has a unique USB identifier which is remembered by the system, so it will receive the same COM port number whenever it is attached to the same PC (regardless of the physical interface socket used), even though the COM port will disappear while the instrument is disconnected or switched off. Other instruments will receive different COM port numbers.

Note that a different PC will not necessarily assign the same COM port number to a particular instrument (it depends on the history of installations), however Device Manager can be used to change the assignments given.

This virtual COM port can be driven by Windows applications (including a terminal emulator) in exactly the same way as any standard COM port, except that the Baud rate and other settings are unnecessary and are ignored. Some old applications might not function with COM port numbers 3 or 4, or above 9. In this case, use Device Manager to change the allocation given. Once it is installed, the driver will be maintained by Windows Update in the usual way.

22.4 LAN Interface

The LAN interface is designed to comply with the LXI standard version 1.4 LXI Core 2011 and contains the interfaces and protocols described below. Since it is possible to misconfigure the LAN interface, making it impossible to communicate with the instrument over LAN, a LAN Configuration Initialise (LCI) mechanism is provided via the menus from the front panel to reset the instrument's interfaces to the factory default. The default setting is for the instrument to attempt to obtain settings via DHCP if available or, if DHCP times out (30 seconds), via Auto-IP.

In the very unlikely event that an Auto-IP address cannot be found a static IP address of 192.168.0.100 is assigned. Resetting the LAN removes any password protection which has been set on the web page.

To reset the LAN interface press the **LanRst** soft-key on the Utility-I/O menu.

For more information on LXI standards refer to www.lxistandard.org



22.4.1 LAN Connection

To use the LAN interface, the IP address of the unit must be known. On the supplied CD-ROM is a guide to the LXI Discovery Tool which provides links to the latest version of the tool and associated downloads. The tool is a Windows PC application which can be used to display the IP addresses or host names of all connected devices that comply with the VXI-11 protocol or support multicast Domain Name System (mDNS) records.

Connecting via a router is recommended as this is significantly quicker to assign an IP address; connecting directly to the PC will begin to assign an IP address only after a 30 second DHCP time-out. Double clicking on any entry in the list of devices discovered will open the PC's web browser and display the Home page of that device.

There are also tools for LAN discovery included as part of the National Instruments Measurement and Automation Explorer package and the Keysight (formerly Agilent) Vee application.

It is also possible to discover the assigned IP address from the Help menu. Press the Utility key followed by the Help soft-key, then select option 3 and scroll down to the IP address.

The unit will, when first powered up, attempt to obtain settings via DHCP if available or, if DHCP times out (30 seconds), via Auto-IP. In the very unlikely event that an Auto-IP address cannot be found a static IP address of 192.168.0.100 is assigned. **During this time the LAN indicator will keep flashing and change to  if a LAN connection is successfully made.** However, if a connection is still not made by the end of the above process, or if the LAN connector is physically removed at any time, the LAN field in the status line will change to ; see LAN Error section for details.

22.4.2 Web Server; Configuration Password Protection

The unit contains a basic web server. This provides information on the instrument and allows it to be configured. The Configure page can be password protected to deter unauthorised changes to the remote operation configuration; the default configuration is 'no password'.

The Configure page itself explains how to set the password. The password can be up to 15 characters long; note that the User Name should be left blank. The password will, however, be reset to the default (no password) if the front panel is used to reset all the LAN parameters to their factory default.

The web pages also have an 'Identify' function which allows the user to send an identifying command to the instrument which causes its display to flash until the command is cancelled.

22.4.3 ICMP Ping Server

The unit contains an ICMP server allowing the instrument to be 'pinged' via either its host name or IP address.

22.4.4 VXI-11 Discovery Protocol

The instrument has very limited support of VXI-11 which is sufficient for the discovery protocol and no more.

The instrument implements a Sun RPC Port-mapper on TCP port 111 and UDP port 111 as defined in RPC1183. The calls supported are: NULL, GET PORT and DUMP.

On TCP port 1024 a very simple VXI-11 protocol is implemented sufficient only for instrument discovery. This implements the following calls: CREATE LINK, DEVICE_WRITE, DEVICE_READ and DESTROY_LINK.

Once a link has been created anything written to the device is ignored and any read from the device returns the identification string as would be expected from a “*IDN?” command of the form

‘Manufacturer, Model, Serial No., XX.xx – YY.yy’ – ZZ.zz

where ‘XX.xx’ is the revision of the main firmware and ‘YY.yy’ is the revision of the remote interface firmware and ‘ZZ.zz’ is the revision of the USB flash drive firmware.

22.4.5 mDNS and DNS-SD Support

Multicast DNS provides DNS services even on networks without a central DNS server (or DHCP server). This simplifies the setting up of a simple LAN using meaningful hostnames instead of a raw IP address. With service discovery it becomes straightforward for the device to be discovered and the services it provides.

The services provided by the instrument are http (`_http._tcp`) and lxi (`_lxi._tcp`).

22.4.6 VISA Resource Name

Because of the limited support for VXI-11(Discovery Protocol only), the instrument must be referred to by its raw socket information when used in software packages which communicate via a VISA resource name. For example, an instrument at IP address 192.168.1.100 would normally have a VISA resource name of "TCPIP0::192.168.1.100::inst0::INSTR" but for this instrument the name must be modified to read "TCPIP0::192.168.1.100::9221::SOCKET" where 9221 is the TCP port used by this instrument for control and monitoring, see below.

22.4.7 XML Identification Document URL

As required by the LXI Standard, the instrument provides an XML identification document that can be queried via a GET at “`http://<hostname>:80/lxi/identification`” that conforms to the LXI XSD Schema (available at <http://www.lxistandard.org/InstrumentIdentification/1.0>) and the W3C XML Schema Standards (<http://www.w3.org/XML/Schema>). This document describes the instrument.

22.4.8 TCP Sockets





The instrument uses 1 socket on TCP port 9221 for instrument control and monitoring. Text commands are sent to this port as defined in ‘Remote Commands’ and any replies are returned via the same port. Commands may be separated with either semicolons “;” or line feeds.

22.4.9 LAN Error

If a LAN connection is made but an error is detected (e.g. the IP address is the same as another device on the network) then the LAN field in the status line will show  until the error is corrected. If a LAN error occurs; check and correct the configuration of the instrument; a LAN Configuration Initialise (LCI) mechanism is provided via a recessed switch on the rear panel (marked LAN RESET) to reset the unit to the factory default. The default setting is for the instrument to attempt to obtain settings via DHCP if available or, if DHCP times out (30 seconds), via Auto-IP. In the very unlikely event that an Auto-IP address cannot be found a static IP address of 192.168.0.100 is assigned.

If no physical LAN connection is found at any time the LAN field in the status line will show  .

22.4.10 LAN Status indication

The LAN field in the Status Line can show multiple status indications. When there is no LAN connection, for example no cable connected, the field will show  . While the system is attempting to connect the icon will flash. When successfully connected with remote control enabled the field will show  . If connected but remote control is disabled it will show  . Finally an unsuccessful attempt to connect will show  .

22.5 GPIB Interface

The GPIB interface 24-way connector is located on the instrument rear panel. The pin connections are as specified in IEEE Std. 488.1-1987 and the instruments in the range complies with IEEE Std. 488.1-1987 and IEEE Std. 488.2-1987 and contain the following IEEE 488.1 subsets.

22.5.1 GPIB Subsets

This instrument contains the following IEEE 488.1 subsets:

Source Handshake	SH1
Acceptor Handshake	AH1
Talker	T6
Listener	L4
Service Request	SR1
Remote Local	RL2
Parallel Poll	PP1
Device Clear	DC1
Device Trigger	DT0
Controller	C0
Electrical Interface	E2

22.5.2 GPIB IEEE Std. 488.2 Error Handling – Query Error Register

The IEEE 488.2 UNTERMINATED error (addressed to talk with nothing to say) is handled as follows. If the instrument is addressed to talk and the response formatter is inactive and the input queue is empty then the UNTERMINATED error is generated. This will cause the Query Error bit to be set in the Standard Event Status Register, a value of 3 to be placed in the Query Error Register and the parser to be reset. See the Status Reporting section for further information.

The IEEE 488.2 INTERRUPTED error is handled as follows. If the response formatter is waiting to send a response message and a <PROGRAM MESSAGE TERMINATOR> has been read by the parser or the input queue contains more than one END message then the instrument has been INTERRUPTED and an error is generated. This will cause the Query Error bit to be set in the Standard Event Status Register, a value of 1 to be placed in the Query Error Register and the response formatter to be reset thus clearing the output queue. The parser will then start parsing the next <PROGRAM MESSAGE UNIT> from the input queue. See the Status Reporting section for further information.

The IEEE 488.2 DEADLOCK error is handled as follows. If the response formatter is waiting to send a response message and the input queue becomes full then the instrument enters the DEADLOCK state and an error is generated. This will cause the Query Error bit to be set in the Standard Event Status Register, a value of 2 to be placed in the Query Error Register and the response formatter to be reset thus clearing the output queue. The parser will then start parsing the next <PROGRAM MESSAGE UNIT> from the input queue. See the Status Reporting section for further information.

22.5.3 GPIB Parallel Poll

Complete parallel poll capabilities are offered on this instrument. The Parallel Poll Enable Register is set to specify which bits in the Status Byte Register are to be used to form the *ist* local message. The Parallel Poll Enable Register is set by the *PRE <nrf> command and read by the *PRE? command. The value in the Parallel Poll Enable Register is ANDed with the Status Byte Register; if the result is zero then the value of *ist* is 0 otherwise the value of *ist* is 1.

The instrument must also be configured so that the value of *ist* can be returned to the controller during a parallel poll operation. The instrument is configured by the controller sending a Parallel Poll Configure command (PPC) followed by a Parallel Poll Enable command (PPE). The bits in the PPE command are shown in the following table:

Bit 7 =	X	don't care
Bit 6 =	1	Parallel poll enable
Bit 5 =	1	
Bit 4 =	0	
Bit 3 =	Sense	sense of the response bit; 0 = low, 1 = high
Bit 2 =	?	bit position of the response
Bit 1 =	?	
Bit 0 =	?	

Example. To return the RQS bit (bit 6 of the Status Byte Register) as a 1 when true and a 0 when false in bit position 1 in response to a parallel poll operation send the following commands

*PRE 64<pmt>, then PPC followed by 69H (PPE)

The parallel poll response from the instrument will then be 00H if RQS is 0 and 01H if RQS is 1.

During parallel poll response the DIO interface lines are resistively terminated (passive termination). This allows multiple devices to share the same response bit position in either wired-AND or wired-OR configuration, see IEEE 488.1 for more information.

22.6 Status Reporting

A separate error and status model is maintained for each interface instance; an interface instance is defined as a potential connection. USB and GPIB are inherently single connections so represent one interface instance each. LAN, however, allows for multiple simultaneous connections and therefore represents multiple interface instances. One interface instance is allocated to the TCP socket interface and one more is allocated to the Web page interface. Having a separate model for each interface instance ensures that data does not get lost as many commands e.g. '*ESR?' clear the contents on read. Error status is maintained using a set of registers; these are described in the following paragraphs and shown on the Status Model at the end of this section.

22.6.1 Standard Event Status and Standard Event Status Enable Registers

These two registers are implemented as required by the IEEE Std. 488.2.

Any bits set in the Standard Event Status Register which correspond to bits set in the Standard Event Status Enable Register will cause the ESB bit to be set in the Status Byte Register.

The Standard Event Status Register is read and cleared by the '*ESR?' command. The Standard Event Status Enable register is set by the '*ESE <nrf>' command and read by the '*ESE?' command.

It is a bit field where each bit has the following significance.

- Bit 7: Power On. Set when power is first applied to the instrument.
- Bit 6: User Request (Not used).
- Bit 5: Command Error. Set when a syntax type error is detected in a command from the bus. The parser is reset and parsing continues at the next byte in the input stream
- Bit 4: Execution Error. Set when an error is encountered while attempting to execute a completely parsed command. The appropriate error number will be reported in the Execution Error Register, see Error Messages section
- Bit 3: Not used.
- Bit 2: Query Error. Set when a query occurs. The appropriate error number will be reported in the Query Error Register, see Query Error Register section.
- Bit 1: Not used.
- Bit 0: Operation Complete: Set in response to the '*OPC' command.

22.6.2 Execution Error Register

This register contains a number representing the last error encountered over the current interface. The Execution Error Register is read and cleared using the 'EER?' command. On power up this register is set to 0 for all interface instances.

22.6.3 Status Byte Register and Service Request Enable Register

These two registers are implemented as required by the IEEE STD. 488.2.

Any bits set in the Status Byte Register which correspond to bits set in the Service Request Enable Register will cause the RQS/MSS bit to be set in the Status Byte Register, thus generating a Service Request on the bus.

The Status Byte Register is read either by the *STB? command, which will return MSS in bit 6, or by a Serial Poll which will return RQS in bit 6. The Service Request Enable register is set by the *SRE <nrf> command and read by the *SRE? command.

- Bit 7 - Not used.
- Bit 6 - RQS/MSS. This bit, as defined by IEEE Std. 488.2, contains both the Requesting Service message and the Master Status Summary message. RQS is returned in response to a Serial Poll and MSS is returned in response to the *STB? command.
- Bit 5 - ESB. The Event Status Bit. This bit is set if any bits set in the Standard Event Status Register correspond to bits set in the Standard Event Status Enable Register.
- Bit 4 - MAV. The Message Available Bit. This will be set when the instrument has a response message formatted and ready to send to the controller. The bit will be cleared after the Response Message Terminator has been sent.
- Bit 3 - Not used.
- Bit 2 - Not used.
- Bit 1 - Not used.
- Bit 0 - Not used.

22.6.4 Status Model

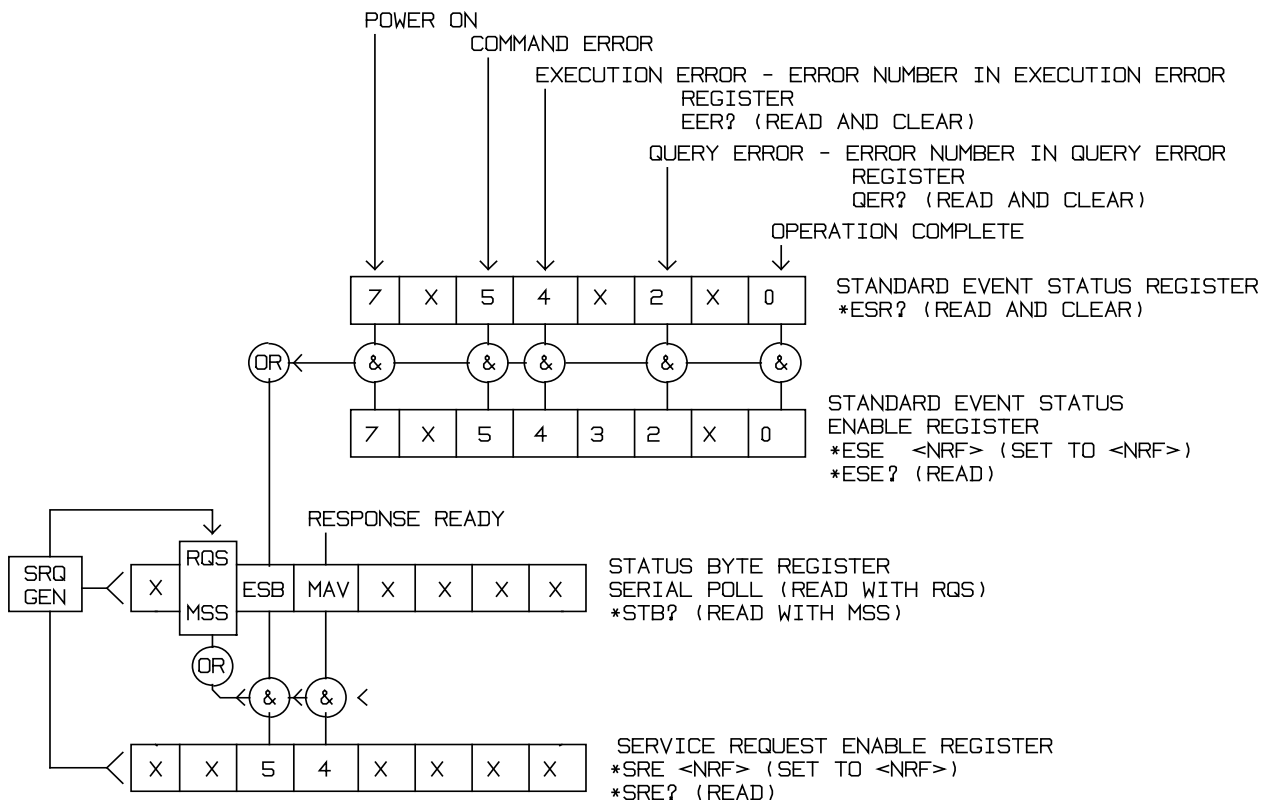

22.6.5 Power-on and Remote Operation Default Settings

The following instrument status values are set at power on:

Status Byte Register	= 0
Service Request Enable Register †	= 0
Standard Event Status Register	= 128 (pon bit set)
Standard Event Status Enable Register †	= 0
Execution Error Register	= 0
Query Error Register	= 0
Parallel Poll Enable Register †	= 0

† Registers marked thus are specific to the GPIB section of the instrument and are of limited use via other interfaces.

The instrument will be in local state with the front panel controls active.

The instrument parameters at power-on are always the same as at last switch off with the exception of the output status. By default the output is always off at power on but the user may change this from the front panel to be the same at power on as it was at switch off, see the Power On State paragraph in the Utility Menu - System section.

The *RST (reset) interface command resets the instrument to the Remote Operation Default settings.

23. Remote Commands

23.1 USB/LAN Remote Command Format

USB input to the instrument is buffered in a 256 byte input queue which is filled, under interrupt, in a manner transparent to all other instrument operations. The USB interface conforms with the USB 2.0 Full Speed.

LAN input to the instrument is buffered in a 1500 byte input queue which is filled, under interrupt, in a manner transparent to all other instrument operations. The LAN interface conforms with the LXI (LAN eXtensions for Instrumentation) Core 2011.

Commands must be sent as specified in the commands list and must be terminated with the command terminator code 0AH (Line Feed, LF). Commands may be sent in groups with individual commands separated from each other by the code 3BH (;). The group must be terminated with command terminator 0AH (Line Feed, LF).

Responses from the instrument to the controller are sent as specified in the commands list. Each response is terminated by a <RESPONSE MESSAGE TERMINATOR> which is 0DH (Carriage Return, CR) followed by 0AH (Line Feed, LF).

<WHITE SPACE> is defined as character codes 00H to 20H inclusive.

<WHITE SPACE> is ignored except in command identifiers. e.g. '*C LS' is not equivalent to '*CLS'. The high bit of all characters is ignored. The commands are case insensitive.

23.2 GPIB Remote Command Formats

GPIB input to the instrument is buffered in a 256 byte input queue which is filled, under interrupt, in a manner transparent to all other instrument operations. The queue contains raw (un-parsed) data which is taken, by the parser, as required. Commands (and queries) are executed in order and the parser will not start a new command until any previous command or query is complete. There is no output queue which means that the response formatter will wait, indefinitely if necessary, until the instrument is addressed to talk and the complete response message has been sent, before the parser is allowed to start the next command in the input queue.

Commands are sent as <PROGRAM MESSAGES> by the controller, each message consisting of zero or more <PROGRAM MESSAGE UNIT> elements separated by <PROGRAM MESSAGE UNIT SEPARATOR> elements.

A <PROGRAM MESSAGE UNIT> is any of the commands in the remote commands list.

A <PROGRAM MESSAGE UNIT SEPARATOR> is the semi-colon character ';' (3BH).

<PROGRAM MESSAGES> are separated by <PROGRAM MESSAGE TERMINATOR> elements which may be any of the following:

NL	The new line character (0AH)
NL^END	The new line character with the END message
^END	The END message with the last character of the message

Responses from the instrument to the controller are sent as <RESPONSE MESSAGES>. A <RESPONSE MESSAGE> consists of one <RESPONSE MESSAGE UNIT> followed by a <RESPONSE MESSAGE TERMINATOR>.

A <RESPONSE MESSAGE TERMINATOR> is the new line character with the END message NL^END.

Each query produces a specific <RESPONSE MESSAGE> which is listed along with the command in the remote commands list.

<WHITE SPACE> is ignored except in command identifiers. e.g. '*C LS' is not equivalent to '*CLS'. <WHITE SPACE> is defined as character codes 00H to 20H inclusive with the exception of the NL character (0AH). The high bit of all characters is ignored. The commands are case insensitive.

23.3 Command List

This section lists all commands and queries implemented in this instrument.

Note that there are no dependent parameters, coupled parameters, overlapping commands, expression program data elements or compound command program headers; each command is completely executed before the next command is started. All commands are sequential and the operation complete message is generated immediately after execution in all cases.

The following nomenclature is used:

<RMT>	<RESPONSE MESSAGE TERMINATOR>
<CPD>	<CHARACTER PROGRAM DATA>, i.e. a short mnemonic or string such as ON or OFF. Multiple CPDs in a command are shown as <CPD1>, <CPD2>, <CPD3>, etc.
<NRF>	A number in any format. e.g. 12, 12·00, 1·2 e1 and 120 e-1 are all accepted as the number 12. Any number, when received, is converted to the required precision consistent with the use then rounded to obtain the value of the command.
<NR1>	A number with no fractional part, i.e. an integer.
<CRD>	<CHARACTER RESPONSE DATA>
<BIN>	Binary data as detailed for the particular command.
[..]	Any item(s) enclosed in these brackets are optional parameters. If more than one item is enclosed then all or none of the items are required.

The commands which begin with a * are implemented as specified by IEEE Std 488.2 as Common commands. All will function when used on the other interfaces but some may be of little use.

The Operation Complete bit (bit 0) in the Standard Event Status Register is only ever set by the *OPC command. The *OPC (or the *OPC?) command can be used for device synchronisation due to the sequential nature of remote operations.

23.3.1 Channel Selection

Most commands act on a particular channel of the generator. The following command is used to select the required channel. Subsequent commands will change only the specified parameter on the selected channel.

CHN	<NR1>	Set channel <NR1> as the destination for subsequent commands. <NR1> can be 1 or 2.
CHN?		Returns currently selected channel number

23.3.2 Continuous Carrier Wave Commands

WAVE	<CPD>	Set the output waveform type to <SINE>, <SQUARE>, <RAMP>, <TRIANG> <PULSE>, <NOISE>, <PRBSPN7>, <PRBSPN9>, <PRBSPN11>, <PRBSPN15>, <PRBSPN20>, <PRBSPN23>, <PRBSPN29>, <PRBSPN31> or <ARB>.
FREQ	<NRF>	Set the waveform frequency to <NRF> Hz
PER	<NRF>	Set the waveform period to <NRF> Sec
AMPLRNG	<CPD>	Set the amplitude range to <AUTO> or <HOLD>
AMPL	<NRF>	Set the amplitude to <NRF> Vpp
HILVL	<NRF>	Set the amplitude-high-level to <NRF> Volts
LOLVL	<NRF>	Set the amplitude-low-level to <NRF> Volts
DCOFFS	<NRF>	Set the dc offset to <NRF> Volts

OUTPUT	<CPD>	Set the output to <ON>, <OFF>, <NORMAL> or <INVERT>
ZLOAD	<CPD>	Set the output load, which the generator is to assume for amplitude and dc offset entries, to <1..10,000>Ohms or <OPEN>.
SQRSYMM	<NRF>	Set the square waveform symmetry to <NRF> %
RMPSYMM	<NRF>	Set the ramp waveform symmetry to <NRF> %
SYNCOUT	<CPD>	Set the sync output to <ON>, <OFF>
SYNCTYPE	<CPD>	Set the sync type to <AUTO>, <NORMAL>, <CARRIER>, <TRIGGER> or <OFF>
CHN2CONFIG	<CPD>	Set channel 2 configuration to <MAINOUT> or <SYNCOUT>.
PHASE	<NRF>	Set the waveform phase offset to <NRF> degree.
ALIGN		Sends signal to align zero phase reference of both channels.

23.3.3 Pulse Generator Commands

PULSFREQ	<NRF>	Set the pulse waveform frequency to <NRF> Hz
PULSPER	<NRF>	Set the pulse waveform period to <NRF> sec
PULSWID	<NRF>	Set the pulse waveform width to <NRF> sec
PULSSYMM	<NRF>	Set the pulse waveform symmetry to <NRF> %
PULSEEDGE	<NRF>	Set the pulse waveform edges (positive and negative edge) to <NRF> sec.

23.3.4 PRBS Generator Commands

PRBSBITRATE	<NRF>	Set the PRBS waveform bit rate to <NRF> bits per second.
-------------	-------	--

23.3.5 Arbitrary Waveform Commands

ARBDCOFFS	<NRF>	Set the arbitrary dc waveform offset to <NRF> Volts
ARBFILTER	<CPD>	Set the arbitrary waveform filter shape to <NORMAL> or <STEP>
ARBLOAD	<CPD>	Set the output waveform type to <DC>, <SINC>, <HAVERSINE>, <CARDIAC>, <EXPRISE>, <LOGRISE>, <EXPFALL>, <LOGFALL>, <GAUSSIAN>, <LORENTZ>, <DLORENTZ>, <TRIANG>, <ARB1>, <ARB2>, <ARB3> or <ARB4>. The user specified name of the arbs stored in ARB1, ARB2, ARB3 or ARB4 are also accepted as valid entries to change the waveform to ARB1, ARB2, ARB3 or ARB4 respectively.
ARBRESIZE	<CPD>, <NR1>	Change the size of arbitrary waveform <CPD> to <NR1>.
ARBDEF	<CPD1>, <CPD2>, <CPD3>	Define an arbitrary waveform with user specified waveform name and waveform point interpolation state. <CPD1> ARB1, ARB2, ARB3 or ARB4 <CPD2> "user specified waveform name" <CPD3> waveform point interpolation ON or OFF

ARB1	<BIN>	Load data to an existing arbitrary waveform memory location ARB1. The data consists of two bytes per point with no characters between bytes or points. The point data is sent high byte first. The data block has a header which consists of the # character followed by several ascii coded numeric characters. The first of these defines the number of ascii characters to follow and these following characters define the length of the binary data in bytes. The instrument will wait for data indefinitely If less data is sent. If more data is sent the extra is processed by the command parser which results in a command error.
ARB2	<BIN>	See ARB1 description.
ARB3	<BIN>	See ARB1 description.
ARB4	<BIN>	See ARB1 description.
ARB1DEF?		Returns user specified waveform name, waveform point interpolation state and waveform length of ARB1.
ARB2DEF?		See ARB1DEF? description.
ARB3DEF?		See ARB1DEF? description.
ARB4DEF?		See ARB1DEF? description.
ARB1?		Returns the data from an existing arbitrary waveform location ARB1. The data consists of two bytes per point with no characters between bytes or points. The point data is sent high byte first. The data block has a header which consists of the # character followed by several ascii coded numeric characters. The first of these defines the number of ascii characters to follow and these following characters define the length of the binary data in bytes.
ARB2?		See ARB1? description.
ARB3?		See ARB1? description.
ARB4?		See ARB1? description.
23.3.6 Modulation Commands		
MOD	<CPD>	Set modulation to <OFF>, <AM>, <AMSC>, <FM>, <PM>, <ASK>, <FSK>, <SUM>, <BPSK> or <PWM>
MODAMSHAPE	<CPD>	Set AM waveform shape to <SINE>, <SQUARE>, <RAMPUP>, <RAMPDN>, <TRIANG>, <NOISE>, <DC>, <SINC>, <EXPRISE>, <LOGRISE>, <EXPFALL>, <LOGFALL>, <HAVERSINE>, <CARDIAC>, <GAUSSIAN>, <LORENTZ>, <DLORENTZ>, <ARB1>, <ARB2>, <ARB3>, <ARB4>, <PRBSPN7>, <PRBSPN9>, <PRBSPN11>, <PRBSPN15>, <PRBSPN20>, <PRBSPN23>, <PRBSPN29> or <PRBSPN31>
MODFM SHAPE	<CPD>	Set FM waveform shape to <SINE>, <SQUARE>, <RAMPUP>, <RAMPDN>, <TRIANG>, <NOISE>, <DC>, <SINC>, <EXPRISE>, <LOGRISE>, <EXPFALL>, <LOGFALL>, <HAVERSINE>, <CARDIAC>, <GAUSSIAN>, <LORENTZ>, <DLORENTZ>, <ARB1>, <ARB2>, <ARB3>, <ARB4>, <PRBSPN7>, <PRBSPN9>, <PRBSPN11>, <PRBSPN15>, <PRBSPN20>, <PRBSPN23>, <PRBSPN29> or <PRBSPN31>

MODPMSHAPE	<CPD>	Set PM waveform shape to <SINE>, <SQUARE>, <RAMPUP>, <RAMPDN>, <TRIANG>, <NOISE>, <DC>, <SINC>, <EXPRISE>, <LOGRISE>, <EXPFALL>, <LOGFALL>, <HAVERSINE>, <CARDIAC>, <GAUSSIAN>, <LORENTZ>, <DLORENTZ>, <ARB1>, <ARB2>, <ARB3>, <ARB4>, <PRBSPN7>, <PRBSPN9>, <PRBSPN11>, <PRBSPN15>, <PRBSPN20>, <PRBSPN23>, <PRBSPN29> or <PRBSPN31>
MODPWMSHAPE	<CPD>	Set PWM waveform shape to <SINE>, <SQUARE>, <RAMPUP>, <RAMPDN>, <TRIANG>, <NOISE>, <DC>, <SINC>, <EXPRISE>, <LOGRISE>, <EXPFALL>, <LOGFALL>, <HAVERSINE>, <CARDIAC>, <GAUSSIAN>, <LORENTZ>, <DLORENTZ>, <ARB1>, <ARB2>, <ARB3>, <ARB4>, <PRBSPN7>, <PRBSPN9>, <PRBSPN11>, <PRBSPN15>, <PRBSPN20>, <PRBSPN23>, <PRBSPN29> or <PRBSPN31>
MODSUMSHAPE	<CPD>	Set SUM waveform shape to <SINE>, <SQUARE>, <RAMPUP>, <RAMPDN>, <TRIANG>, <NOISE>, <DC>, <SINC>, <EXPRISE>, <LOGRISE>, <EXPFALL>, <LOGFALL>, <HAVERSINE>, <CARDIAC>, <GAUSSIAN>, <LORENTZ>, <DLORENTZ>, <ARB1>, <ARB2>, <ARB3>, <ARB4>, <PRBSPN7>, <PRBSPN9>, <PRBSPN11>, <PRBSPN15>, <PRBSPN20>, <PRBSPN23>, <PRBSPN29> or <PRBSPN31>
MODAMSRC	<CPD>	Set AM waveform source to <INT> or <EXT>
MODFMSRC	<CPD>	Set FM waveform source to <INT> or <EXT>
MODPMSRC	<CPD>	Set PM waveform source to <INT> or <EXT>
MODPWMSRC	<CPD>	Set PWM waveform source to <INT> or <EXT>
MODSUMSRC	<CPD>	Set SUM waveform source to <INT> or <EXT>
MODAMFREQ	<NRF>	Set AM waveform frequency to <NRF> Hz
MODFMFREQ	<NRF>	Set FM waveform frequency to <NRF> Hz
MODPMFREQ	<NRF>	Set PM waveform frequency to <NRF> Hz
MODPWFREQ	<NRF>	Set PWM waveform frequency to <NRF> Hz
MODSUMFREQ	<NRF>	Set SUM waveform frequency to <NRF> Hz
MODAMDEPTH	<NRF>	Set AM waveform depth to <NRF> %
MODFMDEV	<NRF>	Set FM waveform deviation to <NRF> Hz
MODPMDEV	<NRF>	Set PM waveform deviation to <NRF> degree
MODPWMDEV	<NRF>	Set PWM waveform deviation to <NRF> %
MODSUMLEVEL	<NRF>	Set SUM waveform level to <NRF> %
MODFSKSRC	<CPD>	Set FSK waveform source to <INT> or <EXT>
MODHOPFREQ	<NRF>	Set HOP frequency to <NRF> Hz
MODFSKRATE	<NRF>	Set FSK rate to <NRF> Hz
MODPOLFSK	<CPD>	Set FSK slope to <POS> or <NEG>
MODBPSKSRC	<CPD>	Set BPSK waveform source to <INT> or <EXT>
MODBPSKPHASE	<NRF>	Set BPSK phase offset to <NRF> degree
MODBPSKRATE	<NRF>	Set BPSK rate to <NRF> Hz
MODPOLBPSK	<CPD>	Set BPSK slope to <POS> or <NEG>

MODASKSRC	<CPD>	Set ASK waveform source to <INT> or <EXT>
MODHOPAMPL	<NRF>	Set HOP amplitude to <NRF> Vpp
MODASKRATE	<NRF>	Set ASK rate to <NRF> Hz
MODPOLASK	<CPD>	Set ASK slope to <POS> or <NEG>

23.3.7 Sweep Commands

SWPTYPE	<CPD>	Set the sweep type to <LINUP>, <LINDN>, <LOGUP> or <LOGDN>.
SWPMODE	<CPD>	Set the sweep mode to <CONT> or <TRIG>.
SWPTRGSRC	<CPD>	Set the sweep trigger source to <INT>, <EXT> or <MAN>.
SWPTRGPER	<NRF>	Set the sweep trigger period to <NRF> Sec.
SWPTRGPOL	<CPD>	Set the sweep trigger slope to <POS> or <NEG>.
SWPBEGFREQ	<NRF>	Set the sweep start frequency to <NRF> Hz.
SWPENDFREQ	<NRF>	Set the sweep stop frequency to <NRF> Hz.
SWPCNTFREQ	<NRF>	Set the sweep centre frequency to <NRF> Hz.
SWSPNFREQ	<NRF>	Set the sweep frequency span to <NRF> Hz.
SWPTIME	<NRF>	Set the sweep time to <NRF> sec.
SWP	<CPD>	Set the sweep to <ON> or <OFF>.

23.3.8 Burst Commands

BSTTRGSRC	<CPD>	Set the burst trigger source to <INT>, <EXT> or <MAN>.
BSTPER	<NRF>	Set the burst trigger period to <NRF> Sec.
BSTTRGPOL	<CPD>	Set the burst trigger slope to <POS> or <NEG>.
BSTCOUNT	<NR1>	Set the burst count to <nr1> cycles.
BSTPHASE	<NRF>	Set the burst phase to <NRF> degree.
BST	<CPD>	Set the burst to <OFF>, <NCYC>, <GATED> or <INFINITE>.

23.3.9 External Counter Commands

CNTRSWT	<CPD>	Set the external counter to <ON> or <OFF>
CNTRCPLNG	<CPD>	Set the counter source to <AC> or <DC> coupled input.
CNTRTYPE	<CPD>	Set the counter type to <FREQUENCY>, <PERIOD>, <WIDTH>, <NWIDTH> or <DUTY>.
CNTRVAL?		Returns the currently measured count value in <nrf> format. If the count type is frequency, then the returned value is in Hz, if the count type is duty cycle, then the returned value is in %, else the returned value is in seconds.

23.3.10 Clock and Miscellaneous Commands

CLKSRC	<CPD>	Set the clock source to <INT> or <EXT>.
CLKSRC?		Returns the clock source <INT> or <EXT>.

CHNTRG	<CPD>	Sends manual trigger to channel <ONE> or <TWO>. This command is the same as pressing the TRIGGER key. Its effect will depend on the context in which it is asserted. If the trigger source is manual and the generator is set to perform triggered burst or triggered sweep operation, this command sends a trigger pulse to the generator. If the trigger source is manual and the generator is set to perform gated burst operation, this command simply inverts the level of the manual trigger to high or low.
--------	-------	--

23.3.11 Dual-channel Function Commands

AMPLCPLNG	<CPD>	Set amplitude coupling to <ON> or <OFF>.
OUTPUTCPLNG	<CPD>	Set output coupling to <ON> or <OFF>.
FRQCPLSWT	<CPD>	Set waveform frequency coupling to <ON> or <OFF>.
TRACKING	<CPD>	Set channel tracking to <OFF>, <EQUAL> or <INVERT>.

23.3.12 System and Status Commands

*CLS		Clear Status. Clears the Status structure. This indirectly clears the Status Byte Register.
*ESE		Set the Standard Event Status Enable Register to the value of <NRF>
*ESE?		Returns the value in the Standard Event Status Enable Register in <NR1> numeric format. The syntax of the response is <NR1><RMT>
*ESR?		Returns the value in the Standard Event Status Register in <NR1> numeric format. The register is then cleared. The response is <NR1><RMT>. See Status Reporting section for details.
*IST?		Returns ist local message as defined by IEEE Std. 488.2. The syntax of the response is 0<RMT>, if the local message is false, or 1<RMT>, if the local message is true.
*OPC		Sets the Operation Complete bit (bit 0) in the Standard Event Status Register. This will happen immediately the command is executed because of the sequential nature of all operations.
*OPC?		Query Operation Complete status. The response is always 1<RMT> and will be available immediately the command is executed because all commands are sequential.
*PRE		Set the Parallel Poll Enable Register to the value <NRF>.
*PRE?		Returns the value in the Parallel Poll Enable Register in <NR1> numeric format. The syntax of the response is <NR1><RMT>
*SRE		Set the Service Request Enable Register to <NRF>.
*SRE?		Returns the value of the Service Request Enable Register in <NR1> numeric format. The syntax of the response is <NR1><RMT>
*STB?		Returns the value of the Status Byte Register in <NR1> numeric format. The syntax of the response is <NR1><RMT>
*WAI		Wait for Operation Complete true. As all commands are completely executed before the next is started this command takes no additional action.
*TST?		The PSU has no self test capability and the response is always 0 <RMT>

EER?	Query and clear Execution Error Register. The response format is <NR1><RMT>.
QER?	Query and clear Query Error Register. The response format is <NR1><RMT>
*LRN?	Returns the complete setup of the instrument as a binary data block. To re-install the setup the block should be returned to the instrument exactly as it is received. The syntax of the response is LRN <BIN>. The settings in the instrument are not affected by execution of the *LRN? Command.
LRN	Install data from a previous *LRN? command.
*RST	Resets the instrument parameters to their default values.
*RCL	Recalls a previously stored instrument set-up file from the specified non-volatile memory location.
*SAV	Saves the complete instrument set-up file to the specified non-volatile memory location.
*TRG	This command is the same as pressing the TRIGGER key. Its effect will depend on the context in which it is asserted. If the trigger source is manual and the generator is set to perform triggered burst or triggered sweep operation, this command sends a trigger pulse to the generator. If the trigger source is manual and the generator is set to perform gated burst operation, this command simply inverts the level of the manual trigger to high or low.
*IDN?	Returns the instrument identification. The exact response is determined by the instrument configuration and is of the form of <Manufacturer, Model, Serial No., XX.xx – YY.yy’ – ZZ.zz> where ‘XX.xx’ is the revision of the main firmware and ‘YY.yy’ is the revision of the remote interface firmware and ‘ZZ.zz’ is the revision of the USB flash drive firmware
BEEPMODE	Set beep mode to <ON>, <OFF>, <WARN>, or <ERROR>.
BEEP	Sound one beep.
OPTNPK?	Returns ‘0’ if option pack is disabled or ‘1’ if option pack is enabled.

23.3.13 Interface Management Commands

LOCAL	Go to local. This does not release any active interface lock so that the lock remains with the selected interface when the next remote command is received.
ADDRESS?	Returns the bus address of the instrument; This is the address used by GPIB, if fitted, or may be used as a general identifier over the other interfaces.
IPADDR?	Returns the present IP address of the LAN interface, provided it is connected. If it is not connected, the response will be the static IP if configured to always use that static IP, otherwise it will be 0.0.0.0 if waiting for DHCP or Auto-IP. The response is nnn.nnn.nnn.nnn<RMT>, where each nnn is 0 to 255.
NETMASK?	Returns the present netmask of the LAN interface, provided it is connected. The response is nnn.nnn.nnn.nnn<RMT>, where each nnn is 0 to 255.

NETCONFIG?		Returns the first means by which an IP address will be sought. The response is <CRD><RMT> where <CRD> is DHCP, AUTO or STATIC.
------------	--	---

The following commands specify the parameters to be used by the LAN interface. **Note:** a power cycle is required after these commands are sent before the new settings are used (or returned in response to the queries listed above). The instrument does not attempt to check the validity of the IP address or netmask in any way other than checking that each part fits in 8 bits. The rear panel LAN RESET switch will override these commands and restore the defaults as described earlier.

NETCONFIG	<CPD>	Specifies the means by which an IP address will be sought. <CPD> must be one of DHCP, AUTO or STATIC.
IPADDR	<quad>	Sets the potential static IP address of the LAN interface (as on the webpage). The parameter must be strictly a dotted quad for the IP address, with each address part an <NR1> in the range 0 to 255, (e.g. 192.168.1.101).
NETMASK	<quad>	Sets the netmask to accompany the static IP address of the LAN interface. The parameter must be strictly a dotted quad for the netmask, with each part an <NR1> in the range 0 to 255, (e.g. 255.255.255.0).

23.3.14 Calibration Specific Commands

See the calibration section for details of calibration specific commands.

23.3.15 Error Messages

Each error message has a number; only this number is reported via the remote control interfaces. Error message numbers are placed in the Execution Error Register where they can be read via the remote interfaces.

24. Appendix 1. Information, Warning and Error Messages

In the following list where [VALUE] appears a numeric value will be inserted in the message which is appropriate to the parameter currently being edited. Message numbers that are omitted are reserved and not currently used. Some numbers can produce two different messages depending on the current instrument editing mode; these are indicated by 'or' in the list.

24.1 Error Messages

- 1 Firmware Update / Battery Fail. Initialised to factory default state.
- 2 Frequency / Period invalid. Frequency lower limit 1mHz. Period upper limit 1000s.
- 3 Frequency / Period invalid. Frequency upper limit 20MHz. Period lower limit 50ns.
- 4 Pulse width invalid. Limited by pulse period.
- 5 Pulse width invalid. Lower limit 25ns.
- 6 Pulse edge time invalid. Limited by pulse width.
- 7 Pulse edge time invalid. Lower limit 10ns.
- 8 Invalid entry. Width cannot be less than $(1.25 * \text{Edge} + [\text{VALUE}])$.
- 9 Invalid entry. Period cannot be less than $(\text{Width} + 1.25 * \text{Edge} + [\text{VALUE}])$.
- 10 Pulse width deviation invalid for current pulse parameter settings.
- 11 Square width invalid. Lower limit [VALUE].
- 12 Bitrate invalid. Lower limit 1ubps.
- 13 Bitrate invalid. Upper limit [VALUE].
- 14 Frequency / Period invalid. Frequency lower limit 1uHz. Period upper limit 1000000s.
- 15 Frequency / Period invalid for Sine. Frequency upper limit [VALUE]. Period lower limit [VALUE].
 - or Frequency / Period invalid for Square. Frequency upper limit [VALUE]. Period lower limit [VALUE].
 - or Frequency / Period invalid for Ramp. Frequency upper limit [VALUE]. Period lower limit [VALUE].
 - or Frequency / Period invalid for Arb. Frequency upper limit [VALUE]. Period lower limit [VALUE].
- 16 Ramp symmetry invalid. Upper limit 100%.
- 17 Ramp symmetry invalid. Lower limit 0%.
- 18 Square duty cycle invalid. Upper limit 99.999%.
- 19 Square duty cycle invalid. Lower limit 0.001%.
- 20 Frequency deviation invalid for current waveform / parameter settings.
- 21 Hop frequency invalid for current waveform / parameter settings.
- 22 Sweep frequency invalid for current waveform / parameter settings.
- 23 Amplitude value invalid. Upper limit +32767.
- 24 Amplitude value invalid. Lower limit -32767.
- 25 Point number invalid. Last defined point [VALUE].

-26	Point number invalid. First defined point 1.
-27	Number of points invalid. Upper limit 8192.
-28	Number of points invalid. Lower limit 1.
-29	Please specify a filename in Short File Name (SFN) format.
-30	AM frequency invalid. Upper limit 10MHz.
-31	AM frequency invalid. Lower limit 1uHz.
-32	Amplitude depth invalid. Upper limit 100%.
-33	Amplitude depth invalid. Lower limit 0%.
-34	FM frequency invalid. Upper limit 10MHz.
-35	FM frequency invalid. Lower limit 1uHz.
-36	Frequency deviation invalid. Current upper limit [VALUE].
-37	Frequency deviation invalid. Lower limit 0Hz.
-38	PM frequency invalid. Upper limit 10MHz.
-39	PM frequency invalid. Lower limit 1uHz.
-40	Phase deviation invalid. Upper limit +360 degrees.
-41	Phase deviation invalid. Lower limit -360 degrees.
-42	FSK rate invalid. Upper limit 10MHz.
-43	FSK rate invalid. Lower limit 2mHz.
-44	Hop frequency invalid. Current upper limit [VALUE].
-45	Hop frequency invalid. Lower limit 1uHz.
-46	BPSK rate invalid. Upper limit 10MHz.
-47	BPSK rate invalid. Lower limit 2mHz.
-48	Hop phase invalid. Upper limit +360 degrees.
-49	Hop phase invalid. Lower limit -360 degrees.
-50	SUM frequency invalid. Upper limit 10MHz.
-51	SUM frequency invalid. Lower limit 1uHz.
-52	SUM modulation level invalid. Upper limit 100%.
-53	SUM modulation level invalid. Lower limit 0%.
-54	PWM frequency invalid. Upper limit 10MHz.
-55	PWM frequency invalid. Lower limit 1uHz.
-56	PWM deviation invalid. Maximum deviation limited by carrier width setting.
-57	PWM deviation invalid. Lower limit 0ns.
-58	Arb DC cannot be selected when modulation is enabled and vice versa.
-59	FM invalid for Noise / PRBS.
-60	PM invalid for Noise / PRBS.
-61	FSK invalid for Noise / PRBS.
-62	BPSK invalid for Noise / PRBS.
-63	PWM invalid for Noise / PRBS.
-64	PWM is only valid for Pulse.

-
- 65 Start frequency invalid. Lower limit 1uHz.
 - 66 Start frequency invalid. Cannot be greater than stop frequency.
 - 67 Stop frequency invalid. Cannot be less than start frequency.
 - 68 Stop frequency invalid. Current upper limit [VALUE].
 - 69 Sweep time invalid. Lower limit 1us.
 - 70 Sweep time invalid. Upper limit 500s.
 - 71 Trigger period invalid. Lower limit [VALUE].
 - 72 Trigger period invalid. Upper limit 500s.
 - 73 Arb DC cannot be selected when frequency sweep is enabled and vice versa.
 - 74 Sweep invalid for Noise.
 - 75 Burst count invalid. Upper limit 2147483647.
 - 76 Burst count invalid. Lower limit 1.
 - 77 Trigger period invalid. Upper limit 500s.
 - 78 Trigger period invalid. Lower limit [VALUE].
 - 79 Arb DC cannot be selected when burst is enabled and vice versa.
 - 80 OUTPUT VOLTAGE OVERLOAD. Output turned off for safety.
 - 81 Invalid entry. High level upper limit [VALUE].
 - 82 Invalid entry. Low level lower limit [VALUE].
 - 83 Invalid entry. Amplitude upper limit [VALUE].
 - 84 Invalid entry. Amplitude lower limit [VALUE].
 - 85 Invalid entry. Offset upper limit [VALUE].
 - 86 Invalid entry. Offset lower limit [VALUE].
 - 87 Phase invalid. Upper limit +360 degrees.
 - 88 Phase invalid. Lower limit -360 degrees.
 - 89 Output load invalid. Upper limit 10000 ohms.
 - 90 Output load invalid. Lower limit 1 ohms.
 - 91 Frequency coupling cannot be turned on when modulation is enabled.
 - 92 Frequency coupling cannot be turned on when frequency sweep is enabled.
 - 93 Frequency coupling cannot be turned on. Pulse waveform can only be coupled with Pulse waveform.
 - 94 Frequency coupling cannot be turned on when Noise is set as main output.
 - 95 Frequency coupling cannot be turned on when DC is set as main output.
 - 96 Outputs cannot be coupled when Tracking is selected.
 - 97 Amplitudes cannot be coupled when Tracking is selected.
 - 98 Frequencies cannot be coupled when Tracking is selected.
 - 99 Tracking cannot be selected when outputs are coupled.
 - 100 Tracking cannot be selected when amplitudes are coupled.
 - 101 Tracking cannot be selected when frequencies are coupled.
 - 102 Channel 2 parameters not available when Tracking is selected.
-

-
- 103 Invalid entry. Upper limit 99%.
 - 104 Invalid entry. Lower limit 1%.
 - 105 GPIB address invalid. Upper limit 30.
 - 106 GPIB address invalid. Lower limit 0.
 - 107 Incorrect password. Please try again.
 - 108 Password did not match. Please try again.
 - 109 Unsupported USB device. Device current limited to 500mA.
 - 110 Unsupported USB device. Please insert USB-Flash disk only.
 - 111 Unsupported remote command.
 - 112 Unsupported remote command parameter.
 - 113 USB HOST hardware not found.
 - 114 Please insert USB-Flash disk and try again.
 - 115 USB-Flash disk files limited to 1260.
 - 116 Please edit different file name as the current file already exist.
 - 117 FATAL ERROR: Invalid waveform location.
 - 118 FATAL ERROR: Invalid setup location.
 - 119 Unsupported waveform file or the file may be corrupted, please wait.
 - 120 Unsupported setup file or the file may be corrupted, please wait.
 - 121 Unsupported command on the Webpage.
 - 122 Unable to Recall instrument setup. The specified location is empty.
 - 123 Test FAILED at address [VALUE]. Data written [VALUE]. Data read back [VALUE].
 - 124 PM invalid for Pulse.
 - 125 BPSK invalid for Pulse.
 - 126 FM invalid for Pulse.
 - 127 FSK invalid for Pulse.
 - 128 Sweep invalid for Pulse.
 - 129 Finite Burst invalid for frequencies above [VALUE].
 - 130 Channel 2 parameters not available when channel 2 is set to output channel 1 sync waveform.
 - 131 Gated Burst invalid for frequencies above [VALUE].
 - 132 Frequency coupling cannot be turned on when burst is enabled.
 - 133 Frequency and amplitude coupling cannot be turned on when channel 2 is set to output channel 1 sync.
 - 134 Tracking cannot be turned on when channel 2 is set to output channel 1 sync waveform.
 - 135 Channel 2 cannot be set to output channel 1 sync when frequencies or amplitudes are coupled.
 - 136 Channel 2 cannot be set to output channel 1 sync when channels are in tracking mode.
 - 137 Channel 2 parameters not available when Tracking is selected.
-

-138	Invalid entry. Order upper limit 50.
-139	Invalid entry. Order lower limit 1.
-140	Invalid entry. Amplitude. percent upper limit 100.0%.
-141	Invalid entry. Amplitude. percent lower limit 0.0%.
-142	Invalid entry. Phase upper limit 360.0 degrees.
-143	Invalid entry. Phase lower limit -360.0 degrees.
-144	Amplitude coupling cannot be turned on when ASK modulation is enabled.
-145	Amplitude coupling cannot be turned on when DC is set as main output.
-146	Amplitude invalid. Carrier amplitude cannot be less than hop amplitude.
-147	Hop amplitude invalid. Cannot be less than 0 Vpp..
-148	ASK rate invalid. Upper limit 10MHz.
-149	ASK rate invalid. Lower limit 2mHz.
-150	Amplitude modulation invalid for carrier frequencies above [VALUE].
-151	Amplitude shift keying invalid for carrier frequencies above [VALUE].
-152	SUM modulation invalid for carrier frequencies above [VALUE].
-153	Feature not available. Option GU3082 is required.

24.2 Warning Messages

1	DC Offset set to default 0V.
2	Frequency coupling turned off.
3	Wrong key pressed. Press keys as instructed.
4	Instrument is not calibrated.
5	Calibration values cleared. Please power-cycle the instrument.
6	USB-Flash disk waveform files limited to 1260.
7	USB-Flash disk setup files limited to 1260.
8	Please press again to overwrite.
9	File was created from 1-CHN-Model. Please press again to copy.
10	File was created from LF-Model. Please press again to copy.
11	File was created from different firmware. Please press again to copy.
12	Amplitude coupling turned off.
13	Hop amplitude set to maximum allowed for current carrier amplitude and offset settings.
14	Burst mode turned off to output DC.
15	Frequency changed to maximum allowed for Ramp waveform.
16	Frequency changed to maximum allowed for Arb waveform for current settings.
17	Frequency changed to maximum allowed for Square waveform.
18	Frequency changed to maximum allowed for Sine waveform for current settings.
19	Option GU3082 installed.
20	Square symmetry set to default 50%.

24.3 Information Messages

- 501 Key test successful.
- 502 New password stored.
- 503 Select a unit to enter value or press Cancel.
- 504 Please reduce the files on USB-Flash disk and try again.
- 505 Test data has been written to RAM.
- 506 RAM test successful.
- 507 Press Trigger key to send a manual trigger pulse.
- 508 Press Trigger key to invert the manual trigger level. Current level high.
or Press Trigger key to invert the manual trigger level. Current level low.
- 509 To send a manual trigger pulse press Trigger key again.
- 510 To invert manual trigger level, press Trigger key again.
- 511 Manual trigger pulse sent.
- 512 Manual trigger level inverted. Current level high.
or Manual trigger level inverted. Current level low.

24.4 Other Information Messages

Please wait.

Please wait. The file is being read from USB-Flash disk.

Please wait. The file is being written to USB-Flash disk.

Please wait. The current settings are being saved.

Please wait. The local setup file is being recalled.

Please wait. The local setup file is being deleted.

Please wait. The local waveform file is being deleted.

Please wait. Writing test data to RAM.

Please wait. Reading test data from RAM.

Are you sure you want to delete? Press Yes to confirm. Press No to cancel.

25. Appendix 2. Factory Default Settings

Output Configuration	Factory Setting
Function	Sine wave
Frequency	10 kHz
Amplitude / Offset	1 Vpp / 0.000 Vdc
Output Termination	50 Ω
Autorange	On
Output Polarity	Normal
Output Phase	0 degrees
Square Duty Cycle	50 %
Ramp Symmetry	50 %
Pulse Width (Duty Cycle)	50 us (50 %)
Pulse Edge	10 ns
Noise Source	Gaussian White Noise
PRBS Bit Rate	10 kbps
PRBS Type	PRBS – LFSR Length 7
Arb Waveform	Exponential Rise
Arb Filter	Step Filter
Output State	Off
Sync Out State	Off; Channel 2 is configured as a separate independent channel with same default configurations as channel 1
Modulation	Factory Setting
Carrier AM, FM, PM, ASK, FSK, BPSK, SUM	10 kHz Sine wave
Carrier PWM	10 kHz Pulse
Modulation Waveform AM, FM, PM, SUM, PWM	1 kHz Sine wave
Modulation Source AM, FM, PM, ASK, FSK, BPSK, SUM, PWM	Internal
AM Depth	50 %
FM Deviation	2 kHz
PM Deviation	180 degrees
FSK Hop Frequency	5 kHz
FSK Rate	1 kHz
FSK Polarity	Positive
SUM Modulation Level	50 %
BPSK Hop Phase	180 degrees
BPSK Rate	1 kHz
BPSK Polarity	Positive
ASK Hop Amplitude	500 mVpp
ASK Rate	1 kHz

ASK Polarity	Positive
PWM Width Deviation	50 %
Modulation State	Off
Sweep	Factory Setting
Start / Stop Frequency	1 kHz / 10 kHz
Sweep Time	500 us
Sweep Type / Mode	Linear Up / Continuous
Sweep Trigger Source	Internal
Sweep Trigger Polarity	Positive (Rising Edge)
Sweep Trigger Period	5 ms
Sweep State	Off
Burst	Factory Setting
Burst Type	Triggered, N-Cycle
Burst Count	1 Cycle
Burst Trigger Source	Internal
Burst Trigger Polarity	Positive (Rising Edge / High Level)
Burst Trigger Period	5 ms
Burst Start Phase	0 degrees
Burst State	Off
System-Related Operations	Factory Setting
Power-Down Recall	Disabled
Display Mode	On
Error Queue	Errors are Cleared
Stored States, Stored Arbs	No Change
Output State	Off
Remote Interface Configuration	Factory Setting
GPIO Address	5
DHCP	On
Auto IP	On
IP Address	192.168.1.100
Subnet Mask	255.255.0.0
Default Gateway	0.0.0.0
DNS Server	0.0.0.0
Host Name	<i>none</i>
Domain Name	<i>none</i>
Calibration	Factory Setting
Calibration State	Not protected

26. Appendix 3. Waveform Manager Plus V4.11 - Arbitrary Waveform Creation and Management Software

The Waveform Manager program allows construction, editing, exchange, translation and storage of many types of waveform data. It is compatible with all TTI waveform generation products.

Waveforms may be generated by equation entry, freehand drawing, combining existing waveforms or any combinations of these methods.

Data upload and download are possible via LAN, USB or GPIB subject to a compatible GPIB adapter being correctly installed and configured in your PC.

Files can also be uploaded/downloaded to the USB flash drive and the flash drive then used directly with the instrument.

Both upload and download of waveform data are possible.

Text data may be read from the Windows clipboard and used to create a waveform. The text data format is very free and will allow most lists of numbers, with or without intervening text, to be read as waveform data points. Waveform data may also be pasted to the clipboard for insertion into other programs.

Waveform data may also be read from files conforming to the CSV file format.

Waveforms are displayed in fully scaleable windows and may be manipulated graphically. Any number of waveforms in any of the supported types may be displayed simultaneously.

On-line help is available in three ways.

1. The help menu contains a contents option from which you can go to any section of the on-line help file or browse particular areas or the whole file. It is also possible to use the Index and Find operations of the Windows help system to search for items which are not listed directly in the contents section.
2. Some dialog boxes have a Help button which, when clicked, will open the on-line help file at the section containing the description of that dialog box.
3. From most windows/dialogues the F1 key will open the help file at the relevant section.

Waveform Manager Plus allows you to keep waveforms for different projects separate from each other on your hard drive. A project may be placed anywhere, in any directory folder and all waveform files for that project will be stored in a structure below that directory. A project is identified by a user defined name. Each project maintains its own library of expressions.