



LVPRO10

TDR/Cable Tester



Contents

I. Overview	3
II. Accessories	3
III. Safety Information	4
IV. Features	4
V. Display Features (LVPRO10)	5
VI. Testing Mode	6
6.1 Testing Twisted-Pair Cabling	6
6.2 Testing Coaxial Cabling	12
VII. POE Mode	14
VIII. Tone Mode	15
8.1 Tone Mode Display	15
8.2 LVPRO10 Receiver	16
IX. Calibrating Length Measurements (Only for test mode)	18
9.1 Setting the NVP to a Specified Value	18
9.2 Determining a Cable's Actual NVP	19
X. Backlight	19
XI. Unit of Length	19
XII. Auto Power Off	19
XIII. Other functions	20
13.1 Low battery indication	20
13.2 Troubleshooting	20
13.3 Specifications	20
XIV. Maintenance	20

I. Overview

The Tripplett LVPRO10 is a handheld TDR cable tester, suitable for copper cables (CAT 5E、CAT 6、CAT 6A or CAT 8), used to detect and diagnose wiring condition of twisted pair and coaxial cable, detect network service, short/open circuit in network cabling, split pair, mis wire, etc. It can also be applied to detect if there is PoE supply (POE module) in network cabling and PoE standard (802.3AF, 802.3AT, 802.3BT). Wire map, cable length, open-circuit location and other information can be displayed on the screen simultaneously. The cable tester is characterized by accurate, easy to operate, visibly displayed, making it an ideal tool for network communication maintenance, network engineering, wiring engineering, etc.

II. Accessories

If any accessories listed below is missing or damaged, please contact with your supplier immediately.

Items	Quantity
LVPRO10 TDR cable tester	1 pc
1.5V AA alkaline battery	3 pcs
RJ45 adapting cable	1 pc
RJ11 adapting cable	1 pc
RJ11 adapting cable (adapted to alligator clip)	1 pc
Plug, F-connector to F-connector	1 pc
User manual	1 pc
Carrying bag	1 pc
LVPRO10 Receiver	1 pc
Micro USB charging cable	1 pc

III. Safety Information

To avoid fire, electric shock or personal injury, please follows:

- Do not open the casing, there is no any user-serviceable part inside.
- Please operate the tester by following the user manual, otherwise the tester can be damaged.
- Check before use. Do not use damaged tester. Do not alter the tester.
- Please stop use in case that the tester does not work normally.
- Please replace the battery immediately if low battery symbol appears, so as to ensure test accuracy.

IV. Features

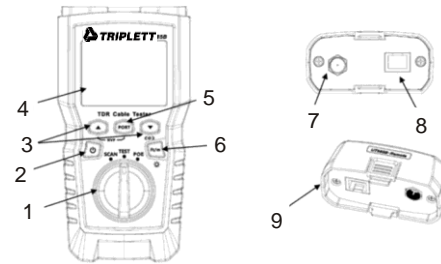

1. Mode knob: Wire tracking mode, testing mode, POE mode
2. Power button: Long press for 2 seconds to power on, short press for 1 second to power off
3. The buttons (multiplexed) are used to view test result.
4. LCD display with backlight
5. Select RJ45 or coaxial cable connector
6. Short press this button to switch unit, long press about one second to turn on/off of the backlight
 - Press , and power button at the same time to display the software version.
 - Press , and power button at the same time to calibrate measured length (Only for test mode).
7. F-Connector for connecting coaxial cable
8. Modular jack for connecting to telephone and twisted-pair network cable. The jack accepts 8-pin modular (RJ45) and 6-pin modular (RJ11) connectors.
9. Wire map adapter with 8-pin modular jack and coaxial F connector.

V. Display Features (LVPRO10 Main Unit)

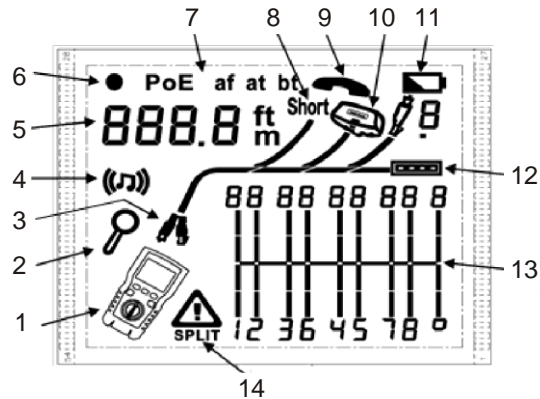

1. Tester icon
2. Detail screen indicator
3. Indicates which port is active, the RJ45 port or the coaxial port.
4. Tone mode indicator
5. Numeric display with feet/meters indicator
6. Test mode indicator
7. POE mode indicator
8. Short circuit indicator
9. Telephone voltage indicator
10. Indicates a wire map adapter is connected to the far end of the cable
11. Low battery indicator
12. Ethernet port indicator
13. Wiremap diagram
14. Fault/high voltage indication: "⚠" denotes fault or high voltage occurs at the cable. SPLIT appears if split pair occurs.

VI. Testing Mode

6.1 Testing Twisted-Pair Cabling

6.1.1 Cabling Test

- (1) Turn on the tester, and set the knob to "TEST", then press "PORT" to select RJ45 port.
- (2) Connect tester and wire map adapter to the cabling, the test runs continuously until you change modes or turn the tester off.

Note: Accurate cable length measurement without the need to connect a remote adapter, however, an adapter is required for a complete wire map test.

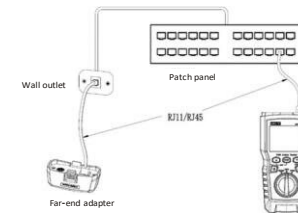

Figure 6.1 Connecting to Twisted Pair Network cabling

6.1.2 Typical Testing Results

6.1.2.1 Open on Twisted Pair Cabling

As shown in figure 6.2, the third wire is open circuit, the three segments shown for the wire pair length indicate the open is approximately 3/4 the distance to the end of the cabling. The cable length is 71.5m.

To see the distance to the open, use "◀" and "▶" to view detailed results for the wire pair. Note: If only one wire in a pair is open, both wires are shown as open. The warning icon "⚠" does not appear if both wires in a pair are open because open pairs are normal for some cabling applications.

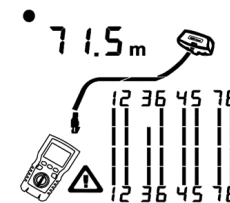

Figure 6.2 Open on Twisted Pair Cabling

6.1.2.2 Short on Twisted Pair Cabling

Figure 6.3 shows a short between wires 5 and 6, the shorted wires flash to indicate the fault.

The cable length is 74.8m.

Note: When there is a short, the far-end adapter and the mapping of the unshorted wires are not shown.

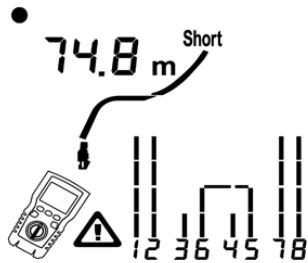

Figure 6.3 Short on Twisted Pair Cabling

6.1.2.3 Crossed Wires

Figure 6.4 shows that wires 3 and 4 are crossed. The pin numbers flash to indicate the fault.

length is 53m. The cable is shielded.

Note: Detection of crossed wires requires a far-end adapter.

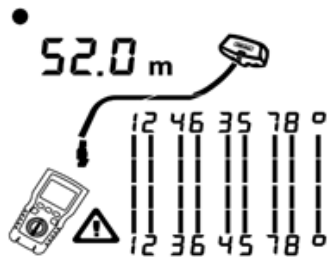

Figure 6.4 Crossed Wires

6.1.2.4 Crossed Pairs

Figure 6.5 shows that 1, 2 and 3, 6 are crossed. The pin numbers flash to indicate the fault. Detection of crossed wires requires a far-end adapter.

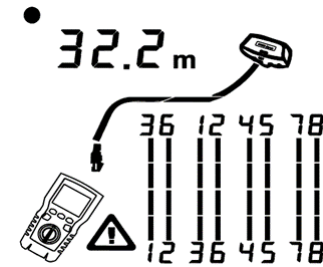

Figure 6.5 Crossed Pairs

6.1.2.5 Split Pair

Figure 6.6 shows a split pair on 3, 6 and 4, 5. The symbol "SPLIT" and split pair flash to indicate the fault. The cable length is 46.8m.

In a split pair, continuity from end to end is correct, but is made with wires from different pairs.

Split pairs cause excessive crosstalk that interferes with network operation.

Note: Cables with untwisted pairs, such as telephone cords, typically show split pairs due to excessive crosstalk.

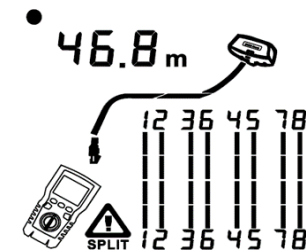

Figure 6.6 Split Pair

6.1.2.6 Ethernet Port Detected

Figure 6.7 shows that the tester detects Ethernet port.

The tester cannot measure the length if the port does not produce reflections. Length may fluctuate or be obviously too high if the port's impedance fluctuates or varies from the cable's impedance. When in doubt, disconnect the cable from the port to get an accurate length measurement.

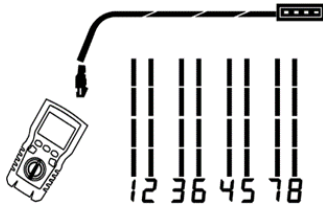

Figure 6.7 Ethernet Port Detected

6.1.2.7 POE Switch Detected

Figure 6.8 shows the tester detecting the POE switch.

In testing mode, the tester could identify if the device connected by measured cable is POE switch or not, and displays "POE" and "⚠".

In testing mode, the tester cannot identify IEEE 802.3af, IEEE 802.3at and IEEE 802.3bt. To know about the power supply standards of POE switch, please perform a test on the switch under POE mode. (See "POE Mode")

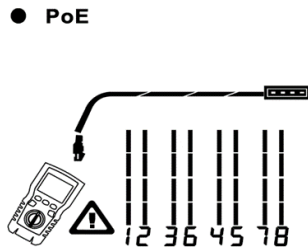

Figure 6.8 POE Switch Detected

6.1.2.8 Voltage Detection

Figure 6.9 shows that the tester detects cable voltage.

If the measured cable is live and its voltage is greater than or equal to 10V, the tester will show "⚠" and "Pn" (P: positive; n: negative).

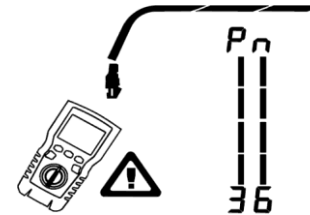

Figure 6.9 Cable Voltage Detection

6.1.2.9 View Details for a Wire Pair

Figure 6.10 shows that the tester displays details for each wire pair. Use "←" and "→" to move through the screens. In this mode, the tester continuously tests only the wire pair you are viewing.

- A: Short on pair 1, 2 at 33.6m. Note: On the results detail screens, shorts are shown only when they are between wires in a pair. When there is a short, the far-end adapter and the mapping of the unshorted wires are not shown.
- B: Pair 3, 6 is 66.2m long and is terminated with wire map adapter.
- C: Open on pair 4, 6 at 53.7m. The open could be on one or both wires.

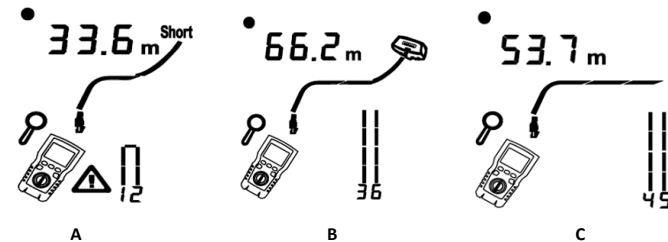

Figure 6.10 Details for a Wire Pair

6.1.2.10 Connecting to Telephone Networks Wired in Star Topologies

Telephone cables wired in a star topology (Figure 6.11) are connected together at a bridge gap at the distribution center. The bridge gap connects each wire to all other wires of the same number. The tester detects bridge taps and measures the distance to the bridge gap. To measure the length of each cable connected to the bridge gap, connect the wiremap adapter to the bridge gap and the tester to the wall outlet.

The tester cannot measure length past the bridge gap because reflections from the bridge gap connection interfere with measurement. If you connect the tester to the bridge gap, the tester measures the length only to the bridge gap, which is only the patch cord length. (Do not use multiple far-end adapters in star or bus topologies. Doing so causes incorrect wiremap results.)

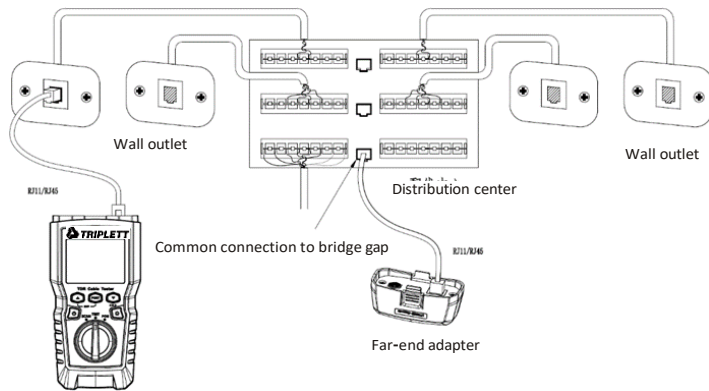

Figure 6.11 Connecting to Telephone Networks Wired in Star Topologies

6.1.2.11 Connecting to Telephone Networks in Bus Topologies

Telephone cables wired in a bus topology (Figure 6.12) connect the wall outlets in series. In this topology, you measure the length from the last outlet to the wire map adapter.

If you connect to an outlet in the middle of the series, the tester reports a bridge gap. The length report is the length to the outlet, which is the patch cord length. The tester cannot measure length past the outlet because reflections from the cables on either side interfere with measurements.

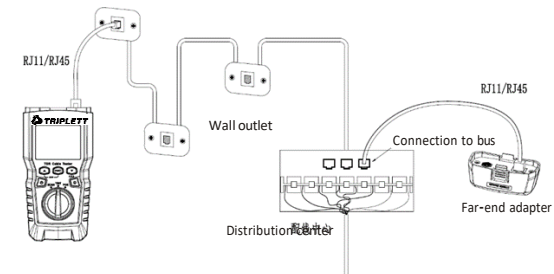

Figure 6.12 Connecting to Telephone Networks in Bus Topologies

6.2 Testing Coaxial Cabling

6.2.1 Coaxial Cabling Testing

- (1) Turn on the tester, and set the knob to "TEST", then press "PORT" to switch to coaxial test mode.
- (2) Connect the tester and wiremap adapter to the cabling.
- (3) For cabling not terminated with an F-connector, use an adapter or hybrid patch cord to connect to the cabling. The test runs continuously until you change modes or turn the tester off.

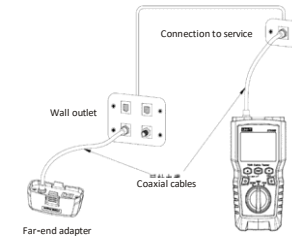

Figure 6.13 Connecting to Coaxial Cabling

6.2.2 Typical Testing Results

6.2.2.1 Results for a Good Coaxial Cable

Figure 6.14 shows a good coaxial cable 63.2m and terminated with far-end adapter



Figure 6.14 Coaxial Results

6.2.2.2 Open on Coaxial Cabling

Figure 6.15 shows an open 57.2m from the tester.



Figure 6.15 Open on Coaxial Cabling

6.2.2.3 Short on Coaxial Cabling

Figure 6.16 shows a short 21.6m from the tester.



Figure 6.16 Short on Coaxial Cabling

6.2.2.4 Voltage on Coaxial Cabling

Figure 6.17 shows that the symbol "⚠" appears if the coaxial cable is live and its voltage is greater than or equal to 10V.



Figure 6.17 Voltage on Coaxial Cabling

VII. POE Mode

As shown in figure 7.1, turn on the tester, and set the knob to POE mode, then the symbol "POE" appears on the display. The tester shows and identifies af/at/bt. and is connected to a power supply device using IEEE 802.3bt standard. In POE mode, the tester detects POE on pairs 1,2-3,6 and 4,5-7,8. The tester may activate a POE source and will not be damaged by POE.

If POE is detected, "POE" appears above the powered pairs. The "POE" may blink as the POE source turns the power on and off.

The tester can detect if the connected device is powered by POE and can identify three different POE standards including IEEE 802.3af, IEEE 802.3at, IEEE 802.3bt. If a non-standard POE device is connected, the tester is not able to detect whether the connected device is POE powered or not and needs to switch to TEST mode to detect whether the device is powered or not.

"IEEE 802.3af: CSMA/CD Access Method and Physical Layer Specifications - Data Terminal Equipment (DTE) Power via the Media Dependent Interface (MDI)"

"IEEE 802.3at: CSMA/CD Access Method and Physical Layer Specifications - Data Terminal Equipment (DTE) Power via the Media Dependent Interface (MDI) Enhancements"

"IEEE 802.3bt: Physical Layer and Management Parameters for Power over Ethernet over 4 pairs"

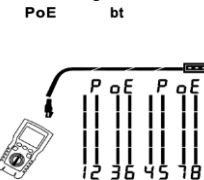

Figure 7.1 POE Display

VIII. Tone Mode

8.1 Tone Mode Display

- (1) Turn on the tester, then set the knob to "SCAN". In tone mode, the default display is shown in Figure 8.1.a.
- (2) In tone mode, short press "Hub" to enable or disable the hub blink function, as shown in Figure 8.1.b.
- (3) If switch under working is connected, "C O C" flashes as the switch port flashes, as shown in Figure 8.1.c.

The tester can send 125KHZ digital modulation signal (10VPP), and support LVPRO10 receiver to achieve tone function (For the use of LVPRO10 RECEIVER PROBE receiver, please refer to "8.2 LVPRO10 RECEIVER PROBE

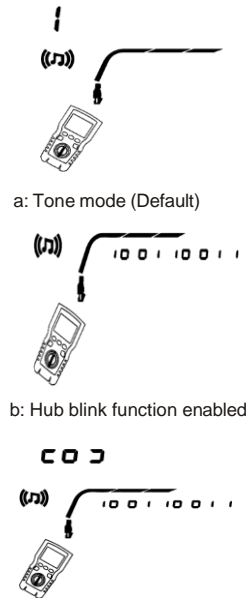

a: Tone mode (Default)

b: Hub blink function enabled

c: Hub blink function enabled (Connected with switch)

Figure 8.1 Tone mode display

8.2 LVPRO10 Receiver

8.2.1 Features

With the support of LVPRO10 tester, The receiver can achieve multiple functions such as locating and isolating cables by adjusting sensitivity, twisted-pair cable tracking, coaxial cable tracking, etc.

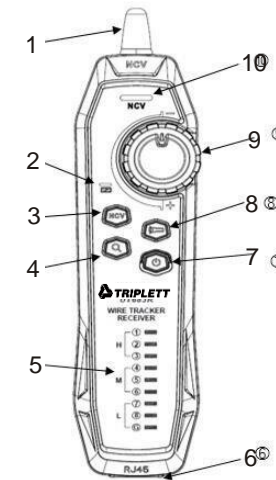

1. Antenna
2. Charging status indicator light
3. NCV button
4. Wire tracking button
5. Wire map indicator light
6. RJ45 jack
7. Power button
8. Flashlight button
9. Sensitivity knob
10. NCV indicator light

8.2.2 Wire Tracking Function

8.2.2.1 Twisted-Pair Wire Tracking

- (1) Connect LVPRO10 tester to the line.
- (2) Set LVPRO10 tester to "SCAN" mode, press "PORT" to select RJ45 port. Short press " " in tone mode to enable the hub blink function. If the tested cable connects with the switch **working**, " " will flash synchronously as the indicator light of switch port flashes.
- (3) LVPRO10 RECEIVER PROBE Receiver: Adjust the sensitivity with the knob. Making "Beep--Beep--Beep" sound indicates that the tested cable is found out.

8.2.2.2 Coaxial Cable Tracking

- (1) Connect LVPRO10 tester to the line.
- (2) Set LVPRO10 tester to "SCAN" mode, press "PORT" to select coaxial cable port.
- (3) LVPRO10 RECEIVER PROBE Receiver: Adjust the sensitivity with the knob. Making "Beep--Beep--Beep" sound indicates that the tested cable is found out.

8.2.2.3 Wire Tracking Diagram

If the targeted cable is among a large amount of other cables, please adjust the sensitivity with the knob. High sound volume indicates that the received signal is strong and the targeted cable is close.

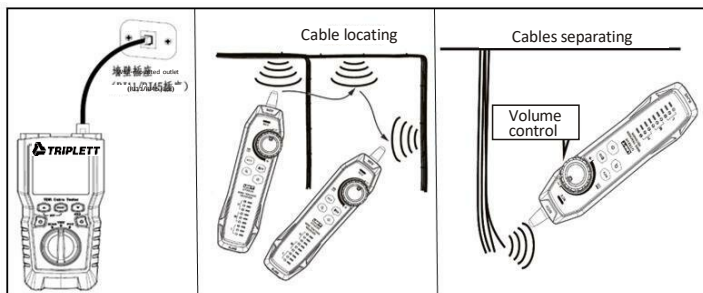

Figure 8.2 Wire Tracking Diagram

8.2.2.4 Other Functions

- (1) NCV function: Press "NCV" to enable NCV function. If the voltage of targeted cable or receptacle is greater than 40V (AC), the receiver makes beep sound and the NCV indicator light flashes synchronously.
- (2) Flashlight: Press the flashlight button to enable the flashlight function separately.
- (3) Low battery indication: If the battery voltage is lower than 3.4V, the power button flashes; if lower than 3.0V, the receiver powers off.
- (4) Earphone: When performing a test in noisy environment, please minimize the sensitivity, and then wear earphone to adjust the sensitivity for appropriate sound volume. Interference can be avoided by wearing earphones. Note that earphones are not supplied.

IX. Calibrating Length Measurements (Only for test mode)

9.1 Setting the NVP to a Specified Value

As shown in figure 9.1, set NVP as a specified value:

- (1) Hold down " ", " " and " " at the same time to enter NVP setting mode.
- (2) To set the NVP for coaxial port, please press "PORT".
- (3) Use " " and " " to set the NVP value.
- (4) To save the setting and exit NVP mode, turn the tester off then on again.

The tester calculates cable length through the use of NVP and signal delay. The default NVP is accurate enough to verify length, but in actual measurement, the length measurement accuracy can be improved by adjusting the NVP to specified or actual value.

Note: NVP refers to Nominal Velocity of Propagation. 69% mainly refers to the proportion of propagation velocity of electron through cable to velocity of light, i.e., the velocity of light is about 0.3m/ns, and the propagation velocity of electron through cable is 0.2m/ns, then, NVP is the proportion of these two velocities ($\frac{\text{Electron velocity}}{\text{Light velocity}}$), which is calculated in cable test by manufacturer. NVP varies depending on different cables, but the NVP of unshielded twisted pair (UTP) is 69% typically, except for special settings, which need to be set by DSP. NVP is the key value to calculate length.

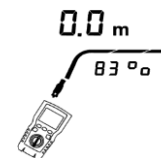

Figure 9.1 NVP Value Setting Interface

9.2 Determining a Cable's Actual NVP

- (1) Hold down “”, “” and “” at the same time to enter NVP setting mode.
- (2) To set the NVP of coaxial port, please press “PORT”.
- (3) Connect a known length of the cable to be tested to the tester's coaxial cable port.
- (4) Use “” and “” to change the NVP until the measured length matches the actual length of the cable.
- (5) To save the setting and exit NVP mode, turn the tester off then on again.
To measure actual NVP, please adjust the measured length to the known length.

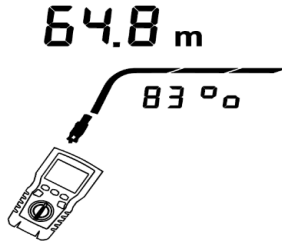

Figure 9.2 Determining a Cable's Actual NVP

X. Backlight

In ON state, long press “” for one second to turn on/off the backlight.

XI. Unit of Length

In ON state, short press “” to switch between ft and m.

XII. Auto Power Off

The tester powers off automatically if it is not operated in 10 minutes (60 minutes under wire tracking state).

XIII. Other functions

13.1 Low battery indication

Please replace the battery when the symbol “” appears. Power off the tester and disconnect all test leads before replacement.

13.2 Troubleshooting

- (1) The tester cannot power on normally: Replace battery
- (2) Measurement length is inaccurate: Check NVP and adjust NVP by a cable with known length.
- (3) Display or button does not response: Power off and restart the tester.

13.3 Specifications

Operating temperature	0~45℃
Storage temperature	-20~60℃
Operating humidity	20~75% RH (N.C)
Storage humidity	10~90% RH (N.C)
Operating altitude	≤2000m
Category rating	CE, EN 61326-1:2013 / EN61326-2-2:2013
Tester dimensions	181mm*80mm*39mm
Receiver dimensions	197mm*48mm*34mm
Test net weight	About 360g
Receiver net weight	About 127g

XIV. Maintenance

- (1) Solvent or corrosive cleaning agent can damage the display or casing. Please wipe the display with soft cloth and glass cleaner, and wipe the casing through soft cloth dipped with clear water or liquid soap. Keep the tester dry.
- (2) Do not open the casing, there is no any user-replaceable part inside the tester. Opening the case without authorization will void the warranty and may damage the safety function.
- (3) Use designated replacement part only.

Warranty

Triplett / Jewell Instruments extends the following warranty to the original purchaser of these goods for use. Triplett warrants to the original purchaser for use that the products sold by it will be free from defects in workmanship and material for a period of (1) one year from the date of purchase. This warranty does not apply to any of our products which have been repaired or altered by unauthorized persons in any way or purchased from unauthorized distributors so as, in our sole judgment, to injure their stability or reliability, or which have been subject to misuse, abuse, misapplication, negligence, accident or which have had the serial numbers altered, defaced, or removed. Accessories, including batteries, are not covered by this warranty.

Copyright © 2023 Triplett
www.triplett.com