

CM650

600A TRMS AC/DC Clamp Meter



Introduction

Congratulations on your purchase of the Triplet CM650 600A True RMS AC/DC Clamp meter. The CM650 True RMS AC/DC Clamp meter features:

- AC/DC Current measurements up to 600A.
- Variable Frequency Drive (VFD) Voltage Measurements
- Inrush Current Mode
- Temperature Measurements
- Non-contact AC voltage detection
- Auto Power OFF

Safety

International Safety Symbols



This symbol, adjacent to another symbol or terminal, indicates the user must refer to the manual for further information.



This symbol, adjacent to a terminal, indicates that, under normal use, hazardous voltages may be present



Double insulation

SAFETY NOTES

- Do not exceed the maximum allowable input range of any function.
- When the instrument is not in use, press the ON/OFF key to turn off the meter.
- Remove the battery if meter is to be stored for longer than 60 days.

CAUTIONS

- Improper use of this meter can cause damage, shock, injury or death. Read and understand this user manual before operating the meter.
- Always remove the test leads before replacing the battery.
- The meter itself for any damage before operating the meter. Repair or replace any damage before use.
- Use great care when making measurements if the voltages are greater than 25VAC rms or 35VDC. These voltages are considered a shock hazard.
- Voltage checks on electrical outlets can be difficult and misleading because of the uncertainty of connection to the recessed electrical contacts. Other means should be used to ensure that the terminals are not “live”.

Input Limits

Function

A AC, A DC

V DC, V AC

Resistance, Capacitance,

Frequency, Diode Test,

Temperature.

Maximum Input

600A DC/AC

1000V DC/AC

300V DC/ AC

Description

Meter Description

1. NCV (Non-Contact Voltage) Sensor
2. Current Clamp
3. NCV (Non-Contact Voltage) Indicator LED
4. Clamp Trigger
5. Rotary Function Switch
6. LCD Display
7. Data HOLD/Flashlight Button
8. REL/Backlight Button
9. Range Button
10. MODE and VFD Button
11. PEAK and INRUSH Button
12. Flashlight
13. Battery Cover
14. COM Input Jack (-)
15. Positive Input Jack (+)

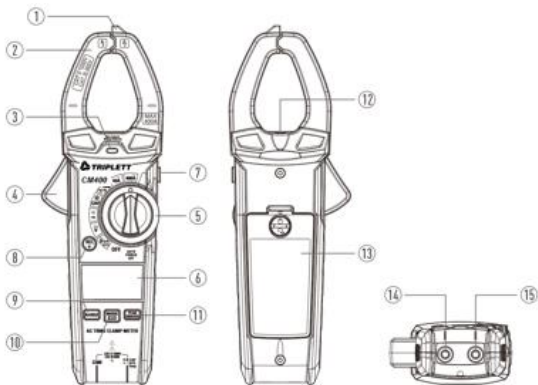

Display Icons Description

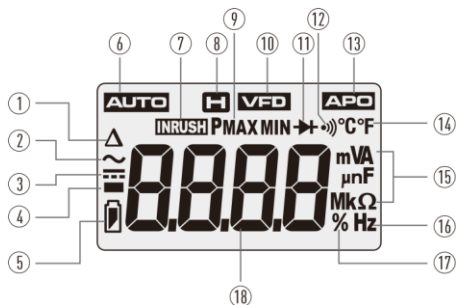

1. REL/ ZERO Button
2. Alternating Current/Voltage
3. Direct Current/Voltage
4. Minus Sign
5. Low Battery
6. Auto Range Mode
7. INRUSH Current Mode
8. Display Hold
9. MAX/MIN Mode
10. Variable Frequency Drive (VFD) Voltage Value
11. Diode Test
12. Continuity Test
13. Auto Power Off (APO)
14. Faranheit and Celcius Units (Temperature)
15. Units of Measure Prefixes
16. Hertz (Frequency)
17. Percent (%) Duty Cycle
18. Measurement Display Digits

Operation

AC/DC Current Measurements

***NOTE:** *Ensure that the test leads are disconnected from the meter before making current clamp measurements.**

1. Set the Function switch to the **600A** range, If the approx range of the measurement is not known, select the highest range then move to the lower ranges if necessary.
2. Press the **REL** button to zero the meter display.
3. Use rotary function switch to select **60A AC/DC** or **600A AC/DC** range.
4. Use **MODE** Button to select **AC** or **DC**.
5. Select AC current Test, press the **INRUSH/PEAK** Button to turn Inrush current test, the LCD will display “----”.
6. Press the trigger to open jaw, Enclose only one conductor, For optimum results, center the conductor in the jaw.
7. The clamp meter LCD will display the reading.



NO



YES

AC Voltage Measurements

8. Insert the black test lead into **COM** input jack and the red test lead into the **Positive** input jacks.
9. Set the function switch to the **VAC** position.
10. Press the **MODE/VFD** Button for 1 second to turn on the VFD test.
11. Press the **INRUSH/PEAK** Button to turn on PEAK test.
12. Connect the test leads in parallel to the circuit under test.
13. Read the voltage measurement on the LCD display.





DC Voltage Measurements

1. Insert the black test lead into **COM** input jack and the red test lead into the **Positive** input jacks.
2. Set the function switch to the **VDC** position.
3. Connect the test leads in parallel to the circuit under test.
4. Read the voltage measurement on the LCD display.

Resistance Measurements

1. Insert the black test lead into the **COM** input jack and the red test lead into the **Positive** input jacks.
2. Set the function switch to the Ω CAP position.
3. Touch the test probe tips across the circuit or component under test.
4. Read the resistance on the LCD display.

Continuity Measurements

1. Insert the black test lead into the **COM** input jack and the red test lead into the **Positive** input jacks.
2. Set the function switch to the “ ” position.
3. Use the **MODE** Button to select continuity “”, The display icons will change when the **MODE** Button is pressed. 
4. Touch the test probe tips across the circuit or component under test.
5. If the resistance is $<50\Omega$, a tone will sound.

Capacitance Measurements

WARNING: To avoid electric shock, discharge the capacitor under test before measuring.

1. Set the function switch to the Ω CAP position.
2. Insert the black test lead into the **COM** input jack and the red test lead into the **Positive** input jacks.
3. Touch the test probe tips across the part under test, If “**OL**” appears in the display, remove and discharge the component.
Read the capacitance value in the display.
4. The display will indicate the proper decimal point and value.

Frequency Measurements

1. Insert the black test lead into the **COM** input jack and the red test lead into the **Positive** input jacks.
1. Set the function switch to the **VAC Hz/%** Position.
2. Press **MODE** Button to select the Frequency (**Hz**) or Duty Cycle (**%**).
3. Touch the test probe tips across the part under test.
4. Read the value on the display.
5. The display will indicate the proper decimal point and value.

Temperature Measurements

1. Set the function switch to the **TEMP** position.
2. Insert the Temperature Probe into the negative **COM** and **Positive** jacks, observing polarity.
3. Touch the Temperature Probe head to the device under test, Continue to touch the part under test with the probe until the reading stabilizes.
4. Read the temperature on the display, The digital reading will indicate the proper decimal point and value.
5. Use the **MODE** Button to select °C or °F.

WARNING: To avoid electric shock, be sure the thermocouple probe has been removed before changing to another measurement function.

Diode Measurements

1. Insert the black test lead into the **COM** input jack and the red test lead into the **Positive** input jacks.
2. Turn the function switch to “→” position.
3. Use the **MODE** Button to select the diode function if necessary (Diode symbol will appear on the LCD when in Diode test mode)
4. Touch the test probe tips to the diode or semiconductor junction under test. Note the meter reading.
5. Reverse the test lead polarity by reversing the red and black leads, Note this reading.
6. The diode or junction can be evaluated as follows:
 - If one reading displays a value (Typically 0.400V to 0.900V) and the other reading displays “**OL**”, the diode is good.
 - If both readings display “**OL**” the device is open.
 - If both readings are very small or ‘**0**’, the device is shorted.

Non-Contact Voltage (NCV) Measurements

WARNING: Risk of Electrocution, always test the Voltage Detector on a known live circuit to verify proper operation before use.

1. Touch the probe tip to the hot conductor or insert into the hot side of the electrical outlet.
2. If AC voltage is present, the detector light will illuminate.

Note: The conductors in electrical cord sets are often twisted. For best results, rub the probe tip along a length of the cord to assure placing the tip in close proximity to the live conductor.

Note: The detector is designed with high sensitivity. Static electricity or other sources of energy may randomly trip the sensor. This is normal operation.

Function Buttons

MODE and VFD Button

- Short Press the **MODE/VFD** Button to toggle between modes available for the rotary switch position (V/Hz/%)
- Long Press and Hold the **MODE/VFD** while **POWERING ON** will disable the Auto Power OFF (APO) Function
- Long Press and hold **MODE/VFD** will engage VFD measuring mode.

HOLD and Flashlight Button

- To freeze the LCD reading, press the **Hold/Flashlight** Button.
- While data hold is active, the “**H**” icon appears on the LCD.
- Press the **Hold/Flashlight** Button again to return to normal operation.
- The LCD is equipped with backlighting for easier viewing, especially in dimly lit areas.
- Press the **Hold/Flashlight** Button to turn the Flashlight on, Press again to turn the Flashlight off.

Range Button



- Press the **RANGE** Button to activate the manual mode and to disable the Autorange function, The symbol “**AUTO**” disappears from the upper left part of the display.
- In manual mode, press the **RANGE** Button to change measuring range, the relevant decimal point will change its position.
- The **RANGE** Button is not active in positions \bullet \gg , \rightarrow , CAP, Hz%, Temp °C °F .
- In Autorange mode, the instrument selects the most appropriate ratio for carrying out measurement.
 - If a reading is higher than the maximum measurable value, the indication “**O.L**” appears on the display.
- Press and hold the **RANGE** Button for more than 1 second to exit the manual mode and restore the Autorange mode.

PEAK/ INRUSH Button

- In AC voltage test mode, Press **PEAK/INRUSH** Button the Peak maximum and Peak minimum values are measured.
- In current test mode, Press **PEAK/INRUSH** Button the Inrush current values are measured.

Relative/Backlight Button

The relative measurement feature allows you to make measurements relative to a stored reference value, A reference voltage, current, Capacitance etc. can be stored and measurements made in comparison to that value, The displayed value is the difference between the reference value and the measured value.

- Press the “**REL/Backlight**” Button to zero the display “” will appear in the display.
- To exit this mode, press the “**REL/Backlight**” Button again, and “” will disappear in the display.
- DC voltage measurement mode, Press the “**REL/Backlight**” Button to “**zero**” the display.
- Press and hold the the “**REL/Backlight**” Button to turn the Backlight on, Press and hold again to turn the Backlight off.

Auto Power OFF (APO)

- In order to conserve battery life, the meter will automatically turn off after approximately 15minutes.
- To turn the meter on again, turn the function switch to the **OFF** position and then to the desired function position.
- To press and hold the **MODE/VFD** Button to turn the system on, the auto power off function will be cancelled.

Maintenance

WARNING: To avoid electrical shock, disconnect the meter from any circuit, remove the test leads from the input terminals, and turn OFF the meter before opening the case. Do not operate the meter with an open case.

Cleaning and Storage

Periodically wipe the case with a damp cloth and mild detergent; do not use abrasives or solvents. If the meter is not to be used for 60 days or more, remove the battery and store it separately.

Battery Replacement

1. Remove the Phillips head screw that secures the rear battery door
2. Open the battery compartment.
3. Replace the 1.5V x 3 "AAA" batteries.
4. Secure the battery compartment.

Type K Temperature Probe Replacement

Note: To use a Type K thermocouple probe that is terminated by a subminiature (Flat blade) connector, a subminiature-to-banana plug adaptor is required.

Specifications

Function	Range	Resolution	Accuracy \pm (% of reading+digits)
AC True RMS Current	60.00A	10mA	$\pm 2.0\%$ of rdg ± 8 digits
	600.0A	100mA	$\pm 2.5\%$ of rdg ± 8 digits
Over rang protection: Maximum input 600A; Accuracy specified from 5% to 100% of the measuring range; Frequency Response:50Hz to 60Hz True RMS; Inrush current Maximum Input: 600A;Inrush current Sensitivity: $>2A$.			
DC Current Max:600A	60.00A	10mA	$\pm 2.0\%$ of rdg ± 8 digits
	600.0A	100mA	$\pm 2.5\%$ of rdg ± 8 digits
AC True RMS Voltage (with VFD)	6.000V	1mV	$\pm 1.2\%$ of rdg ± 5 digits
	60.00V	10mV	
	600.0V	100mV	
	1000V	1V	$\pm 1.5\%$ of rdg ± 5 digits
Variable frequency drive test AC voltage rang: 100V-600V. AC voltage bandwidth: 50 to 1000Hz(Sine); 50/60(All wave). Accuracy specified from 5% to 100%of the measuring range. Maximum Input: 1000V ac rms. PEAK Maximum Input:1000V.			
DC Voltage Maximum Input: 1000V dc	6.000V	1mV	$\pm 0.9\%$ of rdg ± 3 digits
	60.00V	10mV	$\pm 1.0\%$ of rdg ± 3 digits
	600.0V	100mV	
	1000V	1V	$\pm 1.2\%$ of rdg ± 3 digits
Resistance	600.0 Ω	0.1 Ω	$\pm 1\%$ of rdg ± 4 digits
	6.000k Ω	1 Ω	$\pm 1.5\%$ of rdg ± 2 digits
	60.00k Ω	10 Ω	
	600.0k Ω	100 Ω	
	6.000M Ω	1k Ω	$\pm 2.0\%$ of rdg ± 5 digits
	60.00M Ω	10k Ω	$\pm 3\%$ of rdg ± 8 digits

Input Protection: 300V dc or 300V ac rms.

Function	Range	Resolution	Accuracy \pm (% of reading+digits)
Capacitance (Auto-Ranging)	99.99nF*	0.01nF	$\pm 4.5\%$ of rdg ± 20 digits
	999.9nF	0.1nF	$\pm 3.0\%$ of rdg ± 5 digits
	9.999 μ F	0.001 μ F	
	99.99 μ F	0.01 μ F	
	999.9 μ F	0.1 μ F	
	9.999mF	0.001mF	$\pm 5\%$ of rdg ± 5 digits
99.99mF	0.01mF		

Input Protection: 300Vdc or 300V ac rms. $< 99.99\text{nF}$ (No specification)

Frequency with Test Leads (AC Voltage)	10Hz to 100kHz	$\pm 1.0\%$ of rdg ± 5 digits
--	----------------	-----------------------------------

Input Protection: 1000V AC rms; Sensitivity: $>15\text{V AC rms}$.

Frequency (AC Current)	45Hz to 1kHz	$\pm 1.0\%$ of rdg ± 5 digits
------------------------	--------------	-----------------------------------

Sensitivity: $>20\text{A}$.

Duty Cycle	20.0%~80.0%	0.1	$\pm 1.2\%$ of rdg ± 10 digits
Temperature	-20 to 1000°C	0.1/1°C	$\pm 3\%$ of rdg $\pm 3^\circ\text{C}$
	-4 to 1832°F	0.1/1°F	$\pm 3\%$ of rdg $\pm 5^\circ\text{F}$

Sensor: Type K Thermocouple; Input Protection: 300V dc or 300V ac rms.

Function	Testing Condition	Reading
Diode	Forward DCA is approx. 1mA, open circuit Voltage MAX. 3V	Forward voltage drop of Diode
Continuity	Test current MAX. 1.5mA	Buzzer makes a long sound, While resistance is less than(50 Ω)

Input Protection: 300V dc or 300V ac rms.

General Specifications

Clamp Jaw Opening	1.3" (33mm) approx
Display	6000 counts backlit LCD
Low Battery Indication	"  " is displayed
Over-Range Indication	"OL" display
Measurement Rate	3 readings per second, nominal
Temperature Sensor	Type K thermocouple
Input Impedance	10MΩ(VDC and VAC)
AC Response	True rms (AAC and VAC) 2KHz
ACV Bandwidth	5 to 40°C (41 to 104°F)
Operating Temperature	-20 to 60°C (-4 to 140°F)
Storage Temperature	Max 80% up to 31°C(87°F) decreasing linearly to 50% at 40°C(104°F)
Operating Humidity	<80%
Storage Humidity	7000ft. (2000meters) maximum.
Operating Altitude	3 x 1.5V "AAA" Batteries
Battery	~30h (Backlight ON), ~100h (Backlight OFF)
Battery Life	After approx. 15 minutes
Auto Power Off	For indoor use and in accordance with the requirements for double insulation to CAT II 1000V, CAT III 600V (EN 61010-1:2010+A1:2019, EN 61010-2-032:2012, EN 61010-2-033:2012 Low Voltage Directive 2014/35/EU), Pollution Degree 2
Safety	
Weight	10.2 oz (290.6g)
Dimensions	9.4 x 3.0 x 1.5" (238.8 x 76.5 x 38mm)

Warranty Information

Triplett / Jewell Instruments extends the following warranty to the original purchaser of these goods for use. Triplett warrants to the original purchaser for use that the products sold by it will be free from defects in workmanship and material for a period of (1) one year from the date of purchase. This warranty does not apply to any of our products which have been repaired or altered by unauthorized persons in any way or purchased from unauthorized distributors so as, in our sole judgment, to injure their stability or reliability, or which have been subject to misuse, abuse, misapplication, negligence, accident or which have had the serial numbers altered, defaced, or removed. Accessories, including batteries are not covered by this warranty

Copyright © 2020 Triplett

www.triplett.com