



IDEAL NETWORKS

TEquipment
USA
An Interworld Highway, LLC Company

Call Us 1.877.571.7901

LanXPLOER Pro



COPYRIGHT NOTICE

The information contained in this document is the property of IDEAL INDUSTRIES Ltd. and is supplied without liability for errors and omissions. No part of this document may be reproduced or used except as authorized by contract or other written permission from IDEAL INDUSTRIES Ltd. The copyright and all restrictions on reproduction and use apply to all media in which this information may be placed.

IDEAL INDUSTRIES Ltd. pursues a policy of continual product improvement and reserves the right to alter without notice the specification, design, price or conditions of supply of any product or service.

© **IDEAL INDUSTRIES LTD. 2016**

All rights reserved

Publication ref: 150835

Issue 5 - 05/2016

(Applies to software revision 2.0.40 onwards)

IDEAL INDUSTRIES LTD.
Stokenchurch House
Oxford Road
Stokenchurch
High Wycombe
Buckinghamshire
HP14 3SX UK

www.idealnetworks.net

Safety Precautions

CAUTION ON HANDLING RECHARGEABLE BATTERIES (ACCUMULATOR BATTERIES)

All nickel/metal hydride (Ni-MH) rechargeable batteries generate sufficient electrical current to cause injury and/or damage regardless of the charge state indicated.

Nickel/metal hydride (Ni-MH) rechargeable batteries should never be exposed to fire or disposed of with normal domestic waste. Nickel/metal hydride (Ni-MH) rechargeable batteries can explode when exposed to open flames. These batteries constitute special hazardous waste and can contaminate the ground water when disposed of at a waste dump.

Observe the following instructions precisely when handling rechargeable batteries to avoid injury.

- When a rechargeable battery is not installed in the hand-held instrument, it should be stored in a clean, dry and non-conductive package.
- Ensure that the contacts on the rechargeable battery do not come into contact with conductive materials.
- Avoid touching the contact surfaces on the rechargeable battery.
- The rechargeable batteries can be charged while installed in the hand-held instrument. Charging in any other manner can result in the rechargeable battery exploding.
- Install, remove, store and charge the rechargeable batteries only in non-explosive atmospheres.
- Observe the operating and storage temperatures (see. Dimensions, Weights, Operating Conditions).
- Do not allow children or persons not familiar with the safety precautions in these operating instructions to handle or charge rechargeable batteries.
- Never open the rechargeable battery case. There are no user-serviceable parts in the case and the rechargeable batteries contained in the case are not replaceable.

Disclaimer

IDEAL INDUSTRIES, LTD. does not assume any liability for death, injury or damage to equipment or property resulting from improper use of the battery packs.

IDEAL INDUSTRIES, LTD. will not be liable for consequential damages that may result from tampering with the battery packs or charger or their use thereafter.

Subject to technical changes.

Environmental Protection

If you have any questions concerning these precautions, the operating instructions, or any other concerns about the safe use and disposal of the battery packs used in LanXPLOER Pro, please contact a representative of IDEAL INDUSTRIES, LTD.

Information on the use of this Instruction Manual

The following symbols used in this manual indicate that the user should exercise particular caution in order to prevent personal injury or damage to the LanXPLOER or the system under test.



WARNING!

This symbol indicates potentially lethal voltages or dangerous situations. The life and/or health of the person performing the activity or anybody in the vicinity is at risk.



CAUTION!

This symbol indicates that the relative activity could possibly harm the environment or damage technical equipment.

NOTE:

Here you will find general notes, additional information, or support.

Typographical Conventions

- **Boldface** Refers to a button on LanXPLOER.
- *Italics* Refers to a menu option in this Operating Manual.
- Quotation marks " " identify a "Screen Message".

CONTENTS

Chapter 1. Your LanXPLOER	6
1.1 Technical Data.....	Error! Bookmark not defined.
1.2 Dimensions, Weights, Operating Conditions	7
Chapter 2. Instrument description	8
2.1 LanXPLOER	8
2.1.1 Controls And Interfaces/Connections	8
2.1.2 Image on TFT display.....	10
2.1.3 Touchscreen.....	10
2.1.4 Arrow keys / Enter	10
2.1.5 Softkeys.....	10
2.2 Power options	11
2.2.1 Mains Operation.....	11
2.2.2 Charging rechargeable batteries.....	12
2.2.3 Removing / installing rechargeable batteries	12
Chapter 3. Settings	13
3.1 Principles	13
3.2 System	14
3.2.1 Owner.....	14
3.2.2 Preferences.....	14
3.2.3 Update	15
3.2.4 Jobs.....	15
3.2.5 Save	16
3.2.6 About	16
3.2.7 Language.....	17
3.2.8 Date and Time	17
3.2.9 Factory	17
3.3 RJ45.....	18
3.4 Fiber-optic cable	19
3.5 Tests	19
3.5.1 Cable Wire Tests	19
3.5.2 Autotest	21
3.5.3 IP Tests	21
3.5.4 Targets V4 & Targets V6	26
3.6 IPv4	28
3.7 IPv6	29
3.8 VLAN	29
3.9 Wi-Fi	30
3.9.1 Connect / disconnect with an existing Wi-Fi network	30
3.9.2 Creating a new Wi-Fi network	30
3.9.3 Changing a Wi-Fi network already present.....	30
3.9.4 Deleting a Wi-Fi network already present.....	30
3.10 802.1x	30
Chapter 4. Test Summary	32
Chapter 5. Test Setup	33
5.1 Ports.....	33
5.2 Passive Wiring	33
5.2.1 Testing a passive link without Active Remote	33
5.2.2 Testing a passive link with Active Remote	34
5.3 Active wiring	35
5.4 Inline Test	35
5.5 Fiber-optic cable	36
5.6 Wi-Fi	37
Chapter 6. Test description and procedure	38
6.1 Test summary	38
6.1.1 Performing individual tests.....	38
6.1.2 Resetting test results.....	38



6.1.3	Saving test results	38
6.2	Autotest	39
6.2.1	Run Autotest	39
6.2.2	Overall pass/fail result	39
6.2.3	Display of individual test results	39
6.3	Wiremap test	39
6.3.1	Performing Wiremap test	40
6.3.2	Display results	40
6.4	Testing a passive route without Active Remote	41
6.5	Netmap	42
6.5.1	Performing test	42
6.5.2	Saving Netmap for comparisons - Verify	42
6.5.3	Display results	42
6.6	Verify	43
6.6.1	Performing test	43
6.6.2	Saving Netmap for comparisons - Verify	43
6.6.3	Display results	43
6.7	PING4 & PING6	44
6.7.1	Performing test	44
6.7.2	Display results	44
6.8	Voice over IP (VoIP)	45
6.8.1	Performing test	45
6.8.2	Display results	45
6.9	Trace Route	46
6.9.1	Performing test	46
6.9.2	Display results	46
6.10	Blink	47
6.10.1	Performing test	47
6.11	Power over Ethernet (PoE)	47
6.11.1	Performing test	47
6.11.2	Display results	47
6.12	Loop	48
6.12.1	Performing test	48
6.13	PC Diagnosis	48
6.14	Statistics	49
6.15	Wi-Fi	50
6.15.1	Connecting to a network	50
6.15.2	Performing tests	51
Chapter 7.	Wiring test on fiber-optic conductors and SFP modules	52
7.1	Safety precautions	52
7.2	Instructions for cleaning SFP modules and patch cables	52
Chapter 8.	Reports	53
Chapter 9.	LanXPLOER Firmware Update	55
Chapter 10.	Spare parts - Socket inserts	56
Chapter 11.	Specifications	57



Chapter 1. Your LanXPLOER

The LanXPLOER can be used to test RJ45 cable routes, networks, connected Ethernet devices and fiber-optic cable used for high speed transmission of data in communications networks.

1.1 Main Functions

Function	LanXPLOER Pro
Screen size	3.5" TFT color, TOUCH
Wiremap	✓
Number of ports	2 copper 1 fiber, Wi-Fi
Tone Generator	✓
PoE / PoE+ measurement	✓
PoE / PoE+ device load measurement	✓
Basic active tests (DHCP, Ping etc.)	✓
Top Ten test (Talkers, Listeners, protocols etc.)	✓
Device map / NetVerify	✓
Inline testing	✓
VoIP measurement	✓
VLAN Discovery	✓
802.1x	✓
Loopback	✓
Results transfer to PC	Via USB memory stick
Result transfer to mobile devices	Via Wi-Fi USB adapter
Internal battery charging	✓
External power supply	✓

1.2 Dimensions, Weights, Operating Conditions

Dimensions:

(L) 205 mm x (W) 98 mm x (D) 45 mm

Weights:

Handheld display 650 g (incl. Batteries)
 Batteries 180 g

Batteries:

NiMH * (battery pack)

Operating Time With Rechargeable Batteries:

4 hours under normal operating conditions

Charging time:

In instrument 8 hours

Operating temperature (min./max.):

0° C to +40° C (use only when instrument temperature is close to ambient temperature!)

Storage Temperature (Min./Max.):

-20° C to +70° C

Relative Humidity:

5% to 90%, non-condensing

Equipment Included:

Quantity	Description
1	Measuring instrument
1	Active Remote
1	Carrying case
2	STP Patch cables, 30 cm
1	Quick Reference Guide
1	NiMH rechargeable battery pack
1	IDEAL amplifier probe 62-164
1	RJ45 insert extraction tool plus 10 x RJ45 inserts
1	High sensitivity USB Wi-Fi antenna

Chapter 2. Instrument description

2.1 LanXPLOER

The LanXPLOER guarantees control of the settings and test functions while performing individual tests.

2.1.1 Controls And Interfaces/Connections



Fig. 1: LanXPLOER - Front view

Item	Controls	Description
1	ON/OFF	For switching the LanXPLOER on and off. Hold key down: To restart.
2	Arrow keys / Enter	For navigation in menus on TFT display / Entry key for activation and editing in selected menu.
3	Autotest	Immediate execution of pre-programmed test procedure.
4	Function keys F1 to F4	For selection of soft keys displayed on screen.
5	TFT display	Display of menus, test results, graphs, actions selected and function keys. Touchscreen* for display and selection of menus, test results, graphs, action selection and function keys.
6	Escape	Return to previous menu or discontinue and exit current menu without saving changes.
7	LEDs	Display of charging status Illuminated green: Batteries are being charged. Off (with charger connected): Batteries are charged. Flashing green: Batteries cannot be charged - AA cells are fitted, battery is too hot or too cold. Flashing red: Batteries cannot be charged - temperature is too high.

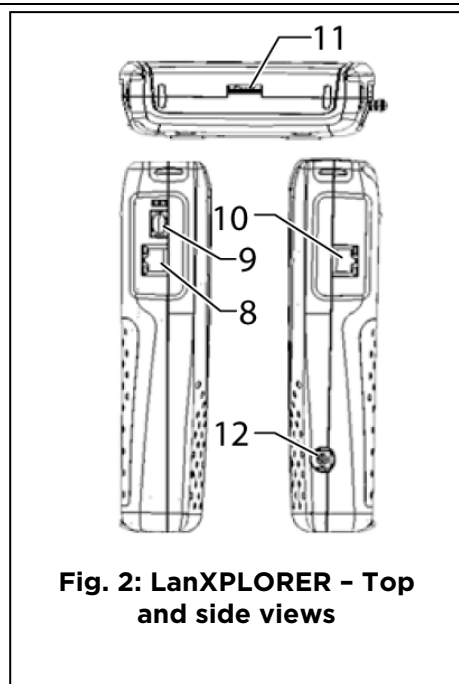

Fig. 2: LanXPLOER - Top and side views

Item	Interfaces / Connections	Description
8	RJ45 main network interface	Terminal for copper cables.
9	Fiber-optic network port	Terminal for fiber-optic cables.
10	RJ45 2 nd diagnostic port	Inline interface for copper cables (active devices)
11	USB external port	Port for connecting USB device. (Wi-Fi antenna & storage)
12	Power socket	Socket for power pack

2.1.2 Image on TFT display

The standby screen appears when the LanXPLOERER is ready for operation.

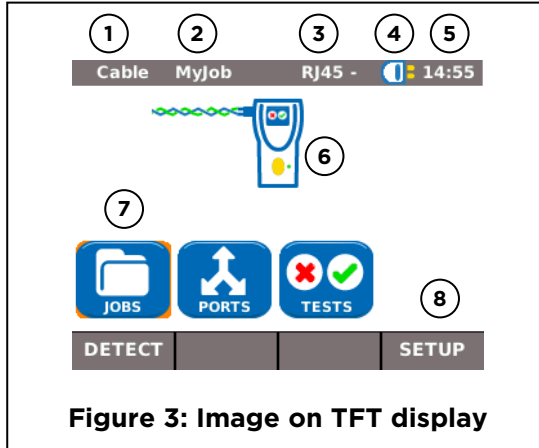

Figure 3: Image on TFT display

Item	Image	Description
1	Instrument mode	Indicates mode to which instrument is set.
2	Job name	Indicates job in which project is being processed.
3	Physical test medium	Indicates test medium connected to LanXPLOERER
4	Battery status	Indicates battery operation or external power supply and charge state of rechargeable battery.
5	Time	
6	LanXPLOERER	
7	Menu points	
8	Softkeys	Functions will be change on different pages

2.1.3 Touchscreen

Possible options in menus are indicated by symbols on the display. Simply touch the symbol to select the option indicated.

2.1.4 Arrow keys / Enter

Possible options in menus are indicated by symbols on the display. The options can be selected by moving to the corresponding symbols with the **arrow keys**. Confirm the selection by pressing the **Enter key**.

2.1.5 Softkeys

Possible options in menus are indicated by softkeys at the bottom of the screen. The **Function keys (F1 - F4)** below the softkeys can be used to select options.

The example shows optional selection of the **Setup** softkey with the softkeys at the bottom of the screen. Selection can be accomplished with **Function key F4**.

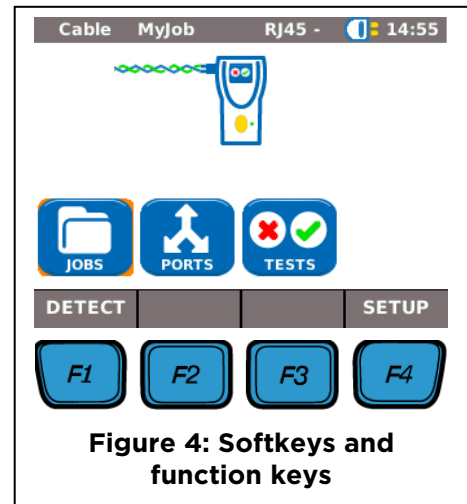

Figure 4: Softkeys and function keys

2.2 Power options

The LanXPLORER can be operated with replaceable AA alkaline batteries (optional battery holder required) as well as rechargeable AA batteries or with an NiMH rechargeable battery pack (default).

- The LanXPLORER can operate for approx. 4 hours with the rechargeable batteries. The actual operating time in battery mode depends on various factors such as use of the background lighting and ambient temperature.
- If the rechargeable battery charge level drops to below the required voltage, a warning message appears. The instrument switches off automatically before any negative effects occur for the test results.
- To preserve your rechargeable batteries, it is possible to set the LanXPLORER to switch off automatically after a certain time with no activity.
- To increase the service life of your rechargeable batteries we recommend removing the batteries when the instrument is not used for longer periods of time.

2.2.1 Mains Operation

The LanXPLORER can be operated using an external DC power source (AC/DC power pack).

During operation of the instrument with the AC/DC charger/power pack, note that:

- The battery pack in the instrument is trickle charged;
- A mains plug is shown in the upper right-hand area on the LanXPLORER;
- Rechargeable AA batteries are not charged in the instrument.



CAUTION!

Use only the power pack supplied with the instrument. Other power packs can damage the tester.

NOTE:

When testing shielded cables do not connect mains power, because otherwise a short-circuit to earth could occur leading to output of warnings for protection of the tester input.

2.2.2 Charging rechargeable batteries

NOTE:

The charging time depends on the charge level of the batteries.

Battery pack

The battery pack for the LanXPLOER can be charged in the LanXPLOER using the charger/power pack. A time of approximately 8 hours is required to completely charge the battery pack in the instrument.

Rechargeable AA batteries (optional)

It is necessary to charge rechargeable AA batteries externally with a charger. They cannot be charged in the LanXPLOER.

2.2.3 Removing / installing rechargeable batteries

When the batteries are removed the LanXPLOER saves the data and settings in the battery-buffered flash ROM.

1. Open the kick stand.
2. Remove the battery cover.

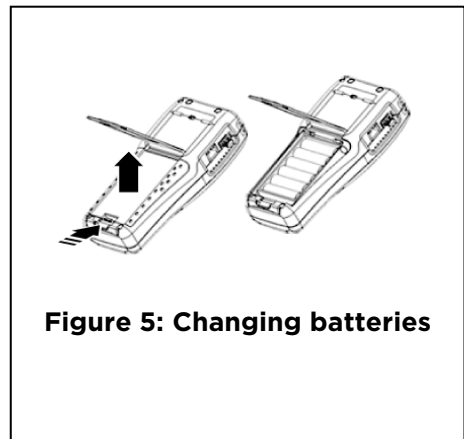

CAUTION!

The battery pack or battery holder is connected to the LanXPLOER with a cable. When removing the batteries, do not pull on the cable - damage to instrument and connector could occur.

1. Remove the battery pack or battery holder.
2. Detach the connector for the battery pack or battery holder from the instrument.
3. If applicable, remove the batteries from the battery holder.

Install batteries in opposite order.

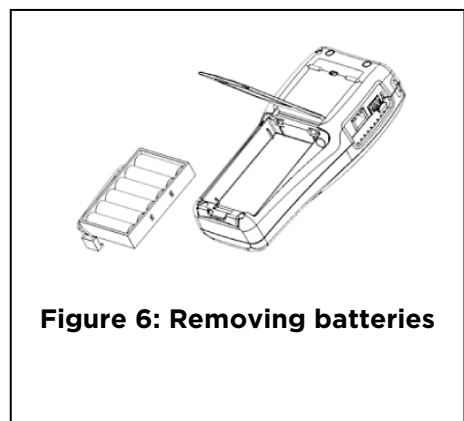

Chapter 3. Settings

3.1 Principles

When the tester is switched on, the Startup screen is displayed. This allows selection of the required test port.

If a test port is not available it is shown in grey.

If the box "Show this screen on start up" is unticked, the standby screen is displayed when the tester is switched on instead of the Startup screen.

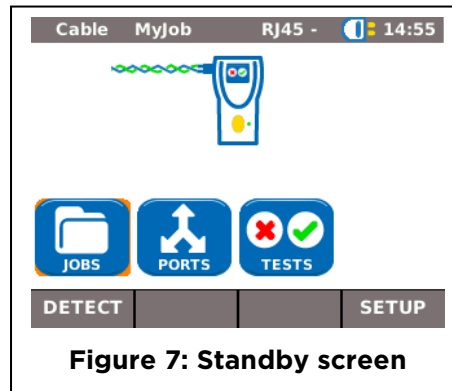
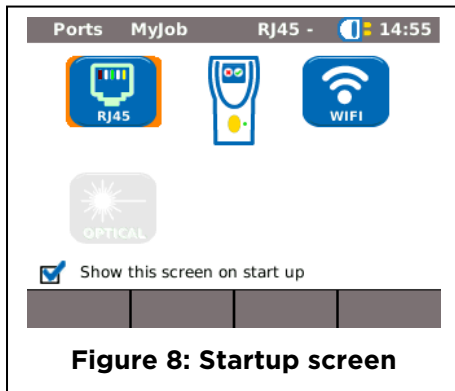

All instrument settings can be made with the **Setup** menu on the standby screen. From the **Setup** menu it is possible to navigate to any of the submenus to make settings there.

1. Select the menu point **Setup**.
2. Make the settings by selecting the applicable menu point.
3. Select **More** to display the next page.

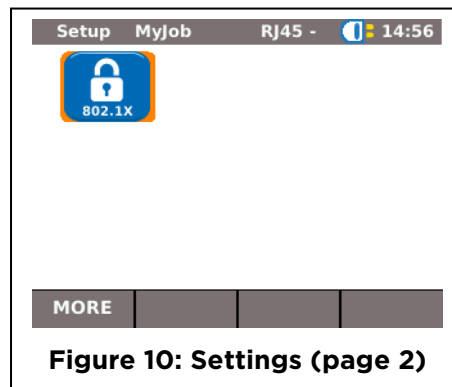
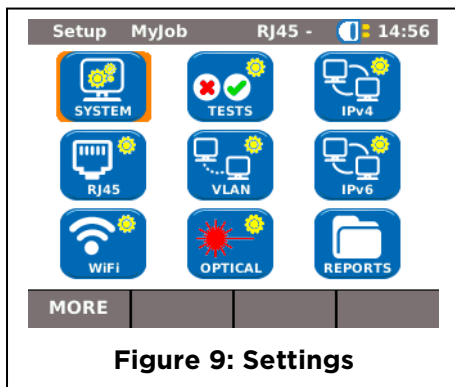



3.2 System

Instrument management is possible in the "System" menu.

1. Select the menu point "System".
2. Make the settings by selecting the applicable menu point.

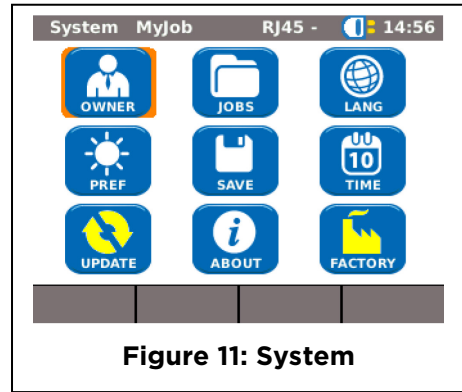

Figure 11: System

3.2.1 Owner

This menu allows information to be saved on the technician performing the work, the company and the client.

1. Select the menu point "Owner".
2. Select the desired option.
3. Enter the desired information with the alphanumeric keys.
4. Save the entry made with **OK**. You can exit the menu without saving the changes with **Cancel** or **Escape**.
5. Save the entry made with **Apply**. You can exit the menu without saving the changes with **Escape**.

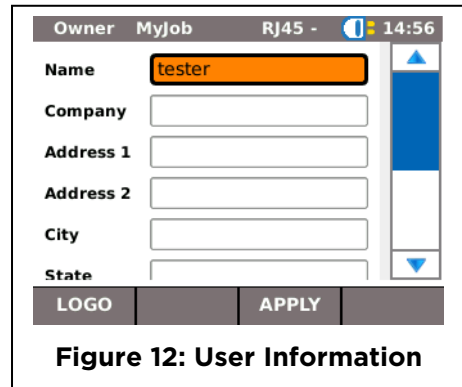

Figure 12: User Information

3.2.2 Preferences

This menu allows settings to be made for the display and display format.

Display settings

1. Select the menu point "Pref".
2. Select the desired option.
3. Set the desired option.
4. Save the entry made with **Apply**. You can exit the menu without saving the changes with **Escape**.

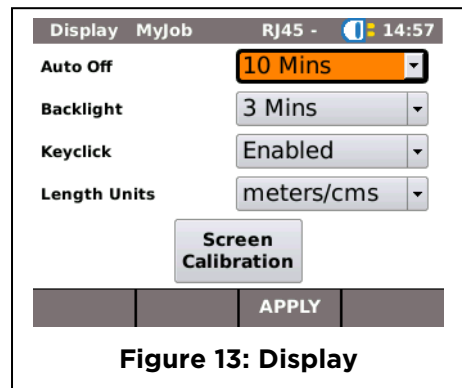

Figure 13: Display

Image	Description
<i>Auto Off</i>	Defines the time after which the LanXPLOER will shut off automatically, if not in use.
<i>Backlight</i>	Defines the time after which the back light dims automatically.
<i>Keyclick</i>	Activates/deactivates an acoustic signal when selecting menus and options.
<i>Length Units</i>	Definition of units of measure for length measurement in <i>ft</i> or <i>m</i> (feet or meters). The default setting depends on the language set.
<i>Screen Calibration*</i>	Calibration of touchscreen.



Screen calibration

1. Select the menu point "Screen Calibration".
2. After the LanXPLOER has automatically restarted touch the cross-hairs, which appear one after another in each corner and in the middle of the screen, as precisely as possible with the pointer or a thin pin.

Successful calibration of the screen is confirmed by a check mark. The LanXPLOER restarts automatically after screen calibration.

3.2.3 Update

The LanXPLOER software can be updated with this menu.

3.2.4 Jobs

Projects can be created and managed with this menu.

NOTE: Job management can also be selected directly with the menu point "Jobs" on the standby screen.

The name of the current job directory is shown on the standby screen on the TFT display. When storing the Autotest it is possible to keep this job directory, activate a job directory already present or to create a new job directory.

1. Select the menu point "Jobs" to obtain a list of all jobs created on your LanXPLOER.

Viewing a present job and test details

1. Select a job from the list, to view the test results and their status.
2. Select a test to obtain further details on the test.
3. Select a single test to obtain further details on the test.

Creating a new job

1. Select **Options**.
2. Select the menu point "New".
3. Select the individual fields and enter the desired information with the alphanumeric keys.
4. Save the entry made with **OK**. You can exit the menu without saving the changes with **Cancel** or **Escape**.
5. Save the entry made with **Apply**. You can exit the menu without saving the changes with **Cancel**.

Changing a job already present

1. Select the job you want to change.
2. Select **Options**.

Menu point	Description
New	Create new job.
To USB	Save job on a USB storage device.
Edit	Change job information.
View	View jobs
Delete	Delete a job.
Activate	Activate a current job for editing.
Setup	Select preferences for the format of the reports

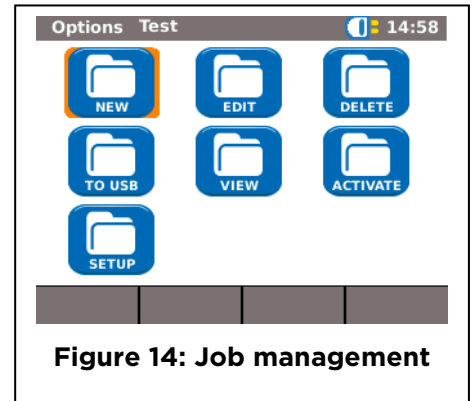

Figure 14: Job management



3.2.5 Save

This menu allows you to

1. export the current LanXPLOER configuration to a USB storage device;
2. load a configuration stored on a USB storage device on the LanXPLOER.

NOTE:

Data export and data import is accomplished exclusively to/from a USB storage device connected to the LanXPLOER.

1. Select the menu point "Save".
2. Select **Save** to store the LanXPLOER configuration on a USB storage device.
3. Select **Load** to load a configuration from a USB storage device on the LanXPLOER.

The exported file is saved on the USB storage device under the Name nmmcfg.xml. to load a configuration on the LanXPLOER, it is necessary for the file with the same name to be present on the USB storage device.

3.2.6 About

This menu contains information on your LanXPLOER.

1. Select the menu point "About".

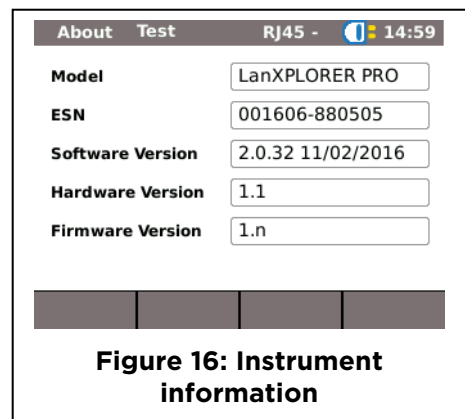
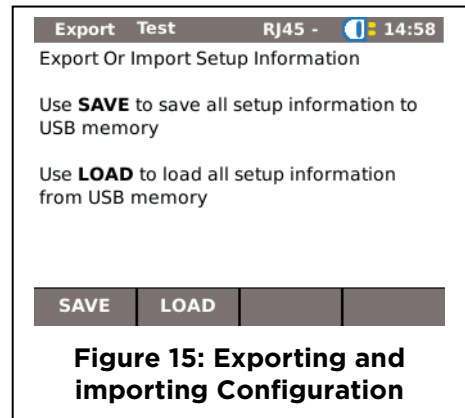

3.2.7 Language

The language can be set with this menu.

1. Select the menu point "Lang".
2. Select the desired language in the Option menu.

Save the entry made with **Apply**. You can exit the menu without saving the changes with **Escape**.

3.2.8 Date and Time

Correct setting of the date and time is important for reliable identification of the data records and test logs.

1. Select the menu point "Time".
2. Set the current date by selecting the month, year and day.
3. Set the current time by selecting the hour, minute and seconds.
4. Save the entry made with **Apply**. You can exit the menu without saving the changes with **Escape**.

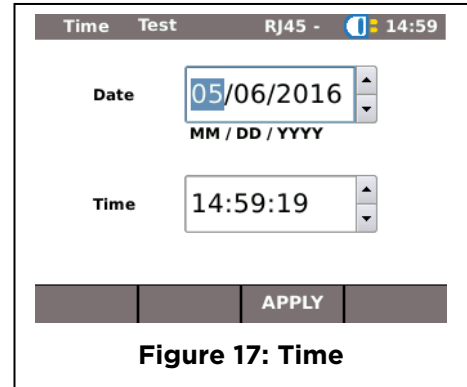

Figure 17: Time

3.2.9 Factory

You can set the LanXPLORER back to the factory settings with this menu.

- All settings are set back to the factory settings.
- All data is deleted from the memory.



CAUTION!

The data cannot be restored after deleting with the "Reset" menu. All tests stored previously are deleted irrevocably.

1. Select the menu point "Factory".
2. With **Reset** returns the instrument to the factory settings and any settings you have made are deleted.

You can exit the menu without saving the changes with **Cancel** or **Escape**.

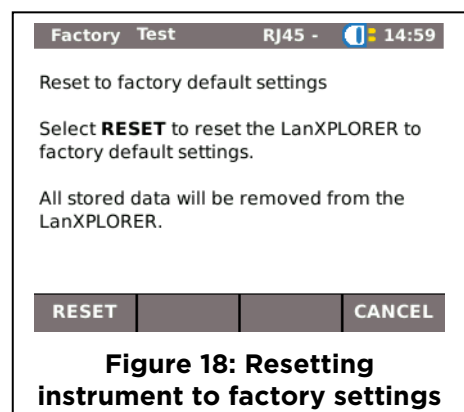
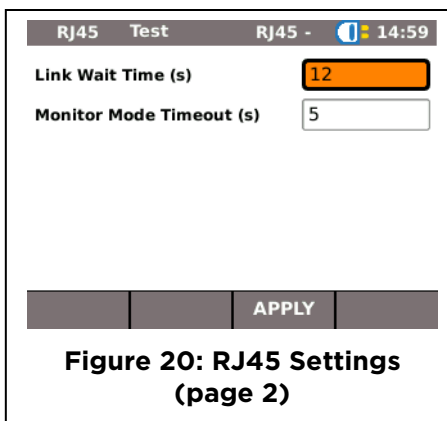
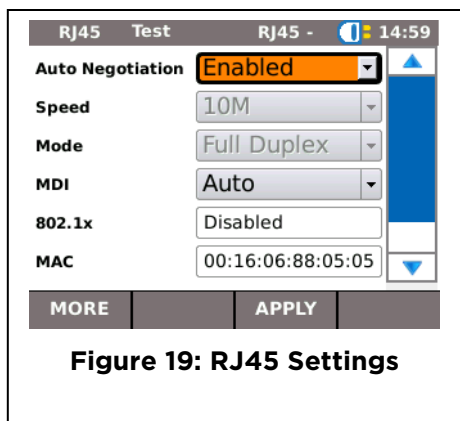

Figure 18: Resetting instrument to factory settings

3.3 RJ45

This menu allows configuration of how the RJ45 interface connects to the network.

1. Select **Setup**.
2. Select the menu point "RJ45".
3. Select **More** to display the next page.



Option	Description
<i>Auto Negotiation</i>	<i>Enabled:</i> Automatic recognition of the network speed. <i>Disabled:</i> It is necessary to set the communication rate and mode manually.
<i>Speed</i>	Setting the network speed.
<i>Mode</i>	<i>Full Duplex</i> (all pairs are used for transmitting and receiving). <i>Half Duplex</i> (pairs are used for transmitting or receiving).
<i>Min. Rx Size</i>	Smallest recognized packet size
<i>MDI</i>	Configuration of the device interface
MACError! Bookmark not defined.	Display of MAC address.
<i>Link Wait Time</i>	Set the time that the tester will wait for Ethernet link establishment before it stops searching
<i>Monitor Mode Timeout (s)</i>	Set the time that the tester will wait for both sides of the Ethernet to be established before reverting to endpoint mode

Save the entry made with **Apply**. You can exit the menu without saving the changes with **Escape**



3.4 Fiber-optic cable

The SFP details (if fitted) are indicated in this menu.

1. Select **Setup**.
2. Select the menu point "Optical".

Item	Description
Status	Indicates the availability of the SFP
Vendor	Identifies the vendor of the SFP (if supported)
Part No.	Identifies the vendor's part number of the SFP (if supported)
802.1x	Indicates if 802.1x security is enabled

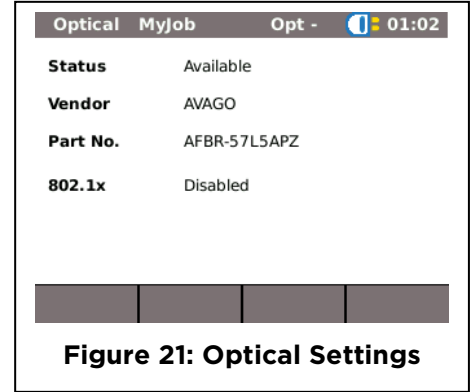

Figure 21: Optical Settings

3.5 Tests

This menu allows settings to be made for the tests.

1. Select Setup.
2. Select the menu point "Tests".

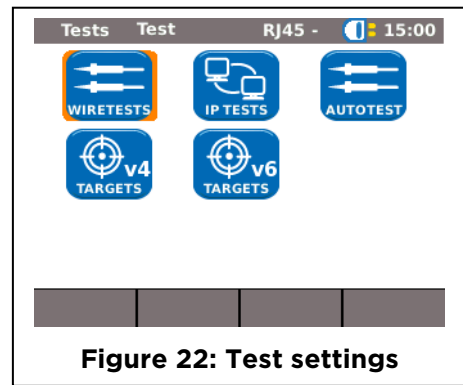

Figure 22: Test settings

3.5.1 Cable Wire Tests

This menu allows settings to be made for "wiremap" and "tone generator".

1. Select the menu point "Wiretests".

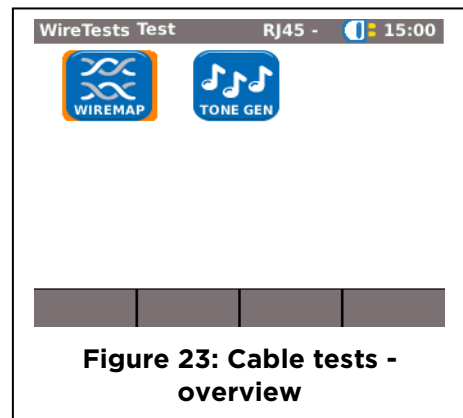

Figure 23: Cable tests - overview

Setting the wiremap

This menu allows you to set the type of wiring.

1. Select the menu point "Wiremap".

Option	Description
<i>Cable Type</i>	Selection of type of cable.
<i>Display Pref</i>	Selection of wiring schematic.
<i>Xover Allowed</i>	Permit cross-over cables.
<i>Use Custom NVP</i>	Use own NVP value. (Allows precise length measurement of the pair.)
<i>Custom NVP</i>	Entry of cable-specific NVP value (Nominal Velocity of Propagation) in percent, e.g. 79 for 79%.

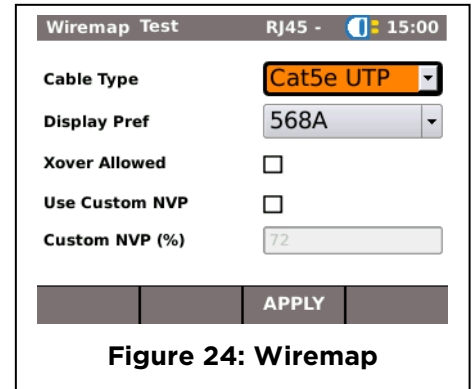

2. Select the desired option.
3. Select the desired test parameters or enter the desired information with the alphanumeric keys.
4. Save the entry made with **Apply**. You can exit the menu without saving the changes with **Escape**.

Setting the tone generator

This menu allows you to set the melody on the tone generator and the pin or pair to be found.

1. Select the menu point "ToneGen".
2. Select the option *Tone* to set the melody.
3. Set the desired option.
4. Select the option *Wire Id* to set the pin or pair to be found.
5. Set the desired option.
6. Save the entry made with **Apply**. You can exit the menu without saving the changes with **Escape**

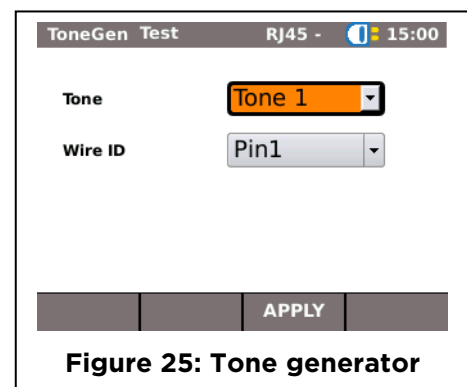



3.5.2 Autotest

The **Autotest** options can be set in this menu. You can set the tests to be performed by actuating the **Autotest** button or selecting the "Autotest" menu.

1. Select the menu point "Autotest".
2. Activate or deactivate the option by selecting. An activated option is indicated by a check mark in the box.
3. Save the entry made with **Apply**. You can exit the menu without saving the changes with **Escape**.

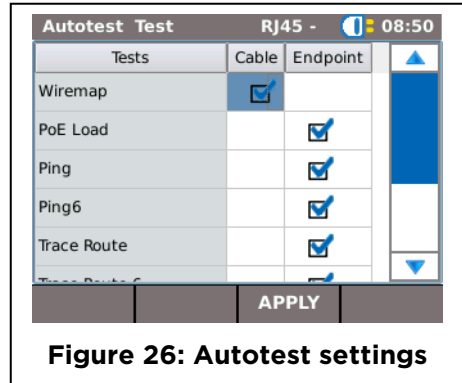

Figure 26: Autotest settings

3.5.3 IP Tests

This menu allows settings to be made for the IP test.

1. Select the menu point "IP Tests".
2. Select **More** to display the next page.

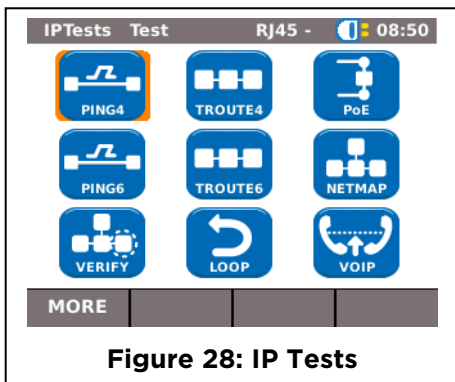

Figure 28: IP Tests

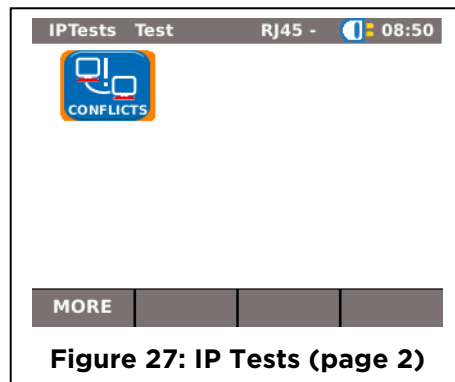

Figure 27: IP Tests (page 2)

Ping4 (Ping IPv4)

This menu allows settings to be made for the ping IPv4 test.

1. Select the menu point "Ping4".
2. Select the tick-box next to the targets to be included in the ping test.
3. Press F1 (MORE) to display the next page.

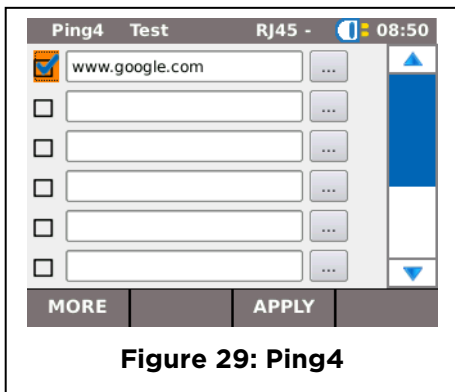

Figure 29: Ping4

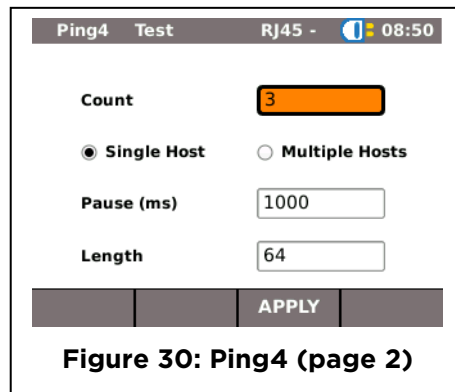

Figure 30: Ping4 (page 2)



Option	Description
<i>Count</i>	Number of pings sent.
<i>Single or Multiple hosts</i>	Select ping to a single target or to all of the selected targets
<i>Pause</i>	Period of time between sending pings in milliseconds.
<i>Length</i>	Size of ping packet sent.

1. Select the desired option.
2. Enter the desired information with the alphanumeric keys.
3. Save the entry made with **Apply**. You can exit the menu without saving the changes with **Escape**.

Ping6 (Ping IPv6)

This menu allows settings to be made for the ping IPv6 test.

1. Select the menu point "Ping6".
2. Select the tick-box next to the targets to be included in the ping test.
3. Select **More** to display the next page.

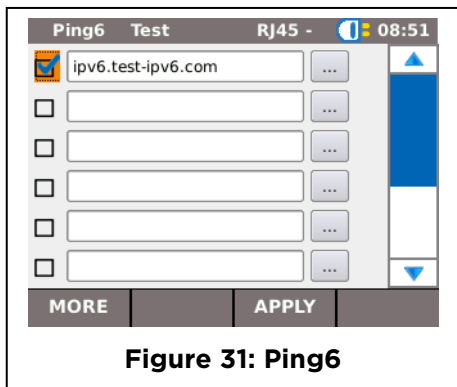

Figure 31: Ping6

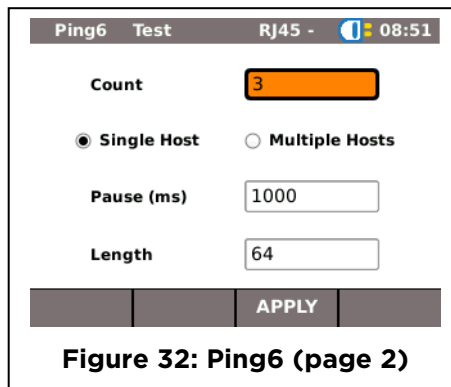

Figure 32: Ping6 (page 2)

Option	Description
<i>Count</i>	Number of pings sent.
<i>Single or Multiple hosts</i>	Select ping to a single target or to all of the selected targets
<i>Pause</i>	Period of time between sending pings in milliseconds.
<i>Length</i>	Size of ping packet sent.

1. Select the desired option.
2. Enter the desired information with the alphanumeric keys.
3. Save the entry made with **Apply**. You can exit the menu without saving the changes with **Escape**.



Netmap

This menu allows settings to be made for the netmap test.

1. Select the menu point "Netmap".
2. Select the area to be scanned by activating or deactivating the option *Local Network* or *Custom Network*. The option activated is indicated by a radio button.
3. Select the desired option.
4. Select the desired test parameters or enter the desired information with the alphanumeric keys.
5. Save the entry made with **Apply**. You can exit the menu without saving the changes with **Escape**.

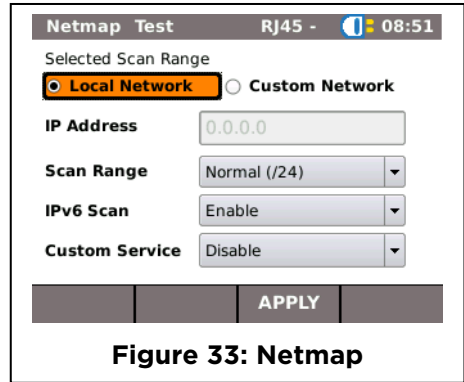

Figure 33: Netmap

Option	Description		
<i>Local Network</i>	Scan local network - automatic setting is used.		
<i>Custom Network</i>	Scan specific network area		
<i>IP Address</i>	Defines the Custom Network area to be scanned		
<i>Scan range</i>	Scan Range	Max Number of Hosts	Test time
	Normal (/24)	256	Short
	Wide (/20)	4096	Medium
<i>IPv6 Scan</i>	Include IPv6 hosts in the scan		
<i>Custom Service</i>	Scan for hosts running specific UDP / TCP services, eg SIP, on specific ports		

VoIP (Voice over IP)

This menu allows settings to be made for the quality parameter of the VoIP test. The LanXPLOER compares each call with the set quality parameters and evaluates the call.

1. Select the menu point "VoIP".

Option	Description
<i>VOIP Port 1</i>	Setting the communication port 1
<i>VOIP Port 2</i>	Setting the communication port 2
<i>Jitter (ms)</i>	Limit value for the measuring parameter Jitter
<i>Delay (ms)</i>	Limit value for the measuring parameter Delay
<i>Lost Pkts (%)</i>	Limit value for the measuring parameter of lost packets

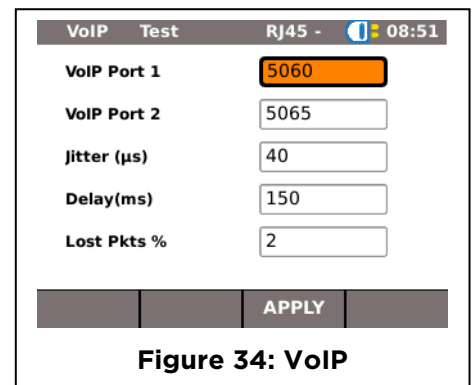

Figure 34: VoIP

2. Select the desired option.
3. Enter the desired information with the alphanumeric keys.
4. Save the entry made with **Apply**. You can exit the menu without saving the changes with **Escape**.

T-Route 4 (Trace Route IPv4)

This menu allows settings to be made for the IPv4 trace route test.

1. Select the menu point "T-Route4".

Option	Description
<i>Target</i>	Select the target address to which the ping is to be sent. Use the option ... to select the list with the target addresses you have saved.
<i>Max Hops</i>	Set the maximum number of hops to the target address.
<i>Timeout</i>	Maximum waiting time in seconds.
<i>Type</i>	Set ICMP or UDP.
<i>Name Lookup</i>	Select the tick-box to include hop names (if supported) in the results. (This will cause the test to take more time to complete.)

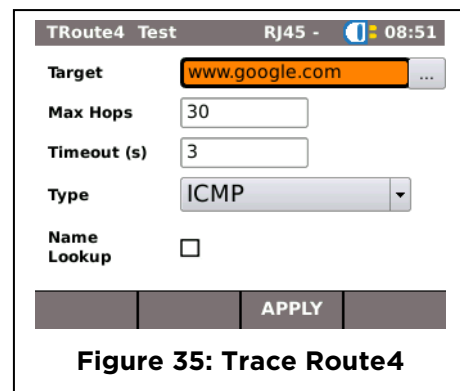

Figure 35: Trace Route4

2. Select the desired option.
3. Select the desired test parameters or enter the desired information with the alphanumeric keys.
4. Save the entry made with **Apply**. You can exit the menu without saving the changes with **Escape**.

T-Route 6 (Trace Route IPv6)

This menu allows settings to be made for the IPv6 trace route test.

1. Select the menu point "T-Route6".

Option	Description
<i>Target</i>	Select the target address to which the ping is to be sent. Use the option ... to select the list with the target addresses you have saved.
<i>Max Hops</i>	Set the maximum number of hops to the target address.
<i>Timeout</i>	Maximum waiting time in seconds.
<i>Type</i>	Set ICMP or UDP.
<i>Name Lookup</i>	Select the tick-box to include hop names (if supported) in the results. (This will cause the test to take more time to complete.)

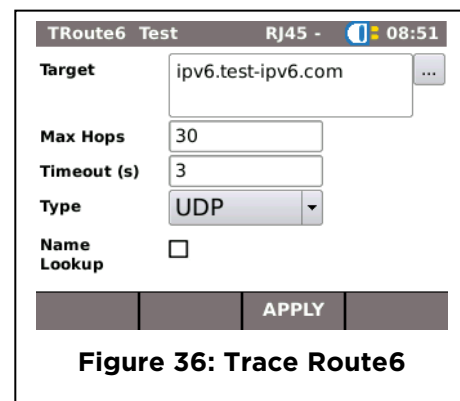

Figure 36: Trace Route6

2. Select the desired option.
3. Select the desired test parameters or enter the desired information with the alphanumeric keys.
4. Save the entry made with **Apply**. You can exit the menu without saving the changes with **Escape**.

Verify

This menu allows settings to be made for comparing new netmaps with netmaps made on previous occasions, to discover any changes that have occurred in the network.

1. Select the menu point "Verify".
2. Set the desired Comparison Map.
3. Save the entry made with **Apply**. You can exit the menu without saving the changes with **Escape**.

Loop

This menu allows settings to be made for the loop test for use together with a network transmission tester (eg UniPRO MGig1)

1. Select the menu point "Loop".
2. Set the desired option of Loopback Type and All Traffic.

Option	Description
<i>Wireline</i>	Every bit received is immediately re-transmitted to its source even if there are errors. Can only be used over a copper or optical cable, not through active network elements.
<i>MAC</i>	Errored frames are dropped. All good frames are re-transmitted back to the source by swapping the Source and Destination MAC address in the re-transmitted frame. Can be used over a cable or a switched network.
<i>IP</i>	Errored frames are dropped. All good frames are re-transmitted back to the source by swapping the Source and Destination MAC and IP addresses in the re-transmitted frame. Can be used over a cable or a switched or routed network.
<i>UDP</i>	Errored frames are dropped. All good frames are re-transmitted back to the source by swapping the Source and Destination MAC and IP addresses and the UDP port numbers in the re-transmitted frame. Can be used over all types of network.
<i>All Traffic</i>	Select the tick-box to loop all received frames whether they are addressed to the tester or not. De-select to loop only frames addressed to the tester's IP address

3. Save the entry made with **Apply**. You can exit the menu without saving the changes with **Escape**.

Conflicts

This menu allows settings to be made for the Conflicts test which detects if more than one host in a network is using the same IP address.

1. Select the menu point "Conflicts".
2. Set the desired option of Local Network (scans the address space around the tester's own IP address for conflicts), or Custom Network (scans a network defined by the settings made to Target IP and Range).
3. Save the entry made with **Apply**. You can exit the menu without saving the changes with **Escape**.

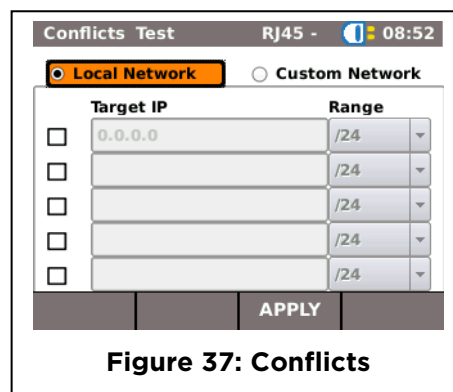



PoE

This menu allows settings to be made for the PoE test.

1. Select the menu point "PoE".
2. Select the desired option.

Option	Description
<i>Test Type</i>	PoE: Setup for standard PoE PoE +: Setup for extended PoE + Measurement
<i>Min PoE Power</i>	Threshold for minimum PoE Power
<i>Min PoE Plus Power</i>	Threshold for minimum PoE PLUS Power

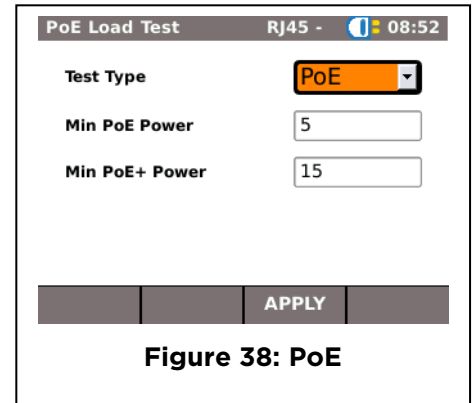

Figure 38: PoE

3. Select the desired test parameters or enter the desired information with the alphanumeric keys.
4. Save the entry made with **Apply**. You can exit the menu without saving the changes with **Escape**.

3.5.4 Targets V4 & Targets V6

This menu point allows target addresses to be entered and managed for use in the individual tests.

1. Select the menu point "Targets".

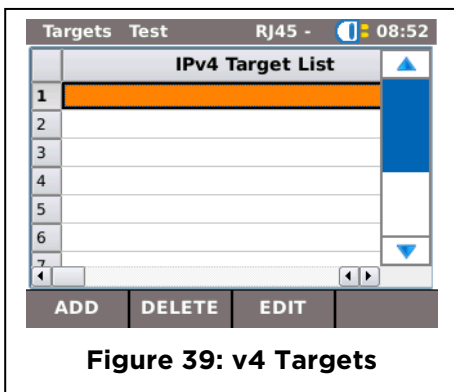

Figure 39: v4 Targets

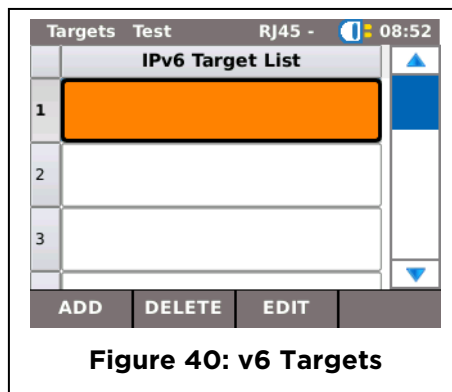

Figure 40: v6 Targets

Softkey	Description
Add	Enter a new target address.
Delete	Delete a target address.
Edit	Change a target address.

Adding a target address

1. Select **Add**.
2. Enter the target address with the alphanumeric keys.
3. Save the entry made with **OK**. You can exit the menu without saving the changes with **Cancel** or **Escape**.
4. Save the entry made with **Apply**. You can exit the menu without saving the changes with **Escape**.

Deleting a target address

1. Mark the target address to be deleted.
2. Select **Delete**.

Changing a target address

1. Mark the target address to be changed.
2. Select edit.
3. Enter the new parameter with the alphanumeric keys.
4. Save the entry made with **Apply**. You can exit the menu without saving the changes with **Escape**.

3.6 IPv4

This menu allows settings to be made for logging onto a network using IP version 4.

1. Select **Setup**.
2. Select the menu point " IPv4"
3. Select **More** to display the next page.

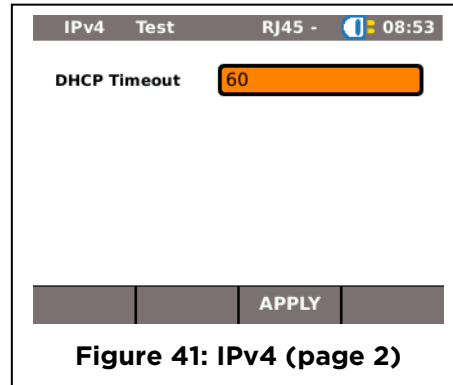
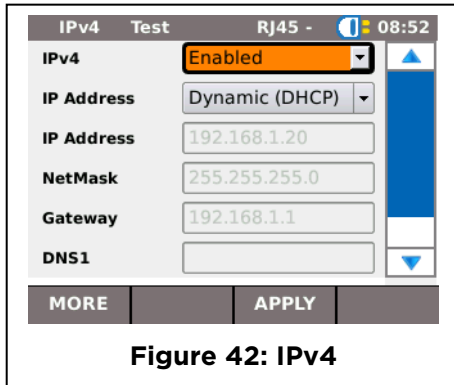

Option	Description
<i>IPv4</i>	Enable to allow the tester to support IPv4 protocol.
<i>IP Address</i>	<i>Dynamic:</i> Automatic address assignment using DHCP. <i>Static:</i> With this option it is necessary to set the network properties manually using the options below.
<i>IP Address</i>	Static IP address.
<i>NetMask</i>	Static network mask.
<i>Gateway</i>	IP address of the Gateway.
<i>DNS1</i>	IP address of Domain Name Server 1
<i>DNS2</i>	IP address of Domain Name Server 2
<i>DHCP Time out</i>	Setting of the time the tester will wait to be assigned a DHCP address before it defaults to a 169.x.x.x address.

NOTE:

When working with the Static option, request the required information on the IP address, NetMask Gateway and DNS server from your system administrator.

4. Select the option *IP Address* to set *Dynamic* or *Static*.
5. Select the desired option.
6. Enter the desired information with the alphanumeric keys.
7. Save the entry made with **Apply**. You can exit the menu without saving the changes with **Escape**.



3.7 IPv6

This menu allows settings to be made for logging onto a network using IP version 6.

1. Select **Setup**.
2. Select the menu point " IPv4"

Option	Description
<i>IPv6</i>	Enable to allow the tester to support IPv6 protocol.
<i>IP Address</i>	Stateful - IP address assigned automatically using DHCPv6 Stateless - IP address assigned automatically using ICMPv6 Static - IP address assigned manually by the operator
<i>IP Address</i>	Static IP address.
<i>Prefix</i>	Select 64 or 128 bit

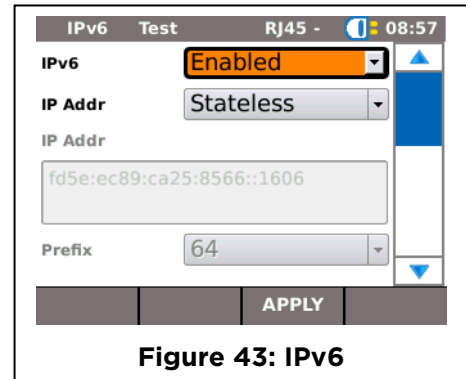

Figure 43: IPv6

3.8 VLAN

This menu allows settings to be made for testing in virtual LANs.

1. Select **Setup**.
2. Select the menu point "VLAN".

Image	Description
<i>VLAN</i>	<i>Disabled</i> : Deactivate virtual network recognition. <i>Enabled</i> : Activate virtual network recognition.
<i>VLAN ID</i>	Manual entry of virtual LAN ID
<i>VLAN PRIORITY</i>	Manual entry of the VLAM Priority from 0 to 7

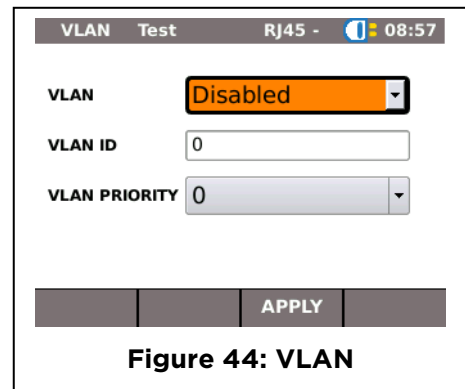

Figure 44: VLAN

3. Select the option VLAN to set virtual LAN recognition.
4. Select the option VLAN ID and enter the desired information with the alphanumeric keys.
5. Save the entry made with **Apply**. You can exit the menu without saving the changes with **Escape**.



3.9 Wi-Fi

Wi-Fi networks can be created and managed with this menu.

1. Select the menu point "Wi-Fi" to obtain a list of all Wi-Fi networks created on your LanXPLOER.

3.9.1 Connect / disconnect with an existing Wi-Fi network

2. Select a Wi-Fi network from the list that you want to use to connect the instrument.
3. Select in order to connect the instrument with the Wi-Fi network.
4. Select in order to disconnect the Wi-Fi network.

3.9.2 Creating a new Wi-Fi network

5. Select .
6. Select the menu point "New".
7. Select the desired option.
8. Select the desired test parameters or enter the desired information with the alphanumeric keys.
9. Save the entry made with . You can exit the menu without saving the changes with **Escape**.

3.9.3 Changing a Wi-Fi network already present

10. Select a Wi-Fi network from the list that you want to process.
11. Select .
12. Select the menu point "Edit".
13. Select the desired option.
14. Select the desired test parameters or enter the desired information with the alphanumeric keys.
15. Save the entry made with . You can exit the menu without saving the changes with **Escape**.

3.9.4 Deleting a Wi-Fi network already present

16. Select a Wi-Fi network from the list that you want to delete.
17. Select .
18. Select the menu point "Delete".

3.10 802.1x

To test networks that use 802.1x security, the tester must be set up as follows:

Import client certificates and root certificates as follows:

- On your PC, create a directory, name it 'certs' and copy the required client and root certificates to that directory.

Note

- Root certificates must be of the file type .pem. Client certificates must be of the file type .p12.

-
- Copy the directory to a USB key and insert it into the USB port.
 - From the home screen press the soft key SETUP (F3).
 - Select the icon 802.1x. The 802.1x setup screen is displayed.
 - Press soft key CERTS (F1) to load the certificates. The loaded certificates will remain until further certificates are loaded or a factory reset is performed.

When entering the 802.1x setup details, scroll to each field, press Enter and select from the drop down menu or look up table as required. Press enter again to return to the 802.1x setup screen. RESET clears all certificate data from the setup screen.

Username and Password fields will display the QWERTY keyboard. When you have entered the Username/Password, press OK to return to the 802.1x setup screen.

The tester's time and date must be correct before 802.1x will work.

- Set the '802.1x' field to Enable.
- Select the required EAP Method from the drop down menu in the 'EAP Method' field. See Notes 1 to 4 below.
- Scroll to the 'Certificate' field and select the required certificate from the look up table.
- Enter a username and password (when required).
- Scroll to the 'Root Cert' field and select the required certificate from the look up table (when required).
- Press the soft key APPLY (F2). You can now connect through the 802.1x port.

Notes

1. Completing the fields 'Client Certificate' and 'Certificate Password' is required only when the EAP Method is: EAP-TLS, Any or, the Tunneled Method is TLS.
2. The Tunneled Method and Root Certificate options are enabled only when the EAP Method is EAP-TLS, EAP-PEAP, EAP-TTLS or Any.
3. Use the Root Certificate option only when you want to authenticate the server (RADIUS server).
4. When the EAP Method is EAP-TLS and the Tunneled Method is TLS, the fields Username and Password are optional. For all other types of EAP Method a Username and Password must be entered.

Chapter 4. Test Summary

This short chapter gives an overview of the tests which can be run with with your LanXPLOER model in the different connection versions.

Test setup	Passive wiring	Active wiring	Inline	Fiber-optic cable	Wi-Fi
Test					
Autotest	✓	✓	✓	✓	✓
Wiremap	✓				
ToneGen	✓				
IPv4 & IPv6		✓	✓	✓	
Mac		✓	✓	✓	
Link		✓	✓	✓	
Ping		✓		✓	✓
Netmap		✓		✓	✓
VoIP			✓		
Trace Route 4 & Trace Route 6		✓		✓	✓
Network Verify		✓		✓	✓
Loop		✓		✓	
PC Diagnosis			✓		
PoE Load		✓	✓		
Top Ten		✓	✓	✓	
Blink		✓		✓	
Virtual Lan			✓	✓	✓
Wi-Fi Scan					✓

Chapter 5. Test Setup

The following sections explain the typical test setup for the individual tests with the LanXPLOER.

1. Confirm with the ON button to start the LanXPLOER.
2. Connect the LanXPLOER, if necessary.
3. Select the port to be tested.
4. Select **Detect** or **Scan** to start recognition.

NOTE:

The LanXPLOER automatically checks whether power is present on connected cables. If power is recognized, it is indicated by the LanXPLOER. This automatically prevents damage to the tester. In this case it is not possible to run a test. Disconnect the power source from the tester immediately.

5.1 Ports

This menu allows you to determine whether a fiber-optic cable, a copper line or a wireless network is to be tested.

1. Select the menu "Ports".
2. Select the desired option.

Option	Description
<i>Optical</i>	Fiber-optic cable
<i>RJ45</i>	Copper cable
<i>Wi-Fi</i>	Wireless network (WLAN)

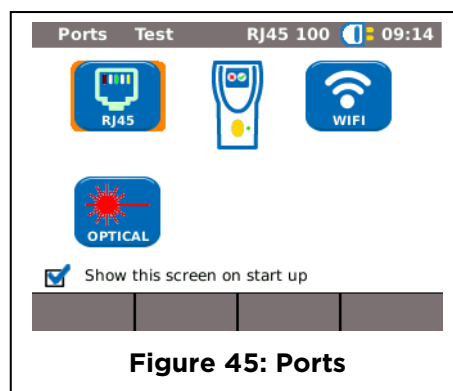

Figure 45: Ports

5.2 Passive Wiring

This function allows all cables not under power to be tested. If it is not possible to connect cables directly to the interfaces present on the LanXPLOER, the cable can be connected to the LanXPLOER using an adapter.

5.2.1 Testing a passive link without Active Remote

When testing a passive link, the instrument tests the connected cable for:

- Length;
 - Short-circuit
1. Select the menu "Ports" "RJ45".
 2. Disconnect the cable link to be tested from all network components.
 3. Connect cable path earth to the RJ45 network port on the LanXPLOER.
 4. Select **Run** to start recognition of the cable path.



5.2.2 Testing a passive link with Active Remote

When testing a passive link with Active Remote, the instrument tests the connected cable for:

- Length;
- Short-circuit;
- Pin mixup, split pair;
- Open / broken conductors;
- Error location.

Item	Description
1	Active Remote
2	Wall Outlet
3	Patch Panel
4	LanXPLOER

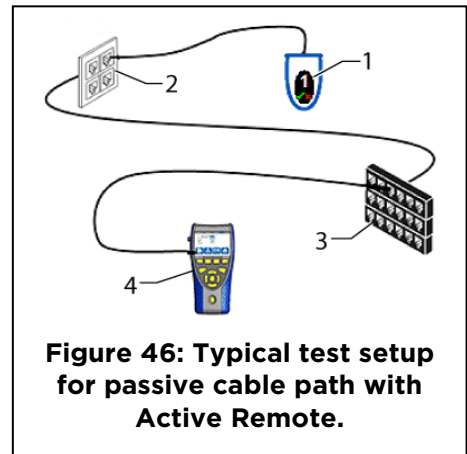

1. Select the menu "Ports" "RJ45".
2. Disconnect the cable link to be tested from all network components.
3. Connect cable path earth to the RJ45 network port on the LanXPLOER.
4. Connect a remote / active Remote to the other end of the cable path.
5. Select **Run** to start recognition of the cable path.



5.3 Active wiring

This function allows all Ethernet-compatible devices to be tested.

1. Select the menu "Ports" "RJ45".
2. Connect a network cable to the Ethernet-compatible device to be tested.
3. Connect the free end of the cable path to the RJ45 network port on the LanXPLOER.
4. Select **Detect** to start recognition of the Ethernet-compatible device.

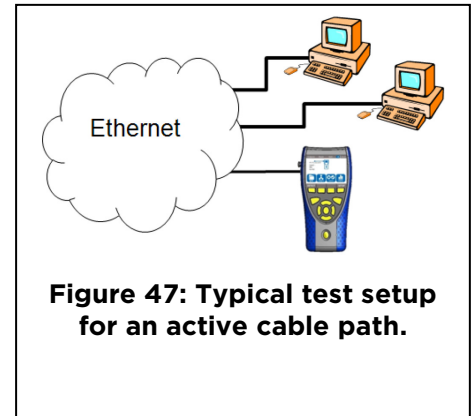

Figure 47: Typical test setup for an active cable path.

Item	Description
1	Line Rate and Duplex status (FD - Full Duplex, HD - Half Duplex)
2	Port number of connected switch
3	Auto Negotiation On/Off
4	Recognition of power over Ethernet. <i>PoE</i> - PoE present. <i>No-PoE</i> - PoE not present.
5	IPv4 address
6	IPv6 address

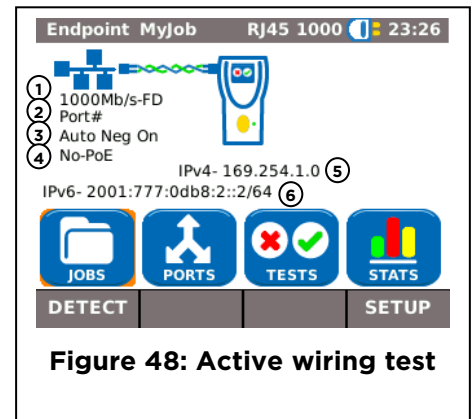

Figure 48: Active wiring test

5.4 Inline Test

Connect the LanXPLOER between an Ethernet-compatible device and the network for the inline test. During this test the LanXPLOER measures the traffic between the connected device and the network. If PoE is present, PoE-specific parameters can also be measured.

1. Select the menu "Ports" "RJ45".
2. Connect a network cable to the Ethernet-compatible device to be tested.
3. Connect the free end of the cable path to the RJ45 network port on the LanXPLOER.
4. Connect a network cable to the network.
5. Connect the free end of the cable path to the RJ45 diagnostic port on the LanXPLOER.
6. Select **Detect** to start recognition of the Ethernet-compatible device.

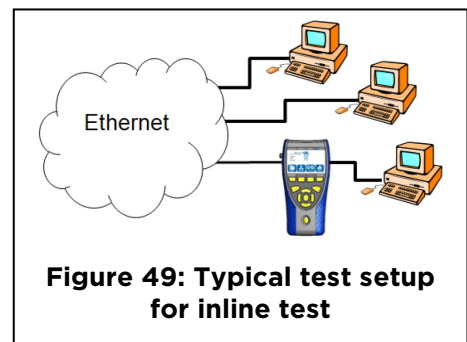

Figure 49: Typical test setup for inline test



Item	Description
1	Network connection status
2	Connection status of connected Ethernet device.

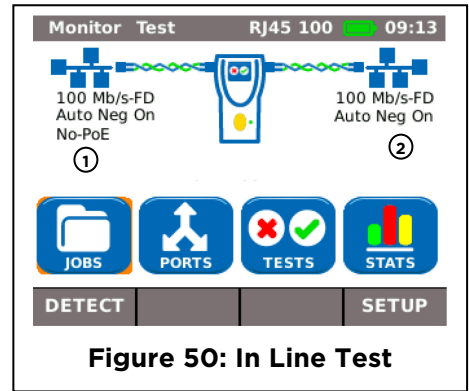

Figure 50: In Line Test

5.5 Fiber-optic cable

This function allows all Ethernet-compatible devices to be tested in the end point mode.

NOTE:

This test function can be used only at an Ethernet transfer rate of 1000 Mbit/s.

1. Plug in an SFP of the desired wavelength
2. Select the menu "Ports" "Optical".
3. Connect a fiber-optic cable to the Ethernet-compatible device to be tested.
4. Connect the free end of the cable path to the SFP plugged in the LanXPLORER.
5. Select **Detect** to start recognition of the Ethernet-compatible device.

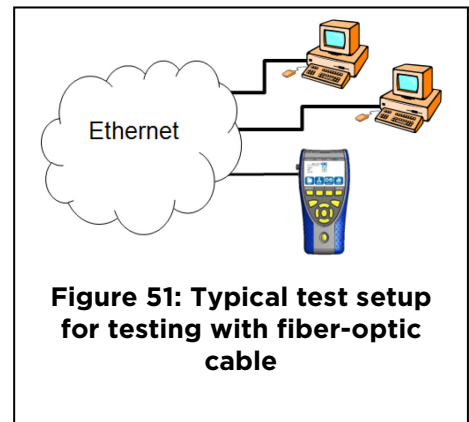

Figure 51: Typical test setup for testing with fiber-optic cable

Item	Description
1	Transfer rate of connected device and Rx optical power.
2	IP address of connected device.

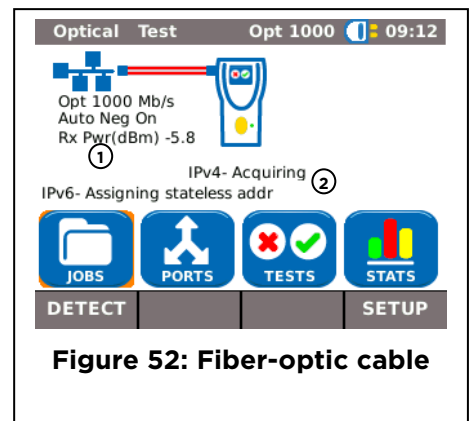



Figure 52: Fiber-optic cable



5.6 Wi-Fi

With this test the LanXPLOER can be connected with all access points and test wireless networks within reception range. To increase the reception range, plug the supplied high sensitivity antenna into the USB port before following the procedure below. An overview the tests available is given in Chapter 4.

1. Select the menu "Ports" "Wi-Fi".
2. Select **Scan** to start recognition of the network.

Image	Description
<i>SSID</i>	SSID of access point.
<i>CH</i>	Channel
	Security protocol

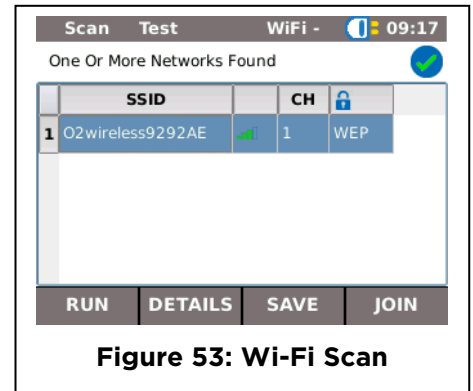

Figure 53: Wi-Fi Scan

3. Select **Run** to start recognition of the network again.
4. Select **Details** to view further information on individual networks.

Chapter 6. Test description and procedure



The availability of individual tests depends on test setup of the LanXPLOER. An overview of the tests available is given in Chapter 4.

6.1 Test summary

This menu shows all tests possible with the current tests. In addition it shows which tests have already been performed and the associated pass/fail results.

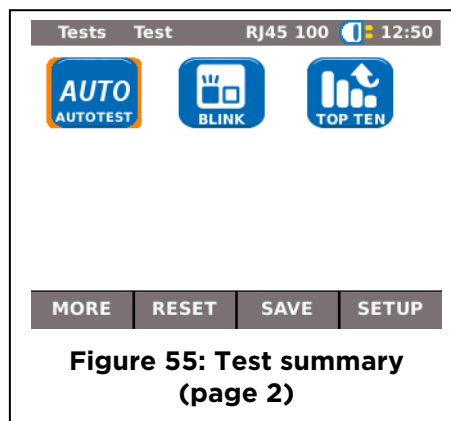
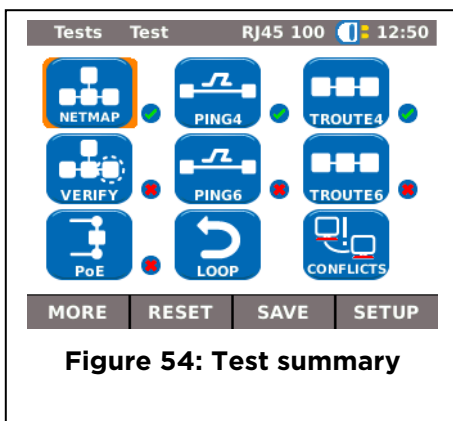
1. Connect the LanXPLOER in the desired manner.
2. Select the menu point "Tests" on the standby screen.
3. Select **More** to display the next page.



Symbol	Overall test results
	Test not performed.
	Test performed and evaluated as passed.
	Test performed and evaluated as failed.

6.1.1 Performing individual tests

1. Select the desired individual test.
2. Perform the test.

The result is stored in the short-term memory and displayed in the test summary.

6.1.2 Resetting test results

1. Select **reset** in order to reset marked individual tests that are shown in the test summary.

All test results of the marked individual tests are deleted from the short-term memory.

6.1.3 Saving test results

1. Select **Save** to store all test results in the current job.

All test results are stored in the current job and can be managed there.

6.2 Autotest

The autotest feature allows the installation to be checked quickly and easily. After pressing the **AUTOTEST** button, the LanXPLOER automatically runs the individual tests set.



Selection of the individual tests in the test series depends on the instrument settings and the type of wiring to be tested.

6.2.1 Run Autotest

1. Connect the LanXPLOER in the desired manner.
2. Set the Autotest options.
3. Select **Run** to start the Autotest.

6.2.2 Overall pass/fail result

After conclusion of the test series, the LanXPLOER displays an overall pass/fail result as well as the individual pass/fail results.

Symbol	Overall Autotest results
	The Autotest is evaluated as passed all total, when all individual tests are passed.
	The Autotest is evaluated as failed all total, when at least one individual test was failed.

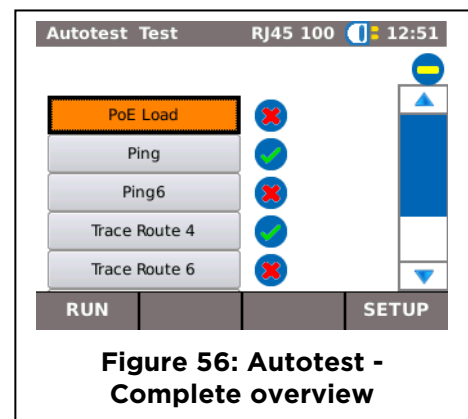

Figure 56: Autotest - Complete overview

You can view the results of the individual tests, save the results or make Autotest settings.

6.2.3 Display of individual test results

1. Select the desired individual test.
2. Select **More** to view additional details on the specific test results.
3. Press **Escape** to return to the previous screen.

6.3 Wiremap test

Short circuits, discontinuities and erroneous circuits can be located with the aid of the wiremap test. The test results are displayed in the form of a graph to facilitate evaluation.

Any faults indicated in the wiremap test should be remedied before performing further tests, because this would result in errors in the other tests.

The wiremap test guarantees the following minimum thresholds for error recognition (based on four conductor pairs, optional shielding):

- All wiring errors or combined wiring errors are indicated in the wiremap as faults.
- Combinations of up to three interruptions, short-circuits or reversed connections are recognized correctly.
- In the case of discontinuities or short-circuits, the end of the cable, at which the fault occurred, is specified (on Autotest screen for length measurement).
- Split pairs are recognized on the basis of specific patterns of contradictory NEXT values (near-end crosstalk).





6.3.1 Performing Wiremap test

1. Disconnect the cable path to be tested from all network components.
2. Connect the LanXPLOER to one end of the cable path.
3. Connect an Active Remote to the other end of the cable path.
4. Select the menu point "Tests" on the standby screen.
5. Select the menu point "Wiremap".
6. Select **Run** to start the Wiremap test.

6.3.2 Display results

DISPLAYS ON THE ACTIVE REMOTE

A flashing LED on the Active Remote indicates the test status:

	LED display	Description
	Red, slowly	The end is near has been detected - Test not performed.
	Fast red:	Fault
	Green, fast	The end is near has been detected - Cable path is okay
	Orange	Incorrect voltage

WIREMAP

Item	Description
1	Type of cable set
2	Display Preference of comparison standard
3	Wiremap results
4	LanXPLOER
5	Length of pairs
6	Lines
7	Total length
8	Active Remote (indicated by LED display).

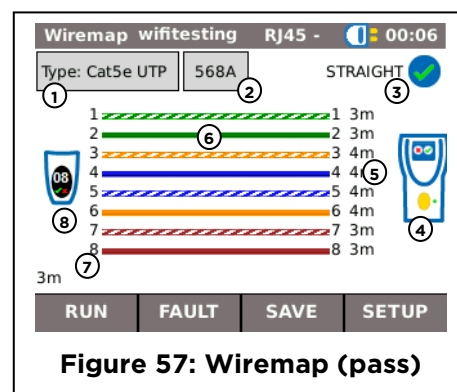

EXAMPLES OF ERRORS

Pairs or pins with errors are shown in red.

Item	Description
1	Short-circuit
2	Discontinuities
3	Line crossed

1. Select **Fault** to view detailed test results.

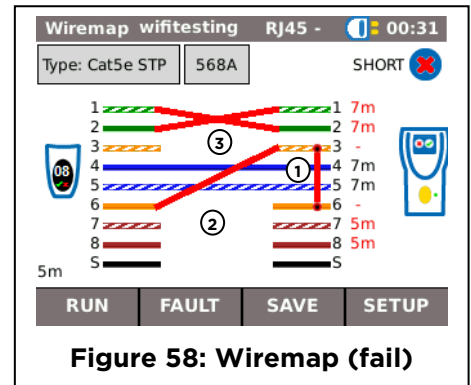

6.4 Testing a passive route without Active Remote

The LanXPLOER can generate a low and a high tone and a warbling tone which alternates between the low and high tone at a rate of 2 Hz and can be recognized by the majority of common line testers (e.g. IDEAL No. 62-164 Tone Probe).

Item	Description
1	LanXPLOER
2	Patch Cord
3	Wall Outlet
4	Patch Panel
5	Inductive receiver (tone probe)

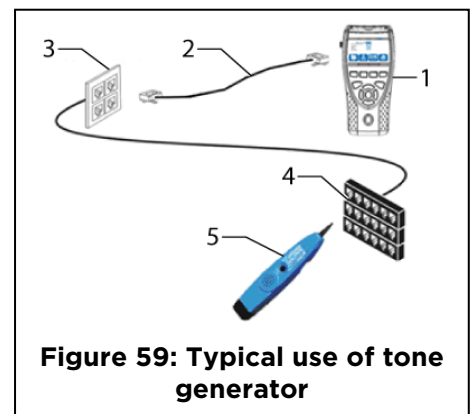

PERFORMING TEST

1. Connect the free end of the cable path to the RJ45 network port on the LanXPLOER.
2. Select the menu point "Tests" on the standby screen.
3. Select the menu point "ToneGen".
4. Find the open end of the cable path with an inductive receiver (tone probe) along the cable connected to the LanXPLOER.

6.5 Netmap

This test searches a network for hosts. The LanXPLOER uses the test results to complete an overview of all servers and printers present in the connected network. It also output the total number of all devices found. A maximum of 511 hosts can be detected and displayed.

6.5.1 Performing test

1. Select the menu point "Tests" on the standby screen.
2. Select the menu point "Netmap".
3. Select **Run** to start the test.

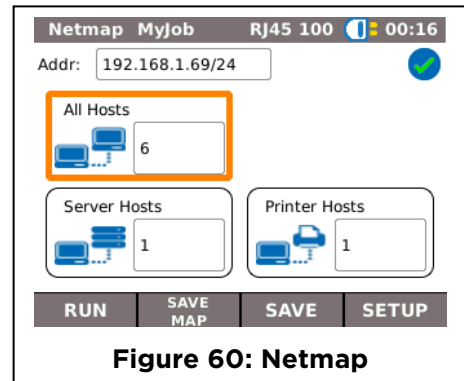

Figure 60: Netmap

6.5.2 Saving Netmap for comparisons - Verify

The device list can be saved in the instrument and used for comparison with new tests.

1. Select **Save Map** to store the current Netmap.
2. Select the currently saved Netmap.
3. Select **Rename** to edit information.
4. Enter the desired information with the alphanumeric keys.
5. Save the entry made with OK. You can exit the menu without saving the changes with **Cancel** or **Escape**.

6.5.3 Display results

It is possible to view the test details on the individual hosts.

- IP address
- MAC address
- Services
- Station name

1. Select the desired option to display a host overview.
2. Mark and ENTER the host for which you want to view more details.
3. Select the **Details**.

6.6 Verify

This test allows a Netmap already saved to be compared with the current Netmap.

6.6.1 Performing test

5. Select **Setup** to select the Netmap already saved for comparison.
6. Select the file to be compared and confirm your selection with **Apply**.

NOTE:

The name of the file selected for comparison then appears in the menu window at the top right.

7. Select **Run** to start the comparison test.

The LanXPLOER then displays a comparison list for the current Netmap and the saved Netmap.

Image	Description
<i>same</i>	The same host was recognized in the comparison file and the current Netmap.
<i>diff</i>	The host is new in the current Netmap or the host is not present in the current Netmap

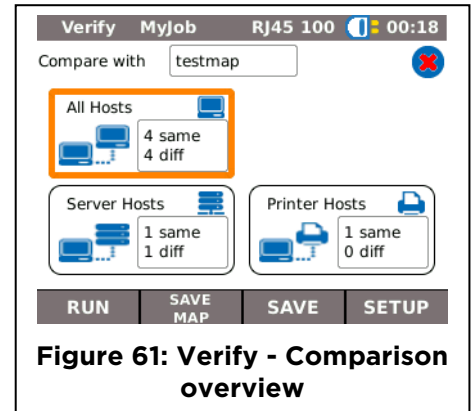



6.6.2 Saving Netmap for comparisons - Verify

The current device list can be saved in the instrument and used for comparison with new tests (see 6.5.2).

6.6.3 Display results

SHOW COMPARISON LIST

It is possible to view the test details on the comparison test.

-  Changed Hosts
-  New Hosts
-  Missing Hosts

Select the desired option to display a host overview.

VIEW TEST DETAILS

It is possible to view the test details on the individual hosts.

- IP address;
- MAC address;
- Services;
- Station name.
 1. Select the desired option to display a host overview.
 2. Mark and ENTER the host for which you want to view more details.
 3. Select the **Details**.

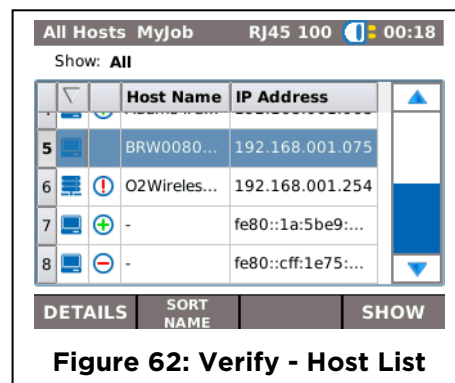



6.7 PING4 & PING6

This test checks whether a host is accessible via the network and how long the host requires to reply under IPv4

For this purpose the LanXPLOER sends a preset number of pings to multiple target addresses and waits for the replies from the hosts.

6.7.1 Performing test

1. Select the menu point "Ping".
2. Select **Setup** to define the test parameters.
3. Save the entry made with **Apply**. You can exit the menu without saving the changes with **Escape**.
4. Select **Run** to start the test.

6.7.2 Display results

All of the targets marked for testing are displayed, with the test result for each target and the overall test result.

Select a target and press **Enter** to display the detailed result for the target.

Image	Description
<i>Target</i>	Target address
<i>Info</i>	In Progress - test running Passed - Test passed Unknown host - address not found
<i>Tx Count</i>	Pings sent / total number of pings
<i>Rx Count</i>	Pings received
<i>Delay</i>	Time between sending and receiving pings

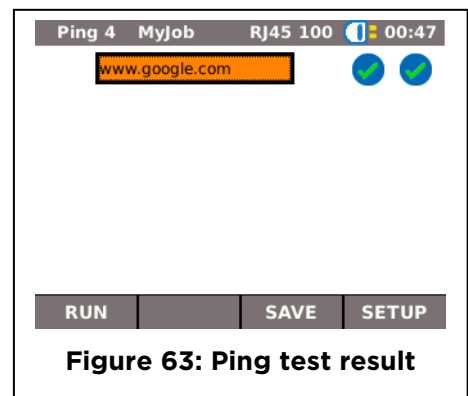

Figure 63: Ping test result

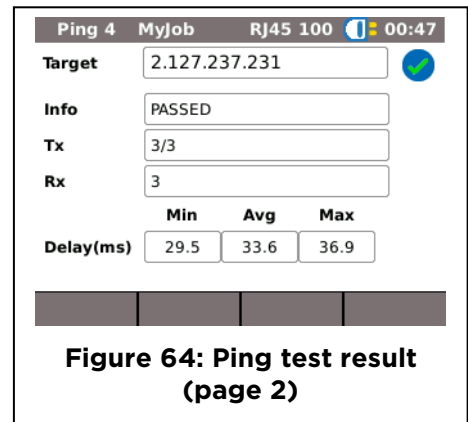

Figure 64: Ping test result (page 2)

6.8 Voice over IP (VoIP)

This test allows transfer parameters of VoIP devices to be measured.





For this purpose the LanXPLOER is switched between the VoIP device and the network in the inline mode and detects incoming calls automatically. From the start of the test, the LanXPLOER writes call sequentially and compares these with the set quality parameters.

6.8.1 Performing test

1. Select the menu point "VoIP".
2. Select Setup to define the ports to be used for VoIP and the acceptable limits of Jitter, Delay and Lost packets to be achieved for the test result to be Pass.:
3. Select **Start** to start the test.

The LanXPLOER now writes the calls sequentially and shows the last 20 calls that have been recorded.

6.8.2 Display results

Image	Description
<i>Call</i>	 The call is evaluated as passed.  The call is evaluated as fault.
<i>No.</i>	Consecutive number
<i>Start</i>	Call begin
<i>to</i>	Call end
<i>Length</i>	Call period
<i>QOS</i>	Service quality  Call corresponds with the quality parameters  Call does not correspond with the quality parameters  The call had not been accepted.

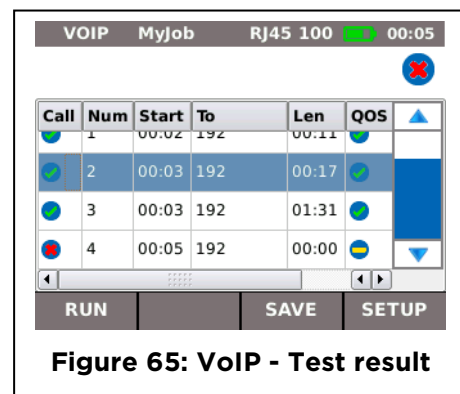

Figure 65: VoIP - Test result

HAVE THE TEST DETAILS FOR VOIP-TRACE DISPLAYED

1. Select the desired call.
2. The VoIP-Trace is displayed by selecting Trace.
3. Press **Escape** to return to the previous screen.

HAVE THE TEST DETAILS FOR THE SERVICE QUALITY DISPLAYED

1. Select the desired call.
2. Further test details are displayed by selecting QOS
3. Press **Escape** to return to the previous screen.

Image	Description
<i>Jit</i>	Jitter - Call distortion in ms
<i>Dly</i>	Delay - Call delay in ms

6.9 Trace Route

This test allows display of all hops up to arrival at the target address.

6.9.1 Performing test

1. Select the menu point "T-route".
2. Select **Setup** to define the test parameters.
3. Save the entry made with **Apply**. You can exit the menu without saving the changes with **Escape**.
4. Select **Run** to start the test.

6.9.2 Display results

All of the hops passed on the route to the destination are listed, together with the time taken for each hop.

Image	Description
<i>Target</i>	IP target address
<i>Info</i>	Passed - Test passed. Failed - Test failed.
<i>Hop</i>	IP address of hop skipped.
<i>Tx ms</i>	Time required to reach next hop in milliseconds.

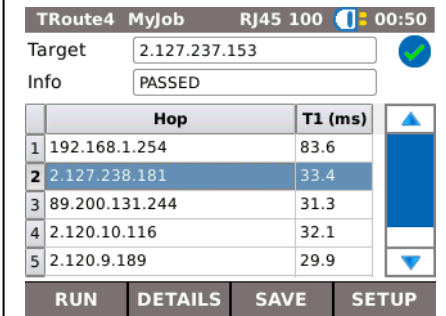

Hop	IP Address	T1 (ms)
1	192.168.1.254	83.6
2	2.127.238.181	33.4
3	89.200.131.244	31.3
4	2.120.10.116	32.1
5	2.120.9.189	29.9

Figure 66: Trace Route - Test result

Select an individual hop and press **Enter** to display the detailed results for the hop.

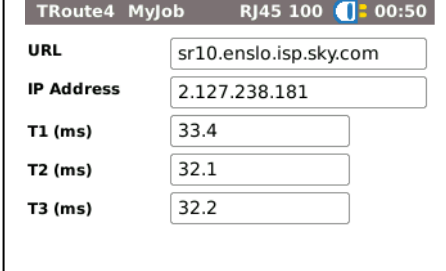

Figure 67: Trace Route - Hop details

6.10 Blink

This test allows display of the Ethernet port to which the test cable is connected.

6.10.1 Performing test

1. Select the menu point "Blink".
2. Select **Run** to start the test.

The tester activates / deactivates the Ethernet link and cycles through the advertised rates. On the Ethernet device the corresponding connection point then blinks intermittently and (if supported) changes colour depending on the connected rate..

3. Select **Stop** to terminate the test.

NOTE:

Speed and colour of the blinking LED changes periodically and is dependent on the switch type.

6.11 Power over Ethernet (PoE)

6.11.1 Performing test

1. Select the menu point "PoE".
2. Select **Setup** to define the test parameters.
3. Save the entry made with **Apply**. You can exit the menu without saving the changes with **Escape**.
4. Select **Run** to start the test.

The LanXPLOER then performs the following steps:

- Measurement of incoming voltage;
- Measurement of incoming current;
- Calculation of resulting power;
- Comparison of test results with standard values.

6.11.2 Display results

Image	Description
<i>Status</i>	Passed - PoE recognized Failed - PoE not recognized
<i>Test Type</i>	Type of test on PoE or PoE+
<i>Pair</i>	Pair used for PoE
<i>Voltage</i>	Voltage
<i>Current</i>	Current
<i>Power</i>	Power

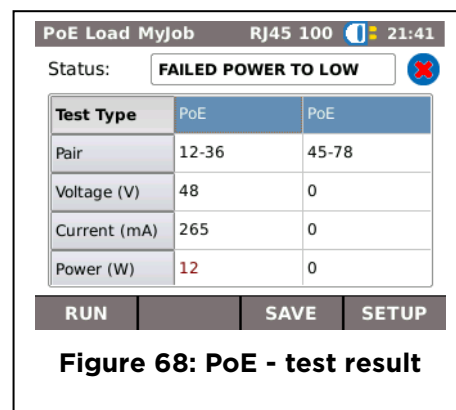

6.12 Loop

This test allows measurement of the network transfer rate. In this test the LanXPLOER serves as a reply box for a measuring instrument with active layer (up to stage 4) (e.g. Trend Unipro or Trend Multipro).

The LanXPLOER can be set to one of the following types of loops, preset in the instrument:

- Wireline
- Mac
- IP
- UDP

6.12.1 Performing test

1. Select **Setup**.
2. Set the type of loop specified by the measuring instrument with active layer.
3. Save the entry made with **Apply**. You can exit the menu without saving the changes with **Escape**.
4. Select **Run** to start the test.

6.13 PC Diagnosis

With this test the LanXPLOER can provide information on the MAC and IP level of the connected PC. Moreover information is output on data transfer (traffic).

1. Select the menu point "PC Diag".
2. The traffic is automatically analyzed.

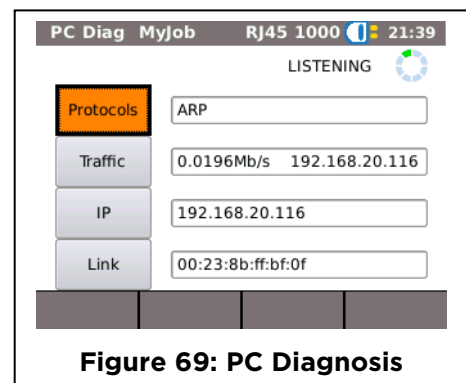



6.14 Statistics

The availability of individual statistics depends on the model version and test setup of the LanXPLOER.

Statistics are kept automatically on active networks and saved together with the tests performed.

1. Select the menu point "Stats" on the standby screen.
2. Select the desired statistics to be displayed:
 - Port 1 - Traffic passing the left hand port is displayed in **Blue**
 - Port 2 - Traffic passing the right hand port is displayed in **Red**
 - Port 1 & 2 - Traffic is shown for both ports.
3. Press **Scale** to adjust the horizontal axis of the graph

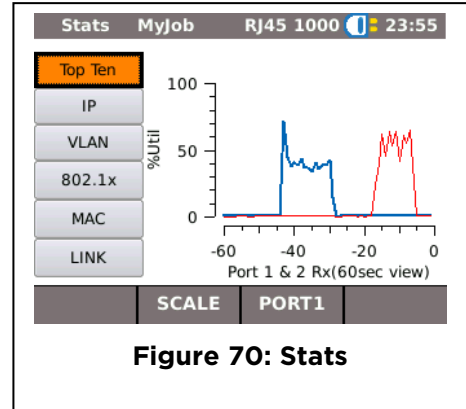

Figure 70: Stats

The LanXPLOER can keep the following statistics on active networks.

Image	Description
<i>Top Ten</i>	Display of 10 largest wideband users, error sources and protocols.
<i>IP</i>	Display of device IP login configuration.
<i>VLAN</i>	Display of recognized, active virtual networks presently in use.
<i>MAC</i>	Displays the package statistics in layer 2: <u>More</u> : further package statistics <u>Size</u> : Distribution size of the package
<i>LINK</i>	Display of link information: <u>Port</u> : Detailed information for configuring the port <u>Fault</u> : Detailed fault counter on layer 1 <u>Partner</u> : Possible connecting speeds
<i>802.1x</i>	802.1x Status data listed is: Auth Not Started, Auth Started, Auth Completed Successfully, Auth Failed. Port Status data listed is: Unauthorized, Authorized. Also shown are: EAP Method Used and Key Management Used.



6.15 Wi-Fi

With this test the LanXPLOER can test wireless networks within reception range. An overview the tests available is given in Chapter 4.

1. Select the menu "Ports" "Wi-Fi".
2. Select **Scan** to start recognition of the networks.

6.15.1 Connecting to a network

3. Select a network with which you want make a connection.
4. Select **Join** in order to connect with the network selected.
5. Confirm the screen message with **OK** if you want to configure the network.

The device detects and sets the coding type automatically.

6. Select the menu point *Code*.
7. Enter the network code with the alphanumeric keys.
8. Save the entry made with **OK**. You can exit the menu without saving the changes with **Cancel** or **Escape**.
9. Save the entry made with **Apply**. You can exit the menu without saving the changes with **Escape**.
10. In the option *Code type*, set ASCII or HEX.

NOTE:

The information required for setting the network has to be requested from your system administrator.

If a Default Access Point has been saved in the LanXPLOER, when activated, the device connects to the Wi-Fi function automatically using this Access Point.

11. Select **Apply** in order to take over the settings.
12. Select **Join** in order to connect with the network.
13. Confirm the screen message with OK.

The SSID of the network with which you are connected will be displayed in bold and underlined.

14. Select **Save** to store all test results in the current job.
15. Select **Details** to view further information on individual networks.

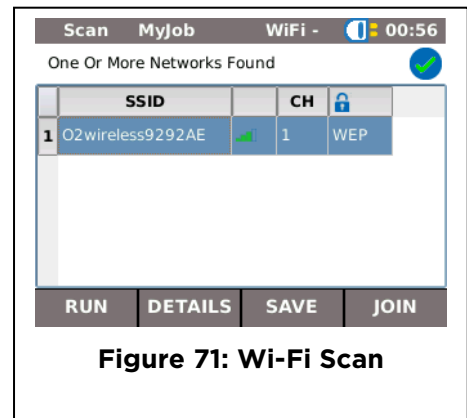

Figure 71: Wi-Fi Scan



6.15.2 Performing tests

The name of the IP address and of the network is shown on the standby screen with which the device has been connected.

1. Select the menu point "Tests" on the standby screen.
2. Select the desired individual test. All of the tests are the same as those available through the RJ-45 or Optical ports, with the addition of the Scan function used to search for available Wi-Fi networks.
3. Perform the test.

The result is stored in the short-term memory and displayed in the test summary.

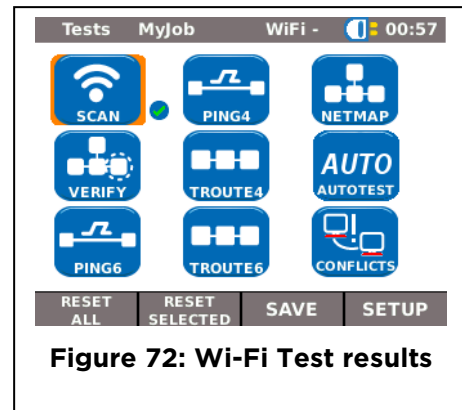

Chapter 7. Wiring test on fiber-optic conductors and SFP modules

7.1 Safety precautions



ATTENTION!

Never look directly into the socket of the SFP module, at connector surfaces, open fiber ends or into connectors. The danger exists that light in the non-visible spectrum could be emitted and permanently damage your eyes.

If you are not sure whether the device is switched on or if the fiber is conducting light, always be on the safe side and assume that light could be emitted.

Treat open fibers properly; fiber splinters can pose an injury hazard.

Protect your eyes when working on open fibers; fiber splinters can cause permanent eye damage.

Never leave fiber remnants lying around open and never dispose of such remnants loose with domestic wastes; the fiber splinters pose an injury hazard.

Before cleaning SFP modules, we recommend removing them from the instrument. This ensures that light cannot be admitted inadvertently during the cleaning process.



CAUTION!

Observe the maximum measuring range when connecting SFP modules to a light conducting link (see specifications for individual SFP modules). Exceeding this distance can lead to damage to the SFP modules.

7.2 Instructions for cleaning SFP modules and patch cables

NOTE:

Before connecting the measuring cables to the SFP modules, ensure that the connectors on the measuring cables are clean.

Clean the ferrule on the SFP sockets with dry, lint-free, non-scratching materials.

The connectors can be cleaned with suitable fiber-glass cleaning cloths or cleaning swabs. IDEAL recommends cleaning set #1219-00-1621 for care of the SFP modules and patch cables.

Chapter 8. Reports

1. Reports can be generated and exported to a USB key.

To generate a report to USB:

- Insert a USB key into the LanXPLOER USB port (size≤16GB).
- From the home screen select the JOBS icon. The display will show the Job List screen.
- Scroll down to select the required Job
- To generate a report for a single result, press ENTER to display the Results list, select the required result, press ENTER, then TO USB (F3).
- To generate a report for a single Job select the required Job then press TO USB (F3).
- To generate a report for all Jobs, press OPTIONS (F2) then select ALL TO USB.
- The dialogue 'Result saved to USB' appears. Reports are now saved on the USB key in the selected format(s).

2. Reports can be generated and downloaded to a smartphone (only when no tests are running).

To enable Wi-Fi for results transfer:

- Insert the supplied small Wi-Fi device into the LanXPLOER USB port. Note - the high gain antenna can not be used for results transfer.
- From the home screen select the JOBS icon.
- The display will show the Job List screen. Wi-Fi connectivity is indicated by the top bar on the LanXPLOER screen changing from grey to blue and a Wi-Fi symbol intermittently appearing in the battery symbol position

Now the LanXPLOER is ready for results transfer wirelessly.

Note

To minimise battery consumption the Wi-Fi connectivity is enabled for 5 minutes following power up and whenever the user is in the JOB screen.

To download results to an Android™ smartphone:

- Download and open IDEAL AnyWARE™ App from the Google Play™ Store.
- Search and connect to LanXPLOER. The SSID will be of the form "IDEALX-XXXXXX". This can be viewed on the LanXPLOER under the SETUP | REPORTS screen.
- You will be prompted for the LanXPLOER Wi-Fi password if it has been changed from the default value.
- Once connected the App will display list of JOBS on the LanXPLOER. These can be selected and downloaded to the smartphone.
- Once results are on the smartphone they can then be transferred using email or other share mechanisms.

To download results to an iPhone®:

- Download and open IDEAL AnyWARE™ App from iTunes®.
 - Search and connect to LanXPLOER. The SSID will be of the form "IDEALX-XXXXXX". This can be viewed on the LanXPLOER under the SETUP | REPORTS screen.
 - You will be prompted for the LanXPLOER Wi-Fi password if it has been changed from the default value.
 - Once connected the App will display list of JOBS on the LanXPLOER. These can be selected and downloaded to the smartphone.
 - Once results are on the iPhone® they can then be transferred using email or other share mechanisms.
-
- Apple is a trademark of Apple Inc., registered in the U.S. and other countries.
 - Android is a trademark of Google Inc.

Chapter 9. LanXPLOER Firmware Update

The LanXPLOER firmware should be updated at regular intervals. The latest firmware update can be downloaded from the IDEAL INDUSTRIES Ltd Internet site.

If you register for the **Newsletter** on the IDEAL INDUSTRIES Ltd Internet site, you will be notified of new downloads automatically.

The LanXPLOER firmware can be updated using as USB storage device.

NOTE:

Before updating the firmware, make a backup of the test data on the LanXPLOER.

When updating the firmware, power **should** be supplied to the LanXPLOER using the charger/power pack or ensure that the rechargeable batteries are fully charged.

Data export and data import is accomplished exclusively to/from a USB storage device connected to the LanXPLOER.

4. Store the firmware update on an empty USB storage device.
8. Plug the USB storage device into the USB interface on the LanXPLOER.
9. Switch on the LanXPLOER.
10. Ensure that the rechargeable batteries in the LanXPLOER are charged or connect the LanXPLOER to mains power.
11. Select the menu point **Setup**.
12. Select the menu point "System".
13. Select the menu point "Update".
14. **Update** the software. You can exit the menu without saving the changes with **Cancel** or **Escape**.
15. Select "Confirm" to start the update.
16. Wait until the update has concluded and the main menu appears on the LanXPLOER display after restarting.
17. Remove the USB storage device.

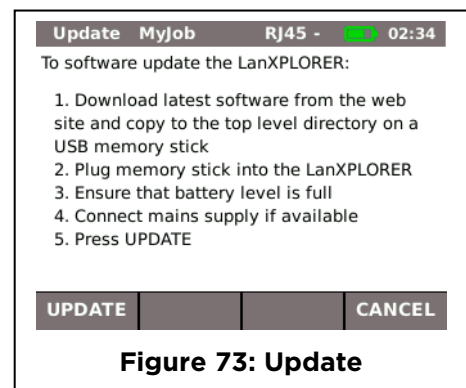

Figure 73: Update

NOTE:

Depending on the update, the LanXPLOER will re-start automatically or requires a manual re-start.

Chapter 10. Spare parts - Socket inserts

The LanXPLOER provides the possibility of replacing damaged or worn sockets with the RJ45 socket insert set (Ideal 150058).

EQUIPMENT INCLUDED

Quantity	Description
1	Tool
10	Replacement insert

CHANGING THE SOCKET INSERT

1. Switch the LanXPLOER off.
2. Remove cables.
3. Carefully push the tool STRAIGHT into the socket. BE CAREFUL - DO NOT MOVE THE TOOL VERTICALLY!



4. Keeping the tool STRAIGHT firmly pull the insert out from the socket.



5. Using fingers replace a new insert STRAIGHT into the socket and secure in place by firmly pushing it home.

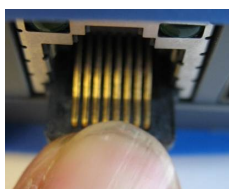



Chapter 11. Specifications

Connectors

- Primary RJ45 test port on left side
 - Used for: Cable Test, Endpoint Test, In-Line Test
 - User-replaceable contacts
 - 500 insertion cycles
- Secondary RJ45 test port on right side
 - Used for: In-Line Test
 - User-replaceable contacts
 - 500 insertion cycles
- Optical test port on left side
 - Used for: Endpoint test
 - SFP Socket
- USB port for management at top
 - Used for: Result upload, Software update, Wi-Fi antenna
 - Class: Host
 - Connector Type A
 - 1.1 USB Type
- Power port for battery charging, mains powering via adaptor on right side
 - 12V Voltage
 - Connector Type 2.0 pin power jack
 - 2 Amp Current
 - Centre Pin positive polarity

Controls

- Screen: Touch Screen
 - Used for: Touch Control of all Tester Functions
 - Located on front
- On/Off: Push Button
 - Used for: Power On/Off
 - Located on front
- Function Keys: F1 to F4
 - Used for: Screen Defined Functions
 - Located on front
- Navigation Keys: Cursor, Enter & Escape
 - Used for: User Interface Navigation
 - Located on front
- Autotest
 - Used for: Launch of automatic test sequence
 - Located on front
- Reset: Push Button
 - Used to Escape from exceptional lockup condition
 - Accessible through hole inside battery compartment using stylus tip

Displays

- Charger LED: Indication of charging status
 - Red/Green
 - Located on front
- Primary RJ45 Link LED: ON indicates Primary link UP
 - Green
 - Adjacent to socket
- Primary RJ45 Activity LED: Flashing indicates Primary link activity
 - Green
 - Adjacent to socket
- Secondary RJ45 Link LED: ON indicates Secondary link UP

- Green
 - Adjacent to Secondary RJ45 socket
- Secondary RJ45 Activity LED: Flashing indicates Secondary link activity
 - Green
 - Adjacent to Secondary RJ45 socket
- Optical Link LED: ON indicates Optical link UP
 - Green
 - Adjacent to SFP socket
- Optical Activity LED: Flashing indicates Optical link activity
 - Green
 - Adjacent to SFP socket
- Screen LCD
 - Type - QVGA Colour
 - Resistive touch screen
 - Pixels - 320 x 240
 - Use - Display of setup functions and results
 - Size - 3.5 inch diagonal
 - Location - Front

Ports - RJ45

- Mode: Full Duplex, Half Duplex
- Min. RX size: 19-99
- MAC: Factory set
- Cable Mode Tests: Wiremap, Tone Generator, Auto (Wiremap)
- Endpoint Mode Tests: Netmap, Ping (IPv4 & IPv6), PoE, Net Verify, Trace Route (IPv4 & IPv6), Loopback, Top Ten, Hub Blink, Auto (PoE Load, Ping, Trace Route, Network Verify), Conflicts
- In-Line (Monitor) Mode Tests: PC Diagnostics, VoIP, Top Ten, Service Detection (PoE, ISDN s (with audible warning), PBX (with audible warning), Unknown (with audible warning))
- VLAN
 - Enabled, Disabled
 - VLAN ID 0 to 4094
 - VLAN Priority 0-7
- Auto Detect Mode Cable, Endpoint, In-Line (Monitor)
- Auto Negotiation: Disabled or Enabled
- Speed: 10Mbps, 100Mbps & 1Gbps
- Link Pulse Polarity: Normal, Inverted
- Link Pulse Height: Normal, Low

Ports - Optical

- The following SFP types are supported. Use of other types of SFP is possible but correct operation is not guaranteed
 - SFP Type SX Manufacturer Part # Avago AFBR-5705Z / APAC LM28-C3S-TI-N-DD 1Gbps Multimode 850nm LC Duplex
 - SFP Type LX Manufacturer Part # Avago AFCT-5705Z 1Gbps Single mode 1310nm LC Duplex
 - SFP Type ZX Manufacturer Part # APAC LS48-C3U-TC-N-DD 1Gbps Single mode 1550nm LC Duplex
- Optical Tests: Tx Power dBm (using a specified SFP), Rx Power dBm (using a specified SFP)
Network Tests: Netmap, Ping, Net Verify, Trace Route, Loopback, Top Ten, Hub Blink, Auto (Ping, Trace Route, Network Verify), Conflicts

Ports - WiFi

- SSID: Text entry by full virtual keyboard, Entry from WiFi scan
- Encryption: None, WEP, WPA-PSK, WPA2-PSK
- Key/Key Type: Text entry by full virtual keyboard / ASCII, HEX
- Sensitivity: Designed for convenient network testing via local access points.
- Internal or external antenna not intended for comparative measurements of distant access points.
- Included high sensitivity external USB antenna for enhanced detection of lower signal strength access points
- Frequency: 2.4GHz
- Mode: 802.11b/g/n
- Scan: Signal strength indication, SSID, BSSID, Channel, Mode (802.11b/g/n), Encryption (None / WEP / WPA / WPA2)
- Network Tests: Netmap, Ping, Net Verify, Trace Route, Auto, Conflicts

In-Line Tests

- PC Diagnostics Results:
 - Protocols: Protocol, Frames. Traffic: Host IPv4 address, Peak Mb/s.
 - IP data: Info, IPv4 address, Gateway, Subnet mask, Primary DNS, Secondary DNS, DHCP Server.
 - Link: Errors, Info, 802.1x status
- VOIP Test Protocols: Session Initiation Protocol (SIP)
- VOIP Test Setup: VoIP Port 1:1 to 65535. VoIP Port 2: 1 to 65535. Max Jitter Test Threshold (ms): 1 to 999999, Max Delay Test Threshold (ms): 1 to 999999. Max Lost Packets Test Threshold (%):1 to 100
- VOIP Test Results:
 - Call Log: Last 20 calls, Call start time, Destination number, Call length (mm:ss) port number (destination & source).
 - Jitter: Last successfully connected call (ms to 3 decimal places), according to RFC3550 (Max, Min, Ave, Cur)
 - Delay: Last successfully connected call (ms) (Max, Min, Ave, Cur)

Cable Tests

- Wiremap Setup
 - Cable Type: Cat3 UTP, Cat3 STP, Cat5 UTP, Cat5 STP, Cat5e UTP, Cat5e STP, Cat6 UTP, Cat6 STP, Cat7, USOC, ETH S12-36, ETH S12-78, ETH U1236, ETH U1278, IND. M12, COAX RJ59.
 - Colour Scheme: None, 568A, 568B, USOC, TERA.
 - Cross Over Allowed: Yes, No.
 - NVP: Fixed 72%, Custom 59% - 89%
- Wiremap Termination Type: None - Open, Active Remote - #1 - #12
- Wiremap Tests (No Termination)
 - Faults: Open circuit by pin, Short circuit by pin.
 - Length of pair: Metres / Feet (Set in System Setup), Range 100m / 390ft
- Wiremap Tests (Active Remote Termination)
 - I/D-Remote #
 - Indications on Remote: Voltage Warning (>±10volts on any pins), Pass/Fail.

- Faults: Open circuit by pin, Short circuit by pin, Crossed pairs, Split pairs, Bridged shorts, Remote shorts.
- Length of pair: Metres/Feet (Set in System Setup), Range 100m/ 390ft
- Tone Generator Setup
 - Tones: 3. Wire I/D: Tone applied to one of 8 pins relative to the other 7, Tone applied across one of 4 pairs
 - Tone Generator Test Audible tone detected using compatible tone probe

Endpoint Tests

- VLAN
 - VLAN: Enabled, Disabled. ID: 0 to 4094. Priority: 0 to 7
- IP version: IPv4, IPv6
- IPv4 Addressing: DHCP, Static.
- IPv6 Addressing : Static, Stateful, Stateless
- Netmask. Gateway. DNS1: Numerical address only. DNS2: Numerical address only
- Netmap Setup
 - Network: Local, Custom.
 - IPv4 Address: Scan Range: Normal (000.255), Wide (015.255)
 - IPv6 Scan: Enable/ disable
- Netmap Results
 - Hosts count: All Hosts, Server Hosts (differentiation based on services / ports), Printer Hosts (differentiation based on services / ports).
 - Host details: Host Name, IPv4/6 Address, MAC Address, Services Detected
- Ping Setup
 - Target: IP address, URL.
 - Count: 1 to 999999.
 - Pause: 0 to 5000 ms.
 - Length: 8 to 3000 bytes
- Ping Results
 - Info: READY, IN PROGRESS, PASSED, NO RESPONSE, UNKNOWN HOST.
 - Tx Count: 0 to 999999.
 - Rx Count: 0 to 999999.
 - Delay(ms): Minimum, Average, Maximum
- PoE Setup
 - Test Type: PoE, PoE Plus.
 - Min PoE Power Test Threshold: 1 to 15 watts.
 - Min PoE + Power Test Threshold: 1 to 28 watts
- PoE Results
 - Status: READY, FAILED NO POE DETECTED, PASSED.
 - Pair: 12/36, 45/78.
 - Voltage: 0 to 60 volts.
 - Current: 0 to 600 mA.
 - Power: 0 to 36 watts
- Net Verify Setup
 - Comparison Map: Stored map from previous Netmap test
- Net Verify Results
 - Hosts count : All Hosts Same / Different,
 - Server Hosts Same / Different,
 - Printer Hosts Same / Different.
 - Host details: Host Name, IPv4 Address, MAC Address, Services detected
- Trace Route Setup

- Target: IP address, URL.
- Max Hops: 1 to 100.
- Timeout: 1 to 30 sec.
- Type: ICMP, UDP
- Trace Route Results
 - Info: READY, IN PROGRESS, PASSED, NO RESPONSE, UNKNOWN HOST.
 - Hop: IP address, name.
 - Delay(ms): t1, t2, t3
- Loop Back Setup
 - Type: Wireline, MAC, IP, UDP
- Top Ten Setup
 - Period: 1 sec, 30 sec, Peak
- Top Ten Results
 - Top Ten: Talkers, Errors, Protocols.
 - Host: IP address.
 - Bandwidth: Average Mb/s
- Blink Test Sequence: Off/10/Off/100/Off/1000 Mb/s
- IP Conflicts

Statistics

- Top Ten Setup
 - Period: 1 sec, 30 sec, Peak
 - Talkers & Listeners
 - IP or MAC
- Top Ten Results
 - Top Ten: Talkers or Listeners, IP or MAC (average Mb/s), Errors (Frame Count), Protocols type (Frame Count).
 - Host: IP address.
 - Bandwidth: Average Mb/s
- IP Results
 - Info, Listening, IPv4/6 address, Gateway, Subnet mask, Primary DNS, Secondary DNS, DHCP Server
- VLAN Results
 - Rx & Tx: VLAN (Endpoint), Rx & Tx: VLAN (In-Line)
- MAC Results
 - Rx & Tx: Frames, Total Bytes, Unicast, Broadcast, Multicast, Max Frames/sec, Current Rate bps, Average Rate bps, Max Rate bps, Current Utilisation %, Average Utilisation %, Max Utilisation %, Frame Size
- MAC Discovery LLDP, CDP, EDP
- Link Results
 - PORT: PoE Type, PoE Pair, Speed, Duplex, MDI / MDIX, Signal Level, Polarity.
 - PARTNER: 10M-HD, 10M-FD, 100M-HD, 100M-FD, 1000M-HD, 1000M-FD.
 - ERRORS: Collisions, FCS Errors, Undersize, Oversize, Jabbers, Bad Length

Storage

- Internal storage configurations
 - Number of configurations – 2 (Current + Factory settings).
 - Export to USB. Format: .xml
- Internal storage results

- Max Number of Jobs (Projects) – 30, Max Number of result sets per Job – 250, Max total number of result sets - 7500.
- Result Export
 - to USB. Format: PDF / CSV (summary only).
 - to Smartphone over Wi-Fi using IDEAL AnyWARE. Format: PDF / CSV (summary only)

General

- Dimensions: Length: 205mm, Width: 98 mm, Depth: 45mm
- Weight Unit: 470g, Batteries: 180g
- Temperature
 - Operating: 0°C to 40°C,
 - Storage: -20°C to 70°C
- Relative Humidity Min: 5%, Max: 90% non-condensing
- EMC Approvals EN 55022:2006 / A1:2007, EN55024:1998 / A1:2001 / A2:2003
- Safety Approvals IEC 60950-1:2005+A1:2009/EN 60950-1:2006+A1:2010
- Internal Clock
 - Used for: Timestamping results.
 - Autonomy: Up to 2 days with battery removed
- Power: Battery
 - Supported Types: Internally rechargeable 6 x AA NiMH cell pack, 6 x AA Alkaline cells.
 - Autonomy: 5 hours minimum (Rechargeable pack only),
 - Recharge time: 8 hours (Rechargeable pack only)

System Setup

- Language Preferences: English, German, French, Spanish, Italian, Portuguese, Chinese
- Auto Off Preferences: Disabled, 3 mins, 10 mins, 30 mins
- Backlight Preferences: Always on, Switch off after 3 mins
- Length / Units Preferences: Metres, Feet
- Software Upgrade Via USB

Regulatory compliance

- EMC: EN 55022:2006 / A1:2007, EN55024:1998 / A1:2001 / A2:2003,
- Safety: IEC 60950-1:2005+A1:2009/EN 60950-1:2006+A1:2010



Call Us 1.877.571.7901



IDEAL NETWORKS

IDEAL INDUSTRIES LIMITED
Stokenchurch House, Oxford Road, Stokenchurch,
High Wycombe, Bucks, HP14 3SX, UK.

www.idealnetworks.net

A subsidiary of IDEAL INDUSTRIES INC.

