



## Elite CTS Tester Operating Instructions

68X001308 Rev.0

June, 2017

## Replacing the Batteries

The Elite CTS tester uses four AAA 1.5 V batteries.

1. To remove the battery cover, See Figure 1. Clear the front catch and then the back catch, before sliding the cover off.
2. To remove the battery plate, push the center tab towards the front of the tester as show in Figure 2. Once unlocked, remove the plate to access the batteries.
3. Invert the tester upside down to remove the batteries. Each side uses two AAA batteries. Orient each battery with positive terminal facing downward.
4. To lock the battery plate, align the small tabs into the guide ribs on the housing and then press down. See Figure 4.

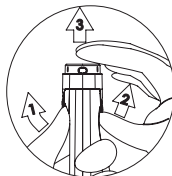

Figure 1: Removing battery cover

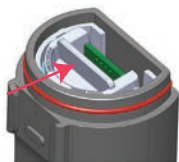

Figure 2: Push to unlock



Figure 3: Align tabs



Figure 4: Push down to unlock

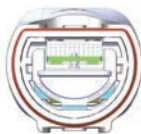

Figure 5: Battery plate unlock position









Figure 6: Battery plate lock position

## Getting Started

The Elite CTS tester has been factory calibrated and usually works well out of the box. However, after extended periods of non-use, it is best to remove the sensor cap and soak the sensor in warm tap water for 10 minutes or so. Prior to taking the measurements, periodic calibration with certified standards is recommended for best accuracy.

## Measurement Parameter Setting

1. Press  to power on the tester.
2. Press  to enter setup window. Press  to select Measure. The display shows Cond, TDS and Salinity.
3. Scroll down by pressing  to toggle between Cond, TDS and Salinity. Press  to select Cond.
4. The display shows the selected measure with a .

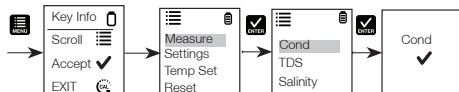

## TDS Factor Setting

1. Press to enter setup window. Scroll down by pressing to select Settings.
2. Press to select settings. The display shows TDS factor and Backlight.
3. Press to select the default TDS factory setting or to adjust the setting.
4. Press to confirm the selection of the setting. The display shows the set TDS factor with a .

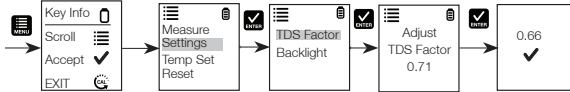

## Backlight Settings

1. Press to enter setup window. Scroll down by pressing to select Settings.
2. Press to select Settings. The display shows TDS Factor and Backlight.
3. Scroll down by pressing to toggle between TDS Factor and Backlight. Press to select Backlight.
4. The display shows ON and OFF. Scroll down by pressing to toggle between ON and OFF. Backlight ON increases readability in low light conditions.
5. Press to select the desired backlight option. The display shows the selected backlight option with a .

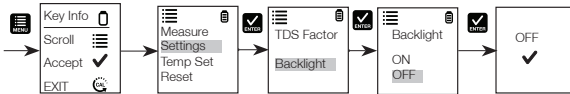

## Temperature Settings

1. Press to enter setup window. Scroll down by pressing to select Temp Set. Press to select Temp set. The display shows Set °C/°F, Temp Cal and Temp Coeff.
2. Press to select Set °C/°F. Scroll down by pressing to toggle between °C and °F.
3. Press to select temperature unit. The display shows the selected temperature setting with a .

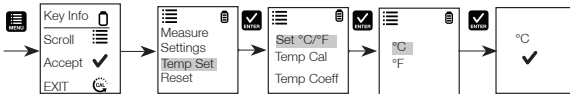

## Temperature Calibration

1. Press to enter setup window. Scroll down by pressing to select Temp Set.
2. Press to select Temp Set. The display shows Set °C/°F, Temp Cal and Temp Coeff.
3. Scroll down by pressing to toggle between Set °C/°F, Temp Cal and Temp Coeff. Press to select Temp Cal.
4. The lower display shows the current measured temperature reading based on the last set offset and the upper display shows the current measured temperature reading based on factory default calibration.

- Dip the tester into a solution of known temperature and allow time for the in built temperature sensor to stabilize.
- Press to adjust the temperature value or press the to confirm the calibrated value as the new temperature value of the solution.

**Note:** To exit this program without confirming the calibration, press .

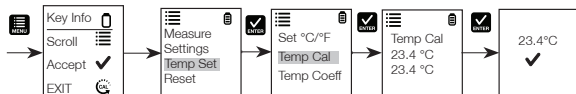

## Temp Coefficient

- Press to enter setup window. Scroll down by pressing to select Temp Set.
- Press to select Temp Set. The display shows Set °C/°F, Temp Cal and Temp Coeff.
- Scroll down by pressing to toggle between Set °C/°F, Temp Cal and Temp Coeff.
- Press to select Temp Coeff or to adjust the Temp Coeff.
- Press to confirm the Temp Coeff value. the new value is automatically confirmed with a .

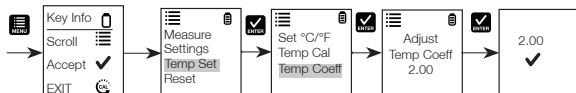

## Calibration for Conductivity, TDS, or Salinity

For best results, periodic calibration with an accurate standard is recommended prior to measurement. Use the calibration standard value that is close to your intended sample value. The tester will retain one calibration value in each mode (conductivity, TDS, salinity) when the instrument is powered off. The conductivity value can be calibrated automatically or manually, while the TDS & salinity values require manual calibration. The tester will begin in the measurement mode that was used when it was powered off. See "Elite CTS Measurement Parameter Setting" to change the desired parameter.

### Automatic Calibration for Conductivity

- Remove the cap and press the to power on.
- Dip the sensor in at least 30 mm of calibration standard.
- Stir gently and press to begin the calibration.
- The display will show CAL followed by the default value. CAL is indicated on the display during calibration mode.
- If the reading is within the calibration range of the automatically recognized standards; 80 (84  $\mu\text{S}/\text{cm}$ ), 1410 (1413  $\mu\text{S}/\text{cm}$ ), or 12.90 (12.88  $\text{mS}/\text{cm}$ ), the icon is displayed when the automatic calibration standard value has been detected.
- Press to accept the auto conductivity standard and finish the calibration.
- Display returns to Measurement window.

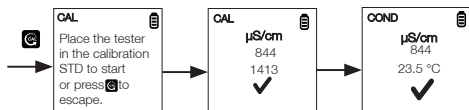



## Manual Calibration

When the conductivity reading is outside calibration range of the automatic conductivity standards or when TDS or salinity is used, the tester will require manual adjustment.

1. Repeat steps 1 to 4 from “Automatic Calibration for Conductivity”.
2. Press  to manually adjust the value to the desired reading.



**Note:** The adjustment will decrease only, however the adjustment will eventually cycle to the highest available value after decreasing by 40% of the initial value.

3. Press  to accept and finish the calibration when the desired value is selected.
4. To abort calibration, press  to escape.
5. Once the calibration is finished and user has accepted the changes, measurement window will now show the calibrated reading.

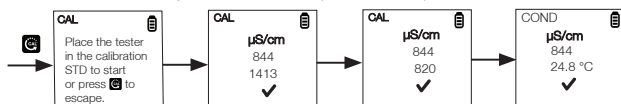

**Note:** The auto conductivity standards are 84  $\mu\text{S/cm}$ , 1413  $\mu\text{S/cm}$  & 12.88  $\text{mS/cm}$ .



## CTS Measurement

1. Press  to power the tester on if needed.
2. Dip the electrode about 2 cm to 3 cm into the test solution. Stir and let the reading stabilize. The timer icon will blink during this time. Once the reading is stabilized, the timer stops blinking and  will appear to indicate the stability of the reading.

**CAUTION:** Testing dry samples is not accurate and can lead to sensor damage or breakage. Soils must be wet and free of particulates that may scratch the glass sensor. Excessive force into dry samples can cause glass breakage.

3. Note the CTS value or press  to freeze the reading. To release the reading, press  again.
4. Press  to turn off tester. If key is not pressed for 8.5 minutes, the tester will automatically shut off to conserve batteries.

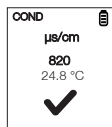

## User Reset

Reset the CTS calibration to the user's default settings by using the user reset function. Temperature user calibration is not affected by the user reset function.

1. Press  to enter setup window. Scroll down by pressing  to select Reset. Press  to select Reset. The display shows User Reset and Fact Reset.
2. Press  to select User Reset.
3. The display automatically shows No and Yes. Scroll down by pressing  to toggle between No and Yes.
4. Press  to confirm either No or Yes. The display shows the User Reset option with a .

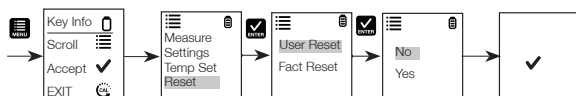

## Factory Reset

Reset the CTS tester to the factory default by using the factory reset function.

1. Press to enter setup window. Scroll down by pressing the to select Reset. Press to select Reset. The display shows User Reset and Fact Reset.
2. Scroll down by pressing to toggle between the resets. Press to select Fact Reset.
3. The display automatically shows No and Yes. Scroll down by pressing to toggle between No and Yes.
4. Press to confirm either No or Yes. The display shows the Factory Reset option with a .



## HOLD Function

This feature helps to freeze the display for a delayed observation.

1. Press button to freeze the measurement.
2. Press again to release the measurement.



## Sensor Maintenance

1. Always keep the sensors electrodes clean. Rinse the electrodes with de-ionized water and wipe them dry with clean cloth before storing with its protective cap. For cup type electrodes, remove the white plastic cup and insert to thoroughly clean viscous solutions. Never scratch electrodes with a hard substance.
2. For better performance, soak the electrode in alcohol for 10 to 15 minutes and rinse with de-ionized water before starting any measurement process. This is to remove dirt and oil stains on the electrode which may affect the accuracy of the measurements.

## Applications

The Elite CTS tester can be used for the following:

- Agriculture
- Drinking water Hydroponics
- Verification of reverse osmosis system operation
- Aquaculture
- Electroplating rinse tanks
- Water and wastewater treatment
- Aquariums and fish farms
- Printing industry
- Others
- Boiler blow-down
- Swimming pools

## Warranty

This instrument is supplied with a warranty against manufacturing defects for a period of one year from the date of purchase.

## Return of Items

Authorization must be obtained from your distributor before returning items for any reason. When applying for authorization, please include information regarding the reason the item(s) are to be returned.

We reserve the right to make improvements in design, construction and appearance of products without notice. Prices are subject to change without notice.

## Sensor Replacement

Replace the sensor module at the fraction of the cost of a new tester. When the tester fails to calibrate or gives fluctuating readings in calibration standards, you need to change the electrode.

1. With dry hands, grip the ring with sensor facing you. Twist the ring clockwise. Save the ring for later use.
2. Pull the old sensor module away from the tester.
3. Align the four tabs on the new module so that they match the four slots on the tester.
4. Gently push the module onto the slots to sit it in position. Push the smaller O-ring fully onto the new sensor module. Push the other O-ring over the module and thread it into place by firmly twisting counter clockwise.

**Note:** It is necessary that you recalibrate your tester prior to measurement after a sensor replacement.

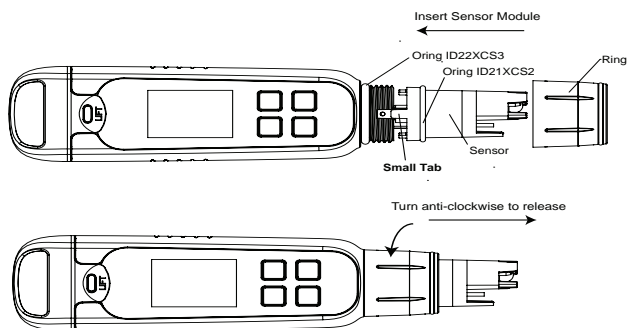

## Self Diagnostic Messages



Batteries are weak and need replacement soon.

stable error

Appears when calibration is attempted but the reading is not yet stable. Wait for the reading to stabilize or manually confirm the calibration by pressing enter.

over range

The reading is above the measuring range of tester.

<b>Specification</b>	<b>Elite CTS</b>
<b>Conductivity</b>	
Conductivity range	0.0 to 200.0 $\mu$ S, 200 to 2000 $\mu$ S, 2.00 to 20.00 mS
Resolution	0.1 $\mu$ S, 1 $\mu$ S, 0.01 mS
Relative accuracy	$\pm$ 1% full scale
Normalization temperature	25.0°C (77°F)
Temperature Co-efficient	0.0% to 10.0%
Calibration Points	Up to 3 points
<b>TDS</b>	
TDS Range	0 .0 to 100.0 ppm 100 to 1000 ppm 0.10 to 10.00 ppt (TDS Factor 0.5)
Resolution	0.1 ppm, 1 ppm, 0.01 ppt
Relative accuracy	$\pm$ 1% full scale
Calibration points	Up to 3 points
TDS Factor	0.40 to 1.00 ( Selectable)
<b>Salinity</b>	
Salinity range	0.00 to 10.00 ppt
Resolution	0.10 ppt
Relative accuracy	$\pm$ 1% full scale
Calibration points	One
<b>Temperature</b>	
Temperature range	0°C to 60°C (32.0°F to 140.0°F)
Temperature resolution	0.1°C / 0.1°F
Temperature accuracy	from 0°C to 50°C ( $\pm$ 0.5°C / $\pm$ 0.9°F + 1 LSD); from 50°C to 60°C ( $\pm$ 1.0°C / $\pm$ 1.8 °F + 1 LSD)
Temperature compensation	Yes (Automatic Temperature Compensation)



Specification	Elite CTS
<b>General</b>	
Display	Graphics, Dot Matrix 80X100 Pixel
Auto off	8.5 minutes ( From Last Key press)
Reset	User / Factory
Power requirement	Four AAA 1.5 V batteries
Battery life	>150 hours
Water proofing	IP67
<b>Environmental operating conditions</b>	
Ambient operating temperature	5°C to 45°C
Relative humidity	5% to 85% Non-Condensing
Storage temperature	-20°C to 60°C
Storage humidity	5% to 85% Non-Condensing

## Accessories

Ordering Code	Product Description
<b>CTS Tester</b>	
ELITECTSPIN	Conductivity/TDS/salinity pocket tester with batteries
ELITECTSCUP	Conductivity/TDS/salinity pocket tester with batteries
<b>Conductivity Standard Solutions and Sachets</b>	
ECCON100BT	100 µS/cm KCl, 480 mL
ECCON1413BT	1413 µS/cm KCl, 480 mL
ECCON1288BT	12.88 mS/cm KCl, 480 mL
ECCON1413BS	1413 µS/cm KCl, box of 20 x 20 mL sachets
<b>TDS 442* Standard Solutions</b>	
EC442300BT	300 ppm 442, 480 mL
EC4421000BT	1000 ppm 442, 480 mL
<b>Salinity (NaCl) Solutions</b>	
ECNACL5PPT	5 ppt NaCl, 480 mL
<b>Other Accessories</b>	
ELITECAP	Replacement sensor cap
TFLANYARD	Tester lanyard

\*The 442 scale simulates fresh water dissolved solids as a mixture of 4 parts sodium sulfate, 4 parts sodium bicarbonate, and 2 parts sodium chloride (40% Na<sub>2</sub>SO<sub>4</sub>, 40% NaHCO<sub>3</sub>, 20% NaCl).

Dieses Anleitungshandbuch bezieht sich auf den Elite CTS-Tester.

## Einlegen und Entnehmen der Batterie

Für den Elite CTS-Tester werden vier AAA 1,5 V Batterien benötigt.

1. Halten Sie den Tester mit einer Hand fest und schieben Sie den Daumen unter die vordere Klemme, um sie zu lösen.
2. Halten Sie den Tester weiter in der Hand und schieben Sie den anderen Daumen unter die hintere Klemme, um sie ebenfalls zu lösen.
3. Wenn beide Klemmen gelöst sind, schieben Sie die Batterieabdeckung nach oben aus dem Tester heraus. Dadurch wird die Batterieabdeckung entfernt.
4. Zum Einlegen der Batterieplatte bringen Sie die kleinen Laschen in den Führungsrillen an dem Gehäuse in eine Linie. Siehe Abbildung 2.
5. Um die Batterieplatte zu verriegeln, drücken Sie sie nach unten und schieben Sie sie in die in Abbildung 3 gezeigte Richtung.
6. Zum Lösen schieben Sie die Lasche wie in Abbildung 4 gezeigt zurück.



Abbildung 1: Entfernen der Batterieabdeckung



Abbildung 2: Schieben, um zu entsperren

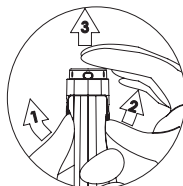

Abbildung 3: Richten Sie die Registerkarten aus



Abbildung 4: Drücken Sie nach unten, um zu sperren



Abbildung 5: Batterieplatte in entsperrter Position







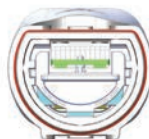

Abbildung 6: Batterieplatte in gesperrter Position

## Erste Schritte





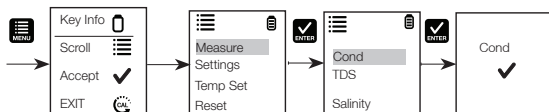

Der Elite CTS-Tester ist werkseitig kalibriert und in der Regel direkt gebrauchsfähig. Nach längerem Nichtgebrauch empfiehlt es sich jedoch, die Sensorkappe abzunehmen und den Sensor ungefähr 10 Minuten lang in warmem Leitungswasser einzuweichen. Für optimale Genauigkeit wird vor der Durchführung der Messungen eine regelmäßige Kalibrierung mit zertifizierten Standards empfohlen.

## Einstellung der Messparameter

1. Drücken Sie , um den Tester einzuschalten.
2. Drücken Sie , um zum Konfigurationsmenü zu gelangen. Drücken Sie  zur Auswahl von „Measure“ (Messen). Die Anzeige zeigt „Cond“ (Leitfähigkeit), „TDS“ und „Salinity“ (Salinität).
3. Scrollen Sie durch Drücken von  nach unten, um zwischen „Cond“ (Leitfähigkeit), „TDS“ und „Salinity“ (Salinität) umzuschalten. Drücken Sie  zur Auswahl von „Cond“ (Leitfähigkeit).
4. Auf der Anzeige ist die Auswahl mit einem  versehen.







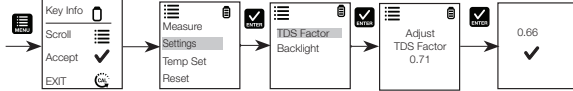

## Einstellung des TDS-Faktors

1. Drücken Sie , um zum Konfigurationsmenü zu gelangen. Scrollen Sie durch Drücken von  nach unten, um „Settings“ (Einstellungen) zu wählen.
2. Drücken Sie  zur Auswahl von „Settings“ (Einstellungen). Auf der Anzeige haben Sie die Wahl zwischen „TDS factor“ (TDS-Faktor) und „Backlight“ (Hintergrundbeleuchtung).
3. Drücken Sie  zur Auswahl der werkseitigen TDS-StandardEinstellung oder  zur Anpassung der Einstellung.
4. Drücken Sie  zur Bestätigung der von Ihnen gewählten Einstellung. Auf der Anzeige ist die ausgewählte TDS-Faktor einstellen mit einem ✓ versehen.







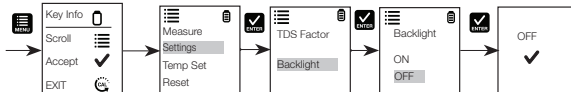

## Auswahl der für die Hintergrundbeleuchtung

1. Drücken Sie , um zum Konfigurationsmenü zu gelangen. Scrollen Sie durch Drücken von  nach unten, um „Settings“ (Einstellungen) zu wählen.
2. Drücken Sie  zur Auswahl von „Settings“ (Einstellungen). Auf der Anzeige haben Sie die Wahl zwischen „TDS factor“ (TDS-Faktor) und „Backlight“ (Hintergrundbeleuchtung).
3. Scrollen Sie durch Drücken von  nach unten, um zwischen „TDS Factor“ (TDS-Faktor) und „Backlight“ (Hintergrundbeleuchtung) umzuschalten. Drücken Sie  zur Auswahl von „Backlight“ (Hintergrundbeleuchtung).
4. Auf der Anzeige haben Sie die Wahl zwischen „ON“ (EIN) und „OFF“ (AUS). Scrollen Sie durch Drücken von  nach unten, um zwischen „ON“ (EIN) und „OFF“ (AUS) umzuschalten. Die Aktivierung der Hintergrundbeleuchtung (Backlight ON) verbessert die Lesbarkeit bei schlechten Lichtverhältnissen.
5. Drücken Sie  um die gewünschte Option für die Hintergrundbeleuchtung zu wählen. Auf der Anzeige ist die ausgewählte Option zur Hintergrundbeleuchtung mit einem ✓ versehen.







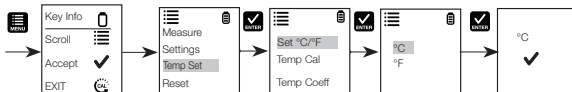

## Auswahl der Temperatur

1. Drücken Sie , um zum Konfigurationsmenü zu gelangen. Scrollen Sie durch Drücken von  nach unten, um „Temp Set.“ (Temp.-Einstellung) zu wählen. Drücken Sie  um „Temp set.“ (Temp.-Einstellung) zu wählen. Die Anzeige zeigt „Set °C/°F“ (°C/°F einstellen), „Temp Cal.“ (Temp.-Kal.) und „Temp Coeff“ (Temp.-Koeff.).
2. Drücken Sie  zur Auswahl von „Set °C/°F“ (°C/°F einstellen). Scrollen Sie durch Drücken von  nach unten, um zwischen °C und °F umzuschalten.
3. Drücken Sie  zur Auswahl einer Temperatureinheit. Auf der Anzeige ist die ausgewählte Temperatureinstellung mit einem ✓ versehen.



## Temperaturkalibrierung





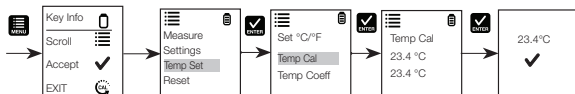

1. Drücken Sie , um zum Konfigurationsmenü zu gelangen. Scrollen Sie durch Drücken von  nach unten, um „Temp Set.“ (Temp.-Einstellung) zu wählen.
2. Drücken Sie  um „Temp set.“ (Temp.-Einstellung) zu wählen. Die Anzeige zeigt „Set °C/°F“ (°C/°F einstellen), „Temp Cal.“ (Temp.-Kal.) und „Temp Coeff“ (Temp.-Koeff.).

3. Scrollen Sie durch Drücken von  nach unten, um zwischen „Set °C/°F“ (°C/°F einstellen), „Temp Cal.“ (Temp.-Kal.) und „Temp Coeff“ (Temp.-Koeff.) umzuschalten. Drücken Sie  um „Temp Cal.“ (Temp.-Kalibrierung) zu wählen.
4. Die untere Anzeige zeigt den aktuellen Temperaturmesswert ausgehend vom zuletzt eingestellten Offset und die obere Anzeige zeigt den aktuellen Temperaturmesswert ausgehend von der werkseitigen Standardkalibrierung.
5. Tauchen Sie den Tester in eine Lösung mit bekannter Temperatur und lassen Sie den eingebauten Temperatursensor sich stabilisieren.
6. Drücken Sie  um den Temperaturwert zu justieren, oder drücken Sie  um den kalibrierten Wert als neuen Temperaturwert der Lösung zu bestätigen.

**Hinweis:** Um dieses Programm zu verlassen, ohne die Kalibrierung zu bestätigen, drücken Sie .



## Temperaturkoeffizient

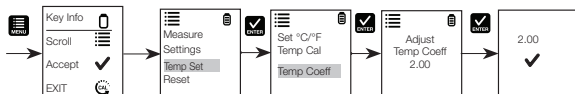

1. Drücken Sie  um zum Konfigurationsmenü zu gelangen. Scrollen Sie durch Drücken von  nach unten, um „Temp Set.“ (Temp.-Einstellung) zu wählen.
2. Drücken Sie  um „Temp set.“ (Temp.-Einstellung) zu wählen. Die Anzeige zeigt „Set °C/°F“ (°C/°F einstellen), „Temp Cal.“ (Temp.-Kal.) und „Temp Coeff“ (Temp.-Koeff.).
3. Scrollen Sie durch Drücken von  nach unten, um zwischen „Set °C/°F“ (°C/°F einstellen), „Temp Cal.“ (Temp.-Kal.) und „Temp Coeff“ (Temp.-Koeff.) umzuschalten.
4. Drücken Sie  zur Auswahl von „Temp Coeff“ (Temp.-Koeff.) oder auf  zur Anpassung des Temperaturkoeffizienten.
5. Drücken Sie  zur Bestätigung des Werts des Temperaturkoeffizienten. Der neue Wert wird automatisch mit einem ✓ bestätigt.



## Kalibrierung für Leitfähigkeits-, TDS- oder Salinitätsmessungen

Um optimale Ergebnisse zu erzielen, wird eine regelmäßige Kalibrierung mit einem akkuraten Standard vor der Messung empfohlen. Verwenden Sie den Kalibrierstandardwert, der dem voraussichtlichen Wert für Ihre Probe am nächsten liegt. Der Tester speichert in jedem Modus (Leitfähigkeit, TDS, Salinität) einen Kalibrierwert, wenn er ausgeschaltet wird. Der Leitfähigkeitswert kann automatisch oder manuell kalibriert werden, wohingegen die TDS- und Salinitätswerte eine manuelle Kalibrierung erfordern. Der Tester beginnt im Messmodus, der vor dem Ausschalten verwendet wurde. Siehe „Einstellung der Messparameter bei Elite CTS-Tester“, um den gewünschten Parameter zu ändern.

### Automatische Kalibrierung für Leitfähigkeitsmessungen

1. Entfernen Sie die Kappe und drücken Sie  um das Gerät einzuschalten.
2. Tauchen Sie den Sensor mindestens 30 mm weit in den Kalibrierstandard ein.
3. Rühren Sie vorsichtig und drücken Sie  um die Kalibrierung zu starten.
4. In der Anzeige erscheint „CAL“ gefolgt vom Standard-Leitfähigkeitswert. Im Kalibriermodus wird auf der Anzeige „CAL“ angezeigt.
5. Wenn die Messung im Kalibrierbereich der automatisch erkannten Standards liegt, d. h. 80 (84 µS/cm), 1410 (1413 µS/cm) oder 12,90 (12,88 mS/cm), wird das Symbol ✓ angezeigt, wenn der automatische Kalibrierstandardwert detektiert wurde.

- Drücken Sie , um den automatischen Leitfähigkeitsstandard zu akzeptieren und die Kalibrierung abzuschließen.
- Danach wird wieder das Messfenster aufgerufen.



## Manuelle Kalibrierung

Liegt der Messwert für die Leitfähigkeit außerhalb des Kalibrierbereichs der automatischen Leitfähigkeitsstandards, oder bei Verwendung von TDS oder Salinität, muss der Tester manuell justiert werden.

- Wiederholen Sie die Schritte 1 bis 4 unter „Automatische Kalibrierung für Leitfähigkeitsmessungen“.

- Drücken Sie , um den Wert manuell auf den gewünschten Messwert zu justieren.

**Hinweis:** Die Justierung ist nur nach unten möglich, nach Reduzierung des Ursprungswerts um 40 % wird aber eventuell wieder der höchste mögliche Wert angezeigt.

- Drücken Sie , um die Kalibrierung zu akzeptieren und abzuschließen, nachdem der gewünschte Wert ausgewählt wurde.

- Um die pH-Kalibrierung abzubrechen, drücken Sie , um den Modus zu verlassen.

- Nachdem die Kalibrierung abgeschlossen ist und der Benutzer die Änderungen bestätigt hat, wird im Messfenster nun der kalibrierte Messwert angezeigt.

**Hinweis:** Die automatischen Leitfähigkeitsstandards sind 84  $\mu\text{S}/\text{cm}$ , 1413  $\mu\text{S}/\text{cm}$  und 12,88  $\text{mS}/\text{cm}$ .

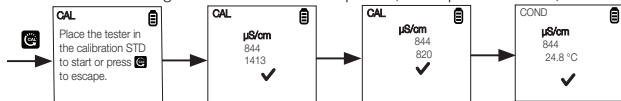

## CTS-Messung

- Drücken Sie , um den Tester einzuschalten, falls er ausgeschaltet ist.

- Tauchen Sie die Elektrode ungefähr 2 cm bis 3 cm tief in die Testlösung. Rühren Sie um und warten Sie, bis sich die Anzeige stabilisiert hat. Währenddessen blinkt das Timer-Symbol. Sobald sich die Anzeige stabilisiert hat, hört der Timer auf zu blinken, und mit  wird die Stabilität des Messwerts angezeigt.

**VORSICHT:** Tests mit trockenen Proben sind ungenau und können zu einer Beschädigung oder zum Ausfall des Sensors führen. Bodenproben müssen feucht und frei von Partikeln sein, die den Glassensor zerkratzen könnten. Zu starkes Hineinpressen in trockene Proben kann zum Zerschneiden des Glases führen.

- Notieren Sie den CTS-Wert oder drücken Sie  um die Messwertanzeige einzufrieren.



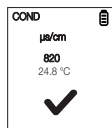

Um das Einfrieren aufzuheben, drücken Sie noch einmal auf .



- Drücken Sie , um den Tester auszuschalten. Wenn Sie 8,5 Minuten lang keine Taste drücken, schaltet sich der Tester automatisch aus, um die Batterien zu schonen.



## Zurücksetzen auf die Standardeinstellungen des Benutzers

Sie können die CTS-Kalibrierung auf die Standardeinstellungen des Benutzers zurücksetzen, indem Sie die entsprechende Funktion verwenden. Die Funktion zum Zurücksetzen auf die Standardeinstellungen des Benutzers wirkt sich nicht auf die Kalibrierung der Pufferwahl und die Temperatureinstellung des Benutzers aus.





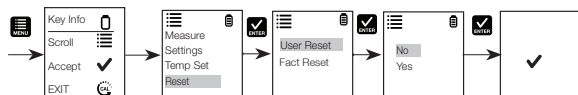



- Drücken Sie , um zum Konfigurationsmenü zu gelangen. Scrollen Sie durch Drücken von  nach unten, um „Reset“ (Zurücksetzen) zu wählen. Drücken Sie  zur Auswahl von „Reset“ (Zurücksetzen). Auf der Anzeige haben Sie die Wahl zwischen „User Reset“ (Zurücksetzen auf die Standardeinstellungen des Benutzers) und „Fact Reset“ (Zurücksetzen auf Werkseinstellungen).
- Drücken Sie  zur Auswahl von „User Reset“ (Zurücksetzen auf die Standardeinstellungen des Benutzers).

- Die Anzeige zeigt automatisch „No“ (Nein) und „Yes“ (Ja). Scrollen Sie durch Drücken von  nach unten, um zwischen „No“ (Nein) und „Yes“ (Ja) umzuschalten.
- Drücken Sie , um „No“ (Nein) oder „Yes“ (Ja) zu bestätigen. Auf der Anzeige ist die Option zum Zurücksetzen auf die Standardeinstellungen des Benutzers mit einem  versehen.



## Zurücksetzen auf Werkseinstellungen

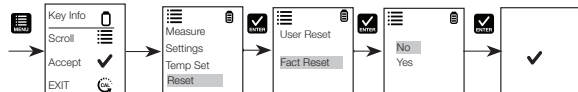

Sie können die CTS-Kalibrierung auf die Werkseinstellungen zurücksetzen, indem Sie die entsprechende Funktion verwenden.

- Drücken Sie , um zum Konfigurationsmenü zu gelangen. Scrollen Sie durch Drücken von  nach unten, um „Reset“ (Zurücksetzen) zu wählen. Drücken Sie  zur Auswahl von „Reset“ (Zurücksetzen). Auf der Anzeige haben Sie die Wahl zwischen „User Reset“ (Zurücksetzen auf die Standardeinstellungen des Benutzers) und „Fact Reset“ (Zurücksetzen auf Werkseinstellungen).
- Scrollen Sie durch Drücken von  nach unten, um zwischen den Optionen zum Zurücksetzen umzuschalten. Drücken Sie  zur Auswahl von „Fact Reset“ (Zurücksetzen auf Werkseinstellungen).
- Die Anzeige zeigt automatisch „No“ (Nein) und „Yes“ (Ja). Scrollen Sie durch Drücken von  nach unten, um zwischen „No“ (Nein) und „Yes“ (Ja) umzuschalten.
- Drücken Sie , um „No“ (Nein) oder „Yes“ (Ja) zu bestätigen. Auf der Anzeige ist die Option zum Zurücksetzen auf Werkseinstellungen mit einem  versehen.



## HOLD-Funktion

Mit dieser Funktion können Sie die Anzeige zur Verzögerung der Messung einfrieren.

- Drücken Sie die Taste , um die Messung einzufrieren.
- Drücken Sie die Taste  erneut, um das Einfrieren der Messung aufzuheben.



## Sensorwartung

- Halten Sie die Sensorelektroden stets sauber. Spülen Sie die Elektroden mit entionisiertem Wasser und wischen Sie sie mit einem sauberen Tuch trocken, bevor Sie unter der Schutzkappe aufbewahren. Bei Elektroden vom Cup-Typ entfernen Sie den Kunststoff-Cup und tauchen Sie die Elektroden in nachweislich saubere viskose Lösungen. Achten Sie darauf, die Elektroden nicht zu zerkratzen.
- Für optimale Funktion tauchen Sie die Elektrode 10 bis 15 Minuten in Alkohol und spülen Sie sie mit entionisiertem Wasser ab, bevor Sie mit einer Messung beginnen. Damit werden Schmutz und Ölflecken, die die Messgenauigkeit beeinträchtigen könnten, von der Elektrode entfernt.

## Austauschen des Sensors

Sie können das Sensormodul zu einem Bruchteil der Kosten eines neuen Testers austauschen. Wenn der Tester keine Kalibrierung durchführt oder bei Kalibrierstandards schwankende Werte anzeigt, müssen Sie die Elektrode auswechseln.

1. Fassen Sie den Ring mit trockenen Händen so an, dass der Sensor zu Ihnen zeigt. Drehen Sie den Ring im Uhrzeigersinn. Heben Sie den Ring auf, weil Sie ihn später wieder brauchen.
2. Ziehen Sie das alte Sensormodul vom Tester ab.
3. Richten Sie die vier Laschen an dem neuen Modul zu den vier Vertiefungen am Tester aus.
4. Schieben Sie das Modul behutsam in die Vertiefungen, bis es einrastet. Drücken Sie den kleineren O-Ring ganz auf das neue Sensormodul. Schieben Sie den anderen O-Ring auf das Modul und schrauben Sie ihn gegen den Uhrzeigersinn fest.

**Hinweis:** Nach einem Sensorwechsel müssen Sie Ihren Tester kalibrieren, bevor Sie Messungen durchführen können.

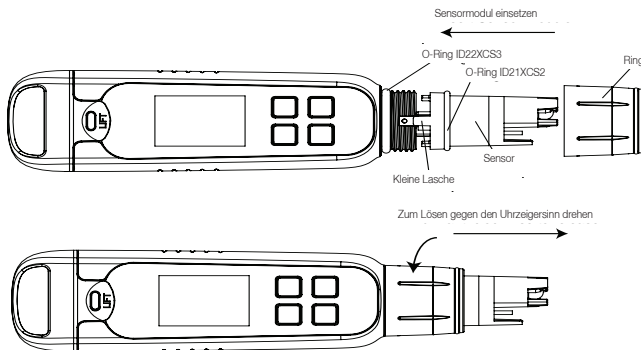

## Gewährleistung

Für dieses Gerät wird eine Garantie gegen Herstellungsfehler für ein Jahr ab dem Kaufzeitpunkt gewährt.

## Produktücksendung

Bevor Sie ein Produkt aus jeglichen Gründen einsenden, müssen Sie von Ihrem Händler eine Genehmigung anfordern. Geben Sie dabei an, aus welchem Grund Sie das Produkt/die Produkte einsenden möchten.

Wir behalten uns das Recht vor, Verbesserungen in Design, Bau und Aussehen von Produkten ohne Ankündigung vorzunehmen. Preise können ohne Ankündigung geändert werden.

Spezifikation	Elite CTS
<b>Leitfähigkeit</b>	
Leitfähigkeitsbereich	0,0 bis 200,0 $\mu$ S, 200 bis 2000 $\mu$ S, 2,00 bis 20,00 mS
Auflösung	0,1 $\mu$ S, 1 $\mu$ S, 0,01 mS
Relative Genauigkeit	$\pm$ 1 % der vollen Skala
Normalisierungstemperatur	25,0 °C (77 °F)
Temperaturkoeffizient	0,0 % bis 10,0 %
Kalibrierpunkte	Bis zu 3 Punkte
<b>TDS</b>	
TDS-Bereich	0,0 bis 100,0 ppm 100 bis 1000 ppm 0,10 bis 10,00 ppt (TDS-Faktor 0,5)
Auflösung	0,1 ppm, 1 ppm, 0,01 ppt
Relative Genauigkeit	$\pm$ 1 % der vollen Skala
Kalibrierpunkte	Bis zu 3 Punkte
TDS-Faktor	0,40 bis 1,00 (wählbar)
<b>Salinität</b>	
Salinitätsbereich	0,00 bis 10,00 ppt
Auflösung	0,10 ppt
Relative Genauigkeit	$\pm$ 1 % der vollen Skala
Kalibrierpunkte	Einer
<b>Temperatur</b>	
Temperaturbereich	0 °C bis 60 °C 32,0 °F bis 140,0 °F
Temperaturauflösung	0,1 °C / 0,1 °F
Temperaturgenauigkeit	von 0 °C bis 50 °C ( $\pm$ 0,5 °C/ $\pm$ 0,9 °F + 1 LSD); von 50 °C bis 60 °C ( $\pm$ 1,0 °C/ $\pm$ 1,8 °F + 1 LSD)
Temperatenausgleich	Ja (Automatischer Temperatenausgleich)
<b>Allgemeines</b>	
Anzeige	Grafik, Punktmatrix 80x100 Pixel
Automatisches Ausschalten	8,5 Minuten (ab dem letzten Drücken einer Taste)
Zurücksetzen	Auf die Standardeinstellungen des Benutzers/Auf Werkseinstellungen
Anforderung an die Stromversorgung	Vier AAA 1,5 V Batterien
Lebensdauer der Batterien	> 150 Stunden
Wasserdichtheit	IP67



# French

Ce mode d'emploi concerne l'analyseur Elite CTS.

## Installation et désinstallation des piles

L'analyseur Elite CTS utilise quatre piles AAA de 1,5 V.

1. En maintenant l'analyseur à une main, faites glisser votre pouce pour ôter le loquet frontal.
2. En continuant de maintenir l'analyseur, faites glisser l'autre pouce pour ôter le loquet arrière.
3. Une fois les deux loquets ôtés, faites glisser verticalement le couvercle du compartiment des piles pour le retirer de l'analyseur. Le couvercle est ainsi libéré.
4. Pour insérer la plaque du compartiment des piles, alignez les petites pattes sur les nervures de guidage du boîtier. Voir figure 2.
5. Pour verrouiller la plaque du compartiment des piles, appuyez dessus et faites-la glisser comme illustré sur la figure 3.
6. Pour libérer la plaque, poussez la patte comme illustré sur la figure 4.

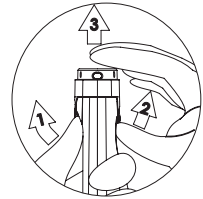

Figure 1 : retrait du couvercle du compartiment des piles



Figure 2 : Poussez pour déverrouiller



Figure 3 : Aligner les onglets



Figure 4 : Poussez vers le bas pour verrouiller

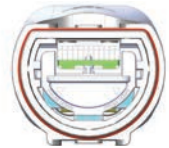

Figure 5 : position de déverrouillage de la plaque du compartiment des piles









Figure 6 : position de verrouillage de la plaque du compartiment des piles

## Pour commencer





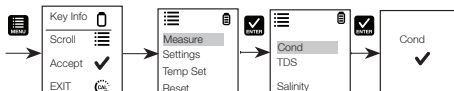

L'analyseur Elite CTS a été étalonné en usine et est en général immédiatement opérationnel. Cependant, après des périodes prolongées de non-utilisation, il est préférable de retirer le capuchon du capteur et de laisser tremper le capteur dans de l'eau tiède pendant environ 10 minutes. Avant de prendre des mesures, il est recommandé d'effectuer périodiquement un étalonnage avec des étalons certifiés pour améliorer la précision.

## Réglage des paramètres de mesure

1. Appuyez sur  pour mettre l'analyseur sous tension.
2. Appuyez sur  pour accéder à la fenêtre de configuration. Appuyez sur  pour sélectionner l'option Mesure (Mesure). L'écran affiche les options Cond (Conductivité), TDS et Salinity (Salinité).
3. Faites défiler le menu vers le bas en appuyant sur  pour basculer entre les options Cond (Conductivité), TDS et Salinity (Salinité). Appuyez sur  pour sélectionner l'option Cond (Conductivité).
4. Sur l'écran, le symbole  s'affiche à côté de la mesure sélectionnée.







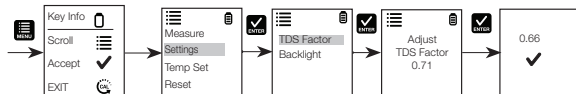



## Réglage du facteur TDS

1. Appuyez sur  pour accéder à la fenêtre de configuration. Faites défiler le menu vers le bas en appuyant sur  pour sélectionner l'option Settings (Paramètres).
2. Appuyez sur  pour sélectionner les paramètres. L'écran affiche les options TDS Factor (Facteur TDS) et Backlight (Rétroéclairage).
3. Appuyez sur  pour sélectionner le réglage usine TDS par défaut ou sur  pour ajuster le réglage.
4. Appuyez sur  pour confirmer la sélection du réglage. Sur l'écran, le symbole  s'affiche à côté du facteur TDS.







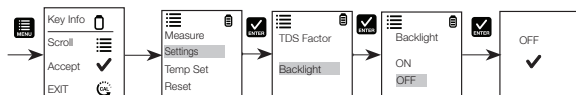

## Sélection des paramètres de rétroéclairage de l'analyseur CTS

1. Appuyez sur  pour accéder à la fenêtre de configuration. Faites défiler le menu vers le bas en appuyant sur  pour sélectionner l'option Settings (Paramètres).
2. Appuyez sur  pour sélectionner l'option Settings (Paramètres). L'écran affiche les options TDS Factor (Facteur TDS) et Backlight (Rétroéclairage).
3. Faites défiler le menu vers le bas en appuyant sur  pour basculer entre les options TDS Factor (Facteur TDS) et Backlight (Rétroéclairage). Appuyez sur  pour sélectionner l'option Backlight (Rétroéclairage).
4. L'écran affiche les options ON (MARCHÉ) et OFF (ARRÊT). Faites défiler le menu vers le bas en appuyant sur  pour basculer entre les options ON (MARCHÉ) et OFF (ARRÊT). Lorsque l'option Backlight (Rétroéclairage) est configurée sur ON (MARCHÉ), la lisibilité est améliorée dans des conditions de faible luminosité.
5. Appuyez sur  pour sélectionner l'option de rétroéclairage souhaitée. Sur l'écran, le symbole  s'affiche à côté de l'option de rétroéclairage sélectionnée.







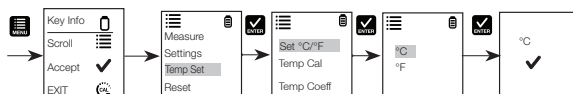

## Sélection du réglage de température de l'analyseur CTS

1. Appuyez sur  pour accéder à la fenêtre de configuration. Faites défiler le menu vers le bas en appuyant sur  pour sélectionner l'option Temp Set (Réglage de température). Appuyez sur  pour sélectionner le menu Temp Set (Réglage de température). L'écran affiche les options Set °C/°F (Réglage sur °C/°F), Temp Cal (Étalonnage de la température) et Temp Coeff (Coefficient de température).
2. Appuyez sur  pour sélectionner l'option Set °C/°F (Réglage sur °C/°F). Faites défiler le menu vers le bas en appuyant sur  pour basculer entre les options °C et °F.
3. Appuyez sur  pour sélectionner l'unité de température. Sur l'écran, le symbole  s'affiche à côté du réglage de température sélectionné.









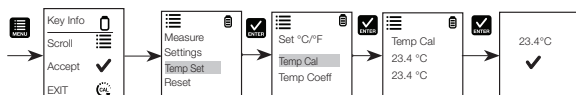

## Étalonnage de la température

1. Appuyez sur  pour accéder à la fenêtre de configuration. Faites défiler le menu vers le bas en appuyant sur  pour sélectionner l'option Temp Set (Réglage de température).
2. Appuyez sur  pour sélectionner le menu Temp Set (Réglage de température). L'écran affiche les options Set °C/°F (Réglage sur °C/°F), Temp Cal (Étalonnage de la température) et Temp Coeff (Coefficient de température).
3. Faites défiler le menu vers le bas en appuyant sur  pour basculer entre les options Set °C/°F (Réglage sur °C/°F), Temp Cal (Étalonnage de la température) et Temp Coeff (Coefficient de température). Appuyez sur  pour sélectionner le menu Temp Cal (Étalonnage de la température).
4. Le bloc d'affichage inférieur indique la température actuelle en fonction du dernier écart prédéfini et le bloc d'affichage supérieur indique la température actuelle en fonction de l'étalonnage d'usine par défaut.
5. Faites tremper l'analyseur dans une solution dont vous connaissez la température et patientez jusqu'à ce que le capteur de température intégré se stabilise.
6. Appuyez sur  pour régler la valeur de température ou appuyez sur  pour faire de la valeur étalonnée la nouvelle valeur de température de la solution.

**Remarque :** pour quitter ce programme sans confirmer l'étalonnage, appuyez sur .



## Coefficient de température



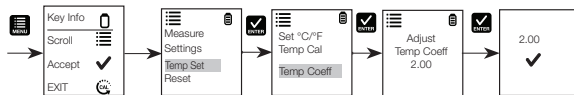

1. Appuyez sur  pour accéder à la fenêtre de configuration. Faites défiler le menu vers le bas en appuyant sur  pour sélectionner l'option Temp Set (Réglage de température).
2. Appuyez sur  pour sélectionner le menu Temp Set (Réglage de température). L'écran affiche les options Set °C/°F (Réglage sur °C/°F), Temp Cal (Étalonnage de la température) et Temp Coeff (Coefficient de température).
3. Faites défiler le menu vers le bas en appuyant sur  pour basculer entre les options Set °C/°F (Réglage sur °C/°F), Temp Cal (Étalonnage de la température) et Temp Coeff (Coefficient de température).
4. Appuyez sur  pour sélectionner l'option Temp Coeff (Coefficient de température) ou sur  pour l'ajuster.
5. Appuyez sur  pour confirmer la valeur Temp Coeff (Coefficient de température). La nouvelle valeur est automatiquement confirmée par le symbole .



## Étalonnage des valeurs Cond (Conductivité), TDS ou Salinity (Salinité)

Pour de meilleurs résultats, avant de prendre des mesures, il est recommandé d'effectuer périodiquement un étalonnage avec des étalons précis. Utilisez une valeur de référence d'étalonnage proche de la valeur d'échantillonnage prévue. L'analyseur conservera une valeur d'étalonnage dans chaque mode (conductivité, TDS, salinité) lorsque l'instrument sera mis hors tension. La valeur de conductivité peut être étalonnée automatiquement ou manuellement, tandis que les valeurs de TDS et de salinité nécessitent un étalonnage manuel. L'analyseur démarre dans le même mode de mesure que celui dans lequel il se trouvait avant sa mise hors tension. Consultez la section "Réglage des paramètres de mesure de l'analyseur Elite CTS" pour modifier le paramètre souhaité.

## Étalonnage automatique de la conductivité

1. Ôtez le bouchon et appuyez sur  pour allumer l'analyseur.
2. Faites tremper le capteur dans au moins 30 mm de solution étalon.
3. Mélangez doucement et appuyez sur  pour commencer l'étalonnage.
4. L'écran affiche CAL (ÉTAL.) suivi de la valeur par défaut. L'icône CAL est affichée à l'écran en mode d'étalonnage.
5. Si la mesure se trouve dans la plage d'étalonnage des étalons automatiquement reconnus : 80 (84  $\mu\text{S}/\text{cm}$ ), 1 410 (1 413  $\mu\text{S}/\text{cm}$ ) ou 12,90 (12.88 mS/cm), l'icône  est affichée lorsque la valeur de référence d'étalonnage automatique a été détectée.
6. Appuyez sur  pour accepter la solution étalon de conductivité automatique et terminer l'étalonnage.
7. L'affichage retourne à la fenêtre de mesure.

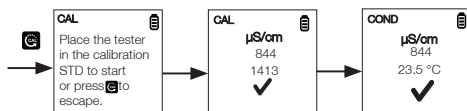



## Étalonnage manuel

Lorsque la valeur de conductivité se trouve en dehors de la plage d'étalonnage des étalons de conductivité automatiques ou lorsque la valeur de TDS ou de salinité est utilisée, l'analyseur nécessitera un ajustement manuel.

1. Répétez les étapes 1 à 4 à partir de la section "Étalonnage automatique de la conductivité".
2. Appuyez sur  pour régler manuellement la valeur sur la mesure souhaitée.



**Remarque :** le réglage diminuera uniquement, cependant, il finira par revenir à la valeur la plus élevée disponible après avoir diminué de 40 % par rapport à la valeur initiale.

3. Appuyez sur  pour accepter et terminer l'étalonnage lorsque la valeur souhaitée est sélectionnée.
4. Pour annuler l'étalonnage, appuyez sur  pour quitter.
5. Une fois que l'étalonnage est terminé et que l'utilisateur a accepté les modifications, la fenêtre de mesure affiche le relevé étalonné.

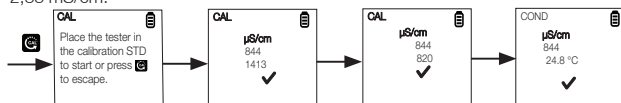
**Remarque:** les solutions étalons de conductivité automatiques sont celles de 84  $\mu\text{S}/\text{cm}$ , 1 413  $\mu\text{S}/\text{cm}$  et 2,88 mS/cm.



## Mesure de la valeur de CTS

1. Appuyez sur  pour allumer l'analyseur s'il est éteint.
2. Immergez l'électrode de 2 à 3 cm dans la solution d'essai. Mélangez et laissez le relevé se stabiliser. L'icône de la minuterie clignote pendant le processus. Une fois le relevé stabilisé, la minuterie cesse de clignoter et  s'affiche pour indiquer la stabilité de la lecture.





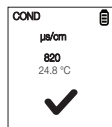

**ATTENTION :** l'analyse d'échantillons secs n'est pas précise et peut entraîner l'endommagement ou la rupture du capteur. Les sols doivent être humides et ne pas contenir de particules qui pourraient rayer le capteur en verre. L'application d'une force excessive sur les échantillons secs peut briser le verre.

3. Notez la valeur de CTS ou appuyez sur  pour figer le relevé. Pour débloquer le relevé, appuyez à nouveau sur .
4. Appuyez sur  pour éteindre l'analyseur. Si vous n'appuyez pas sur un bouton pendant 8,5 minutes, l'analyseur s'éteint automatiquement afin d'économiser les piles.



## Réinitialisation par l'utilisateur





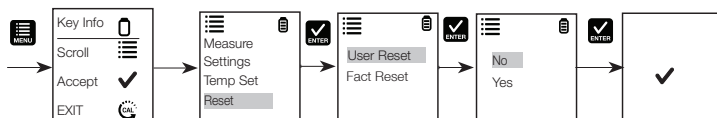



Vous pouvez réinitialiser l'étalonnage CTS sur les réglages par défaut de l'utilisateur à l'aide de la fonction de réinitialisation par l'utilisateur. La sélection du tampon et l'étalonnage de la température par l'utilisateur ne sont pas affectés par la fonction de réinitialisation par l'utilisateur.

1. Appuyez sur  sur pour accéder à la fenêtre de configuration. Faites défiler le menu vers le bas en appuyant sur  pour sélectionner l'option Reset (Réinitialisation). Appuyez sur  pour sélectionner l'option Reset (Réinitialisation). L'écran affiche les options User Reset (Réinitialisation par l'utilisateur) et Fact Reset (Réinitialisation des paramètres d'usine).
2. Appuyez sur  pour sélectionner l'option User Reset (Réinitialisation par l'utilisateur).
3. L'écran affiche automatiquement les options No (Non) et Yes (Oui). Faites défiler le menu vers le bas en appuyant sur  pour basculer entre les options No (Non) et Yes (Oui).
4. Appuyez sur  pour confirmer votre choix. Sur l'écran, le symbole  s'affiche à côté de l'option de réinitialisation par l'utilisateur.



## Réinitialisation des paramètres d'usine

Vous pouvez réinitialiser l'étalonnage CTS aux réglages par défaut définis en usine à l'aide de la fonction de réinitialisation des paramètres d'usine.

1. Appuyez sur  pour accéder à la fenêtre de configuration. Faites défiler le menu vers le bas en appuyant sur  pour sélectionner l'option Reset (Réinitialisation). Appuyez sur  pour sélectionner l'option Reset (Réinitialisation). L'écran affiche les options User Reset (Réinitialisation par l'utilisateur) et Fact Reset (Réinitialisation des paramètres d'usine).
2. Faites défiler le menu vers le bas en appuyant sur  pour basculer entre les réinitialisations. Appuyez sur  pour sélectionner l'option Fact Reset (Réinitialisation des paramètres d'usine).
3. L'écran affiche automatiquement les options No (Non) et Yes (Oui). Faites défiler le menu vers le bas en appuyant sur  pour basculer entre les options No (Non) et Yes (Oui).
4. Appuyez sur  pour confirmer votre choix. Sur l'écran, le symbole  s'affiche à côté de l'option de réinitialisation des paramètres d'usine.

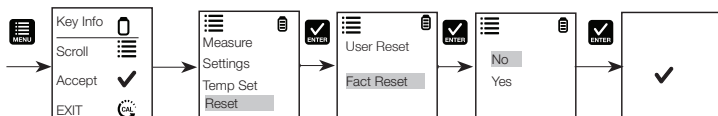

## Fonction d'exécution en continu

Cette fonction vous permet de figer l'écran pour une observation retardée.

1. Appuyez sur le bouton  pour figer la mesure.
2. Appuyez à nouveau sur  pour libérer la mesure.



## Entretien du capteur

1. Veillez toujours à ce que les électrodes du capteur restent propres. Rincez les électrodes avec de l'eau déminéralisée et essuyez-les avec un chiffon propre avant de les ranger dans leur capuchon de protection. Pour les électrodes cupules, retirez la cupule et l'insert en plastique blanc pour nettoyer soigneusement les solutions visqueuses. Ne rayez jamais les électrodes avec une substance dure.
2. Pour obtenir de meilleures performances, laissez tremper l'électrode dans de l'alcool pendant 10 à 15 minutes et rincez avec de l'eau déminéralisée avant de commencer le processus de mesure. Cela permet d'éliminer la saleté et les taches d'huile présentes sur l'électrode qui peuvent fausser la précision des mesures.

## Remplacement du capteur

Le remplacement du module capteur vous reviendra beaucoup moins cher que l'achat d'un nouvel analyseur. En cas d'échec de l'étalonnage de l'analyseur ou de fluctuation des relevés avec des solutions étalons, vous devez remplacer l'électrode.

1. Avec les mains sèches, saisissez l'anneau en vous tenant face au capteur. Tournez l'anneau dans le sens des aiguilles d'une montre. Mettez l'anneau de côté en vue d'une utilisation ultérieure.
2. Retirez l'ancien module capteur de l'analyseur.
3. Alignez les quatre languettes sur le nouveau module afin qu'elles correspondent aux quatre fentes de l'analyseur.
4. Insérez délicatement le module dans les fentes pour le mettre en place. Insérez entièrement le joint torique le plus petit dans le nouveau module capteur. Poussez l'autre joint torique sur le module et mettez-le en place en le tournant fermement dans le sens inverse des aiguilles d'une montre.

**Remarque :** après avoir remplacé un capteur, vous devez étalonner à nouveau l'analyseur avant de prendre des mesures.

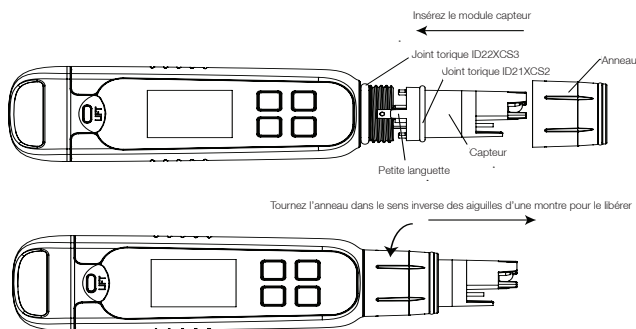

## Garantie

Cet instrument est couvert par une garantie contre les défauts de fabrication pendant une période d'un an à compter de la date d'achat.

## Retour d'articles

Vous devez obtenir une autorisation auprès de votre distributeur avant de retourner des articles pour quelque motif que ce soit. Lorsque vous demandez une autorisation, veuillez fournir des informations concernant le motif de retour de l'article ou des articles.

Nous nous réservons le droit d'améliorer la conception, la construction et l'apparence des produits sans préavis. Les prix sont sujets à modification sans préavis.

Spécification	Elite CTS
<b>Conductivité</b>	
Plage de conductivité	0,0 à 200,0 $\mu$ S, 200 à 2 000 $\mu$ S et 2,00 à 20,00 mS
Résolution	0,1 $\mu$ S, 1 $\mu$ S et 0,01 mS
Précision relative	$\pm$ 1 % de la pleine échelle
Température de normalisation	25,0 °C (77 °F)
Coefficient de température	0,0 % à 10,0 %
Points d'étalonnage	Jusqu'à 3 points
<b>TDS</b>	
Plage TDS	0,0 à 100,0 ppm, 100 à 1 000 ppm et 0,10 à 10,00 ppt (du facteur TDS 0,5)
Résolution	0,1 ppm, 1 ppm et 0,01 ppt
Précision relative	$\pm$ 1 % de la pleine échelle
Points d'étalonnage	Jusqu'à 3 points
Facteur TDS	0,40 à 1,00 (sélectionnable)
<b>Salinité</b>	
Plage de salinité	0,00 à 10,00 ppt
Résolution	0,10 ppt
Précision relative	$\pm$ 1 % de la pleine échelle
Points d'étalonnage	Un
<b>Température</b>	
Plage de températures	0°C à 60°C 32,0°F à 140,0°F
Résolution de la température	0,1°C / 0,1°F
Précision de la température	de 0°C à 50°C ( $\pm$ 0,5°C / $\pm$ 0,9°F + 1 LSD) ; de 50°C à 60°C ( $\pm$ 1,0°C / $\pm$ 1,8°F + 1 LSD)
Compensation thermique	Oui (Compensation automatique de la température)
<b>Général</b>	
Affichage	Graphique, matriciel, 80 x 100 pixels
Arrêt automatique	Après 8,5 minutes (à compter de la dernière pression sur un bouton)
Réinitialisation	Par l'utilisateur / aux paramètres d'usine
Alimentation	Quatre piles AAA de 1,5 V
Autonomie des piles	> 150 heures
Étanchéité	IP67

# DUTCH

Deze instructiehandleiding is van toepassing op de Elite CTS Tester.

## Plaatsen en uitnemen van de batterij

De Elite CTS-tester maakt gebruik van vier AAA-batterijen van 1,5 V.

1. Houd de tester met één hand vast en schuif uw duim naar boven om de vergrendeling aan de voorkant los te maken.
2. Terwijl u de tester vast blijft houden, schuift u uw andere duim aan de achterzijde naar boven om de vergrendeling aan de achterkant los te maken.
3. Wanneer beide vergrendelingen zijn losgemaakt, schuift u het batterijklepje in de verticale richting van de tester. Hiermee wordt het batterijklepje verwijderd.
4. Om de batterijplaat in te zetten brengt u de lipjes op één lijn met de ribben op de behuizing. Zie afbeelding 2.
5. Om de batterijplaat vast te zetten drukt u deze naar beneden en schuift u de lip naar voren, zoals weergegeven in afbeelding 3.
6. Om de batterijplaat los te maken duwt u de lip naar achteren, zoals weergegeven in afbeelding 4.

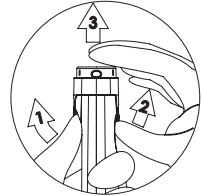

Afbeelding 1: Verwijderen van het batterijklepje

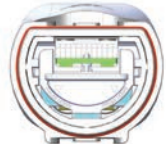

Afbeelding 5: Ontgrendelde positie van batterijplaat

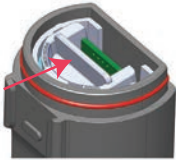

Afbeelding 2: Duw om te ontgrendelen Duw om te ontgrendelen

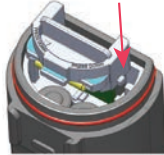

Afbeelding 3: Tabbladen uitlijnen



Afbeelding 4: Duw omlaag om te vergrendelen

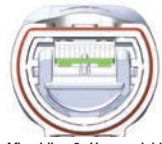

Afbeelding 6: Vergrendelde positie van batterijplaat

## Aan de slag

De Elite CTS-tester is in de fabriek gekalibreerd en werkt buiten de behuizing doorgaans goed. Als de tester echter gedurende een lange periode niet is gebruikt, is het beter om de sensorop te verwijderen en de sensor ongeveer 10 minuten in warm leidingwater onder te dompelen. Voordat er metingen worden gedaan, wordt aanbevolen om de tester te kalibreren met gecertificeerde controlevloeistoffen. Door regelmatig te kalibreren kan de beste nauwkeurigheid worden verkregen.

## Instellen van de meetparameters

1. Druk op om de tester aan te zetten.
2. Druk op om het instelvenster te openen. Druk op om Measure (meten) te kiezen. Het scherm toont Cond (geleidbaarheid), TDS en Salinity (saliniteit).
3. Scroll door op te drukken en kies tussen Cond, TDS of Salinity. Druk op om Cond te kiezen.
4. Het scherm toont de gekozen maateenheid met een .

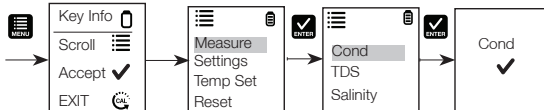



## Instellen van de TDS-factor

1. Druk op om het instelvenster te openen. Scroll door op te drukken en kies Settings (instellingen).
2. Druk op om Settings te kiezen. Het scherm toont TDS Factor en Backlight (achtergrondverlichting).
3. Druk op om de standaard fabrieksinstelling van TDS te kiezen of om de instelling aan te passen.
4. Druk op om de keuze van de instelling te bevestigen. Het scherm toont de gekozen stel TDS factor met een ✓.

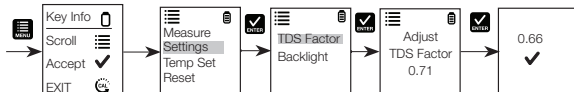

## Instellingen achtergrondverlichting

1. Druk op om het instelvenster te openen. Scroll door op te drukken en kies Settings.
2. Druk op om Settings te kiezen. Het scherm toont TDS Factor en Backlight.
3. Scroll door op te drukken en kies tussen TDS Factor en Backlight. Druk op om Backlight te kiezen.
4. Het scherm toont ON (aan) en OFF (uit). Scroll door op te drukken en kies tussen ON en OFF. Backlight ON verhoogt de leesbaarheid in omstandigheden met weinig licht.
5. Druk op om de gewenste optie voor achtergrondverlichting te kiezen. Het scherm toont de gekozen optie voor achtergrondverlichting met een ✓.

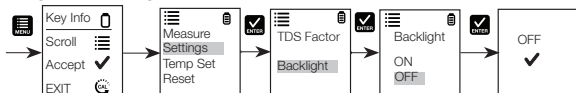

## Temperatuurinstellingen

1. Druk op om het instelvenster te openen. Scroll door op te drukken en kies Temp Set (temperatuurinstelling). Druk op om Temp Set te kiezen. Het scherm toont Set (instellen) °C/°F, Temp Cal (temperatuurkalibratie) en Temp Coeff (temperatuurcoëfficiënt).
2. Druk op om Set °C/°F te kiezen. Scroll door op te drukken en kies tussen °C en °F.
3. Druk op om de temperatureenheid te kiezen. Het scherm toont de gekozen temperatuurinstelling met een ✓.

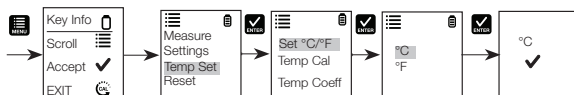

## Temperatuurkalibratie

1. Druk op om het instelvenster te openen. Scroll door op te drukken en kies Temp Set.
2. Druk op om Temp Set te kiezen. Het scherm toont Set °C/°F, Temp Cal en Temp Coeff.
3. Scroll door op te drukken en kies tussen Set °C/°F, Temp Cal en Temp Coeff. Druk op om Temp Cal te kiezen.
4. De onderste waarde is de actuele gemeten temperatuurwaarde op basis van de laatst ingestelde compensatiewaarde en de bovenste waarde is de actuele gemeten temperatuurwaarde op basis van de standaard fabriekskalibratie.
5. Dompel de tester in een oplossing met een bekende temperatuur en geef de ingebouwde temperatuursensor de tijd om zich te stabiliseren.

6. Druk op om de temperatuurwaarde bij te stellen of druk op om de gekalibreerde waarde als de nieuwe temperatuurwaarde van de oplossing te bevestigen.

**Let op:** Om dit programma te verlaten zonder bevestiging van de kalibratie drukt u op .

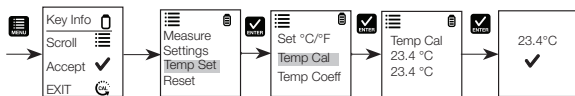

## Temperatuurcoëfficiënt

1. Druk op om het instelvenster te openen. Scroll door op te drukken en kies Temp Set.
2. Druk op om Temp Set te kiezen. Het scherm toont Set °C/°F, Temp Cal en Temp Coeff.
3. Scroll door op te drukken en kies tussen Set °C/°F, Temp Cal en Temp Coeff.
4. Druk op om Temp Coeff te kiezen of om de Temp Coeff af te stellen.
5. Druk op om de waarde van Temp Coeff te bevestigen. De nieuwe waarde wordt automatisch met een bevestigd.

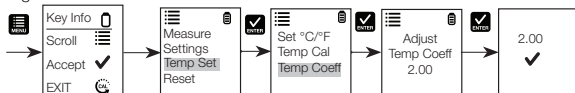

## Kalibratie voor geleidbaarheid, TDS of saliniteit

Voor de beste resultaten wordt aanbevolen om vóór het meten met een correcte controlevloeistof te kalibreren. Dit dient regelmatig te gebeuren. Gebruik de waarde van de kalibratiecontrolevloeistof die dicht bij de waarde van uw beoogde monster ligt. De tester zal in iedere modus (geleidbaarheid, TDS, saliniteit) één kalibratiewaarde bewaren wanneer het toestel is uitgeschakeld. De waarde voor geleidbaarheid kan automatisch of handmatig worden gekalibreerd, terwijl de waarden voor TDS en saliniteit een handmatige kalibratie vereisen. De tester zal in de meetmodus beginnen die werd gebruikt toen hij werd uitgeschakeld. Zie "Instellen van de meetparameters" van de Elite CTS om de gewenste parameter te veranderen.

## Automatische kalibratie voor geleidbaarheid

1. Verwijder de dop en druk op om het toestel in te schakelen.
2. Dompel de sensor in ten minste 30 mm kalibratiecontrolevloeistof.
3. Roer de sensor voorzichtig en druk op om de kalibratie te starten.
4. Op het scherm wordt nu CAL (kalibreren) weergegeven, gevolgd door de standaardwaarde. Tijdens het kalibreren wordt op het scherm CAL weergegeven.
5. Als de waarde zich binnen het kalibratiebereik van de controlevloeistoffen bevindt waarvan de waarden automatisch worden herkend (80 [84  $\mu$ S/cm], 1410 [1413  $\mu$ S/cm] of 12,90 [12,88 mS/cm]), wordt het pictogram weergegeven als eenmaal de waarde van de kalibratiecontrolevloeistof automatisch is gedetecteerd.
6. Druk op om de automatische waarde van de controlevloeistof voor geleidbaarheid te accepteren en voltooi de kalibratie.
7. Op het scherm wordt het meetvenster weer weergegeven.

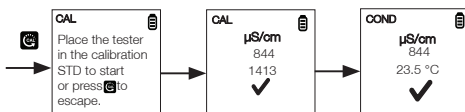



## Handmatige kalibratie

Als de waarde van de geleidbaarheid zich buiten het kalibratiebereik van de automatisch gedetecteerde waarden van de controlevloeistoffen voor geleidbaarheid bevindt of als TDS of saliniteit wordt gebruikt, is handmatige bijstelling van de tester nodig.

1. Herhaal stap 1 tot 4 van "Automatische kalibratie voor geleidbaarheid".
2. Druk op  om de waarde handmatig bij te stellen tot de gewenste waarde.



**Let op:** De bijstelling zal alleen een afname betreffen, maar zal uiteindelijk als onderdeel van een cyclus overgaan op de hoogst beschikbare waarde nadat de waarde met 40% is afgenomen ten opzichte van de beginwaarde.

3. Druk op  om de kalibratie te accepteren en te voltooien wanneer de gewenste waarde is gekozen.
4. Om de kalibratie te annuleren drukt u op , waardoor u teruggaat.
5. Zodra de kalibratie is voltooid en de gebruiker de veranderingen heeft geaccepteerd, zal het meetvenster de gekalibreerde waarde tonen.

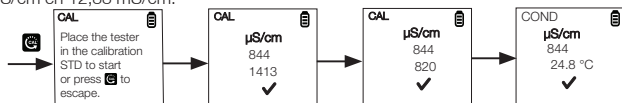
**Let op:** De automatisch gedetecteerde waarden van de controlevloeistoffen voor geleidbaarheid zijn 84  $\mu\text{S/cm}$ , 1413  $\mu\text{S/cm}$  en 12,88  $\text{mS/cm}$ .





## Meten met de CTS

1. Druk op  om de tester aan te zetten als deze is uitgeschakeld.
2. Dompel de elektrode ongeveer 2 tot 3 cm in de testoplossing. Roer en laat de waarde zich stabiliseren. Gedurende deze periode knippert het timerpictogram. Zodra de waarde zich heeft gestabiliseerd stopt de timer met knipperen en verschijnt  om de stabiliteit van de waarde aan te geven.

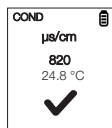
**VOORZICHTIG:** Het testen van droge monsters is niet nauwkeurig en kan leiden tot beschadiging of breken van de sensor. Bodemonsters moeten vochtig zijn en vrij van deeltjes die krassen in de glazen sensor kunnen maken. Teveel druk uitoefenen op droge monsters kan leiden tot breken van het glas.



3. Noteer de waarde van de CTS of druk op  om de waarde stil te zetten. Om de waarde vrij te geven drukt u weer op .
4. Druk op  om de tester uit te zetten. Als u 8,5 minuten lang geen toets indrukt, zal de tester automatisch worden uitgeschakeld om de batterijen te sparen.

## Resetten door de gebruiker





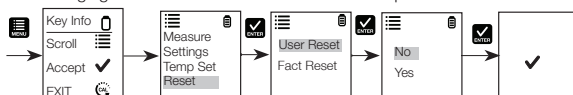



U kunt de kalibratie van de CTS resetten naar de standaardinstellingen van de gebruiker door de functie 'resetten door de gebruiker' te gebruiken. De bufferkeuze en de temperatuurkalibratie door de gebruiker worden niet beïnvloed door de functie 'resetten door de gebruiker'.

1. Druk op  om het instelvenster te openen. Scroll door op  te drukken en kies Reset (resetten). Druk op  om Reset te kiezen. Het scherm toont User Reset (resetten door de gebruiker) en Fact Reset (fabrieksreset).
2. Druk op  om User Reset te kiezen.
3. Het scherm toont automatisch No (nee) en Yes (ja). Scroll door op  te drukken en kies tussen No en Yes.
4. Druk op  ter bevestiging van No of Yes. Het scherm toont de optie voor resetten door de gebruiker met een .



## Fabrieksreset

U kunt de kalibratie van de CTS resetten naar de resetstandaardwaarde van de fabriek door de functie 'fabrieksreset' te gebruiken.

1. Druk op  om het instelvenster te openen. Scroll door op  te drukken en kies Reset. Druk op  om Reset te kiezen. Het scherm toont User Reset (resetten door de gebruiker) en Fact Reset (fabrieksreset).
2. Scroll door op  te drukken en kies tussen de verschillende opties voor resetten. Druk op  om Fact Reset te kiezen.
3. Het scherm toont automatisch No en Yes. Scroll door op  te drukken en kies tussen No en Yes.
4. Druk op  ter bevestiging van No of Yes. Het scherm toont de optie voor fabrieksreset met een .



## HOLD (vasthoud)-functie

Met deze functie kunt u het scherm stilzetten voor een vertraagde waarneming.

1. Druk op de toets  om de meting stil te zetten.
2. Druk nogmaals op  om de meting weer vrij te geven.



## Onderhoud van de sensor

1. Houd de sensorelektroden altijd schoon. Spoel de elektroden met gedeïoniseerd water af en wrijf ze droog met een schone doek alvorens ze met de bijbehorende beschermdop te bewaren. Voor elektroden van het bekertype verwijdert u de witte plastic beker en plaatst u ze in volkomen schone viskeuze oplossingen. Zorg ervoor dat u met een harde substantie nooit krassen in de elektroden maakt.
2. Voor een betere werking dompelt u de elektrode gedurende 10 tot 15 minuten in alcohol en spoelt u deze, alvorens te beginnen met een meetprocedure, met gedeïoniseerd water af. Dit is om vuil en olievlekken op de elektrode te verwijderen, die de nauwkeurigheid van de metingen kunnen beïnvloeden.

## Vervanging van de sensor

U kunt de sensormodule vervangen voor een fractie van de prijs van een nieuwe tester. Als de tester niet meer gekalibreerd kan worden of bij de kalibratiecontrole vloeistoffen fluctuerende waarden geeft, moet u de elektrode vervangen.

1. Pak met droge handen de ring vast, terwijl de sensor naar u toe is gekeerd. Draai de ring rechtsom. Bewaar de ring voor later gebruik.
2. Trek de oude sensormodule van de tester af.
3. Breng de vier lipjes op de nieuwe module op één lijn met de vier gleuven op de tester, zodat ze daarin passen.
4. Duw de module voorzichtig in de gleuven zodat deze op zijn plaats komt te zitten. Duw de kleinere O-ring helemaal op de nieuwe sensormodule. Duw de andere O-ring over de module en schroef deze op zijn plaats door stevig linksom te draaien.

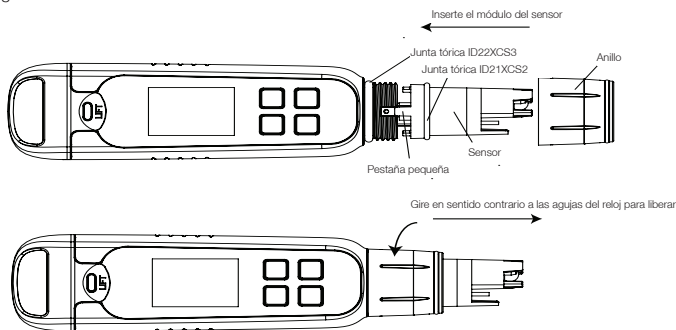

## Garantie

Dit hulpmiddel wordt geleverd met garantie tegen fabrieksfouten die gedurende één jaar geldig is vanaf de dag van aanschaf.

## Terugzenden van artikelen

U moet goedkeuring van uw distributeur krijgen alvorens u artikelen om wat voor reden ook terugzendt. Als u om goedkeuring vraagt, geef dan informatie over de reden waarom het artikel/de artikelen moeten worden teruggezonden.

We behouden ons het recht voor om zonder voorafgaande kennisgeving verbeteringen aan te brengen aan het ontwerp, de constructie en het uiterlijk van de producten. Prijzen kunnen zonder voorafgaande kennisgeving worden gewijzigd.

Specificatie	Elite CTS
<b>Geleidbaarheid</b>	
Geleidbaarheidsbereik	0,0 tot 200,0 $\mu$ S, 200 tot 2000 $\mu$ S, 2,00 tot 20,00 mS
Resolutie	0,1 $\mu$ S, 1 $\mu$ S, 0,01 mS
Relatieve nauwkeurigheid	$\pm$ 1% volledige schaal
Normalisatietemperatuur	25,0 °C (77 °F)
Temperatuurcoëfficiënt	0,0% tot 10,0%
Kalibratiepunten	Maximaal 3 punten
<b>TDS</b>	
TDS-bereik	0,0 tot 100,0 ppm 100 tot 1000 ppm 0,10 tot 10,00 ppt (van TDS-factor 0,5)
Resolutie	0,1 ppm, 1 ppm, 0,01 ppt
Relatieve nauwkeurigheid	$\pm$ 1% volledige schaal
Kalibratiepunten	Maximaal 3 punten
TDS Factor	0,40 tot 1,00 (kiesbaar)
<b>Saliniteit</b>	
Saliniteitsbereik	0,00 tot 10,00 ppt
Resolutie	0,10 ppt
Relatieve nauwkeurigheid	$\pm$ 1% volledige schaal
Kalibratiepunten	Eén
<b>Temperatuur</b>	
Temperatuurbereik	0 °C tot 60 °C 32,0 °F tot 140,0 °F
Temperatuurreolutie	0,1 °C / 0,1 °F
Temperatuurnauwkeurigheid	van 0 °C tot 50 °C ( $\pm$ 0,5 °C / $\pm$ 0,9 °F + 1 LSD); van 50 °C tot 60 °C ( $\pm$ 1,0 °C / $\pm$ 1,8 °F + 1 LSD)
Temperatuur-s compensatie	Ja (Automatische temperatuurcompensatie)
<b>Algemeen</b>	
Scherm	Grafische gegevensverwerking, puntenmatrix 80 x 100 pixel
Automatisch uit	8,5 minuten (vanaf de laatste toetsaanslag)
Resetten	Gebruiker / Fabriek
Stroomvereiste	Vier AAA-batterijen van 1,5 V
Levensduur van de batterijen	>150 uur
Waterdichtmaking	IP67

# SPANISH

Este manual de instrucciones es aplicable al analizador Elite CTS.

## Instalación y desinstalación de las pilas

El analizador Elite CTS utiliza cuatro pilas AAA de 1,5 V.

1. Sostenga el analizador con una mano y deslice el pulgar hacia adentro para soltar el pasador frontal.
2. Mientras sostiene el analizador, deslice el otro pulgar hacia adentro para soltar el pasador posterior.
3. Una vez sueltos ambos pasadores, deslice verticalmente la cubierta de las pilas hasta que salga del analizador. Esto retira la cubierta de las pilas.
4. Para insertar la placa de las pilas, alinee las pequeñas pestañas en las acanaladuras guía de la carcasa. Consulte la Figura 2.
5. Para bloquear la placa de las pilas, empuje hacia abajo y deslícela como se muestra en la figura 3.
6. Para liberarla, empuje hacia afuera la pestaña como se muestra en la figura 4.



Figura 1: Extracción de la cubierta de las pilas



Figura 2: Desbloquear

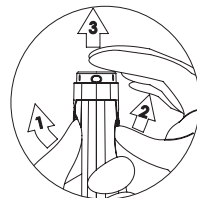

Figura 3: Alinear pestañas



Figura 4: Empuje hacia abajo para bloquear



Figura 5: Posición de desbloqueo de la placa de las pilas







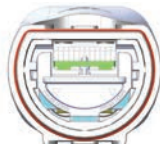

Figura 6: Posición de bloqueo de la placa de las pilas

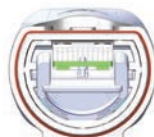
## Información básica





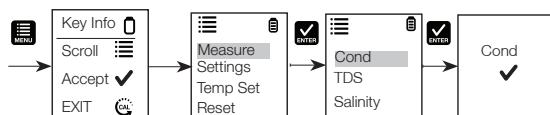

El analizador Elite CTS se ha calibrado en fábrica y habitualmente funciona bien desde el primer momento. Sin embargo, después de periodos prolongados de no usarlo, es mejor retirar la tapa del sensor y remojar el sensor en agua del grifo caliente durante 10 minutos aproximadamente. Antes de llevar a cabo las mediciones, se recomienda realizar una calibración periódica según los patrones certificados para obtener una mejor precisión.

## Configuración de los parámetros de medición

1. Pulse  para encender el analizador.
2. Pulse  para acceder a la ventana de configuración. Pulse  para seleccionar Measure (Medición). La pantalla muestra Cond (Conductividad), TDS (STD) y Salinity (Salinidad).
3. Desplácese hacia abajo pulsando  para alternar entre Cond (Conductividad), TDS (STD) y Salinity (Salinidad). Pulse  para seleccionar Cond (Conductividad).
4. La pantalla muestra la medida seleccionada con una .







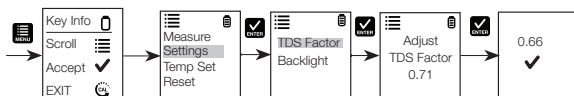



## Configuración del factor SDT

1. Pulse  para acceder a la ventana de configuración. Desplácese hacia abajo pulsando  para seleccionar Settings (Ajustes).
2. Pulse  para seleccionar Settings (Ajustes). La pantalla muestra TDS factor (Factor SDT) y Backlight (Retroiluminación).
3. Pulse  para seleccionar el ajuste SDT predeterminado o  para ajustar la configuración.
4. Pulse  para confirmar la selección del ajuste. La pantalla muestra el establecer el factor tds seleccionado con una .







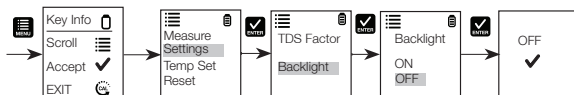

## Selección de ajustes de retroiluminación

1. Pulse  para acceder a la ventana de configuración. Desplácese hacia abajo pulsando  para seleccionar Settings (Ajustes).
2. Pulse  para seleccionar Settings (Ajustes). La pantalla muestra TDS factor (Factor SDT) y Backlight (Retroiluminación).
3. Desplácese hacia abajo pulsando  para alternar entre TDS Factor (Factor SDT) y Backlight (Retroiluminación). Pulse  para seleccionar Backlight (Retroiluminación).
4. La pantalla muestra ON (Encender) y OFF (Apagar). Desplácese hacia abajo pulsando  para alternar entre ON (Encender) y OFF (Apagar). La retroiluminación en ON aumenta la legibilidad en condiciones de poca luz.
5. Pulse  para seleccionar la opción de retroiluminación deseada. La pantalla muestra la opción de retroiluminación seleccionada con una .







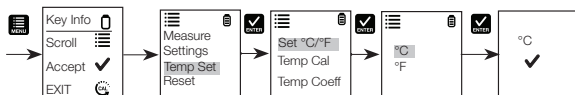

## De ajustes de temperatura

1. Pulse  para acceder a la ventana de configuración. Desplácese hacia abajo pulsando  para seleccionar Temp Set (Definir temperatura). Pulse  Intro para seleccionar Temp Set (Definir temperatura). La pantalla muestra Set °C/°F (Definir °C/°F), Temp Cal (Calibración de temperatura) y Temp Coeff (Coeficiente de temperatura).
2. Pulse  para seleccionar Set °C/°F (Definir °C/°F). Desplácese hacia abajo pulsando  para alternar entre °C y °F.
3. Pulse  para seleccionar la unidad de temperatura. La pantalla muestra el ajuste de temperatura seleccionado con una .











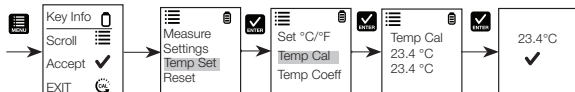

## Calibración de temperatura

1. Pulse  para acceder a la ventana de configuración. Desplácese hacia abajo pulsando  para seleccionar Temp Set (Definir temperatura).
2. Pulse  para seleccionar Temp Set (Definir temperatura). La pantalla muestra Set °C/°F (Definir °C/°F), Temp Cal (Calibración de temperatura) y Temp Coeff (Coeficiente de temperatura). Desplácese hacia abajo pulsando  para alternar entre Set °C/°F (Definir °C/°F), Temp Cal (Calibración de temperatura) y Temp Coeff (Coeficiente de temperatura).
3. Pulse  para seleccionar Temp Cal (Calibración de temperatura).
4. La pantalla inferior muestra la lectura de temperatura medida actual en base a la última compensación definida y la pantalla superior muestra la lectura de temperatura medida actual en base a la calibración predeterminada de fábrica.
5. Sumerja el analizador en una solución de temperatura conocida y espere un tiempo a que el sensor de temperatura integrado se establezca.
6. Pulse  para ajustar el valor de la temperatura o pulse  para confirmar el valor calibrado como el nuevo valor de temperatura de la solución.

**Nota:** Para salir de este programa sin confirmar la calibración, pulse .



## Coeficiente de temperatura



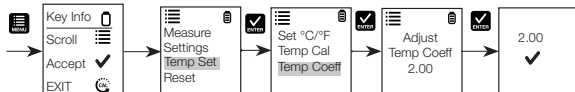

1. Pulse  para acceder a la ventana de configuración. Desplácese hacia abajo pulsando  para seleccionar Temp Set (Definir temperatura).
2. Pulse  para seleccionar Temp Set (Definir temperatura). La pantalla muestra Set °C/°F (Definir °C/°F), Temp Cal (Calibración de temperatura) y Temp Coeff (Coeficiente de temperatura).
3. Desplácese hacia abajo pulsando  para alternar entre Set °C/°F (Definir °C/°F), Temp Cal (Calibración de temperatura) y Temp Coeff (Coeficiente de temperatura).
4. Pulse  para seleccionar Temp Coeff (Coeficiente de temperatura) o  para ajustarlo.
5. Pulse  para confirmar el valor de Temp Coeff (Coeficiente de temperatura). El nuevo valor se confirma automáticamente con una .



## Calibración de conductividad, SDT o salinidad

Para obtener mejores resultados, se recomienda realizar una calibración periódica con un calibrador preciso antes de llevar a cabo la medición. Utilice el valor del calibrador que se asemeje al valor previsto de su muestra. El analizador guardará un valor de calibración en cada modo (conductividad, SDT y salinidad) cuando el instrumento se apague. El valor de conductividad puede calibrarse de forma automática o manual, mientras que los valores de SDT y salinidad precisan una calibración manual. El analizador empezará en el modo de medición en que se estaba utilizando en el momento de apagarse. Consulte "Configuración de los parámetros de medición de Elite CTS" para cambiar el parámetro deseado.

## Calibración automática para la conductividad

1. Retire la tapa y pulse  para encender el dispositivo.
2. Sumerja el sensor en al menos 30 mm de calibrador.
3. Agite suavemente y pulse  para iniciar la calibración.
4. La pantalla mostrará "CAL" (Calibración) seguido del valor predeterminado. "CAL" se indica en la pantalla durante el modo de calibración.
5. Si la lectura está dentro del rango de calibración de los calibradores automáticamente reconocidos, 80 ( $84 \mu\text{S/cm}$ ), 1410 ( $1413 \mu\text{S/cm}$ ) o 12,90 ( $12,88 \text{ mS/cm}$ ), se mostrará el icono  cuando se haya detectado el valor del calibrador automático.
6. Pulse  para aceptar el patrón de conductividad automático y terminar la calibración.
7. La pantalla vuelve a la ventana Measurement (Medición).

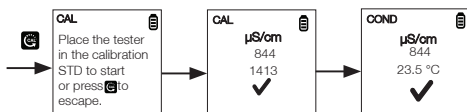



## Calibración manual

Si la lectura de conductividad está fuera del rango de calibración de los patrones de conductividad automática o si se utiliza SDT o salinidad, el analizador precisará un ajuste manual.

1. Repita los pasos del 1 al 4 de "Calibración automática para la conductividad".
2. Pulse  para ajustar manualmente el valor a la lectura deseada.



**Nota:** El ajuste únicamente disminuirá; sin embargo, el ajuste finalmente cambiará al valor más alto disponible después de disminuir un 40% del valor inicial.

3. Pulse  para aceptar y terminar la calibración cuando se seleccione el valor deseado.
4. Para cancelar la calibración, pulse  para salir.
5. Una vez que la calibración finalice y el usuario haya aceptado los cambios, la ventana de medición mostrará la lectura calibrada.

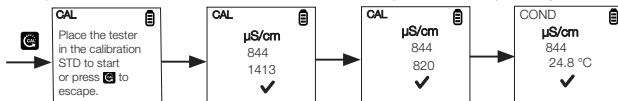
**Nota:** Los patrones de conductividad automática son  $84 \mu\text{S/cm}$ ,  $1413 \mu\text{S/cm}$  y  $12,88 \text{ mS/cm}$ .





## Medición de CTS

1. Pulse  para encender el analizador si está apagado.
2. Sumerja el electrodo aproximadamente de 2 cm a 3 cm en la solución de prueba. Agítelo y espere a que la lectura se estabilice. El icono del temporizador parpadeará durante este periodo. Una vez que se estabiliza la lectura, el temporizador deja de parpadear y aparecerá una  para indicar la estabilidad de la lectura.

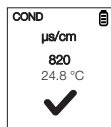





**PRECAUCIÓN:** El análisis de muestras secas no es preciso y puede provocar daños o roturas en el sensor. Los suelos deben estar húmedos y libres de partículas que puedan arañar el sensor de vidrio. Ejercer una fuerza excesiva en muestras secas puede provocar la rotura del vidrio.



3. Anote el valor de CTS o pulse  para congelar la lectura. Para desbloquear la lectura, pulse  de nuevo.
4. Pulse  para apagar el analizador. Si no pulsa ningún botón durante 8,5 minutos, el analizador se apagará automáticamente para ahorrar batería.

## Restablecimiento de valores de usuario





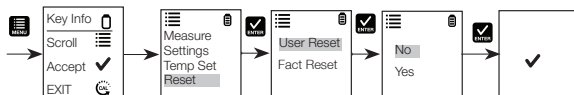



Puede reiniciar la calibración de CTS a los ajustes predeterminados del usuario empleando la función de restablecimiento de valores de usuario. La selección de tampones y la calibración de usuario de temperatura no se ven afectados por la función de restablecimiento de valores de usuario.

1. Pulse  para acceder a la ventana de configuración. Desplácese hacia abajo pulsando  para seleccionar Reset (Restablecer). Pulse  para seleccionar Reset (Restablecer). La pantalla muestra User Reset (Restablecimiento de valores de usuario) y Fact Reset (Restablecimiento de valores de fábrica).
2. Pulse  para seleccionar User Reset (Restablecimiento de valores de usuario).
3. La pantalla muestra automáticamente No y Yes (Sí). Desplácese hacia abajo pulsando  para alternar entre No y Yes (Sí).
4. Pulse  para confirmar No o Yes (Sí). La pantalla muestra la opción de restablecimiento de valores de usuario con una .



## Restablecimiento de valores de fábrica

Puede reiniciar la calibración de CTS al restablecimiento de valores de fábrica empleando la función Factory Reset (Restablecimiento de valores de fábrica).

1. Pulse  para acceder a la ventana de configuración. Desplácese hacia abajo pulsando  para seleccionar Reset (Restablecer). Pulse  para seleccionar Reset (Restablecer). La pantalla muestra User Reset (Restablecimiento de valores de usuario) y Fact Reset (Restablecimiento de valores de fábrica).
2. Desplácese hacia abajo pulsando  para alternar entre los restablecimientos. Pulse  para seleccionar Fact Reset (Restablecimiento de valores de fábrica).
3. La pantalla muestra automáticamente No y Yes (Sí). Desplácese hacia abajo pulsando  para alternar entre No y Yes (Sí).
4. Pulse  para confirmar No o Yes (Sí). La pantalla muestra la opción de restablecimiento de valores de fábrica con una .



## Función HOLD

Esta función le permite congelar la pantalla para realizar una observación más adelante.

1. Pulse el botón  para congelar la medición.
2. Pulse  nuevamente para desbloquear la medición.

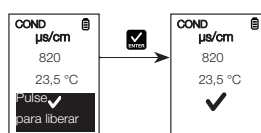
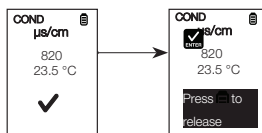

## Mantenimiento del sensor

1. Mantenga siempre limpios los electrodos de los sensores. Enjuague los electrodos con agua desionizada y séquelos con un paño limpio antes de almacenarlos con su tapa protectora. En el caso de los electrodos de copa, retire la copa de plástico blanco y la plantilla para limpiar a fondo las soluciones viscosas. No arañe nunca los electrodos con una sustancia dura.
2. Para obtener un mejor rendimiento, humedezca el electrodo en alcohol durante 10-15 minutos y enjuáguelo con agua desionizada antes de iniciar cualquier proceso de medición. Esto se hace para eliminar la suciedad y las manchas de aceite del electrodo que puedan afectar a la precisión de las mediciones.

## Sustitución del sensor

Puede sustituir el módulo del sensor por una parte del precio de un analizador nuevo. Cuando el analizador no puede calibrarse o arroja lecturas que fluctúan respecto a los patrones de calibración, necesita cambiar el electrodo.

1. Con las manos secas, agarre el anillo con el sensor orientado hacia usted. Gire el anillo en el sentido de las agujas del reloj. Guárdelo para un uso posterior.
2. Saque del analizador el módulo del sensor antiguo.
3. Alinee las cuatro pestañas del nuevo módulo para que coincidan con las cuatro ranuras del analizador.
4. Empuje suavemente el módulo en las ranuras para que encaje en su lugar. Empuje la junta tórica más pequeña completamente sobre el módulo del sensor nuevo. Empuje la otra junta tórica sobre el módulo y enrósquela en su lugar girándola firmemente en sentido contrario a las agujas del reloj.

**Nota:** Es necesario que vuelva a calibrar su analizador antes de realizar una medición después de la sustitución del sensor.

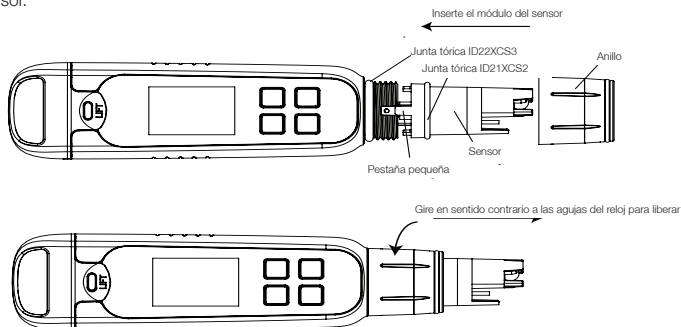

## Garantía

Este instrumento se suministra con una garantía contra defectos de fabricación por un periodo de un año a partir de la fecha de compra.

## Devolución de los artículos

Debe obtener la autorización de su distribuidor antes de devolver artículos por cualquier motivo. Al solicitar la autorización, incluya información relativa al motivo por el que se va a devolver el artículo.

Nos reservamos el derecho a realizar mejoras en el diseño, la construcción y el aspecto de los productos sin previo aviso. Los precios pueden cambiar sin previo aviso.

Especificación	Elite CTS
<b>Conductividad</b>	
Rango de conductividad	De 0,0 a 200,0 $\mu\text{S}$ ; de 200 a 2000 $\mu\text{S}$ ; de 2,00 a 20,00 mS
Resolución	0,1 $\mu\text{S}$ , 1 $\mu\text{S}$ , 0,01 mS
Exactitud relativa	$\pm 1\%$ fondo de escala
Temperatura de normalización	25,0° C (77 °F)
Coefficiente de temperatura	Del 0,0% al 10,0%
Puntos de calibración	Hasta tres puntos
<b>SDT</b>	
Intervalo SDT	De 0,0 a 100,0 ppm; de 100 a 1000 ppm; de 0,10 a 10,00 ppt (del factor SDT 0,5)
Resolución	0,1 ppm, 1 ppm, 0,01 ppt
Exactitud relativa	$\pm 1\%$ fondo de escala
Puntos de calibración	Hasta tres puntos
TDS Factor (Factor SDT)	De 0,40 a 1,00 (seleccionable)
<b>Salinidad</b>	
Rango de salinidad	De 0,00 a 10,00 ppt
Resolución	0,10 ppt
Exactitud relativa	$\pm 1\%$ fondo de escala
Puntos de calibración	Uno
<b>Temperatura</b>	
Intervalo de temperatura	De 0 °C a 60 °C de 32,0 °F a 140,0 °F
Resolución de la temperatura	0,1 °C/0,1 °F
Exactitud de la temperatura	De 0 °C a 50 °C ( $\pm 0,5$ °C/ $\pm 0,9$ °F + 1 LSD); De 50 °C a 60 °C ( $\pm 1,0$ °C/ $\pm 1,8$ °F + 1 LSD)
Compensación de temperatura	Sí (compensación automática de temperatura)
<b>Generalidades</b>	
Pantalla	Gráficos, matriz de puntos de 80 × 100 píxeles
Apagado automático	8,5 minutos (desde la última pulsación de tecla)
Reset (Restablecer)	Usuario/fábrica
Requisitos de la alimentación	Cuatro pilas AAA de 1,5 V
Duración de las pilas	>150 horas
Resistencia al agua	IP67

Este manual de instruções é aplicável ao Elite CTS Tester.

## Instalação e desinstalação das pilhas

O Elite CTS Tester usa quatro pilhas AAA de 1,5 V.

1. Segurando o medidor com uma mão, deslize o polegar para liberar a trava frontal.
2. Ainda com o medidor na mão, deslize o outro polegar para liberar a trava traseira.
3. Com as travas liberadas, deslize verticalmente a tampa do compartimento de pilhas do medidor. Isso removerá a tampa do compartimento de pilhas.
4. Para inserir a placa de pilhas, alinhe as pequenas proteções às guias do compartimento. Consulte a Figura 2.
5. Para bloquear a placa de pilhas, pressione e deslize-a para baixo, conforme mostrado na Figura 3.
6. Para liberá-la, empurre a aba, conforme mostrado na Figura 4.



Figura 1: Remoção da tampa do compartimento de pilhas



Figura 2: Pressione para desbloquear

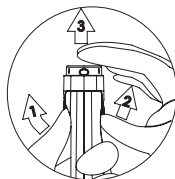

Figura 3: Alinhar guias



Figura 4: Pressione para baixo para bloquear



Figura 5: Posição de desbloqueio da placa de pilhas



Figura 6: Posição de bloqueio da placa de pilhas

## Guia de introdução

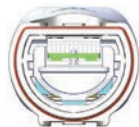



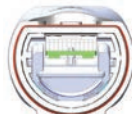

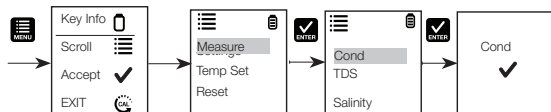
O Elite CTS Tester foi calibrado de fábrica e geralmente está pronto para utilização. Porém, após longos períodos sem utilização, é recomendável remover a tampa do sensor e mergulhá-lo em água quente corrente durante cerca de 10 minutos. Antes de efetuar as medições, é recomendável realizar calibrações periódicas com padrões certificados a fim de obter uma melhor precisão.

## Configuração dos parâmetros de medição

1. Pressione para ligar o medidor.
2. Pressione para acessar a janela de configuração. Pressione para selecionar Measure (Medida). O visor mostrará Cond (Condutividade), TDS e Salinity (Salinidade).
3. Percorra as opções pressionando para alternar entre Cond (Condutividade), TDS e Salinity (Salinidade). Pressione para selecionar Cond (Condutividade).
4. O visor mostrará a medida selecionada com um .







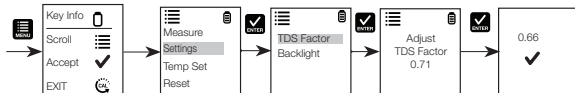



## Configuração do fator TDS

1. Pressione  para acessar a janela de configuração. Percorra as opções pressionando  para selecionar Settings (Configurações).
2. Pressione  para selecionar as configurações. O visor mostrará TDS Factor (Fator TDS) e Backlight (Luz de fundo).
3. Pressione  para selecionar a configuração TDS padrão de fábrica ou  para ajustar a configuração.
4. Pressione  para confirmar a seleção da configuração. O visor mostrará de definir Fator TDS com um .







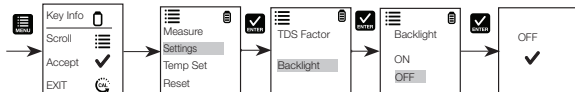

## Configurações da luz de fundo do

1. Pressione  para acessar a janela de configuração. Percorra as opções pressionando  para selecionar Settings (Configurações).
2. Pressione  para selecionar Settings (Configurações). O visor mostrará TDS Factor (Fator TDS) e Backlight (Luz de fundo).
3. Percorra as opções ao pressionando  para alternar entre TDS Factor (Fator TDS) e Backlight (Luz de fundo). Pressione  para selecionar Backlight (Luz de fundo).
4. O visor mostrará ON (Ligado) e OFF (Desligado). Percorra as opções pressionando  para alternar entre ON (Ligado) e OFF (Desligado). A opção ON (Ligado) de Backlight (Luz de fundo) aumenta a legibilidade em condições de baixa iluminação.
5. Pressione  para selecionar a opção de luz de fundo desejada. O visor mostrará a opção de luz de fundo selecionada com um .







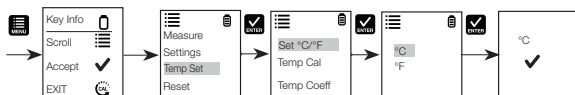



## Configurações da temperatura

1. Pressione  para acessar a janela de configuração. Percorra as opções pressionando  para selecionar Temp Set (Definir temperatura). Pressione  para selecionar Temp Set (Definir temperatura). O visor mostrará Set °C/°F (Definir °C/°F), Temp Cal (Calibração da temperatura) e Temp Coeff (Coeficiente de temperatura).
2. Pressione  para selecionar Set °C/°F (Definir °C/°F). Percorra as opções pressionando  para alternar entre °C e °F.
3. Pressione  para selecionar a unidade de temperatura. O visor mostrará a configuração de temperatura selecionada com um .









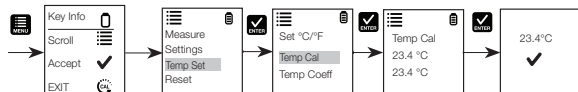

## Calibração da temperatura

1. Pressione  para acessar a janela de configuração. Percorra as opções pressionando  para selecionar Temp Set (Definir temperatura).
2. Pressione  para selecionar Temp Set (Definir temperatura). O visor mostrará Set °C/°F (Definir °C/°F), Temp Cal (Calibração da temperatura) e Temp Coeff (Coeficiente de temperatura).
3. Percorra as opções pressionando  para alternar entre Set °C/°F (Definir °C/°F), Temp Cal (Calibração da temperatura) e Temp Coeff (Coeficiente de temperatura). Pressione  para selecionar Temp Cal (Calibração da temperatura).
4. O visor inferior mostrará a atual leitura de temperatura medida com base no último desvio configurado e o visor superior mostrará a atual leitura de temperatura medida com base na calibração padrão de fábrica.
5. Mergulhe o medidor em uma solução de temperatura conhecida e aguarde até que o sensor de temperatura interno estabilize.
6. Pressione  para ajustar o valor de temperatura ou pressione  para confirmar o valor calibrado como o novo valor de temperatura da solução.

**Nota:** Para sair deste programa sem confirmar a calibração, pressione .



## Coeficiente de temperatura

1. Pressione  para acessar a janela de configuração. Percorra as opções pressionando  para selecionar Temp Set (Definir temperatura).
2. Pressione  para selecionar Temp Set (Definir temperatura). O visor mostrará Set °C/°F (Definir °C/°F), Temp Cal (Calibração da temperatura) e Temp Coeff (Coeficiente de temperatura).
3. Percorra as opções pressionando  para alternar entre Set °C/°F (Definir °C/°F), Temp Cal (Calibração da temperatura) e Temp Coeff (Coeficiente de temperatura).
4. Pressione  para selecionar Temp Coeff (Coeficiente de temperatura) ou  para ajustar Temp Coeff (Coeficiente de temperatura).
5. Pressione  para confirmar o valor de Temp Coeff (Coeficiente de temperatura). O novo valor será automaticamente confirmado com um .

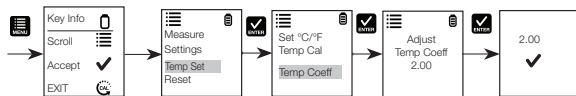





## Calibração para Condutividade, TDS ou Salinidade

Para obter melhores resultados, é recomendável realizar calibrações periódicas com um padrão preciso antes das medições. Utilize o valor de calibração padrão que seja próximo ao valor da amostra pretendida. O medidor reterá um valor de calibração em cada modo (condutividade, TDS, salinidade) quando o instrumento for desligado. O valor de condutividade pode ser calibrado automática ou manualmente, enquanto os valores de TDS e salinidade requerem uma calibração manual. O medidor começará no modo de medição que estava sendo utilizado quando foi desligado. Consulte "Configuração dos parâmetros de medição do Elite CTS" para alterar o parâmetro desejado.



## Calibração automática para condutividade

1. Remova a tampa e pressione  para ligar.
2. Mergulhe o sensor em pelo menos 30 mm de solução de calibração padrão.
3. Agite suavemente e pressione  para iniciar a calibração.
4. O visor mostrará "CAL" seguido do valor predefinido. "CAL" é indicado no visor durante o modo de calibração.
5. Se a leitura estiver dentro do intervalo de calibração dos padrões automaticamente reconhecidos; 80 (84  $\mu\text{S/cm}$ ), 1410 (1413  $\mu\text{S/cm}$ ) ou 12,90 (12,88  $\text{mS/cm}$ ), o ícone  será exibido quando o valor padrão automático de calibração tiver sido detectado.
6. Pressione  para aceitar o padrão de condutividade automático e finalize a calibração.
7. O visor retornará à janela Measurement (Medição).

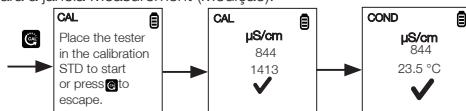



## Calibração manual

Quando a leitura de condutividade estiver fora do intervalo de calibração dos padrões de condutividade automáticos ou quando o TDS ou a salinidade forem utilizados, o medidor exigirá um ajuste manual.

1. Repita os passos 1 a 4 de "Calibração automática para condutividade".
2. Pressione  para ajustar manualmente o valor para a leitura desejada.



**Nota:** O ajuste apenas diminuirá. Porém, o ajuste passará eventualmente para o valor mais alto disponível após diminuir em 40% em relação ao valor inicial.

3. Pressione  para aceitar e finalizar a calibração quando o valor desejado estiver selecionado.
4. Para cancelar a calibração, pressione  para sair.
5. Uma vez concluída a calibração e as alterações aceitas pelo usuário, a janela de medição mostrará a leitura calibrada.

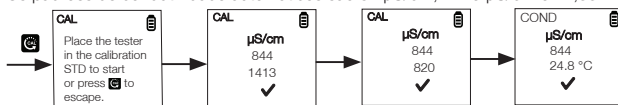

**Nota:** Os padrões de condutividade automáticos são 84  $\mu\text{S/cm}$ , 1413  $\mu\text{S/cm}$  e 12,88  $\text{mS/cm}$ .



## Medição de CTS

1. Pressione  para ligar o medidor, caso ele esteja desligado.
2. Mergulhe o eletrodo cerca de 2 a 3 cm na solução de teste. Agite e aguarde até que a leitura estabilize. O ícone do temporizador piscará durante este período. Quando a leitura estiver estabilizada, o temporizador irá parar de piscar e  aparecerá para indicar a estabilidade da leitura.





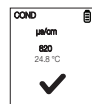

**CUIDADO:** O teste de amostras secas não é preciso e pode resultar em danos ou na quebra do sensor. Os solos devem estar úmidos e livres de partículas que possam arranhar o sensor de vidro. Aplicar força excessiva em amostras secas pode causar a quebra do vidro.

3. Anote o valor de CTS ou pressione  para congelar a leitura. Para liberar a leitura, pressione  novamente.
4. Pressione  para desligar o medidor. Caso não pressione nenhum botão durante 8,5 minutos, o medidor se desligará automaticamente para poupar as pilhas.



## Redefinição do usuário





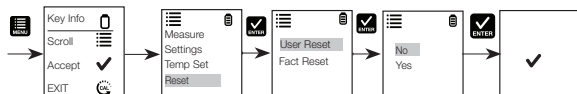



É possível redefinir a calibração de CTS para as configurações padrão do usuário através da função User Reset (Redefinição do usuário). A seleção do tampão e a calibração de temperatura do usuário não são afetadas pela função de redefinição do usuário.

1. Pressione  para acessar a janela de configuração. Percorra as opções pressionando  para selecionar Reset (Redefinir). Pressione  para selecionar Reset (Redefinir). O visor mostrará User Reset (Redefinição do usuário) e Fact Reset (Redefinição de fábrica).
2. Pressione  para selecionar User Reset (Redefinição do usuário).
3. O visor mostrará automaticamente No (Não) e Yes (Sim). Percorra as opções pressionando  para alternar entre No (Não) e Yes (Sim).
4. Pressione  para confirmar No (Não) ou Yes (Sim). O visor mostrará a opção de redefinição do usuário com um .



## Redefinição de fábrica

É possível redefinir a calibração de CTS para o padrão de fábrica através da função de redefinição de fábrica.

1. Pressione  para acessar a janela de configuração. Percorra as opções pressionando  para selecionar Reset (Redefinir). Pressione  para selecionar Reset (Redefinir). O visor mostrará User Reset (Redefinição do usuário) e Fact Reset (Redefinição de fábrica).
2. Percorra as opções pressionando  para alternar entre as redefinições. Pressione  para selecionar Fact Reset (Redefinição de fábrica).
3. O visor mostrará automaticamente No (Não) e Yes (Sim). Percorra as opções pressionando  para alternar entre No (Não) e Yes (Sim).
4. Pressione  para confirmar No (Não) ou Yes (Sim). O visor mostrará a opção de redefinição de fábrica com um .

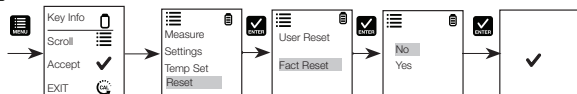

## Função HOLD (Reter)

Este recurso permite congelar o visor para uma observação demorada.

1. Pressione o botão  para congelar a medição.
2. Pressione  novamente para liberar a medição.



## Manutenção do sensor

1. Mantenha os eletrodos do sensor sempre limpos. Enxágue os eletrodos com água deionizada e seque-os com um pano limpo antes de armazená-los com a sua tampa de proteção. Para eletrodos de tipo copo, remova o copo de plástico branco e insira cuidadosamente em soluções viscosas limpas. Nunca arranhe os eletrodos com uma substância dura.
2. Para obter um melhor desempenho, mergulhe o eletrodo em álcool durante 10 a 15 minutos e enxágue com água deionizada antes de iniciar qualquer processo de medição. Essa ação removerá sujeiras e manchas de óleo do eletrodo que possam afetar a precisão das medições

## Substituição do sensor

É possível substituir o módulo sensor por uma fração do custo de um novo medidor. Quando o medidor não efetuar a calibração ou fornecer leituras oscilantes nos padrões de calibração, será necessário substituir o eletrodo.

1. Com as mãos secas, segure o anel com o sensor virado para você. Gire o anel para a direita. Guarde o anel para utilização posterior.
2. Retire o antigo módulo sensor do medidor.
3. Alinhe as quatro abas do novo módulo para que coincidam com as quatro aberturas no medidor.
4. Empurre suavemente o módulo para as aberturas para posicioná-lo corretamente. Empurre completamente o pequeno anel-O no novo módulo sensor. Empurre o outro anel-O sobre o módulo e encaixe-o no devido lugar girando firmemente para a esquerda.

**Nota:** É necessário recalibrar o medidor antes de uma medição, após uma substituição de sensor.

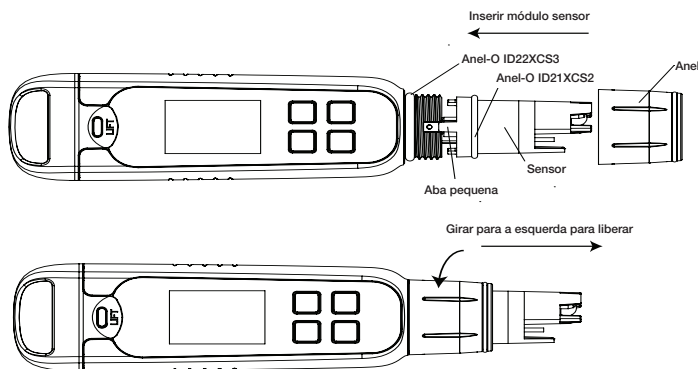

## Garantia

Este instrumento é fornecido com uma garantia contra defeitos de fabricação pelo período de um ano a contar da data de compra.

## Devolução de itens

Você deverá obter uma autorização do seu fornecedor antes de poder devolver itens por algum motivo. Ao solicitar uma autorização, inclua as informações relacionadas ao motivo da devolução dos itens.

Reservamos o direito de fazer melhorias no design, na fabricação e no aspecto dos produtos sem aviso prévio. Os preços estão sujeitos a alterações sem aviso prévio.

<b>Especificação</b>	<b>Elite CTS</b>
<b>Condutividade</b>	
Intervalo de condutividade	0,0 a 200,0 $\mu$ S, 200 a 2000 $\mu$ S, 2,00 a 20,00 mS
Resolução	0,1 $\mu$ S, 1 $\mu$ S, 0,01 mS
Precisão relativa	$\pm$ 1% em escala completa
Temperatura de normalização	25,0 °C (77 °F)
Coeficiente de temperatura	0,0 a 10,0%
Pontos de calibração	Até 3 pontos
<b>TDS</b>	
Intervalo de TDS	0,0 a 100,0 ppm, 100 a 1000 ppm, 0,10 a 10,00 ppt (do fator TDS 0,5)
Resolução	0,1 ppm, 1 ppm, 0,01 ppt
Precisão relativa	$\pm$ 1% em escala completa
Pontos de calibração	Até 3 pontos
Fator TDS	0,40 a 1,00 (selecionável)
<b>Salinidade</b>	
Intervalo de salinidade	0,00 a 10,00 ppt
Resolução	0,10 ppt
Precisão relativa	$\pm$ 1% em escala completa
Pontos de calibração	Um
<b>Temperatura</b>	
Intervalo de temperatura	0 a 60 °C 32,0 a 140,0 °F
Resolução de temperatura	0,1 °C/0,1 °F
Precisão de temperatura	de 0 a 50 °C ( $\pm$ 0,5 °C/ $\pm$ 0,9 °F + 1 LSD); de 50 a 60 °C ( $\pm$ 1,0 °C/ $\pm$ 1,8 °F + 1 LSD)
Compensação de temperatura	Sim (Compensação automática de temperatura)
<b>Especificação Elite CTS</b>	
<b>Geral</b>	
Visor	Gráfico, matriz de pontos de 80x100 pixels
Desligamento automático	8,5 minutos (após pressionar a última tecla)
Redefinição	Usuário/Fábrica
Alimentação	Quatro pilhas AAA de 1,5 V
Vida útil das pilhas	>150 horas
Impermeabilização	IP67

本説明書は、Elite CTS に適用されます。

## バッテリーの取り付けおよび取り外し

Elite CTS テスターは、AAA (単 4 形) 1.5 V バッテリーを四本使用します。

1. 一方の手でテスターを握り、親指を滑らせて前部の留め金を外します。
2. テスターを握んだまま、もう一方の親指で後部の留め金を外します。
3. 両方の留め金を外れたら、バッテリーカバーを垂直方向へ滑らせて、テスターから外します。これによりバッテリーカバーが外れます。
4. バッテリー プレートを差し込むには、ハウジングのガイド リブに小さいタブを合わせます。図 2 を参照してください。
5. バッテリー プレートをロックするには、図 3 に示すように押し下げてスライドさせます。
6. 解除するには、図 4 に示すようにタブを押し離します。



図 1: バッテリーカバーの取り外し



図 5: バッテリー プレートがロックされていない位置

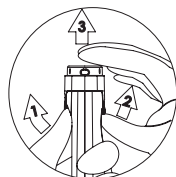

図 6: バッテリー プレートがロックされた位置

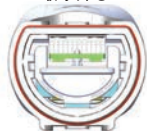

「2: 押してロックを解除する



「3: タブの整列



「4: 押してロックする

## はじめに

Elite CTS テスターは工場では校正されており、通常は、出荷後箱から出してそのまま良好に動作します。しかし、長期間未使用の場合には、センサー キャップを外し、センサーを温かい水道水に 10 分間程度浸すことが最善です。精度を最善に保つために、測定を行う前に、認証された標準を用いて定期的に校正を行うことが推奨されます。

## 測定パラメーターの設定

1. **ON** を押して、テスターのスイッチをオンにします。
2. **Menu** を押して、セットアップ ウィンドウに入ります。**ENTER** を押して、[Measure (測定)] を選択します。表示部に [Cond (導電率)]、[TDS]、および [Salinity (塩分)] が表示されます。
3. **Menu** を押して下にスクロールし、[Cond (導電率)]、[TDS]、および [Salinity (塩分)] 間を切り替えます。**ENTER** を押して、[Cond (導電率)] を選択します。
4. 表示部に、選択した測定が **✓\*\*\***マーク付きで表示されます。

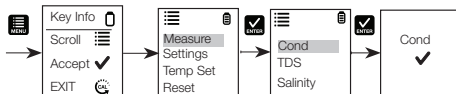

## TDS ファクターの設定

1. を押して、セットアップウィンドウに入ります。 を押して下にスクロールし、[Settings (設定)] を選択します。
2. を押して、[Settings (設定)] を選択します。表示部に [TDS factor (TDS ファクター)] と [Backlight (バックライト)] が表示されます。
3. を押してデフォルトの TDS 工場設定を選択するか、 を押して設定を調整します。
4. を押して、選択した設定を確認します。ディスプレイには、TDS係数の設定が表示されます。✓

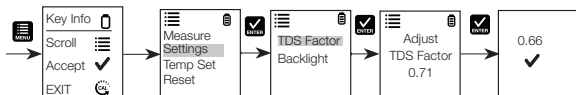

## バックライト設定の選択

1. を押して、セットアップウィンドウに入ります。 を押して下にスクロールし、[Settings (設定)] を選択します。
2. を押して、[Settings (設定)] を選択します。表示部に [TDS factor (TDS ファクター)] と [Backlight (バックライト)] が表示されます。
3. **\*\*\***を押して下にスクロールし、[TDS factor (TDS ファクター)] と [Backlight (バックライト)] 間を切り替えます。 を押して、[Backlight (バックライト)] を選択します。
4. 表示部に [ON] と [OFF] が表示されます。 を押して下にスクロールし、[ON] と [OFF] 間を切り替えます。バックライトを [ON] にすると、暗い場所で見えやすくなります。
5. を押して、適切なバックライトオプションを選択します。表示部に、選択されたバックライトオプションが✓\*\*\*マーク付きで表示されます。

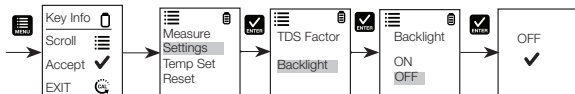

## 温度設定の選択

1. を押して、セットアップウィンドウに入ります。 を押して下にスクロールし、[Temp Set (温度設定)] を選択します。 を押して、[Temp Set (温度設定)] を選択します。表示部に [Set °C/°F (°C/°F を設定)] と [Temp Cal (温度校正)] が表示されます。
2. を押して、[Set °C/°F (°C/°F を設定)] を選択します。 を押して下にスクロールし、[°C] と [°F] 間を切り替えます。
3. を押して、温度の単位を選択します。表示部に、選択された温度の設定が✓\*\*\*マーク付きで表示されます。

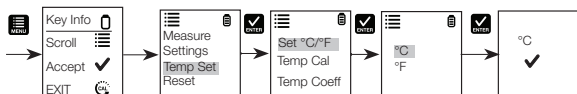

## 温度校正

1. を押して、セットアップウィンドウに入ります。 を押して下にスクロールし、[Temp Set (温度設定)] を選択します。
2. を押して、[Temp Set (温度設定)] を選択します。表示部に [Set °C/°F (°C/°F を設定)]、[Temp Cal (温度校正)]、および [Temp Coeff (温度係数)] がされます。
3. を押して下にスクロールし、[Set °C/°F (°C/°F を設定)]、[Temp Cal (温度校正)]、および [Temp Coeff (温度係数)] 間を切り替えます。 を押して、[Temp Cal (温度校正)] を設定します。
4. 下段の表示には、前回設定したオフセット値を基に測定された現在の温度値が表示されます。上段の表示には、工場出荷時のデフォルトの校正値を基に測定された現在の温度値が表示されます。
5. テスターを既知の温度の溶液に浸し、内蔵型温度センサーが安定するまで待ちます。
6. を押して温度値を調整するか、 を押して、溶液の新しい温度値として校正値を確認します。

注記：校正を確認せずにこのプログラムを終了するには、 を押します。

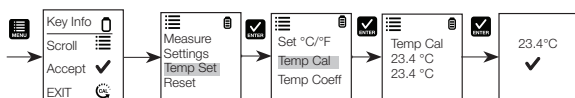

## 温度係数



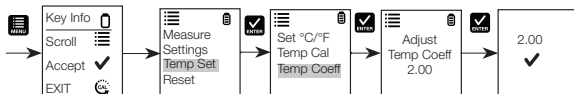

1. を押して、セットアップウィンドウに入ります。 を押して下にスクロールし、[Temp Set (温度設定)] を選択します。
2. を押して、[Temp Set (温度設定)] を選択します。表示部に [Set °C/°F (°C/°F を設定)]、[Temp Cal (温度校正)]、および [Temp Coeff (温度係数)] がされます。
3. を押して下にスクロールし、[Set °C/°F (°C/°F を設定)]、[Temp Cal (温度校正)]、および [Temp Coeff (温度係数)] 間を切り替えます。
4. を押して [Temp Coeff (温度係数)] を選択するか、 を押して [Temp Coeff (温度係数)] を調整します。
5. を押して、[Temp Coeff (温度係数)] の値を確定します。新しい値が自動的に確定され、 マークが付きます。



## 伝導率、TDS、または塩分の校正

最良の結果を得るには、測定を行う前に、精度の高い標準を用いて定期的に校正を行うことが推奨されます。目的の試料の値に近い、校正標準の値を使用します。テスターには、電源がオフになった時点の各モード（伝導率、TDS、塩分）の校正値一つが保持されます。導電率値は、自動または手動で校正できますが、TDS 値および塩分値には手動校正が必要です。テスターは、電源がオフになった時点の測定モードを開始します。希望のパラメーターに変更するには、「Elite CTS 測定パラメーターの設定」を参照してください。

## 伝導率の自動校正

1. キャップを取り外し、 を押して電源をオンにします。
2. センサーを 30 mm 以上の校正標準液に浸します。
3. 優しくかき混ぜて、 を押し、校正を開始します。
4. 表示部に「CAL」が表示され、続いてデフォルトの値が表示されます。校正モード中、表示部に CAL が表示されます。
5. 測定値が自動的に認識される標準値の校正範囲内—80 (84  $\mu\text{S}/\text{cm}$ )、1410 (1413  $\mu\text{S}/\text{cm}$ )、または 12.90 (12.88 mS/cm)—にある場合、自動校正標準値が検出されると、 アイコンが表示されます。
6.  を押して自動導電率標準値を確定し、校正を終了します。
7. 表示部は測定ウィンドウに戻ります。





## 手動校正

導電率の測定値が自動導電率標準値の校正範囲外の場合や、TDS または塩分を使用する場合、テスターは手動の調整が必要になります。

1. 「伝導率の自動校正」のステップ 1～4 を繰り返します。
2.  を押して、値を希望の測定値に手動で調整します。



注記:調整は下げることのみ可能ですが、最初の値の **40%** まで 減少する度に、調整可能な最も高い値に戻ります。

3.  を押して確定し、希望の値が選択されたら校正を終了します。表示部に「donE」が表示され、手動校正を確認します。
4. 校正を中止するには、 を押して終了します。
5. 校正が終了し、ユーザーが変更を受け入れると、測定ウィンドウには校正された測定値が表示されます。

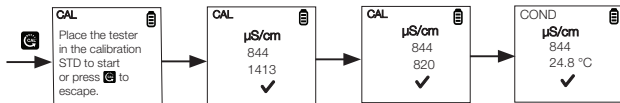

注記:自動導電率標準液は、84  $\mu\text{S}/\text{cm}$ 、1413  $\mu\text{S}/\text{cm}$ 、12.88 mS/cm です。



## CTS 測定

1. テスターのスイッチがオフの場合は、 を押してオンにします。
2. 電極を試験溶液に約 2 cm～3 cm 浸します。かき混ぜて、測定値を安定させます。この間、タイマーアイコンが点滅します。測定値が安定すると、タイマーの点滅は停止し、 マークが表示され、測定値が安定化したことを示します。

注意：乾燥した試料の測定は正確に行われず、センサーの損傷または破損につながる可能性があります。土壌は湿っていて、ガラス製センサーを傷つけるおそれのある微粒子が含まれていない必要があります。乾燥した試料に無理な力を加えるとガラスの破損の原因となる可能性があります。

3. CTS 値を書き留めるか、 を押して測定値を静止させます。測定値を解除するには、 を再び押します。
4.  を押して、テスターの電源を切ります。バッテリー節約のため、ボタンを 8.5 分間押さない状態が続くとテスターの電源が自動的に切れます。

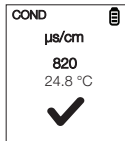



## ユーザー リセット

ユーザー リセット機能を使用して、CTS 校正をユーザーのデフォルト設定にリセットすることができます。緩衝液の選択および温度のユーザー校正は、ユーザー リセット機能による影響を受けません。

1. を押して、セットアップウィンドウに入ります。 を押して下にスクロールし、[Reset (リセット)] を選択します。 を押して [Reset (リセット)] を選択します。表示部に [User Reset (ユーザー リセット)] と [Fact Reset (工場リセット)] が表示されます。
2. を押して [User Reset (ユーザー リセット)] を選択します。
3. 表示部には、[No (いいえ)] と [Yes (はい)] が自動的に表示されます。 を押して下にスクロールし、[No (いいえ)] と [Yes (はい)] 間を切り替えます。
4. を押して、[No (いいえ)] または [Yes (はい)] のどちらかを確認します。表示部に、ユーザー リセットのオプションが マーク付きで表示されます。



## 工場リセット

工場リセット機能を使用して、CTS 校正を工場出荷時デフォルトにリセットすることができます。

1. を押して、セットアップウィンドウに入ります。 を押して下にスクロールし、[Reset (リセット)] を選択します。 を押して [Reset (リセット)] を選択します。表示部に [User Reset (ユーザー リセット)] と [Fact Reset (工場リセット)] が表示されます。
2. を押して下にスクロールし、両リセット間を切り替えます。 を押して、[Fact Reset (工場リセット)] を選択します。
3. 表示部には、[No (いいえ)] と [Yes (はい)] が自動的に表示されます。 を押して下にスクロールし、[No (いいえ)] と [Yes (はい)] 間を切り替えます。
4. を押して、[No (いいえ)] または [Yes (はい)] のどちらかを確認します。表示部に、工場リセットのオプションが マーク付きで表示されます。

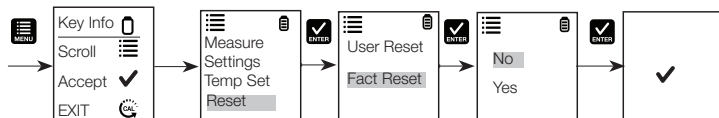

## HOLD (保持) 機能

この機能では、遅れて観測するために表示部を静止することができます。

1. ボタンを押して、測定値を静止します。
2. を再び押して、測定値を解除します。

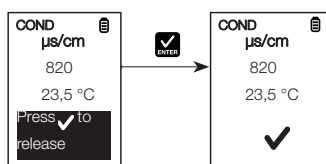
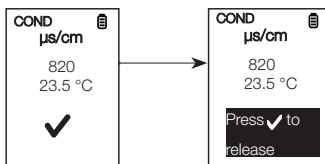

## センサーのメンテナンス

1. センサーの電極は常に清潔に保ってください。電極を脱イオン水ですすぎ、清潔な布で拭いてから、保護キャップをして保管します。カップ型電極の場合は、白いプラスチックカップを取り外して挿入し、粘性の溶液を丁寧に洗浄します。決して電極を固いものでこすったりしないでください。
2. より優れた性能を発揮させるためには、電極をアルコールに10～15分間浸し、脱イオン水ですすいでから、測定プロセスを開始します。これは、測定の精度に影響を及ぼす可能性のある電極の汚れや油しみを取り除くためのものです。

## センサーの交換

センサー モジュールは、新しいテスターを購入するよりはるかに少額の費用で交換できます。テスターが校正できない場合、または校正標準液で変動する測定値が出る場合は、電極を交換する必要があります。

1. 乾いた手で、センサーを前面にしてリングをつかみます。リングを時計回りに回します。リングは後で使用するため保存しておきます。
2. 古いセンサー モジュールをテスターから引き抜きます。
3. 新しいモジュールの四個のタブを、テスターの四個のスロットの位置に一致するように揃えます。
4. モジュールをスロットにゆっくり押し込み、所定の位置にはめ込みます。小さい方の○リングを新しいセンサーモジュールに完全に押し込みます。もう一方の○リングをモジュールの上に押し込み、反時計回りに固く回してねじ込みます。

注記: センサーの交換後は、測定を行う前に、テスターの再校正を行う必要があります。

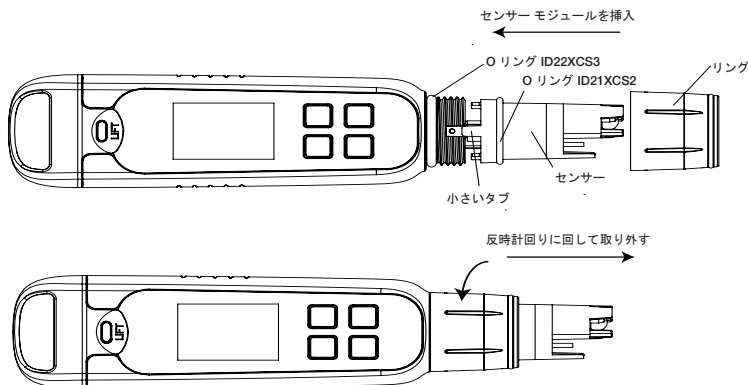

## 保証

本機器は、購入日から1年間、製造欠陥に対して保証が付けられています。

## 商品の返品

何らかの理由で返品される前に、お買い求めになった流通業者から承認を得る必要があります。返品承認をお申し込みの際は、その商品の返品理由について情報をご提供ください。

当社は、いつでも予告なしに製品の設計、構造、および外観において改善を行う権利を有しています。価格は、予告なく変更されることがあります。

仕様		Elite CTS	
<b>伝導率</b>			
伝導率範囲	0.0 ~ 200.0 $\mu$ S、200 ~ 2000 $\mu$ S、2.00 ~ 20.00 mS		
分解能	0.1 $\mu$ S、1 $\mu$ S、0.01 mS		
相対精度	$\pm$ 1% フルスケール		
標準化温度	25.0 $^{\circ}$ C (77 $^{\circ}$ F)		
温度係数	0.0% ~ 10.0%		
校正ポイント	最大 3 ポイント		
<b>TDS</b>			
TDS 範囲	0.0 ~ 100.0 ppm、100 ~ 1000 ppm、0.10 ~ 10.00 ppt (TDS ファクターに基づく)		
分解能	0.1 ppm、1 ppm、0.01 ppt		
相対精度	$\pm$ 1% フルスケール		
校正ポイント	最大 3 ポイント		
TDS ファクター	0.40 ~ 1.00 (選択可能)		
<b>塩分</b>			
塩分範囲	0.00 ~ 10.00 ppt		
分解能	0.10 ppt		
相対精度	$\pm$ 1% フルスケール		
校正ポイント	1		
<b>温度</b>			
温度範囲	0 $^{\circ}$ C ~ 60 $^{\circ}$ C 32.0 $^{\circ}$ F ~ 140.0 $^{\circ}$ F		
温度分解能	0.1 $^{\circ}$ C / 0.1 $^{\circ}$ F		
温度精度	0 $^{\circ}$ C ~ 50 $^{\circ}$ C ( $\pm$ 0.5 $^{\circ}$ C / $\pm$ 0.9 $^{\circ}$ F + 1 LSD); 50 $^{\circ}$ C ~ 60 $^{\circ}$ C ( $\pm$ 1.0 $^{\circ}$ C / $\pm$ 1.8 $^{\circ}$ F + 1 LSD)		
温度補正	あり (自動温度補正)		

# KOREAN

이 지침 설명서는 Elite CTS 테스트에 적용됩니다.

## 배터리 설치 및 제거

Elite CTS 테스트는 AAA 1.5V 배터리 4개를 사용합니다.

1. 한 손으로 테스트를 잡은 상태에서 엄지손가락으로 밀어서 전면 걸쇠를 제거합니다.
2. 테스트를 계속 잡은 상태에서 다른 엄지손가락으로 밀어서 후면 걸쇠를 제거합니다.
3. 양쪽 걸쇠가 제거된 상태에서 배터리 커버를 수직으로 밀어 테스트에서 빼냅니다. 이렇게 하면 배터리 커버가 제거됩니다.
4. 배터리 플레이트를 삽입하려면 소형 탭을 하우징의 가이드 홈에 맞춥니다. 그림 2를 참조하십시오.
5. 배터리 플레이트를 장그러면 그림 3에 나와 있는 것처럼 아래로 누르고 밀니다.
6. 잠금을 풀려면 그림 4에 나와 있는 것처럼 탭을 밀어냅니다.



그림 1: 배터리 커버 제거



그림 5: 배터리 플레이트 잠금 해제 위치

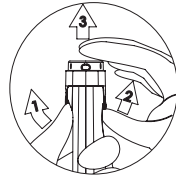

그림 2: 푸시하여 잠금 해제

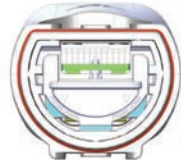

그림 3: 탭 맞춤

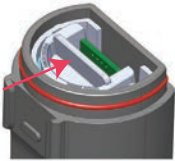

그림 4: 아래로 밀어 잠금 해제

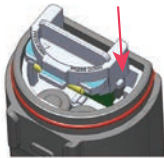

그림 6: 배터리 플레이트 잠금 위치

## 시작

Elite CTS 테스트는 공장에서 제조 시 교정되었으며 일반적으로 문제없이 즉시 작동됩니다. 그러나 사용하지 않은 기간이 오래 경과된 이후에는 센서 캡을 제거하고 센서를 미지근한 수돗물에 10분 정도 담가두는 것이 좋습니다. 측정을 시작하기 전에 최상의 정확성을 보장하려면 인증된 표준물질로 주기적인 교정을 하는 것이 좋습니다.

## 측정 변수 설정

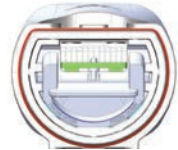
1. 를 눌러 테스트를 켭니다.
2. 를 눌러 설정 창으로 들어갑니다. 를 눌러 측정을 선택합니다. 디스플레이에 Cond(전도도), TDS, Salinity(염도)가 표시됩니다.
3. 를 눌러 아래로 스크롤하여 Cond(전도도), TDS, Salinity(염도) 간에 전환합니다. 를 눌러 Cond(전도도)를 선택합니다.
4. 디스플레이에 와 함께 선택한 측정이 표시됩니다.

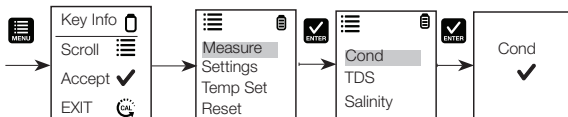

## TDS 인자 설정

1. 를 눌러 설정 창으로 들어갑니다. 를 눌러 아래로 스크롤하여 Settings(설정)를 선택합니다.
2. 를 눌러 Settings(설정)를 선택합니다. 디스플레이에 TDS Factor(TDS 인자) 및 Backlight(백라이트)가 표시됩니다.
3. 를 눌러 기본 TDS 공장 설정을 선택하거나 를 눌러 설정을 조정합니다.
4. 를 눌러 설정의 선택을 확인합니다. 디스플레이에 와 함께 선택한 온도 설정이 표시됩니다.

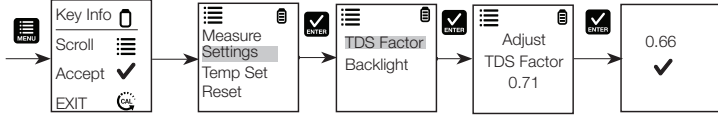

## 백라이트 설정 선택

1. 를 눌러 설정 창으로 들어갑니다. 를 눌러 아래로 스크롤하여 Settings(설정)를 선택합니다.
2. 를 눌러 Settings(설정)를 선택합니다. 디스플레이에 TDS Factor(TDS 인자) 및 Backlight(백라이트)가 표시됩니다.
3. 를 눌러 아래로 스크롤하여 TDS Factor(TDS 인자)와 Backlight(백라이트) 간에 전환합니다. 를 눌러 Backlight(백라이트)를 선택합니다.
4. 디스플레이에 ON(켜기) 및 OFF(끄기)가 표시됩니다. 를 눌러 아래로 스크롤하여 ON(켜기)와 OFF(끄기) 간에 전환합니다. Backlight(백라이트) ON(켜기)를 선택하면 낮은 조도에서 판독성이 높아집니다.
5. 를 눌러 원하는 백라이트 옵션을 선택합니다. 디스플레이에 와 함께 선택한 백라이트 옵션이 표시됩니다.

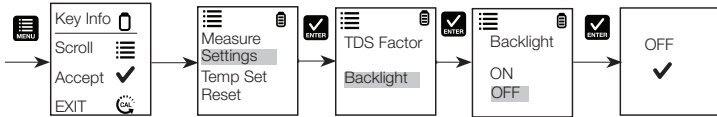

## 온도 설정 선택

1. 를 눌러 설정 창으로 들어갑니다. 를 눌러 아래로 스크롤하여 Temp Set(온도 설정)을 선택합니다. 를 눌러 Temp Set(온도 설정)으로 들어갑니다. 디스플레이에 Set °C/°F (°C/°F 설정), Temp Cal(온도 교정), Temp Coeff(온도 계수)가 표시됩니다.
2. 를 눌러 Set °C/°F(°C/°F 설정)을 선택합니다. 를 눌러 °C와 °F 간에 전환합니다.
3. 를 눌러 온도 단위를 선택합니다. 디스플레이에 와 함께 선택한 온도 설정이 표시됩니다.

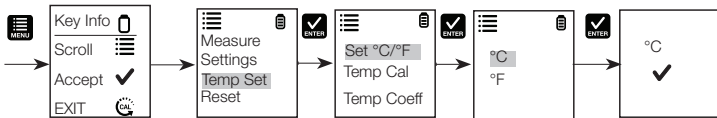

## 온도 교정

1. 를 눌러 설정 창으로 들어갑니다. 를 눌러 아래로 스크롤하여 Temp Set(온도 설정)을 선택합니다.
2. 를 눌러 Temp Set(온도 설정)을 선택합니다. 디스플레이에 Set °C/°F (°C/°F 설정), Temp Cal(온도 교정), Temp Coeff(온도 계수)가 표시됩니다.
3. 를 눌러 Set °C/°F (°C/°F 설정), Temp Cal(온도 교정), Temp Coeff(온도 계수) 간에 전환합니다. 를 눌러 Temp Cal(온도 교정)을 선택합니다.
4. 아래쪽 디스플레이에는 마지막으로 설정된 오프셋을 기준으로 현재 측정된 온도 판독값이 표시되며, 위쪽 디스플레이에는 공장 기본값 교정을 기준으로 현재 측정된 온도 판독값이 표시됩니다.
5. 테스트를 알려진 온도의 용액에 담고고 내장된 온도 센서가 안정화될 때까지 기다립니다.
6. 를 눌러 온도 값을 조정하거나 를 눌러 교정된 값을 용액의 새 온도 값으로 확인합니다.

참고: 교정을 확인하지 않고이 프로그램을 종료하려면 를 누릅니다.

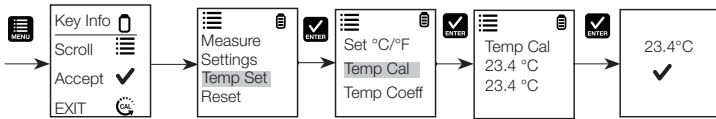

## 온도 계수

1. 를 눌러 설정 창으로 들어갑니다. 를 눌러 아래로 스크롤하여 Temp Set(온도 설정)을 선택합니다.
2. 를 눌러 Temp Set(온도 설정)을 선택합니다. 디스플레이에 Set °C/°F(°C/°F 설정), Temp Cal(온도 교정), Temp Coeff(온도 계수)가 표시됩니다.
3. 를 눌러 Set °C/°F(°C/°F 설정), Temp Cal(온도 교정), Temp Coeff(온도 계수) 간에 전환합니다.
4. 를 눌러 Temp Coeff(온도 계수)를 선택하거나 Temp Coeff(온도 계수)를 조정합니다.
5. 를 눌러 Temp Coeff(온도 계수) 값을 확인합니다. 새 값이 와 함께 자동으로 확인됩니다.

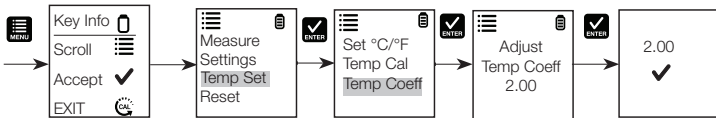

## 전도도, TDS, 염도 교정

최상의 결과를 보장하려면 측정 전에 정확한 표준 물질로 주기적인 교정을 수행하는 것이 좋습니다. 의도한 샘플 값과 가까운 교정 표준 물질 값을 사용하십시오. 장비의 전원이 꺼진 경우 테스트는 각 모드(전도도, TDS, 염도)에서 하나의 교정 값을 유지합니다. 전도도 값은 자동으로 또는 수동으로 교정할 수 있는 반면, TDS 및 염도 값은 수동 교정을 해야 합니다. 테스트를 전원이 꺼진 상태에서 사용했던 경우 측정 모드에서 시작됩니다. 원하는 변수를 변경하려면 "Elite CTS 측정 변수 설정"을 참조하십시오.

## 전도도 자동 교정

1. 캡을 제거하고 를 눌러 전원을 켭니다.
2. 30mm 이상의 교정 표준 물질에 센서를 담급니다.
3. 부드럽게 섞고 를 눌러 교정을 시작합니다.

- 디스플레이에 CAL이 표시된 후에 기본값이 표시됩니다. 교정 모드 중에는 디스플레이에 CAL 이 표시됩니다.
- ✓표독값이 자동으로 인식되는 표준 물질의 교정 범위인 80(84 $\mu$ S/cm), 1,410(1,413 $\mu$ S/cm) 또는 12.90(12.88mS/cm) 내에 속할 경우, 자동 교정 표준 값이 감지되면 ✓아이콘이 표시됩니다.
- 를 눌러 자동 전도도 표준 물질을 허용하고 교정을 완료합니다. 디스플레이에 자동 교정을 확인하는.
- 디스플레이가 측정 창으로 돌아갑니다.

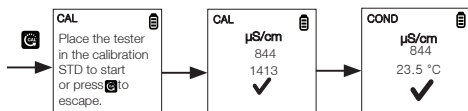

## 수동 교정

전도도 판독값이 자동 전도도 표준 물질의 교정 범위를 초과하거나 TDS 또는 염도를 사용한 경우, 테스트를 수동 조정해야 합니다.

- "전도도 자동 교정"의 1~4단계를 반복합니다.
- [MENU]를 눌러 값을 원하는 판독값으로 수동으로 조정합니다.

참고: 조정은 감소만 수행하지만, 최초 값의 40%가 감소한 후에는 조정 값이 사용 가능한 최고 값으로 순환합니다.

- [ENTER]를 눌러 원하는 값이 선택되면 교정을 허용하고 완료합니다. 디스플레이에 수동 교정을 확인하는.
- 교정을 중단하려면 [ESC]를 눌러 끝냅니다.
- 교정이 완료되고 사용자가 변경 사항을 허용하면 이제 측정 창에 교정된 판독값이 표시됩니다.

참고: 자동 전도도 표준 물질은 84 $\mu$ S/cm, 1,413 $\mu$ S/cm, 12.88mS/cm입니다.

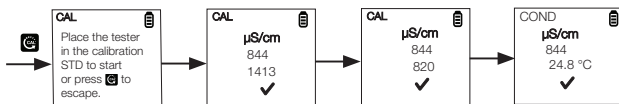

## CTS 측정

- 테스트의 전원이 꺼진 경우 [POWER]를 눌러 테스트를 켭니다.
- 전극을 테스트 용액에 2cm~3cm 정도 담급니다. 용액을 저어 판독값이 안정화되도록 합니다. 이 시간 동안 타이머 아이콘이 깜빡입니다. 판독값이 안정화되면 타이머가 깜빡임을 멈추고 ✓가 표시되어 판독값이 안정화되었음을 나타냅니다.  
주의: 건조 샘플 테스트는 정확하지 않으며 센서 손상 또는 파손이 발생할 수 있습니다. 습은 젖은 상태여야 하고 유리 센서가 긁힐 수 있는 미립자가 없어야 합니다. 건조 샘플에 과한 힘을 가하면 유리가 깨질 수 있습니다.
- CTS 값을 참조하거나 [ENTER]를 눌러 판독값을 동결시킵니다. 판독값을 해제하려면 [ENTER]를 다시 누릅니다.
- [POWER]를 눌러 테스트를 끕니다. 버튼을 8.5분 정도 누르지 않으면 배터리를 보존하기 위해 테스트가 자동으로 꺼집니다.

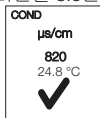

## 사용자 재설정

사용자 재설정 기능을 사용하면 CTS 교정을 사용자의 기본 설정으로 재설정할 수 있습니다. 완충용액 선택 및 온도 사용자 교정은 사용자 재설정 기능의 영향을 받지 않습니다.

1. **[MENU]**를 눌러 설정 창으로 들어갑니다. **[MENU]**를 눌러 아래로 스크롤하여 Reset(재설정)을 선택합니다. **[ENTER]**를 눌러 Reset(재설정)을 선택합니다. 디스플레이에 User Reset(사용자 재설정) 및 Fact Reset(공장값 재설정)이 표시됩니다.
2. **[ENTER]**를 눌러 User Reset(사용자 재설정)을 선택합니다.
3. 디스플레이에 No(아니요) 및 Yes(예)가 자동으로 표시됩니다. **[MENU]**를 눌러 아래로 스크롤하여 No(아니요)와 Yes(예) 간에 전환합니다.
4. **[ENTER]**를 눌러 No(아니요) 또는 Yes(예)를 확인합니다. 디스플레이에 와 함께 선택한 사용자 재설정 옵션이 표시됩니다. **[ENTER]**

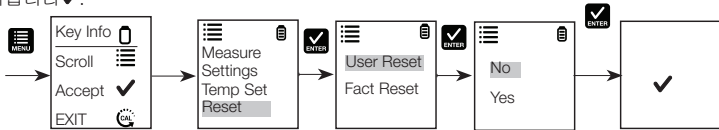

## 공장값 재설정

공장값 재설정 기능을 사용하면 CTS 교정을 공장값 재설정 기본값으로 재설정할 수 있습니다.

1. **[MENU]**를 눌러 설정 창으로 들어갑니다. **[MENU]**를 눌러 아래로 스크롤하여 Reset(재설정)을 선택합니다. **[ENTER]**를 눌러 Reset(재설정)을 선택합니다. 디스플레이에 User Reset(사용자 재설정) 및 Fact Reset(공장값 재설정)이 표시됩니다.
2. **[MENU]**를 눌러 아래로 스크롤하여 재설정 간에 전환합니다. **[ENTER]**를 눌러 Fact Reset(공장값 재설정)을 선택합니다.
3. 디스플레이에 No(아니요) 및 Yes(예)가 자동으로 표시됩니다. **[MENU]**를 눌러 아래로 스크롤하여 No(아니요)와 Yes(예) 간에 전환합니다.
4. **[ENTER]**를 눌러 No(아니요) 또는 Yes(예)를 확인합니다. 디스플레이에 와 함께 선택한 공장값 재설정 옵션이 표시됩니다. **[ENTER]**

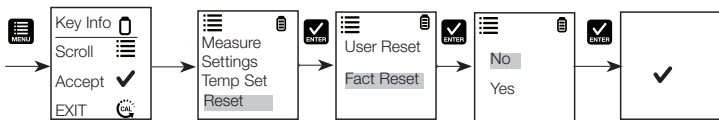

## 보류 기능

이 기능을 사용하여 지연된 관측 시간 동안 디스플레이를 동결시킬 수 있습니다.

1. **[ENTER]** 버튼을 눌러 측정값을 동결시킵니다.
2. **[ENTER]**를 다시 눌러 측정값을 해제합니다.





## 센서 유지관리

1. 센서 전극을 항상 청결하게 유지합니다. 전극을 초순수에 씻은 후 보호 캡을 씌워 보관하기 전에 깨끗한 천으로 물기를 닦습니다. 컵 유형 전극의 경우, 흰색 플라스틱 컵을 제거하고 깨끗한 점성 용액에 완전히 넣습니다. 전극을 딱딱한 물질로 긁지 마십시오.
2. 최상의 성능을 보장하려면 전극을 알코올에 10~15분간 담그고 측정 프로세스를 시작하기 전에 초순수로 씻어냅니다. 이렇게 하면 측정의 정확성에 영향을 미칠 수 있는 전극의 오염물 및 기름 얼룩을 제거할 수 있습니다.

## 센서 교체

새 테스트 구매에 비해 극히 적은 비용으로 센서 모듈을 교체할 수 있습니다. 테스트가 교정을 수행하지 못하거나 교정 표준 물질을 판독할 때 변동이 심할 경우 전극을 바꾸어야 합니다.

1. 사용자 방향을 보고 있는 센서의 링을 마른 손으로 잡습니다. 링을 시계 방향으로 돌립니다. 나중에 사용하기 위해 링을 보관합니다.
2. 오래된 센서 모듈을 테스트에서 빼냅니다.
3. 새 모듈의 탭 4개를 테스트의 슬롯 4개에 맞게 조정합니다.
4. 모듈을 슬롯 안에 부드럽게 밀어넣어 제자리에 끼웁니다. 작은 O링을 새 센서 모듈에 밀어넣습니다. 다른 O링을 모듈 위에 밀어넣고 시계 반대 방향으로 세계 돌려 제자리에 끼웁니다.

참고: 센서 교체 후에는 측정 전에 테스트를 다시 교정해야 합니다.

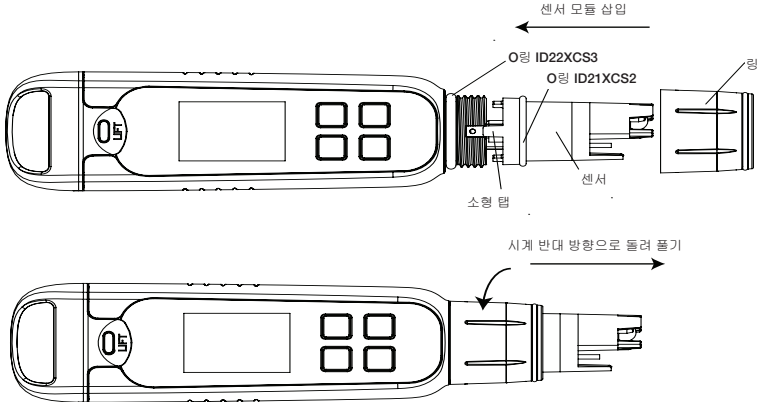

## 보증

본 장비는 구입일로부터 1년 동안 제조상의 결함에 대한 보증이 제공됩니다.

## 물품 반환

어떠한 이유든 물품을 반환하기 전에 유통업체의 승인을 받아야 합니다. 승인을 요청할 경우 물품을 반환하는 이유에 대한 정보를 포함해 주십시오.

당사는 고지 없이 제품의 설계, 구조 및 모양을 개선할 권한이 있습니다. 가격은 고지 없이 변경될 수 있습니다.

사양		Elite CTS
<b>전도도</b>		
전도도 범위	0.0~200.0 $\mu$ S, 200~2000 $\mu$ S, 2.00~20.00mS	
분해능	0.1 $\mu$ S, 1 $\mu$ S, 0.01mS	
상대 정확도	$\pm$ 1% 전체 범위	
표준화 온도	25.0°C(77°F)	
온도 계수	0.0%~10.0%	
교정 포인트	최대 3포인트	
<b>TDS</b>		
TDS 범위	0.0~100.0ppm, 100~1000ppm, 0.10~10.00ppt (TDS 인자에 따라 다름)	
분해능	0.1ppm, 1ppm, 0.01ppt	
상대 정확도	$\pm$ 1% 전체 범위	
교정 포인트	최대 3포인트	
TDS 인자	0.40~1.00(선택 가능)	
<b>염도</b>		
염도 범위	0.00~10.00ppt	
분해능	0.10ppt	
상대 정확도	$\pm$ 1% 전체 범위	
교정 포인트	1	
<b>온도</b>		
온도 범위	0°C~60°C 32.0°F~140.0°F	
온도 분해능	0.1°C/0.1°F	
온도 정확도	0°C~50°C( $\pm$ 0.5°C/ $\pm$ 0.9°F + 1 LSD), 50°C~60°C( $\pm$ 1.0°C/ $\pm$ 1.8 °F + 1 LSD)	
온도 보정	예 (자동 온도 보정)	
<b>일반</b>		
디스플레이	그래픽, 도트 매트릭스 80X100픽셀	
자동 끄기	8.5분(마지막 키를 누른 시점 기준)	
재설정	사용자/공장값	
전력 요구 사항	AAA 1.5V 배터리 4개	
배터리 수명	>150시간	
방수	IP67	

本说明书适用于 Elite CTS 测试仪。

## 电池的安裝和拆卸

Elite CTS 测试仪使用四节 AAA 1.5 V 电池。

1. 一手固定测试仪，滑动拇指拨开前钩。
2. 仍然保持测试仪固定，滑动另一拇指拨开后钩。
3. 打开两个钩后，垂直将电池盖从测试仪上滑开。这样即可拆除电池盖。
4. 插入电池板时，将小片对准外壳上的导肋。参见图 2。
5. 要锁定电池板，如图 3 所示向下按并滑动。
6. 若要释放，则如图 4 所示推开翼片。



图 1: 拆除电池盖



图 2: 推动解锁

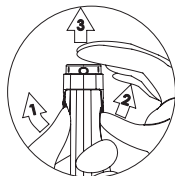

图 3: 对齐选项卡



图 4: 按下锁定



图 5: 电池板解锁位置



图 6: 电池板锁定位置

## 入门指南

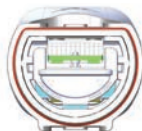
Elite CTS 测试仪出厂时已校准，通常开箱即可正常使用。但是在长期未使用后，建议取出传感器盖并将传感器浸在温水中 10 分钟左右。为获得最佳精度，建议在测量前根据认证标准进行定期校准。

## 测量参数设置

1. 按 打开测试仪。
2. 按 进入设置窗口。按 选择 Measure (测量)。显示屏上显示 Cond (电导率)、TDS 和 Salinity 盐度)。
3. 按 向下滚动可切换 Cond (电导率)、TDS 和 Salinity (盐度)。按 选择 Cond (电导率)。
4. 显示屏上显示所选测量和 。

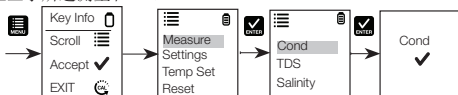

## TDS 因数设置

1. 按 进入设置窗口。按 向下滚动选择 Settings (设置)。
2. 按 选择 Settings (设置)。显示屏上显示 TDS Factor (TDS 因数) 和 Backlight (背光)。
3. 按 选择默认 TDS 出厂设置或按 调整设置。
4. 按 确认设置选择。显示屏上显示所选温度设置和 。

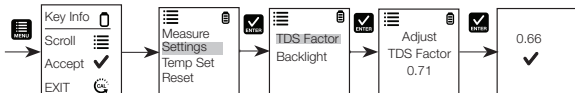

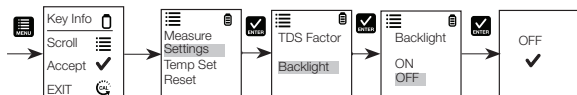

## 背光设置选择

1. 按  进入设置窗口。按  向下滚动选择 Settings (设置)。
2. 按  选择 Settings (设置)。显示屏上显示 TDS Factor (TDS 因数) 和 Backlight (背光)。
3. 按  向下滚动切换 TDS Factor (TDS 因数) 和 Backlight (背光)。按  选择 Backlight (背光)。
4. 显示屏上显示 ON (开) 和 OFF (关)。按  向下滚动切换 ON (开) 和 OFF (关)。背光开可提高高低光条件下的易读性。
5. 按  选择所需背光选项。显示屏上显示选择的背光选项和 。







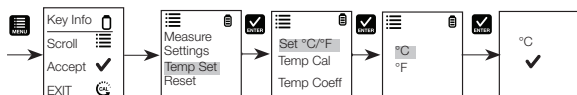

## 温度设置选择

1. 按  进入设置窗口。按  向下滚动选择 Temp Set (温度设置)。按  进入并选择 Temp Set (温度设置)。显示屏上显示 Set °C/°F (设置 °C/°F)、Temp Cal (温度校准) 和 Temp Coeff (温度系数)。
2. 按  选择 Set °C/°F (设置 °C/°F)。按  向下滚动切换 °C 和 °F。
3. 按  选择温度单位。显示屏上显示所选温度设置和 。



## 温度校准

1. 按  进入设置窗口。按  向下滚动选择 Temp Set (温度设置)。
2. 按  选择 Temp Set (温度设置)。显示屏上显示 Set °C/°F (设置 °C/°F)、Temp Cal (温度校准) 和 Temp Coeff (温度系数)。
3. 按  向下滚动切换 Set °C/°F (设置 °C/°F)、Temp Cal (温度校准) 和 Temp Coeff (温度系数)。按  选择 Temp Cal (温度校准)。
4. 下方显示屏显示基于上次设置的偏移的当前测量温度读数，上方显示屏显示基于出厂默认校准的当前测量温度读数。
5. 将测试液浸入已知温度的溶液中，然后等待内置温度传感器稳定。
6. 按  调整温度值或按  确认已校准值为溶液的新温度值。

注：要退出此程序但不确认校准，请按 。

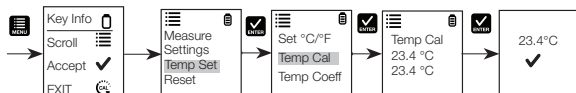

## 温度系数

1. 按 进入设置窗口。按 向下滚动选择 Temp Set（温度设置）。
2. 按 选择 Temp Set（温度设置）。显示屏上显示 Set °C/°F（设置 °C/°F）、Temp Cal（温度校准）和 Temp Coeff（温度系数）。
3. 按 向下滚动切换 Set °C/°F（设置 °C/°F）、Temp Cal（温度校准）和 Temp Coeff（温度系数）。
4. 按 选择 Temp Coeff（温度系数）或按 调整 Temp Coeff（温度系数）。
5. 按 确认 Temp Coeff（温度系数）的值。自动确认新值并显示 。

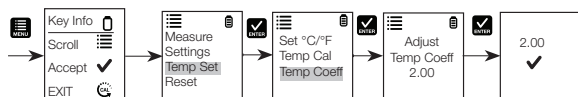

## 电导率自动校准

1. 取下盖子并按 打开电源。
2. 将传感器浸入校准标样至少 30 mm。
3. 轻轻搅动并按 开始校准。
4. 显示屏会显示 CAL（校准）及默认电导率值。校准期间显示屏上会显示 CAL。
5. 如果读数在自动识别的标样的校准范围内，80 (84  $\mu$ S/cm)、1410 (1413  $\mu$ S/cm) 或 12.90 (12.88 mS/cm)，则检测到自动校准标样值时会显示 图标。
6. 按 接受自动电导率标样并完成校准。
7. 显示屏返回 Measurement（测量）窗口。



## 手动校准

电导率读数在自动电导率标样校准范围外或使用 TDS 或盐度时，测试仪会要求手动校准。

1. 重复“电导率自动校准”的步骤 1 - 4。
2. 按 手动将值调整到所需读数。



注：调整时只能降低读数，但当调整值较初始值降低 40% 后，会循环到最高可用值。

3. 选择所需值后按 接受并完成校准。
4. 要中止校准，请按 退出。
5. 校准完成且用户接受更改后，测量窗口会显示校准后的读数。

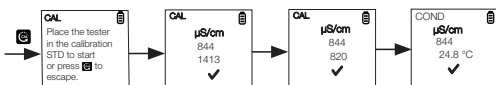

注：自动电导率标样为 84  $\mu$ S/cm、1413  $\mu$ S/cm 和 12.88 mS/cm。



## CTS 测量

1. 如果测试仪已关闭，按  打开测试仪。
2. 将电极浸入测试溶液中 2 cm 到 3 cm。搅动并等待读数稳定。在此期间计时器图标会闪烁。读数稳定后，计时器停止闪烁并会显示  表示读数稳定。

**小心：**测试干样本是不准确的并会导致传感器损坏或破碎。土壤必须是湿的且不能有会擦伤玻璃传感器的颗粒。过度用力插入干样本会导致玻璃破碎。

3. 记录 CTS 值或按  冻结读数。若要释放读数，再按一次 。
4. 按  关闭测试仪。如果您在 8.5 分钟内未按任何按钮，测试仪会自动关闭以节省电量。

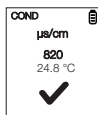

## 用户重置

您可使用用户重置功能将 CTS 校准重置为用户的默认设置。缓冲液选择和温度用户校准不受用户重置功能的影响。

1. 按  进入设置窗口。按  向下滚动选择 Reset（重置）。按  选择 Reset（重置）。显示屏上显示 User Reset（用户重置）和 Fact Reset（出厂重置）。
2. 按  选择 User Reset（用户重置）。
3. 显示屏自动显示 No（否）和 Yes（是）。按  切换 No（否）和 Yes（是）。
4. 按  确认 No（否）或 Yes（是）。显示屏上显示用户重置选项和 。



## 出厂重置

您可使用出厂重置功能将 CTS 校准重置为出厂默认设置。

1. 按  进入设置窗口。按  向下滚动选择 Reset（重置）。按  选择 Reset（重置）。显示屏上显示 User Reset（用户重置）和 Fact Reset（出厂重置）。
2. 按  向下滚动切换重置。按  选择 Fact Reset（出厂重置）。
3. 显示屏自动显示 No（否）和 Yes（是）。按  切换 No（否）和 Yes（是）。
4. 按  确认 No（否）或 Yes（是）。显示屏上显示出厂重置选项和 。



## 保持功能

该功能可以冻结显示屏以长时间观看。

1. 按  按钮冻结测量。
2. 再按一次  释放测量。

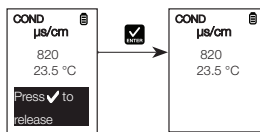
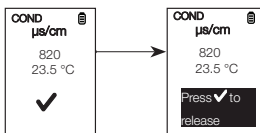

## 传感器维护

1. 始终保持传感器电极的清洁。盖上保护盖前，使用去离子水清洗电极并使用干净的布擦干。对于杯型电极，取下白色塑料杯并浸入非常干净的黏稠溶液中。切勿使用硬物质刮电极。
2. 为获得更好的性能，开始任何测量流程之前，请先将电极浸入酒精中 10 到 15 分钟，然后用去离子水冲洗。这样可以移除电极上的灰尘和油污，避免影响测量精度。

## 传感器的更换

您可以比新测试仪成本低得多的成本更换传感器模块。如果测试仪无法校准或在校准标样时出现读数波动，那么您需要更换电极。

1. 用干燥的手握住环，让传感器面向您。顺时针旋转环。保存环以备稍后使用。
2. 将旧传感器模块从测试仪中拉出。
3. 对准新模块上的四个翼片，使它们和测试仪上的四个插槽对准。
4. 轻轻将模块按到插槽上并按到位。将较小的 O 形环完全按到传感器模块上。将其他 O 形环按到模块上并通过顺时针旋转将其牢固地拧到位。

**注：**更换传感器后，在测量前一定要重新校准测试仪。

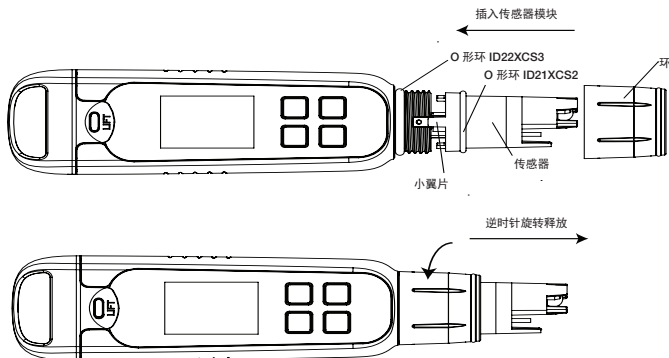

## 保修

本仪器自购买之日起，制造缺陷方面的保修期为一年。

## 退货

无论出于任何原因，退货前必须获得经销商的授权。申请授权时，需提供退货原因。

我们保留对产品的设计、构造和外观进行改善的权限，恕不另行通知。价格可能发生更改，恕不另行通知。

技术规格	Elite CTS
<b>电导率</b>	
电导率范围	0.0 到 200.0 $\mu$ S, 200 到 2000 $\mu$ S, 2.00 到 20.00 mS
分辨率	0.1 $\mu$ S, 1 $\mu$ S, 0.01 mS
相对精度	$\pm$ 1% 全刻度
归一化温度	25.0°C (77°F)
温度系数	0.0% 至 10.0%
校准点	最多 3 个点
<b>TDS</b>	
TDS 范围	0.0 至 100.0 ppm, 100 至 1000 ppm, 0.10 至 10.00 ppt (取决于 TDS 因数)
分辨率	0.1 ppm, 1 ppm, 0.01 ppt
相对精度	$\pm$ 1% 全刻度
校准点	最多 3 个点
TDS 因数	0.40 至 1.00 (可选择)
<b>盐度</b>	
盐度范围	0.00 至 10.00 ppt
分辨率	0.10 ppt
相对精度	$\pm$ 1% 全刻度
校准点	一个
<b>温度</b>	
温度范围	0°C 至 60°C (32.0°F 至 140.0°F)
温度分辨率	0.1°C / 0.1°F
温度精度	从 0°C 至 50°C ( $\pm$ 0.5°C / $\pm$ 0.9°F + 1 LSD); 从 50°C 至 60°C ( $\pm$ 1.0°C / $\pm$ 1.8 °F + 1 LSD)
温度补偿	是 (自动温度补偿)
<b>常规</b>	
显示屏	图形, 点阵 80X100 像素
自动关闭	8.5 分钟 (最后一次按键后)
重置	用户/出厂
电源要求	四节 AAA 1.5 V 电池
电池寿命	>150 小时
防水	IP67

## Water and Lab Products

**Australia:** (613) 9757-4300 **In Australia:** (1300) 735-295 **China:** (86) 21-6865-4588

**Germany:** (49) 6184-90-6321 **India:** (91) 22-6716-2261/2247 **Japan:** (81) 045-453-9175

**North America:** 1-978-232-6000 **Toll Free:** 1-800-225-1480 **Singapore:** (65) 6778-6876

68X001308 Rev.0

Find out more at [thermofisher.com/elitectscup](http://thermofisher.com/elitectscup)

[thermofisher.com/elitectspin](http://thermofisher.com/elitectspin)

**ThermoFisher**  
SCIENTIFIC