

iCapture™ Analog MUX

WHITEPAPER

Introduction

iCapture™ Analog MUX is a unique Tektronix innovation for viewing an electrical signal in digital and analog forms simultaneously using a single voltage probe. This white paper discusses the need for probing a circuit as well as the challenges of minimizing probe loading. In addition, the design and technology of iCapture™ Analog MUX is explained. Finally, the benefits of iCapture™ Analog MUX for digital and analog designers using oscilloscopes or logic analyzers are listed.

Motivation for Probing

- Design engineers and technicians frequently need to measure signals in their equipment to debug, characterize or validate their circuits. Analog fidelity (e.g. ringing, risetime, etc.) and digital conformity (correct logic level and timing) are typically of concern.
- To gauge analog fidelity a user would use their oscilloscope with its probe attached to the circuit under test (CUT). The oscilloscope would need to be of high enough performance to measure the signals in question. The probe would need to have both high enough performance to pass the signals with minimal distortion and low enough loading capacitance so as to avoid causing the signal itself to change due to the probe loading.

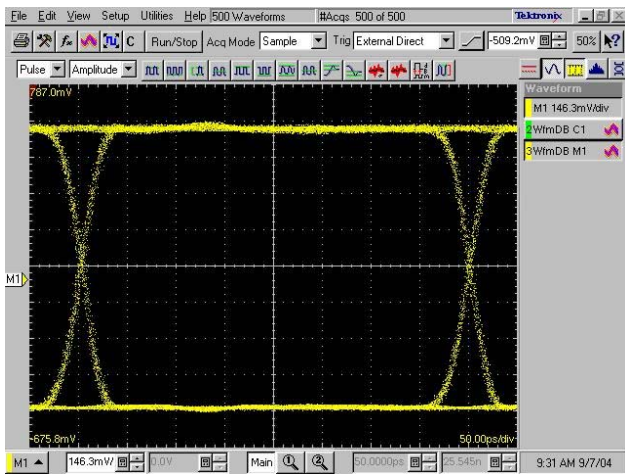

Figure 1. Screen capture of an eye diagram without probe loading.

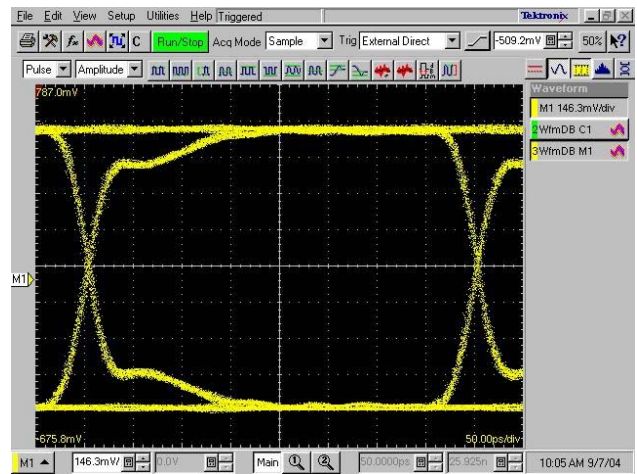

Figure 2. The same signal with the addition of probe loading.

- Gauging digital conformity requires that a digital probe be of low enough capacitance so as to maintain logic timing accuracy and of high enough bandwidth performance to pass the unperturbed logic signal.

Problems inherent in probing

- Unfortunately, with a traditional logic analyzer one cannot view analog aspects of a signal. Similarly, with a traditional oscilloscope viewing an analog signal as it relates to other logic signals is both limited and cumbersome. One way that engineers attempt to solve these problems is to connect a logic analyzer and oscilloscope simultaneously to their signals of interest. While this may work for some signals, the increase in probe capacitance loading on the signal could be great enough as to make both logic and analog measurements of the signals meaningless. Before Tektronix' iCapture™ Analog MUX, even systems requiring high performance measurements were relegated to substandard double-probing, as shown in Figure 3. In more and more cases there is simply no room for two probes on each of the signals of interest, as is evident in Figure 4.



Figure 3. Substandard double-probing.

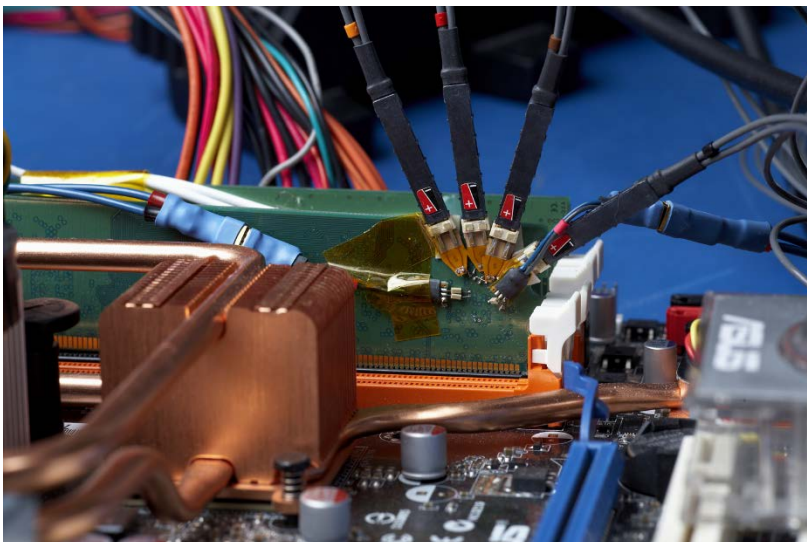

Figure 4. Insufficient room for probing.

The Solution: Tektronix iCapture™ Analog MUX

- Tektronix eliminated the problem of probing twice, once each for analog and for digital, with iCapture™ Analog MUX (US Patent no. 6847199, "Capturing Both Digital and Analog Forms of a Signal Through the Same Probing Path") one probe is used to measure both analog and digital aspects of the signal. First implemented in Tektronix logic analyzers and now performance MSOs, iCapture™ Analog MUX contains an analog multiplexer (MUX) which selects as many as four of the input signals for analog viewing, while avoiding additional perturbation of those signals, and while maintaining full digital capability. The basics of the analog MUX are shown in the block diagram in Figure 5.

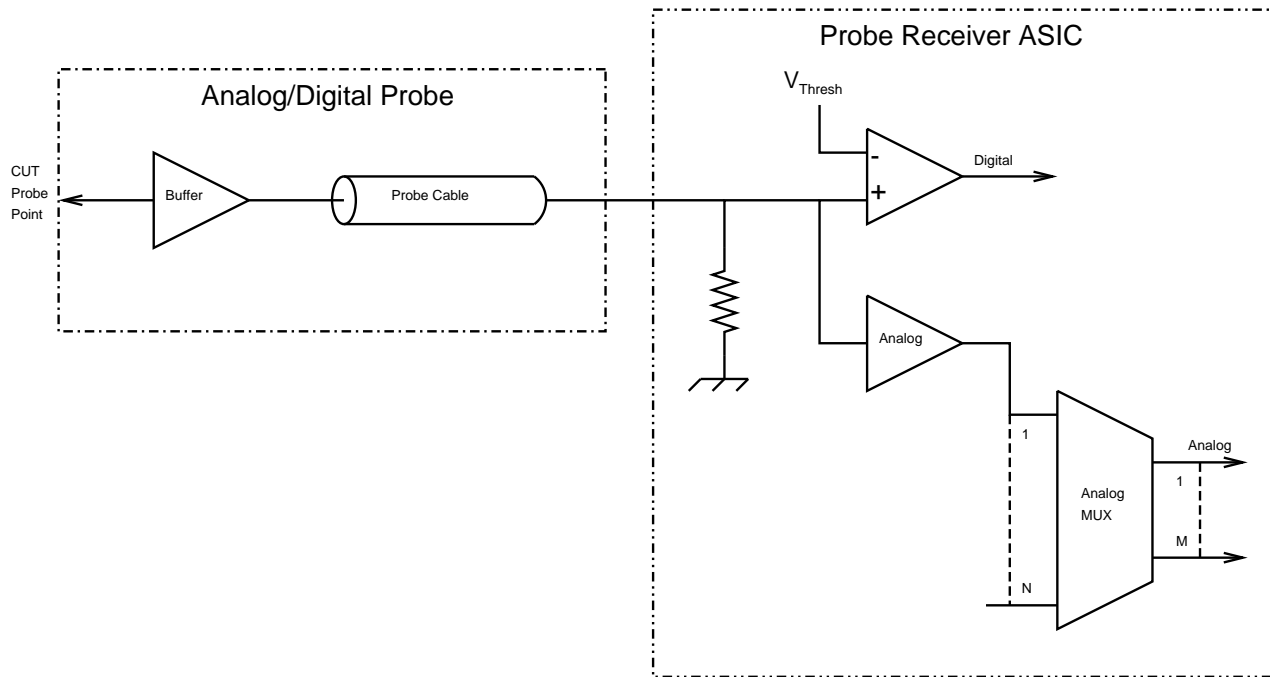

Figure 5. Block diagram of the basic of the analog MUX.

- Note that there is only one probe connected to each circuit under test (CUT) Probe Point, easily cutting the probe loading by half, or more. After being buffered the CUT signal propagates down the probe cable and splits into analog and digital paths. The fact that this split takes place inside the Probe Receiver ASIC means that the additional capacitance on the signal from the addition of the second connection, can be 20 to 100 times less than it would have been were this connection being made at the CUT Probe Point.

Benefits of iCapture™ Analog MUX

- The benefits of iCapture™ Analog MUX to the digital designer are clear. Analog views of digital signals can be called up at any time during debug, characterization and validation, without needing to change or add probes. The image below shows one signal in both analog and digital domains, where the upper analog waveform clearly depicts ringing on the rising and falling edges. This ringing will cause extra digital transitions in the CUT, as is shown by the lower digital representation of the signal. Access to the iCapture™ Analog MUX feature is shown in Figure 6.



Figure 6. Edge ringing causing digital transitions.

- The benefits of iCapture™ Analog MUX to the analog designer are less obvious, though also important. Many more analog signals can be called up for viewing at any time without needing to move or remove other analog probes, thereby expanding the effective channel count of the oscilloscope.

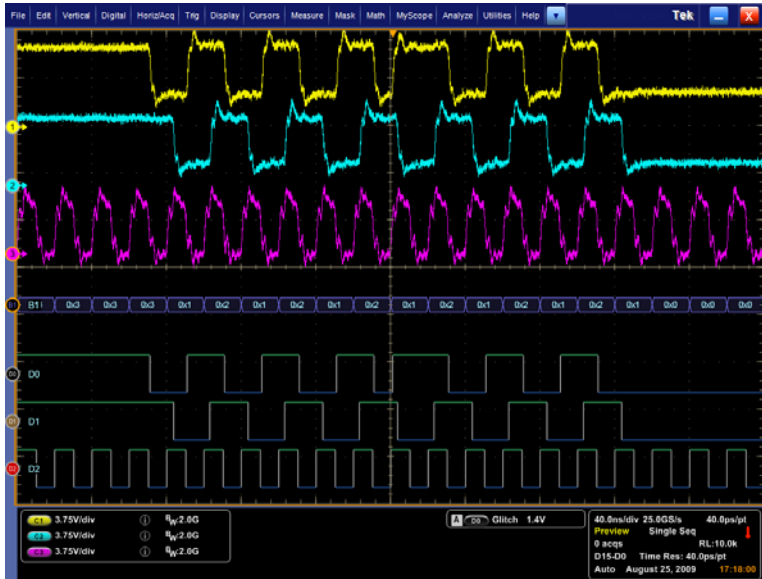

The impact of these benefits is that more measurements are possible, the probing is more convenient, and a better measurement result is achieved in a shorter amount of time.

- iCapture Analog MUX offers flat frequency response out to 2.5 GHz giving you frequency response comparable to that of a standard 2.5 GHz analog probe.

MSO70k Frequency Response Using ICapture

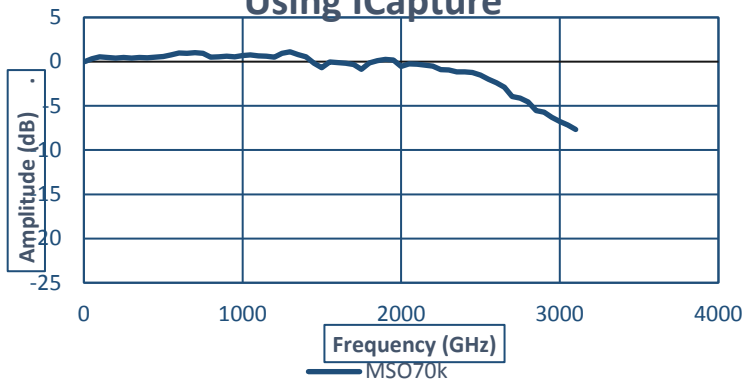

- The P6780 Differential Digital probe using iCapture can offer levels of performance comparable to standard analog differential probes allowing you to capture analog waveforms with high fidelity. The performance out of the P6780 using iCapture is sufficient to produce passing results in the USB 2.0 Compliance Signal Quality test.

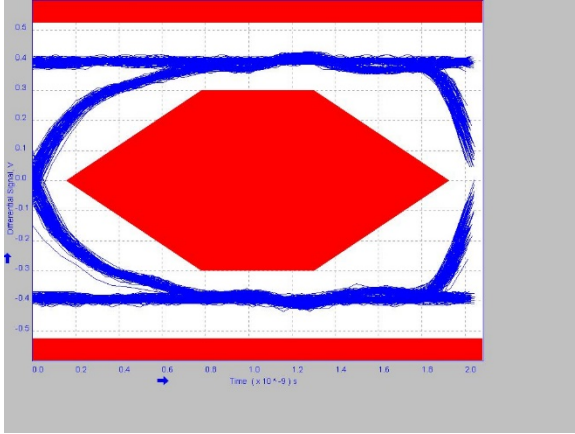

TDUSB2 USB 2.0 Signal Quality Test Eye Diagram Captured with P7330 3.5 GHz Differential Probe

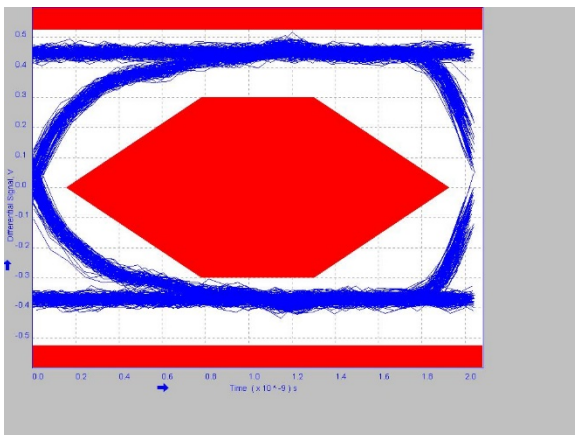

TDSUSB2 USB 2.0 Signal Quality Test Eye Diagram Captured with P6780 Differential Digital Probe using iCapture Analog MUX

- The P6780 Differential Digital probe allows you to connect simultaneously to 16 different probe points on your DUT. The iCapture Analog MUX allows you to capture waveforms from each of these probe points without needing to change connections between your DUT and the MSO70000 Series oscilloscope.



The probe inputs are 100 mil pin header compatible and the included accessory kit offer a wide selection of adapters including solder down probe tips providing connection flexibility. The P6780 Digital Logic Probe and iCapture Analog MUX gives you functionality similar to having 16 differential analog probes connected to the scope at the same time for a price similar to that of a single differential analog probe.

Summary

Tektronix' iCapture™ Analog MUX technology provides digital and analog visibility of a signal simultaneously using a single voltage probe. The advantages of using a single probe for digital and analog measurements are numerous. Digital and analog designers using oscilloscopes with iCapture™ Analog MUX gain increased insight to their designs.

Background information

- US Patent no. 6847199, "Capturing Both Digital and Analog Forms of a Signal Through the Same Probing Path"
- iCapture™ Analog MUX, is available on MSO70000 Series Mixed Signal Oscilloscopes.

