

Models 2380-500 and 2380-120 Programmable DC Electronic Load Instruments

User's Manual

2380-120-60-900-01 Rev. A / November 2015



2380-120-60-900-01A

A Greater Measure of Confidence



Models 2380-500 and 2380-120

Programmable DC Electronic Load Instruments

User's Manual

© 2015, Keithley Instruments, Inc.

Cleveland, Ohio, U.S.A.

All rights reserved.

Any unauthorized reproduction, photocopy, or use of the information herein, in whole or in part, without the prior written approval of Keithley Instruments, Inc. is strictly prohibited.

TSP®, TSP-Link®, and TSP-Net® are trademarks of Keithley Instruments, Inc. All Keithley Instruments product names are trademarks or registered trademarks of Keithley Instruments, Inc. Other brand names are trademarks or registered trademarks of their respective holders.

Document number: 2380-120-60-900-01 Rev. A / November 2015

The following safety precautions should be observed before using this product and any associated instrumentation. Although some instruments and accessories would normally be used with nonhazardous voltages, there are situations where hazardous conditions may be present.

This product is intended for use by qualified personnel who recognize shock hazards and are familiar with the safety precautions required to avoid possible injury. Read and follow all installation, operation, and maintenance information carefully before using the product. Refer to the user documentation for complete product specifications.

If the product is used in a manner not specified, the protection provided by the product warranty may be impaired.

The types of product users are:

Responsible body is the individual or group responsible for the use and maintenance of equipment, for ensuring that the equipment is operated within its specifications and operating limits, and for ensuring that operators are adequately trained.

Operators use the product for its intended function. They must be trained in electrical safety procedures and proper use of the instrument. They must be protected from electric shock and contact with hazardous live circuits.

Maintenance personnel perform routine procedures on the product to keep it operating properly, for example, setting the line voltage or replacing consumable materials. Maintenance procedures are described in the user documentation. The procedures explicitly state if the operator may perform them. Otherwise, they should be performed only by service personnel.

Service personnel are trained to work on live circuits, perform safe installations, and repair products. Only properly trained service personnel may perform installation and service procedures.

Keithley Instruments products are designed for use with electrical signals that are measurement, control, and data I/O connections, with low transient overvoltages, and must not be directly connected to mains voltage or to voltage sources with high transient overvoltages. Measurement Category II (as referenced in IEC 60664) connections require protection for high transient overvoltages often associated with local AC mains connections. Certain Keithley measuring instruments may be connected to mains. These instruments will be marked as category II or higher.

Unless explicitly allowed in the specifications, operating manual, and instrument labels, do not connect any instrument to mains.

Exercise extreme caution when a shock hazard is present. Lethal voltage may be present on cable connector jacks or test fixtures. The American National Standards Institute (ANSI) states that a shock hazard exists when voltage levels greater than 30 V RMS, 42.4 V peak, or 60 VDC are present. A good safety practice is to expect that hazardous voltage is present in any unknown circuit before measuring.

Operators of this product must be protected from electric shock at all times. The responsible body must ensure that operators are prevented access and/or insulated from every connection point. In some cases, connections must be exposed to potential human contact. Product operators in these circumstances must be trained to protect themselves from the risk of electric shock. If the circuit is capable of operating at or above 1000 V, no conductive part of the circuit may be exposed.

Do not connect switching cards directly to unlimited power circuits. They are intended to be used with impedance-limited sources. NEVER connect switching cards directly to AC mains. When connecting sources to switching cards, install protective devices to limit fault current and voltage to the card.

Before operating an instrument, ensure that the line cord is connected to a properly-grounded power receptacle. Inspect the connecting cables, test leads, and jumpers for possible wear, cracks, or breaks before each use.

When installing equipment where access to the main power cord is restricted, such as rack mounting, a separate main input power disconnect device must be provided in close proximity to the equipment and within easy reach of the operator.

For maximum safety, do not touch the product, test cables, or any other instruments while power is applied to the circuit under test. ALWAYS remove power from the entire test system and discharge any capacitors before: connecting or disconnecting cables or jumpers, installing or removing switching cards, or making internal changes, such as installing or removing jumpers.

Do not touch any object that could provide a current path to the common side of the circuit under test or power line (earth) ground. Always make measurements with dry hands while standing on a dry, insulated surface capable of withstanding the voltage being measured.

For safety, instruments and accessories must be used in accordance with the operating instructions. If the instruments or accessories are used in a manner not specified in the operating instructions, the protection provided by the equipment may be impaired.

Do not exceed the maximum signal levels of the instruments and accessories, as defined in the specifications and operating information, and as shown on the instrument or test fixture panels, or switching card.

When fuses are used in a product, replace with the same type and rating for continued protection against fire hazard.

Chassis connections must only be used as shield connections for measuring circuits, NOT as protective earth (safety ground) connections.

If you are using a test fixture, keep the lid closed while power is applied to the device under test. Safe operation requires the use of a lid interlock.

If a  screw is present, connect it to protective earth (safety ground) using the wire recommended in the user documentation.

The  symbol on an instrument means caution, risk of danger. The user must refer to the operating instructions located in the user documentation in all cases where the symbol is marked on the instrument.

The  symbol on an instrument means caution, risk of electric shock. Use standard safety precautions to avoid personal contact with these voltages.

The  symbol on an instrument shows that the surface may be hot. Avoid personal contact to prevent burns.

The  symbol indicates a connection terminal to the equipment frame.

If this  symbol is on a product, it indicates that mercury is present in the display lamp. Please note that the lamp must be properly disposed of according to federal, state, and local laws.

The **WARNING** heading in the user documentation explains dangers that might result in personal injury or death. Always read the associated information very carefully before performing the indicated procedure.

The **CAUTION** heading in the user documentation explains hazards that could damage the instrument. Such damage may invalidate the warranty.

Instrumentation and accessories shall not be connected to humans.

Before performing any maintenance, disconnect the line cord and all test cables.

To maintain protection from electric shock and fire, replacement components in mains circuits — including the power transformer, test leads, and input jacks — must be purchased from Keithley Instruments. Standard fuses with applicable national safety approvals may be used if the rating and type are the same. Other components that are not safety-related may be purchased from other suppliers as long as they are equivalent to the original component (note that selected parts should be purchased only through Keithley Instruments to maintain accuracy and functionality of the product). If you are unsure about the applicability of a replacement component, call a Keithley Instruments office for information.

To clean an instrument, use a damp cloth or mild, water-based cleaner. Clean the exterior of the instrument only. Do not apply cleaner directly to the instrument or allow liquids to enter or spill on the instrument. Products that consist of a circuit board with no case or chassis (e.g., a data acquisition board for installation into a computer) should never require cleaning if handled according to instructions. If the board becomes contaminated and operation is affected, the board should be returned to the factory for proper cleaning/servicing.

Safety precaution revision as of January 2013.

CONTENTS

SAFETY PRECAUTIONS	2
INTRODUCTION	1
WELCOME	1
EXTENDED WARRANTY	1
CONTACT INFORMATION	1
CD-ROM CONTENTS	1
KEY FEATURES	2
STANDARD ACCESSORIES	2
GENERAL RATINGS	3
QUICK REFERENCE	4
INTRODUCTION TO THE FRONT PANEL	4
INTRODUCTION TO THE KEYPAD	4
FAST FUNCTION KEYS	6
INTRODUCTION TO INDICATORS ON THE SCREEN	7
INTRODUCTION TO THE REAR PANEL	7
INSTALLATION POSITION	8
ADJUSTING THE LOAD HANDLE	10
DISASSEMBLING THE LOAD HANDLE	10
Steps:	10
INSTALLATION OF POWER LINE	11
POWER-ON SELF-TEST	12
Self-test steps	12
Exception handling	12
FUNCTION AND FEATURES	14
SWITCHING OF LOCAL / REMOTE OPERATION MODES	14
CONSTANT-STATUS OPERATION MODE	15
Constant current operation mode (CC)	15
Operation steps under CC mode	15
Constant voltage operation mode (CV)	16
Operation steps under CV mode	17
Constant resistance operation mode (CR)	17
Operation steps under CR mode	18
Constant power operation mode (CP)	18
Operation steps in CP mode	19
INPUT CONTROL FUNCTION	19
KEYPAD LOCKING FUNCTION	19
SHORT-CIRCUIT ANALOG FUNCTION	19
SYSTEM MENU INTRODUCTION	20
CONFIGURATION MENU INTRODUCTION	22
Save settings	24
TRIGGERING FUNCTION	24
Operation steps	24

DYNAMIC TEST FUNCTION	24
Continuous mode	25
Pulse mode	26
Toggle mode	27
OCP TEST FUNCTION	28
Operating steps:	29
OPP TEST FUNCTION	30
Operating steps:	31
BATTERY DISCHARGE TEST FUNCTION	31
Test procedures:	32
CR-LED TEST FUNCTION	33
MEASUREMENT OF VOLTAGE RISE TIME	34
CONFIGURATION SAVE FUNCTION	35
Operation steps	35
VON FUNCTION	36
PROTECTIVE FUNCTION	36
Overvoltage protection (OVP)	37
Overcurrent protection (OCP)	37
Overpower protection (OPP)	38
Overtemperature protection (OTP)	38
Input reverse polarity protection (RVS)	38
LIST OPERATION	39
Operation steps	39
Operation steps	41
FUNCTION OF THE TERMINALS ON THE REAR BOARD	41
Remote sense measurement function	41
External trigger function	42
External analog quantity function	42
Voltage fault indication	42
Current monitoring (I Monitor)	42
AUTO TEST FUNCTION	42
Operation steps	43
Recalling test file	45
TECHNICAL SPECIFICATIONS	46
MAJOR TECHNICAL PARAMETERS	46
ADDITIONAL FEATURES	49
SCPI COMMAND REFERENCE	50
COMMUNICATION SETTING	50
Communication Interface	50
GPIB function	50
RS-232 function	51
USB-TMC Capabilities of the Electronic Load	53
Status register	53
Condition register	56
Event register	56

Enable register	57
Queue	57
Output queue.....	57
Error queue	57
Status byte and service request (SRQ)	58
Status byte register	58
Service request enable register.....	58
Serial poll and SRQ.....	59
Trigger Model (GPIB Operation).....	59
Trigger Model Operation.....	59
SCPI COMMAND INTRODUCTION	60
SCPI	60
Command type of SCPI	60
Multiple commands in a message.....	61
Movement in the subsystem.....	61
Including Common Commands	61
Case sensitivity.....	61
Long-form and short-form versions	62
Query	62
Message Type of SCPI	62
The Message Unit	63
Headers.....	63
Query Indicator.....	63
Message Unit Separator.....	63
Root Specifier.....	63
Message Terminator	63
Command execution rules	63
SCPI Data Form.....	64
Response Data Type	64
SCPI Command Complete	65
Default setup.....	66
2380 COMMANDS	67
Common commands	67
*CLS (no query form)	68
*ESE	68
*ESR? (query only)	69
*IDN?	69
*OPC	70
*PSC.....	70
*RCL(no query form).....	71
*RST (no query form)	71
*SAV (no query form).....	72
*SRE	72
*STB?	73
*TRG.....	74
*TST?.....	74

*WAI	74
STATus subsystem	75
STATus:QUEStionable?	75
STATus:QUEStionable:ENABle	75
STATus:QUEStionable:PTRansition	76
STATus:QUEStionable:NTRansition	77
STATus:QUEStionable:CONDition?	78
STATus:OPERation?	78
STATus:OPERation:ENABle	78
STATus:OPERation:CONDition?	79
STATus:PRESet	79
SYSTem:POSetup	80
SYSTem:VERSion?	81
SYSTem:ERRor?	81
SYSTem:CLEar	82
SYSTem:LOCal	82
SYSTem:REMote	82
SYSTem:RWLock	83
SYSTem:KEY	83
DISPlay[:WINDow]:MODE	84
DISPlay[:WINDow]:TEXT	84
MEASurement subsystem	85
FETCh:VOLTage[:DC]? (query only)	85
FETCh:VOLTage:MAX? (query only)	85
FETCh:VOLTage:MIN? (query only)	86
FETCh:CURRent[:DC]? (query only)	86
FETCh:CURRent:MAX? (query only)	87
FETCh:CURRent:MIN? (query only)	87
FETCh:POWer[:DC]? (query only)	87
FETCh:CAPability? (query only)	88
FETCh:TIME? (query only)	88
MEASure:VOLTage[:DC]? (query only)	88
MEASure:VOLTage:MAX? (query only)	89
MEASure:VOLTage:MIN? (query only)	89
MEASure:CURRent[:DC]? (query only)	90
MEASure:CURRent:MAX? (query only)	90
MEASure:CURRent:MIN? (query only)	90
MEASure:POWer[:DC]? (query only)	91
MEASure:CAPability? (query only)	91
MEASure:TIME? (query only)	91
TRIGger subsystem	92
FORCe:TRIGger	92
TRIGger:SOURce	93
TRIGger:TIMer	94
TRACe subsystem	95
TRACe:CLEar	95

TRACe:FREE?	95
TRACe:POINts	95
TRACe:FEED	96
TRACe:FEED:CONTRol	96
TRACe:DATA?	97
TRACe:FILTer	97
TRACe:DELay	98
TRACe:TIMer	98
SOURce subsystem	99
[SOURce:]INPut	99
[SOURce:]INPut:SHORT	99
[SOURce:]INPut:TIMer	100
[SOURce:]INPut:TIMer:DELay	100
[SOURce:]FUNction	101
[SOURce:]FUNction:MODE	101
[SOURce:]TRANsient	102
[SOURce:]PROTection:CLear	102
[SOURce:]CURRent	103
[SOURce:]CURRent:RANGe	103
[SOURce:]CURRent:SLEW	104
[SOURce:]CURRent:SLEW:POSitive	105
[SOURce:]CURRent:SLEW:NEGative	105
[SOURce:]CURRent:SLOWrate:STATe	106
[SOURce:]CURRent:PROTection:STATe	107
[SOURce:]CURRent:PROTection:LEVel	107
[SOURce:]CURRent:PROTection:DELay	108
[SOURce:]CURRent:TRANsient:MODE	108
[SOURce:]CURRent:TRANsient:ALEVel	109
[SOURce:]CURRent:TRANsient:BLEVel	109
[SOURce:]CURRent:TRANsient:AWIDth	110
[SOURce:]CURRent:TRANsient:BWIDth	110
[SOURce:]CURRent:HIGH	110
[SOURce:]CURRent:LOW	110
[SOURce:]VOLTagE	111
[SOURce:]VOLTagE:RANGe	112
[SOURce:]VOLTagE:RANGe:AUTO[:STATe]	112
[SOURce:]VOLTagE:ON	113
[SOURce:]VOLTagE:LATCH	113
[SOURce:]VOLTagE:TRANsient:MODE	114
[SOURce:]VOLTagE:TRANsient:ALEVel	114
[SOURce:]VOLTagE:TRANsient:BLEVel	114
[SOURce:]VOLTagE:TRANsient:AWIDth	115
[SOURce:]VOLTagE:TRANsient:BWIDth	115
[SOURce:]VOLTagE:HIGH	116
[SOURce:]VOLTagE:LOW	116
[SOURce:]RESistance	116

[SOURce:]RESistance:RANGe	117
[SOURce:]RESistance:TRANSient:MODE.....	118
[SOURce:]RESistance:TRANSient:ALEvel	118
[SOURce:]RESistance:TRANSient:BLEvel	118
[SOURce:]RESistance:TRANSient:AWIDth	119
[SOURce:]RESistance:TRANSient:BWIDth.....	119
[SOURce:]RESistance:HIGH	120
[SOURce:]RESistance:LOW	120
[SOURce:]POWer.....	120
[SOURce:]POWer:RANGe	121
[SOURce:]POWer:TRANSient:MODE	121
[SOURce:]POWer:TRANSient:ALEvel	122
[SOURce:]POWer:TRANSient:BLEvel	122
[SOURce:]POWer:TRANSient:AWIDth	123
[SOURce:]POWer:TRANSient:BWIDth	123
[SOURce:]POWer:HIGH	123
[SOURce:]POWer:LOW	123
[SOURce:]POWer:PROTection	124
[SOURce:]POWer:PROTection:DELay.....	125
[SOURce:]POWer:CONFig.....	125
[SOURce:]RESistance:VDRop <NRf>	126
[SOURce:]RESistance:LED[:STATe] <BOOL>	126
LIST subsystem	126
[SOURce:]LIST:SLOWrate[:STATe] <BOOL>.....	127
[SOURce:]LIST:RANGe	127
[SOURce:]LIST:COUNT.....	127
[SOURce:]LIST:STEP	128
[SOURce:]LIST:LEVel	129
[SOURce:]LIST:SLEW	129
[SOURce:]LIST:WIDth	130
[SOURce:]LIST:SAV.....	130
[SOURce:]LIST:RCL.....	131
SENSe subsystem	131
SENSe:AVERage:COUNT.....	131
SENSe:TIME:VOLTage1	132
SENSe:TIME:VOLTage2	132
SYSTem:SENSe[:STATe] <BOOL>.....	132
Calibration subsystem	133
CALibrate:SECure[:STATe]	133
CALibrate:INITial	134
CALibrate:SAVE.....	134
CALibrate:CURREnt:POINt.....	134
CALibrate:CURREnt[:LEVel]	135
CALibrate:CURREnt:METE:r:POINt	135
CALibrate:CURREnt:METE:r[:LEVel].....	136
CALibrate:VOLTage:POINt.....	136

CALibrate:VOLTage[:LEVel]	137
CALibrate:VOLTage:METER:POINT	137
CALibrate:VOLTage:METER[:LEVel]	138
ERROR INFORMATION	139
APPENDIX	142
Wire specifications	142

Introduction

Welcome

Thank you for choosing a Keithley Instruments product. The Keithley models 2380-500-15/2380J-500-15/2380-120-60/2380J-120-60 programmable high-precision DC electronic load instruments support constant current (CC), constant voltage (CV), constant resistance (CR), constant power (CP), and transient operating modes. Its power ranges from 200 W to 250 W. The resolution of its voltage and current are 0.1 mV and 0.01 mA. Its adjustable current rise and fall times range from 0.0001 A/ μ s to 2.5 A/ μ s. Its measurement speed of voltage and current reaches up to 50 KHz. The load can be controlled externally from 0 through 10 V using analog interfaces. It is equipped with built-in ports of RS232, USB, and GPIB. The load also provides special LED mode to conduct LED power supply test by simulating LED current.

Extended warranty

Additional years of warranty coverage are available on many products. These valuable contracts protect you from unbudgeted service expenses and provide additional years of protection at a fraction of the price of a repair. Extended warranties are available on new and existing products. Contact your local Keithley Instruments office, sales partner, or distributor for details.

Contact information

If you have any questions after reviewing this information, please contact your local Keithley Instruments representative or call Keithley Instruments corporate headquarters (toll-free inside the U.S. and Canada only) at 1-888-Keithley (1-888-534-8453), or from outside the U.S. at +1-440-248-0400. For worldwide contact numbers, visit the Keithley Instruments website (<http://www.keithley.com>).

CD-ROM contents

The Series 2380 Product Information CD-ROM is shipped with each electronic load.

The Product Information CD-ROM contains:

- **User's Manual:** Includes basic operation topics and maintenance information.
- **Performance Verification:** Contains performance verification procedures. Additional test equipment is required to complete the verification procedures.
- **Accessories information:** Documentation for accessories that are available for the Model 2380.

For the latest drivers and additional support information, see the Keithley Instruments website (<http://www.keithley.com>).

Key features

The Series 2380 has the following features:

- High-visibility vacuum fluorescent display (VFD)
- Dynamic mode: up to 25 KHz
- Voltage and current measurement resolution rate: up to 0.1 mV and 0.01 mA (10 uA)
- Voltage and current measurement speed: up to 50 KHz
- Four operation modes: constant voltage, constant current, constant resistance and constant power.
- Navigation control for easy and quick operation
- Remote sense test function
- Battery test function
- OCP test, OPP test
- Auto test function
- CR-LED test
- Memory capacity: 100 groups
- Short-circuit function
- Dynamic test function
- Portable and robust structure equipped with skid resistant foot stand
- Intelligent fan control
- Built-in warning buzzer
- Outage backup memory
- Built-in GPIB, USB and RS232 communication interfaces

Model	Voltage	Current	Power
2380-500-15	500 V	15 A	200 W
2380J-500-15	500 V	15 A	200 W
2380-120-60	120 V	60 A	250 W
2380J-120-60	120 V	60 A	250 W

Standard accessories

Accessory	Part number
Programmable DC Electronic Load Product Information CD-ROM	2380S-950-01
Certificate of Compliance	001165500
USB cable	174684100

You will also get one of the following power cords:

Option	Description
Option A0	North America and South America. The factory sets the line-voltage selector switch to 110 V.
Option A1	Universal Euro. The factory sets the line-voltage selector switch to 220 V.
Option A2	United Kingdom. The factory sets the line-voltage selector switch to 220 V.
Option A3	Australia. The factory sets the line-voltage selector switch to 220 V.
Option A4	Chile, Italy. The factory sets the line-voltage selector switch to 220 V.
Option A5	Switzerland. The factory sets the line-voltage selector switch to 220 V.
Option A6	Denmark. The factory sets the line-voltage selector switch to 220 V.
Option A7	Israel. The factory sets the line-voltage selector switch to 220 V.
Option A8	Argentina. The factory sets the line-voltage selector switch to 220 V.
Option A9	China. The factory sets the line-voltage selector switch to 220 V.
Option A10	India. The factory sets the line-voltage selector switch to 220 V.

General ratings

The general ratings and connections of Series 2380 are listed in the following table.

Category	Specification
Power supply	100/220 V, 115/230 V, 50 Hz or 60 Hz
Operating altitude	Maximum 2000 m (6562 ft) above sea level
Environmental conditions	<p>For indoor use only</p> <p>Operating: 0 °C to 40 °C (32 °F to 104 °F), full accuracy with maximum 80% relative humidity at up to 40 °C (104 °F), non-condensing</p> <p>Storage: -20 °C to 70 °C (-4 °F to 158 °F), 10% to 85% relative humidity at up to 40 °C (+104 °F) and 5% to 60% relative humidity above 40 °C (+104 °F) up to 70 °C (+158 °F)</p> <p>Pollution degree: 2</p> <p>Installation category: II</p>

Quick Reference

Introduction to the front Panel

The front panel of 2380-500-15/2380J-500-15/2380-120-60/2380J-120-60 is shown in the next figure.

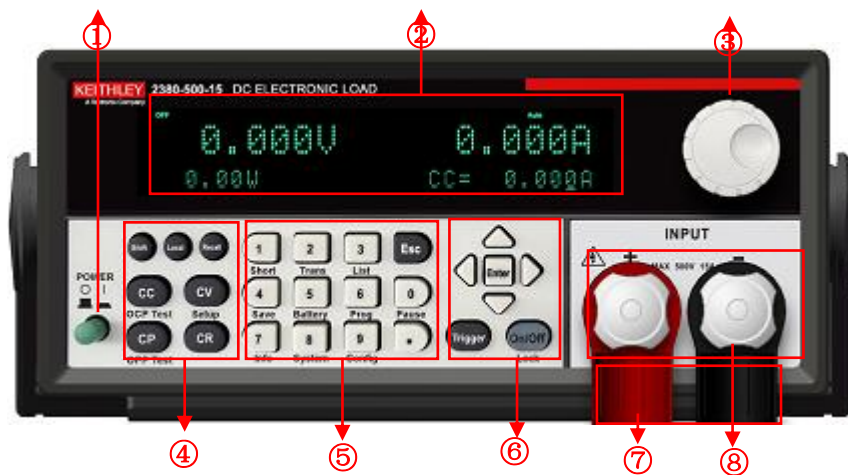

Figure 1 The front panel

No.	Explanation	No.	Explanation
1	Power On/Off switch	2	VFD display
3	Navigation control	4	Function keys
5	Numeric keypad, Esc key, and combination button	6	Navigation arrow keys, Enter, Trigger and On/Off button
7	Protective cover	8	Input terminals

Introduction to the keypad

The keypad of 2380-500-15/2380J-500-15/2380-120-60/2380J-120-60 is shown in the next figure.































Figure 2 Keypad on the front panel

The following table explains the keys and buttons on the keypad.

	Enables access to secondary functions
	Sets the instrument to local mode
	Recall stored instrument settings
	Sets the load to CC mode and configures the current value
	Sets the load to CV mode and configures the voltage value
	Sets the load to CR mode and configures the resistance value
	Sets the load to CP mode and configures the power value
	Sets the load to trigger mode for list and transient function
	Turns the instrument on or off
	Confirms settings
	Up arrow key
	Down arrow key
	Left/Right arrow keys
	Enters numeric values for various parameters
	Decimal point
	Cancels the current action and returns to the previous menu

Fast function keys

A combination of front board keys and Shift composition keys in 2380 Series can realize functions marked at key bottom. For details, see table below.

 +  (Short)	To start or end short circuit test
 +  (Trans)	To set dynamic operation parameters
 +  (List)	To set list operation function
 +  (Save)	To save existing setting load parameter values, e.g., voltage, current and power
 +  (Battery)	To enable battery test function
 +  (Prog)	To enable auto test function
 +  (Info)	To display model, version number and serial number of electronic load To view the error information when Error symbol is displayed on VFD (the error information is displayed one item per pressing)
 +  (System)	To set system menu
 +  (Config)	To configure system menu
 +  (Pause)	To pause operation during the automatic test
 +  (OCP Test)	To enable OCP test function
 +  (Setup)	To set specific parameters of constant voltage, constant current, constant resistance, and constant power
 +  (OPP Test)	To enable OPP test function
 +  (Lock)	To enable Keyboard locking function

Introduction to indicators on the screen

OFF	The load is off	Error	Error has occurred
Rmt	The load is under remote operation mode	Trig	The load is waiting for triggering signal
Addr	Send command under remote operation	Sense	The load is under remote sense input mode
SRQ	Serial request query	Prot	The load is in overcurrent protection status
*	Keyboard locking function is enabled	Rear	External analog quantity function is enabled
Shift	Shift key is pressed	Auto	Automatic voltage range is enabled

Introduction to the rear panel

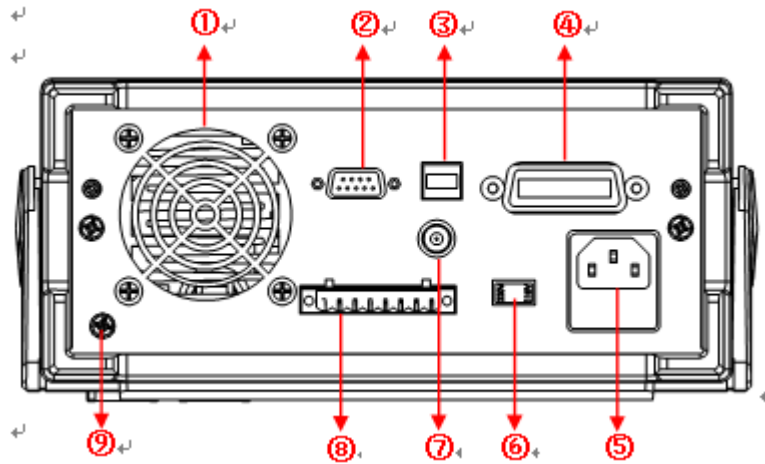

Figure 3 The rear panel

1. Vent hole
2. RS232 communication cable interface
3. USB communication cable interface
4. GPIB communication cable interface
5. AC power input socket (including fuse)
6. AC power switch key
7. Current monitoring terminal
8. Remote sense compensation terminal, external triggering terminal and external analog 0-10 V control terminal
9. Ground terminal

Installation Position

The instrument should be installed at a well-ventilated and rational-sized space. Please select appropriate space for installation based on the electronic load size.

Model 2380-500-15/2380J-500-15/2380-120-60/2380J-120-60

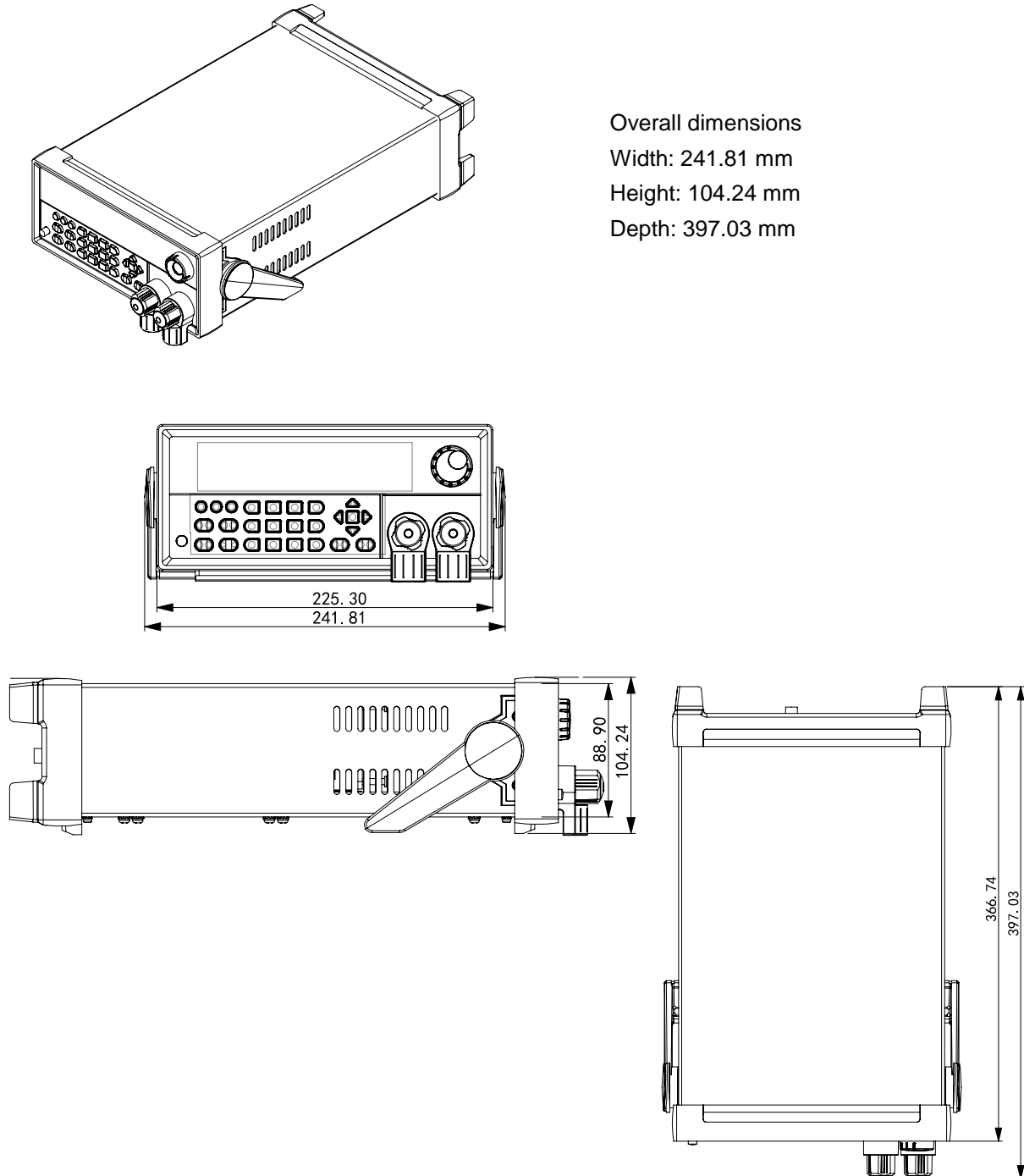

Figure 4 Detailed dimensional drawings

 **CAUTION**

When DC input voltage is more than 60 VDC, basic insulation should be maintained between both polarities of the power source and ground.

DC input short circuit and overcurrent protection should be provided by an external DC power source.

Where access to the main power cord is restricted, a separate main input power disconnect device must be provided in close proximity to the equipment and within easy reach of the operator. Attachment plug is used as disconnect device. It shall be readily operable.

Adjusting the load handle

The load handle may be adjusted based on three methods (as shown in icons below). Be sure that appropriate force is applied to adjust the load handle to an appropriate position.

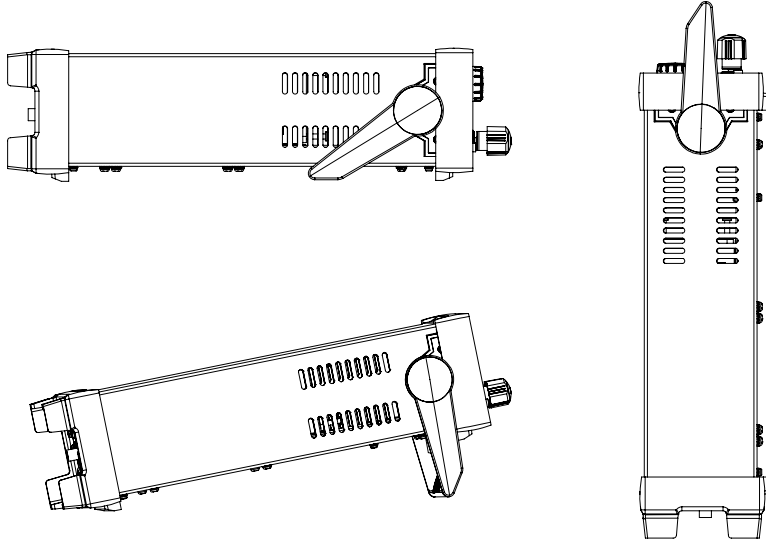

Figure 5 Adjusting load handles

CAUTION

Do not lift the instrument by holding the front bezel because it may cause damage to the instrument.

Disassembling the load handle

Please disassemble the load handle before installing the equipment.

Steps:

1. Adjust the handle to the position as shown in the figure below.

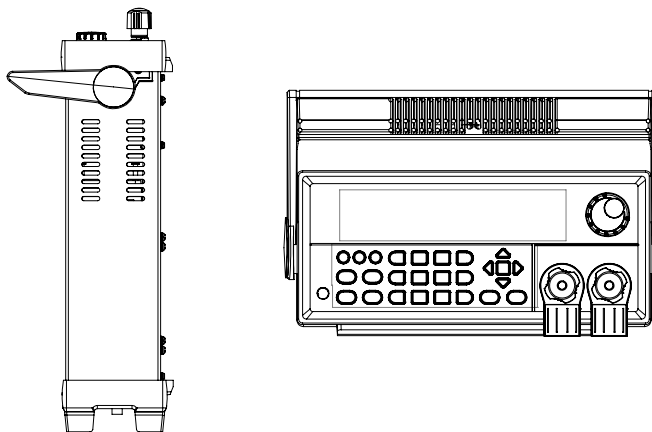

NOTE

To easily disassemble handle, align the locking mouth and locking device, which are between the handle and the instrument.

2. Align the locking mouth, and pull out the handle from two sides.

NOTE

Do not use too much force and mind your hands when disassembling the load handles.

Installation of power line

Connect power line from the standard accessories to the instrument and ensure that the electronic load is properly sourced by the power supply.

AC power input level

The working voltage of 2380-500-15 / 2380-120-60 also include 115 V and 230 V, and the working voltage of 2380J-500-15 / 2380J-120-60 also include 100 V and 220 V (which can be selected through the switch on the rear board).

2380-500-15 / 2380-120-60 AC power input level:

- Option Opt.1: 230 Vac \pm 10% 50 Hz / 60 Hz
- Option Opt.2: 115 Vac \pm 10% 50 Hz / 60Hz

2380J-500-15 / 2380J-120-60 AC power input level:

- Option Opt.1: 220 Vac \pm 10% 50 Hz / 60 Hz
- Option Opt.2: 100 Vac \pm 10% 50 Hz / 60 Hz

Installation of protective ground terminal

The protective ground terminal on the rear panel is designed to accept approved compression lug.

Protective ground wiring must be done by qualified electrician or trained personnel according to national electrical codes. The cross-section area of the protective ground cable should be the same or larger than the power cable.

Power-on self-test

Before operation, please confirm that you fully understand the safety instructions.

WARNING

To avoid burning out, be sure to confirm that the power voltage matches with the supply voltage.

Be sure to connect the main power socket to the power outlet with protective grounding. Do not use terminal board without protective grounding.

Before operation, be sure that the electronic load is well-grounded.

To avoid burning out, pay attention to marks of positive and negative polarities before wiring.

Self-test steps

1. Properly connect the power line.
2. Press **Power** key to turn the instrument on.
3. The VFD screen displays the software version number "**BOIS Ver 1.XX**".
4. After approximately 1 s, the system starts conducting self-test and the VFD displays "**System Selftest....**"
5. After the self-test, the VFD displays information, as shown in the below.



0.0000V0.0000A

0.00W CC=0.000A

Information description:

The first line displays actual input voltage and current values.



The second line displays setting values of power and current.

6. Press  +  (Info), the VFD screen displays related information of the product, as shown in the below.

2380-XXX-XX

Ver:1.XX-1.XX

SN:XXXXXXXXXXXXXXXXXXXX

7. Press   key to switch between the display of product model, product serial number, and software version number.

Exception handling

If the instrument cannot start properly, take the following steps:

1. Check whether the power line is correctly connected.
 - a. If yes, go to step 2
 - b. If no, connect the power line correctly.
2. Check whether the power is turned on
 - a. If yes, go to step 3.
 - b. If no, turn the power on.
3. Check whether the specified voltage of the instrument is larger than the power supply voltage. If the specified voltage is 220 V and the power supply voltage is 100 V, the instrument cannot start.
4. Check whether the fuse of the instrument is burned out.

If yes, change the fuse according to the following steps:

 - a. Pull out the power line from its socket.
 - b. Take out the fuse box using a small screw driver, as shown below.

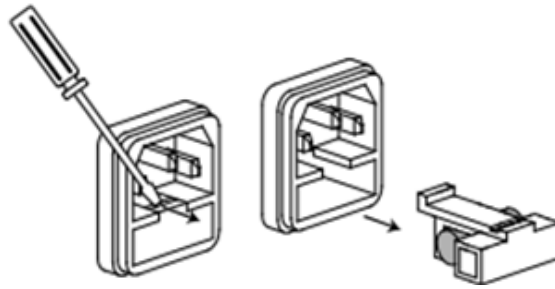

- c. Change the fuse based on the machine model. Refer to the table in the below to choose the right fuse for the model.

Product	Fuse specification	Fuse specification
2380-500-15	1.25 AT (115 Vac)	0.5 AT (230 Vac)
2380J-500-15	1.25 AT (100 Vac)	0.5 AT (220 Vac)
2380-120-60	1.25 AT (115 Vac)	0.5 AT (230 Vac)
2380J-120-60	1.25 AT (100 Vac)	0.5 AT (220 Vac)

- d. Install the fuse box back to the socket, as shown in the below.

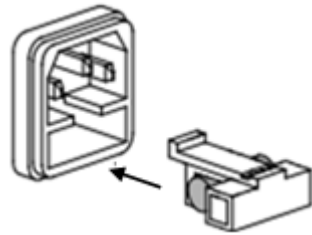

Function and Features

This Chapter gives a detailed description of functions and features of the electronic load instrument. It contains the following parts:

- Switching of local / remote operation modes
- Constant-status operation mode
- Input control function
- Keyboard locking function
- Dynamic simulation function
- System menu function
- Configuration menu function
- Triggering function
- Dynamic test function
- OCP test function
- OPP test function
- Battery discharge test function
- CR-LED function
- Measurement of voltage rise time
- Save function
- VON function
- Protective function
- List function
- Terminal function of rear board
- To operate auto test function

Switching of local / remote operation modes

The electronic load can work under both local and remote operation modes. You can switch these two modes through commands, refer to SYSTem:LOCAl and SYSTem:REMote. The electronic load works under local operation mode initially.

The two modes are explained in the below:

- Local operation mode: you can operate the instrument through keys on the front panel.
- Remote operation mode: you can operate the instrument on PC. Under remote operation

mode, all the keys on the board except ,  +  (Info), ,  and , are

disabled. The  key can also be used for switching the instrument to local operation mode.

Constant-status operation mode

The electronic mode can work under 4 constant-status operation modes:

- Constant current operation mode (CC)
- Constant voltage operation mode (CV)
- Constant resistance operation mode (CR)
- Constant power operation mode (CP)

Constant current operation mode (CC)

Under CC mode, the electronic load consumes constant current regardless of whether the input voltage changes or not, as shown in the following figure.

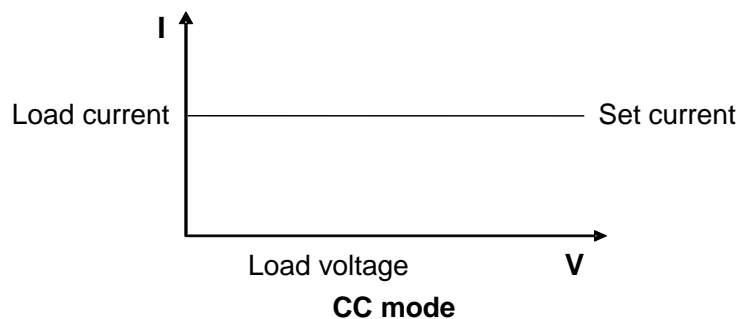













Figure 6 Voltage-current relation under CC mode

You can set the constant current by one of the following ways:

- Turn the navigation control to set the constant current.
- Use numeric keys to input the current value and press  to confirm the setting.
- Press  and  to adjust the value.

Operation steps under CC mode

1. Press  key and  +  to enter parameter setting screen. The following text is displayed.
Constant Current
Range=0.000A
2. Set maximum working current value and press  to confirm. The following text is displayed.
Constant Current
Range =1.000A
3. Set maximum voltage value and press  key. The following text is displayed.
Constant Current
High=0.00V

4. Set minimum voltage value and press  key. The following text is displayed.
Constant Current
Low=0.000V
5. Set high and low rate and press  key. The following text is displayed.
Constant Current
High-Rate Low-Rate
6. Set ascending slope and press  key. The following text is displayed.
Constant Current
Rise up=5.000A/uS
7. Set descending slope and press  key. The following text is displayed.
Constant Current
Fall down=5.000A/uS
8. Complete the parameter setting. The following text is displayed.
10.0000V 0.0000A
0.00W CC=1.000A

NOTE

If you are editing auto test steps, constant current range can also be set.

Constant voltage operation mode (CV)

Under CV mode, the electronic load consumes sufficient current to maintain the input voltage at the constant setting voltage, as shown in the following figure.

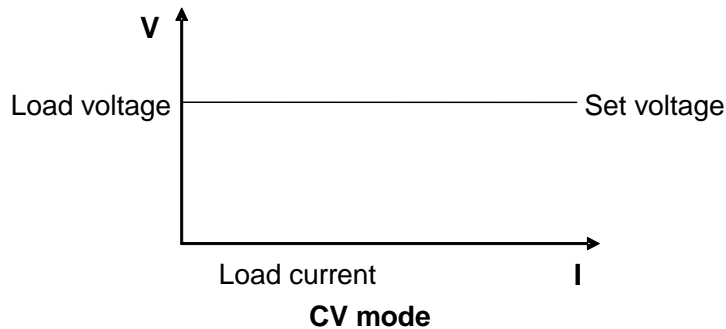





Figure 7 Voltage-current relation under CV mode

You can set the constant voltage by one of the following ways:

- Turn the navigation control to set the constant voltage.
- Use numeric keys to input the voltage value and press  to confirm the setting.
- Press  and  to adjust the value.

Operation steps under CV mode

- Press **CV** and **Shift** + **CV** to enter parameter setting screen. The following text is displayed.
Constant Voltage
Range=120.00V
- Set maximum working voltage value and press **Enter**. The following text is displayed.
Constant Voltage
Range=2.33V
- Set maximum current value and press **Enter**. The following text is displayed.
Constant Voltage
High=15.000A
- Set minimum current value and press **Enter**. The following text is displayed.
Constant Voltage
Low=0.0000A
- Complete the parameter setting. The following text is displayed.
10.0000V 0.0000A
0.00W CV=2.33V

NOTE

If you are editing auto test steps, constant voltage range can also be set.

Constant resistance operation mode (CR)

Under CR mode, the electronic load is set to a constant resistance. The relation of the voltage and current is shown in the following figure.

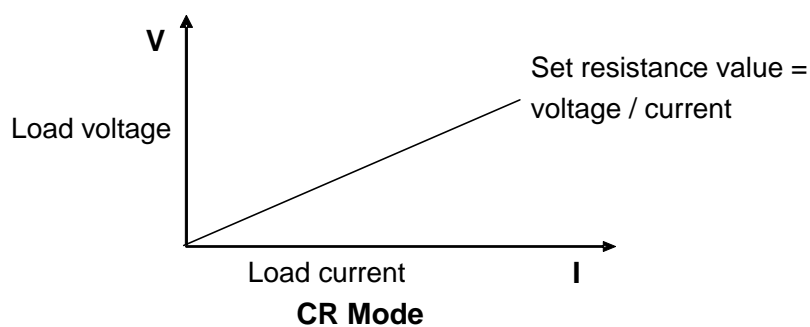

Figure 8 Voltage-current relation under CR mode

You can set the constant resistance by one of the following ways:

- Turn the navigation control to set the constant resistance.
- Use numeric keys to input the value and press **Enter** to confirm the setting.
- Press **Left** and **Right** to adjust the value.

Operation steps under CR mode

- Press **CR** and **Shift** + **CV** to enter the parameter setting screen. The following text is displayed.
Constant Resistance
Range=7500.0Ω
- Set maximum working resistance value and press **Enter**. The following text is displayed.
Constant Resistance
Range=2000.0Ω
- Set maximum voltage value and press **Enter**. The following text is displayed.
Constant Resistance
High=130.0V
- Set minimum voltage value and press **Enter**. The following text is displayed.
Constant Resistance
Low=0.000V
- Complete parameter setting. The following text is displayed.
10.0000V 0.0000A
0.00W CR=2.000Ω

NOTE

If you are editing auto test steps, constant resistance range can also be set.

Constant power operation mode (CP)

Under CP mode, the electronic load operates with a constant power. The relation between the voltage and current is explained in the following figure.

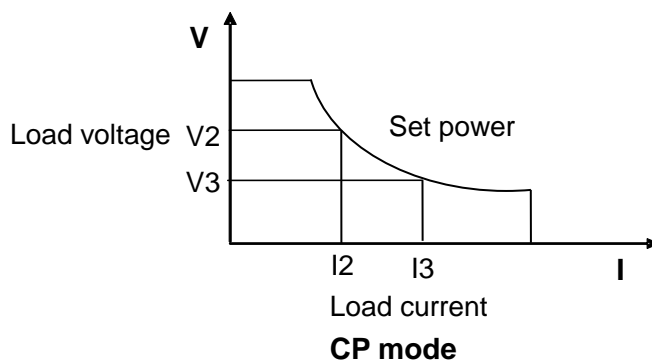

Figure 9 Voltage-current relation under CP mode

You can set the constant power by one of the following ways:

- Turn the navigation control to set the constant power.
- Use numeric keys to input the value and press **Enter** to confirm the setting.
- Press **Left** and **Right** to adjust the value.

Operation steps in CP mode

1. Press **CP** and **Shift** + **CV** to enter the parameter setting screen. The following text is displayed.
Constant Power
Range=400.00W
2. Set maximum working power value and press **Enter**. The following text is displayed.
Constant Power
Range =300.00W
3. Set maximum voltage value and press **Enter**. The following text is displayed.
Constant Power
High=130.00V
4. Set minimum voltage value and press **Enter**. The following text is displayed.
Constant Power
Low=0.000V
5. Complete parameter setting. The following text is displayed.
10.0000V 0.0000A
0.00W CP=1.00W

NOTE

If you are editing auto test steps, constant power range can also be set.

Input control function

You can control the input of the electronic load by pressing **On/Off** on the front panel. If **On/Off** indicator is on, the input is on, and the OFF indicator on the VFD screen disappears. If **On/Off** is off, the OFF indicator on the VFD screen appears.

Keypad locking function



Press **Shift** + **On/Off** to lock the keypad, and the VFD displays *. Except **On/Off**, **Shift** + **7** (Info), **△**, **▽** and **Esc**, other keys are disabled. Press **Shift** + **On/Off** to cancel the locking.

Short-circuit analog function

The electronic load can analog a short circuit. On the front panel, press **Shift** + **1** to switch to the short circuit mode. The short circuit mode does not influence the existing settings. When the short-circuit analog is turned off, the instrument functions again with the existing settings.

In the short circuit mode, the current value is determined by the operation mode and the current range. Under CC, CP and CR modes, maximum short-circuit current is 110% of the current range. Under CV mode, short-circuit current equals to current when constant voltage is 0 V.



System menu introduction

You can press  +  to enter the system setting menu. You can switch between the setting options by pressing the left/right arrow key on the front panel. The settings are explained in the following table.

Initialize	Press Enter when this option is highlighted, INITIALIZE SYSTEM? is displayed on the screen.	
	NO	Keep existing configurations.
	YES	Restore all configurations to default values.
Power-ON	Press Enter when this option is highlighted, POWER-ON SET is displayed on the screen.	
	RST (default)	Set the input status after powered-on as RST. Every time when the load is powered on, the settings are reset.
	SAV0	Set the input status after powered-on as SAV0. The settings from previous configuration are saved if the load is turned off.
Buzzer	Press Enter when this option is highlighted, BUZZER STATE is displayed on the screen.	
	On (default)	Set the buzzer as On.
	Off	Set the buzzer as Off.
Knob	Press Enter when this option is highlighted, LOAD ON KNOB MODE is displayed on the screen. You can set the navigation control here.	
	Update (default)	Set the knob mode as Update. When you turn the navigation control, the value changes are saved when the load is turned off.
	Old	Set the knob mode as Old. When you turn the navigation control, the value changes are not saved when the load is turned off.
Trigger	Press Enter when this option is highlighted, TRIGGER SOURCE is displayed on the screen.	
	Manual (Def)	Manual trigger
	External	External trigger
	Hold	Command trigger
	Bus	GPIB bus trigger
	Timer	Timer trigger
Display	Press Enter when this option is highlighted, DISPLAY ON TIMER is displayed on the screen. You can set the timer displayed on the screen.	
	On	The timer is on and displayed on the screen.
	Off (default)	The timer is off.

Communication	Press Enter when this option is highlighted, COMMUNICATION is displayed on the screen. You can set the interface for the communication between the instrument and the computer.	
	RS232	Press Enter to set this interface. You can change the setting by pressing the up/down arrow.
		4800, 8, N non parity check, 1, NONE
		9600 O odd parity check CTS/RTS
		19200 E even parity check XON/XOFF
		38400
	57600	
115200		
USBTMC		Set the communication interface as USB.
GPIB		Set the communication interface as GPIB. You can set Address by pressing up/down arrow or numeric keys, or turning navigation knob, when the digit is highlighted, the value range is from 0 to 30.
Protocol	Press Enter when this option is highlighted, PROTOCOL is displayed on the screen. You can select the communication protocol here.	
	SCPI (default)	Set the communication protocol as SCPI.
	Extend-Table	Expand the SCPI protocol for compatibility of other machines

Configuration menu introduction

You can press  +  to enter the interface of configuration menu. You can switch between the setting options by pressing the left/right arrow key on the front panel.



Von	Press Enter when this option is highlighted, VON LATCH is displayed on the screen. You can configure the settings for the latch function here.	
	On	Press Enter . Set the starting voltage point of latch function after Point=.
	Off	Press Enter . Set the ending voltage point of latch function after Point=.
Protect	Press Enter when this option is highlighted, PROTECT MENU is displayed on the screen.	
	OPP SET Press Enter when this option is highlighted, MAX POWER is displayed on the screen. You can set the hardware power protection by setting the maximum power. You can press the up/down arrow or numeric keys, or turning navigation knob, to change the number in Point=149.99 W to set the protective power value.	
	I-Limit	Press Enter when this option is highlighted, CURRENT LIMIT is displayed on the screen.
		On Press Enter when On is highlighted, Point=15.000A is displayed. You can set the current limit by pressing up/down arrow key or numeric keys, or turning navigation knob. Press Enter when the current limit setting is finished, Delay= 3S is displayed. You can set the current protection delay by pressing up/down arrow key or numeric keys, or turning navigation knob.
	Off	Set the current protection as off.
P-Limit	Press Enter when this option is highlighted, POWER LIMIT is displayed on the screen. You can set the power protection here.	You can set the power limit by pressing the up/down arrow key to or numeric keys, or turning navigation knob, change the number in Point=150W. Press Enter when the power limit setting is finished, Delay= 3S is displayed. You can set the power protection delay by pressing up/down arrow key or numeric keys, or turning navigation knob.
	Timer	Press Enter when this option is highlighted, ON-TIMER is displayed. You can set the delay by pressing up/down arrow key or numeric keys, or turning navigation knob, to change the number in

		displayed on the screen.	Delay=10.00S. Press Enter when Off is highlighted, timer is turned off.
Measure	Press Enter when this option is highlighted, MEASURE MENU is displayed on the screen.		
	V-Range	Press Enter when this option is highlighted, VOLTAGE AUTO RANGE is displayed. This function is only effective in CC mode.	Select On to start auto voltage range.
			Select Off to stop auto voltage range.
	TimeV1	Press Enter when this option is highlighted, TIMER VOLTAGE1 is displayed.	You can set the first voltage value for measuring voltage rise/drop time by pressing up/down arrow key or numeric keys, or turning navigation knob, to change the number in Point=0.00V.
	TimeV2	Press Enter when this option is highlighted, TIMER VOLTAGE2 is displayed.	You can set the second voltage value for measuring voltage rise/drop time by pressing up/down arrow key or numeric keys, or turning navigation knob, to change the number in Point=500.00V.
Filter	Press Enter when this option is highlighted, FILTER is displayed.	You can set the average count by pressing up/down arrow key or numeric keys, or turning navigation knob, to change the bracketed number in Average Count=2^(14). The value ranges from 2 to 16.	
CR-LED	Press Enter when this option is highlighted, CR LED MODE is displayed on the screen. You can set the LED state in the CR mode.		
	On		Enable LED in the CR mode.
	Off		Disable LED in the CR mode.
Remote-Sense	Press Enter when this option is highlighted, REMOTE SENSE STATE is displayed on the screen.		
	On		Enable remote sense compensation.
	Off		Disable remote sense compensation.
Ext-Program	Press Enter when this option is highlighted, EXT PROGRAM is displayed on the screen.		
	On		Enable the external 0-10 V analog control.
	Off		Disable the external 0-10 V analog control.

Save settings

You can save your configuration in the internal nonvolatile memory (NVM). Your configurations include:

- Configurations under SYSTEM menu
- Configurations under CONFIG menu
- Settings for 4 modes of CC/CV/CR/CP
- Settings for TRAN parameters, LIST parameters, and OCP/OPP parameters

You can erase all your configurations by pressing  +  + .









Triggering function

You need to configure the triggering function to operate dynamic pulse output and list output.

There are five ways to trigger the instrument:

- Press  to trigger an operation, provided that the key is enabled.
- Apply a low pulse (> 10 us) through the triggering input terminal on the rear panel to trigger an operation, provided that the triggering input terminal is enabled.
- Send the command GET or * TRG through the GPIB port to trigger an operation, provided that the bus trigger is enabled.
- Set a time trigger to trigger an operation according to the time setting.
- Send the command FORC:TRIG to trigger an operation, provided that trigger holding is enabled.

Operation steps

1. Press  +  to enter system menu setting screen.
2. Press   to move to the Trigger.
3. Press  to enter triggering source selection screen.
4. Press   to select triggering source. The five triggering sources are explained in the below:
 - Manual (Def): Manual trigger
 - External: external signal trigger
 - Hold: command trigger
 - Bus: BUS command trigger
 - Timer: timer trigger
5. Press  to complete the setting.
6. Press  to exit the setting. The system displays original values under different modes.

Dynamic test function

In order to test the dynamic performance of a power supply, the electronic load can switch between two settings of values.

Press **Shift** + **2** on the front panel to enter the configuration menu of dynamic test. You need to set the following parameters:

- Dynamic test mode
- A value
- B value
- Pulse width time
- Frequency
- Duty ratio
- Current ascending and descending slopes for CC mode

The dynamic test modes are:

- Continuous mode
- Pulse mode
- Toggle mode

Continuous mode

Under continuous mode and with dynamic test function enabled, the electronic load switch continuously between A value and B value.

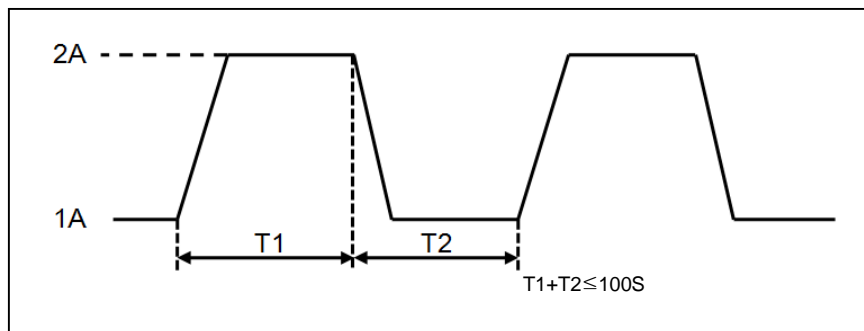















Figure 10 Dynamic test in continuous mode

The next procedure takes CC mode as an example since the procedure with other modes are similar. If the output voltage and current of the tested instrument are 10 V and 3 A respectively, the load switches its current between 1 A and 2 A.

To set the dynamic test parameters and perform the test:

1. Press **Shift** + **2**, the following text is displayed.
TRANSITION
On Off
2. Press **Left** **Right** to move the highlight to On.
3. Press **Enter** and select Continuous.
4. Press **Enter**. The Trig indicator on the VFD screen is turned on.
5. Press **Left** **Right** to move the highlight to High-Rate.

6. Press .
7. Set ascending slope after Rise Time and press .
8. Set descending slope after Fall Time and press .
9. Set A value after Level A and press .
10. Set B value after Level B and press .
11. Set frequency value and press . The range of the frequency value is from 0.01 to 25000 Hz.
12. Set duty ratio and press . The range of the duty ratio is from 0.01% to 99.99%.
13. If On is highlighted, press  to start the dynamic test. The following text is displayed.
10.0000V 0.0000A
0.00W 0 TRAN
14. Press  to open input.
15. Press .
The load continuously switches between A and B value. Time of operation is shown at the bottom right of the screen.
16. Press  /  /  /  or any composite key to exit dynamic test function.
For other modes, repeat steps 1-15 to set the parameters and start the dynamic test.

Pulse mode

Under pulse mode with dynamic test function enabled, the load will switch to A value after receiving a trigger signal and switch back to B value after the pulse width time, as shown in the following figure.

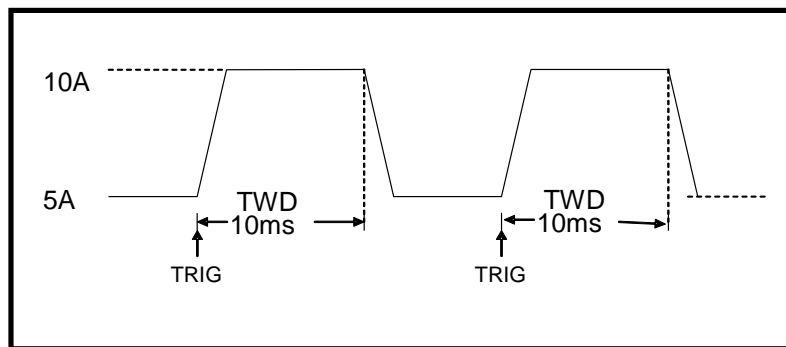





















Figure 11 Dynamic test in pulse mode

The next procedure takes CC mode as an example since the procedure with other modes are similar. If the output voltage and current of the tested instrument are 10 V and 3 A respectively, the load switches its current between 1 A and 2 A.

To set the dynamic test parameters and perform the test:

1. Press  + , the following text is displayed.
TRANSITION
On Off
2. Press   to move the highlight to On.

3. Press  and select Pulse.
 4. Press . The Trig indicator on the VFD screen is turned on.
 5. Press  to move the highlight to High-Rate.
 6. Press .
 7. Set ascending slope after Rise Time and press .
 8. Set descending slope after Fall Time and press .
 9. Set A value after Level A and press .
 10. Set B value after Level B and press .
 11. Set pulse time width after Pulse Width and press . The range of this value is from 0.00002 to 3600 s.
 12. If On is highlighted, press  to start the dynamic test. The following text is displayed.
10.0000V 0.0000A
0.00W 0 TRAN
 13. Press  to open input.
 14. Press .
The load switches between A and B value based on the triggering signal. Time of operation is shown at the bottom right of the screen.
 15. Press  /  /  /  or any composite key to exit dynamic test function.
- For other modes, repeat steps 1-14 to set the parameters and start the dynamic test.

Toggle mode

Under toggle mode with dynamic test function enabled, the load switches between A value and B value upon receiving a trigger signal, as shown in the following figure.

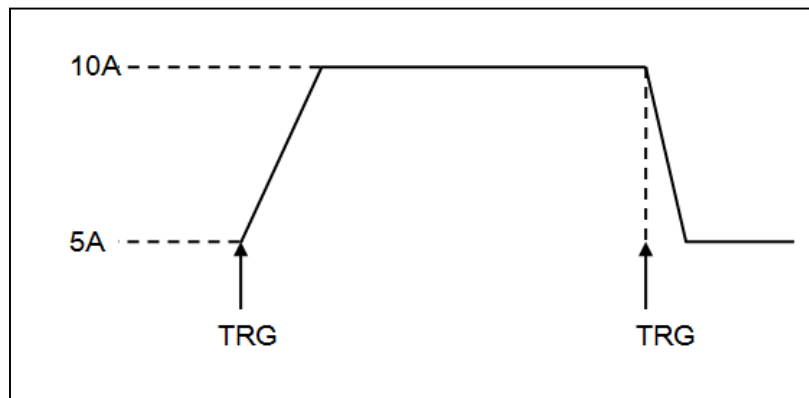



Figure 12 Dynamic test in toggle mode



















The next procedure takes CC mode as an example since the procedure with other modes are similar. If the output voltage and current of the tested instrument are 10 V and 3 A respectively, the load switches its current between 1 A and 2 A.

To set the dynamic test parameters and perform the test:

1. Press  + , the following text is displayed.

TRANSITION

On Off

2. Press   to move the highlight to On.
 3. Press  and select Toggle.
 4. Press . The Trig indicator on the VFD screen is turned on.
 5. Press   to move the highlight to High-Rate.
 6. Press .
 7. Set ascending slope after Rise Time and press .
 8. Set descending slope after Fall Time and press .
 9. Set A value after Level A and press .
 10. Set B value after Level B and press .
 11. If On is highlighted, press  to start the dynamic test. The following text is displayed.
10.0000V 0.0000A
0.00W 0 TRAN
 12. Press  to open input.
 13. Press .
- The load switches between A and B value based on the triggering signal. Time of operation is shown at the bottom right of the screen.
14. Press  /  /  /  or any composite key to exit dynamic test function.

For other modes, repeat steps 1-13 to set the parameters and start the dynamic test.

OCP test function

The 2380 series electronic load can test the OCP function of a power supply.

The instrument conduct the test in OCP test mode. The test is explained as follows:

1. Set a Von (voltage on) value along with other parameters on the load.
2. Source the load by the power supply under test.
3. If the input voltage reached Von value, delay for a while for the electronic load to latch.
4. Raise input current value step by step at a regular interval.
5. Check the load input voltage to see whether it is higher than preset voltage value for OCP.
 - If yes, OCP does not occur.
 - If no, OCP occurs.
6. Check whether the current is within target scope if the OCP occurs. If yes, the power supply passes the test.

NOTE

DC input short-circuit / overcurrent protection should be supplied by external DC power source.

Press **Shift** + **CC** to enter OCP test function setting screen.

Run	Press Enter when this option is highlighted to start the OCP test.	
Recall	Press Enter when this option is highlighted, Recall OCP File=1 is displayed. You can select a file to recall a test. You can select which file to recall by changing the number. 5 files can be saved and recalled.	
Edit	Press Enter when this option is highlighted, you can set the parameters for the OCP test here.	
	1:Voltage on level=0.000V	Set Von voltage value.
	2:Voltage on Delay=0.00S	Set Von voltage delay time.
	3:Current Range=0.000A	Set working current range.
	4:Start Current=0.000A	Set initial current value.
	5:Step Current=0.000A	Set step current value.
	6:Step Delay=0.00S	Set step delay time.
	7:End Current=0.000A	Set cutoff current value.
	8:Voltage Standard =0.000V	Set standard voltage value.
	9:Max Trip Current=0.000A	Set overcurrent range (maximum value).
	10:Min Trip Current=0.000A	Set overcurrent range (minimum value).
	Save OCP File=1	Save OCP test documents.

Operating steps:

1. Press **Trigger** to start the OCP test. If the power supply passes the test, the following is displayed:

9.9973V	0.0005A		
0.01W	5.100A	PASS	STOP

If the power supply does not pass the test, the following is displayed:

9.9973V	0.0005A		
0.01W	5.100A	FAULT	STOP

2. Press **Esc** to return to the setting screen.

NOTE

If the set voltage value for OCP is higher than the Von value, OCP does not occur, and the following is displayed:

9.9990V	0.0009A		
0.01W	0.100A	FAULT	STOP

OPP test function

The 2380 series electronic load can test the OPP function of a power supply.

The instrument conduct the test in OPP test mode. The test is explained as follows:

1. Set a Von (voltage on) value along with other parameters on the load.
2. Source the load by the power supply under test.
3. If the input voltage reached Von value, delay for a while for the electronic load to latch.
4. Raise input power value step by step at a regular interval.
5. Check the load input voltage to see whether it is higher than preset voltage value for OPP.
 - If yes, OPP does not occur.
 - If no, OPP occurs.
6. Check whether the current is within target scope if the OPP occurs. If yes, the power supply passes the test.

Press  +  to enter OPP test function setting screen:

Run	Press Enter when this option is highlighted to start the OPP test.
Recall	Press Enter when this option is highlighted, Recall OPP File=1 is displayed. You can select a file to recall a test. You can select which file to recall by changing the number. 5 files can be saved and recalled.

Edit	Press Enter when this option is highlighted, you can set the parameters for the OPP test here.	
	1:Voltage on level=0.000V	Set Von voltage value.
	2:Voltage on Delay=0.00S	Set Von voltage delay time.
	3:Current Range=0.000A	Set current range.
	4:Start Power=0.000W	Set initial power value.
	5:Step Power=0.000W	Set step power value.
	6:Step Delay=0.00S	Set step delay time.
	7:End Power=0.000W	Set cutoff power value.
	8:Voltage Standard =0.000V	Set standard voltage value.
	9:Max Trip Power =0.000W	Set overpower range (maximum value).
	10:Min Trip Power =0.000W	Set overpower range (minimum value).
Save OPP File=1	Save OPP test documents.	

Operating steps:

1. Press  to start OPP test. If the power supply passes the test, the following is displayed:

9.996V	0.0007A			
0.01W	49.10W	PASS	STOP	

If the power supply does not pass the test, the following is displayed:

9.996V	0.0007A			
0.01W	48.6W	FAULT	STOP	

2. Press  to return to the setting screen.



NOTE

If the set voltage value for OPP is higher than the Von value, OPP does not occur, and the following is displayed:

9.996V	0.0007A			
0.01W	0.1W	FAULT	STOP	









Battery discharge test function

The 2380 series electronic load can conduct battery discharge test. Battery discharge test is a necessary step before battery replacement for it can reflect reliability and remaining life of the battery. The test is conducted in CC mode. You can measure the voltage, discharging time, and discharged capacity of the battery.

Press  +  to enter the setting screen for battery discharge test. The settings are explained in the following table.

Stop Voltage=0.000V	You can set voltage as the stop condition of the test. You can change the number to set the value.
Stop Capability=0.000Ah	You can set battery capacity as the stop condition of the test. You can change the number to set the value.
Stop Timer=0S	You can set timer as the stop condition of the test. You can change the number to set the value.

Test procedures:

1. Press .
2. Connect the battery to the load.
3. Under CC mode, press  +  to enter battery discharge setting screen.
4. Select one of the three methods and set test stop conditions:
 - Voltage: set stop voltage and press  to start discharge test. When the battery voltage drops to the stop voltage, the load input automatically turns off.
 - Capability: set battery stop capacity. Press  to start discharge test. When set battery capacity is reached, the load input automatically turns off.
 - Timer: set the stop timer. Press  to start discharge test. When the set stop time is reached, the load input automatically turns off.
5. Press  to start the test. The discharge voltage, current, discharge time, and discharged capacity are displayed on the screen.
6. Press  to exit the test.

CR-LED test function

The 2380 series electronic load can conduct LED test in CR mode. The load can be set that it only works when voltage applied at its both ends is higher than the diode break-over voltage to agree with how diode works in real life.

As shown in the following figure, the traditional electronic loads can only simulate the static working point of diode as shown in the red circle of the following figure. They are unable to simulate the dynamic characteristics of LED normally working with ripple current.

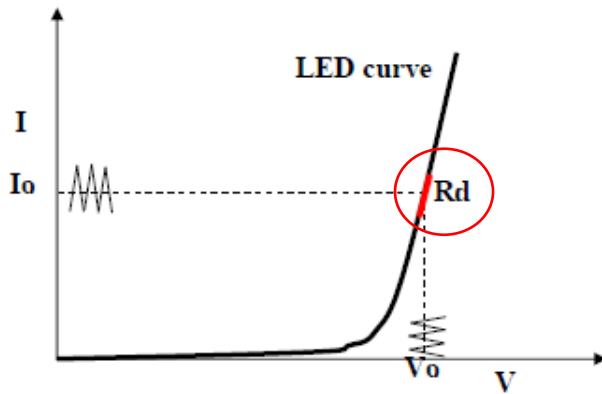

Figure 13 LED test by traditional electronic loads

2380 series electronic load can simulate an LED dynamically, as shown in the following figure:

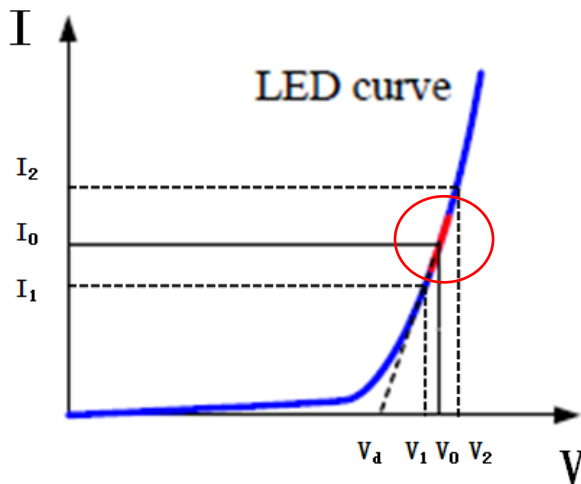

Figure 14 LED test by 2380

The definitions of the parameters in the previous figure are as follows:

- V_o : constant working voltage of the constant current source for LED
- I_o : output current of the constant current source for LED
- V_d : break-over voltage of the LED (string)
- R : constant resistance

You can calculate the value of R and V_d with the following equation:

$$R = \frac{V_2 - V_1}{I_2 - I_1}$$

$$V_d = V_o - I_o \times R$$

NOTE

The value of V₂, V₁, I₂ and I₁ should be close to the static working point of LED as shown in the red circle in the figure.

Or you can calculate the value of R and V_d with the following equation.

$$V_d = V * 0.8 \quad R = 0.2V/I$$

Where:

- V: constant working voltage of the constant current source for LED
- I: output current of the constant current source for LED

For example:

$$V_d = 50 \text{ V} * 0.8 = 40 \text{ V} \quad R = (0.2 * 50 \text{ V}) / 0.2 \text{ A} = 50 \Omega.$$

CR-LED test setting:

The following setting procedure takes example the LED under test with the output current as 200 mA and the range of output voltage from 45 V to 62 V.

1. Press **Shift** + **9** to enter the configuration menu.
2. Select CR-LED and press **Enter**.
3. Select On and press **Enter**.
4. Press **Esc** to exit.
5. Press **CR** and set the constant resistance. For example, set CR as 50 Ω.
6. Press **Shift** + **CV** to set range as 7500.0, high as 130 V, low as 0 V, and V_d as 40 V.
7. Press **Enter** to confirm.
8. Turn on the load input.

Measurement of voltage rise time

The 2380 series electronic load can measure voltage rise/drop time and provides a simple analog of voltage rise/drop waveform like an oscilloscope.

Procedures:

Set initial voltage and final voltage:

1. Press **Shift** + **9** to enter configuration menu.
2. Select Measure and press **Enter**.
3. Select TimeV1 and press **Enter**.
4. Set the initial voltage value and press **Enter**.
5. Select TimeV2 and press **Enter**.
6. Set final voltage value and press **Enter**.
7. Press **Esc** to exit.

Enable timer display

8. Press **Shift** + **8** to enter system menu.
9. Press Display and press **Enter**.
10. Select On.
11. Press **Enter** to enable timer display.
12. Press **Esc** to exit the setting. The timer locates in the middle in the bottom row.

OFF
0.0001V 0.0002A
0.00W 0.0000S CC=0.000A

Measurement of rise time

13. Connect the power supply under test to the electronic load.
14. Make sure that the power supply is set with an output voltage value that is higher than the set final voltage value.
15. Make sure the power output is turned off.
16. Set a constant current value on the load.
17. Turn the load's input on.
18. Turn the power output on.
The timer starts recording the time until the test finishes. The recorded time is the rise time of voltage.
19. Turn the power output off.
The voltage drop is displayed on the screen.

Configuration save function

The electronic load can save the configuration in 101 groups in the non-volatile memory. You can press **Shift** + **4** to save the configuration. Then you can press **Recall** to recall the configuration.

Operation steps

The procedures to save and recall the configuration:

Save:

1. Press **Shift** + **4** to save the configuration after the settings.
2. Set the number of the group to save the configuration. The following is displayed.
5.8949V 0.99994A
5.89W SAVE 9
3. Press **Enter** to confirm.

Recall

1. Press **Recall**.
2. Select the number of the saved file to be recalled.
3. Press **Enter** to confirm. The settings of the recalled configuration is displayed as shown in the following.
5.8949V 0.99994A
5.89W cc=1.000A

VON function

You can set a Von value so that the electronic load only latches when power voltage is higher than this value.

When Von latch function is enabled, the instrument is loaded when the power voltage rises over Von value. When the power voltage drops to lower than Von value, the instrument is unloaded, as shown in the following figure.

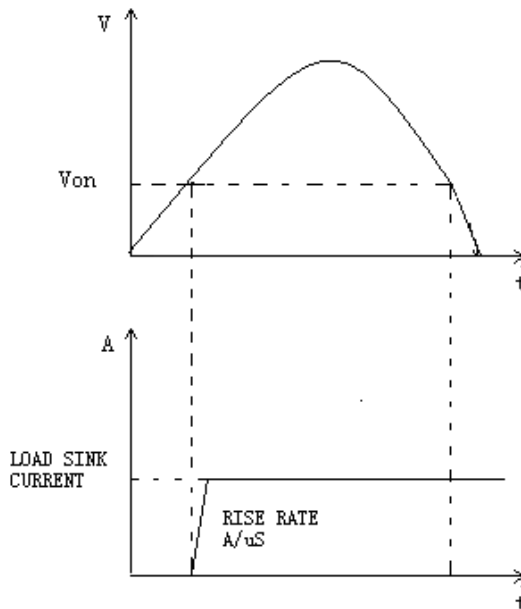

Figure 15 Load working range with Von latch enabled

You can press **Shift** + **9** to enter the configuration menu, select VON LATCH, and set the Von value.

NOTE

Set Von value and enable Von latch function may cause failure of turning on the load. It is advised to enable this function only when it is necessary.

If the load cannot be turned on, check whether the Von latch function is enabled. If yes, set Von value to 0 to clear the fault.

This function is invalid under CV mode.

Protective function

The load has the following protective functions:

- Overvoltage protection (OVP)
- Overcurrent protection (OCP)
- Overpower protection (OPP)
- Overtemperature protection (OTP)
- Input reverse polarity protection (RVS/RRV).

If any one of the above protections occurs, the alarm is on and the input automatically switches to off status. The according alarm is displayed on the screen. Press any key on the front panel to reset.

Overvoltage protection (OVP)

If this protection is triggered:



- The load turns off the input.
- The buzzer is on.
- OV and VF bits of the status register are set.
- OVP is displayed on the screen.
- The VF pin on the rear panel outputs TTL high level.

Clear overvoltage protection:

Check whether the output voltage of the power supply under test exceeds the set protection voltage. If yes, disconnect the power supply. Press any key on the front panel or send a command PROTection:CLEAr, the load is cleared of the protection and OVP disappears from the screen.

Overcurrent protection (OCP)

The electronic load has two kinds of overcurrent protections:



- Hardware overcurrent protection: maximum load current of the electronic load should be within 110% of the specified current range. When the hardware OCP is triggered, OC bit of the status register is set. The On/Off status of load will not be changed by the hardware overcurrent protection.
- Software overcurrent protection: this protection can be set by the following steps:  +  > Protect > I-limit > ON. Set I point as OCP current and I delay as pre-alarm delay time. When this protection is triggered, the load turn the input off, OCP is displayed on the screen, OC and PS bits of the status register are set.

Clear overcurrent protection:

Check whether the output current of the power supply under test exceeds the set protection current. If yes, disconnect the power supply. Press any key on the front panel or send a command PROTection:CLEAr, the load is cleared of the protection, OCP disappears from the screen, and OC and PS bits of the status register are reset.

Overpower protection (OPP)

The electronic load has two kinds of overpower protections:

- Hardware overpower protection: maximum load power of the electronic load should be within the specified power range. The On/Off status of load will not be changed by the hardware overcurrent protection.
- Software overpower protection: this protection can be set by the following steps:  +  > Protect > P-Limit. Set point as OPP power and Delay as alarm delay time. When this protection is triggered, the load turn the input off, OPP is displayed on the screen, OC and PS bits of the status register are set.

Clear overcurrent protection:

Check whether the output power of the power supply under test exceeds the set protection power. If yes, disconnect the power supply. Press any key on the front panel or send a command PROTection:CLEar, the load is cleared of the protection, OPP disappears from the screen, and OC and PS bits of the status register are reset.

Overtemperature protection (OTP)

When the internal temperature of the load is higher than 85 °C, the over temperature protection is triggered:

- The load turns off the input.
- OT and PS bits of the status register are set.
- OTP is displayed on the screen.

Clear overtemperature protection:

Press any key on the front panel or send a command PROTection:CLEar, the load is cleared of the protection, OTP disappears from the screen, and OT and PS bits of the status register are reset.

Input reverse polarity protection (RVS)

When the reverse polarity protection is triggered:

- The buzzer is on.
- RVS /RRV and VF bits of the status register are set.
- RVS is displayed on the screen
- VF pin outputs a high level.

Clear reverse polarity protection:

Check whether the load has reverse polarity. If yes, disconnect the power supply under test.

List operation

In list mode, the load provides an accurate, fast, and low-cost way to conduct any complicated quasi-bit precision test, which enables synchronization of internal or external signals.

In list mode, the load executes sequenced steps based on the list script and the preset step value, pulse width, and slope of each step.

You need to configure the following parameters for this function:

- Designation of input list file
- Input step count (2-84)
- Step time (0.00002 s – 3600 s)
- Setting values and slope of each step.

The list file can be stored in non-volatile memory. You can save 7 groups of list files at maximum.

If the load is in list mode, the load starts list operation when it receives a triggering signal till completion or receipt of another triggering signal.

Before starting list operation, make sure to edit list files and save them in non-volatile memory.

The output voltage and current of the tested instrument are 10 V and 3 A respectively and the load is under CC mode.

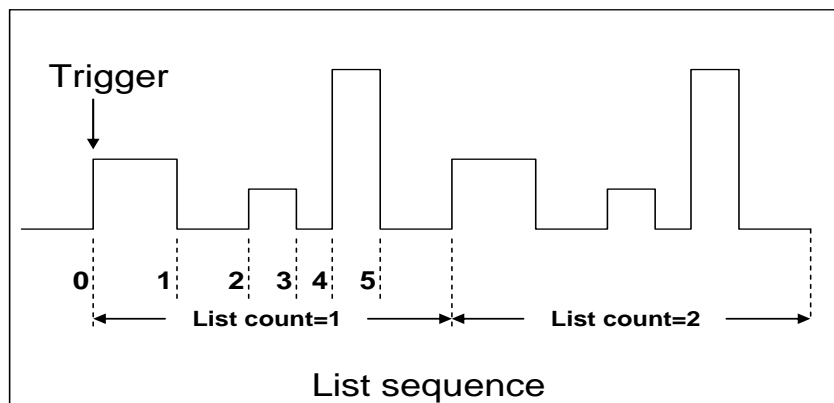

















Figure 16 List operation

To edit the list file and run the list:

Operation steps

1. Press **Shift** + **3**.
2. Select Edit and press **Enter**.
3. Select High-Rate and press **Enter**.
4. Edit number of steps. Press **2** to designate two steps.
5. Press **Enter**. The following text is displayed.
EDIT LIST
Step 001 Level=1A
6. Edit current value after Level in step 1 and press **Enter**. The following text is displayed.
EDIT LIST
Step 001 Rate=0.1A/uS

7. Edit slope after Rate in step 1 and press . The following text is displayed.
EDIT LIST
Step 001 Width=5S
8. Edit time after Width in step 1 and press . The following text is displayed.
EDIT LIST
Step 002 Level=2A
9. Edit current value after Level in step 2 and press . The following text is displayed.
EDIT LIST
Step 002 Rate=0.1A/uS
10. Edit slope after Rate in step 2 and press . The following text is displayed.
EDIT LIST
Step 002 Width=5S
11. Edit time after Width in step 2 and press . The following text is displayed.
EDITLIST
Repeat Count=3
12. Edit repeat count and press . The following text is displayed.
EDIT LIST
Save List File=1
13. Save all edited files and press . The following text is displayed.
LIST
On Recall Edit
14. Select On and press . The Trig indicator is on.
15. Press  to exit setting.
16. Press  to turn input on and press . The list operation is running.
17. Press  /  /  /  or any composite key to exit list operation.

For recalling of existing list files and triggering of list operation, refer to steps below:

Operation steps

1. Press **Shift** + **3**.
2. Make sure that OFF indicator flickers by pressing **Enter**. The following text is displayed.
LIST
On Recall Edit
3. Select Recall and press **Enter**. The following text is displayed.
Recall List File=1
4. Select the file and press **Enter**. The following text is displayed.
LIST
On Recall Edit
5. Select On and press **Enter**. The Trig indicator is on.
6. Press **Esc** to exit setting.
7. Press **On/Off** to turn input on and press **Trigger**. The list operation running.

Function of the terminals on the rear board

Please refer to Introduction to the rear panel for the introduction of the terminals.

Remote sense measurement function

Under CC, CV, CR or CP mode, if the input current of the load rises abruptly, a large voltage drop will be detected in the wire between tested device and the load. To ensure measurement accuracy, remote sense measurement terminals are provided in the rear panel.

SENSE (+) and SENSE (-) are remote input terminals. If you connect the load to the device under test as shown in the following figure, the voltage drop can be canceled out if the remote sense measurement function is enabled.

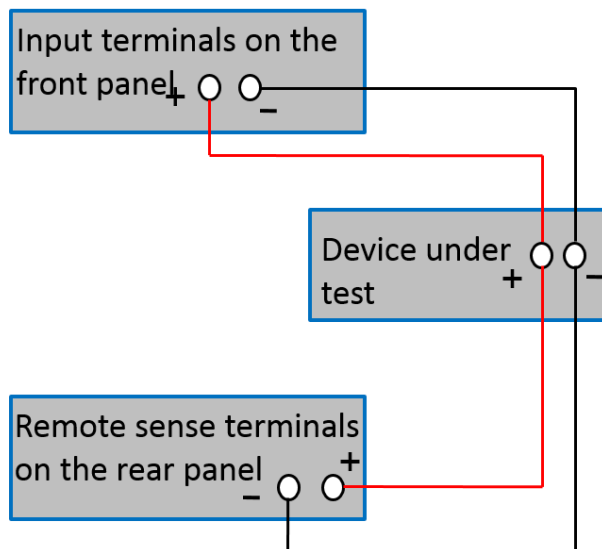

Figure 17 Remote sense connection

To enable remote sense measurement function:

1. Press **Shift** + **9**.
2. Select Remote-Sense and press **Enter**.
3. Select ON to start remote sense function.

External trigger function

You can set the triggering source as External, and then the triggering signals can be input from the rear board trigger terminals.

To enable external trigger function:

1. Press **Shift** + **8**.
2. Press Right key and select Trigger.
3. Press **Enter**.
4. Select External and press **Enter**.
5. Press **Esc** to exit the setting.

When external trigger is enabled, the trigger terminals generate triggering signals, and the low pulse is valid.

This function can be used for triggering dynamic test, list test and auto test.

External analog quantity function

You can control the load voltage or current of the electronic load by EXT PRG (positive and negative) analog quantity terminals on the rear board.

Connect a power source with 0-10 V adjustable voltage to the EXT PRG terminals to analog input so as to adjust input voltage and load current. Please note that 10 V corresponds to load voltage or current at full range.

Voltage fault indication

When load is under overvoltage protection or terminal reverse polarity protection, VF pin of the voltage fault indication terminal outputs high level.

Current monitoring (I Monitor)

An external voltmeter or oscilloscope can be connected to the load through this terminal to display input current change. You can calculate the current value with the voltage value.

















Auto test function

You can conduct auto test on the 2380 series electronic load. In an auto test, 10 groups of test files can be included, and each file can contain 10 steps, which means a maximum of 100 steps can be edited and saved in EEPROM.

NOTE

In the following procedures, "Y" indicates selected status. To cancel selected status, press numeric key of the corresponding step.

Operation steps

1. Press  + .
PROGRAM
Run Recall Edit
2. Select Edit and press . The following text is displayed.
EDIT PROGRAM
Active Sequence=0987654321
3. Press numeric key to select test step. The following text is displayed. YY after Active Sequence= 09876543 indicates that 1 or 2 steps are selected.
EDIT PROGRAM
Active Sequence=09876543YY
4. Press . The following text is displayed.
EDIT PROGRAM
Pause Sequence=□□□□□□□□Y1
5. Select pause for the steps. If step 2 is to be paused, press . If not, press . The following text is displayed.
EDIT PROGRAM
Short Sequence=□□□□□□□□2Y
6. Select short-circuit test for the steps. If step 1 is to be tested, press . If not, press . The following text is displayed.
EDIT PROGRAM
SEQ01 On Time=2S
7. Set loading time for step 1. If 2 s is required, press .
8. Press . The following text is displayed.
EDIT PROGRAM
SEQ01 Off Time=2S
9. Set unloading time for step 1. If 2 s is required, press .
10. Press . The following text is displayed.
EDIT PROGRAM
SEQ01 P/F Delay Time=1S
11. Set test delay time for step 1. If 1 s is required, press .
12. Press . The following text is displayed.
EDIT PROGRAM
SEQ02 On Time=2S
13. Set loading time for step 2. If 2 s is required, press .
14. Press . The following text is displayed.
EDIT PROGRAM
SEQ02 Off Time=2S

15. Set unloading time for step 2. If 2 s is required, press .
16. Press .
EDIT PROGRAM
SEQ02 P/F Delay Time=1S
17. Set test delay time for step 2. If 1 s is required, press .
As shown in the next figure, T_{pf} is the delay time before measurement.

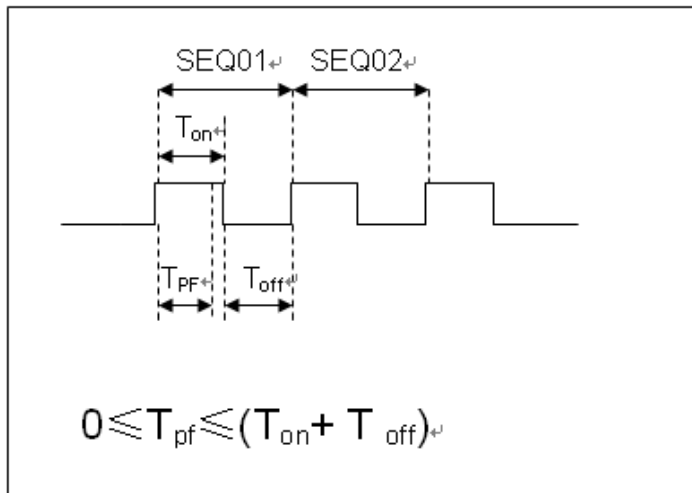

Figure 18 Auto test sequence

18. Press . The following text is displayed.
PROGRAM
Complete-Stop Failure-Stop
19. Set conditions for stopping the test. COMPLETE means to stop after all tests are completed and FAILURE means to stop in case of test error.
20. Press . The following text is displayed.
PROGRAM
Chain Program File=0(0-10)
21. Set the link to the next group of test file. If it is to link to the second group, press . 0 means not to link to other test files.
22. Press . The following text is displayed.
PROGRAM
Save Program File=1 (1-10)
23. Save the programmed files in EEPROM. A total of 10 groups of files can be saved. To save edited files in group 1, press . Then press .

The following table explains the relation between the sequence and the saved group.

Program 1 Sequence	1	2	3	4	5	6	7	8	9	10
Save Group	1	2	3	4	5	6	7	8	9	10
Program 2 Sequence	1	2	3	4	5	6	7	8	9	10
Save Group	11	12	13	14	15	16	17	18	19	20
:										
:										
Program 10 Sequence	1	2	3	4	5	6	7	8	9	10
Save Group	91	92	93	94	95	96	97	98	99	100

24. Press **Esc** key to exit the setting.

Note: The above steps only set entire framework of auto tests. Additional setting is required for specific parameters in each step, which allows modification of parameters in a single step.

25. Select working mode and press **Shift** + **CV** to enter the parameter setting. The following text is displayed.

```
10.0000V  0.0000A
0.00W     CC=1.000A
```

26. For step 1 under CC mode, set the parameters as follows:

- Current: 2 A
- Maximum voltage value: 10 V
- Minimum voltage value: 2 V

For step 2 under CV mode, set the parameters as follows:

- Voltage: 3 V
- Maximum current value: 5 A
- Minimum current value: 0 A

27. Press **Esc** to exit the setting.

28. Press **Shift** + **4** for saving the steps.

Note: Settings at each step should be independently saved. It is necessary to recall test files for running after editing auto test files.

Recalling test file

To recall edited test files from EEPROM:

1. Press **Shift** + **6**. The following text is displayed.
PROGRAM
Run Recall Edit
2. Select Recall and press **Enter**. The following text is displayed.
RECALL PROGRAM
Recall Program File=1
3. Select auto test file 1. The following text is displayed.
PRG01 STOP
4. Press **Trigger** to run auto test file 1.
5. Press **Shift** + **0** to pause auto test.
6. Press **Next** for next step.

Technical Specifications

Major technical parameters

Model		2380-500-15 / 2380J-500-15	
Rated value (0-40 °C)	Input voltage	0~500 V	
	Input current	0~3 A	0~15A
	Input power	200 W	
	Min. operating voltage	0.6 V at 3 A (maximum 0.9 V)	4.5 V at 15 A
Constant voltage mode	Range	0.1~50 V	0.1~500 V
	Resolution	1 mV	10 mV
	Accuracy	$\pm(0.05\%+0.025\% \text{ FS})$	$\pm(0.05\%+0.025\% \text{ FS})$
Constant current mode	Range	0~3 A	0~15 A
	Resolution	0.1 mA	1 mA
	Accuracy	$\pm(0.05\%+0.05\% \text{ FS})$	$\pm(0.05\%+0.05\% \text{ FS})$
Constant resistance mode *1	Range	0.3 Ω ~10 Ω	10 Ω ~7.5 K Ω
	Resolution	16 bit	
	Accuracy	0.01%+0.08 S *2	0.01%+0.0008 S
Constant power mode *3	Range	200 W	
	Resolution	10 mW	
	Accuracy	0.1%+0.1% FS	
Dynamic mode			
Dynamic mode	CC mode		
	T1 & T2	20 μ S~3600 S /Res:1 μ S	
	Accuracy	5 μ S \pm 100 ppm	
	Ascending/descending slope *4	0.0001~0.1 A/ μ S	0.001~1 A/ μ S
	Minimum rise time*5	\cong 10 μ S	\cong 10 μ S
Measuring range			
Read-back voltage	Range	0~50 V	0~500 V
	Resolution	1 mV	10 mV
	Accuracy	$\pm(0.025\%+0.025\% \text{ FS})$	$\pm(0.025\%+0.025\% \text{ FS})$
Read-back current	Range	0~3 A	0~15 A
	Resolution	0.01 mA	0.1 mA

	Accuracy	$\pm(0.05\%+0.05\% \text{ FS})$	
Read-back power	Range	200 W	
	Resolution	10 mW	
	Accuracy	$\pm(0.1\%+0.1\% \text{ FS})$	
Protection range			
Overpower protection		$\cong 210 \text{ W}$	
Overcurrent protection		$\cong 3.3 \text{ A}$	$\cong 16.5 \text{ A}$
Overvoltage protection		$\cong 530 \text{ V}$	
Over temperature protection		$\cong 85 \text{ }^\circ\text{C}$	
Specification			
Short circuit	Current (CC)	$\cong 3.3 / 3 \text{ A}$	$\cong 16.5 / 15 \text{ A}$
	Voltage (CV)	$\cong 0 \text{ V}$	$\cong 0 \text{ V}$
	Resistance (CR)	$\cong 300 \text{ m}\Omega$	$\cong 300 \text{ m}\Omega$
Input terminal Impedance		$\cong 1 \text{ m}\Omega$	
Dimension		214.5 mm * 88.2 mm * 354.6 mm	

*1. The voltage/current input is no less than 10%FS (FS indicates the full scope).

*2. The scope of read-back resistance is $(1/(1/R+(1/R)*0.01\%+0.08), 1/(1/R-(1/R)*0.01\%-0.08))$.

*3. The voltage/current input is no less than 10%FS.

*4. Ascending/descending slope: 10%-90% current ascending slope from 0 to maximum current

*5. Minimum rise time: 10%-90% current rise time

Model		2380-120-60/2380J-120-60	
Rated value (0 - 40 °C)	Input voltage	0~120 V	
	Input current	0~6 A	0~60 A
	Input power	250 W	
	Min. operating voltage	0.18 V at 6 A	1.8 V at 60 A
Constant voltage mode	Range	0~18 V	0~120 V
	Resolution	1 mV	10 mV
	Accuracy	$\pm(0.05\%+0.025\% \text{ FS})$	$\pm(0.05\%+0.025\% \text{ FS})$
Constant current mode	Range	0~6 A	0~60 A
	Resolution	0.1 mA	1 mA
	Accuracy	$\pm(0.05\%+0.1\% \text{ FS})$	$\pm(0.05\%+0.1\% \text{ FS})$
Constant	Range	0.05 Ω ~10 Ω	10 Ω ~7.5 K Ω

resistance mode *1	Resolution	16 bit	
	Accuracy	0.01%+0.08 S *2	0.01%+0.0008 S
Constant power mode *3	Range	250 W	
	Resolution	10 mW	
	Accuracy	0.2%+0.2% FS	
Dynamic mode			
Dynamic mode	CC mode		
	T1 & T2	20 μ S~3600 S /Res:1 μ S	
	Accuracy	5 μ S \pm 100 ppm	
	Ascending/descending slope *4	0.0001~0.25 A/ μ S	0.001~2.5 A/ μ S
	Minimum rise time*5	\approx 20 μ S	\approx 20 μ S
Measuring range			
Read-back voltage	Range	0~18 V	0~120 V
	Resolution	0.1 mV	1 mV
	Accuracy	\pm (0.025%+0.025% FS)	\pm (0.025%+0.025% FS)
Read-back current	Range	0~6 A	0~60 A
	Resolution	0.1 mA	1 mA
	Accuracy	\pm (0.05%+0.1% FS)	
Read-back power	Range	250 W	
	Resolution	10 mW	
	Accuracy	\pm (0.2%+0.2% FS)	
Protection range			
Overpower protection	\approx 260 W		
Overcurrent protection	\approx 6.6 A	\approx 66 A	
Overvoltage protection	\approx 130 V		
Over temperature protection	\approx 85°C		
Specification			
Short circuit	Current (CC)	\approx 6.6/6 A	\approx 66/60 A
	Voltage (CV)	0 V	0 V
	Resistance (CR)	\approx 30 m Ω	\approx 30 m Ω
Input terminal impedance	\approx 300 K Ω		
Dimension	214.5 mm*88.2 mm*354.6 mm		

*1. The voltage/current input is no less than 10% FS (FS indicates the full scope).

*2. The scope of read-back resistance is $(1/(1/R+(1/R)*0.01\%+0.08), 1/(1/R-(1/R)*0.01\%-0.08))$.

*3. The voltage/current input is no less than 10% FS.

*4. Ascending/descending slope: 10%-90% current ascending slope from 0 to maximum current

*5. Minimum rise time: 10%-90% current rise time

*The above specifications may be subject to change without prior notice.

Additional features

Memory capacity: 100 groups.

Recommended calibration frequency: 1 time/year.

Cooling method: fan.

Fan control temperature:

Temperature	40°C	50°C	70°C	85°C
Fan status	First gear	Second gear	Third gear	Temperature protection (OH) and load is shut off.

SCPI Command Reference

Communication Setting

Communication Interface

GPIB function

All electronic load functions except setting the communication parameters are programmable over the GPIB. The IEEE 488.2 capabilities of the electronic load are described in the following table.

GPIB Capabilities	Response	Interface Function
Talker/Listener	All electronic load functions except for setting the communication parameters are programmable over the GPIB. The electronic load can send and receive messages over the GPIB. Status information is sent using a serial poll.	AH1, SH1,AH1, SH1, T6, L4T6, L4
Service Request	The electronic load sets the SRQ line true if there is an enabled service request condition.	SR1, SR1
Remote/Local	In local mode, the electronic load is controlled from the front panel but will also execute commands sent over the GPIB. If the electronic load is powered on in local mode, it remains in local mode until it receives a command over the GPIB. Once the electronic load is in remote mode the front panel REM indicator is on, all front panel keys (except Shift+7 , Local and Esc) are disabled, and the display is in normal metering mode. Press Local on the front panel to return to the local mode.	RL1
Device Trigger	The electronic load responds to the device triggers.	DT1
Group Execute Trigger	The electronic load responds to the group execute triggers.	GETGET
Device Clear	The electronic load responds to the Device Clear (DCL) and Selected Device Clear (SDC) interface commands. They command the electronic load to clear any activity that would prevent it from receiving and executing a new command (including *WAI and *OPC?). DCL and SDC do not change any programmed settings.	DCL,SDC

GPIB address

The electronic load operates from a GPIB address that is set from the front panel. To set the GPIB address, press the **Shift + System** on the front panel and enter the address using the keys. The address can be set from 0 to 30. The GPIB address is stored in non-volatile memory.

RS-232 function

The electronic load provides an RS-232 programming interface, which can be activated and set by pressing **Shift + System** on the front panel. All SCPI commands are available through RS-232 programming. When the RS-232 interface is selected, The EIA RS-232 Standard defines the interconnections between Data Terminal Equipment (DTE) and Data Communications Equipment (DCE). The electronic load is designed to be a DTE. It can be connected to another DTE such as a PC COM port through a null modem cable.

NOTE

The RS-232 settings in your program must match the settings specified in the front panel system menu. Press **Shift + System** to change the settings if they don't match.

You can break data transmissions by sending a ^C or ^X character string to the multimeter. This clears any pending operation and discards any pending output.

RS-232 data format

The RS-232 data is a 10-bit word with one start bit and one stop bit. The number of start and stop bits is not programmable. However, the following parity options are selectable after pressing **Shift + System**:

- **EVEN**: Seven data bits with even parity
- **ODD**: Seven data bits with odd parity
- **NONE**: Eight data bits without parity

Parity options are stored in non-volatile memory.

Baud rate

After pressing **Shift + System**, you can select one of the following baud rates:

- 4800
- 9600
- 19200
- 38400
- 57600
- 115200

The baud rate is stored in the non-volatile memory.

RS-232 flow control

The RS-232 interface supports the following flow control:

- **CTS/RTS**: the electronic load asserts its Request to Send (RTS) line to signal hold-off when its input buffer is almost full, and it interprets its Clear to Send (CTS) line as a hold-off signal from the controller.
- **XON/XOFF**: when the input queue of the electronic load becomes more than 3/4 full, the instrument issues an X_OFF command. The control program should respond to this and stop sending characters until The electronic load issues the X_ON, which it will do once its input buffer drops to below half-full. The electronic load recognizes X_ON and X_OFF sent from the controller. An X_OFF will cause the electronic load to stop outputting characters until it sees an X_ON.
- **NONE**: there is no flow control.

For each case, the electronic load will send a maximum of five characters after hold-off is asserted by the controller. The electronic load is capable of receiving as many as fifteen additional characters after it asserts hold-off. Flow control options are stored in the non-volatile memory.

RS-232 connections

The RS-232 serial port can be connected to the serial port of a controller (i.e., personal computer) using a straight through RS-232 cable ended with DB-9 connectors.

Note: Do not use a null modem cable.

If your computer uses a DB-25 connector for the RS-232 interface, you will need a cable or adapter with a DB-25 connector on one end and a DB-9 connector on the other, wired straight through.

The following figure and table show the pins for the connector.



The plug pins of RS232

Pin Number	Description
1	no connection
2	TXD:transmit data
3	RXD:receive data
4	no connection
5	GND:signal ground
6	no connection
7	CTS:clear to send
8	RTS:ready to send
9	no connection

RS-232 troubleshooting

If you are having trouble communicating over the RS-232 interface, check the following:

- The computer and the electronic load must be configured for the same baud rate, parity, number of data bits, and flow control options. Note that the electronic load is configured for 1 start bit and 1 stop bit (these values are fixed).
- The correct interface cables or adapters must be used, as described under RS-232 Connector. Note that even if the cable has the proper connectors for your system, the internal wiring may be incorrect.
- The interface cable must be connected to the correct serial port on your computer (COM1, COM2,etc.).

USB-TMC Capabilities of the Electronic Load

All electronic load functions are programmable over the USB.

The USB488 interface capabilities of the electronic load are described as follows:

- The interface is a 488.2 USB488 interface.
- The interface accepts REN_CONTROL, GO_TO_LOCAL, and LOCAL_LOCKOUT requests.
- The interface accepts the MsgID = TRIGGER USBTMC command message and forwards TRIGGER requests to the Function Layer.

The USB488 device capabilities of the electronic load are described follow:

- The device understands all mandatory SCPI commands.
- The device is SR1 capable
- The device is RL1 capable
- The device is DT1 capable

Status register

You can use status register programming to determine the operating condition of the electronic load at any time. For example, you may program the electronic load to generate an interrupt (assert SRQ) when an event such as a current protection occurs.

The Standard Event, Status Byte, Service Request Enable registers, and the Output Queue perform standard GPIB functions as defined in the IEEE 488.2 Standard Digital Interface for Programmable Instrumentation. The Operation Status and Questionable Status registers implement functions that are specific to the electronic load.

The following table explains the status signals.

Bit	Signal	Description
Operation status group		
0	CAL	<u>Calibrating</u> : The electronic load is calculated a new calibration constant.
5	TRG	<u>Waiting</u> : The electronic load is waiting for a trigger
Questionable status group		
0	VF	<u>Voltage Fault</u> : Either an overvoltage or a reverse voltage has occurred This bit reflects the active state of the FLT pin on the back of the unit. The bit remains set until the condition is removed and PROT:CLE is programmed.
1	OC	<u>Over current</u> : An over-current condition has occurred. This occurs if the current exceeds 110% of the rated current or if it exceeds the user-programmed current protection level. Removing the over-current condition clears the bit.If the condition persists beyond the user programmable delay time, PS bit is also set and the input is turned off. Both bits remain set until the condition is removed and PROT:CLE is programmed.
2	RS	<u>Remote Sense</u> : When the real pannel sense is connected, this bit is true or else false.
3	OP	<u>Overpower</u> : An overpower condition has occurred. This occurs if the unit exceeds the max power or it excee the user-programmed power protection level, Removing the overpower condition clears the bit, If the condition persists beyond the user programmable delay time, PS bit is also set and the input is turned off, Both bits remain set until the condition is removed and PROT:CLE is programmed.
4	OT	<u>Over temperature</u> : An over-temperature condition has occurred, Both this bit and bit PS are set and the input is turned off, Both bits remain set until the unit is cooled

		down and PROT:CLE is programmed.
7	RUN	<u>List run or stop status</u> when list is running, this bit is true else false._
8	EPU	<u>Extended Power Unavailable</u> : This bit is not used.
9	RRV	<u>Remote Reverse Voltage</u> : A reverse voltage condition has occurred on the sense terminals, Both this bit and VF bit are set, Removing the reverse voltage clears this bit but does not clear VF bit.VF Bit remains set until PROT:CLE is programmed.
10	UNR	<u>Unregulated</u> : The input is unregulated, when the input is regulated the bit is cleared.
11	LRV	<u>Local Reverse Voltage</u> : A reverse voltage condition has occurred on the input terminals, Both this bit and VF bit are set, Removing the reverse voltage clears this bit but does not clear VF bit.VF bit remains set until PROT:CLE is programmed.
12	OV	<u>Over voltage</u> : An over voltage condition has occurred, Both this bit and VF bit0 are set and the load are turned off, Both bits remain set until the condition is removed and PROT:CLE is programmed.
13	PS	<u>Protection Shutdown</u> : The protection shutdown circuit has tripped because of an Over-current, over-power, or over-temperature condition, The bit remains set until PROT:CLE is programmed._
14	VON	<u>Voltage of sink current on</u> : When the voltage of input exceeds the user-programmed Von level, this bit is true else false.
15	TBF	<u>Trace Buffer Full</u> .

Standard event status group		
0	OPC	<u>Operation Complete</u> : The load has completed all pending operations, *OPC must be programmed for this bit to be set when pending operations are complete.
2	QYE	<u>Query Error</u> : The output queue was read with no data present or the data was lost, Errors in the range of -499 through -400 can set this bit.
3	DDE	<u>Device-Dependent Error: Device-Dependent Error</u> . Memory was lost or self test failed, Errors in the range of -399 through -300,0 through 99 and 100 through 32767 can set this bit.
4	EXE	<u>Execution Error</u> : A command parameter was outside its legal range, inconsistent with the load's operation, or prevented from executing because of an operating condition, Errors in the range of -299 through -200 can set this bit.
5	CME	<u>Command Error</u> : A syntax or semantic error has occurred or the load received a <get> within a program message, Errors in the range of 200 through 100 can set this bit.
7	PON	<u>Power-On</u> : The unit has been turned off and then on since this bit was last read.

Status and service request enable register		
2	EAV	<u>Error Available Summary</u> : Indicates if the Error Queue contains data
3	QUES	<u>Questionable Status Summary</u> : Indicates if an enabled questionable event has occurred.
4	MAV	<u>Message Available Summary</u> : Indicates if the Output Queue contains data.
5	ESB	<u>Event Status Summary</u> : Indicates if an enabled standard event has occurred.
6	RQS/ MSS	<u>Request Service</u> : During a serial poll, RQS is returned and cleared. <u>Master Status Summary</u> : For an *STB? query, MSS is returned without being cleared.
7	OPER	<u>Operation Status Summary</u> : Indicates if an operation event has occurred.

The following figure shows the status register structure of the electronic load.

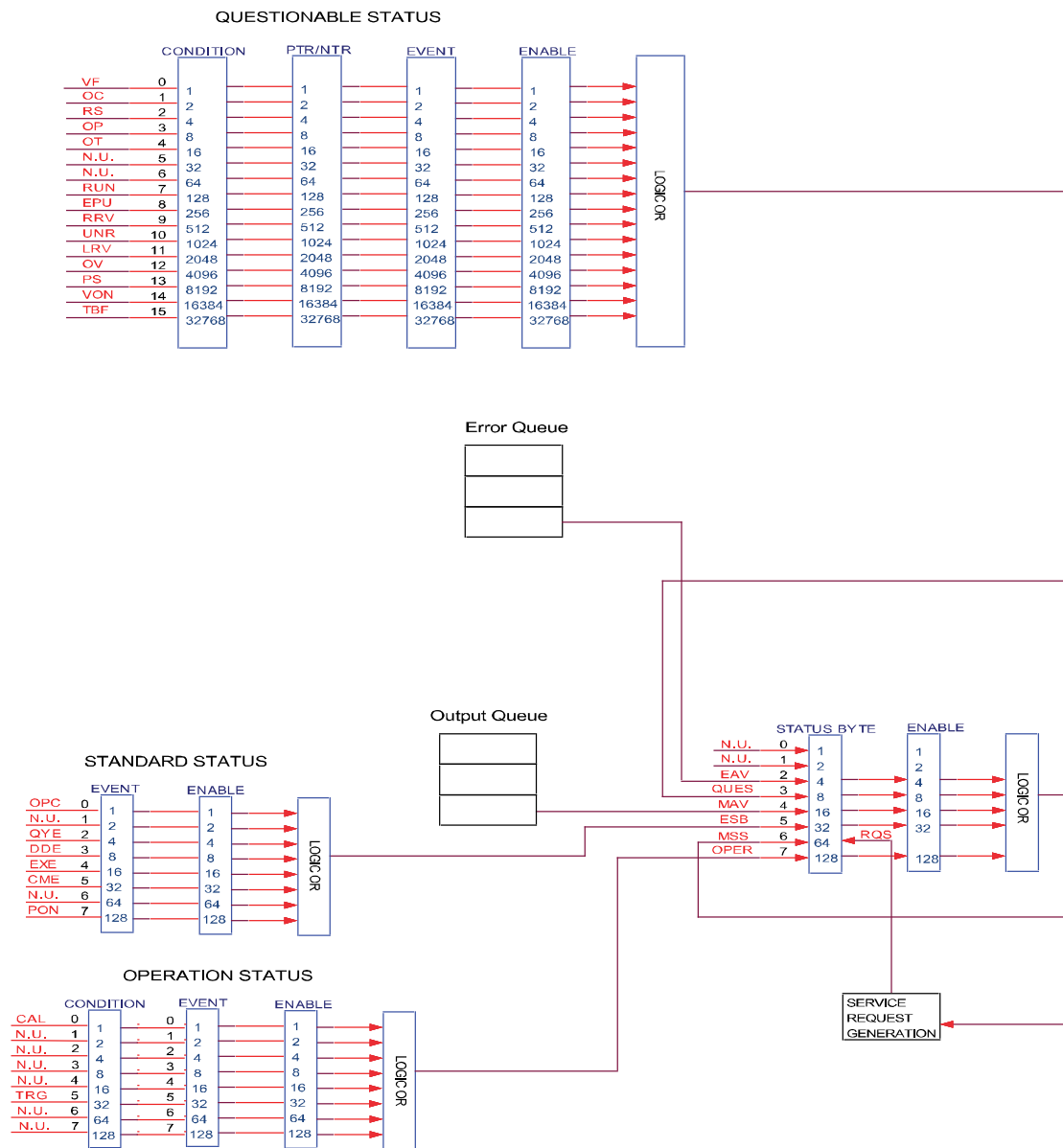

Figure 19 Status register structure

Condition register

As you can see from the figure above, channel status register and operation status register sets have a condition register. A condition register is a real-time, read-only register that constantly updates to reflect the current operating conditions of the instrument.

You can see the :CONDition? command in the STATus Subsystem to read the condition registers.

Event register

Each status register set has an event register. An event register is a latched, read-only register whose bits are set by the corresponding condition register. Once a bit in an event register is set, it remains set (latched) until the register is cleared by a specific clearing operation. The bits of an event register are logically ANDed with the bits of the corresponding enable register and applied to an OR gate. The output of the OR gate is applied to the status byte register.

Send the *ESR? command to read the standard event register. All other event registers can be read by sending the :EVENT? query command.

An event register is cleared when it is read. The following operations clear all event registers:

- Cycling power
- Sending *CLS

Enable register

Each status register set has an enable register. An enable register is programmed by you and serves as a mask for the corresponding event register. An event bit is masked when the corresponding bit in the enable register is cleared (0). When masked, a set bit in an event register cannot set a bit in the status byte register ($1 \text{ AND } 0 = 0$).

To use the status byte register to detect events (i.e., serial poll), you must unmask the events by setting the appropriate bits of the enable registers.

To program and query the Standard Event Status Register, use the *ESE and *ESE?.

All other enable registers are programmed and queried using the :ENABle and :ENABle? Command.

An enable register is not cleared when it is read. The following operations affect the enable registers:

- Circulationpower: Clear all the enable register.
- :STATus:PREset clears the following enable registers:
 - Operation event enable register
 - Questionable event enable register
- *ESE 0 clears the standard event status enable register.

Queue

The 2380 Series uses two queues, which are first-in, first-out (FIFO) registers:

- Output Queue - used to hold reading and response messages
- Error Queue - used to hold error and status messages

The 2380 Series status model shows how the two queues are structured with the other registers.

Output queue

The output queue holds data that are related to the normal operation of the instrument. For example, when a query command is sent, the response message is placed on the output queue.

When data is placed in the output queue, the Message Available (MAV) bit in the status byte register sets. A data message is cleared from the output queue when it is read. The output queue is considered cleared when it is empty. An empty output queue clears the MAV bit in the status byte register.

You can read a message from the output queue after a query is sent.

Error queue

The error queue holds error and status messages. When an error or status event occurs, a message that defines the error/status is placed in the error queue. This queue holds up to 31 messages.

When a message is placed in the error queue, the Error Available (EAV) bit in the status byte register is set. An error message is cleared from the error/status queue when it is read. The

error queue is considered cleared when it is empty. An empty error queue clears the EAV bit in the status byte register. Read an error message from the error queue by sending :SYSTem:ERRor? command.

Status byte and service request (SRQ)

Service request is controlled by two 8-bit registers: the status byte register and the service request enable register.

Status byte register

The summary messages from the status registers and queues are used to set or clear the appropriate bits (B2, B3, B4, B5, and B7) of the status byte register. These bits do not latch, and their states (0 or 1) are solely dependent on the summary messages (0 or 1). For example, if the Standard event status register is read, its register is cleared. As a result, its summary message will reset to 0, which in turn will clear the ESB bit in the status byte register. Bit B6 in the status byte register is called the MSS bit.

The Master Summary Status (MSS) bit, sent in response to the *STB? indicates the enable status of the set bit. The Request for Service (RQS) bit, sent in response to a serial poll, indicates which device was requesting service by pulling on the SRQ line.

For a description of the other bits in the status byte register, see *STB?

When reading the status byte register using the *STB? command, bit B6 is called the MSS bit. None of the bits in the status byte register are cleared when using the *STB? command to read them.

The IEEE-488.1 standard has a serial poll sequence that also reads the status byte register and is better suited to detect a service request (SRQ). When using the serial poll, bit B6 is called the RQS bit. Serial polling causes bit B6 (RQS) to reset. Serial polling is discussed in more detail later.

Any of the following operations clear all bits of the status byte register:

- Circulation power
- Sending the *CLS command

Note: The MAV bit may or may not be cleared.

Service request enable register

This register is programmed by you and serves as a mask for the status summary message bits (B2, B3, B4, B5, and B7) of the status byte register. When masked, a set summary bit in the status byte register cannot set bit B6 (MSS/RQS) of the status byte register. Conversely, when unmasked, a set summary bit in the status byte register sets bit B6.

A status summary message bit in the status byte register is masked when the corresponding bit in the service request enable register is cleared. When the masked summary bit in the status byte register sets, it is ANDed with the corresponding cleared bit in the service request enable register. The logic "1" output of the AND gate is applied to the input of the OR gate and, thus, sets the MSS/RQS bit in the status byte register.

The individual bits of the service request enable register can be set or cleared by using the following common command:

```
*SRE <NRf>*SRE <NRf>
```

To read the service request enable register, use the *SRE? query command. The service request enable register clears when power is cycled or a parameter (n) value of zero is sent with the *SRE command *SRE 0).

Serial poll and SRQ

Any enabled event summary bit that goes from 0 to 1 will set RQS and generate a service request (SRQ). In your test program, you can periodically read the status byte register to check if a service request (SRQ) has occurred and what caused it. If an SRQ occurs, the program can, for example, branch to an appropriate subroutine that will service the request. Typically, service requests (SRQs) are managed by the serial poll sequence of the electronic load. If an SRQ does not occur, bit B6 (RQS) of the status byte register will remain cleared and the program will simply proceed normally after the serial poll is performed. If an SRQ does occur, bit B6 of the status byte register will set and the program can branch to a service subroutine when the SRQ is detected by the serial poll.

The serial poll automatically resets RQS of the status byte register. This allows subsequent serial polls to monitor bit B6 for an SRQ occurrence generated by other event types. After a serial poll, the same event can cause another SRQ, even if the event register that caused the first SRQ has not been cleared.

A serial poll clears RQS but does not clear MSS. The MSS bit stays set until all status byte event summary bits are cleared.

Trigger Model (GPIB Operation)

This section describes how the electronic load operates over the GPIB bus. It is called the trigger model because operation is controlled by SCPI commands from the Trigger subsystem. Key SCPI commands are included in the trigger model.

Trigger Model Operation

Once the instrument is taken out of idle state, operation proceeds through the trigger model down to the device action.

A control source is used to hold up operation until the programmed event occurs. The control source options are explained as follows:

- **HOLD**: only the FORCE:TRIG command will generate a trigger in HOLD mode. All other trigger commands are ignored.
- **MANual**: event detection is ended by pressing the TRIG key.
- **TIMer**: this generates triggers that are in synchronization with the electronic load's internal oscillator as the trigger source. The internal oscillator begins running as soon as this command is executed. Send TRIG:TIM to program the oscillator period.
- **EXTernal**: event detection is ended when an input trigger via the TRIGGER LINK connector is received by the electronic load.
- **BUS**: event detection is ended when a bus trigger (GET or *TRG) is received by the electronic load.

SCPI Command Introduction

SCPI

SCPI (Standard Commands for Programmable Instruments) is a programming language for controlling instrument functions over the GPIB and RS-232 and usb and ethernet interface. SCPI is layered on top of the hardware-portion of IEEE 488.2. The same SCPI commands and parameters control the same functions in different classes of instruments.

Conventions Used in This Guide:

Angle	<>	The parameter in the angle bracket is as shorthand, for example: <NR1> indicates a specific form of numerical data.
Vertical Line		It used to separate optional parameters. For example: NORM TEXT indicates that either "TEXT" or "NORM" can be used as a parameter.
Square Bracket	[]	The parameter in the square bracket is optional. For example: [SOURce:]VOLTage indicates SOURce: can be ignored.
Curly braces	{ }	The parameter in the curly bracket can be omitted or entered one or more times. It is used especially for showing arrays. The notation <A>{<,B>} shows that parameter "A" must be entered, while parameter "B" may be omitted or may be entered one or more times.

Command type of SCPI

SCPI has two types of commands, common and subsystem.

- Common commands generally are not related to specific operation but to controlling overall electronic load functions, such as reset, status, and synchronization. All common commands consist of a three-letter mnemonic preceded by an asterisk: *RST *IDN? *SRE 8
- Subsystem commands perform specific electronic load functions. They are organized into an inverted tree structure with the "root" at the top. The next figure shows a portion of a subsystem command tree, from which you access the commands located along the various paths.

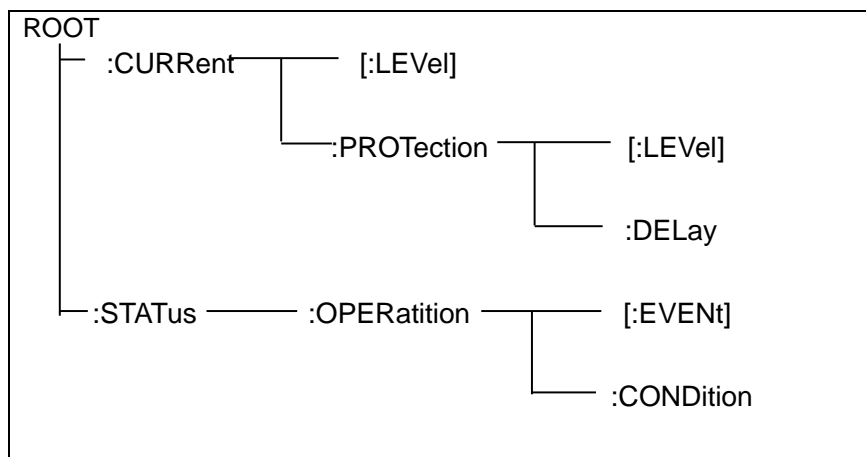

Figure 20 Command tree

Multiple commands in a message

Multiple SCPI commands can be combined and sent as a single message with one message terminator. There are two important considerations when sending several commands within a single message:

- Use a semicolon to separate commands within a message.
- Head paths influence how the instrument interprets commands.

We consider the head path as a string which will be inserted in front of every command of a message. As for the first command of a message, the head path is a null string; for each subsequent command, the head path is a string which is defined to form the current command until and including the head of the last colon separator. A message with two combined commands:

```
CURR:LEV 3;PROT:STAT OFF
```

The example indicates the effect of semicolon and explains the concept of head path. Since the head path is defined to be "CURR" after "curr: lev 3", the head of the second command, "curr", is deleted and the instrument explains the second command as:

```
CURR:PROT:STAT OFF
```

If "curr" is explicitly included in the second command, it is semantically wrong. Since combining it with the head path will become "CURR:CURR:PROT:STAT OFF", resulting in wrong command.

Movement in the subsystem

In order to combine commands from different subsystems, you need to be able to reset the header path to a null string within a message. You do this by beginning the command with a colon (:), which discards any previous header path. For example, you could clear the output protection and check the status of the Operation Condition register in one message by using a root specifier as follows:

```
PROTection:CLEAR;;STATus:OPERation:CONDition?
```

The following message shows how to combine commands from different subsystems as well as within the same subsystem:

```
POWer:LEVel 200;PROTection 28; :CURRent:LEVel 3;PROTection:STATe ON
```

Note the use of the optional header LEVel to maintain the correct path within the voltage and current subsystems, and the use of the root specifier to move between subsystems.

Including Common Commands

You can combine common commands with subsystem commands in the same message. Treat the common command as a message unit by separating it with a semicolon (the message unit separator). Common commands do not affect the header path; you may insert them anywhere in the message.

```
VOLTage:TRIGgered 17.5;:INITialize;*TRG
```

```
OUTPut OFF;*RCL 2;OUTPut ON
```

Case sensitivity

Common commands and SCPI commands are not case sensitive. You can use upper or lower, for example:

```
*RST = *rst
```

```
:DATA? = :data?
```

:SYSTem:PRESet = :system:preset

Long-form and short-form versions

A SCPI command word can be sent in its long-form or short-form version. The command subsystem tables in Section 5 provide the in the long-form version. However, the short-form version is indicated by upper case characters. Examples:

:SYSTem:PRESet long-form

:SYST:PRES short form

:SYSTem:PRES long-form and short-form combination

Note that each command word must be in long-form or short-form, and not something in between.

For example, :SYSTe:PRESe is illegal and will generate an error. The command will not be executed.

Query

Observe the following precautions with queries:

- Set up the proper number of variables for the returned data. For example, if you are reading back a measurement array, you must dimension the array according to the number of measurements that you have placed in the measurement buffer.
- Read back all the results of a query before sending another command to the electronic load. Otherwise a Query Interrupted error will occur and the unreturned data will be lost.

Message Type of SCPI

There are two types of SCPI messages, program and response.

- program message: A program message consists of one or more properly formatted SCPI commands sent from the controller to the electronic load. The message, which may be sent at any time, requests the electronic load to perform some action.
- response message: A response message consists of data in a specific SCPI format sent from the electronic load to the controller. The electronic load sends the message only when commanded by a program message called a "query."

The next figure illustrates SCPI message structure:

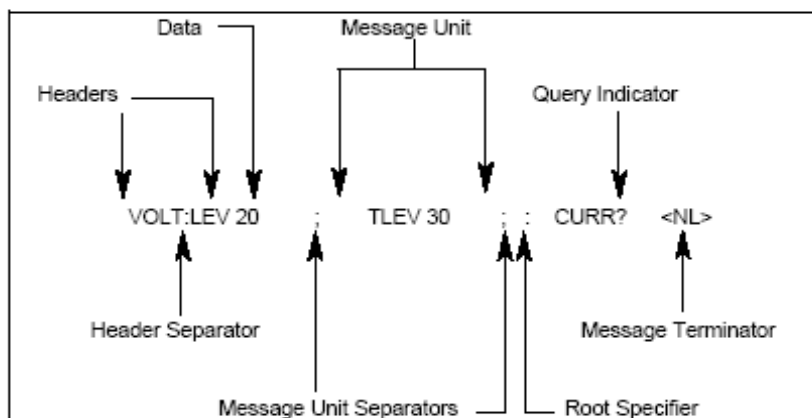

Figure 21 SCPI message structure

The Message Unit

The simplest SCPI command is a single message unit consisting of a command header (or keyword) followed by a message terminator. The message unit may include a parameter after the header. The parameter can be numeric or a string.

```
VOLTage 20<NL>
```

Headers

Headers, also referred to as keywords, are instructions recognized by the electronic load. Headers may be either in the long form or the short form. In the long form, the header is completely spelled out, such as VOLTAGE, STATUS, and DELAY. In the short form, the header has only the first three or four letters, such as VOLT, STAT, and DEL.

Query Indicator

Following a header with a question mark turns it into a query (VOLTage?, VOLTage:PROTection?). If a query contains a parameter, place the query indicator at the end of the last header(VOLTage:PROTection?MAX).

Message Unit Separator

When two or more message units are combined into a compound message, separate the units with a semicolon (STATus:OPERation?;QUEStionable?).

Root Specifier

When it precedes the first header of a message unit, the colon becomes the root specifier. It tells the command parser that this is the root or the top node of the command tree.

Message Terminator

A terminator informs SCPI that it has reached the end of a message. Three permitted message terminators are:

- newline (<NL>), decimal 10 or hexadecimal 0X0A in ASCII.
- end or identify (<END>)
- both of the above (<NL><END>).

In the examples of this guide, there is an assumed message terminator at the end of each message.

Command execution rules

- Commands execute in the order that they are presented in the program message.
- An invalid command generates an error and, of course, is not executed.
- Valid commands that precede an invalid command in a multiple command program message are executed.
- Valid commands that follow an invalid command in a multiple command program message are ignored.

SCPI Data Form

All data programmed to or returned from the electronic load is ASCII. The data may be numerical or character string.

Data Form

Symbol	Data Form
	<u>Talking Formats</u>
<NR1>	Digits with an implied decimal point assumed at the right of the least-significant digit. Examples: 273
<NR2>	Digits with an explicit decimal point Example: .0273
<NR3>	Digits with an explicit decimal point and an exponent. Example: 2.73E+2
	<u>Listening Formats</u>
<Nrf>	Extended format that includes <NR1>, <NR2> and <NR3>. Example: 273 273. 2.73E2
<Nrf+>	Extension decimal form includes <Nrf> and MIN MAX DEF, Example: 273 273. 2.73E2.MAX. MIN and MAX are the minimum and maximum values. Within the scope of the parameter definitions, DEF is the default value.
<Bool>	Boolean Data. Example: 0 1 or ON OFF

Suffixes and Multipliers

Class	Suffix	Unit	Unit with Multiplier
Voltage	V	volts	MV (millivolt)
Current	A	amperes	MA (milliampere)
Power	W	watts	MW (milliwatt)
Resistance	OHM	Ohms	MOHM (megohm)
	Ω	ohms	M Ω (megohm)
Slew Rate	A/uS	amps/second	
	Ω /s	ohms/second	
	V/s	volts/second	
Time	s	seconds	MS (millisecond)
Common Multipliers			
	1E3	K	kilo
	1E-3	M	milli
	1E-6	U	micro

Response Data Type

Character strings returned by query statements may take either of the following forms, depending on the length of the returned string::

<CRD>	Character Response Data. Permits the return of character strings.
<AARD>	Arbitrary ASCII Response Data. Permits the return of undelimited 7-bit ASCII. This data type has an implied message terminator.
<SRD>	String Response Data. Returns string parameters enclosed in double quotes

Response messages

A response message is the message sent by the instrument to the computer in response to a query command.

Sending a response message

After sending a query command, the response message is placed in the Output Queue. When the 2380 Series is then addressed to talk, the response message is sent from the Output Queue to the computer.

Multiple response messages

If you send more than one query command in the same program message (see the paragraph entitled, "Multiple Command Messages"), the multiple response messages for all the queries is sent to the computer when the 2380 Series is addressed to talk. The responses are sent in the order that the query commands were sent and are separated by semicolons (;). Items within the same query are separated by commas (.). The following example shows the response message for a program message that contains four single item query commands:

```
0; 1; 1; 0
```

Response message terminator (RMT)

Each response is terminated with an LF (line feed) and EOI (end or identify). The following example shows how a multiple response message is terminated:

```
0; 1; 1; 0; <RMT>
```

Message exchange protocol

Two rules summarize the message exchange protocol:

Rule 1. You must always tell the 2380 Series what to send to the computer.

The following two steps must always be performed to send information from the instrument to the other computer:

1. Send the appropriate query command(s) in a program message.
2. Address the 2380 Series to talk.

Rule 2. The complete response message must be received by the computer before another program message can be sent to the 2380 Series.

SCPI Command Complete

SCPI commands sent to the electronic load are processed either sequentially or in parallel. Sequential commands finish execution before a subsequent command begins. Parallel commands allow other commands to begin executing while the parallel command is still executing. Commands that affect trigger actions are among the parallel commands.

*WAI, *OPC, and *OPC:Common commands provide different ways of indicating when all transmitted commands, including any parallel ones, have completed their operations. Some practical considerations for using these commands are as follows:

*WAI: This prevents the electronic load from processing subsequent commands until all pending operations are completed.

*OPC?: This places a 1 in the Output Queue when all pending operations have completed. Because it requires your program to read the returned value before executing the next program statement, *OPC? can be used to cause the controller to wait for commands to complete before proceeding with its program.

*OPC: This sets the OPC status bit when all pending operations have completed. Since your program can read this status bit on an interrupt basis, *OPC allows subsequent commands to be executed.

NOTE

The trigger system must be in the Idle state in order for the status OPC bit to be true.

Therefore, as far as triggers are concerned, OPC is false whenever the trigger system is in the Initiated state.

Using Device Clear

You can send a device clear at any time to abort a SCPI command that may be hanging up the GPIB interface. The status registers, the error queue, and all configuration states are left unchanged when a device clear message is received. Device clear performs the following actions:

- The input and output buffers of the electronic load are cleared.
- The electronic load is prepared to accept a new command string.

The following statement shows how to send a device clear over the GPIB interface using GW BASIC:

```
CLEAR 705          IEEE-488 Device Clear
```

The following statement shows how to send a device clear over the GPIB interface using the GPIB command library for C or QuickBASIC.

```
IOCLEAR (705)
```

Default setup

The following table lists the settings that are restored when you return the electronic load to default settings.

Menu or system	Defaults	Menu or system	Defaults
INPUT	OFF	CURR:RANG	DEF
INP:SHOR	OFF	CURR	DEF
TRAN	OFF	CURR:HIG	DEF
FUNC	CC	CURR:LOW	DEF
REM:SENS	OFF	VOLT:RANG	DEF
VOLT:RANG:AUTO	ON	VOLT	DEF
CURR:TRAN:MODE	CONT	VOLT:HIG	DEF
VOLT:TRAN:MODE	CONT	VOLT:LOW	DEF
RES:TRAN:MODE	CONT	RES:RANG	DEF
POW:TRAN:MODE	CONT	RES	DEF
CURR:PROT	OFF	RES:HIG	DEF
TRAC:DEL	0	RES:LOW	DEF
TRAC:TIM	1	POW:RANG	DEF
TRAC:POIN	1000	POW	DEF
TRAC:FEED	TWO	POW:HIG	DEF
TRAC:FEED:CONT	NEV	POW:LOW	DEF
TRAC:FILT	OFF	CURR:SLEW	DEF
VOLT:LATC	ON	CURR:TRAN:ALEV	DEF
INP:TIM:DEL	10	CURR:TRAN:BLEV	DEF
INP:TIM	OFF	CURR:TRAN:AWID	DEF

CURR:TRAN:BWID	DEF	VOLT:TRAN:ALEV	DEF
VOLT:TRAN:BLEV	DEF	VOLT:TRAN:AWID	DEF
VOLT:TRAN:BWID	DEF	RES:TRAN:ALEV	DEF
RES:TRAN:BLEV	DEF	RES:TRAN:AWID	DEF
RES:TRAN:BWID	DEF	POW:TRAN:ALEV	DEF
POW:TRAN:BLEV	DEF	POW:TRAN:AWID	DEF
POW:TRAN:BWID	DEF	POW:PROT	DEF
POW:CONF	DEF	POW:PROT:DEL	DEF
CURR:PROT:LEV	DEF	CURR:PROT:DEL	DEF
SENS:AVER:COUN	DEF	-	-

Please note that the default value of VOLT:RANG depends on the actual voltage of the instrument measured from the input terminals.

2380 Commands

Common commands

Common commands begin with an * and consist of three letters (command) or three letters and ?(query). They are defined by the IEEE 488.2 standard to perform common interface functions. Common commands and queries are categorized under System, Status, or Trigger functions and are listed at the end of this chapter.

The electronic loads respond to the required common commands that control status reporting, synchronization, and internal operations. The electronic loads also respond to optional common commands that control triggers, power-on conditions, and stored operating parameters.

If a command has a corresponding query that simply returns the data or status specified by the command, then both command and query are included under the explanation for the command. If a query does not have a corresponding command or is functionally different from the command, then the query is listed separately. The description for each common command or query specifies any status registers affected.

Mnemonic	Name	Description
*CLS	Clear status	Clear all the event registers and error queue.
*ESE <NRf>	Event enable command	Edit the Standard Event Enable Register.
*ESE?	Event enable query	Read the Standard Event Enable Register.
*ESR?	Event status query	Read the Standard Event Status Register and clear it.
*IDN?	Identification query	Return the instrument manufacture, model, serial number and firmware revision level.
*OPC	Operation complete command	Set the Operation Complete bit in the Standard Event Status Register after all pending commands have been executed.
*OPC?	Operation complete query	Places an ASCII "1" into the output queue when all pending selected device operations have been completed.
*RCL <NRf>	Recall Command	Returns the Load to the setup configuration stored in the specified memory location.
*RST	Reset Command	Returned the Load to the *RST default conditions.

*SAV <NRf>	Save Command	Saves the current setup to the specified memory location.
*SRE <NRf>	Service request enable command	Programs the Service Request Enable register.
*SRE?	Service request enable query	Reads the Service Request Enable Register.
*STB?	Read status byte query	Read the status byte register
*TRG	Trigger Command	Send a trigger to Load.
*TST?	Self-test query	Execute self-test and return a result.
*WAI	Wait to continue command	Wait until all previous commands are executed.

*CLS (no query form)

This command clears the bits of the following registers:

- _ Standard Event Register
- _ Operation Event Register
- _ Questionable Event Register
- _ Error Queue

Group	Status
Syntax	*CLS
Related Commands	*ESR? , *STB?

*ESE

Sets and queries the bits in the Event Status Enable Register (ESER). The ESER is an eight-bit mask register that determines which bits in the Standard Event Status Register (SESR) will set the ESB bit in the status byte register (SBR) See Status Register, Registers for more information about registers.

Group	Status
Syntax	*ESE <mask> *ESE?
Arguments	<mask> ::= <NR1>

where:

<NR1> is a value in the range from 0 through 255. The binary bits of the ESER are set according to this value.

The power-on default for ESER is 0 if *PSC is 1. If *PSC is 0, the ESER maintains its value through a power cycle.

Example

*ESE 145 sets the ESER to binary 10010001, which enables the PON, EXE, and OPC bits.

*ESE might return the string *ESE 186, showing that the ESER contains the binary value 10111010.

Related Command

*ESR?, *CLS

***ESR? (query only)**

Returns the contents of the Standard Event Status Register (SESR). *ESR? also clears the SESR (since reading the SESR clears it) See Status Register, registers for more information about SESR.

Group

Status

Syntax

*ESR?

Returns

<NR1>, which is a decimal representation of the contents of the Standard Event Status Register (SESR).

Example

*ESR? might return the value 149, showing that the SESR contains binary 10010101.

Related Command

*CLS *SRE *OPC

***IDN?**

This query requests the electronic load to identify itself. It returns the data in four fields separated by commas.

Group

Status

Syntax

*IDN?

Returns

A string that includes <manufacturer>, <model>, <serial number>, and <firmware_version> as defined in the following table.

<manufacturer>	<model>	<serial number>	<firmware_version>
Keithley	2380-XXX-XX	XXX...XX	X.XX-X.XX

Examples

*IDN? might return the following response for a 2380-120-60 instrument:

Keithley, 2380-120-60, 802436010707110008, 1.37-1.39

***OPC**

This command configures the instrument to generate an operation complete message by setting bit 0 of the Standard Event Status Register (SESR) when all pending commands that generate an OPC message are complete.

The query command places the ASCII character "1" into the output queue when all such OPC commands are complete.

Group

Synchronization

Syntax

*OPC
*OPC?

Example

*OPC? might return 1 to indicate that all pending OPC operations are finished.

***PSC**

Sets and queries the power-on status flag that controls the automatic power-on execution of SRER and ESER. When *PSC is true, the SRER and ESER are set to 0 at power-on. When *PSC is false, the current values in the SRER and ESER are preserved in nonvolatile memory when power is shut off and are restored at power-on.

Group

Source

Syntax

*PSC <BOOL>
*PSC?

Related Command

[*RST](#)
[*OPC](#)

Arguments	<p><code><NR1> = 0/OFF</code> sets the power-on status clear flag to false, disables the power-on clear, and allows the electronic load to possibly assert SRQ after power on.</p> <p><code><NR1> = 1/ON</code> sets the power-on status clear flag to true. Sending <code>*PSC 1</code> therefore enables the power-on status clear and prevents any SRQ assertion after power-on.</p>
Returns	0 1
Example	<p><code>*PSC 0</code></p> <p>sets the power-on status clear flag to false.</p> <p><code>*PSC?</code></p> <p>might return 1, indicating that the power-on status clear flag is set to true.</p>

*RCL(no query form)

	Restores the state of the electronic load from a copy of its settings stored in the setup memory. The settings are stored using the <code>*SAV</code> command. If the specified setup memory is deleted, this command causes an error.
Group	Save and Recall
Syntax	<code>*RCL <NR1></code>
Arguments	<code><NR1></code> is an integer value in the range from 0 to 100 and specifies the location of setup memory.
Example	<p><code>*RCL 3</code></p> <p>sets the electronic load to settings stored in memory location 3.</p>
Related Command	*SAV

*RST (no query form)

This command resets the electronic load to default settings, but does not purge any stored settings.

Sending the `*RST` command does the following:

- Returns the electronic load settings to the defaults described in Default setup.

- Clears the pending operation flag and associated operations

The *RST command does not change the following items:

- State of the USB or GPIB interface
- Calibration data that affects device specifications
- Current GPIB electronic load address
- Stored settings
- Output queue
- Service Request Enable Register settings
- Standard Event Status Enable Register settings
- Power-On Status Clear flag setting
- Front-panel LOCK state

Group	Status
Syntax	*RST

*SAV (no query form)

Saves the state of the electronic load into a specified nonvolatile memory location. Any settings that had been stored previously at the location are overwritten. You can later use the *RCL command to restore the electronic load to this saved state.

Group	Status
Syntax	*SAV <NR1>
Returns	<NR1> is an integer value in the range from 0 to 100.
Example	*SAV 2 saves the settings in memory location 2.
Related Command	*RCL

*SRE

Service request enable (SRE) sets and queries the bits in

the service request enable register (SRER). See Status Register, Registers for more information about SRER.

Group	Status
Syntax	*SRE <NR1> *SRE?
Arguments	<NR1> is an integer value in the range from 0 to 255. The binary bits of the SRER are set according to this value. Using an out-of-range value causes an execution error. The power-on default for SRER is 0 if *PSC is 1. If *PSC is 0, the SRER maintains its value through a power cycle.
Example	*SRE 48 sets the bits in the SRER to 00110000 binary. *SRE? might return a value of 32, showing that the bits in the SRER have the binary value 00100000.
Related Command	*CLS *ESR? *PSC

*STB?

This query reads the Status Byte register, which contains the status summary bits and the Output Queue MAV bit. Reading the Status Byte register does not clear it. The input summary bits are cleared when the appropriate event registers are read. A serial poll also returns the value of the Status Byte register, except that bit 6 returns Request for Service (RQS) instead of Master Status Summary (MSS). A serial poll clears RQS, but not MSS. When MSS is set, it indicates that the electronic load has one or more reasons for requesting service.

Group	Status
Syntax	*STB?
Arguments	None
Returns	<NR1> (register value)
Related Command	*CLS *ESR? *ESE

***TRG**

This command generates a trigger to any system that has BUS selected as its source (for example, TRIG:SOUR BUS). The command has the same affect as the Group Execute Trigger (<GET>) command.

Group	Trigger
Syntax	*TRG
Arguments	None
Related Command	FORCE:TRIGGER

***TST?**

This query causes the electronic load to do a self-test and report any errors.

Group	Diagnostic
Syntax	*TST?
Arguments	None
Returns	<NR1> 0 indicates the load passes its self test. Non-zero indicates an error code.

***WAI**

This command instructs the electronic load not to process any further commands until all pending operations are completed.

Pending operations are complete when:

All commands sent before *WAI have been executed. This includes overlapped commands. Most commands are sequential and are completed before the next command is executed. Overlapped commands are executed in parallel with other commands. Commands that affect input voltage or state, relays, and trigger actions are overlapped with

subsequent commands sent to the electronic load. The *WAI command prevents subsequent commands from being executed before any overlapped commands have been completed.

All triggered actions are completed and the trigger system returns to the Idle state.*WAI can be aborted only by sending the electronic load a GPIB DCL (Device Clear) command.

Group	Synchronization
Syntax	*WAI
Arguments	None
Related Command	*OPC

STATus subsystem

These commands program the electronic load status registers.

STATus:QUEStionable?

This query returns the value of the Questionable Event register. The Event register is a read-only register that holds (latches) all events that pass into it. Reading the Questionable Event register clears it. This command is not channel specific, it applies to the entire mainframe.

Group	Status
Syntax	STATus:QUEStionable[:EVENT]?
Returns	<NR1> (register value)
Example	STAT:QUES:EVEN?
Related Command	*CLS

STATus:QUEStionable:ENABLE

This command sets or reads the value of the Questionable

Enable register. This register is a mask for enabling specific bits from the Questionable Event register to set the questionable summary (QUES) bit of the Status Byte register. This bit (bit 3) is the logical OR of all the Questionable Event register bits that are enabled by the Questionable Status Enable register. This command is not channel specific, it applies to the entire mainframe.

Group	Status
Syntax	<pre>STATus:QUEStionable:ENABle <NR1> STATus:QUEStionable:ENABle?</pre>
Arguments	0 to 65535
Returns	<NR1> (register value)
Default Value	0
Example	STAT:QUES:ENAB 32 STAT:QUES:ENAB 1
Related Command	STAT:QUES?

STATus:QUEStionable:PTRansition

This command sets or reads the positive value of the questionable condition register. When the bit value of the questionable condition register changes from 0 to 1, and the corresponding bit of ptransition register is 1, then the corresponding bit value of questionable event register turns into 1.

Group	Status
Syntax	<pre>STATus:QUEStionable:PTRansition<NR1> STATus:QUEStionable:PTRansition?</pre>
Arguments	<pre><mask>::=<NR1></pre> <p>where:</p> <p><NR1> is a number ranging from 0 through 65535. The binary bits of the questionable PTR register are set according to this value.</p>

Default Value	0
Returns	<mask>
Example	<p>STATUS:QUESTIONABLE:PTRANSITION 8</p> <p>STATUS:QUESTIONABLE:PTRANSITION? might return 8 which would indicate that a positive transition on the Remote Inhibit bit of the questionable condition register would be registered as an event.</p>
Related Command	STAT:QUES?

STATus:QUEStionable:NTRansition

This command sets or reads the negative value of the questionable condition register. When the bit value of the questionable condition register changes from 1 to 0, and the corresponding bit of ntransition register is 1, then the corresponding bit value of questionable event register turns into 1.

Group	Status
Syntax	<p>STATus:QUEStionable:NTRansition <mask></p> <p>STATus:QUEStionable:NTRansition?</p>
Arguments	<p><mask>::=<NR1></p> <p>where:</p> <p><NR1> is a number ranging from 0 through 65535. The binary bits of the Questionable NTR register are set according to this value.</p>
Default Value	0
Returns	<mask>
Example	<p>STATUS:QUESTIONABLE:NTRANSITION 8</p> <p>STATUS:QUESTIONABLE:NTRANSITION? might return 8, which would indicate that a negative transition on the Remote Inhibit bit of the questionable condition register would be registered as an event.</p>

**Related
Command**

[STAT:QUES?](#)

STATus:QUEStionable:CONDition?

This query returns the value of the Questionable Condition register. That is a read-only register that holds the real-time (unlatched) questionable status of the electronic load. This command is not channel specific, it applies to the entire mainframe.

Group

Status

Syntax

STATus:QUEStionable:CONDition?

Returns

<NR1> (register value)

Example

STAT:QUES:COND?

**Related
Command**

[STAT:OPER:COND?](#)

STATus:OPERation?

This query returns the value of the Operation Event register. Reading the Operation Event register clears it. This command is not channel specific, it applies to the entire mainframe.

Group

Status

Syntax

STATus:OPERation[:EVENT]?

Returns

<NR1> (register value)

Example

STAT:OPER:EVEN?

**Related
Command**

[*CLS](#)

STATus:OPERation:ENABLE

This command and its query set and read the value of the

Operation Enable register. This register is a mask for enabling specific bits from the Operation Event register to set the operation summary bit (OPER) of the Status Byte register. The operation summary bit is the logical OR of all enabled Operation Event register bits. This command is not channel specific, it applies to the entire mainframe.1

Group	Status
Syntax	STATus:OPERation:ENABle <NR1> STATus:OPERation:ENABle?
Arguments	0 to 65535
Default Value	0
Returns	<NR1> (register value)
Example	STAT:OPER:ENAB 32 STAT:OPER:ENAB 1
Related Command	STAT:OPER?

STATus:OPERation:CONDition?

This query returns the value of the Operation Condition register. That is a read-only register that holds the real-time (unlatched) operational status of the electronic load.

This command is not channel specific, it applies to the entire mainframe.

Group	Status
Syntax	STATus:OPERation:CONDition?
Returns	<NR1> (register value)
Example	STAT:OPER:COND?
Related Command	STAT:QUES:COND?

STATus:PRESet

When this command is sent, the SCPI event registers are affected as follows:

All bits of the following registers are cleared to zero (0):

Questionable Event Enable Register.

Operation Event Enable Register.

NOTE: Registers not included in the above list are not affected by this command.

Group	Status
Syntax	STATus:PRESet
Arguments	None
Example	STAT:PRES

System Command

System commands control the system-level functions of the electronic load that are not directly related to input control or measurement functions.

SYSTEM:POSetup

This command is used to select the power-on defaults. With RST selected, the instrument powers up to the *RST default conditions. With the SAV0 parameter selected, the instrument powers-on to the setup that is saved in the specified location using the *SAV command.

Group	System
Syntax	SYSTEM:POSetup<CRD> SYSTEM:POSetup?
Arguments	RST SAV0
*RST	RST
Returns	<CRD>
Example	SYST:POS RST
Related Command	*RST *SAV

SYSTem:VERSion?

This query returns the SCPI version number to which the electronic load complies to. The value is of the form YYYY.V, where YYYY is the year and V is the revision number for that year.

Group	System
Syntax	SYSTem:VERSion?
Returns	<NR2>
Example	SYST:VERS?

SYSTem:ERRor?

This query returns the next error number followed by its corresponding error message string from the remote programming error queue.

The queue is a FIFO (first-in, first-out) buffer that stores errors as they occur. As it is read, each error is removed from the queue.

When all errors have been read, the query returns "0, No Error". If more errors are accumulated than the queue can hold, the last error in the queue is "-350, Too Many Errors".

Group	System
Syntax	SYSTem:ERRor?
Returns	<NR1>, <error_text> <error_text> ::= <string> where: <string> is a description of the error.
Example	SYST:ERR?

SYSTem:CLEar

This action command is used to clear the Error Queue of messages.

Group	System
Syntax	SYSTem:CLEar
Arguments	None
Example	SYST:CLE
Related Command	SYST:ERR?

SYSTem:LOCal

This command sets the electronic load for control from the front-panel.

Group	System
Syntax	SYSTem:LOCal
Arguments	None
Example	SYST:LOC
Related Command	SYST:REM SYST:RWL

SYSTem:REMOte

This command sets the electronic load to remote control mode.

Group	System
Syntax	SYSTem:REMOte
Arguments	None
Example	SYST:REM

Related Command[SYST:LOC](#) [SYST:RWL](#)

SYSTEM:RWLock

If the electronic load is in remote mode, this command locks out the front panel. This command has no effect if the instrument is in local mode. Use SYSTEM:LOCAL to return the front panel to the local state. This command is not suitable for GPIB bus.

Group

System

Syntax

SYSTEM:RWLock

Arguments

None

Example

SYST:RWL

Related Command[SYST:REM](#) [SYST:LOC](#)

SYSTEM:KEY

This command can produce the same effect as pressing one of the front-panel buttons. The instrument must be in local mode in order for this command to simulate a front-panel button press. This command is not suitable for GPIB bus.

Group

System

Syntax

```
SYSTEM:KEY <NR1>
SYSTEM:KEY?
```

Arguments

<NR1> is an integer key code (see the following table). When sending invalid keys, the load has no response.

Returns

<NR1>

Front-panel button	<NR1> key code	Front-panel button	<NR1> key code
KEY_CC	1	KEY_0	9
KEY_CV	2	KEY_1	10
KEY_CR	3	KEY_2	11
KEY_CP	4	KEY_3	12

When the display mode of VFD is set to TXT, this command is used to display the setup strings.

Group	Display
Syntax	DISPlay[:WINDow]:TEXT<NR1>, <SRD>
Arguments	<NR1> is a value in the range from 0 through 47, Which is the starting position of the characters. <SRD>. Up to 48 characters.
Example	DISP:TEXT 0, "HELLO!"
Related Command	DISP:MODE

MEASurement subsystem

The signal-oriented measurement commands are used to acquire readings. You can use these high-level instructions to control the measurement process.

FETCh:VOLTage[:DC]? (query only)

This command returns the last measured input voltage stored in the communications buffer of the electronic load. A new measurement is not initiated by this command.

Group	Measurement
Syntax	FETCh:VOLTage[:DC]?
Returns	<NR2> is the measured input voltage in volts.
Example	FETC:VOLT? might return 5.0011, which would be the measured voltage across the electronic load inputs in volts.

FETCh:VOLTage:MAX? (query only)

This command returns the last measured input maximum voltage stored in the communications buffer of the electronic load. A new measurement is not initiated by this command.

Group	Measurement
Syntax	FETCh:VOLTage:MAX?
Returns	<NR2> is the measured input maximum voltage in volts.
Example	FETC:VOLT:MAX? might return 100.0011, which would be the measured maximum voltage across the electronic load inputs in volts.

FETCh:VOLTage:MIN? (query only)

This command returns the last measured input minimum voltage stored in the communications buffer of the electronic load. A new measurement is not initiated by this command.

Group	Measurement
Syntax	FETCh:VOLTage:MIN?
Returns	<NR2> is the measured input minimum voltage in volts.
Example	FETC:VOLT:MIN? might return 1.0011, which would be the measured minimum voltage across the electronic load inputs in volts.

FETCh:CURRent[:DC]? (query only)

This command returns the last measured input current stored in the communications buffer of the electronic load. A new measurement is not initiated by this command.

Group	Measurement
Syntax	FETCh:CURRent[:DC]?
Returns	<NR2> is the measured input current in amperes.
Example	FETC:CURR? might return 3.001, which would be the measured current across the electronic load inputs in amperes.

FETCh:CURRent:MAX? (query only)

This command returns the last measured input maximum current stored in the communications buffer of the electronic load. A new measurement is not initiated by this command.

Group	Measurement
Syntax	FETCh:CURRent:MAX?
Returns	<NR2> is the measured input maximum current in amperes.
Example	FETC:CURR:MAX? might return 40.001, which would be the measured maximum current across the electronic load inputs in amperes.

FETCh:CURRent:MIN? (query only)

This command returns the last measured input minimum current stored in the communications buffer of the electronic load. A new measurement is not initiated by this command.

Group	Measurement
Syntax	FETCh:CURRent:MIN?
Returns	<NR2> is the measured input minimum current in amperes.
Example	FETC:CURR:MIN? might return 1.001, which would be the measured minimum current across the electronic load inputs in amperes.

FETCh:POWer[:DC]? (query only)

This command returns the last measured input power stored in the communications buffer of the electronic load. A new measurement is not initiated by this command.

Group	Measurement
Syntax	FETCh:POWer[:DC]?

Returns	<NR2> is the measured input power in watt.
Example	FETC:POW? might return 5.01, which would be the measured power across the electronic load inputs in watt.

FETCh:CAPability? (query only)

This command returns the last measured discharging capability stored in the communications buffer of the electronic load. A new measurement is not initiated by this command.

Group	Measurement
Syntax	FETCh:CAPability?
Returns	<NR2> is the measured input discharging capability in ampere-hour.
Example	FETC:CAP? might return 5.011, which would be the measured discharging capability of the electronic load in ampere-hour.

FETCh:TIME? (query only)

This command returns the last measured discharging time stored in the communications buffer of the electronic load. A new measurement is not initiated by this command.

Group	Measurement
Syntax	FETCh:TIME?
Returns	<NR2> is the measured discharging time in second.
Example	FETC:TIME? might return 5.1, which would be the measured discharging time of the electronic load in second.

MEASure:VOLTage[:DC]? (query only)

This command initiates and executes a new voltage measurement, and returns the measured input voltage of

	the electronic load.
Group	Measurement
Syntax	MEASure:VOLTage[:DC]?
Returns	<NR2> is the measured input voltage in volts.
Example	MEAS:VOLT? might return 5.0011, which would be the measured voltage across the electronic load inputs in volts.

MEASure:VOLTage:MAX? (query only)

This command initiates and executes a new maximum voltage measurement, and returns the measured input maximum voltage of the electronic load.

Group	Measurement
Syntax	MEASure:VOLTage:MAX?
Returns	<NR2> is the measured input maximum voltage in volts.
Example	MEAS:VOLT:MAX? might return 100.0011, which would be the measured maximum voltage across the electronic load inputs in volts.

MEASure:VOLTage:MIN? (query only)

This command initiates and executes a new minimum voltage measurement, and returns the measured input minimum voltage of the electronic load.

Group	Measurement
Syntax	MEASure:VOLTage:MIN?
Returns	<NR2> is the measured input minimum voltage in volts.
Example	MEAS:VOLT:MIN? might return 1.0011, which would be the measured minimum voltage across the electronic load inputs in volts.

MEASure:CURRent[:DC]? (query only)

This command initiates and executes a new current measurement, and returns the measured input current of the electronic load.

Group	Measurement
Syntax	MEASure:CURRent[:DC]?
Returns	<NR2> is the measured input current in amperes.
Example	MEAS:CURR? might return 3.001, which would be the measured current across the electronic load inputs in amperes.

MEASure:CURRent:MAX? (query only)

This command initiates and executes a new maximum current measurement, and returns the measured input maximum current of the electronic load.

Group	Measurement
Syntax	MEASure:CURRent:MAX?
Returns	<NR2> is the measured input maximum current in amperes.
Example	MEAS:CURR:MAX? might return 40.001, which would be the measured maximum current across the electronic load inputs in amperes.

MEASure:CURRent:MIN? (query only)

This command initiates and executes a new minimum current measurement, and returns the measured input minimum current of the electronic load.

Group	Measurement
Syntax	MEASure:CURRent:MIN?
Returns	<NR2> is the measured input minimum current in amperes.

Example `MEAS:CURR:MIN?` might return 1.001, which would be the measured minimum current across the electronic load inputs in amperes.

MEASure:POWer[:DC]? (query only)

This command initiates and executes a new power measurement, and returns the measured input power of the electronic load.

Group Measurement

Syntax `MEASure:POWer[:DC]?`

Returns `<NR2>` is the measured input power in watt.

Example `MEAS:POW?` might return 5.01, which would be the measured power across the electronic load inputs in watt.

MEASure:CAPability? (query only)

This command initiates and executes a new discharging capability measurement, and returns the measured input discharging capability of the electronic load.

Group Measurement

Syntax `MEASure:CAPability?`

Returns `<NR2>` is the measured input discharging capability in ampere-hour.

Example `MEAS:CAP?` might return 5.011, which would be the measured discharging capability of the electronic load in ampere-hour.

MEASure:TIME? (query only)

This command initiates and executes a new discharging time measurement, and returns the measured input discharging time of the electronic load.

Group Measurement

Syntax	MEASure:TIME?
Returns	<NR2> is the measured discharging time in second.
Example	MEAS:TIME? might return 5.1, which would be the measured discharging time of the electronic load in second.

TRIGger subsystem

The trigger subsystem is composed of a series of commands and subsystems which use to configure trigger models.

FORCe:TRIGger

When the trigger system has been initiated, this command generates a trigger signal regardless of the selected trigger source.

Group	Trigger
Syntax	FORCe:TRIGger
Arguments	None
Example	FORCe:TRIGger
Related Arguments	TRIG:SOUR TRIG:TIM

This command selects the trigger source. This command is not channel specific, it applies to the entire mainframe.

- **BUS** Accepts a GPIB <GET> signal or a *TRG command as the trigger source. This selection guarantees that all previous commands are complete before the trigger occur.
- **EXternal** Selects the electronic load's trigger input as the trigger source. This trigger is processed as soon as it is received.
- **HOLD** Only FORCE:TRIGGER command will generate a trigger in HOLD mode. Other commands are swept aside.
- **MANUal** The event occurs when the Trig key is

	pressed.
	<ul style="list-style-type: none"> ● TIMer The generated trigger and internal electronic load are as a trigger source of crystal oscillator in sync. When the command is excuted, the synchronized crystal oscillator starts to run. Using the TRIG:TIM to edit the crystal oscillator periods.
Group	Trigger
Syntax	TRIGger:SOURce <CRD> TRIGger:SOURce?
Arguments	BUS EXTernal HOLD MANUal TIMer
Returns	<CRD>
*RST	MANUal
Example	TRIG:SOUR BUS TRIG:SOUR EXT
Related Command	FORCe:TRIGger

TRIGger:SOURce

This command is not channel specific, it applies to the entire mainframe.

- **BUS** Accepts a GPIB <GET> signal or a *TRG command as the trigger source. This selection guarantees that all previous commands are complete before the trigger occur.
- **EXTernal** Selects the electronic load's trigger input as the trigger source. This trigger is processed as soon as it is received.
- **HOLD** Only FORCE:TRIGGER command will generate a trigger in HOLD mode. Other commands are swept aside.
- **MANUal** The event occurs when the Trig key is pressed.
- **TIMer** The generated trigger and internal electronic load are as a trigger source of crystal oscillator in sync. When the command is excuted, the synchronized crystal oscillator starts to run. Using the

TRIG:TIM to edit the crystal oscillator periods.

Group	Trigger
Syntax	TRIGger:SOURce <CRD> TRIGger:SOURce?
Arguments	BUS EXTernal HOLD MANUal TIMer
Returns	<CRD>
*RST	MANUal
Example	TRIG:SOUR BUS TRIG:SOUR EXT
Related Command	FORCce:TRIGger

TRIGger:TIMer

This command specifies the period of the triggers generated by the internal trigger generator.

Group	Trigger
Syntax	TRIGger:TIMer <NRf+> TRIGger:TIMer? [MINimum MAXimum DEFault]
Arguments	0.01 to 9999.99s MINimum MAXimum DEFault
Unit	S(seconds)
*RST	0.01
Returns	<NR3>
Example	TRIG:TIM 0.25 TRIG:TIM MAX
Related Command	FORCce:TRIGger TRIG:SOUR

TRACe subsystem

The commands in this subsystem are used to configure and control data storage into the buffer.

TRACe:CLEAr

This action command is used to clear the buffer of readings. If you do not clear the buffer, a subsequent store will overwrite the old readings. If the subsequent store is aborted before the buffer becomes full, you could end up with some “old” readings still in the buffer.

Group	Trace
Syntax	TRACe:CLEAr
Arguments	None
Example	TRACe:CLEAr

TRACe:FREE?

This command is used to read the status of storage memory. After sending this command and addressing the electronic to talk, two values separated by commas are sent to the computer. The first value indicates how many bytes of memory are available, and the second value indicates how many bytes are reserved to store readings.

Group	Trace
Syntax	TRACe:FREE?
Returns	<NR1>, <NR1>
Example	TRAC:FREE?

TRACe:POINts

This command is used to specify the size of the buffer and cooperate the TRACe:FEED command. When TWO is selected, the maximum value of TRAC:POIN is 1000, each

current and voltage is accounted for 500. When VOLTAGE or CURRENT is selected, the maximum value of TRAC:POIN is 1000.

Group	Trace
Syntax	TRACe:POINts <NRf+> TRACe:POINts? [MINimum MAXimum DEFault]
Arguments	2 to 1000 MINimum MAXimum DEFault
Returns	<NR1>
Example	TRAC:POIN 10
Related Command	TRAC:FEED

TRACe:FEED

This command is used to select the source of readings to be placed in the buffer. With VOLTage selected, voltage readings are placed in the buffer, TRAC:POIN maximum values is 1000. With CURRent selected, current readings are placed in the buffer, TRAC:POIN maximum values is 1000. With TWO selected, voltage and current are placed in the buffer when storage is performed, TRAC:POIN maximum values is 1000.

Group	Trace
Syntax	TRACe:FEED <CRD> TRACe:FEED?
Arguments	VOLTAGE CURRENT TWO
Returns	<CRD>
Example	TRAC:FEED VOLT
Related Command	TRAC:POIN

TRACe:FEED:CONTRol

This command is used to select the buffer control. With NEVer selected, storage into the buffer is disabled. When NEXT is selected, the storage process starts, fills the buffer and then stops. When the buffer is full, you should send TRAC:CLE command to clear it. After cleared entirely, the buffer can catch data again. The buffer size is specified by the :POINTs command.

Group	Trace
Syntax	TRACe:FEED:CONTRol <CRD> TRACe:FEED:CONT?
Arguments	NEVer NEXT
Returns	<CRD>
Example	TRAC:FEED:CONT NEXT
Related Command	TRAC:FEED

TRACe:DATA?

When this command is sent and the electronic load is addressed to talk, all the readings stored in the buffer are sent to the computer.

Group	Trace
Syntax	TRACe:DATA?
Returns	{<NR3>}

TRACe:FILTer

The command is used to select whether the cached data for filtering the data.

Group	Trace
Syntax	TRACe:FILTer[:STATe] <BOOL> TRACe:FILTer[:STATe]?

Arguments	0 1 ON OFF
Returns	0 1
Example	TRAC:FILT 1

TRACe:DELaY

This command is used to select the delay time of buffer trigger.

Group	Trace
Syntax	TRACe:DELaY <NRf> TRACe:DELaY? [MINimum MAXimum DEFault]
Arguments	0 to 3600s MINimum MAXimum DEFault
Unit	S (seconds)
Default Value	0
Returns	<NR3>
Example	TRAC:DEL 1

TRACe:TIMer

This command is used to select the period of buffer.

Group	Trace
Syntax	TRACe:TIMer<NRf> TRACe:TIMer? [MINimum MAXimum DEFault]
Arguments	0.00002 to 3600s MINimum MAXimum DEFault
Unit	S (second)
Default Value	1
Returns	<NR3>

Example `TRAC:TIM 0.1`

SOURce subsystem

These commands control the input of the electronic load.

The INPut and OUTput commands are equivalent. INPut, The CURRent, RESistance and VOLTage commands program the actual input current, resistance, and voltage.

[SOURce:]INPut

These commands enable or disable the electronic load inputs. The state of a disabled input is a high impedance condition.

Group	Source
Syntax	[SOURce:]INPut[:STATe] <bool> [SOURce:]INPut[:STATe]?
Arguments	0 1 OFF ON
Default Value	OFF
Returns	0 1
Example	INP 1
Related Command	*RCL *SAV

[SOURce:]INPut:SHORT

This command programs the specified electronic load module to the maximum current that it can sink in the present operating range.

Group	Source
Syntax	[SOURce:]INPut:SHORT[:STATe] <bool> [SOURce:]INPut:SHORT:[STATe]?
Arguments	0 1 OFF ON

Default Value	OFF
Returns	0 1
Example	INP:SHOR 1
Related Command	INP

[SOURCE:]INPut:TIMer

These commands enable or disable the load on timer.

Group	Source
Syntax	[SOURCE:]INPut:TIMer[:STATe] <bool> [SOURCE:]INPut:TIMer[:STATe]?
Arguments	0 1 OFF ON
Default Value	OFF
Returns	0 1
Example	INP:TIM 1
Related Command	INP:TIM:DEL

[SOURCE:]INPut:TIMer:DELay

This command specifies the load on timer.

Group	Source
Syntax	[SOURCE:]INPut:TIMer <NRf+> [SOURCE:]INPut:TIMer:DELay? [MINimum MAXimum DEFault]
Arguments	1 to 60000s MINimum MAXimum DEFault
Unit	S(seconds)

Default Value	10
Returns	<NR3>
Example	INP:TIM:DEL 5
Related Command	INP:TIM

[SOURce:]FUNCTION

These equivalent commands select the input regulation mode of the electronic load.

Group	Source
Syntax	[SOURce:]FUNCTION <function> [SOURce:]FUNCTION?
Arguments	CURRent RESistance VOLTage POWer
Default Value	CURRent
Returns	<CRD>
Example	FUNCTION RESistance

[SOURce:]FUNCTION:MODE

This command can be in either fixed mode or list mode. When this command is in fixed mode, the electronic load responds to discrete commands. When this command is in list mode, the electronic load operates in list mode.

Fixed mode

The regulation mode is determined by the FUNCTION or MODE command.

List mode

Set this command to LIST to operate the electronic load in list mode. Attempts to edit a list while this command is in list mode will generate an error message of settings conflict. If you need to change the list, set this command to FIXEd before changing the list.

Group	Source
Syntax	[SOURce:]FUNction:MODE {FIXed LIST} [SOURce:]FUNction:MODE?
Arguments	FIXed configures the electronic load to respond to discrete commands. LIST configures the electronic load to operate in list mode.
Returns	FIXed LIST
Example	[SOURCE:]FUNCTION:MODE LIST

[SOURce:]TRANsient

This command turns the transient generator on or off. Before turning on the transient generator, you should set the value of INPUT:SHORT to OFF and set the value of FUNC:MODE to FIXED.

Group	Source
Syntax	[SOURce:]TRANsient[:STATe] <bool> [SOURce:]TRANsient[:STATe]?
Arguments	0 1 OFF ON
Default Value	OFF
Returns	0 1
Example	TRAN 1
Related Command	CURR:TRAN:MODE CURR:TRAN:ALEV

[SOURce:]PROTection:CLEar

This commands clear the latch that disables the input when a protection condition such as overvoltage (OV) or overcurrent (OC) is detected. All conditions that generated the fault must be removed before the latch can be cleared. The input is then restored to the state it was in before the

fault condition occurred.

Group	Source
Syntax	[SOURce:]PROTection:CLEar
Arguments	None
Example	PROT:CLE

[SOURce:]CURRent

This command sets the current that the load will regulate when operating in constant current mode.

Group	Source
Syntax	[SOURce:]CURRent[:LEVel][:IMMediate] <NRf+> [SOURce:]CURRent[:LEVel][:IMMediate]? [MINimum MAXimum DEFault]
Arguments	0 through MAX MINimum MAXimum DEFault
Unit	A (amperes)
Default Value	MINimum
Returns	<NR3>
Example	CURR 5 CURR:LEV 0.5
Related Command	CURR:RANG

[SOURce:]CURRent:RANGe

This command sets the current range of the electronic load module. There are two current ranges.

High Range Low Range

When you program a range value, the load automatically selects the range that corresponds to the value that you program. If the value falls in a region where ranges overlap, the load selects the range with the highest resolution.

Group	Source
Syntax	[SOURce:]CURRent:RANGE <NRf+> [SOURce:]CURRent:RANGE? [MINimum MAXimum DEFault]
Arguments	0 through MAX MINimum MAXimum DEFault
Unit	A (amperes)
Default Value	MAXimum (high range)
Returns	<NR3>
Example	SOUR:CURR:RANGE MIN
Related Command	CURR:SLEW

NOTE

When this command is executed, the IMMEDIATE, TRANSient, TRIGgered, and SLEW current settings are adjusted as follows:

If the existing settings are within the new range, no adjustment is made.

If the existing settings are outside the new range, the levels are set to the maximum value of the new range.

[SOURce:]CURRent:SLEW

This command sets the slew rate for all programmed changes in the input current level of the electronic load. This command programs both positive and negative going slew rates. MAXimum sets the slew to the fastest possible rate. MINimum sets the slew to the slowest rate.

Group	Source
Syntax	[SOURce:]CURRent:SLEW[:BOTH] <NRf+>
Arguments	MINimum to MAXimum MAXimum MINimum DEFault
Unit	A/uS: the current rising mode is quick mode. A/mS: the current rising mode is slow mode.

Default Value	MAXimum
Example	CURR:SLEW MAX
Related Command	CURR:SLEW:NEG CURR:SLEW:POS

[SOURce:]CURRent:SLEW:POSitive

This command sets the slew rate of the current for positive going transitions. MAXimum sets the slew to the fastest possible rate. MINimum sets the slew to the slowest rate.

Group	Source
Syntax	[SOURce:]CURRent:SLEW:POSitive <NRf+> [SOURce:]CURRent:SLEW:POSitive? [MINimum MAXimum DEFault]
Arguments	MINimum to MAXimum MAXimum MINimum DEFault
Unit	A/uS: the current rising mode is quick mode. A/mS: the current rising mode is slow mode.
Default Value	MAXimum
Returns	<NR3>
Example	CURR:SLEW:POS MAX
Related Command	CURR:SLEW

[SOURce:]CURRent:SLEW:NEGative

This command sets the slew rate of the current for negative going transitions. MAXimum sets the slew to the fastest possible rate. MINimum sets the slew to the slowest rate.

Group	Source
Syntax	[SOURce:]CURRent:SLEW:NEGative <NRf+>

	[SOURce:]CURRent:SLEW:NEGative? [MINimum MAXimum DEFault]
Arguments	MINimum to MAXimum MAXimum MINimum DEFault
Unit	A/uS: the current rising mode is quick mode. A/mS: the current rising mode is slow mode.
Default Value	MAXimum
Returns	<NR3>
Example	CURR:SLEW:NEG MAX
Related Command	CURR:SLEW

[SOURce:]CURRent:SLOWrate:STATE

This command is used to switch the speed of current rising slope. When the parameter is set to OFF indicates that the current rising mode is quick mode and the slope unit is A/US; When the parameter is set to ON indicates that the current rising mode is the slow mode and the slope unit is A/MS.

Group	Source
Syntax	[SOURce:]CURRent:SLOWrate[:STATE]<Bool> [SOURce:]CURRent:SLOWrate:STATE?
Arguments	0 1 OFF ON
Default Value	OFF
Returns	0 1
Example	CURR:SLOW:STAT 1
Related Command	CURR:SLEW

[SOURce:]CURRent:PROTection:STATe

This command enables or disables the over-current protection feature.

Group	Source
Syntax	[SOURce:]CURRent:PROTection:STATe <Bool> [SOURce:]CURRent:PROTection:STATe?
Arguments	0 1 OFF ON
Default Value	OFF
Returns	0 1
Example	CURR:PROT:STAT 1

[SOURce:]CURRent:PROTection:LEVel

This command sets the soft current protection level. If the input current exceeds the soft current protection level for the time specified by CURR:PROT:DEL, the input is turned off.

NOTE:Use CURR:PROT:DEL to prevent momentary current limit conditions caused by programmed changes from tripping the overcurrent protection.

Group	Source
Syntax	[SOURce:]CURRent:PROTection:LEVel <NRf+> [SOURce:]CURRent:PROTection:LEVel? [MINimum MAXimum DEFault]
Arguments	0 through MAX MINimum MAXimum DEFault
Unit	A (amperes)
Default Value	MAXimum
Returns	<NR3>
Example	CURR:PROT:LEV 2
Related	CURR:PROT:DEL CURR:PROT:STAT

Command**[SOURce:]CURRent:PROTection:DELaY**

This command specifies the time that the input current can exceed the protection level before the input is turned off.

Group	Source
Syntax	[SOURce:]CURRent:PROTection:DELaY <NRf+> [SOURce:]CURRent:PROTection:DELaY? [MINimum MAXimum DEFault]
Arguments	0 to 60 seconds MINimum MAXimum DEFault When the parameter is decimal, it will be rounded.
Unit	S(seconds)/ millisecond
Default Value	3
Returns	<NR1>
Example	CURR:PROT:DEL 5
Related Command	CURR:PROT:STAT

[SOURce:]CURRent:TRANsient:MODE

This command selects the operating mode of the transient generator as follows in constant current mode

- **CONTinuous** The transient generator puts out a continuous pulse stream after receipt of a trigger.
- **PULSe** The transient generator puts out a single pulse upon receipt of a trigger.
- **TOGGle** The transient generator toggles between two levels upon receipt of a trigger.

Group	Source
Syntax	[SOURce:]CURRent:TRANsient:MODE <mode> [SOURce:]CURRent:TRANsient:MODE?

Arguments	CONTinuous PULSe TOGGle
Default Value	CONTinuous
Returns	<CRD>
Example	CURR:TRAN:MODE TOGG
Related Command	CURR:TRAN:ALEV TRAN

[SOURce:]CURRent:TRANsient:ALEVEL

[SOURce:]CURRent:TRANsient:BLEVEL

This command specifies the transient level of the input current. The transient function switches between the level a and level b.

Group	Source
Syntax	[SOURce:]CURRent:TRANsient:ALEVEL <NRf+> [SOURce:]CURRent:TRANsient:BLEVEL <NRf+> [SOURce:]CURRent:TRANsient:ALEVEL? [MINimum MAXimum DEFault] [SOURce:]CURRent:TRANsient:BLEVEL? [MINimum MAXimum DEFault]
Arguments	0 through MAX MINimum MAXimum DEFault
Unit	A (amperes)
Default Value	ALEVEL MAXimum , BLEVEL MINimum
Returns	<NR3>
Example	CURR:TRAN:ALEV 5 CURR:TRAN:BLEV 0.5
Related Command	CURR

[SOURce:]CURRent:TRANsient:AWIDth**[SOURce:]CURRent:TRANsient:BWIDth**

This command specifies the transient pulse width of the input current.

Continuous: $awidth = 1/freq * duty$

$bwidth = 1/freq * (1-duty)$

Pulse: $awidth = pulse-width$

Group	Source
Syntax	[SOURce:]CURRent:TRANsient:AWIDth <NRf+> [SOURce:]CURRent:TRANsient:BWIDth <NRf+> [SOURce:]CURRent:TRANsient:AWIDth? [MINimum MAXimum DEFault] [SOURce:]CURRent:TRANsient:BWIDth? [MINimum MAXimum DEFault]
Arguments	0.00002S to 3600S
Unit	S (seconds)
Default Value	500S
Returns	<NR3>
Example	CURR:TRAN:AWID 0.001 CURR:TRAN:BWID 0.02
Related Command	CURR

[SOURce:]CURRent:HIGH**[SOURce:]CURRent:LOW**

This command set the voltage bounds in the CC mode.

Group	Source
Syntax	[SOURce:]CURRent:HIGH <NRf+>

	[SOURce:]CURRent:LOW <NRf+>
	[SOURce:]CURRent:HIGH?
	[MINimum MAXimum DEFault]
	[SOURce:]CURRent:LOW?
	[MINimum MAXimum DEFault]
Arguments	MINimum through MAX MINimum MAXimum DEFault
Unit	V (volts)
Default Value	MAXimum
Returns	<NR3>
Example	CURR:HIGH 5

[SOURce:]VOLTage

This command sets the voltage that the load will regulate when operating in constant voltage mode.

Group	Source
Syntax	[SOURce:]VOLTage[:LEVel][:IMMediate] <NRf+> [SOURce:]VOLTage[:LEVel][:IMMediate]? [MINimum MAXimum DEFault]
Arguments	MINimum through MAX MINimum MAXimum DEFault
Unit	V (volts)
Default Value	MAXimum
Returns	<NR3>
Example	VOLT 5
Related Command	VOLT:RANG

[SOURce:]VOLTage:RANGe

This command sets the voltage range of the electronic load module. There are two voltage ranges.

Group	Source
Syntax	<pre>[SOURce:]VOLTage:RANGe {<voltage> MINimum MAXimum DEFault }</pre> <pre>[SOURce:]VOLTage:RANGe?[MINimum MAXimum DEFault]</pre>
Arguments	<pre><voltage> ::= <NRf><units></pre> <p>where:</p> <p><NRf> is a flexible decimal that sets the maximum output voltage, ranging from 0 to the maximum nameplate voltage</p> <p><units> ::= {V}</p> <p>MIN: sets the voltage limit to the minimum value (0 V).</p> <p>MAX: sets the voltage limit to the maximum value which is slightly higher than the maximum nameplate voltage.</p> <p>DEF: sets the voltage limit to the default value, which equals MAX.</p>
Unit	V(volts)
Returns	<NR2> is the voltage limit in volts.
Example	<pre>VOLT:RANG 15</pre> <p>VOLT:RANG? might return 15, which would be the maximum programmable voltage in volts.</p>
Related Command	VOLT

[SOURce:]VOLTage:RANGe:AUTO[:STATe]

This command is used to switch the state of the voltage auto range of the electronic load module.

Group	Source
--------------	--------

Syntax	[SOURce:]VOLTage:RANGe:AUTO[:STATe] <bool> [SOURce:]VOLTage:RANGe:AUTO[:STATe]?
Arguments	0 1 ON OFF
Default Value	1
Returns	0 1
Example	VOLT:RANG:AUTO 1

[SOURce:]VOLTage:ON

This command sets the voltage of sink current on.

Group	Source
Syntax	[SOURce:]VOLTage[:LEVel]:ON <NRf+> [SOURce:]VOLTage[:LEVel]:ON? [MINimum MAXimum DEFault]
Arguments	0 through MAX MINimum MAXimum DEFault
Unit	V (volts)
Default Value	MINimum
Returns	<NR3>
Example	VOLT:ON 5
Related Command	VOLT: Latch

[SOURce:]VOLTage:LATCh

This command sets the action type of Von.

Group	Source
Syntax	[SOURce:]VOLTage:LATCh[:STATe] [SOURce:]VOLTage:LATCh[:STATe]?

Arguments	0 1 ON OFF
Default Value	ON
Returns	0 1
Example	VOLT:LATC 1
Related Command	VOLT:ON

[SOURce:]VOLTage:TRANSient:MODE

This command selects the operating mode of the transient generator as follows in constant voltage mode.

- **CONTinuous** The transient generator puts out a continuous pulse stream after receipt of a trigger.
- **PULSe** The transient generator puts out a single pulse upon receipt of a trigger.
- **TOGGLE** The transient generator toggles between two levels upon receipt of a trigger.

Group	Source
Syntax	[SOURce:]VOLTage:TRANSient:MODE <mode> [SOURce:]VOLTage:TRANSient:MODE?
Arguments	CONTinuous PULSe TOGGLE
Default Value	CONTinuous
Returns	<CRD>
Example	VOLT:TRAN:MODE TOGG
Related Command	VOLT:TRAN:ALEV TRAN

[SOURce:]VOLTage:TRANSient:ALEVEL

[SOURce:]VOLTage:TRANSient:BLEVEL

This command specifies the transient level of the input voltage. The transient function switches between the level

a and level b.

Group	Source
Syntax	<pre>[SOURce:]VOLTage:TRANSient:ALEVEL <NRf+> [SOURce:]VOLTage:TRANSient:BLEVEL <NRf+> [SOURce:]VOLTage:TRANSient:ALEVEL? [MINimum MAXimum DEFault] [SOURce:]VOLTage:TRANSient:BLEVEL? [MINimum MAXimum DEFault]</pre>
Arguments	MIN through MAX MINimum MAXimum DEFault
Unit	V (volts)
Default Value	ALEVELMAXimum , BLEVEL MINnum
Returns	<NR3>
Example	VOLT:TRAN:ALEV 5 VOLT:TRAN:BLEV 0.5
Related Command	VOLT

[SOURce:]VOLTage:TRANSient:AWIDTH

[SOURce:]VOLTage:TRANSient:BWIDTH

This command specifies the transient pulse width of the input voltage.

Group	Source
Syntax	<pre>[SOURce:]VOLTage:TRANSient:AWIDTH <NRf+> [SOURce:]VOLTage:TRANSient:BWIDTH <NRf+> [SOURce:]VOLTage:TRANSient:AWIDTH? [MINimum MAXimum DEFault] [SOURce:]VOLTage:TRANSient:BWIDTH? [MINimum MAXimum DEFault]</pre>
Arguments	0.0001S to 3600S
Unit	S (seconds)

Default Value	1000S
Returns	<NR3>
Example	VOLT:TRAN:AWID 0.001 VOLT:TRAN:BWID 0.02
Related Command	VOLT

[SOURce:]VOLTage:HIGH

[SOURce:]VOLTage:LOW

This command sets the current bounds in CV mode.

Group	Source
Syntax	[SOURce:]VOLTage:HIGH <NRf+> [SOURce:]VOLTage:LOW <NRf+> [SOURce:]VOLTage:HIGH? [MINimum MAXimum DEFault] [SOURce:]VOLTage:LOW? [MINimum MAXimum DEFault]
Arguments	MINimum through MAX MINimum MAXimum DEFault
Unit	A (amperes)
Default Value	MAXimum
Returns	<NR3>
Example	VOLT:HIGH 5

[SOURce:]RESistance

This command sets the resistance of the load when operating in constant resistance mode.

Group	Source
--------------	--------

Syntax	[SOURce:]RESistance[:LEVel][:IMMediate] <NRf+> [SOURce:]RESistance[:LEVel][:IMMediate]? [MINimum MAXimum DEFault]
Arguments	MINimum through MAX MINimum MAXimum DEFault
Unit	Ω (ohms)
Default Value	MAXimum
Returns	<NR3>
Example	RES 5 RES:LEV 3.5
Related Command	RES:RANG

[SOURce:]RESistance:RANGe

This command sets the resistance range of the electronic load module. There is only one resistance range.

Group	Source
Syntax	[SOURce:]RESistance:RANGe <NRf+> [SOURce:]RESistance:RANGe? [MINimum MAXimum DEFault]
Arguments	MINimum through MAX MINimum MAXimum DEFault
Unit	Ω (ohms)
Default Value	MAXimum (high range)
Returns	<NR3>
Example	RES:RANG 15 SOUR:RES:RANGE MIN

[SOURce:]RESistance:TRANSient:MODE

This command selects the operating mode of the transient generator as follows in constant resistance mode.

- **CONTInuous** The transient generator puts out a continuous pulse stream after receipt of a trigger.
- **PULSe** The transient generator puts out a single pulse upon receipt of a trigger.
- **TOGGle** The transient generator toggles between two levels upon receipt of a trigger.

Group	Source
Syntax	[SOURce:]RESistance:TRANSient:MODE <mode> [SOURce:]RESistance:TRANSient:MODE?
Arguments	CONTInuous PULSe TOGGle
Default Value	CONTInuous
Returns	<CRD>
Example	RES:TRAN:MODE TOGG
Related Command	RES:TRAN:ALEV TRAN

[SOURce:]RESistance:TRANSient:ALEVEL**[SOURce:]RESistance:TRANSient:BLEVEL**

This command specifies the transient level of the input resistance. The transient function switches between the level a and level b.

Group	Source
Syntax	[SOURce:]RESistance:TRANSient:ALEVEL <NRf+> [SOURce:]RESistance:TRANSient:BLEVEL <NRf+> [SOURce:]RESistance:TRANSient:ALEVEL? [MINimum MAXimum DEFault] [SOURce:]RESistance:TRANSient:BLEVEL? [

	MINimum MAXimum DEFault]
Arguments	MIN through MAX MINimum MAXimum DEFault
Unit	Ω (ohms)
Default Value	ALEVEL MAXimum , BLEVel MINnum
Returns	<NR3>
Example	RES:TRAN:ALEV 5 RES:TRAN:BLEV 0.5
Related Command	RES

[SOURce:]RESistance:TRANSient:AWIDth

[SOURce:]RESistance:TRANSient:BWIDth

This command specifies the transient pulse width of the input resistance.

Group	Source
Syntax	[SOURce:]RESistance:TRANSient:AWIDth <NRf+> [SOURce:]RESistance:TRANSient:BWIDth <NRf+> [SOURce:]RESistance:TRANSient:AWIDth? [MINimum MAXimum DEFault] [SOURce:]RESistance:TRANSient:BWIDth? [MINimum MAXimum DEFault]
Arguments	0.0001S to 3600S
Unit	S (seconds)
Default Value	1000S
Returns	<NR3>
Example	RES:TRAN:AWID 0.001 RES:TRAN:BWID 0.02
Related Command	RES

[SOURce:]RESistance:HIGH**[SOURce:]RESistance:LOW**

This command sets the voltage bounds in CR mode.

Group	Source
Syntax	<pre>[SOURce:]RESistance:HIGH <NRf+> [SOURce:]RESistance:LOW <NRf+> [SOURce:]RESistance:HIGH? [MINimum MAXimum DEFault] [SOURce:]RESistance:LOW? [MINimum MAXimum DEFault]</pre>
Arguments	MINimum through MAX MINimum MAXimum DEFault
Unit	V (volts)
Default Value	MAXimum
Returns	<NR3>
Example	RES:HIGH 5

[SOURce:]POWer

This command sets the power of the load when operating in CP mode.

Group	Source
Syntax	<pre>[SOURce:]POWer[:LEVel][:IMMediate] <NRf+> [SOURce:]POWer[:LEVel][:IMMediate]? [MINimum MAXimum DEFault]</pre>
Arguments	MINimum through MAX MINimum MAXimum DEFault
Unit	W(watts)

Default Value	MINimum
Returns	<NR3>
Example	POW 5 POW:LEV 3.5
Related Command	POW:RANG

[SOURce:]POWer:RANGe

This command sets the power range of the electronic load. There is only one power range.

Group	Source
Syntax	[SOURce:]POWer:RANGe <NRf+> [SOURce:]POWer:RANGe?
Arguments	MINimum through MAX MINimum MAXimum DEFault
Unit	W(watts)
Default Value	MAXimum (high range)
Returns	<NR3>
Example	POW:RANG 15

[SOURce:]POWer:TRANsient:MODE

This command selects the operating mode of the transient generator as follows in constant power mode.

- **CONTinuous** The transient generator puts out a continuous pulse stream after receipt of a trigger.
- **PULSe** The transient generator puts out a single pulse upon receipt of a trigger.
- **TOGGLE** The transient generator toggles between two levels upon receipt of a trigger.

Group	Source
--------------	--------

Syntax	[SOURce:]POWER:TRANSient:MODE <mode> [SOURce:]POWER:TRANSient:MODE?
Arguments	CONTInuous PULSe TOGGle
Default Value	CONTInuous
Returns	<CRD>
Example	POW:TRAN:MODE TOGG
Related Command	POW:TRAN:ALEV TRAN

[SOURce:]POWER:TRANSient:ALEVEL

[SOURce:]POWER:TRANSient:BLEVEL

This command specifies the transient level of the input power. The transient function switches between the level a and level b.

Group	Source
Syntax	[SOURce:]POWER:TRANSient:ALEVEL <NRf+> [SOURce:]POWER:TRANSient:BLEVEL <NRf+> [SOURce:]POWER:TRANSient:ALEVEL? [MINimum MAXimum DEFault] [SOURce:]POWER:TRANSient:BLEVEL? [MINimum MAXimum DEFault]
Arguments	0 through MAX MINimum MAXimum DEFault
Unit	W(watts)
Default Value	ALEVELMAXimum , BLEVEL MINnum
Returns	<NR3>
Example	POW:TRAN:ALEV 5 POW:TRAN:BLEV 0.5
Related Command	POW

[SOURce:]POWer:TRANsient:AWIDth**[SOURce:]POWer:TRANsient:BWIDth**

This command specifies the transient pulse width of the input power.

Group	Source
Syntax	[SOURce:]POWer:TRANsient:AWIDth <NRf+> [SOURce:]POWer:TRANsient:BWIDth <NRf+> [SOURce:]POWer:TRANsient:AWIDth? [MINimum MAXimum DEFault] [SOURce:]POWer:TRANsient:BWIDth? [MINimum MAXimum DEFault]
Arguments	0.0001S to 3600S
Unit	S (seconds)
Default Value	1000S
Returns	<NR3>
Example	POW:TRAN:AWID 0.001 POW:TRAN:BWID 0.02
Related Command	POW

[SOURce:]POWer:HIGH**[SOURce:]POWer:LOW**

This command sets the voltage bounds in CP mode.

Group	Source
Syntax	[SOURce:]POWer:HIGH <NRf+> [SOURce:]POWer:LOW <NRf+> [SOURce:]POWer:HIGH?

	[MINimum MAXimum DEFault]
	[SOURce:]POWer:LOW?
	[MINimum MAXimum DEFault]
Arguments	MINimum through MAX MINimum MAXimum DEFault
Unit	V (volts)
Default Value	MAXimum
Returns	<NR3>
Example	POW:HIGH 5

[SOURce:]POWer:PROTection

This command sets the soft power protection level. If the input power exceeds the soft power protection level for the time specified by POW:PROT:DEL, the input is turned off.

Group	Source
Syntax	[SOURce:]POWer:PROTection[:LEVel] <NRf+> [SOURce:]POWer:PROTection[:LEVel]? [MINimum MAXimum DEFault]
Arguments	0 through MAX MINimum MAXimum DEFault
Unit	W(watts)
Default Value	MAXimum
Returns	<NR3>
Example	POW:PROT 100
Related Command	POW:PROT:DEL

[SOURce:]POWer:PROTection:DELaY

This command specifies the time that the input power can exceed the protection level before the input is turned off.

Group	Source
Syntax	[SOURce:]POWer:PROTection:DELaY <NRf+> [SOURce:]POWer:PROTection:DELaY? [MINimum MAXimum DEFault]
Arguments	0 to 60 seconds MINimum MAXimum DEFault When the parameter is decimal, it will be rounded.
Unit	S(seconds)/ millisecond
Default Value	0
Returns	<NR1>
Example	POW:PROT:DEL 5
Related Command	POW:PROT

[SOURce:]POWer:CONFIg

This command sets the hard power protection level.

Group	Source
Syntax	[SOURce:]POWer:CONFIg[:LEVel] <NRf+> [SOURce:]POWer:CONFIg[:LEVel]? [MINimum MAXimum DEFault]
Arguments	0 through MAX MINimum MAXimum DEFault
Unit	W(watts)
Default Value	MAXimum
Returns	<NR3>
Example	POW:CONFIg 100

**Related
Command**

[POW:PROT](#)

[SOURce:]RESistance:VDRop <NRf>

This command sets CR mode of load and LED cut-off voltage when the LED test function is opened.

Group	Source
Syntax	[SOURce:]RESistance:VDRop <NRf> [SOURce:]RESistance:VDRop? [MINimum MAXimum DEFault]
Arguments	0 through MAX MINimum MAXimum DEFault
Unit	V (volts)
Returns	<NRf>
Example	RESistance:VDRop MINimum

[SOURce:]RESistance:LED[:STATE] <BOOL>

This command enables or disables the LED test items of load CR mode.

Group	Source
Syntax	[SOURce:]RESistance:LED[:STATE] <BOOL> [SOURce:]RESistance:LED[:STATE]?
Arguments	0 1 OFF ON
Returns	0 1
Example	RESistance:LED 1

LIST subsystem

List commands let you program complex sequences of input changes with rapid, precise timing, and synchronized with trigger signals.

Each function for which lists can be generated has a list of values that specify the input at each list step.

[SOURce:]LIST:SLOWrate[:STATE] <BOOL>

This command sets the slowrate of List mode.

Group	Source
Syntax	[SOURce:]LIST:SLOWrate[:STATE] <BOOL> [SOURce:]LIST:SLOWrate[:STATE]?
Arguments	1 ON: Sets the electronic load to low-rate. 0 OFF: Sets the electronic load to high-rate.
Returns	0 1
Example	LIST:SLOWrate 1

[SOURce:]LIST:RANGe

This command sets the range for list mode.

Group	Source
Syntax	[SOURce:]LIST:RANGe <NRf> [SOURce:] LIST:RANGe? [Min max def]
Arguments	MIN through MAX Min max def
Unit	A (amperes)
Example	LIST:RANGe 15
Returns	<NRf>
Related Command	LIST:LEV

[SOURce:]LIST:COUNT

This command sets the number of times that the list is executed before it is completed. The command accepts arguments in the range 1 through 65535.

Group	Source
Syntax	[SOURce:]LIST:COUNT <NRf+> [SOURce:]LIST:COUNT? [MINimum MAXimum]
Arguments	1 to 65535 MINimum MAXimum
Returns	<NR3>
Example	LIST:COUN 3
Related Command	LIST:STEP

[SOURce:]LIST:STEP

This command sets the steps of the list.

Group	Source
Syntax	[SOURce:]LIST:STEP <NRf+> [SOURce:]LIST:STEP? [MINimum MAXimum]
Arguments	2 to 84 MINimum MAXimum
Returns	<NR3>
Example	LIST:STEP 5
Related Command	LIST:LEV

[SOURce:]LIST:LEVel

This command specifies the setting for each list step.

Group	Source
Syntax	[SOURce:]LIST:LEVel <NR1>, <NRf> [SOURce:]LIST:LEVel? <NR1>
Arguments	1 to steps, MINimum to MAXimum
Unit	NONE, Amperes
Returns	<NR3>
Example	LIST:LEV 1, 10 LIST:LEV 2, 15.2
Related Command	LIST:RANG

[SOURce:]LIST:SLEW

This command sets the slew rate for each step. This command programs both positive and negative going slew rates. MAXimum sets the slew to its fastest possible rate. MINimum sets the slew to its slowest rate. LIST:SLEW? returns the number of points programmed.

Group	Source
Syntax	[SOURce:]LIST:SLEW[:BOTH] <NR1>, <NRf> [SOURce:]LIST:SLEW[:BOTH]? <NR1>
Arguments	1 to steps, MINimum to MAXimum
Unit	NONE, A/ms or NONE, A/us
Returns	<NR3>
Example	LIST:SLEW 1, 1.5
Related Command	CURR:SLEW

[SOURce:]LIST:WIDth

This command sets the sequence of list dwell times. Each value represents the time in seconds that the input will remain at the particular list step point before completing the step. Else At the end of the dwell time, the input automatically changes to the next point in the list.

Group	Source
Syntax	[SOURce:]LIST:WIDth <NR1>, <NRf> [SOURce:]LIST:WIDth? <NR1>
Arguments	1 to steps, 20uS to 3600S
Unit	NONE, S(seconds)
Returns	<NR3>
Example	LIST:WID 1, 0.02 LIST:WID 2, 0.5

[SOURce:]LIST:SAV

This command stores the present list file of the electronic load to a specified location in memory. Up to 7 files can be stored. File in saved in locations 1-7 are volatile, the data are nonvolatile, the data will be saved when power is removed.

Group	Source
Syntax	[SOURce:]LIST:SAV <NR1>
Arguments	1 to 7
Example	LIST:SAV 3
Related Command	[SOURce:]LIST:RCL

[SOURce:]LIST:RCL

This command restores a list file that was previously stored in memory with a LIST:SAV command to the specified location.

Group	Source
Syntax	[SOURce:]LIST:RCL <NR1>
Arguments	1 to 7
Example	LIST:RCL 3
Related Command	[SOURce:]LIST:SAV

SENSE subsystem

The sense subsystem is used to configure and control the measurement functions of the electronic load. A function does not have to be selected before you program its various configurations. A function can be selected any time after it has been programmed. Whenever a programmed function is selected, the edit status is estimated.

SENSe:AVERage:COUNT

The command is used to specify the filter count. In general, the filter count is the number of readings that are acquired and stored in the filter buffer for the averaging calculation. The larger the filter count, the more filtering that is performed.

Group	Sense
Syntax	SENSe:AVERage:COUNT <NR1> SENSe:AVERage:COUNT?
Arguments	2-16
Returns	<NR1>
Example	SENSe:AVERage:COUNT 3

SENSe:TIME:VOLTage1**SENSe:TIME:VOLTage2**

This command sets the voltage that the load will regulate when operating in constant current mode.

Group	Sense
Syntax	<pre>SENSe:TIME:VOLTage1 <NRf+> SENSe:TIME:VOLTage2 <NRf+> [SOURce:]SENSe:TIME:VOLTage1? [MINimum MAXimum DEFault] [SOURce:]SENSe:TIME:VOLTage2? [MINimum MAXimum DEFault]</pre>
Arguments	0 through MAX MINimum MAXimum DEFault
Unit	V (volts)
Default Value	MINimum / MAXimum
Returns	<NR3>
Example	<pre>SENSe:TIME:VOLTage1 15 SENSe:TIME:VOLTage2 10</pre>
Related Command	FETC:TIME?

SYSTem:SENSe[:STATe] <BOOL>

This command enables or disables remote sense measurement functions.

Group	Sense
Syntax	<pre>SYSTem:SENSe[:STATe] <BOOL> SYSTem:SENSe[:STATe]?</pre>
Arguments	0 1 OFF ON

Returns	0 1
Example	SYSTem:SENSE 1

Calibration subsystem

Calibration commands let you:

- Enable and disable the calibration mode.
- Calibrate the input functions, current monitor offset and gain, and store new calibration constants in nonvolatile memory.

CALibrate:SECure[:STATe]

This command enables and disables calibration mode. The calibration mode must be enabled before the load will accept any other calibration commands. The first parameter specifies the enabled or disabled state. The second parameter is the password. It is required if the calibration mode is being enabled and the existing password is not 0. If the password is not entered or is incorrect, an error is generated and the calibration mode remains disabled. The query statement returns only the state, not the password. Whenever the calibration state is changed from enabled to disabled, any new calibration constants are lost unless they have been stored with CALibrate:SAVE.

Group	Calibration
Syntax	CALibrate:SECure[:STATe] <bool> [,<SRD>] CALibrate:SECure[:STATe]?
Arguments	0 1 OFF ON [,<password>]
Default Value	ON
Returns	0 1
Example	CAL:SEC 0, N3301A CAL:SEC ON
Related Command	CAL:SAVE CAL:INIT

CALibrate:INITial

This command can only be used in calibration mode. It restores factory calibration constants from nonvolatile memory.

Group	Calibration
Syntax	CALibrate:INITial
Arguments	None
Example	CAL:INIT
Related Command	CAL:SEC

CALibrate:SAVE

This command can only be used in calibration mode. It saves any new calibration constants (after a current or voltage calibration procedure has been completed) in nonvolatile memory.

Group	Calibration
Syntax	CALibrate:SAVE
Arguments	None
Example	CAL:SAVE
Related Command	CAL:SEC CAL:INIT

CALibrate:CURRent:POINT

This command can only be used in calibration mode. It is used to set the calibration points of constant current mode. P1, P2 is used in low current range, P3, P4 is used in high current range. It can use calibrate current source and current meter.

Group	Calibration
Syntax	CALibrate:CURRent:POINT <point>
Arguments	P1 P2 P3 P4
Example	CAL:CURR:POIN P2
Related Command	CAL:SEC CAL:SAV

CALibrate:CURRent[:LEVel]

This command is only used in calibration mode. It enters a calibration current value that you obtain by reading an external meter. You must first select a calibration level (with CALibrate:CURRent:POINT) for the value being entered. These constants are not stored in nonvolatile memory until they are saved with CALibrate:SAVE.

Group	Calibration
Syntax	CALibrate:CURRent[:LEVel] <NRf>
Arguments	<external reading>
Unit	A (amperes)
Example	CAL:CURR 3.2223
Related Command	CAL:SEC CAL:SAV

CALibrate:CURRent:METER:POINT

This command can only be used in calibration mode. It is used to set the calibration points of constant current mode. P1, P2 is used in low current range, P3, P4 is used in high current range. It can only use calibrate current meter.

Group	Calibration
Syntax	CALibrate:CURRent:METER:POINT <point>

Arguments	P1 P2 P3 P4
Example	CAL:CURR:METER:POIN P2
Related Command	CAL:SEC CAL:SAV

CALibrate:CURRent:METER[:LEVel]

This command is only used in calibration mode. It enters a calibration current value that you obtain by reading an external meter. You must first select a calibration level (with CAL:CURR:METE:POIN) for the value being entered. These constants are not stored in nonvolatile memory until they are saved with CALibrate:SAVE.

Group	Calibration
Syntax	CALibrate:CURRent:METER[:LEVel] <NRf>
Arguments	<external reading>
Unit	A (amperes)
Example	CAL:CURR 3.2223
Related Command	CAL:SEC CAL:SAV

CALibrate:VOLTage:POINT

This command can only be used in calibration mode. It is used to set the calibration points of constant voltage mode. P1, P2 is used in low voltage meter range, P3, P4 is used in high voltage meter range. It can use calibrate voltage source and voltage meter.

Group	Calibration
Syntax	CALibrate:VOLTage:POINT <point>
Arguments	P1 P2 P3 P4

Example	CAL:VOLT:POIN P2
Related Command	CAL:SEC CAL:SAV

CALibrate:VOLTage[:LEVel]

This command is only used in calibration mode. It enters a calibration voltage value that you obtain by reading an external meter. You must first select a calibration level (with CALibrate:VOLTage:POINT) for the value being entered. These constants are not stored in nonvolatile memory until they are saved with CALibrate:SAVE.

Group	Calibration
Syntax	CALibrate:VOLTage[:LEVel] <NRf>
Arguments	<external reading>
Unit	V (volts)
Example	CAL:VOLT 3.2223
Related Command	CAL:SEC CAL:SAV

CALibrate:VOLTage:METER:POINT

This command can only be used in calibration mode. It is used to set the calibration points of constant voltage mode. P1, P2 is used in low voltage range, P3, P4 is used in high voltage range. It can only use calibrate voltage meter.

Group	Calibration
Syntax	CALibrate:VOLTage:METER:POINT <point>
Arguments	P1 P2 P3 P4
Example	CAL:VOLT:METER:POIN P2

**Related
Command**

[CAL:SEC](#) [CAL:SAV](#)

CALibrate:VOLTage:METER[:LEVel]

This command is only used in calibration mode. It enters a calibration voltage value that you obtain by reading an external meter. You must first select a calibration level (with CALibrate:VOLTage:METER:POINt) for the value being entered. These constants are not stored in nonvolatile memory until they are saved with CALibrate:SAVE.

Group

Calibration

Syntax

CALibrate:VOLTage:METER[:LEVel] <NRf>

Arguments

<external reading>

Unit

V (volts)

Example

CAL:VOLT:METE 4

**Related
Command**

[CAL:SAV](#)

Error Information

Error Number List

This appendix describes the error numbers and descriptions that are returned by the electronic load. Error numbers are returned on the front panel in two ways:

- Error number with messages after the SYSTem:ERRor? query
- Error number with an NR1 and a string after the SYSTem:ERRor? query

Errors from 100 to 199 (Set bit #5 of standard event status register) are explained as follows.

- (0) No error
- (101) DESIGN ERROR: Too many numeric suffices in Command Spec
- (110) No Input Command to parse
- (114) Numeric suffix is invalid value
- (116) Invalid value in numeric or channel list, e.g. out of range
- (117) Invalid number of dimensions in a channel list
- (120) Parameter overflowed
- (130) Wrong units for parameter
- (140) Wrong type of parameter(s)
- (150) Wrong number of parameters
- (160) Unmatched quotation mark (single/double) in parameters
- (165) Unmatched bracket
- (170) Command keywords were not recognized
- (180) No entry in list to retrieve (number list or channel list)
- (190) Too many dimensions in entry to be returned in parameters
- (191) Too many char

- (-150) String data error
- (-151) Invalid string data [e.g., END received before close quote]
- (-158) String data not allowed
- (-160) Block data error
- (-161) Invalid block data [e.g., END received before length satisfied]
- (-168) Block data not allowed
- (-170) Expression error
- (-171) Invalid expression
- (-178) Expression data not allowed

Execute errors from -200 to -299 (Set bit #4 of standard event register) are explained as follows.

- (-200) Execution error [generic]
- (-221) Settings conflict [check current device state]
- (-222) Data out of range [e.g., too large for this device]
- (-223) Too much data [out of memory; block, string, or expression too long]
- (-224) Illegal parameter value [device-specific]
- (-225) Out of memory

(-230) Data Corrupt or Stale

(-270) Macro error

(-272) Macro execution error

(-273) Illegal macro label

(-276) Macro recursion error

(-277) Macro redefinition not allowe

System errors from -300 to -399 (Set bit 3 of standard event resgister) are explained as follows.

(-310) System error [generic]

(-350) Too many errors [errors beyond 9 lost due to queue overflow]

Query errors from -400 to -499 (Set Bit2 of standard event resgister) are explained as follows.

(-499) (sets Standard Event Status Register bit #2)

(-400) Query error [generic]

(-410) Query INTERRUPTED [query followed by DAB or GET before response complete]

(-420) Query UNTERMINATED [addressed to talk, incomplete programming message received]

(-430) Query DEADLOCKED [too many queries in command string]

(-440) Query UNTERMINATED [after indefinite response]

Checking errors from 0 to 99 (Set bit 3 of standard event resgister) are explained as follows.

0 No error

1 Module Initialization Lost

2 Mainframe Initialization Lost

3 Module Calibration Lost

4 Non-volatile RAM STATE section checksum failed

5 Non-volatile RAM RST section checksum failed

10 RAM selftest

11 CVDAC selftest 1

12 CVDAC selftest 2

13 CCDAC selftest 1

14 CCDAC selftest 2

15 CRDAC selftest 1

16 CRDAC selftest 2

20 Input Down

40 Flash write failed

41 Flash erase failed

80 Digital I/O selftest error

Equipment related errors from 100 to 32767 (Set bit 3 of standard event resgister) are explained as follows.

213 RS-232 buffer overrun error

216 RS-232 receiver framing error

217 RS-232 receiver parity error

218 RS-232 receiver overrun error

220 Front panel uart overrun

221 Front panel uart framing

222 Front panel uart parity

223 Front panel buffer overrun

224 Front panel timeout

225 Front Crc Check error

226 Front Cmd Error

401 CAL switch prevents calibration

402 CAL password is incorrect

403	CAL not enabled
404	Computed readback cal constants are incorrect
405	Computed programming cal constants are incorrect
406	Incorrect sequence of calibration commands
407	CV or CC status is incorrect for this command
408	Output mode switch must be in NORMAL position
600	Lists inconsistent [lists have different list lengths]
601	Too many sweep points
602	Command only applies to RS-232 interface
603	FETCH of data that was not acquired
604	Measurement overrange
605	Command not allowed while list initiated
610	Corrupt update data
611	Not Updating

Appendix

Wire specifications

For maximum current of AWG copper wire, refer to table blow.

AWG	10	12	14	16	18	20	22	24	26	28
Maximum current (A)	40	25	20	13	10	7	5	3.5	2.5	1.7

Note: in accordance with AWG (American Wire Gage), it means X wire (marked on the wire). The table above lists current carrying capacity of single wire at working temperature of 30 °C. For reference only.

Specifications are subject to change without notice.
All Keithley trademarks and trade names are the property of Keithley Instruments.
All other trademarks and trade names are the property of their respective companies.

Keithley Instruments
Corporate Headquarters • 28775 Aurora Road • Cleveland, Ohio 44139 • 440-248-0400 • Fax: 440-248-6168 • 1-800-935-5595 • www.tek.com/keithley



A Greater Measure of Confidence