

AFG1022
Arbitrary/Function Generator
Quick Start User Manual



AFG1022
Arbitrary/Function Generator
Quick Start User Manual

Copyright © Tektronix. All rights reserved. Licensed software products are owned by Tektronix or its subsidiaries or suppliers, and are protected by national copyright laws and international treaty provisions.

Tektronix products are covered by U.S. and foreign patents, issued and pending. Information in this publication supersedes that in all previously published material. Specifications and price change privileges reserved.

TEKTRONIX and TEK are registered trademarks of Tektronix, Inc.

Contacting Tektronix

Tektronix, Inc.
14150 SW Karl Braun Drive
P.O. Box 500
Beaverton, OR 97077
USA

For product information, sales, service, and technical support:

- In North America, call 1-800-833-9200.
- Worldwide, visit www.tektronix.com to find contacts in your area.

Warranty

Tektronix warrants that the product will be free from defects in materials and workmanship for a period of three (3) years from the date of original purchase from an authorized Tektronix distributor. If the product proves defective during this warranty period, Tektronix, at its option, either will repair the defective product without charge for parts and labor, or will provide a replacement in exchange for the defective product. Parts, modules and replacement products used by Tektronix for warranty work may be new or reconditioned to like new performance. All replaced parts, modules and products become the property of Tektronix.

In order to obtain service under this warranty, Customer must notify Tektronix of the defect before the expiration of the warranty period and make suitable arrangements for the performance of service. Customer shall be responsible for packaging and shipping the defective product to the service center designated by Tektronix, shipping charges prepaid, and with a copy of customer proof of purchase. Tektronix shall pay for the return of the product to Customer if the shipment is to a location within the country in which the Tektronix service center is located. Customer shall be responsible for paying all shipping charges, duties, taxes, and any other charges for products returned to any other locations.

This warranty shall not apply to any defect, failure or damage caused by improper use or improper or inadequate maintenance and care. Tektronix shall not be obligated to furnish service under this warranty a) to repair damage resulting from attempts by personnel other than Tektronix representatives to install, repair or service the product; b) to repair damage resulting from improper use or connection to incompatible equipment; c) to repair any damage or malfunction caused by the use of non-Tektronix supplies; or d) to service a product that has been modified or integrated with other products when the effect of such modification or integration increases the time or difficulty of servicing the product.

THIS WARRANTY IS GIVEN BY TEKTRONIX WITH RESPECT TO THE PRODUCT IN LIEU OF ANY OTHER WARRANTIES, EXPRESS OR IMPLIED. TEKTRONIX AND ITS VENDORS DISCLAIM ANY IMPLIED WARRANTIES OF MERCHANTABILITY OR FITNESS FOR A PARTICULAR PURPOSE. TEKTRONIX' RESPONSIBILITY TO REPAIR OR REPLACE DEFECTIVE PRODUCTS IS THE SOLE AND EXCLUSIVE REMEDY PROVIDED TO THE CUSTOMER FOR BREACH OF THIS WARRANTY. TEKTRONIX AND ITS VENDORS WILL NOT BE LIABLE FOR ANY INDIRECT, SPECIAL, INCIDENTAL, OR CONSEQUENTIAL DAMAGES IRRESPECTIVE OF WHETHER TEKTRONIX OR THE VENDOR HAS ADVANCE NOTICE OF THE POSSIBILITY OF SUCH DAMAGES.

[W16 – 15AUG04]

Table of contents

Preface	iii
Where to find more information.....	iii
Conventions used in this manual.....	iii
Service offerings	iv
Getting started	1
General features.....	1
Before installation	1
Standard accessories.....	2
Operating requirements.....	3
Power the instrument on and off	4
Change instrument settings at power-on	5
Select a local language	6
Protect your instrument from misuse	7
General care	8
Update your instrument firmware	9
Equivalent output circuits.....	12
Instrument front panel, interface, and rear panel.....	13
Front panel overview.....	13
Parts of the screen interface	14
Default setup	15
Select waveform.....	17
Select run mode.....	19
Adjust waveform parameters	20
Channel Select.....	21
Channel output On/Off.....	21
Display Both Channels	21
Rear panel.....	22
Operating basics.....	23
Quick tutorial: How to select a waveform and adjust parameters.....	23
Quick tutorial: How to generate a sine waveform.....	24
Quick tutorial: Instrument help system	25
Operating Basics	26
Generate a pulse waveform.....	26
Generate a built-in waveform.....	27
Create/Save a user-defined waveform.....	29
Recall a user-defined waveform.....	31
Generate noise	32
Generate DC.....	32

Table of contents







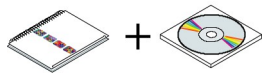

Sweep a waveform	33
Modulate a waveform.....	36
Generate a burst waveform.....	41
Copy channel setting	44
USB memory.....	45
Utility menu.....	46
Appendix A: Line Fuse Replacement	49
Index	50

Preface

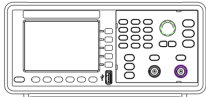
This manual describes the installation and operation of the Tektronix AFG1022 Arbitrary/Function Generator along with basic operations and concepts.

Where to find more information

The following table lists related documentation available for your instrument. The documentation is available on the Product Documentation CD and on the Tektronix Web site (www.tektronix.com/manuals).

Item	Purpose	Location
Important safety and compliance instructions	Compliance and safety instructions	 +  +  WWW.Tektronix.com
Built-in Help	UI Help and Operation	
Quick Start User Manual	Unpacking, Installation, Tutorials, Operation, and Overviews	 +  WWW.Tektronix.com
Programmer Manual	Programming Information	 +  WWW.Tektronix.com
Technical Reference	Specifications and performance verification procedures	 +  WWW.Tektronix.com

Conventions used in this manual

The following icons are used throughout this manual.

Front panel power



Connect power

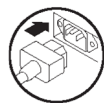

USB

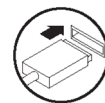

The soft keypad along the right side of the display are called bezel buttons in this manual. In other documents, they may also be called option buttons or side-menu buttons.

Service offerings

Tektronix provides service to cover repair under warranty and other services that are designed to meet your specific service needs.

Tektronix warrants this product as describe in the warranty statement at the front of this manual. Tektronix technicians provide warranty service at most Tektronix service locations worldwide.

Please contact your local Tektronix representative for more information on any repair or adjustment service.

Getting started

General features

The AFG1022 Arbitrary/Function Generator offers the functionality of three generators in one, and a frequency counter:

- 25 MHz Function Generator
- 12.5 MHz Pulse Generator
- 14-bit Arbitrary Waveform Generator
- 200 MHz Frequency Counter

The following table describes some of the general features of your instrument.

Feature	Description
Channel	2
Sine	25 MHz
Pulse	12.5 MHz
Arbitrary waveform	2 to 8,192 points, 14-bit
Sampling Rate	125 MS/s
Amplitude	High Z 2 mV _{p-p} - 20 V _{p-p} 50 Ω 1 mV _{p-p} - 10 V _{p-p}
Display	Color TFT LCD
Interface	USB
Help system	Instrument help available in multiple languages

Before installation

Inspect the instrument carton for external damage. If the carton is damaged, notify the carrier.

Remove the instrument from its package and check that it has not been damaged in transit. Verify that the carton contains the instrument and its standard accessories.

Standard accessories

Unpack the instrument and check that you received all items listed as Standard Accessories. Check the Tektronix Web site (www.tektronix.com) for the most current information.

Standard accessories

Description	Tektronix part number
AFG1022 Arbitrary/Function Generator Safety and Compliance Instructions	071-3419-xx
AFG1022 Documentation CD containing the following PDF documents:	063-4558-xx
AFG1022 Arbitrary/Function Generators Quick Start User Manual	
English	077-1097-xx
Simplified Chinese	077-1098-xx
AFG1022 Arbitrary/Function Generators Programmer Manual	077-1096-xx
AFG1022 Arbitrary/Function Generators Specifications and Performance Verification Manual	077-1101-xx
Packing list	
Power cord (220 V, 50 Hz, China)	161-0390-xx
Certificate of calibration	001-1657-xx
USB cable x 1	174-6604-xx
BNC cable x 2	161-0389-xx

Operating requirements

The following information and figure describe temperature, clearance, and power supply operating requirements of the instrument.

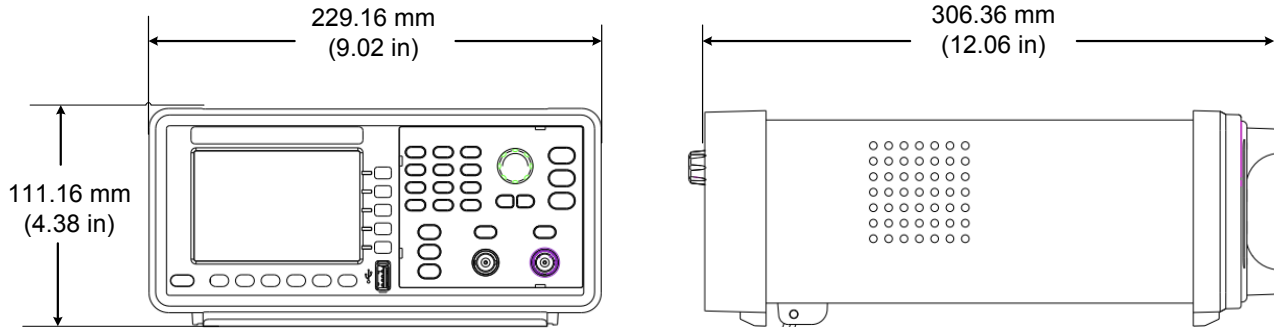

Figure 1: Instrument dimensions

Environmental requirements

Clearance. When placing the instrument on a cart or bench, observing the following clearance requirements:

- Sides: 50 mm (2 in)
- Rear: 50 mm (2 in)

Temperature. Before operating the instrument, ensure the ambient temperature is between 0 °C to +40 °C (+32 °F to +104 °F).



CAUTION. To ensure proper cooling, keep both sides of the instrument clear of obstructions.

Power supply requirements

Source voltage and frequency. 220 - 240 VAC, 100 - 120 VAC, 50/60 Hz, CAT II.

Power Consumption. Less than 28 W



WARNING. To reduce the risk of fire and shock, ensure that the mains supply voltage fluctuations do not exceed 10% of the operating voltage range.

Power the instrument on and off

The following procedures show you how to apply power to the instrument and turn it on and off.

Power on To turn apply power to the instrument and turn it on, do the following:

1. Switch the line selector to the correct position.

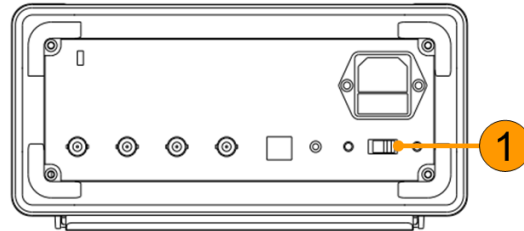

2. Peel off the label on the power receptacle and if needed, replace the fuse according to the line setting (refer to *Appendix A* for the steps of fuse replacement) before inserting the AC power cord. Insert the AC power cord into the power receptacle on the rear panel and the other end into a properly grounded power outlet.

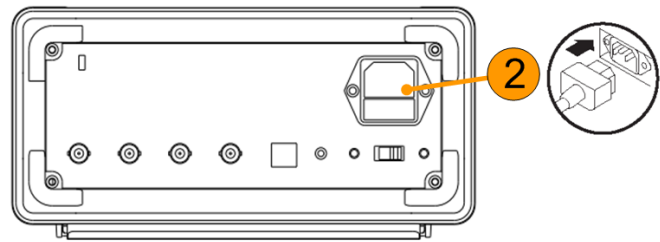

3. Push the front-panel power button to power on the instrument.

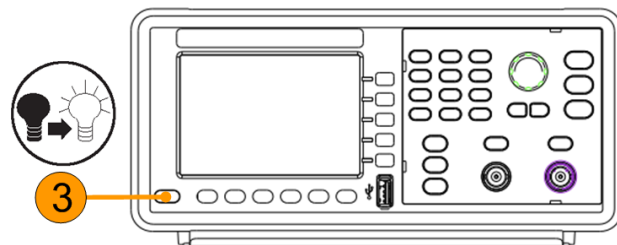

Power off To turn the instrument off, do the following:

1. Push the front-panel power button to power off the instrument.

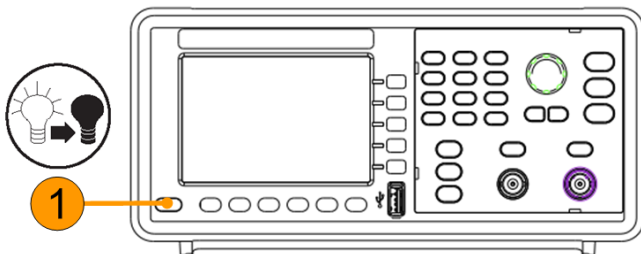

Change instrument settings at power-on

The default settings are restored when you power on the instrument. You can change the power-on settings to the last powered-off settings from the Utility menu using the following procedure.

1. Push the front-panel **Utility** button.
2. Press **System**.

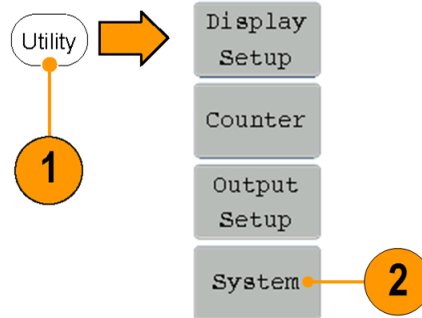

3. Press **Power On** to select from the following the power on settings.

- **Default** restores the default settings when the instrument is powered on.
- **Last** restores the same settings as when the instrument was last powered off.

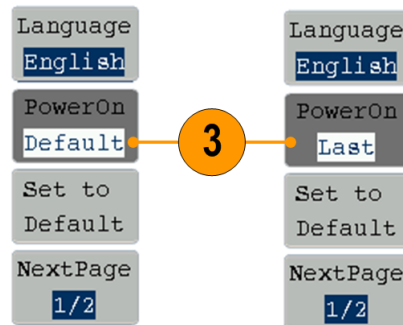

Select a local language

When you power on the instrument for the first time, English is selected by default. After you select a desired language, all the bezel menus, pop-up messages, and built-in help are displayed in the specified language.

1. Push the front-panel **Utility** button.
2. Press **System**.

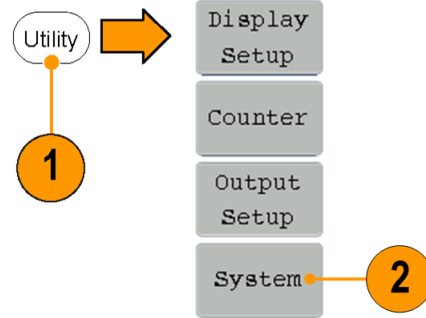

3. Press **Language** to select the desired language.
You can select from English, and Simplified Chinese.

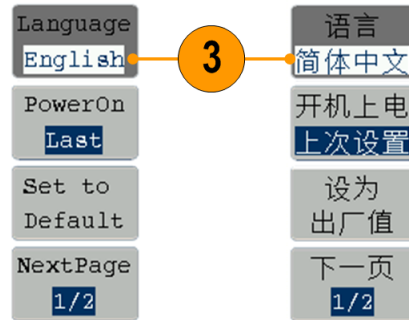

Protect your instrument from misuse

Check input and output connectors

When connecting a cable, be sure to distinguish the input connector from the output connectors to avoid making wrong connection.

1. Locate the channel output on the front panel. Out1 means CH1 output and Out2 means CH2 output.
2. Locate the Ref Clk Out on the rear panel.

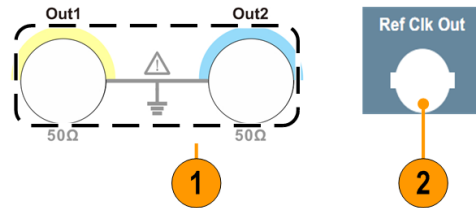

3. Locate the Ref Clk/Counter In, Ext Trig/Burst/Fsk In and Ext Mod In connectors on the rear panel.

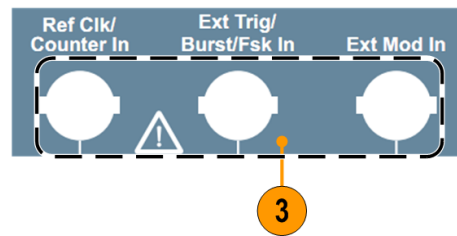

CAUTION. Do not short output pins or apply external voltages to Output connectors. The instrument might be damaged.



CAUTION. Do not apply excessive inputs over +5 V to Trigger Input connector. The instrument might be damaged.

General care

Protect the instrument from adverse weather conditions. The instrument is not waterproof. Do not store or leave the instrument where the display will be exposed to direct sunlight for long periods of time.



CAUTION. *To avoid damage to the instrument, do not expose it to sprays, liquids, or solvents.*

Preventive maintenance

Preventive maintenance mainly consists of periodic cleaning. Periodic cleaning reduces instrument breakdown and increases reliability. Clean the instrument as needed, based on the operating environment. Dirty conditions might require more frequent cleaning than computer room conditions.

Clean the flat panel display surface by gently rubbing the display with a cleanroom wipe. If the display is very dirty, moisten the wipe with distilled water or a 75% isopropyl alcohol solution and gently rub the digital surface. Avoid excess force or you might damage the display surface.

Clean the exterior surfaces with a dry, lint-free cloth or a soft bristle brush. If dirt remains, use a cloth dampened with a 75% isopropyl alcohol solution. A swab is useful for cleaning in narrow spaces around the controls and connectors. Do not use abrasive compounds on any part of the instrument.

To avoid damaging the instrument, follow these precautions:

- Avoid getting moisture inside the instrument during external cleaning and use only enough to dampen the cloth or swab.
- Do not wash the front-panel power switch. Cover the switch while washing the instrument.
- Use only deionized water when cleaning. Use a 75% isopropyl alcohol solution as a cleanser and rinse with deionized water.
- Do not use chemical cleaning agents; they can damage the instrument. Avoid chemicals that contain benzene, toluene, xylene, acetone, or similar solvents.

Update your instrument firmware

You can use the front-panel USB connector to update your instrument firmware using a USB memory device.



CAUTION. Updating your instrument firmware is a sensitive operation which might damage your instrument if you do not follow all instructions carefully. To prevent damage to the instrument, do not remove the USB memory device or power off the instrument during the update process.

NOTE: The screen images of the following procedure are provided as an example. The actual screen display might be different depending on your instrument configuration.

1. Push the front-panel **Utility** button to display the Utility menu and view the currently installed firmware version on the display screen.



2. From a PC, visit www.tektronix.com and check if Tektronix offers a newer firmware version. Download and unzip the compressed zip file with the most current firmware to a USB memory device.



3. Insert the USB memory device into the front-panel USB connector on your instrument.

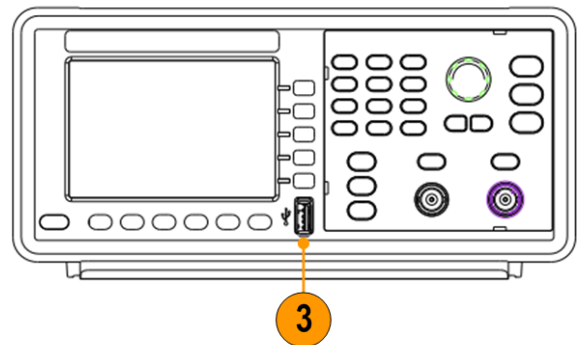

4. Press **System**.
5. Press **NextPage**.
6. Press **Update firmware** to enter file system.

NOTE: If the USB memory device is not inserted, the Update firmware is disabled.

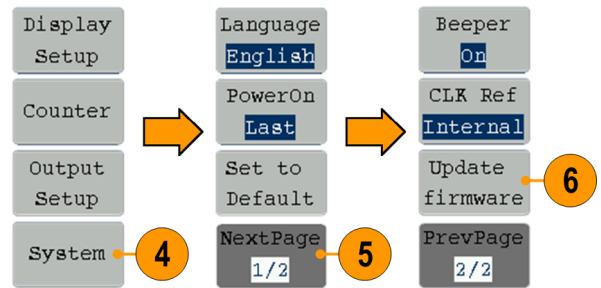

7. Use the general purpose knob to select USBDEVICE, and then press **Enter** to enter USBDEVICE to browse files in the USB memory.

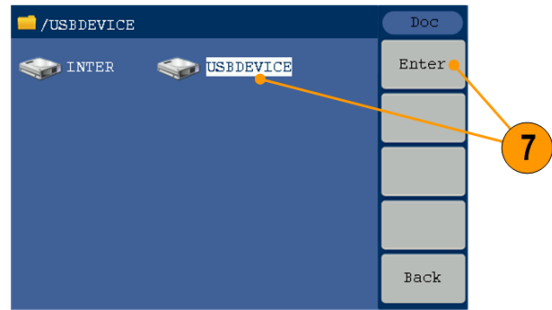

8. Select the downloaded firmware file by rotating the general purpose knob. Then press **Execute** to update firmware.

NOTE: The firmware file name is as follows:
tekafgtb-Vx.x.x.tfb.



9. The instrument displays a message telling you not to remove the USB device or power off the instrument until the update process is complete. The progress bar of the screen indicates the update process is in progress.

NOTE: A firmware update usually takes approximately under a minute. Do not remove the USB memory during the update process.

NOTE: If you accidentally removed the USB memory during the update process, do not power off the instrument. Repeat the installation process from step 3.

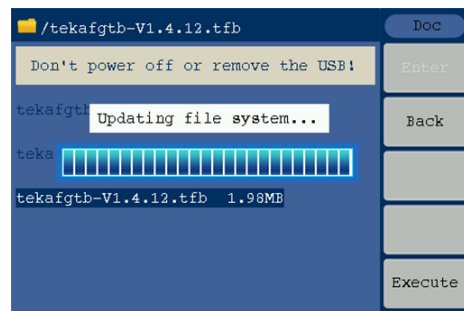
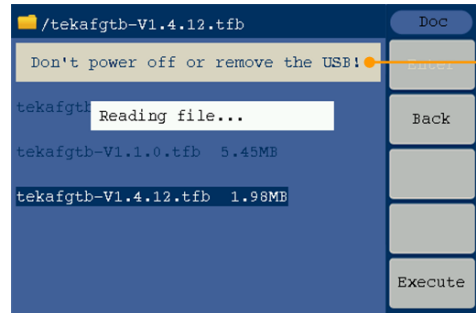

10. Wait until the instrument displays a message saying that the operation is complete.

NOTE: If the operation complete message is not displayed, do not power off the instrument. Repeat the installation process from step 2 using a different type of USB memory device.

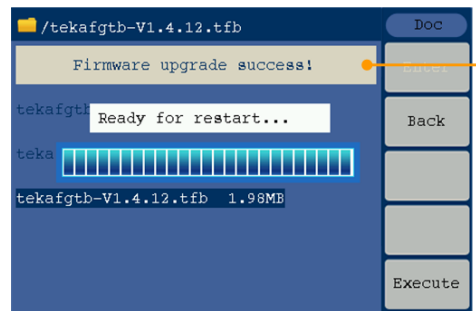

11. Remove the USB memory device from the front-panel USB connector.

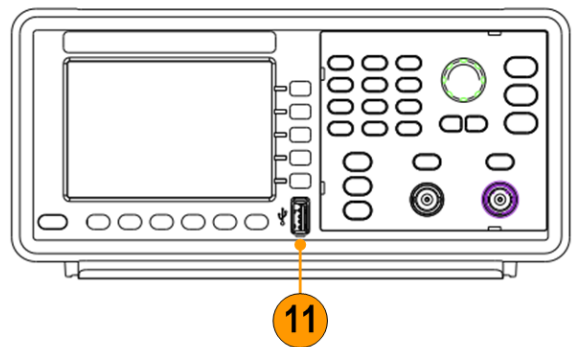

12. Push the front-panel **Utility** button to display the Utility menu. Confirm that the firmware has been updated.



Equivalent output circuits

The following illustrations show the equivalent output circuits:

Legend for the following images:



Output signals do not exceed ± 10 V when the $>50 \Omega$ load impedance is used.

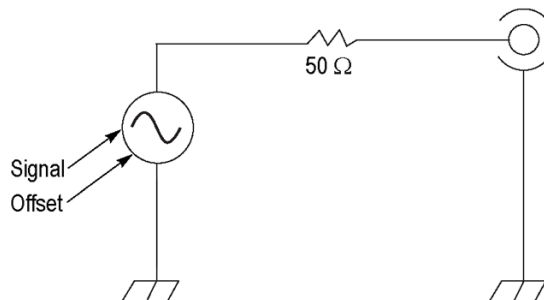

A change to the load impedance (L) will affect the output window (maximum and minimum levels) for a sine waveform as follows.

- **L = 50Ω** : -5 V to +5 V ($10 V_{p-p}$)
- **L = High Z**: -10 V to +10 V ($20 V_{p-p}$)

Instrument front panel, interface, and rear panel

Front panel overview

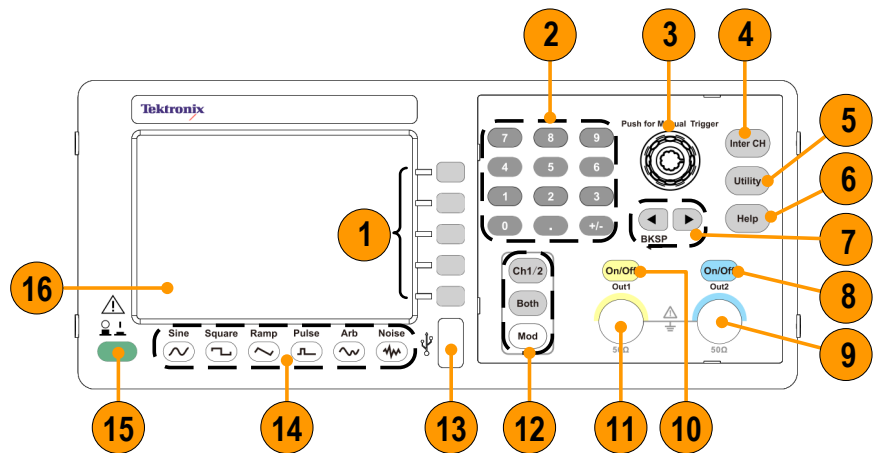

The front panel is divided into easy-to-use functional areas. This section provides you with a quick overview of the front panel controls and the screen interface.

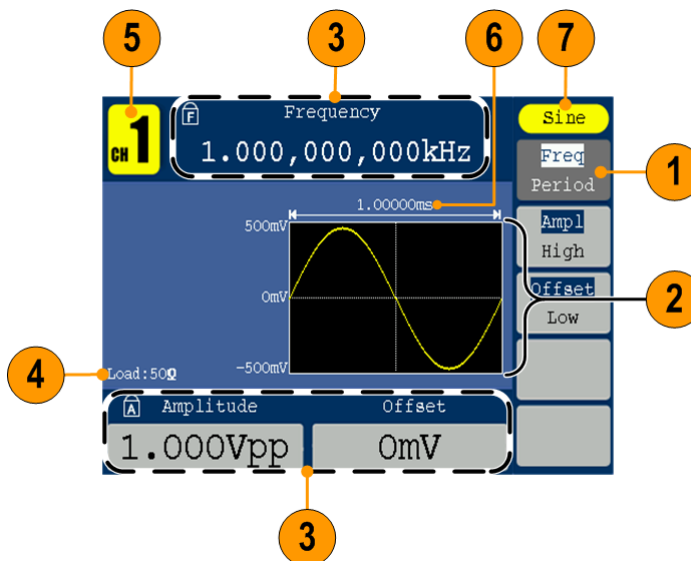

Item	Description
1	Bezel buttons
2	Numeric keypad, including numeric, point, plus/minus sign
3	General purpose knob
4	Channel copy button
5	Utility button
6	Help button
7	Arrow buttons allow you to select a specific number on the display screen when you are changing amplitude, phase, frequency, or other such values
8	Channel 2 On/Off button
9	Channel 2 output connector
10	Channel 1 On/Off button
11	Channel 1 output connector
12	Ch1/2: Switch channel on the screen Both: Show the parameters of the two channels at the same time Mod: Run modes, including continuous, modulation, sweep and burst, which just apply to Channel 1.
13	USB connector
14	Function buttons
15	Power button
16	Screen

Parts of the screen interface



Item	Description
1	Bezel menu: When you push a front panel button, the instrument displays the corresponding menu on the right side of the screen. The menu shows the options that are available when you press the unlabeled bezel buttons directly to the right of the screen. (Some documentation may also refer to the bezel buttons as option buttons, side-menu buttons, or soft keypad.)
2	Graph / waveform display area: This part of the main display area shows the signal as a graph or waveform.
3	Parameter display area: This part of the main display area shows active parameters.  indicates Frequency Lock is on;  indicates Amplitude Lock is on.
4	Message display area: This part displays the load value
5	Message display area: This part displays the current channel.
6	Parameter display area: This part displays the period.
7	Message display area: This part displays the type of the current signal or the current mode.

Default setup

When you want to restore the instrument settings to the default values, use the front-panel Utility button as follows:

1. Push the front-panel **Utility** button.
2. Press **System**.

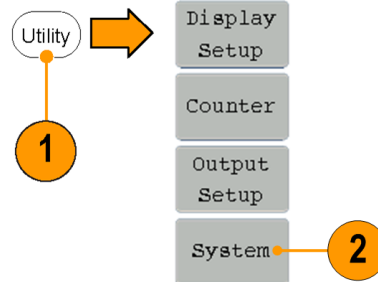

3. Press **Set to Default**.

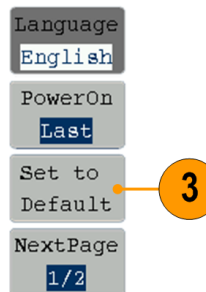

4. Select one of the following:

- **Select** to recall the default settings; the instrument will display a 1 kHz frequency, 1 V_{p-p} amplitude sine waveform as the default setup.
- **Cancel** to cancel the recall and return to the previous menu.

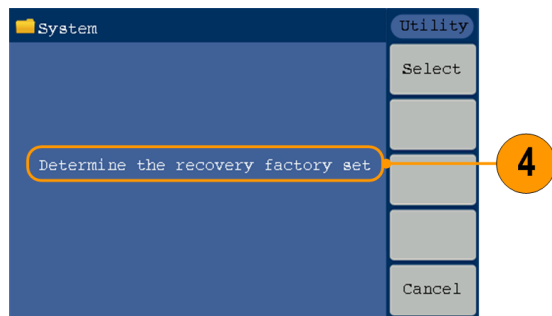

Default settings

Default settings

Menu/System	Default setting
Output configuration (available in ch1 and ch2)	
Function	Sine
Frequency	1.000 000 000 kHz
Amplitude	1.000 V _{p-p}
Offset	0 mV
Symmetry (ramp)	50.00%
Duty (Pulse)	50.00%
Output Units	V _{p-p}
Output impedance	50 Ω
Sweep (only available in ch1)	
Sweep start frequency	100.000 Hz
Sweep stop frequency	1.000 kHz
Sweep time	1 s
Sweep type	Linear
Sweep source	Internal
Modulation (only available in ch1)	
Modulation waveform	100.000 Hz, Sine (except FSK)
AM depth	100%
FM deviation	100.000 Hz
PM deviation	0°
FSK hop frequency	100.000 Hz
FSK rate	100.000 Hz
Burst (only available in ch1)	
Burst mode	N Cycle
Burst count	1
Trigger source	Internal
Trigger interval	1.000 ms
System related settings (available in ch1 and ch2)	
Clock reference	Internal

The Default bezel button in the Utility menu does not reset the Language option.

Select waveform

The instrument can provide five standard waveforms (Sine, Square, Ramp, Pulse and Noise). The instrument can also provide user-defined arbitrary waveforms. You can create, edit, and save your custom waveforms.

You can also create modulated waveforms using the **Mod** panel button and then **Mod** bezel button menus. The following table shows the combination of modulation type and the shape of the output waveform. Modulation, sweeping, and burst modes are only available in Ch1. Continuous mode is available in both CH1 and CH2.

	Sine, Square, Ramp	Pulse	Noise	Arb
AM	√			√
FM	√			√
PM	√			√
FSK	√			√
Sweep	√			
Burst	√	√		√
Continuous	√	√	√	√

Other available waveforms

The following are examples of some other waveform types available in the Built-in Waveform menu.

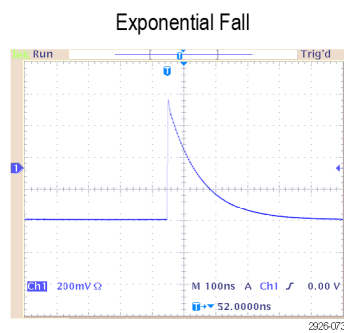
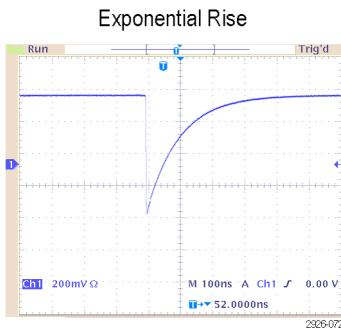
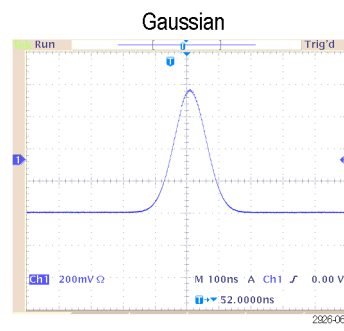
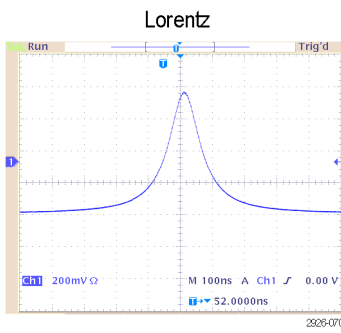
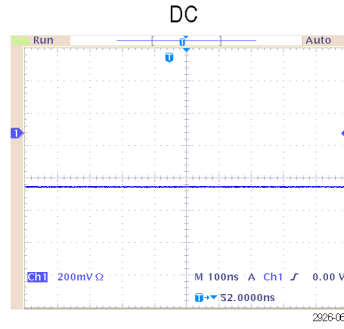
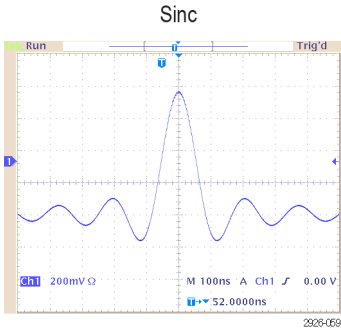

Select run mode

Push the **Mod** panel button, and then press one of the four Run Mode bezel buttons to select the instrument signal output method. Modulation, sweeping, and burst modes are only available in Ch1.

1. The default Run Mode is Continuous.

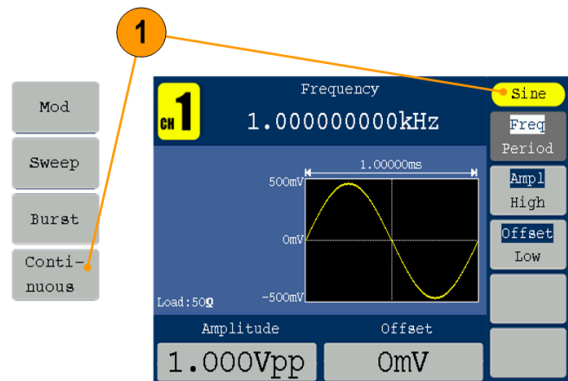

2. To select a modulated waveform, press **Mod**.

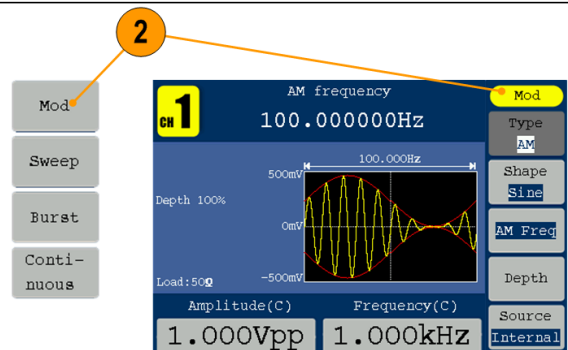

3. To select a sweep waveform, press **Sweep**.
See page 33 for details on sweeping waveforms.

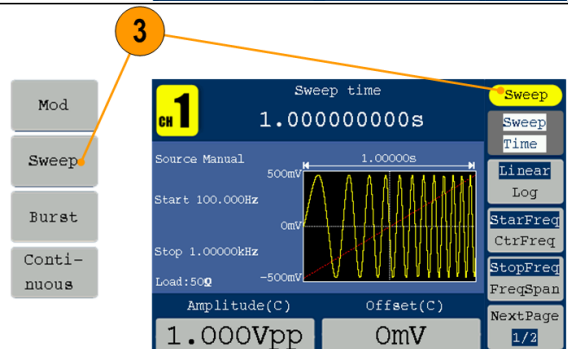

4. To select a burst waveform, press **Burst**.

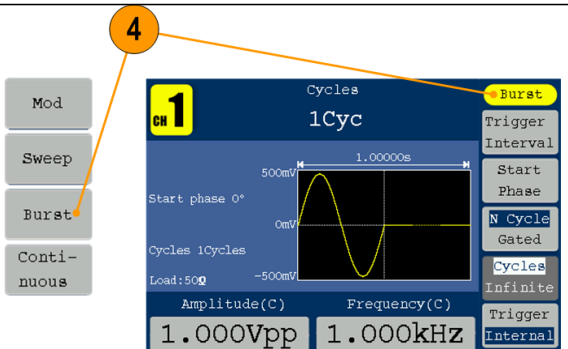

Adjust waveform parameters

When you turn on your instrument, the default output signal is a 1 kHz sine waveform with an amplitude of 1 V_{p-p}. In the following example, you can change the frequency and amplitude of the original output signal.

- To change frequency, press **Freq/Period**. Press it again to choose **Period**. The parameter which is chosen will be lighted with white background. Use the general purpose knob to set frequency value directly, and use the \leftarrow/\rightarrow direction button to move the cursor.

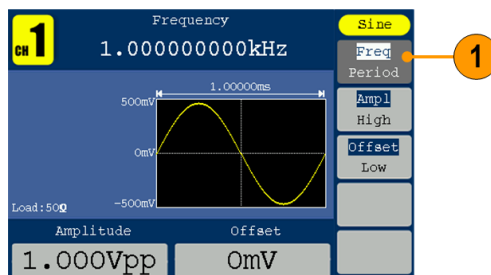

- Or push the numeric panel button, and an input box will pop up. Input frequency value and choose proper unit. Use \leftarrow BK/SP panel button to delete character if input error occurs.

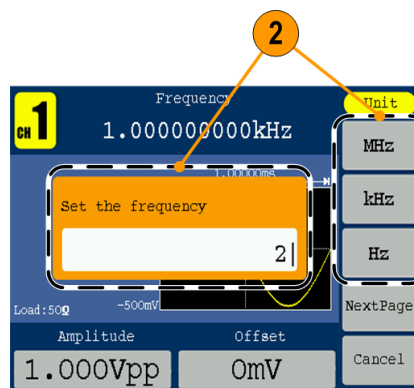

- Press **NextPage** to go to the next page for other unit options.
- Press **Cancel** to cancel the operation.

NOTE: You can change the *Period, Ampl, High, Offset, and Low values in the same way.*

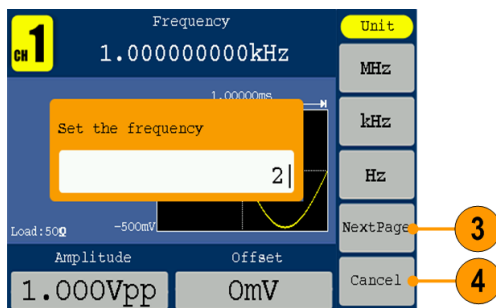

Unit conversions

The following conversion table shows the relationship between V_{p-p} and V_{rms} in the case of sine wave.

V _{p-p}	V _{rms}	dBm
10.00 V _{p-p}	3.54 V _{rms}	+23.98 dBm
2.828 V _{p-p}	1.00 V _{rms}	+13.01 dBm
2.000 V _{p-p}	707 mV _{rms}	+10.00 dBm
1.414 V _{p-p}	500 mV _{rms}	+6.99 dBm
632 mV _{p-p}	224 mV _{rms}	0.00 dBm
283 mV _{p-p}	100 mV _{rms}	-6.99 dBm
200 mV _{p-p}	70.7 mV _{rms}	-10.00 dBm
10.0 mV _{p-p}	3.54 mV _{rms}	-36.02 dBm

Channel Select

1. Push the front-panel **Ch1/2** button to control the screen display. You can toggle between the two channels.

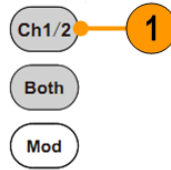

Channel output On/Off

1. To enable CH1 signal output, push the front-panel **On/Off** with yellow color. An LED turns on when the corresponding channel button is in the On state. You can configure the signal with the outputs off. This will allow you to minimize the chance of sending a problematic signal to a DUT.
2. To enable CH2 signal output, push the front-panel **On/Off** with blue color.

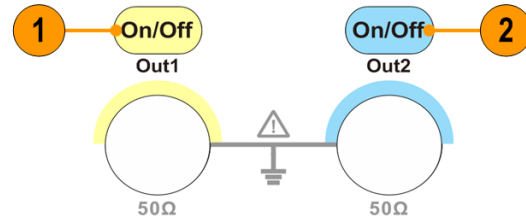

Display Both Channels

1. Push the front-panel **Both** button to display the parameters of both channels.

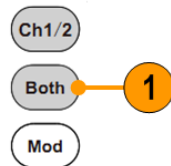

2. Push the front-panel **Ch1/2** button to switch the editable channel.

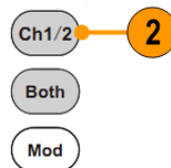

3. Push the Waveform buttons to select waveform of current channel.
4. Push the bezel button to choose the corresponding parameter. Push it again to switch the current parameter, such as Frequency/Period. Turn the general purpose knob to change the value of cursor position. Push the \leftarrow/\rightarrow direction button to move the cursor. (The numeric keypad can not be used to input.)

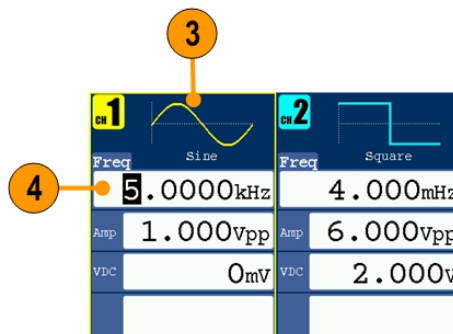

Rear panel

The following illustration shows the rear panel connectors for the instrument.

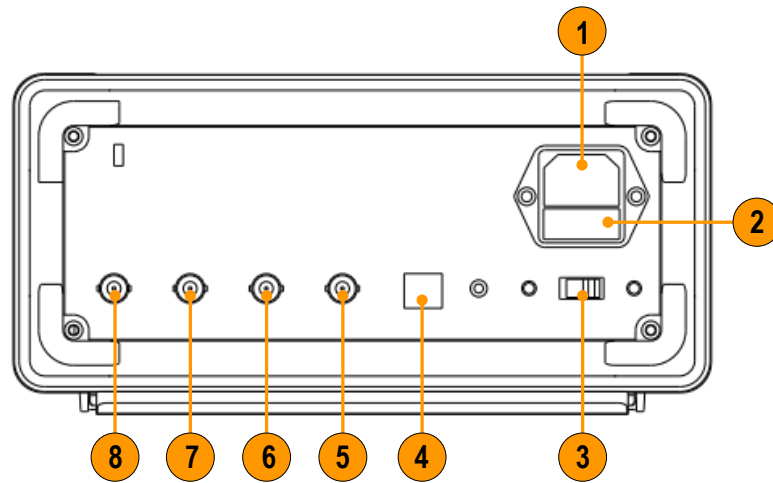

Item	Description						
1	Power input: This is where you attached an appropriate power cord to supply power to the instrument.						
2	Fuse: Use the specified fuse according to the voltage scale. The rating of replaceable fuse: <table border="1" style="margin-left: 20px;"> <thead> <tr> <th>Voltage</th> <th>Fuse</th> </tr> </thead> <tbody> <tr> <td>100 - 120 V</td> <td>250 V, F1AL</td> </tr> <tr> <td>220 - 240 V</td> <td>250 V, F0.5AL</td> </tr> </tbody> </table>	Voltage	Fuse	100 - 120 V	250 V, F1AL	220 - 240 V	250 V, F0.5AL
Voltage	Fuse						
100 - 120 V	250 V, F1AL						
220 - 240 V	250 V, F0.5AL						
3	Power line selector: Switch between 110 V / 220 V.						
4	USB (type B) connector: This can be used to connect a USB type B controller.						
5	Ext Mod In Connector: This is the BNC connector for external modulation input. It can be used to input a modulating signal.						
6	Ext Trig/Burst/Fsk In connector: This is the BNC connector for external trigger/burst/FSK input.						
7	Ref Clk/Counter In connector: This is the BNC connector for external reference clock or counter input.						
8	Ref Clk Out connector: This is the BNC connector for external reference clock output.						

Operating basics

Quick tutorial: How to select a waveform and adjust parameters

If you are a beginning user, follow the steps described here to get acquainted with how to select a waveform and adjust waveform parameters.

1. Push the power button to turn on the instrument.
2. Connect the Channel Output of the instrument to an oscilloscope input with a BNC cable.
3. Select a waveform.
4. Enable the signal output.
5. Observe the waveform displayed on the oscilloscope screen.
6. Use the front-panel shortcut buttons or bezel buttons on the instrument to select a waveform parameter.
7. Select Frequency as the parameter to be changed.
8. Change the frequency value using the numeric keypad.
9. Change the waveform parameters using the general purpose knob and the arrow keypad.

Quick tutorial: How to generate a sine waveform

If you are a beginning user, follow the steps described here to learn how to generate a continuous sine waveform.

1. Connect the power cord, and then push the front-panel power button to turn on the instrument.
2. Connect a BNC cable from the Channel Output of the arbitrary/function generator to an oscilloscope input connector.

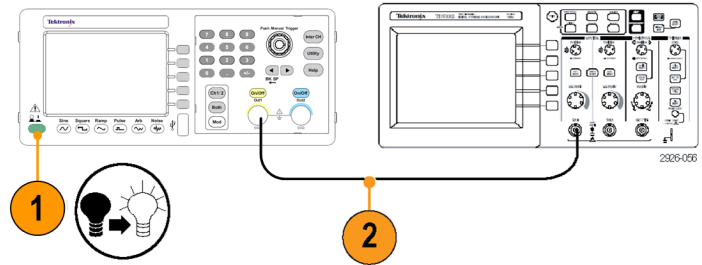

3. Push the front-panel **Sine** button.



4. The default run mode is Continuous after power-on. If it is not at Continuous mode, push the front-panel **Mod** button, and then press the bezel button to select **Continuous** among the four run modes.

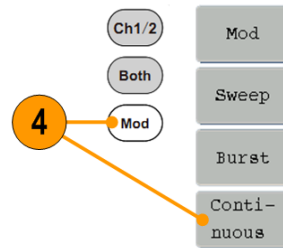

5. Push the front-panel Channel **On/Off** button to enable the output. The backlight should turn on.

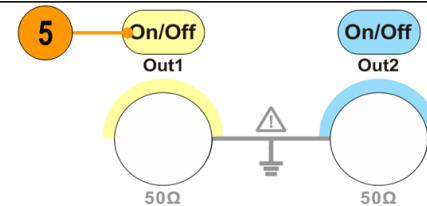

6. Use the oscilloscope auto-scaling function to display the sine waveform on the screen.
If the instrument outputs a default sine waveform, manually set the oscilloscope as follows:

- 500 us/div
- 400 mV/div

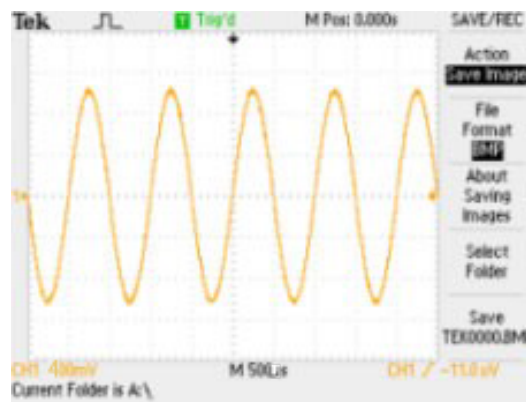

Quick tutorial: Instrument help system

The instrument help system allows you to access information about specific menu items and instrument functions when you need help. Access and navigate this help system using front panel buttons and knob; and then follow the on-screen instructions as they appear.

How to access the instrument help system

You can follow the steps described here to access the instrument help system.

1. Push the front-panel **Help** button to display the help screen.
2. Turn the general purpose knob to move the highlight from one link to another.
3. Press **Select** to display the topic corresponding to the highlighted link.
4. Press **Previous** to display a previous topic.
5. Press **Next** to display the next topic.
6. Press **Back** or push any front-panel button to remove the Help text from the screen and return to the graphic or parameter display.

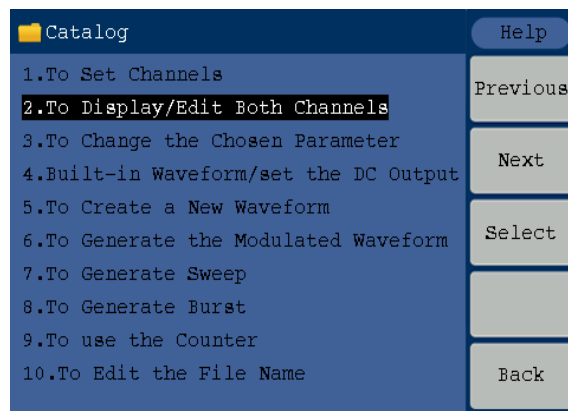

Ways to access and navigate the instrument help system

- Push the **Help** button to display information (topic) about the functions.
- Turn the general purpose knob or press **Previous** and **Next** to move from page to page within a displayed topic.
- Turn the general purpose knob to highlight a help topic in the index.
- Press **Select** to display the topic from the index page.
- Push the **Utility** button, then press **System**, and then press **Language** to choose the language in which you want the Help topics, bezel menus, and on-screen messages to appear.

Operating Basics

Generate a pulse waveform

1. Push the front-panel **Pulse** button to display the Pulse screen.

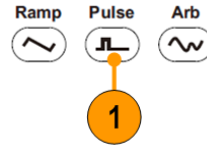

NOTE: All of the following parameters can be adjusted using the numeric keypad or the general purpose knob.

2. Press **Width/DutyCyc** and adjust the parameter as needed. Adjust the other parameters in the same way.

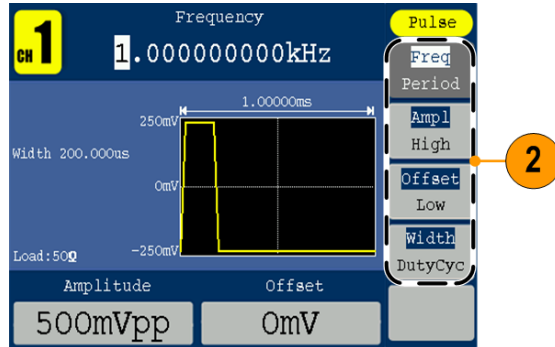

Generate a built-in waveform

The instrument can output a built-in waveform that is stored in the internal memory.

1. Push the front-panel **Arb** button.



2. Adjust the parameters of arbitrary waveforms according to *How to generate sine waveform* (see page 24).
3. Press **Built-in**. The built-in waveform menu is displayed.

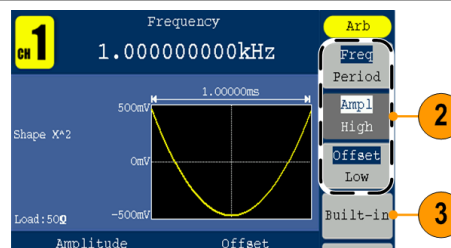

4. Press **Common**, **Maths**, **Window** or **Others** to enter built-in waveform detail list. You can browse 45 kinds of built-in waveforms saved in the internal memory. Use the front panel general purpose knob to scroll the files, then select a file and press **Select**. Or press **Cancel** to cancel the operation.

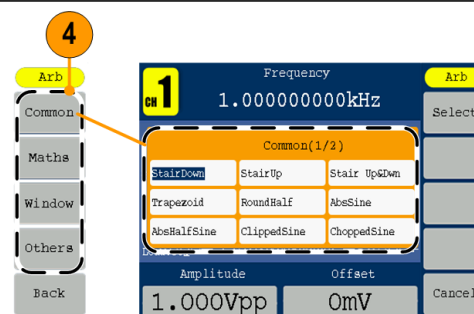

There are 45 kinds of Built-in waveforms, see as follows:

Name	Explanation
Common	
StairDown	Stair-down waveform
StairUp	Stair-up waveform
Stair Up&Dwn	Stair-up and stair-down waveform
Trapezoid	Trapezoid waveform
RoundHalf	RoundHalf wave
AbsSine	Absolute value of a Sine
AbsHalfSine	Absolute value of half a Sine
ClippedSine	Sine transverse cut
ChoppedSine	Sine vertical cut
NegRamp	Negative ramp
OscRise	Gain oscillation curve
OscDecay	Attenuation oscillation curve
CodedPulse	Coded pulse
PosPulse	Positive pulse
NegPulse	Negative pulse

Name	Explanation
Maths	
ExpRise	Exponential rise function
ExpDecay	Exponential fall function
Sinc	Sinc function
Tan	Tangent
Cotan	Cotangent
SquareRoot	Square root
X^2	Square function
HaverSine	HaverSine function
Lorentz	Lorentz function
Ln(x)	Natural logarithm function
X^3	Cubic function
CauchyDistr	Cauchy distribution
BesselJ	Bessell function
BesselY	Besselll function
ErrorFunc	Error function
Airy	Airy function
Windows	
Rectangle	Rectangle window
Gauss	Gauss distribution
Hamming	Hamming window
Hanning	Hanning window
Bartlett	Bartlett window
Blackman	Blackman window
Laylight	Laylight window
Triangle	Triangle window (Fejer window)
Others	
DC	DC signal
Heart	Heart signal
Round	Round signal
Chirp	Linear FM pulse
Rhombus	Rhombus signal
Cardiac	Cardiac signal

Create/Save a user-defined waveform

You can create a user-defined waveform, and save it in the internal memory or in an external USB memory device.

1. Push the **Arb** panel button.



2. Press **Editable**.

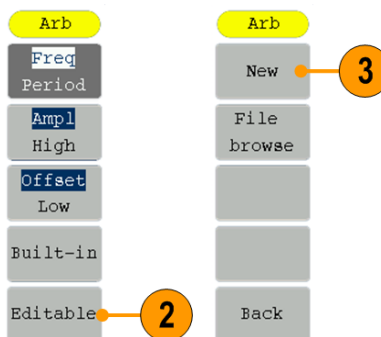

3. Press **New** to enter arb waveform edit menu.

4. Press **Points** to set the number of waveform points to be edited. Use the general purpose knob to adjust parameters directly or use the numeric keypad to adjust and then choose the proper unit. X1, X1000. The waveform points range is 2 to 8192.

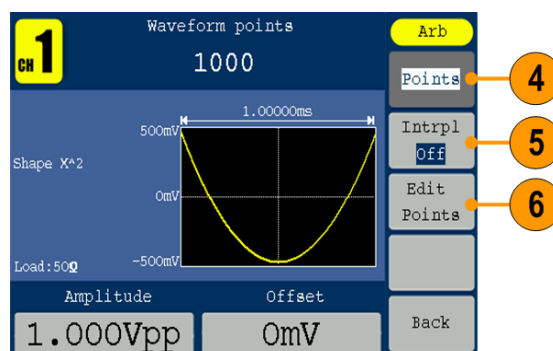

5. Press **Intrpl** to switch Interpolation On/Off. On means the points will be connected with beelines; Off means the voltages between two consecutive points will not change, and the waveform looks like a step-up one.
6. Press **Edit Points** to enter point edit sub menu.

7. Press **Point** to set the number of point to be edited.
8. Press **Voltage** to set the voltage of the point. Repeat step 7 and 8 to set voltages of the corresponding points.
9. Press **Write** to enter file system interface.

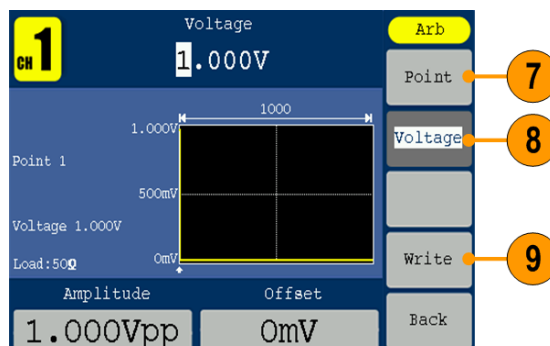

10. If you want to save the waveform to internal memory, select **INTER**, press **Enter**. Use the front panel general purpose knob to select a file from USER0 through USER255. Press **Save**.

NOTE:

The file size is displayed on the right side. 0B indicates the file is empty.

When creating a new waveform, the waveform data is in Edit Memory. If you do not save it, the data still exists in the Edit Memory. The data may be changed or cleared after creating a new waveform or receiving the related command. The data will be lost when the power is turned off.



11. To save the waveform to USB memory, first insert a USB memory device into the port on the front panel. Use the general purpose knob to select USBDEVICE, and then press **Enter**.

The instrument lists a directory of the folders and files on the USB memory device. Select a folder or file using the knob to scroll up and down the list.

To enter the current folder, press **Enter**. To return to the upper directory, press **Back**. Press **SaveAs**; the waveform will be saved in current directory.

An input keyboard will appear. Use the general purpose knob to choose characters. Press **ABC/abc** to toggle between upper-case and lower- case. Press **Select** to select the corresponding character. Press **Delete** to delete the last character. Press **DONE** to save the waveform as a file with the .tfw suffix. Press **Cancel** to cancel to current operation.

NOTE: The length of file name limits to 20 characters.



Recall a user-defined waveform

You can recall an user-defined waveform that is stored in the internal memory or a USB memory.

1. Push the **Arb** panel button.



2. Press **Editable**.

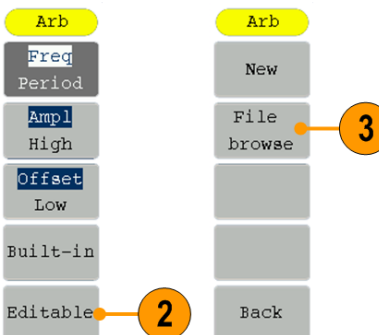

3. Press **File browse** to enter the file system.

4. To recall a waveform in the internal memory, select **INTER**, and then press **Enter**.

Use the front panel general purpose knob to select a file from Edit Memory or User 0 through User 255.

Press **CallOut**. If a prompt "File read successful." appears, go back to the waveform interface and view the waveform.

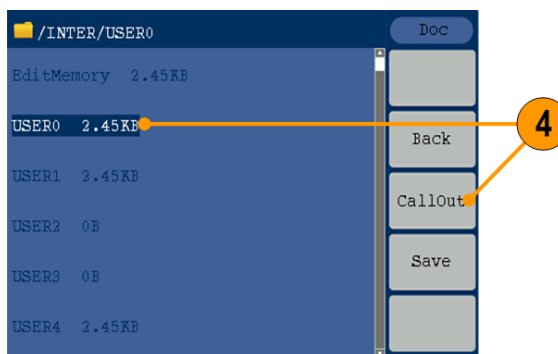

NOTE: The file size is displayed on the right side. 0B indicates the file is empty.

5. To recall a waveform in the USB memory, use the general purpose knob to select **USBDEVICE**, and then press **Enter**.

The instrument lists a directory of the folders and files on the USB memory device. Select a folder or file using the knob.

Select a file with the .tfw suffix, and then press **CallOut**. If a prompt "File read successful." appears, go back to the waveform interface and view the waveform. To return to the upper directory, press **Back**.

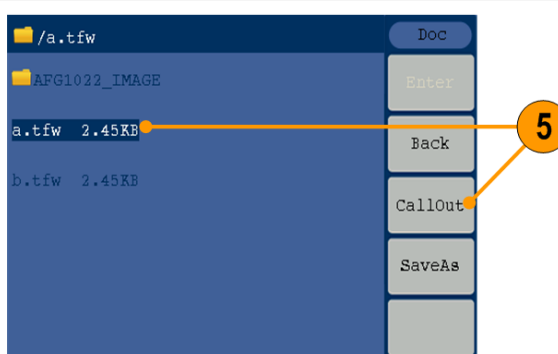

Generate noise

1. Push the front-panel **Noise** waveform button.

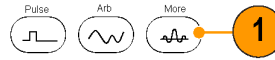

2. Use the general purpose knob or the numeric keypad to adjust Ampl, High, Offset and Low.

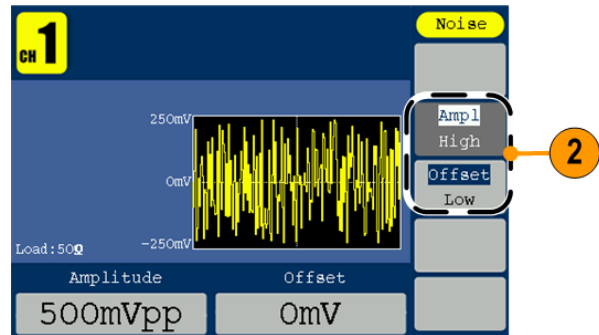

NOTE: You cannot modulate, sweep, or burst noise waveform.

Generate DC

1. Push the front-panel **Arb** button.

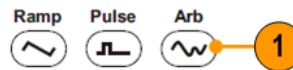

2. Press **Built-in**.

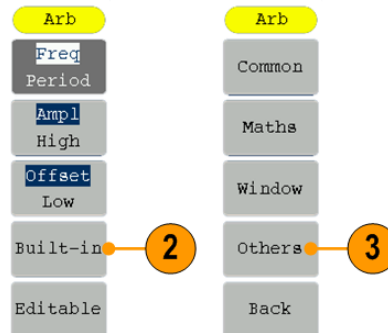

3. Press **Others**.

4. Select DC, press **Select** to output a DC waveform.

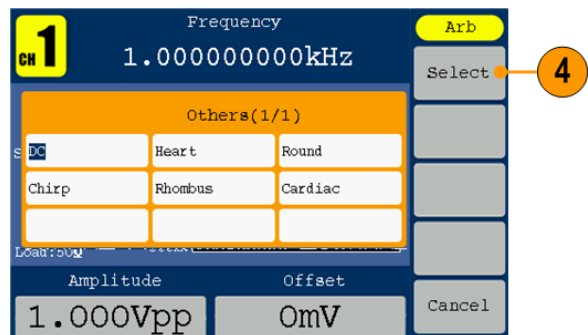

NOTE: You cannot modulate, sweep, or burst a DC waveform.

Sweep a waveform

The Sweep outputs a waveform with the output signal frequency varying linearly or logarithmically.

- Start frequency
- Stop frequency
- Sweep time
- Center frequency
- Frequency span

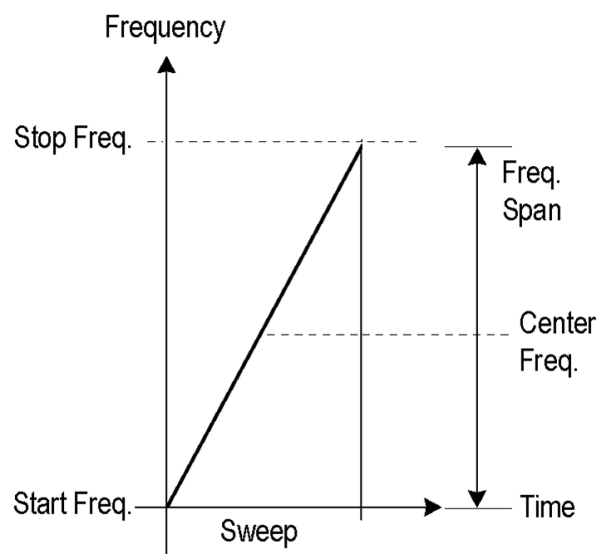

To set sweep parameters, do the following:

1. Select a waveform among sine, square, or ramp, and then push the front-panel **Mod** button.
2. Press **Sweep** to enter sweep menu.

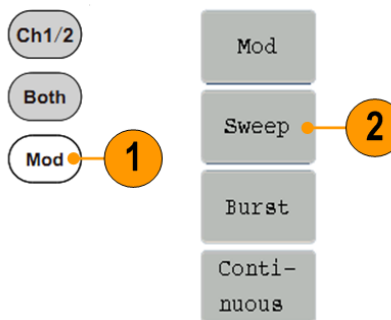

NOTE: You can only choose sine, square, or ramp as a carrier waveform.

3. Press **Sweep Time** to set the time between the start and stop frequency.
4. Press **Linear/Log** to select the sweep type.
5. Press **StartFreq/CtrFreq**. Use the general purpose knob or the numeric keypad to set the start or the center frequency.
6. Press **StopFreq/FreqSpan**. Use the general purpose knob or the numeric keypad to set the stop frequency and the frequency span.
7. Press **NextPage** to enter next submenu.

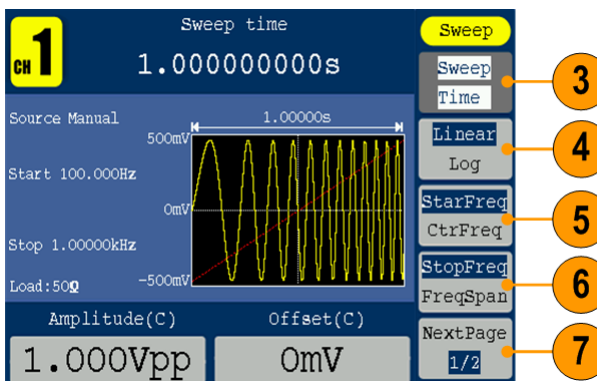

8. Press **Source** to choose a source between internal, external, and manual. **External** defines the source input from the Trig/FSK/Burst interface. Press **Slope** to switch between Positive and Negative. **Manual** defines the sweeping whenever the general purpose knob is pushed.

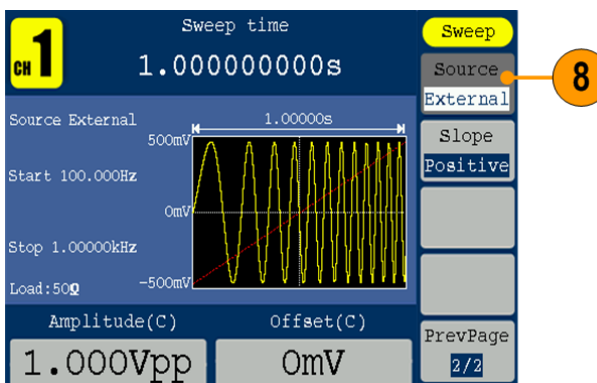

NOTE: All the parameters can be adjusted by the general purpose knob or the keypad.

Sweep frequency facts

- If a start frequency is lower than a stop frequency, the instrument sweeps from the low frequency to the high frequency.
- If a start frequency is higher than a stop frequency, the instrument sweeps from the high frequency to the low frequency.
- Once the sweep is selected, the frequency is swept from the sweep start to the sweep stop frequencies.

Modulate a waveform

To output an AM waveform

1. Select a waveform and then push the front-panel **Mod** button.
2. Press **Mod**.
In this example, use the sine waveform as an output waveform (carrier waveform).

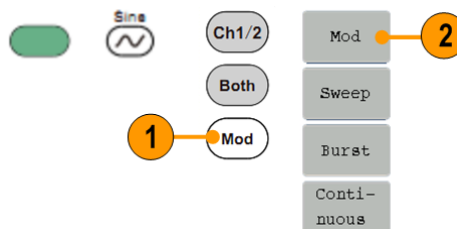

NOTE: You can only choose sine, square, ramp, or arb as a carrier waveform.

3. Press **Type** to display the modulation selection menu. Select AM as the modulation type.



4. Press **Source** to select Internal or External. If the source is External, use the Ext Mod In connector in the rear panel to input the external signal, the setting of AM is finished. If you choose Internal, continue with the steps below.
5. Press **Shape** to select among sine, square, ramp, or arb as the modulating waveform.
6. Press **AM Freq** to set the AM frequency. The range is 2 mHz to 20 kHz (Internal source only).
7. Press **Depth**, use the general purpose knob to adjust the depth or use the numeric keypad and then select % as unit. The range is 0% to 100%.

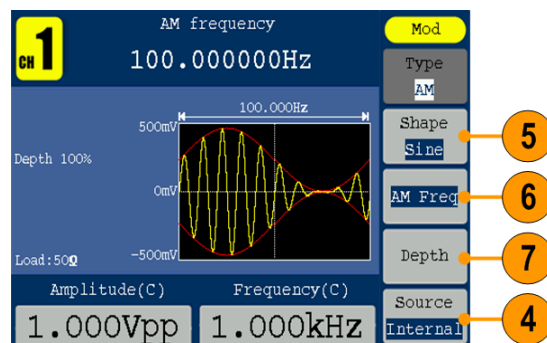

To output an FM waveform

1. Select a waveform and then push the front-panel **Mod** button.
2. Press **Mod**.
In this example, use the sine waveform as an output waveform (carrier waveform).

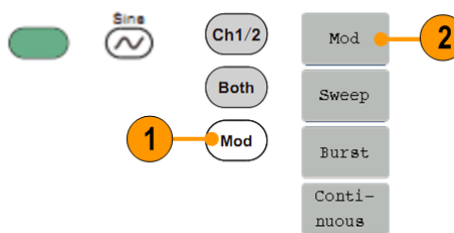

NOTE: You can only choose sine, square, ramp, or arb as a carrier waveform.

3. Press **Type** to display the modulation selection menu. Select **FM** as the modulation type.

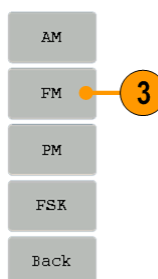

4. Press **Source** to select Internal or External. If the source is External, use the Ext Mod In connector in the rear panel to input the external signal, the setting of FM is finished. If you choose Internal, continue with the steps below.

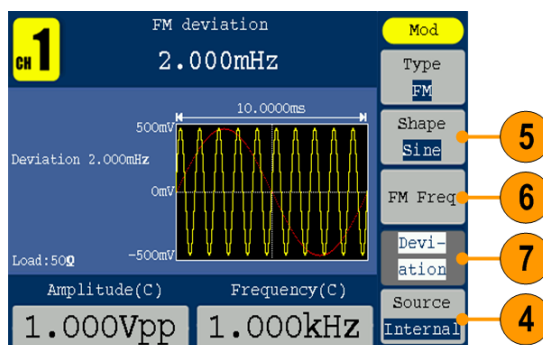

5. Press **Shape** to select among sine, square, ramp, or arb as the modulating waveform.
6. Press **FM Freq** to set the FM frequency. The range is 2 mHz to 20 kHz (Internal source only).
7. Press **Deviation**, use the general purpose knob to adjust the deviation or use the numeric keypad and then select unit.

NOTE: The sum of deviation and carrier frequency should be less than or equal to that of the upper limit of carrier waveform and 1 kHz. For external source, the deviation is controlled by the electrical level of Modulation In interface. +5 V add the selected deviation, and -5 V minus the selected deviation

To output an PM waveform

1. Select a waveform and then push the front-panel **Mod** button.
2. Press **Mod**.
In this example, use the sine waveform as an output waveform (carrier waveform).

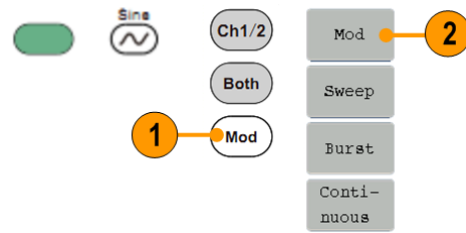

NOTE: You can only choose sine, square, ramp, or arb as a carrier waveform.

3. Press **Type** to display the modulation selection menu. Select **PM** as the modulation type.

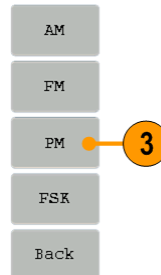

4. Press **Source** to select Internal or External. If the source is External, use the Ext Mod In connector in the rear panel to input the external signal, the setting of PM is finished. If you choose Internal, continue with the steps below.

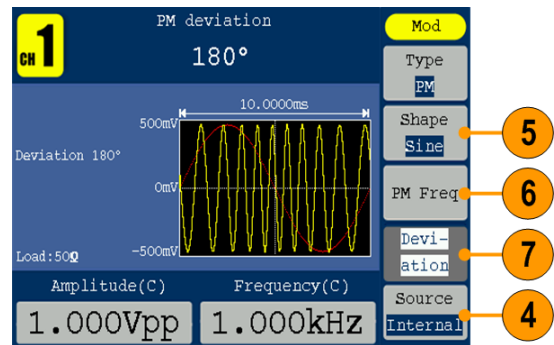

5. Press **Shape** to select among sine, square, ramp, or arb as the modulating waveform.
6. Press **PM Freq** to set the PM frequency. The range is 2 mHz to 20 kHz (Internal source only).
7. Press **Deviation**, use the general purpose knob to adjust the deviation or use the numeric keypad and then select unit.

To output an FSK waveform

Frequency Shift Keying modulation is a modulation technique that shifts the output signal frequency between two frequencies: the carrier frequency and Hop frequency. The Frequency of the Output Frequency switch between the carrier waveform frequency and the Hop frequency is called the FSK rate. The frequency by which the output frequency switch from each other is determined by the Internal Frequency generator or the Signal Voltage Level offered by the Ext Trig/FSK/Burst connector in the rear panel. The user interface of the FSK is shown as below.

1. Select a waveform and then push the front-panel **Mod** button.

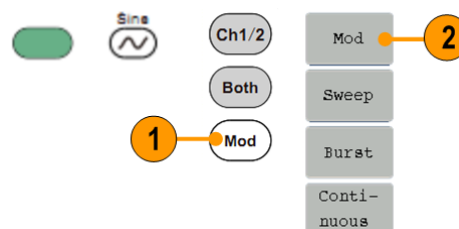

2. Press **Mod**.

In this example, use the sine waveform as an output waveform (carrier waveform).

NOTE: You can only choose sine, square, ramp, or arb as a carrier waveform.

3. Select **FSK** as the modulation type.

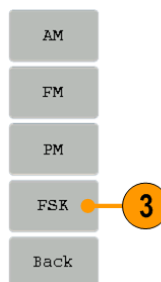

4. The FSK parameter setting screen is displayed. Select Internal or External as FSK source.
5. If you select **Internal**, you can set the FSK Rate. If you select **External**, press **Slope** to switch between Positive and Negative.

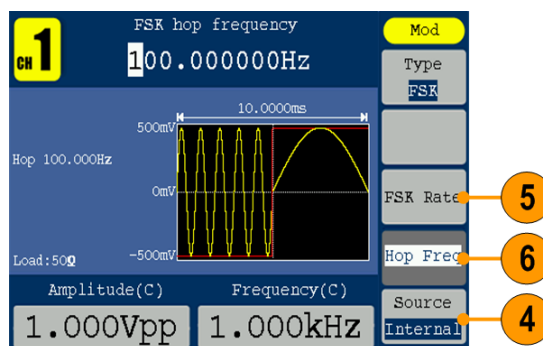

6. Set Hop Frequency. Carrier waveform frequency shifts to the Hop frequency with the specified FSK rate, and then returns to the original frequency.

Modulation waveform facts and formulas

- You can output frequency modulation or phase modulation waveforms in the same way.
- You can select an internal or external signal as an AM source.
- You can select a modulation shape from the internal memory or USB memory.
- You can only select sine, square, ramp, or arb as a carrier waveform.
- The following equations show the output amplitude of AM, FM, and PM modulation (in this example, sine waveform is used for carrier waveform and modulation waveform):

AM: $Output(V_{p-p}) = \frac{A}{2} \left(1 + \frac{M}{100} \sin(2\pi f_m t) \right) \sin(2\pi f_c t)$

FM: $Output(V_{p-p}) = A \sin(2\pi (f_c + D \sin(2\pi f_m t)) t)$

PM: $Output(V_{p-p}) = A \sin\left(2\pi f_c t + 2\pi \frac{P}{360} \sin(2\pi f_m t)\right)$

Carrier amplitude	A[V _{p-p}]
Carrier frequency	fc [Hz]
Modulation frequency	fm [Hz]
Time	t [sec]
AM Modulation depth	M [%]
FM Deviation	D [Hz]
PM Deviation	P [degree]

- The following table shows relationship between modulation depth and maximum amplitude for AM modulation waveform (internal modulation source is selected):

Depth	Maximum amplitude
100%	A (V _{p-p})
50%	A (V _{p-p}) * 0.75
0%	A (V _{p-p}) * 0.50

Generate a burst waveform

The instrument can output a burst using standard waveforms such as sine, square, ramp, and pulse, or arbitrary waveforms. The instrument allows you to use the following two types of burst mode:

Triggered burst mode. A specified number (burst count) of waveform cycles are output when the instrument receives a trigger input from the internal trigger source, an external trigger source, a remote command, or the Manual Trigger button.

Gated burst mode. The instrument outputs a continuous waveform when an effective gate signal is applied externally, when the Manual Trigger button is depressed, when a remote command is applied, or during 50% of the selected internal trigger interval.

To generate a triggered burst waveform

Burst function is only available on CH1. Burst function generates versatile waveforms in burst. A burst can last for certain times of waveform cycle (Triggered Burst), or to be controlled by external gating signals (Gated Burst). Burst can be applied to sine, square, ramp, pulse, and arb waveforms (You can't select noise).

1. Select a waveform and then push the front-panel **Mod** button.
2. Press **Burst**.

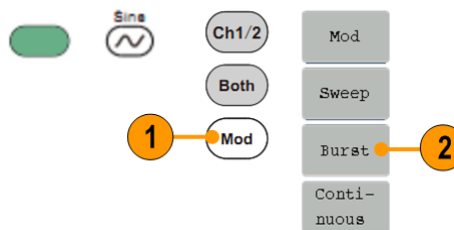

NOTE: You cannot select noise waveform as a carrier waveform.

3. Press **N Cycle/Gated** to select N Cycle.
4. Press **Trigger Interval** to set the trigger interval.
5. Press **Start Phase** to set start phase. The start phase defines the initial phase where the waveform output begins at, and it may vary from -360 to 360. For an arbitrary waveform, 0° is the first waveform point.
6. Press **Cycles/Infinite** to select **Cycles**. Use the general purpose knob or the numeric keypad to set the number of waveform cycles (from 1 to 50,000) in each burst. If you select **Infinite**, then a continuous waveform will be generated at one trigger event and will not stop until another trigger event happens (the general purpose knob on the front panel is pushed).

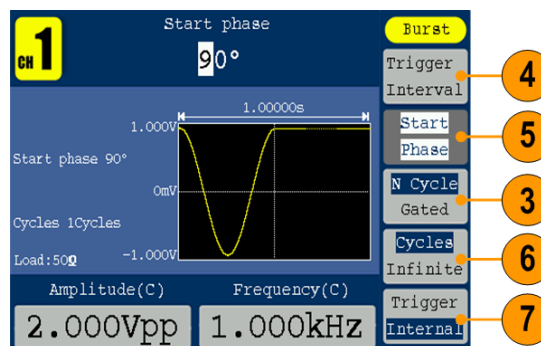

- Press **Trigger** to select Internal, External or Manual.

Internal means using the internal trigger source.

External means using the Ext Trig/FSK/Burst connector on the rear panel to input the external triggered signal. Press **Slope** to switch between Positive and Negative.

Manual means choosing manual trigger; in Triggered Burst mode, push the general purpose knob on the front panel to output a burst signal.

To generate a gated burst waveform

- Select a waveform and then push the front-panel **Mod** button.
- Press **Burst**.

NOTE: You cannot select pulse, noise, or arb waveform as a carrier waveform.

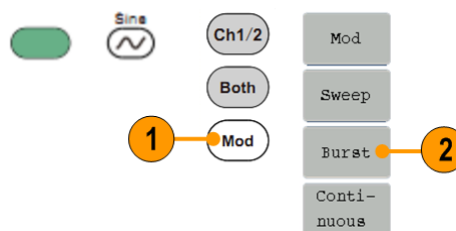

- Press **N Cycle/Gated** to select Gated.
- Press **Start Phase** to set start phase. The start phase defines the initial phase where the waveform output begins at, and it may vary from -360 to 360. For an Arbitrary Waveform, 0° is the first waveform point.
- Press **Polarity** to set the polarity of the gated burst waveform.

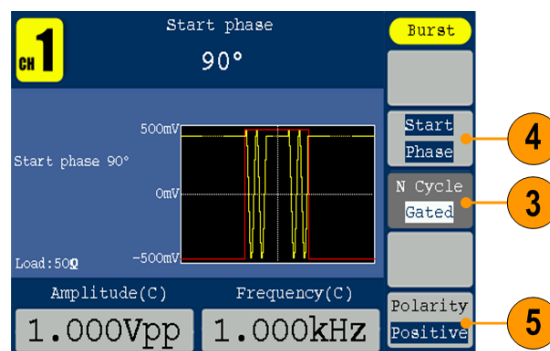

Copy channel setting

The instrument can copy the parameters of one channel to the other. If frequency or amplitude of both channels are locked, when you change the parameter of either channel, the parameter of the other channel is set to the same value.

1. Push the **Inter CH** panel button to display the submenu.
2. Press **CH2 To CH1** to copy parameters of CH2 to CH1.
3. Press **CH1 To CH2** to copy parameters of CH1 to CH2.
4. Press **FreqLock** to toggle between On and Off. At on status, the frequency of the two channels can be adjusted synchronously.
5. Press **AmpLock** to toggle between On and Off. At on status, the amplitude of the two channels can be adjusted synchronously.
6. Press **PhaseDev**, and then use the numeric keypad to input the value of phase deviation, or select Off to disable it.

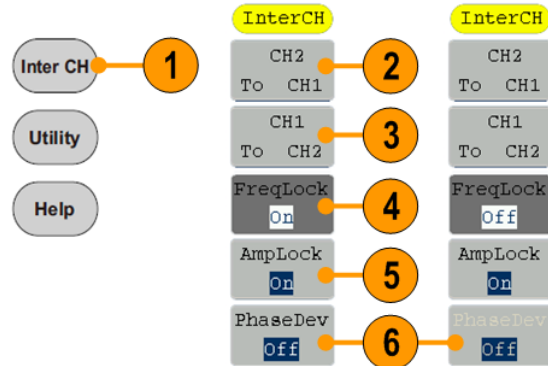

NOTE: The *PhaseDev* bezel button is only valid when *FreqLock* is on.

USB memory

A USB memory connector, located on the front panel of the instrument, allows you to perform the following tasks:

- Save user-defined waveforms to a USB memory device (See page 29, *Create/Save a user-defined waveform.*) or recall waveform from a USB memory device (See page 31, *Recall a user-defined waveform.*).
- Update your instrument firmware (See page 9, *Update your instrument firmware.*)



CAUTION. *When you plug in a USB memory device to the instrument, a caution message appears on the screen. Do not remove the USB memory device until the message disappears.*

If you remove the USB memory device while this caution message is displayed, it may cause damage to the instrument.

USB connector requirements

This instrument supports a USB memory with a FAT32 file system, and the allocation unit size cannot exceed 4096. If the USB memory doesn't work properly, format it into the supported format and try again.

Emissions can exceed the specification limit if a USB cable is placed in the front-panel USB memory connector. Use only appropriate USB memory devices.

Utility menu

Push the front-panel **Utility** button to display the Utility menu. The Utility menu provides access to utilities used by the instrument such as system related menus, and local language preferences.

1. Push the front-panel **Utility** button to display the Utility menu which has the following options.
2. **Display setup related menus**, see step 6.
3. **Counter related menus**, see step 10.
4. **Output setup related menus**, see step 15.
5. **System setup related menus**, see step 16.

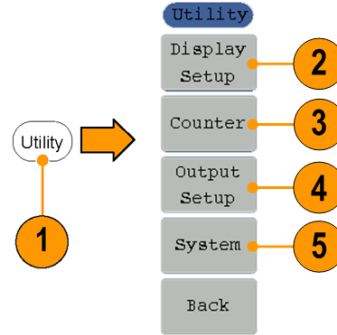

6. Press **Display Setup** to display the submenu.
7. Press **BckLight**, use the general purpose knob to adjust the value on the current cursor and use to **</>** move cursor. You can also use the numeric keypad to adjust the parameters and then choose proper unit.
8. Press **Separatr** to select the separator among Comma, Space and Off.
9. Press **ScrSaver** to select On or Off. At on status, you can set the screen saver time. Use the general purpose knob to adjust the value on the current cursor and use to **</>** move cursor. You can also use the numeric keypad to adjust the parameter and then select min as unit. The screen saver time range is 1 to 999 minutes.

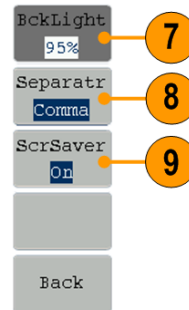

10. Press **Counter** to display the Counter submenu. Connect the signal to the connector [Ref Clk/Counter In] on the rear panel. Press **Settings** to display the submenu.
11. Press **Coupling** to select AC or DC as coupling mode.
12. Press **Sens** to select Low, Middle and High. For low amplitude signal, the “Middle” or “High” sensitivity should be used. For low frequency signal with high amplitude and slower rising edge, low sensitivity is a better choice.
13. Press **HFR** to select ON or OFF. High frequency restrain is used for filtering the high frequency signal in measuring the low frequency signal, and improve the measure accuracy. To measure low frequency signal lower than 1 kHz, you should put on the high frequency restrain to filter out the high frequency noise. To measure high frequency signal higher than 1 kHz, you should turn off the high frequency restrain.
14. Press **Trigger Level**. Use the general purpose knob to adjust the value on the current cursor, use **</>** to move cursor. You can also use the numeric keypad to adjust the parameter and then select unit. The range of trig level is -2.5 V to +2.5 V.

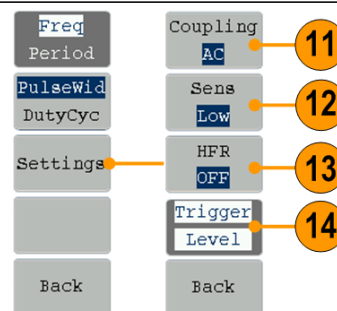

15. Press **Output Setup** to set output load value. Press **CH1Load** or **CH2Load** to toggle 50 Ω and High Z. At 50 Ω status, use the general purpose knob to adjust the value on the current cursor and use to \leftarrow/\rightarrow move cursor. Use the numeric keypad to adjust the parameters and then choose proper unit. The load range is 1 Ω to 10 K Ω .

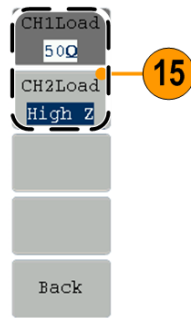

NOTE: Please setup the correct load for right application.

16. Press **System** to display the submenu.
Language (See page 6, *Select a local language*)
PowerOn (See page 5, *Change instrument settings at power-on*)
Set to Default (See page 15, *Default setup*)
17. Press **NextPage** to enter next submenu.
18. Press **Beeper** to toggle the beep sound Off and On.
19. Press **Clk Ref** to toggle the clock reference source between Internal and External.
20. **Update firmware** (See page 9, *Update your instrument firmware*)

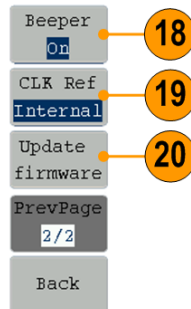
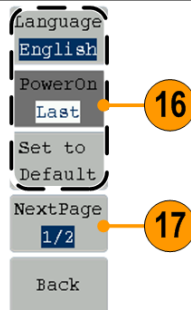

Appendix A: Line Fuse Replacement

The line fuse is in the plastic fuse box below the power line input on the rear panel.



WARNING. *Disconnect the line cord at the rear panel and remove all test leads connected to the instrument before replacing the line fuse. Failure to do so could expose the operator to hazardous voltages that could result in personal injury or death.*

Use only the correct fuse type. Failure to do so could result in personal injury or instrument damage.

Voltage	Fuse
100 - 120 V	250 V, F1AL
220 - 240 V	250 V, F0.5AL

To perform the line fuse replacement, follow these steps:

1. Remove the power cord.
2. Use a screwdriver to remove the fuse box.

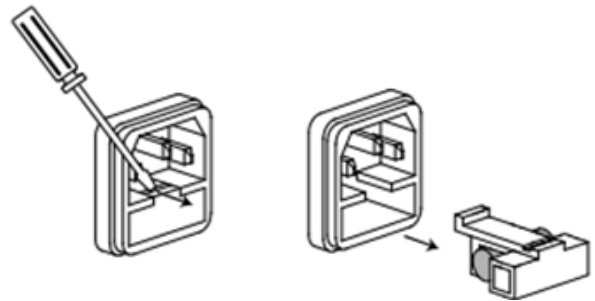

3. Replace the fuse with a new one, which should match with the voltage; install it into the fuse box and then push the fuse box back on to the rear panel.

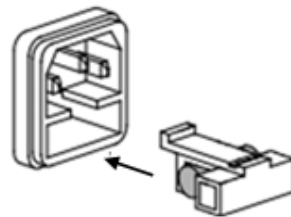

Index

- A**
 - Amplitude, To change the units, 20
 - Application examples
 - Frequency modulation, 36
 - Arb button (front panel), 13
 - Recalling arbitrary waveforms, 31
- B**
 - Beeper
 - Utility menu, 46
 - Bezel menu
 - screen interface, 14
 - Burst waveform
 - generate, 41
- C**
 - Center frequency
 - sweep waveform, 33
 - Channel output On/Off, 21
 - Utility menu, 46
 - Language selection, 6
- D**
 - DC
 - standard waveform, 18
 - Default setup, 15
 - Default, Power on settings, 5
- E**
 - Environmental requirements, 3
 - Equivalent output circuits, 12
 - Exponential decay standard waveform, 18
 - Exponential rise
 - standard waveform, 18
 - Ext Mod In Connector
 - connector rear panel, 22
 - Ext Trig/ Burst/Fsk In connector
 - rear panel, 22
- F**
 - Firmware updates, 9
 - Formulas
 - modulation waveforms, 40
 - Frequency span
 - sweep waveform, 33
 - Front panel, 13
- G**
 - Gated burst waveform
 - generate, 43
 - Generate a burst waveform, 42
 - Generate a pulse waveform, 26
 - Generate a sine waveform, 24
 - Generate an arbitrary waveform, 27
 - Generate DC, 32
 - Generate Noise, 32
 - Graph display area
 - screen interface, 14
- H**
 - Haversine
 - built-in waveform, 18
 - Help 24
 - Hold time
 - sweep waveform, 33
- I**
 - Instrument power-on and power-off, 4
 - Instrument settings when powered-on, 5
- L**
 - Language selection 6
 - Last, Power on settings, 5
 - Load impedance 46
- M**
 - Main display area
 - screen interface, 14
 - Message display area
 - screen interface, 14
 - Modify an arbitrary waveform, 29
 - Modulate a waveform, 36
 - Modulation waveform formulas, 40
- N**
 - Noise
 - standard waveform, 32
 - Number of Points, Edit menu, 29
- O**
 - Operating requirements, 3
 - Option buttons, 14
 - Output On/Off channel, 21
- P**
 - Parameter display area
 - screen interface, 14
 - Power button, 4
 - Power consumption, 3
 - Power input
 - rear panel, 22
 - Power off, 4
 - Power on, 4
 - Power supply requirements, 3
 - Procedure
 - To adjust waveform parameters, 20
 - Programmer Manual iii, 2
 - Protect your DUT, 7

R

- Rear panel, 22
- Recalling waveform data 31
 - Saving waveform data, 29
- Run Mode, 19

S

- Save a waveform
 - Save arbitrary waveform, 29
 - Recall arbitrary waveform, 31
- Screen interface, 14
 - Screen saver
 - Utility menu, 46
 - Selecting a local language, 6
 - Side-menu buttons, 14
- Sin(x)/x
 - standard waveform, 18
- Soft keypad, 14
- Standard accessories, 2
- Standard waveforms, 17
- Start frequency
 - sweep waveform, 33
- Stop frequency
 - sweep waveform, 33
- Sweep, 33
- Sweep time
 - sweep waveform, 33

T

- To adjust waveform parameters, 20
- To generate a pulse
 - waveform, 26
- To generate a sine waveform, 24
- To generate an built-in
 - waveform, 27
- To create/save a user-defined
 - waveform, 29
- To protect your DUT, 7
- To output an AM
 - waveform, 36
- To output an FSK
 - waveform, 39
- To restore the default
 - setup, 15

- To set up load impedance, 48
- To select a local language, 6
- To select a waveform, 17
- To select Run Mode, 19
 - To sweep a waveform, 33

U

- USB connector requirements, 45
- USB interface
 - front panel, 13
- USB memory, 45
- Utility menu, 46

V

- Voltage units, Conversion table
 - of V_{p-p} , V_{rms} , 20

W

- Waveform display area
 - screen interface, 14
- Waveform parameter, how to
 - change, 20
- Waveforms
 - Save, 29
 - Recall, 31