



## **4/5/6 Series MSO**

**MSO4X, MSO4XB, MSO5X, MSO5XB, MSO64, MSO6XB, MSO58LP, and  
LPD64**

**Help**

**Register now!**

**Click the following link to protect your product.**

**[tek.com/register](https://tek.com/register)**



**077-1303-22 November 2023**

Copyright © Tektronix. All rights reserved. Licensed software products are owned by Tektronix or its subsidiaries or suppliers, and are protected by national copyright laws and international treaty provisions. Tektronix products are covered by U.S. and foreign patents, issued and pending. Information in this publication supersedes that in all previously published material. Specifications and price change privileges reserved.

TEKTRONIX and TEK are registered trademarks of Tektronix, Inc.

FlexChannel, TekVPI, FastAcq, and e\*Scope are registered trademarks of Tektronix, Inc.

FastFrame and TekSecure are trademarks of Tektronix, Inc.

### **Contacting Tektronix**

Tektronix, Inc.

14150 SW Karl Braun Drive

P.O. Box 500

Beaverton, OR 97077

USA

For product information, sales, service, and technical support:

- In North America, call 1-800-833-9200.
- Worldwide, visit [www.tek.com](http://www.tek.com) to find contacts in your area.

# Contents

List of Figures.....	19
List of Tables.....	21
Welcome to the instrument embedded Help.....	22
TEKTRONIX END USER LICENSE AGREEMENT.....	26
Open Source GPL License Notice.....	26
Product support and feedback.....	26
Documentation.....	27
Options.....	29
Install option upgrade licenses.....	29
Uninstall (return) an option license.....	30
Drive names for system and USB memory devices.....	30
Getting acquainted with your instrument.....	33
Installing and activating Windows 10 operating system.....	33
Install the SSD.....	33
Powering on Windows for the first time.....	34
Activating Windows.....	34
Differences between Windows and base instrument user interfaces.....	35
Updating the Windows TekScope application software.....	36
Secure (lock) the instrument.....	36
Connecting probes or signals to the instrument.....	37
Rackmount option information.....	39
Bench conversion kit information for Low Profile instruments.....	39
Front panel controls and connectors.....	39
Rear panel connections.....	48
User interface screen.....	51
User interface elements.....	53
Badges.....	55
Moving waveform and measurement badges.....	64
Group signal badges in the Settings bar.....	65
Configuration menus.....	66
Zoom user interface.....	67
Using the touch screen interface for common tasks.....	68
Accessing application help.....	69
ESD Prevention Guidelines.....	69
Configure the instrument.....	71
Set the time zone and clock readout format.....	71
Functional check.....	71
Download and install the latest instrument firmware.....	72
Run Signal Path Compensation (SPC).....	73
Compensate the TPP Series probes.....	73
Compensate passive probes.....	75
Connect to a network (LAN).....	76
Mount a network drive from a standard instrument.....	76
Mount a network drive on the Windows 10 instrument.....	77

---

Mount TekDrive.....	78
Unmount a network drive from a standard instrument.....	78
Unmount a network drive from the Windows 10 instrument.....	79
Unmount a TekDrive.....	79
Connect the oscilloscope to a PC using a USB cable.....	79
Remote access from a Web browser.....	79
Remote access to a Windows 10 instrument.....	80
Install TightVNC on the Windows 10 instrument.....	81
Install TightVNC on a PC.....	82
Deskew analog input channels.....	82
Connect a keyboard or mouse.....	83
Connect an external monitor or projector.....	83
Analog channel operating basics.....	85
Acquiring a signal.....	85
Autoset to quickly display a waveform.....	85
Set Horizontal parameters.....	86
How to trigger on a signal.....	87
Set the acquisition mode.....	88
Start and stop an acquisition.....	89
Enable the History.....	89
Add a channel waveform to the display.....	89
Configure channel and waveform settings.....	90
Add a math, reference, or bus waveform.....	93
Analog view of digital waveform.....	94
Add a measurement.....	95
Configure a measurement.....	97
Delete a Measurement or Search badge.....	98
Add a plot of a measurement.....	99
Display a Histogram plot.....	100
Display a Time Trend plot.....	101
Display a Acq Trend plot.....	101
Display a Spectrum plot.....	101
Display an XY or XYZ plot.....	101
Display an Eye Diagram plot.....	102
Display a Phasor Diagram for Power Quality measurement.....	102
Display a Phasor Diagram for DQ0 measurement.....	102
Display a Harmonics Bar Graph plot for IMDA Harmonics measurement.....	102
Add Mask Testing to an Eye Diagram plot.....	103
Display an FFT math waveform.....	104
Display a B-H curve plot for Magnetic Property measurement.....	104
Display an I vs (integral of) V plot for I vs V measurement.....	104
Display an Inductance Curve plot for Inductance measurement.....	104
Display a Safe Operating Area (SOA) measurement and plot.....	105
Display a power Switching Loss (SWL) Trajectory plot.....	105
Display instantaneous power and energy plots from the Power Quality measurement.....	105
Display a Harmonics Bar Graph plot for the Power Harmonics measurement.....	106
Display a Power Supply Rejection Ratio plot.....	106
Display a Control Loop Response (Bode) plot.....	106
Add a Search.....	107



Change waveform view settings.....	108
Display and configure cursors.....	109
Display and configure Multi-source cursor readouts.....	111
Using Default Setup.....	113
Using Fast Acq.....	113
Add a callout to a view.....	114
Delete a Callout.....	115
Acquiring digital signals.....	116
Connect and set up digital signals.....	116
Add a serial bus to the Waveform view.....	117
Add a parallel bus to the Waveform view.....	118
Advanced triggering.....	121
Triggering concepts.....	121
Trigger on a pulse width event.....	121
Trigger on a timeout event.....	122
Trigger on a runt signal event.....	123
Trigger on a signal window event.....	124
Trigger on a logic event.....	124
Trigger on a setup-hold event.....	126
Trigger on a rise or fall time event.....	126
Set up trigger on a parallel bus.....	127
Set up trigger on a serial bus.....	128
Trigger on sequential events (A and B triggers).....	128
Set Trigger Holdoff.....	129
Trigger on an external signal using the AUX input (MSO58LP, MSO64, LPD64 only).....	129
Create Visual Trigger areas.....	130
Edit visual trigger areas on the screen.....	130
Edit visual trigger areas using the Area menu.....	132
RF vs Time trigger.....	134
Using Spectrum View.....	138
Spectrum View concepts.....	138
Time Domain Traces concepts.....	140
Display a spectrum trace.....	142
Enable the spectrogram.....	143
The Spectrum View user interface.....	143
Spectrum View and Spectrum Time.....	145
Spectrum trace handle and trace types.....	149
Spectrum peak markers.....	150
Spectrum View and front panel controls.....	150
Spectrum View and badges.....	151
Save and recall spectrum traces.....	154
Setting waveform display parameters.....	155
Set waveform display mode (Stacked or Overlay).....	155
Set the Waveform Interpolation mode.....	155
Set the waveform persistence, style, and intensity.....	155
Set the graticule style and intensity.....	156
Mask testing waveforms.....	157
Create a Mask.....	157
Edit mask segments on the screen.....	157

---

Edit mask segments using the Mask Definition menu.....	160
Waveform histogram .....	163
Create a waveform histogram.....	163
Edit histogram on the screen.....	163
Waveform Histogram guidelines.....	164
Zoom in on waveforms.....	165
Turn on Zoom mode.....	165
Using Wave Inspector front-panel controls for zoom.....	166
Zoom mode and Searches.....	166
Measurement configuration.....	168
Label a measurement.....	168
Set measurement reference levels.....	168
Set measurement gates.....	169
Set measurement filters.....	170
Set measurement limits.....	171
Saving and recalling information.....	172
Save a screen image.....	172
Save a waveform or spectrum trace to a file.....	172
Save instrument settings to a file.....	173
Save reports.....	174
Save sessions.....	174
Recall a reference waveform or spectrum trace.....	175
Recall a Setup file.....	176
Recall a Session file.....	176
Open a mask test file for an Eye Diagram plot.....	177
Menus and dialog boxes.....	178
Act On Event configuration menu.....	178
Acquisition configuration menu.....	179
Fast Frame Panel.....	180
Fast Frame badge.....	182
Fast Frame badge configuration menu.....	182
History badge configuration menu.....	183
Add Measurements configuration menu overview.....	188
The Standard measurements tab.....	189
Amplitude Measurements panel.....	190
Timing Measurements panel.....	191
Spectrum Measurements panel.....	193
Jitter Measurements panel.....	195
The Jitter tab (Advanced Jitter and Eye Analysis).....	196
The Power tab.....	199
The IMDA tab.....	203
The DPM tab.....	204
The DDR measurements tab.....	207
The WBG-DPT tab.....	208
Measurement configuration menu overview.....	210
Measurement Name panel (Measurement configuration menu).....	211
Configure panel (Measurement configuration menu).....	212
Reference Levels panel (Measurement configuration menu).....	212
Clock Recovery panel (Measurement configuration menu).....	214

Clock Recovery- Advanced Settings configuration menu.....	217
Gating panel (Measurement configuration menu).....	218
Filter/Limit Results panel (Measurement Settings menu).....	220
Pass/Fail Testing panel (Measurement Settings menu).....	221
Spectrum measurements configuration menu overview.....	222
Spectrum Measurements Name panel (Measurement configuration menu).....	222
Configure panel (Spectrum measurements configuration menu).....	223
Pass/Fail Testing panel (Spectrum measurement configuration menu).....	225
Jitter measurement configuration menu overview.....	225
Jitter Measurement Name panel (Measurement configuration menu).....	226
Configure panel (Jitter measurement configuration menu).....	227
Reference Levels panel (Jitter measurement configuration menu).....	236
Clock Recovery panel (Jitter measurement configuration menu).....	236
Gating panel (Jitter measurement configuration menu).....	237
Filter/Limit Results panel (Jitter measurement configuration menu).....	237
Pass/Fail Testing panel (Jitter measurement configuration menu).....	237
Power measurement configuration menu overview.....	238
Power Measurement Name panel (Measurement configuration menu).....	239
Configure panel (Power measurement configuration menu).....	239
Connection setup for Frequency Response Analysis (FRA) measurements.....	252
Connect to an external signal generator.....	254
Configure Profile.....	254
Power Autoset.....	255
Power Preset.....	256
SOA Mask definition controls and fields.....	256
Save Mask menu (SOA power measurement).....	257
Recall Mask menu (SOA power measurement).....	258
Reference Levels panel (Power measurement configuration Menu).....	261
Gating panel (Power measurement configuration menu).....	262
IMDA measurement configuration menu overview.....	262
IMDA Measurement Name panel (Measurement configuration menu).....	263
Source Setup panel - Motor Analysis.....	263
Configure panel (IMDA measurement configuration menu) - Motor Analysis.....	266
Connection setup for IMDA measurements.....	271
IMDA Autoset.....	274
Set modify custom limits.....	275
Reference Levels panel (IMDA measurement configuration Menu).....	276
Gating panel (IMDA measurement configuration menu).....	276
DPM measurement configuration menu overview.....	277
DPM Measurement Name panel (Measurement configuration menu).....	277
Configure panel (DPM measurement configuration menu).....	278
Reference Levels panel (DPM measurement configuration Menu).....	282
Connection setup for Digital Power Management (DPM) measurements.....	283
Power Rail Autoset.....	283
Power Rail Preset.....	284
Spectrum View Autoset.....	284
DDR measurement configuration menu overview.....	285
DDR measurement name panel (Measurement configuration menu).....	286
Configure panel (DDR measurement configuration menu).....	287

Reference Levels panel (DDR measurement configuration Menu).....	287
Gating panel (DDR measurement configuration menu).....	287
Filter/Limit results panel (DDR measurement configuration Menu).....	288
WBG-DPT measurement configuration menu overview.....	288
WBG-DPT Measurement Name panel (WBG-DPT measurement Preset menu).....	288
Configure panel (WBG-DPT measurement configuration menu).....	289
Deskew panel (WBG-DPT measurement configuration menu).....	294
Generator Setup: Configure AFG31000 Series (WBG-DPT measurement configuration menu).....	294
Connection setup for WBG-DPT measurements.....	295
Reference Levels panel (WBG-DPT measurement configuration Menu).....	295
Gating panel (WBG-DPT measurement configuration menu).....	295
Bus configuration menu.....	296
1-Wire serial bus configuration menu.....	297
8b10b serial bus configuration menu.....	298
ARINC 429 serial bus menu.....	299
Audio serial bus configuration menu.....	300
Auto Ethernet serial bus configuration menu.....	301
CAN serial bus configuration menu.....	303
CPHY serial bus configuration menu.....	305
CXPI serial bus configuration menu.....	306
DPHY serial bus configuration menu.....	307
eSPI serial bus configuration menu.....	308
Ethernet serial bus menu.....	309
EtherCAT serial bus configuration menu.....	310
eUSB serial bus configuration menu.....	311
FlexRay serial bus configuration menu.....	313
I2C serial bus configuration menu.....	314
I3C serial bus configuration menu.....	315
LIN serial bus configuration menu.....	316
Manchester serial bus configuration menu.....	317
MDIO serial bus configuration menu.....	318
MIL-STD-1553 serial bus menu.....	319
NFC serial bus configuration menu.....	320
NRZ serial bus configuration menu.....	321
Parallel Bus configuration menu.....	322
Parallel Bus - Define Inputs menu.....	323
PSI5 serial bus configuration menu.....	324
RS232 serial bus menu.....	326
SDLC serial bus configuration menu.....	327
SENT serial bus configuration menu.....	328
SMBus serial bus configuration menu.....	329
SpaceWire serial bus configuration menu.....	330
SPI serial bus configuration menu.....	331
SPMI serial bus configuration menu.....	333
SVID serial bus configuration menu.....	334
USB serial bus configuration menu.....	335
Add Plot configuration menu.....	336
Add Results Table configuration menu.....	337
Results Tables operations overview.....	337

Measurement Table configuration menu.....	338
Save As configuration menu (Measurement Results Table).....	339
Search Results table menu.....	340
Bus Decode Results table configuration menu.....	341
Save As configuration menu (Bus Decode Results table).....	342
Harmonics/Frequency Response Analysis (FRA) Results table configuration menu.....	343
Save As configuration menu, Custom Results Table.....	343
Annotation and navigation on waveform plots/data and results table.....	344
Navigation on Bar Graph and Harmonics Results Table.....	345
Peak Marker results table configuration menu.....	345
Save As configuration menu (Peak Marker results table).....	346
Search configuration menu overview.....	346
Bus Search configuration menus.....	347
1-Wire serial bus search configuration menu.....	348
8b10b serial bus search configuration menu.....	350
ARINC 429 serial bus search configuration menu.....	351
Audio serial bus search configuration menu.....	353
Auto Ethernet serial bus search configuration menu.....	354
CAN serial bus search configuration menu (when not using a .dbc symbol definition file).....	356
CAN serial bus search configuration menu (when using a .dbc symbol definition file).....	357
CAN DBC Symbolic Configuration menu.....	359
CPHY serial bus search configuration menu.....	359
CXPI serial bus search configuration menu.....	362
DPHY serial bus search configuration menu.....	363
eSPI serial bus search configuration menu.....	365
Ethernet serial bus search configuration menu.....	369
EtherCAT serial bus search configuration menu.....	371
eUSB serial bus search configuration menu.....	376
FlexRay serial bus search configuration menu.....	379
I2C serial bus search configuration menu.....	381
I3C serial bus Search configuration menu.....	382
LIN serial bus search configuration menu.....	391
Manchester serial bus search configuration menu.....	392
MDIO serial bus search configuration menu.....	394
MIL-STD-1553 serial bus search configuration menu.....	396
NFC serial bus search configuration menu.....	398
NRZ serial bus search configuration menu.....	399
Parallel bus search configuration menu.....	400
PSI5 serial bus search configuration menu.....	401
RS-232 serial bus search configuration menu.....	404
SDLC serial bus search configuration menu.....	405
SENT serial bus search configuration menu.....	408
SMBus serial bus search configuration menu.....	410
SPI serial bus search configuration menu.....	411
SPMI serial bus search configuration menu.....	412
SpaceWire serial bus search configuration menu.....	414
SVID serial bus search configuration menu.....	415
USB serial bus search configuration menu.....	416
Configure pattern editor.....	418

Edge Search configuration menu.....	419
Logic search configuration menu.....	420
Logic Search - Define Inputs configuration menu.....	422
Pulse Width Search configuration menu.....	422
Rise/Fall Time Search configuration menu.....	424
Runt Search configuration menu.....	425
Setup and Hold Search configuration menu.....	426
Setup and Hold Search - Define Inputs configuration menu.....	427
Timeout Search configuration menu.....	428
Window Search configuration menu.....	429
DDR Read Search configuration menu.....	431
DDR Write Search configuration menu.....	432
DDR Read & Write Search configuration menu.....	434
DQ/DQS Levels Configure menu.....	436
DDR Input Configure menu.....	436
Remote channel configuration menu.....	436
Analog Channel configuration menu.....	439
Invert channel guidelines.....	440
Probe Setup panel (Channel configuration menu).....	440
Unsupported Probe dialog.....	441
Probe Compensation configuration menu (analog channels Probe Setup panel).....	442
Spectrum View panel (Channel configuration menu).....	442
Other panel (Channel configuration menu).....	444
Deskew configuration menu (Other panel, Channel configuration menu).....	444
AFG configuration menu.....	445
Cursor configuration menu.....	447
Date and Time configuration menu.....	449
Digital channel configuration menu.....	449
More (DRAW A BOX Menu).....	450
DVM configuration menu.....	451
Horizontal configuration menu.....	451
Mask Badge configuration menu.....	453
Mask Definition configuration menu.....	454
Save As configuration menu (Save Mask).....	457
Right click menu functions associated with mask segments.....	458
Mask Test badge configuration menu.....	458
Right click menu functions associated with the Mask Test badge.....	459
Math configuration menu overview.....	459
Math configuration menu.....	460
Create/Edit filter configuration menu.....	462
Equation Editor (Math configuration menu).....	464
Add Filter menu (math Equation Editor).....	465
Add Variable menu (math Equation Editor).....	466
Add Functions (math Equation Editor).....	467
Menu bar overview.....	469
Recall configuration menu (File menu).....	470
Save As configuration menu (File menu).....	474
Browse Save As Location configuration menu.....	477
File Utilities configuration (File menu).....	480

Mount Drive configuration menu.....	484
Undo, Redo (Edit menu).....	486
Application (Menu bar).....	486
User Preferences (Utility menu).....	486
DDR Measurement limits file.....	491
Define Custom Colors menu.....	492
I/O (Utility menu).....	493
LAN Reset configuration menu (Utility > I/O menu).....	496
Self Test configuration menu (Utility menu).....	497
Calibration configuration menu (Utility menu).....	497
Security configuration menu for standard instruments (Utility menu).....	498
TekSecure Erase Memory.....	498
Security configuration menu.....	499
Enter Password configuration menu.....	500
Set Password configuration menu.....	501
Change Password configuration menu.....	501
Demo (Utility menu).....	502
Help... (Help menu).....	503
License Options...(Help menu).....	503
About (Help menu).....	503
Location to Save Exit Key configuration menu.....	504
Browse License Files menu (Help > About).....	505
Font Color menu (Text Settings configuration).....	506
Text Settings configuration menu (Callout and Waveform labels text).....	506
Plot configuration menus.....	507
Acq (Acquisition) Trend plot configuration menu.....	507
Bathtub plot configuration menu.....	509
BH curve configuration menu (Magnetic Analysis power measurement).....	510
Control Loop Response (Bode) plot configuration menu.....	512
Eye Diagram plot configuration menu.....	513
Fast Frame Timestamp Trend plot configuration menu.....	518
Harmonics Bar Graph plot configuration menu (IMDA).....	520
Harmonics Bar Graph plot configuration menu.....	521
Histogram plot configuration menu.....	522
Inductance Curve configuration menu (Magnetic Analysis power measurement).....	523
I vs (integral of) V plot configuration menu (Magnetic Analysis power measurement).....	524
Impedance plot configuration menu.....	524
Math FFT plot configuration menu (Math waveform).....	525
Overlapped Recovery plot configuration menu.....	528
Phasor Diagram plot configuration menu (IMDA-DQ0).....	529
Phasor Diagram plot configuration menu (IMDA-Power Quality).....	531
Phase Noise plot configuration menu.....	533
Power Supply Rejection Ratio plot configuration menu.....	534
Power plots and cursors.....	535
SOA plot configuration menu.....	535
Spectrum plot configuration menu.....	536
Time Trend plot configuration menu.....	538
Trajectory plot configuration menu (Switching Loss power measurement).....	539
Transient Response plot configuration menu.....	540



---

Trend Plot configuration menu.....	541
Plot XY configuration menu.....	542
XYZ plot configuration menu.....	543
Save As configuration menu (plot Save panel, Save Plot Image button).....	544
Save As configuration menu (plot Save panel, Save Plot Data button).....	544
Reference waveform configuration menu.....	545
Recall configuration menu (Ref waveform configuration menu).....	546
Search configuration menu.....	548
Spectrum View menus.....	548
Spectrum View window configuration menu.....	548
Selected Trace configuration menu (Spectrum View).....	551
Spectrum View Cursors menu.....	551
Magnitude Vs. Time badge menu.....	552
Frequency Vs. Time badge menu.....	552
Phase Vs. Time badge menu.....	553
Spectrum badge menu.....	554
Trigger configuration menu overview.....	556
Edge Trigger configuration menu.....	556
Video Trigger configuration menu.....	558
Bus Trigger configuration.....	561
Logic Trigger configuration menu.....	595
Logic Trigger - Define Inputs configuration menu.....	598
Pulse Width Trigger configuration menu.....	598
Rise/Fall Time Trigger configuration menu.....	600
Runt Trigger configuration menu.....	602
Sequence Trigger configuration menu.....	604
A Trigger Event configuration menu.....	606
B Trigger Event configuration menu.....	607
Setup and Hold Trigger configuration menu.....	608
Setup and Hold Trigger - Define Inputs configuration menu.....	610
Timeout Trigger configuration menu.....	610
Logic Qualification - Define Inputs configuration menu.....	612
Window Trigger configuration menu.....	612
Visual Trigger panel.....	615
Bus trigger radix-specific virtual keypads.....	615
Virtual Keyboard.....	616
Virtual Keypad.....	616
Visual Trigger Area configuration menu.....	616
Right click menu functions associated with visual trigger areas.....	618
Visual Trigger Area Combinatorial Logic menu.....	618
Waveform Histogram configuration menu.....	619
Waveform Histogram Result Badge menu.....	620
Save As configuration menu (Save Waveform Histogram).....	621
Right click menu functions associated with the Waveform Histogram.....	622
Waveform View configuration menu.....	622
Waveform acquisition.....	624
Acquisition concepts.....	624
Acquisition hardware.....	624
Sampling process.....	624



Real-Time sampling.....	624
Interpolated Real-Time sampling.....	624
Waveform record.....	624
Interpolation.....	625
Acquisition modes.....	625
Fast Frame concepts.....	626
Waveform sample interpolation.....	627
Coupling.....	627
Scaling and positioning.....	627
Vertical acquisition considerations.....	628
Horizontal acquisition considerations.....	629
Triggering concepts.....	630
Trigger sources.....	630
Trigger types.....	630
Trigger modes.....	631
Trigger holdoff.....	631
Trigger coupling.....	632
Trigger slope and level.....	632
Trigger position in waveform record.....	633
Trigger delay.....	633
Advanced triggering.....	633
Bus triggering concepts.....	633
Pulse width trigger concepts.....	634
Timeout trigger concepts.....	634
Runt trigger concepts.....	634
Window trigger.....	634
Logic trigger concepts.....	635
Setup and Hold trigger concepts.....	635
Rise/Fall time trigger concepts.....	635
Sequential (A B) trigger concepts.....	635
Visual Trigger concepts.....	636
Waveform display concepts.....	638
Waveform preview mode.....	638
Horizontal position and the horizontal reference point.....	638
Measurement concepts.....	639
Measurement variables.....	639
Missing or out-of-range samples.....	641
Math waveforms.....	641
Math waveform elements.....	642
Math waveform sources.....	643
Guidelines for working with math waveforms.....	643
Math waveform editor syntax.....	644
Math waveform differentiation.....	644
Math waveform offset, position, and scale.....	645
Waveform integration.....	645
FFT process.....	646
FFT and aliasing.....	646
Blackman-Harris FFT window concepts.....	647
Flatop2 window.....	648

---

Gaussian window.....	648
Hanning FFT window.....	649
Hamming window.....	649
Kaiser-Bessel FFT window.....	650
Rectangular window.....	650
Tek-Exponential window.....	651
User Defined Filter .....	652
Measurement algorithms.....	665
Amplitude measurement algorithms.....	665
AC RMS measurement algorithm.....	665
Area measurement algorithm.....	665
Amplitude measurement algorithm.....	665
Base measurement algorithm.....	665
Integration algorithm.....	665
Maximum measurement algorithm.....	666
Mean measurement algorithm.....	666
Minimum measurement algorithm.....	666
Negative Overshoot measurement algorithm.....	666
Positive Overshoot measurement algorithm.....	667
Peak-To-Peak measurement algorithm.....	667
RMS measurement algorithm.....	667
Top measurement algorithm.....	667
Timing measurement algorithms.....	667
Burst Width measurement algorithm.....	667
Data Rate measurement algorithm.....	667
Delay measurement algorithm.....	667
Falling slew rate.....	668
Fall Time measurement algorithm.....	668
Frequency measurement algorithm.....	669
High Time measurement algorithm.....	669
Hold Time measurement algorithm.....	669
Low Time measurement algorithm.....	669
N-Periods Duration measurement algorithm.....	670
Negative Duty Cycle measurement algorithm.....	670
Negative Pulse Width measurement algorithm.....	671
Period measurement algorithm.....	671
Phase measurement algorithm.....	671
Positive Duty Cycle measurement algorithm.....	671
Positive Pulse Width measurement algorithm.....	671
Rising Slew Rate measurement algorithm.....	671
Rise Time measurement algorithm.....	672
Setup.....	673
Skew.....	673
Time Outside Level measurement algorithm.....	673
Time to Max.....	674
Time to Min.....	674
Unit Interval measurement algorithm.....	674
Spectrum measurements algorithm.....	674
Channel Power algorithm.....	674

Adjacent Channel Power Ratio (ACPR) algorithm.....	675
Occupied Bandwidth algorithm.....	676
Spectrogram algorithm.....	677
Jitter measurement algorithms.....	677
AC Common Mode.....	677
Bit Amplitude measurement algorithm.....	678
Bit High measurement algorithm.....	678
Bit Low measurement algorithm.....	678
DC Common Mode measurement algorithm.....	678
Differential Crossover measurement algorithm.....	678
SSC Freq Dev measurement algorithm.....	678
SSC Modulation Rate measurement algorithm.....	678
TIE.....	678
T/nT Ratio measurement algorithm.....	679
DCD.....	679
DDJ.....	679
DJ.....	679
Dual Dirac deterministic jitter.....	679
F/2 measurement algorithm.....	679
F/4 measurement algorithm.....	680
F/8 measurement algorithm.....	680
J2.....	680
J9.....	680
CC-Jitter (Cycle to Cycle Jitter).....	680
Jitter Summary measurement.....	680
NPJ.....	680
Phase noise.....	680
PJ.....	681
RJ.....	681
RJ $\delta\delta$ measurement algorithm.....	681
SRJ.....	681
TJ@BER.....	681
Eye measurement algorithms.....	681
Eye Height measurement algorithm.....	681
Eye high.....	682
Eye low.....	682
Eye Width measurement algorithm.....	683
Height@BER.....	683
Q-factor.....	683
Width@BER.....	683
Power measurements: Input Analysis algorithms.....	683
Power Quality measurement algorithm.....	683
Harmonics algorithm.....	685
Input Capacitance algorithm.....	687
Inrush Current algorithm.....	688
Power measurements: Amplitude Analysis algorithms.....	688
Cycle Base measurement algorithm.....	688
Cycle Maximum measurement algorithm.....	688
Cycle Minimum measurement algorithm.....	688

Cycle Peak-to-Peak measurement algorithm.....	688
Cycle Top measurement algorithm.....	688
Cycle Amplitude measurement algorithm.....	688
Power measurements: Timing Analysis algorithms.....	689
Frequency measurement algorithm.....	689
Negative Duty Cycle measurement algorithm.....	689
Negative Pulse Width measurement algorithm.....	689
Period measurement algorithm.....	689
Positive Duty Cycle measurement algorithm.....	689
Positive Pulse Width measurement algorithm.....	689
Power measurements: Switching Analysis algorithms.....	689
Switching Loss algorithm.....	689
dv/dt algorithm.....	692
di/dt algorithm.....	693
SOA algorithm.....	693
R <sub>DS(on)</sub> algorithm.....	693
Power measurements: Magnetic Analysis algorithms.....	693
Inductance algorithm.....	694
I vs (integral of) V algorithm.....	694
Magnetic Loss algorithm.....	694
Magnetic Property algorithm.....	694
Power measurements: Output Analysis algorithms.....	696
Line Ripple algorithm.....	696
Switching Ripple algorithm.....	696
Efficiency algorithm.....	696
Turn On Time .....	697
Turn Off Time .....	697
Power measurements: Frequency Response Analysis algorithms.....	697
Control Loop Response (Bode) measurement algorithm.....	697
Power supply rejection ratio measurement algorithm.....	698
Impedance measurement algorithm.....	698
IMDA measurements: Electrical Analysis algorithms.....	698
Power Quality measurement algorithm.....	698
Harmonics measurement algorithm.....	699
Ripple Analysis algorithms.....	699
Efficiency measurement algorithm.....	699
DQ0 measurement algorithm.....	700
IMDA measurements: Mechanical Analysis algorithms.....	702
IMDA measurements: Using Hall sensors.....	702
IMDA measurements: Using QEI.....	704
IMDA measurements: Using Resolver.....	705
Torque measurement algorithm.....	706
Mechanical Power algorithm.....	706
System Efficiency algorithm.....	707
DDR Amplitude Measurement algorithms.....	708
AOS (DDR).....	708
AOS Per tCK (DDR).....	708
AOS Per UI (DDR).....	708

AUS (DDR).....	708
AUS Per tCK (DDR).....	708
AUS Per UI (DDR).....	708
Vix(ac) (DDR).....	708
DDR Time Measurement algorithms.....	708
tRPRE (DDR).....	708
tWPRE (DDR).....	708
tPST (DDR).....	709
Hold Diff (DDR).....	709
Setup Diff (DDR).....	709
tCK(avg) (DDR).....	709
tCH(avg) (DDR).....	709
tCL(avg) (DDR).....	709
tCH(abs) (DDR).....	710
tCL(abs) (DDR).....	710
tJIT(duty) (DDR).....	710
tJIT(per) (DDR).....	710
tJIT(cc) (DDR).....	711
tERR(n) (DDR).....	711
tERR(m-n) (DDR).....	711
tDQSCK (DDR).....	711
tCKSRE.....	712
tCKSRX.....	712
tCMD-CMD.....	712
DPM Power sequence analysis algorithm.....	712
Overshoot.....	712
Undershoot.....	712
DC Rail Voltage.....	712
Turn on Overshoot.....	712
DPM Ripple analysis measurement.....	712
Ripple.....	712
DPM Transient analysis measurement algorithm.....	713
Turn on time.....	713
Turn off time.....	713
DPM Power Integrity - Signal Integrity Analysis Algorithm.....	713
Power Supply Induced Jitter.....	713
WBG-DPT measurements algorithm.....	714
WBG Auto Level Determination Algorithm.....	714
WBG-DPT Deskew Algorithm.....	714
Switching Parameter Analysis Algorithms.....	717
Switching Timing Analysis Algorithms.....	718
Reverse Recovery Analysis Algorithms.....	719
Capacitance Analysis Algorithm.....	720
References.....	722
Power badge error and warning messages.....	722
DPM badge error and warning messages.....	726
User defined filter errors and warnings.....	727
WBG-DPT badge error and warning messages.....	728
Spectrum badge error and warning messages.....	729

Index..... 730

## List of Figures

Figure 1: Connecting probes to the 4 Series MSO.....	37
Figure 2: Connecting probes to the 5 Series MSO.....	37
Figure 3: Connecting probes to the MSO58LP.....	37
Figure 4: Connecting probes to the 6 Series MSO.....	38
Figure 5: Connecting SMA cables to the LPD64.....	38
Figure 6: 4 Series B MSO Controls.....	39
Figure 7: 5 Series B MSO controls.....	40
Figure 8: 6 Series B MSO controls.....	40
Figure 9: 4 Series MSO.....	45
Figure 10: 5 Series MSO.....	46
Figure 11: The time and frequency domain components of a waveform. ....	138
Figure 12: The Spectrum View window elements .....	144
Figure 13: The Spectrum View trace handle elements.....	149
Figure 14: The spectrum peak markers.....	150
Figure 15: Connection diagram for Bode measurement.....	252
Figure 16: Connection diagram for PSRR measurement.....	252
Figure 17: Connection diagram for Impedance measurement (Passive Splitter).....	253
Figure 18: Connection diagram for Impedance measurement (Active Splitter).....	253
Figure 19: 2V2I 3Phase3Wire.....	271
Figure 20: 3V3I 3Phase3Wire.....	271
Figure 21: 3V3I 3Phase4Wire.....	272
Figure 22: 1V1I 1Phase2Wire.....	272
Figure 23: 3 phase motor system, as 2V2I Efficiency measurement using 3 Phase motor setup .....	272
Figure 24: Harmonics with custom limits.....	275
Figure 25: Harmonics with custom limits.....	276
Figure 26: Connection setup for Digital Power Management (DPM) measurements.....	283
Figure 27: Phase Frequency.....	508
Figure 28: True Power.....	508
Figure 29: Vrms and Irms.....	508
Figure 30: Fall Time.....	668
Figure 31: The image shows the channel width for a given Channel Power measurement.....	675
Figure 32: The image shows the channel width, channel spacing, and adjacent channels for a given ACPR measurement..	676

Figure 33: The image shows the analysis bandwidth for a given OBW measurement..... 676

Figure 34: B-H curve..... 694

Figure 35: This transition is for 4 pole pairs motor. .... 702

Figure 36: Multi-rail example with different HSS loads (point of loads)..... 713

Figure 37: Double pulse waveform..... 714

Figure 38: Vds modelled using low  $L_{eff}$ (blue) and high  $L_{eff}$ (red) to match zero skew acquired Vds(yellow) during turn on transient..... 716

Figure 39: Vds modeled using perfectly differential order of filter at turn on transient..... 716

Figure 40: Flat model of Vds with large differential order filter at turn on transient..... 716

Figure 41: Noisy model of Vds using small differential order filter at turn on transient..... 717

Figure 42: Waveform during turn on time..... 717

Figure 43: Waveform during turn off time..... 718



---

## List of Tables

Table 1: Probe errors.....	61
Table 2: Common touchscreen UI tasks with mouse equivalents.....	68
Table 3: Spectrum View RF vs Time, Acquisition time vs Span.....	146
Table 4: 1-Wire search menu, fields, and controls.....	348
Table 5: CPHY search menu, fields, and controls.....	359
Table 6: CXPI search search menu, fields, and controls.....	362
Table 7: DPHY search menu, fields and controls.....	363
Table 8: eSPI search menu, fields, and controls.....	365
Table 9: I3C search menu, fields and controls.....	382
Table 10: MDIO search menu, fields and controls.....	394
Table 11: PSI5 search menu, fields and controls.....	401
Table 12: SVID search menu, fields and controls.....	415
Table 13: Data Pattern Editor fields and controls.....	418
Table 14: Custom Pattern Editor fields and controls.....	418
Table 15: Spectrum View panel, fields and controls.....	437
Table 16: Other panel fields and controls.....	438
Table 17: Invalid Input and Output Wiring for Efficiency measurement.....	700
Table 18: Not supported Input and Output Wiring for Efficiency measurement.....	700

# Welcome to the instrument embedded Help

This Help supports the 4 Series MSO (MSO44, MSO46), 4 Series B MSO (MSO44B, MSO46B), 5 Series MSO (MSO54, MSO56, MSO58, MSO58LP), 5 Series B MSO (MSO54B, MSO56B, MSO58B), 6 Series MSO (MSO64), 6 Series B MSO (MSO64B, MSO66B, MSO68B), and the 6 Series Low Profile Digitizer (LPD64) instruments. See the following lists for information on the key features of each instrument. Use the tabs on the left to go to specific topics or search for a topic of interest.

## MSO44B, MSO46B, MSO44, and MSO46 Key features and benefits

- Bandwidths from 200 MHz to 1.5 GHz
- 4- and 6-channel models with FlexChannel<sup>®</sup> inputs
- Each FlexChannel input is dual-purpose, letting you connect either an analog probe (TekVPI<sup>®</sup> or BNC) or an eight-channel digital probe (the TLP058 FlexChannel Logic Probe)
- Each FlexChannel can display 8 digital channels (with TLP058), an analog waveform, a spectrum trace, or both an analog and spectral view of the same channel at the same time with independent controls for each view
- Large 13.3" HD (1920 x 1080 pixel) capacitive touch-screen display
- User interface optimized for touch screen use
- Maximum 6.25 GS/s sample rate
- 31.25 M points record length on all channels (optional 62.5 M record length available)
- 500,000 waveforms/second capture rate
- Cursors analysis: Waveform, V Bars, H Bars, V&H Bars, Multi source cursor (readouts)
- Spectrum View enables simple, intuitive frequency domain analysis, independent of time domain controls, to show a spectral trace for each channel
- FastFrame<sup>™</sup> segmented memory acquisition uses multiple trigger events to capture widely spaced events of interest at high sample rates while conserving acquisition memory
- No set limit on the number of math, reference, and bus waveforms you can display (the number of waveforms depends on available system memory)
- Integrated options include a 50 MHz arbitrary/function generator (AFG), and a Digital Voltmeter (DVM) and trigger frequency counter
- Advanced serial bus triggering and analysis options let you decode and trigger on industry standard buses. See the Serial bus and trigger options Help topic
- Power and 3-Phase options provide additional measurement and analysis functions. See the Advanced Power Analysis option Help topics. 3-Phase is available only on MSO46.

## MSO54, MSO56, MSO58 Key features and benefits

- Bandwidths from 350 MHz to 2 GHz
- 4-, 6-, and 8-channel models with FlexChannel<sup>®</sup> inputs
- Each FlexChannel input is dual-purpose, letting you connect either an analog probe (TekVPI<sup>®</sup> or BNC) or an eight-channel digital probe (the TLP058 FlexChannel Logic Probe)
- Each FlexChannel can display 8 digital channels (with TLP058), an analog waveform, a spectrum trace, or both an analog and spectral view of the same channel at the same time with independent controls for each view
- Large 15.6" HD (1920 x 1080 pixel) capacitive touch-screen display
- User interface optimized for touch screen use
- Maximum 6.25 GS/s sample rate
- 62.5 M points record length on all channels (optional 125, 250, 500 M record length available)
- 500,000 waveforms/second maximum waveform capture rate
- Cursors analysis: Waveform, V Bars, H Bars, V&H Bars, Multi source cursor (readouts)

- Spectrum View enables simple, intuitive frequency domain analysis, independent of time domain controls, to show a spectral trace for each channel
- FastFrame™ segmented memory acquisition uses multiple trigger events to capture widely spaced events of interest at high sample rates while conserving acquisition memory
- No set limit on the number of math, reference, and bus waveforms you can display (the number of waveforms depends on available system memory)
- Integrated options include a 50 MHz arbitrary/function generator (AFG), and a Digital Voltmeter (DVM) and trigger frequency counter
- Automated compliance testing solutions add compliance measurement features. <sup>1</sup> See the *Compliance Testing options* Help topic
- Advanced serial bus triggering and analysis options let you decode and trigger on industry standard buses. See the *Serial bus and trigger options* Help topic
- Power, WBG-DPT, Spectrum measurements, DPM, IMDA, and Jitter options provide additional measurement and analysis functions. See the *Advanced Power Analysis*, *DPM Analysis*, and *Advanced Jitter Analysis* Help topics. IMDA application is available on MSO56 and MSO58 only.

### MSO54B, MSO56B, and MSO58B Key features and benefits

- Bandwidths from 350 MHz to 2 GHz
- 4, 6, or 8 channels with FlexChannel® inputs
- Each FlexChannel input is dual-purpose, letting you connect either an analog probe (TekVPI® or BNC) or an eight-channel digital probe (the TLP058 FlexChannel Logic Probe)
- Each FlexChannel can display 8 digital channels (with TLP058), an analog waveform, a spectrum view, or both an analog and spectral view of the same channel at the same time with independent controls for each view
- FlexChannel inputs are compatible with TekVPI® probes
- Large 15.6" HD (1920 x 1080 pixel) capacitive touch-screen display
- User interface designed to optimize touch screen use and quickly access key settings
- Stacked mode places each channel or waveform in its own horizontal 'slice' on the screen, allowing for cleaner signal viewing and measuring
- Maximum 6.25 GS/s sample rate
- 62.5 M points record length on all channels (optional 125 M, 250 M, and 500 M record lengths available)
- >500,000 waveforms/second maximum waveform capture rate
- Cursors analysis: Waveform, V Bars, H Bars, V&H Bars, Multi source cursor (readouts)
- Spectrum View enables simple, intuitive frequency domain analysis, independent of time domain controls, to show a spectral trace for each channel
- No set limit on the number of math, reference, and bus waveforms you can display (the number of waveforms depends on available system memory)
- Integrated optional features include a 100 MHz arbitrary function generator (AFG), and a DVM and trigger frequency counter
- Optional serial triggering features enable you to isolate protocol-level events of interest in common aerospace, audio, automotive, computer, and embedded serial buses. See the *Serial bus and trigger options* topic in the instrument Help, or the *Serial Triggering and Analysis Applications Datasheet* (Tektronix part number 48W-61353-X) for more information.
- Power, DPM, Spectrum measurements, IMDA, and Jitter options provide additional measurement and analysis functions. See the *Advanced Power Analysis*, *DPM Analysis*, and *Advanced Jitter Analysis* Help topics. IMDA application is available on MSO56B and MSO58B only.

### MSO58LP Key features and benefits

- Low profile instrument with no display, comes ready to install in a 2U rack mount space

---

<sup>1</sup> Compliance testing options require the optional Microsoft Windows 10 operating system.

- 1 GHz bandwidth
- 8 channels with FlexChannel® inputs
- Each FlexChannel input is dual-purpose, letting you connect either an analog probe (TekVPI® or BNC) or an eight-channel digital probe (the TLP058 FlexChannel Logic Probe)
- Each FlexChannel can display 8 digital channels (with TLP058), an analog waveform, a spectrum trace, or both an analog and spectral view of the same channel at the same time with independent controls for each view
- Maximum 6.25 GS/s sample rate
- 125 M points record length on all channels (optional 250, 500 M record length available)
- 500,000 waveforms/second maximum waveform capture rate
- Cursors analysis: Waveform, V Bars, H Bars, V&H Bars, Multi source cursor (readouts)
- Spectrum View enables simple, intuitive frequency domain analysis, independent of time domain controls, to show a spectral trace for each channel
- FastFrame™ segmented memory acquisition uses multiple trigger events to capture widely spaced events of interest at high sample rates while conserving acquisition memory
- No set limit on the number of math, reference, and bus waveforms you can acquire (the number of waveforms depends on available system memory)
- Integrated options include a 50 MHz arbitrary/function generator (AFG), and a Digital Voltmeter (DVM) and trigger frequency counter
- Advanced serial bus triggering and analysis options let you decode and trigger on industry standard buses. See the *Serial bus and trigger options* Help topic
- Power, WBG-DPT, Spectrum measurements, DPM, IMDA, and Jitter options provide additional measurement and analysis functions. See the *Advanced Power Analysis, DPM Analysis, and Advanced Jitter Analysis* Help topics.

## MSO64 Key features and benefits

- 4 channels with FlexChannel® inputs
- Bandwidths from 1 GHz to 8 GHz
- Each FlexChannel input is dual-purpose, letting you connect either an analog probe (TekVPI® or BNC) or an eight-channel digital probe (the TLP058 FlexChannel Logic Probe)
- Each FlexChannel can display 8 digital channels (with TLP058), an analog waveform, a spectrum trace, or both an analog and spectral view of the same channel at the same time with independent controls for each view
- Large 15.6" HD (1920 x 1080 pixel) capacitive touch-screen display
- User interface optimized for touch screen use
- Maximum 25 GS/s sample rate
- 62.5 M points record length on all channels (optional 125 M, 250 M, 500 M, and 1 G record lengths available)
- 500,000 waveforms/second maximum waveform capture rate
- Cursors analysis: Waveform, V Bars, H Bars, V&H Bars, Multi source cursor (readouts)
- Spectrum View enables simple, intuitive frequency domain analysis, independent of time domain controls, to show a spectral trace for each channel
- FastFrame™ segmented memory acquisition uses multiple trigger events to capture widely spaced events of interest at high sample rates while conserving acquisition memory
- No set limit on the number of math, reference, and bus waveforms you can display (the number of waveforms depends on available system memory)
- Integrated options include a 50 MHz arbitrary/function generator (AFG), and a Digital Voltmeter (DVM) and trigger frequency counter
- Advanced serial bus triggering and analysis options let you decode and trigger on industry standard buses. See the *Serial bus and trigger options* Help topic

- Power, DPM, Spectrum measurements, and Jitter options provide additional measurement and analysis functions. See the *Advanced Power Analysis*, *DPM Analysis*, and *Advanced Jitter Analysis* Help topics.

## MSO64B, MSO66B, and MSO68B Key features and benefits

- Bandwidths from 1 GHz to 10 GHz
- 4, 6, or 8 channels with FlexChannel<sup>®</sup> inputs
- Each FlexChannel input is dual-purpose, letting you connect either an analog probe (TekVPI<sup>®</sup> or BNC) or an eight-channel digital probe (the TLP058 FlexChannel Logic Probe)
- Each FlexChannel can display 8 digital channels (with TLP058), an analog waveform, a spectrum view, or both an analog and spectral view of the same channel at the same time with independent controls for each view
- FlexChannel inputs are compatible with TekVPI<sup>®</sup> probes
- Large 15.6" HD (1920 x 1080 pixel) capacitive touch-screen display
- User interface designed to optimize touch screen use and quickly access key settings
- Stacked mode places each channel or waveform in its own horizontal 'slice' on the screen, allowing for cleaner signal viewing and measuring
- Maximum 50 GS/s sample rate
- 62.5 M points record length on all channels (optional 125 M, 250 M, 500 M, and 1 G record lengths available)
- >500,000 waveforms/second maximum waveform capture rate
- Cursors analysis: Waveform, V Bars, H Bars, V&H Bars, Multi source cursor (readouts)
- Spectrum View enables simple, intuitive frequency domain analysis, independent of time domain controls, to show a spectral trace for each channel
- No set limit on the number of math, reference, and bus waveforms you can display (the number of waveforms depends on available system memory)
- Integrated optional features include a 50 MHz arbitrary function generator (AFG), and a DVM and trigger frequency counter
- Optional serial triggering features enable you to isolate protocol-level events of interest in common aerospace, audio, automotive, computer, and embedded serial buses. See the *Serial bus and trigger options* topic in the instrument embedded Help, or the *6 Series MSO Serial Triggering and Analysis Applications Datasheet* (Tektronix part number 48W-61353-x) for more information
- Power, DPM, WBG-DPT, Spectrum measurements, IMDA, and Jitter options provide additional measurement and analysis functions. See the *Advanced Power Analysis*, *DPM Analysis*, and *Advanced Jitter Analysis* Help topics. IMDA application is available on MSO66B and MSO68B only.

## LPD64 Key features and benefits

- Low profile instrument with no display, comes ready to install in a 2U rack mount space
- 4 channels with 50  $\Omega$  SMA inputs
- 1, 2.5, 4, 6, and 8 GHz bandwidths on all channels
- Maximum 25 GS/s sample rate on all channels
- 125 M points record length on all channels (optional 250 M points, 500 M points, 1 G points)
- 12 bits A/D resolution
- Lowest-in-class noise
- Highest-in-class ENOB (8.2 bits at 1 GHz)
- 500,000 waveforms/second maximum waveform capture rate
- Cursors analysis: Waveform, V Bars, H Bars, V&H Bars, Multi source cursor (readouts)
- No set limit on the number of math, reference, and bus waveforms you can create (the number of waveforms depends on available system memory)

- Spectrum View enables simple, intuitive frequency domain analysis, independent of time domain controls, to show a spectral trace for each channel
- Real-Time 2 GHz DDC for RF bandwidth
- FastFrame™ segmented memory acquisition uses multiple trigger events to capture widely spaced events of interest at high sample rates while conserving acquisition memory
- Integrated options include a 50 MHz arbitrary/function generator (AFG), and a Digital Voltmeter (DVM) and trigger frequency counter
- Advanced serial bus triggering and analysis options let you decode and trigger on industry standard buses. See the *Serial bus and trigger options* Help topic
- Power, WBG-DPT, Spectrum measurements, DPM, and Jitter options provide additional measurement and analysis functions. See the *Advanced Power Analysis*, *DPM Analysis*, and *Advanced Jitter Analysis* Help topics

4/5/6 Series MSO Help, version 20231108-10:00 for Firmware v2.6 and above.

## TEKTRONIX END USER LICENSE AGREEMENT

Go to [www.tek.com/terms\\_and\\_conditions](http://www.tek.com/terms_and_conditions) to read the Tektronix End User License Agreement.



## Open Source GPL License Notice

For programs licensed under the "GNU General Public License (GPL) or Lesser GNU General Public License (LGPL)" the complete corresponding sources are available. You can order a CD containing the sources from us for a period of three years after download of the software, by sending a written request to:

Chief Intellectual Property Counsel, Tektronix, Inc.

MS 50/LAW

14150 SW Karl Braun Dr.

Beaverton OR, 97077

This offer is valid to anyone in receipt of this information.

Your request should include: (i) the name of the product, (ii) your (company) name, and (iii) your return mailing and email address (if available).

Please note that we may charge you a fee to cover the cost of performing this distribution.

## Product support and feedback

Tektronix values your feedback on our products. To help us serve you better, please send us your suggestions, ideas, or comments on your instrument, application, or product documentation.

Contact through mail, telephone, or [tek.com](http://tek.com).

When you contact Tektronix Technical Support, please include the following information (be as specific as possible):

### General information

- All instrument model numbers
- Hardware options, if any
- Probes used
- Your name, company, mailing address, phone number, and FAX number
- Please indicate if you would like to be contacted by Tektronix about your suggestion or comments.

### Application specific information

- Software version number
- Description of the problem such that technical support can duplicate the problem
- If possible, save and send the setup files for all the instruments used and the application
- If possible, save and send status messages text files
- If possible, save and send the waveform on which you are performing the measurement as a .wfm file

## Documentation

Review the following user documents before installing and using your instrument. These documents provide important operating information.

### Product documentation

The following table lists the primary product specific documentation available for your product. These and other user documents are available for download from [tek.com](http://tek.com). Other information, such as demonstration guides, technical briefs, and application notes, can also be found at [tek.com](http://tek.com).

Document	Content
Installation and Safety Instructions	Safety, compliance, and basic introductory information for hardware products.
Help	In-depth operating information for the product. Available from the Help button in the product UI and as a PDF on <a href="http://tek.com">tek.com</a> .
Quick Start User Manual	Introduction to product hardware and software, installation instructions, turn on, and basic operating information.
User Manual	In-depth operating information for the product.
Specifications and Performance Verification Technical Reference	Instrument specifications and performance verification instructions for testing instrument performance.
Programmer Manual	Commands for remotely controlling the instrument.
Declassification and Security Instructions	Information about the location of memory in the instrument. Instructions for declassifying and sanitizing the instrument.
Service Manual	Replaceable parts list, theory of operations, and repair and replace procedures for servicing an instrument.
Upgrade Instructions	Product upgrade installation information.
Rackmount Kit Instructions	Installation information for assembling and mounting an instrument using a specific rackmount.

## How to find your product documentation

1. Go to [tek.com](http://tek.com).
2. Click **Download** in the green sidebar on the right side of the screen.
3. Select **Manuals** as the Download Type, enter your product model, and click **Search**.
4. View and download your product manuals. You can also click the Product Support Center and Learning Center links on the page for more documentation.



# Options

Some features described in this Help system are not supported by all product families, models, or configurations. Please refer to the datasheet for your specific product at [tek.com](http://tek.com) to see which features it supports.

## Install option upgrade licenses

Option license upgrades are field-installable licenses that you can purchase after receiving your instrument, to add features to your oscilloscope. You install option upgrades by installing license files on the oscilloscope. Each option requires a separate license file.

### Before you begin

These instructions do not pertain to options that were purchased and pre-installed on your instrument when ordered.

A node-locked license is valid only for the specific model number and serial number of the instrument for which it was purchased; it will not work on any other instrument. The single license file does not affect options that were factory installed or any other upgrades that you may have already purchased and installed.

A floating license enables you to install an upgrade options on any equivalent instrument, but only one instrument at a time can use the license. You must uninstall a floating license from one instrument, and log it back into the Tektronix AMS, before checking it out for use on another instrument. Access the Tektronix AMS at [www.tek.com/products/product-license](http://www.tek.com/products/product-license).

To access the user interface on a Low Profile instrument, connect a monitor to a video port on the rear of the instrument, and connect a mouse to any USB Host port. You do not need to connect a mouse if your remote monitor is touch-capable. You can also remotely access the user interface of a network-connected instrument by entering the instrument's IP address in a web browser.

### About this task

**Note:** You can only install a Node Locked option license one time. If you need to reinstall an uninstalled Node Locked license, contact Tektronix Customer Support.



These instructions only support options that are enabled by installing a software license. Some product upgrades, such as the 5/6 Series MSO SSD upgrades (Embedded OS or Microsoft Windows 10) and 5 Series MSO bandwidth upgrades to 2 GHz, are not supported by this document. These upgrades either have their own installation instructions, or require that you send the instrument to a Tektronix support center for new hardware and calibration.

### Procedure

1. Follow the instructions you received to download the upgrade license file (<filename>.lic).
2. Copy the license file or files to a USB memory device.
3. Insert the USB drive into the powered-on oscilloscope for which the upgrade was purchased.
4. Select **Help > About**.
5. Select **Install License** to open the Browse License Files dialog box.
6. Find and select the upgrade license file to install.
7. Select **Open**. The oscilloscope installs the license and returns to the About screen. Verify that the installed license was added to the Installed Options list.
8. Repeat steps 5 through 7 for each upgrade license file that you purchased and downloaded.
9. Power cycle the oscilloscope to enable the installed upgrades.
10. If you installed a bandwidth upgrade, rerun signal path compensation (SPC). Then carefully remove the model/bandwidth label from the lower-left corner of the front panel and install the new model/bandwidth label that was sent through normal mail channels as part of the upgrade purchase.

---

## Uninstall (return) an option license

Use this process to uninstall (return) a Node Locked or Floating option license.

### Before you begin

To access the user interface on a Low Profile instrument, connect a monitor to a video port on the rear of the instrument, and connect a mouse to any USB Host port. You do not need to connect a mouse if your remote monitor is touch-capable. You can also remotely access the user interface of a network-connected instrument by entering the instrument's IP address in a web browser.

Floating licenses can be used on any compatible instrument, but can only be checked out to use on one instrument at a time. This process removes the option license from the instrument so that you can check (return) it back into the Tektronix TekAMS system.

When you check out an option Floating license from your TekAMS account, you stipulate a time period for which the option license can be used. When the license expiration time is close, the instrument shows warning messages at 72 hours, 24 hours, and 1 hour prior to the expiration date.

At the expiration time, the TekAMS account automatically sets the license as available. The instrument gives you a four-hour grace period.

If you do nothing, the instrument automatically deactivates the license after the grace period expires and restarts the TekScope application (on instruments with Windows OS installed) or performs a warm reboot (base instrument). You should uninstall (return) the license key file before the expiration date to prevent a power cycle and possible disruption of measurements.

### About this task



**Note:** If you uninstall a Node Locked option license, you cannot reinstall the license using the same file used to install it. If you need to reinstall an uninstalled Node Locked option, contact Tektronix Customer Support to obtain a new option license file.

### Procedure

1. Insert a USB memory stick or device in an available USB port.
2. Select **Help > About**.
3. Tap the option license in the list that you want to uninstall (return to your Tektronix AMS account).
4. Tap the **Return License** button.  
The oscilloscope opens the **Location to Save the Exit Key** menu.
5. Navigate to and select the location at which to save the license key uninstall file.
  - For an instrument not connected to the internet, or installed in a secure environment, save the license file to a USB memory device connected to the instrument. See the table at the end of this procedure for USB port names.
  - For an instrument with the Microsoft Windows 10 OS option that is connected to the internet, you can save the uninstall key file to a location on the instrument SSD drive or to a network drive.
6. Tap **Create**. The oscilloscope saves the license key file to the specified location and removes the license from the Installed Options list.
7. Power cycle the oscilloscope before taking any measurements.
8. From a PC with the license file USB memory device attached, or from a browser on an instrument connected to the internet, access the Tektronix AMS Web site. The site path was provided when you purchased the license and created a Tektronix AMS account.
9. Use the Tektronix AMS site to select and return the license key file to your Tektronix AMS account.

## Drive names for system and USB memory devices

Use the following table to determine which drive to select when navigating to and/or selecting a file on system memory or a connected USB memory device.

Drive name	Drive letter	Drive or physical USB port location
<b>MSO44B and MSO46B</b>		
Root drive	C	User-accessible memory on the oscilloscope.
Front panel	E	USB 2.0 (top)
	F	USB 2.0 (middle)
	G	USB 2.0 (bottom)
Rear panel	H	USB 3.0 (left)
	I	USB 3.0 (right)

Drive name	Drive letter	Drive or physical USB port location
<b>MSO44 and MSO46</b>		
Root drive	C	User-accessible memory on the oscilloscope.
Front panel	E	USB 2.0 (top)
	F	USB 2.0 (middle)
	G	USB 2.0 (bottom)
Rear panel	H	USB 2.0 (left)
	I	USB 2.0 (right)

Drive name	Drive letter	Drive or physical USB port location
<b>MSO54, MSO56, MSO58, MSO54B, MSO56B, MSO58B, MSO64, LPD64, MSO64B, MSO66B, and MSO68B without Windows OS</b>		
Root drive	C	User-accessible memory on the oscilloscope.
Front panel	E	USB 3.0 (left)
	F	USB 2.0 (center)
	G	USB 2.0 (right)
Rear panel	H	USB 2.0 (top)
	I	USB 2.0 (bottom)
	J	USB 3.0 (top)
	K	USB 3.0 (bottom)
<b>Instruments with Windows OS</b>		
Root drive	C	User-accessible memory on the oscilloscope.
USB ports	<b>Dynamic port letter assignment</b>	If Windows operating system is installed, the Windows operating system assigns the first available drive letter (typically E:) to the first USB device attached to the oscilloscope, regardless of which port the USB device is plugged into. The next plugged-in USB device is assigned the next available drive letter (such as F:) and so on for other installed devices.  Use standard Windows procedures to mount and access network drives.

Drive name	Drive letter	Drive or physical USB port location
<b>MSO58LP without Windows OS</b>		
Table continued...		

Drive name	Drive letter	Drive or physical USB port location
Root drive	C	User-accessible memory on the oscilloscope.
Front panel	E	USB 3.0 (left)
	F	USB 2.0 (right)
Rear panel	G	USB 2.0 (top)
	H	USB 2.0 (bottom)
	I	USB 3.0 (top)
	J	USB 3.0 (bottom)
<b>Instruments with Windows OS</b>		
Root drive	C	User-accessible memory on the oscilloscope.
USB ports	<b>Dynamic port letter assignment</b>	<p>If Windows operating system is installed, the Windows operating system assigns the first available drive letter (typically E:) to the first USB device attached to the oscilloscope, regardless of which port the USB device is plugged into. The next plugged-in USB device is assigned the next available drive letter (such as F:) and so on for other installed devices.</p> <p>Use standard Windows procedures to mount and access network drives.</p>

Drive name	Drive letter	Drive or physical USB port location
<b>LPD64 without Windows OS</b>		
Root drive	C	User-accessible memory on the oscilloscope.
Front panel	F	USB 3.0 (left)
	E	USB 2.0 (center)
	G	USB 2.0 (right)
Rear panel	H	USB 2.0 (top)
	I	USB 2.0 (bottom)
	J	USB 3.0 (top)
	K	USB 3.0 (bottom)

# Getting acquainted with your instrument

The following content provides a high-level description of the instrument controls and user interface.

## Installing and activating Windows 10 operating system

Use the following instructions to install the embedded operating system solid state drive or to install and activate Windows 10 on the instrument.



**Note:** The Windows option is not available for the 4 Series MSO or MSO58LP instruments.

## Install the SSD

The optional SSD assembly installs in the bottom of the instrument. To remove a previously installed SSD, reverse these steps. Contact your nearest Tektronix, Inc., Service Center or Tektronix Factory Service if you need any installation assistance.

**Prerequisite:** Wear an anti-static wrist strap connected to the instrument chassis while installing this drive.

1. Remove all cables from the front and rear of the instrument, including the power cable.
2. Position the instrument on its back, with the bottom facing you.
3. Remove the SSD cover from the bottom of the oscilloscope as shown.



4. Slide the connector end of the SSD into the drive connector bracket. Push firmly to seat the drive in the connector.



5. Push down on and tighten the thumb screw to attach the SSD to the chassis.
6. Reinstall the SSD cover on the bottom of the instrument.
7. Restore the instrument to its normal operating position.



**Note:** After installing a Windows SSD, go to the [Powering on Windows for the first time](#) on page 34 and [Activating Windows](#) on page 34 procedures. These procedures do not apply when installing the SUPx-LNX options.

## Powering on Windows for the first time

The instrument goes through a series of configuration boot-ups that require manual intervention when first powering up a new (never-installed) Windows drive in an instrument. Once the drive is configured, the instrument boots into Windows and starts the oscilloscope application from then on.

1. Power on the instrument. The oscilloscope powers up to initialize some settings, then shuts down.
2. Power on the instrument again. The instrument powers up into the application start-up screen, then displays a message at the bottom of the screen:

**Updating System Files... This will take a few minutes.**

**The oscilloscope will shut down when the update is complete.**

After a few minutes, the instrument powers down.

3. Power on the instrument again. The instrument boots-up into Windows and starts the oscilloscope application.

The instrument attempts to activate the Windows license as part of the initial power-on process (See [Activating Windows](#) on page 34).

## Activating Windows

The Windows operating system shipped from Tektronix is in a "deferred activation" state. The first time you power on an instrument with a newly installed Windows drive, the operating system may attempt to activate itself, depending on whether the instrument is connected to a network.

- The instrument is connected to a network with access to the Microsoft web site:
  - The Windows activation occurs silently in the background, and does not display any messages. No other action is required.
  - See [Verifying Windows activation](#) on page 35 to check the activation status of the instrument.
- The instrument is connected to a network without access to the Microsoft web site:

- The instrument may attempt to activate and fail. You may see a screen message saying that Windows is not activated and the Windows user settings may be disabled.
- See [Verifying Windows activation](#) on page 35 to check the activation status of the instrument.
- You can activate Windows by either connecting the instrument to a network with access to Microsoft or by contacting Microsoft to obtain activation instructions:
  - Go to <https://support.microsoft.com/en-us> and select **Windows**.
  - Go to <https://support.microsoft.com/en-us/contactus/> and follow the instructions to select your preferred contact method.



**Note:** Please contact Microsoft to resolve Windows activation issues.

- The instrument is not connected to any network:
  - The instrument stays in the "deferred activation" state. No error message appears. Windows, and the oscilloscope application, can operate indefinitely in the deferred activation state without error messages.
  - See [Verifying Windows activation](#) on page 35 to check the activation status of the instrument.
  - Once you connect the instrument to a network with access to Microsoft, Windows will activate automatically (no interaction required).
- Moving an activated Windows SSD from one instrument to another:
  - Windows should remain activated. To verify activation, see [Verifying Windows activation](#) on page 35. If Windows lost activation when installed on the current instrument, follow the above instructions to re-activate.

## Verifying Windows activation

To check that Windows is activated:

1. Tap **Start** on the Windows taskbar.
2. Scroll down and tap **Settings**.
3. Tap **Update & Security**.
4. Tap **Activation** (left side list) to display the activation status.

## Recovering Windows System Image

This procedure is outlined in the section labeled "Restoring a Windows SSD" in the "Opt. SUP5-WIN, SUP6-WIN, SUP6B-WIN, SUP6B-LNX Upgrade Kit Installation Instructions" which can be found at [download.tek.com/manual/5-6-MSO-Option-WIN\\_LNX-Install-Instructions-071352402.pdf](http://download.tek.com/manual/5-6-MSO-Option-WIN_LNX-Install-Instructions-071352402.pdf)

## Windows update

Automatic Windows update is disabled by default.

## Differences between Windows and base instrument user interfaces

The Windows-based oscilloscope application interface appearance and behavior is exactly the same as the base instruments, with some exceptions:

- You can change the size of the Windows-based oscilloscope application, or minimize it, just like any other Windows application.
- The File Utilities choice in the File menu opens a standard Windows Explorer instance instead of the custom dialog found in the base instrument.
- You can use the standard Windows network tools to mount and access network drives.
- You can use the standard Windows tools to create a login password to access the instrument, if required by your organization.

- You can use the Application menu to access installed applications.

## Updating the Windows TekScope application software

The Windows TekScope application does not automatically update when newer versions are released. You will need to manually download and install the newer software. The oscilloscope application cannot be running when installing the software.

To update the Windows version of the oscilloscope application software:

### Instrument is connected to a network:

1. Display the Windows desktop and open a browser.
2. Go to [www.tek.com/product-support](http://www.tek.com/product-support).
3. Enter your model number in the **Enter Product or Product Series Name:** field and click **Go**.
4. Click the **Software** tab (left side of table).
5. Click the link in the description that pertains to your instrument model or series, and select the software that applies for Windows instruments.
6. Check that the listed software is newer than your current installed software before downloading and installing.
7. Follow instructions to download the application file.
8. Click on the install instructions link to open the installation instructions.

### Instrument is not connected to a network:

Follow the above instructions on a network-connected PC,

1. Open a browser on a network-connected PC or laptop.
2. Do steps 2 on page 36 through 7 on page 36 above.
3. Download the installation file to a USB memory device and insert the USB memory device in any USB Host port on the instrument.
4. Open the USB drive location.
5. Double-tap on the installation file to update the application software; follow any on-screen instructions.

## Secure (lock) the instrument

Lock an instrument to a test bench or equipment rack to prevent property loss.

To secure the instrument to a workbench, rack, or other location, attach a standard laptop security lock to the rear panel of the instrument.

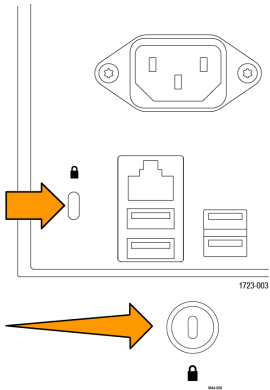



## Connecting probes or signals to the instrument

Probes connect the instrument to your device under test (DUT). Use a probe or cable that best matches your signal measurement needs.

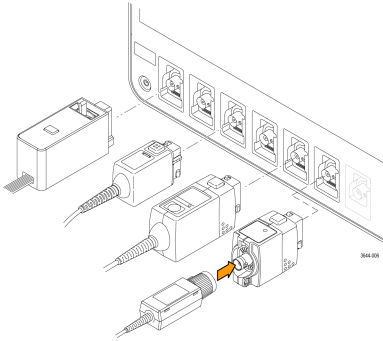

Figure 1: Connecting probes to the 4 Series MSO

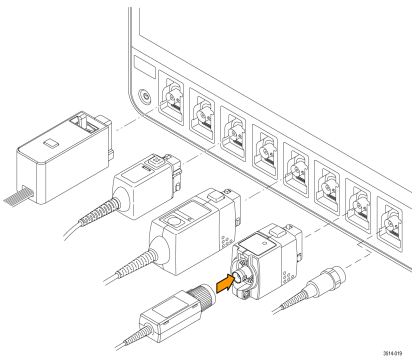

Figure 2: Connecting probes to the 5 Series MSO

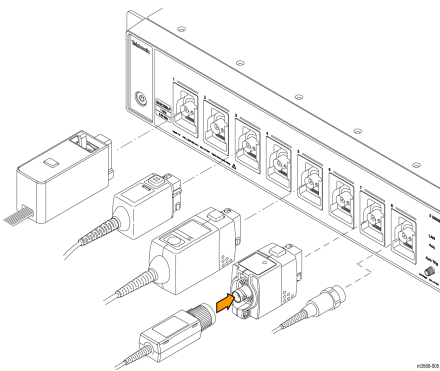

Figure 3: Connecting probes to the MSO58LP

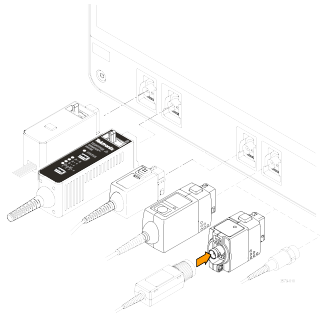

Figure 4: Connecting probes to the 6 Series MSO

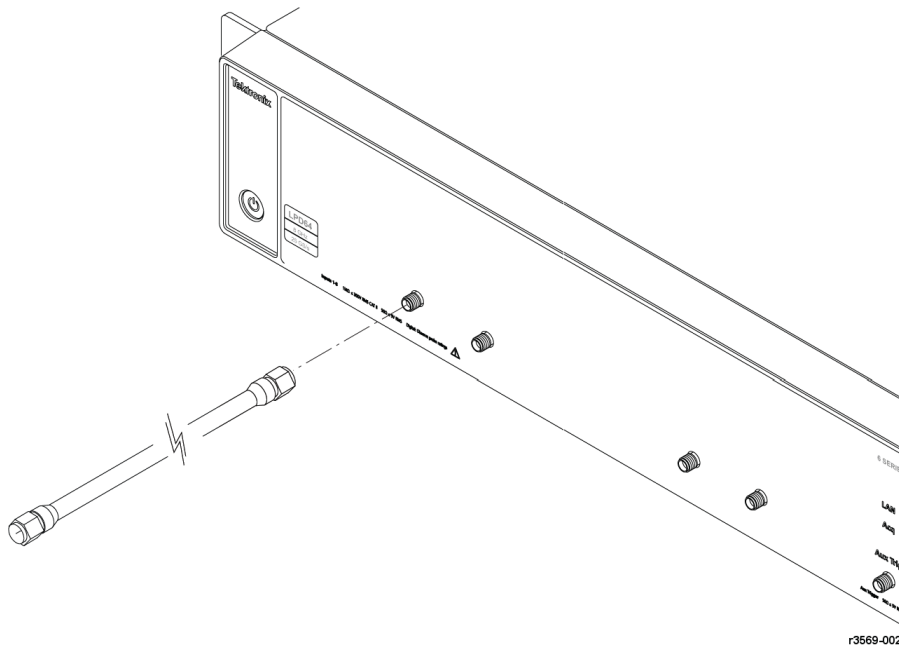

Figure 5: Connecting SMA cables to the LPD64

## Connecting Probes (all instruments except LPD64)

Connect TPP Series, TekVPI+, TekVPI, or other supported Tektronix analog probes by pushing them into a FlexChannel connector. The probe base latch locks with a 'click' when the probe is fully seated.

TekVPI probes automatically set the channel input parameters for that probe (bandwidth, attenuation, termination, and so on). If a probe has a **Menu** button, push that button to open an on-screen configuration menu. Follow instructions provided with active probes to set their parameters (auto zero, degauss, and so on).

To connect a TLP058 FlexChannel Logic Probe or a TDP7700 Series TriMode™ Probe:

1. Move the locking lever to the unlocked position, then let go to reset locking lever to the center position.
2. Insert the probe into a FlexChannel connector until fully seated and the lock mechanism clicks.
3. Move the locking lever to the locked position. The status light should be a solid green.
4. To disconnect the TLP058 probe, move and hold the locking lever at the unlocked position and pull out the probe. Do not pull on the ribbon cable while removing the probe.

Connect a BNC probe or cable by pushing it onto a channel BNC bayonet connector and turn the lock mechanism clockwise until it locks.



**Note:** Connecting a probe does not automatically enable that channel (make it active). Use the instrument controls or programmatic interface to turn on a channel and open its configuration menu to verify or change probe or cable settings (bandwidth, attenuation, termination and so on).

## Connecting SMA cables (LPD64)

Connect SMA cables to the instrument. Hand tighten, then torque the cable connectors to 56 N-cm (5 in-lb).

## Rackmount option information

An optional rackmount kit lets you install the oscilloscope in standard equipment racks.

Please refer to the product datasheet at [tek.com](http://tek.com) for information on rackmount options.

## Bench conversion kit information for Low Profile instruments

The Low Profile instruments (MSO58LP and LPD64) come equipped with rackmount hardware installed so that you can immediately add them to a rack. You can also order a kit to convert them for bench use.

To use a Low Profile instrument on a bench, purchase and install the 5 Series MSO MSO58LP/6 Series Low Profile Digitizer LPD64 Benchtop Conversion kit (Tektronix part number 020-3180-xx). The kit includes chassis feet and a handle, and lets you stack Low Profile instruments on a bench.

## Front panel controls and connectors

The front panel controls provide direct access to key instrument settings such as vertical, horizontal, trigger, cursors, and zoom. The connectors are where you input signals with probes or cables, or insert USB devices.

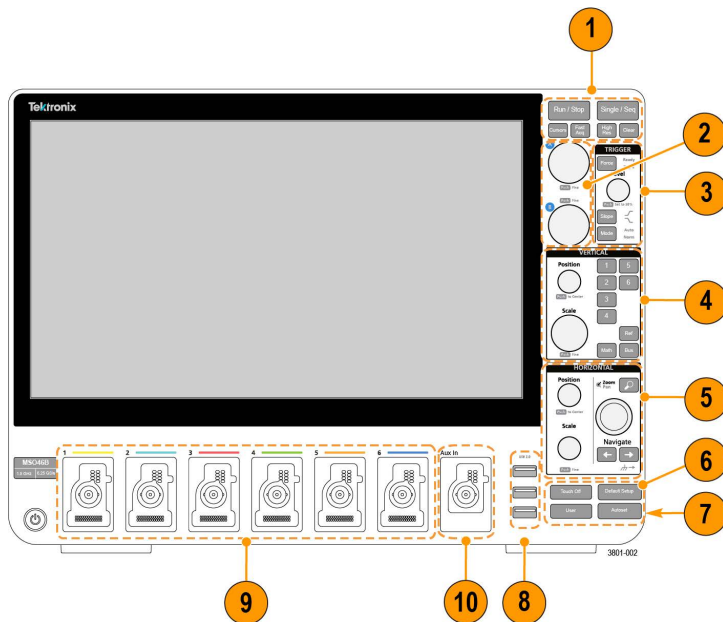

Figure 6: 4 Series B MSO Controls

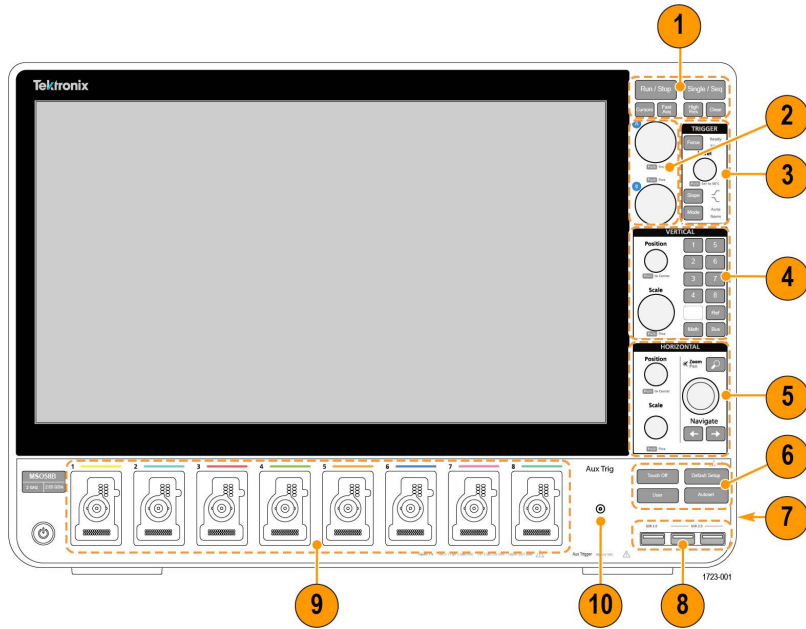

Figure 7: 5 Series B MSO controls

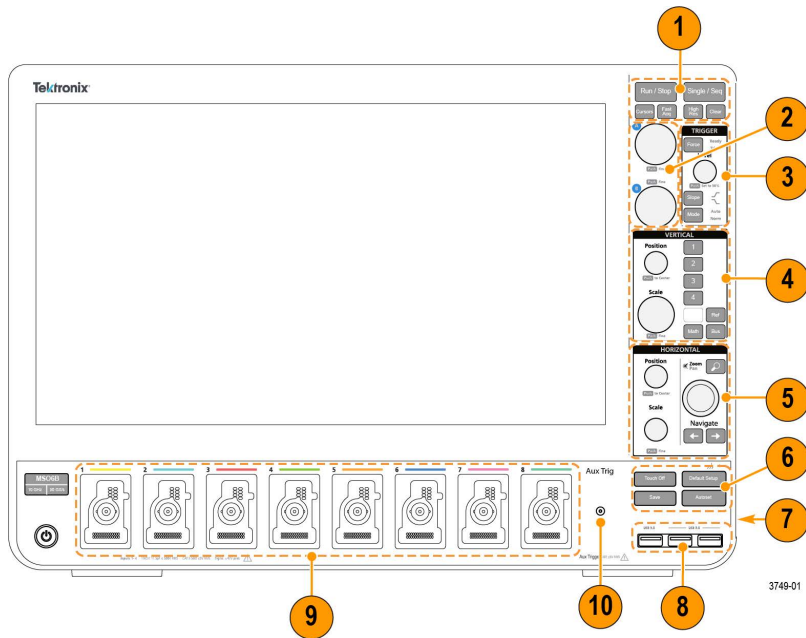

Figure 8: 6 Series B MSO controls

1. Acquisition and Cursors controls:



3514-011

- **Run/Stop** starts and stops waveform acquisition. The button color indicates the acquisition status (green = running and acquiring; red = stopped). When stopped, the oscilloscope shows waveforms from the last completed acquisition. The Run/Stop button on the screen also shows the acquisition status.
- **Cursors** button turns screen cursors on or off. Use the Multipurpose knobs to move the cursors. Double-tap the cursor readouts, or on a cursor bar (line), to open the configuration menu to set cursor types and functionality. See [Display and configure cursors](#) on page 109.
- **Fast Acq™** enables or disables the fast acquisition mode. FastAcq provides high-speed waveform capture that reduces the dead time between waveform acquisitions, enabling the capture and display of transient events such as glitches and runt pulses. It is helpful in finding elusive signal anomalies. Fast acquisition mode can also display waveform phenomena at an intensity that reflects their rate of occurrence.
- **Single/Seq** enables making a single waveform acquisition, or a specified number of acquisitions (as set in the **Acquisition** configuration menu). Pushing **Single/Seq** turns off **Run/Stop** mode and takes a single acquisition. The button color indicates the acquisition status (quick green flash = single acquisition acquired; solid green = waiting for trigger event). Pushing **Single/Seq** again takes another single acquisition.
- **High Res** applies unique finite impulse response (FIR) filters based on the current sample rate. This FIR filter maintains the maximum bandwidth possible for that sample rate while rejecting aliasing. The filter removes noise from the oscilloscope amplifiers and ADC above the usable bandwidth for the selected sample rate. Implementation of the filter in hardware, ahead of the trigger and storage, reduces trigger jitter and enables using **Fast Acq** mode while in **High Res** mode.

**High Res** mode also guarantees at least 12 bits of vertical resolution. The number of bits of resolution is displayed in the **Acquisition** badge at the bottom of the screen. The **Horizontal** badge also updates to show the sample rate and record length settings while in **High Res** mode.

- **Clear** deletes the current acquisitions and measurement values from memory.

2. **Multipurpose knobs:** The Multipurpose knobs A and B move cursors and set parameter values in configuration menu input fields. Selecting an menu field that can use a Multipurpose knob assigns the indicated knob to change the value in that input field. The ring around each knob lights when you can use that knob to do an action. Push a Multipurpose knob to enable the **Fine** mode for making smaller increment changes. Push the knob again to exit **Fine** mode.

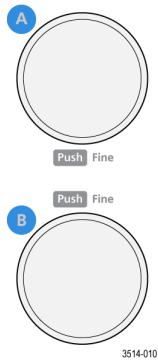

3. **Trigger controls:**

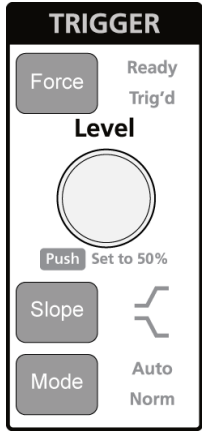

3514-012

- **Force** forces a trigger event at a random point in the waveform and captures the acquisition.
- **Level** sets the amplitude level that the signal must pass through to be considered a valid transition. The color of the **Level** knob LED indicates the trigger source except for dual-level triggers.

The **Level** knob is disabled when the trigger type requires two level settings or other trigger qualifiers (set from the **Trigger** configuration menu). Push the knob to set the threshold level to 50% of the peak-to-peak amplitude range of the signal.

- **Slope** sets the signal transition direction to detect for a trigger (low to high, high to low, or either direction). Push the button to cycle through the selections. The **Slope** button is disabled when the trigger type requires other slope qualifiers (set from the **Trigger** configuration menu).
- **Mode** sets how the instrument behaves in the absence or presence of a trigger event:
  - **Auto** trigger mode enables the instrument to acquire and display a waveform whether or not a trigger event occurs. If a trigger event occurs, the instrument displays a stable waveform. If a trigger event does not occur, the instrument forces a trigger event and acquisition and displays an unstable waveform.
  - **Normal** trigger mode sets the instrument to acquire and display a waveform only when there is a valid trigger event. If no trigger occurs, the last waveform record acquired remains on the display. If no last waveform exists, no waveform is displayed.

4. Vertical controls:

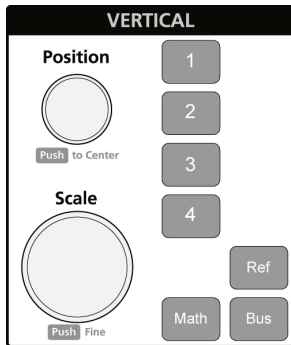

3579-002

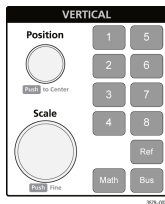

3579-002

- **Position** moves the selected waveform (Channel, Math, Reference, Bus) and its graticule up or down on the screen. The color of the **Position** knob indicates which waveform the knob is controlling. Push the knob to set the threshold level to 50% of the peak-to-peak amplitude range of the signal.
- **Scale** sets the amplitude units per vertical graticule division of the selected waveform. The scale values are shown on the right edge of the horizontal graticule lines, and are specific to the selected waveform in both **Stacked** or **Overlay** modes (in other words, each waveform has its own unique vertical graticule settings regardless of display mode). The color of the **Scale** knob indicates which waveform the knob is controlling.
- **Channel** buttons turn on (display), select, or turn off Channel, Math, Reference, or Bus waveforms. The number of channel buttons depends on the instrument model. The buttons operate as follows:
  - If the channel is not displayed, pushing a Channel button turns on that channel to the Waveform view.
  - If the channel is on the screen and is not selected, pushing that channel's button selects that channel.
  - If the channel is on the screen and is also selected, pushing that channel's button turns that channel off (removes it from Waveform view).
- **Math** button adds or selects a Math waveform on the Waveform view.
  - If no Math waveform exists, pushing the **Math** button adds a Math waveform to the Waveform view and opens the Math configuration menu.
  - If only one Math waveform is displayed, pushing the button turns off the Math waveform (removes it from Waveform view). Push the button again to display the waveform.
  - If two or more Math waveforms are displayed, pushing the button cycles through selecting each math waveform.
- **Ref** button adds or selects a Reference (saved) waveform on the Waveform view.
  - If no Reference waveform exists, pushing the **Ref** button opens the **Browse Waveform Files** configuration menu. Navigate to and select a waveform file (\*.wfm) and tap **Recall** to load and display the reference waveform.
  - If only one Reference waveform is displayed, pushing the button turns off the Reference waveform (removes it from the Waveform View). Push the button again to display the waveform.
  - If two or more Reference waveforms are displayed, pushing the button cycles through selecting each Reference waveform.
- **Bus** button adds or selects a bus waveform on the Waveform view.
  - If no Bus waveform exists, pushing the **Bus** button adds a Bus waveform to the Waveform view and opens the Bus configuration menu.
  - If only one Bus waveform is displayed, pushing the button turns off the Bus waveform (removes it from Waveform view).
  - If two or more Bus waveforms are displayed, pushing the button cycles through selecting each Bus waveform.

#### 5. Horizontal controls:

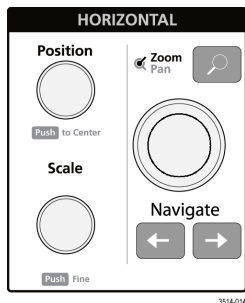

- **Position** moves the waveform and graticule side to side on the screen (changing the trigger point position in the waveform record). Push the knob to center the trigger event to the center graticule on the Waveform view.
- **Scale** sets the time per major horizontal graticule division and samples/second parameters for the oscilloscope. Scale applies to all waveforms. Push the knob to enable the Fine mode for making smaller increment changes. Push the knob again to exit Fine mode.
- **Zoom** opens the Zoom mode. Push **Zoom** again to close zoom mode. See [Zoom user interface](#) on page 67.

- **Zoom** knob (center knob) increases or decreases the area of the zoom box in the Zoom Waveform Overview, which in turn controls the zoom amount of the waveforms shown in the main Zoom view.
- **Pan** knob (outer knob) moves the Zoom box left or right in the **Zoom Waveform Overview**, which in turn controls the part of the waveform shown in the main Zoom view.
- **Navigate** (left and right arrow) buttons puts the oscilloscope in Zoom mode and positions the previous or next search point in the waveform record to the center graticule of the Waveform view. There must be a **Search** badge present in the Results bar before the **Navigate** function will operate. Press and hold a front panel navigate button to continue moving to the next search point in that direction. See [Badges](#) on page 55.

The front panel **Navigate** buttons can also be used for the **Previous** and **Next** button functions on measurement badges.

6. Miscellaneous controls:



3514 015

- **Touch Off** turns touch screen capability off. The **Touch Off** button is lighted when the touch screen is turned off.
- **Save** is a one-push save operation that uses the current **File > Save As** settings to save screen shots (including open menus and dialog boxes), waveform files, instrument settings, and so on.
  - If a **File > Save** or **File > Save As** operation has occurred since the last instrument startup, pushing **Save** saves the file types to the location last set in the **Save As** configuration menu.
  - If no file save operation has occurred since the last instrument startup, pushing **Save** opens the **Save As** configuration menu. Select a tab to select the type of file to save (Screen Capture, Waveform, and so on), set any associated parameters, and where to save it, and select **OK**. The specified file or files are saved. The next time you push **Save**, the same type files are saved.
  - **Screen Captures** capture the entire screen, including most displayed configuration menus and dialog boxes.
- **Default Setup** restores the oscilloscope settings (horizontal, vertical, scale, position, and so on) to the factory default settings.
- **Autoset** automatically displays a stable waveform. See [Autoset to quickly display a waveform](#) on page 85.

7. Ground and Probe Compensation connectors: The Ground and Probe Compensation connectors are located at the lower right side of the instrument, near the front panel. The Ground connector (the small hole in the case) provides an electrically grounded (through a resistor) connection point to attach an anti-static wrist strap, to reduce electrostatic damage (ESD) while you handle or probe the DUT.

The Probe Compensation connections provide a ground connector (upper tab) and 1 kHz square wave source (lower tab) for adjusting the high-frequency response of a passive probe (probe compensation). The oscilloscope uses this signal to automatically compensate supported probes, including the ones that ship with the product. See [Compensate the TPP Series probes](#) on page 73.

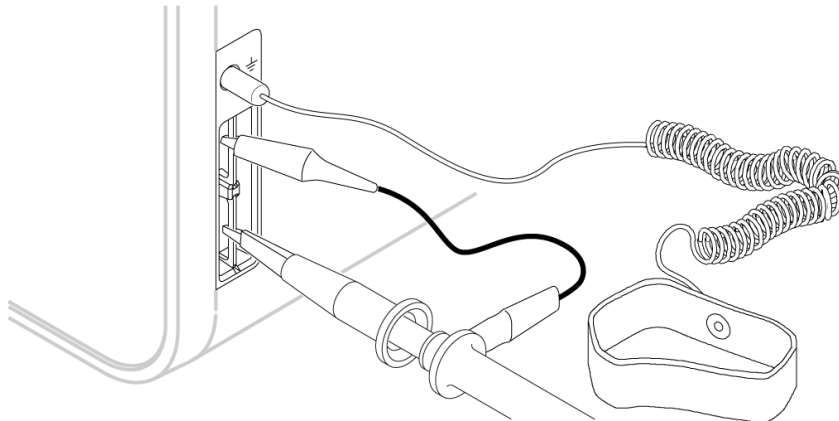

3644-011



8. **USB Host ports (USB 3.0 and 2.0):** USB ports are located at the lower right corner of the front panel, and on the rear panel. Connect USB flash drives to which you can save or recall data (such as instrument software updates, waveforms, settings, and screen captures), or connect peripheral devices such as a mouse or keyboard.
9. **FlexChannel probe connectors:** FlexChannel connectors support all TekVPI+ and TekVPI measurement probes, BNC passive probes, the TPL058 FlexChannel Logic Probe, and BNC cables. You connect most probes simply by pushing them into the connector until the probe seats with a click.

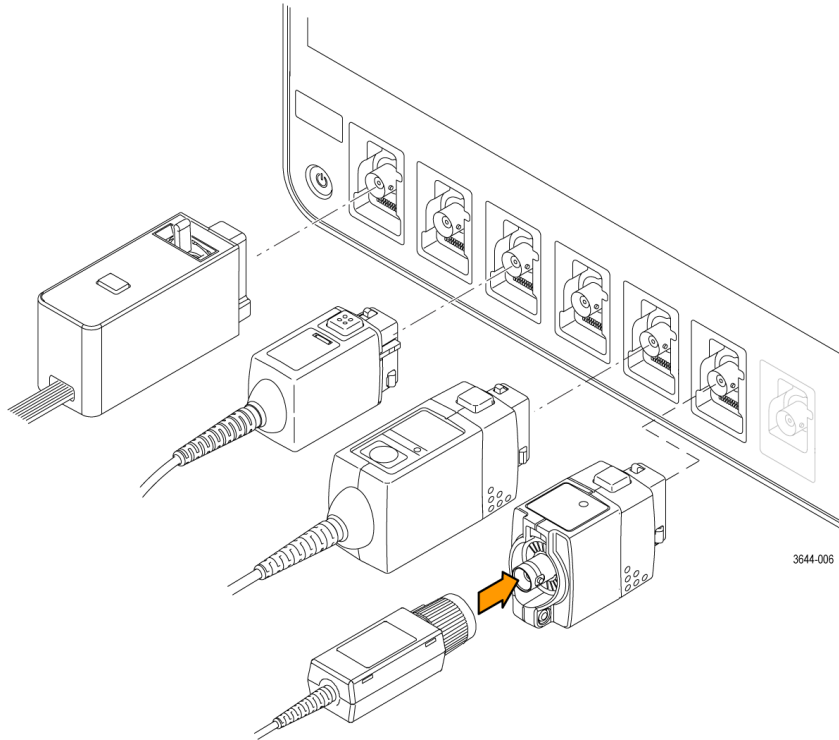
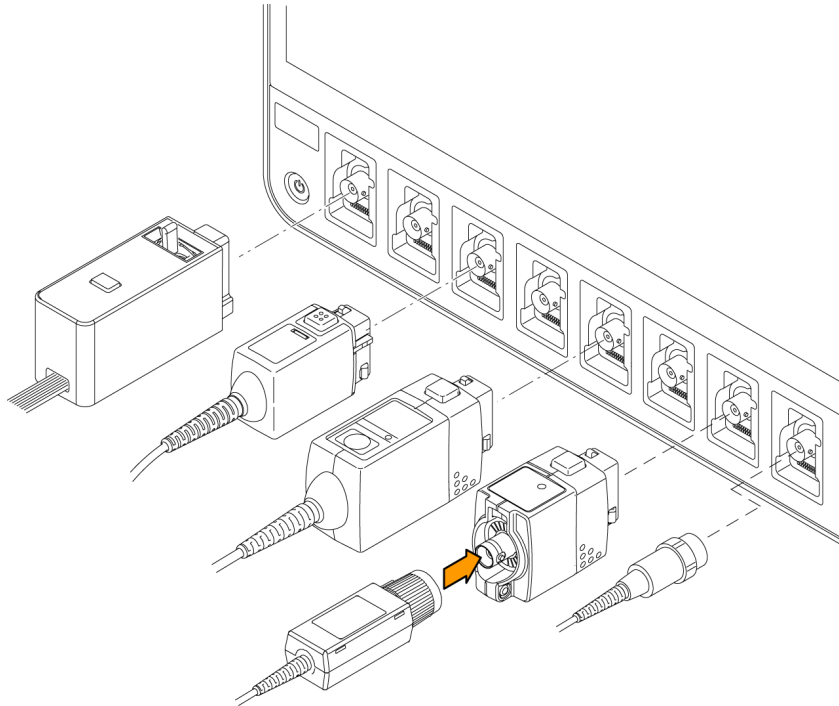

Figure 9: 4 Series MSO



3514-019

Figure 10: 5 Series MSO

- Aux In** auxiliary trigger input connector. A connector to which you can connect an external trigger input signal. Use the **Aux In** trigger signal with the Edge trigger mode.

### The MSO58LP front panel

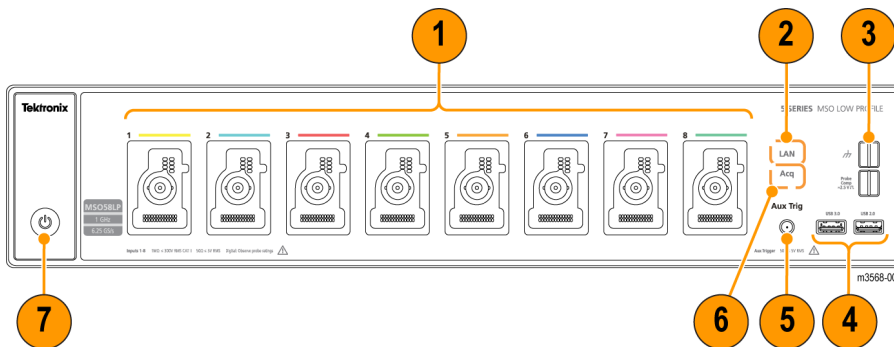

- FlexChannel® probe connectors:** FlexChannel® connectors support all TekVPI+ and TekVPI measurement probes, BNC passive probes, the TLP058 FlexChannel® Logic Probe, and BNC cables. You connect most probes simply by pushing them into the connector until the probe seats with a click. See
- LAN Status LED:** Shows the network connection and activity status:
  - Off - No power to instrument
  - Green - Network connection is good
  - Red - Network connection has fault or is not connected
- Probe Compensation connectors:**

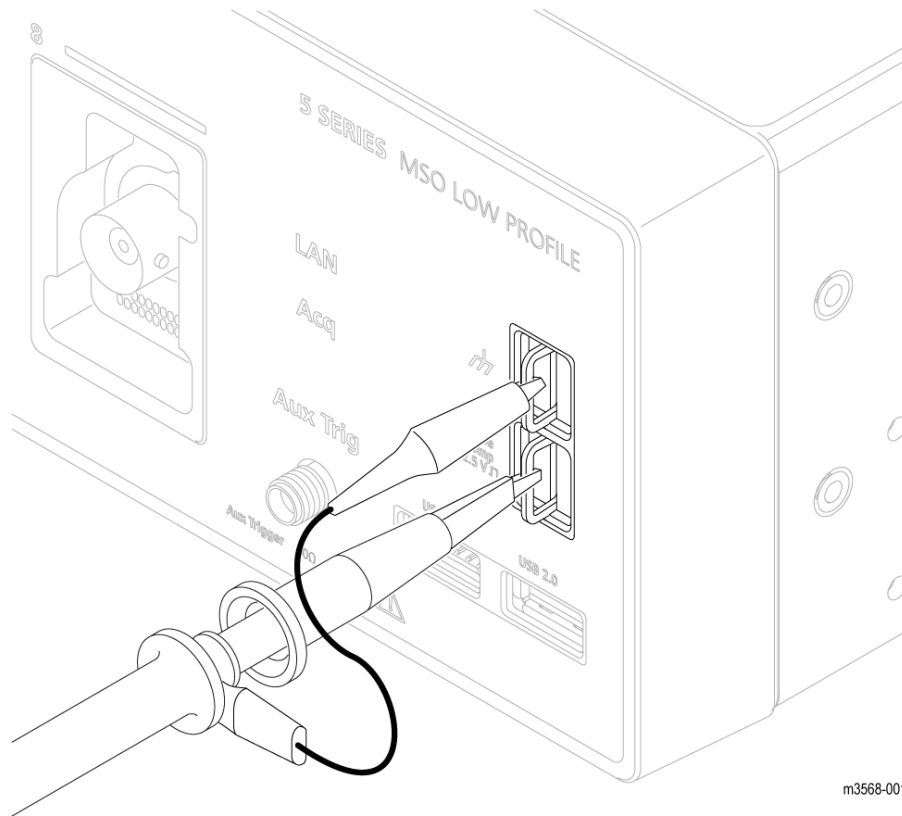

m3568-001

The Probe Compensation connections provide a ground connector and 1 kHz square wave source for adjusting the high-frequency response of a passive probe (probe compensation). The oscilloscope uses this signal to automatically compensate supported probes. See [Compensate the TPP Series probes](#) on page 73.

You can also use the ground connector to attach an anti-static wrist strap, to reduce the chance of electrostatic damage (ESD) while you handle or probe the DUT.

4. **USB Host ports:** USB ports are located at the lower right corner of the front panel. Connect USB flash drives to which you can save or recall data (such as instrument firmware updates, waveforms, settings, and screen captures), or connect peripheral devices such as a mouse or keyboard.
5. **Aux Trig trigger input connector:** An SMA connector to which you can connect an external trigger input signal. Use the AUX In trigger signal with the Edge trigger mode.
6. **Acq status LED:** Shows the instrument trigger/acquisition status:
  - Green - Triggered
  - Yellow - Armed but not yet triggered
  - Red - Acquisition stopped
7. **Power On/Standby button:** Powers the instrument on and off. The power button color indicates instrument power states:
  - No light - No AC power applied
  - Yellow - Standby mode
  - Blue - Powered on

## The LPD64 front panel

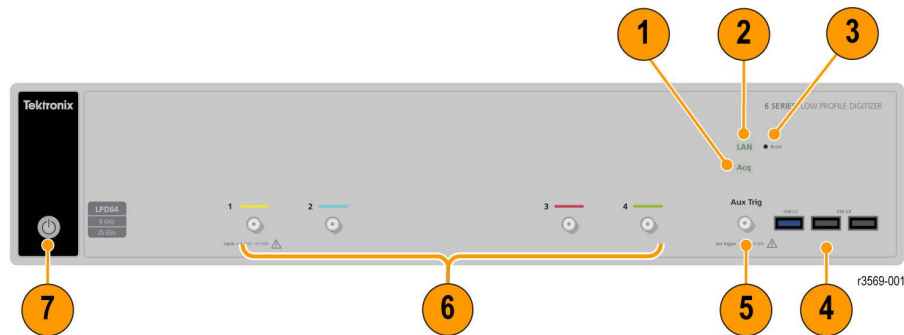

### 1. Acq status LED:

Shows the instrument trigger/acquisition status:

- Green - Triggered
- Yellow - Armed but not yet triggered
- Red - Acquisition stopped

### 2. LAN Status LED: Shows the network connection and activity status:

- Off - No power to instrument
- Green - Network connection is good
- Red - Network connection has fault or is not connected

### 3. LAN Reset button (to the right of the LAN status LEDs): Lets you manually reset the LAN settings.

### 4. USB Host ports (One USB 3.0; two USB 2.0): Lets you save or recall data (such as instrument firmware updates, waveforms, settings, and screen captures) to a USB memory device, or connect peripheral devices such as a mouse or keyboard.

### 5. Aux Trig trigger input connector: An SMA connector to which you can connect an external trigger input signal. Use the AUX In trigger signal with the Edge trigger mode.

### 6. SMA connectors: SMA connectors support high bandwidth and frequency cables.

### 7. Power On/Standby button: Powers the instrument on and off. The power button color indicates instrument power states:

- No light - No AC power applied
- Yellow - Standby mode
- Blue - Powered on

## Rear panel connections

The rear panel connections supply power to the instrument and provide connectors for network, USB devices, video, reference signals, and the AFG output.

4 Series B MSO

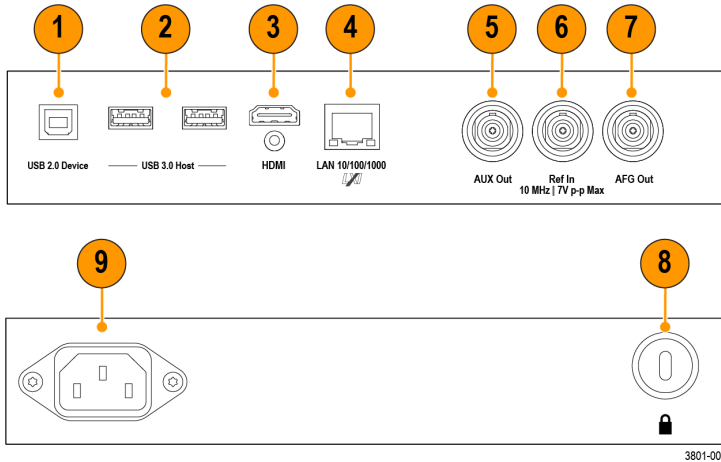

1. **USB 2.0 Device** port lets you connect to a PC to remotely control the instrument using USBTMC protocol.
2. **USB 3.0 Host** ports let you connect a USB memory device, keyboard, or mouse.
3. **HDMI video output** lets you connect an external monitor or projector to show the instrument's graphical user interface.



**Note:** You must connect an external monitor before powering on the instrument.

4. **LAN** connector (RJ-45) connects the instrument to a 10/100/1000 Base-T local area network.
5. **AUX Out** generates a signal transition on a trigger event, outputs a 10 MHz reference signal, or outputs a synchronization signal from the AFG.
6. **Ref In** lets you connect a high-precision 10 MHz reference signal to the oscilloscope for more accurate measurements.
7. **AFG Out** is the signal output for the optional Arbitrary Function Generator (AFG) feature.
8. **Security** lock connector lets you use a standard PC/laptop lock cable to secure the instrument to a work bench or other location.
9. **Power cord** connector. Use only the power cord specified for this product and certified for the country of use.

#### 4 Series MSO:

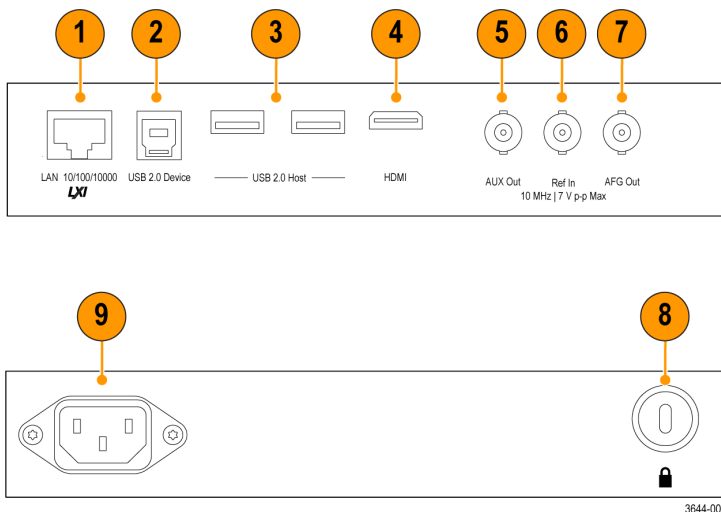

1. **LAN** connector (RJ-45) connects the instrument to a 10/100/1000 Base-T local area network.
2. **USB 2.0 Device** port lets you connect to a PC to remotely control the instrument using USBTMC protocol.
3. **USB 2.0 Host** ports let you connect a USB memory device, keyboard, or mouse.
4. **HDMI video output** lets you connect an external monitor or projector to show the instrument's graphical user interface.



**Note:** You must connect an external monitor before powering on the instrument.

5. **AUX Out** generates a signal transition on a trigger event, outputs a 10 MHz reference signal, or outputs a synchronization signal from the AFG.
6. **Ref In** lets you connect a high-precision 10 MHz reference signal to the oscilloscope for more accurate measurements.
7. **AFG Out** is the signal output for the optional Arbitrary Function Generator (AFG) feature.
8. **Security** lock connector lets you use a standard PC/laptop lock cable to secure the instrument to a work bench or other location.
9. **Power cord** connector. Use only the power cord specified for this product and certified for the country of use.

5 Series MSO (including MSO58LP) and 6 Series MSO (including LPD64):

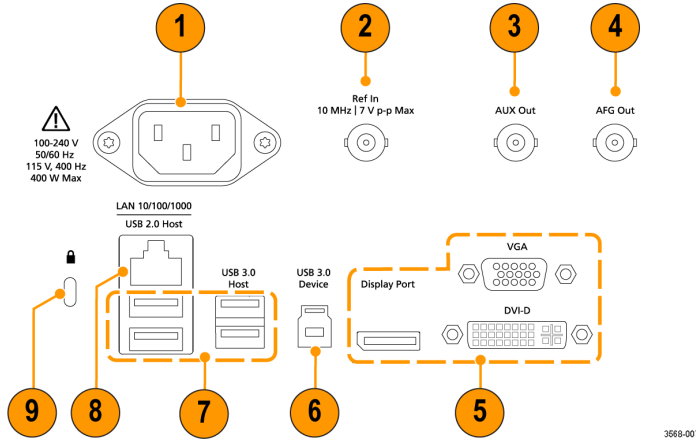

5 and 6 Series B MSO:

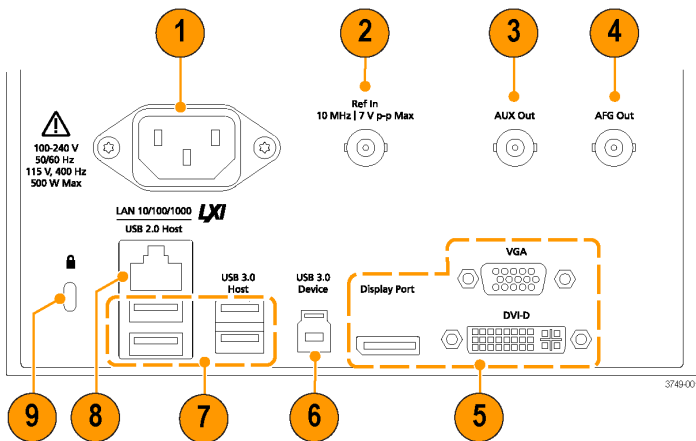

1. **Power cord** connector. Use only the power cord specified for this product and certified for the country of use.
2. **Ref In** lets you connect a high-precision 10 MHz reference signal to the oscilloscope for more accurate measurements.
3. **AUX Out** generates a signal transition on a trigger event, outputs a 10 MHz reference signal, or outputs a synchronization signal from the AFG.
4. **AFG Out** is the signal output for the optional Arbitrary Function Generator (AFG) feature.
5. **Video outputs** (Display Port, VGA, and DVI-D) let you connect an external monitor or projector to show the instrument's graphical user interface.
6. **USB 3.0 Device** port lets you connect to a PC to remotely control the instrument using USBTMC protocol.
7. **USB Host** ports let you connect a USB memory device, keyboard, or mouse.
8. **LAN** connector (RJ-45) connects the instrument to a 10/100/1000 Base-T local area network. The LAN is LXI 1.5 compliant.

9. **Security** lock connector lets you use a standard PC/laptop lock cable to secure the instrument to a work bench or other location.

## User interface screen

The touch screen user interface contains waveforms and plots, measurement readouts, and touch-based controls to access all oscilloscope functions.



- The **Menu bar** provides menus for typical operations including:
  - Saving, loading, and accessing files
  - Undoing or redoing an action
  - Setting oscilloscope display and measurement preferences
  - Configuring network access
  - Running self tests
  - Erasing measurement and settings memory (TekSecure™)
  - Loading option licenses
  - Opening a Help viewer
- The **Waveform View** area displays analog, digital, math, reference, bus, and trend waveforms. The waveforms include waveform handles (identifiers), individual vertical graticule scale labels, and trigger position and level(s) indicators. You can set the Waveform View to stack each waveform vertically in separate graticules, called 'slices' (the default mode, as shown in the previous image), or overlay all the waveforms on the screen (traditional waveform view). See [User interface elements](#) on page 53.
 

You can also add Histogram, Spectral, Eye, and Measurement Results views (plots) for individual measurements. These plot views are separate view windows that you can move on the screen by dragging their title bar to a new position.
- The **Results Bar** contains controls for displaying cursors, adding callout, plots, and result tables to the screen, and add measurements to the Results bar. To remove a measurement, search or other badge from the Results Bar simply flick it off screen. The controls are:
  - The **Cursors** button displays on-screen cursors in the selected view. Touch and drag, or use the Multipurpose knobs, to move the cursors. Double-tap on a cursor, or on the cursor readouts, to open a configuration menu to set cursor types and related functions.

- The **Measure** button opens a configuration menu from which to select and add measurements to the Results bar. Each measurement you add has a separate badge. Double-tap a measurement badge to open its configuration menu.
  - The **Results Table** button adds a Measurement or Bus Results table to the screen. The Measurement Results table displays all measurements present in the Results bar. The Bus Results table displays bus decode information for displayed bus waveforms. Each table is contained within its own view window, which can be moved within the display area.
  - To remove a measurement, search or other badge from the Results Bar simply flick it off screen.
  - The **Callout** button adds a Callout object to the selected view. Double-tap the Callout text to open a configuration menu to change the type of callout, text and font characteristics. Drag any callout other than bookmark to any location on the oscilloscope screen view. Bookmarks callout can only be added to waveviews and spectrum views.
  - The **Search** button lets you detect and mark a waveform where specified events occur. Tap **Search** to open a Search configuration menu and set the search conditions for analog and digital channels. You can add any number of searches to the same waveform or to different waveforms. Search badges are added to the **Results Bar**.
  - The **Plot** button adds an XY, XYZ, or Eye Diagram plot to the display. These plots are contained within their own window and can be moved within the overall display area.
  - The **Measurement** and **Search** badges show measurement and search results, and are displayed in the **Results Bar**. See [Badges](#) on page 55. See [Add a measurement](#) on page 95. See [Add a Search](#) on page 107.
  - The **Zoom icon** button at the up right of the **Results Bar** lets you to draw a box on the screen to zoom in on an area of interest, drawing segments for mask testing, or drawing areas to define visual trigger conditions.
  - The **More...** button at the up right of the **Results Bar** allows you to select Zoom, Visual trigger, Mask, or Waveform Histogram.
4. The **Settings Bar** contains System badges for setting Horizontal, Trigger, Acquisition, and Date/Time parameters; **Inactive Channel** buttons to turn on channels; **Add New Waveform** buttons to add math, reference, and bus waveforms to the display; and Channel and Waveform badges that let you configure the individual waveform parameters. Tap a channel or waveform button to add it to the screen and display a badge. Double-tap a badge to open its configuration menu. See [Badges](#) on page 55.
  5. **Configuration Menus** let you quickly change the parameters of the selected user interface item. You can open configuration menus by double-tapping on badges, screen objects, or screen areas. See [Configuration menus](#) on page 66.



## User interface elements

Each area of the user interface has a specific function that helps manage information or controls. This topic shows and describes the key user interface elements.

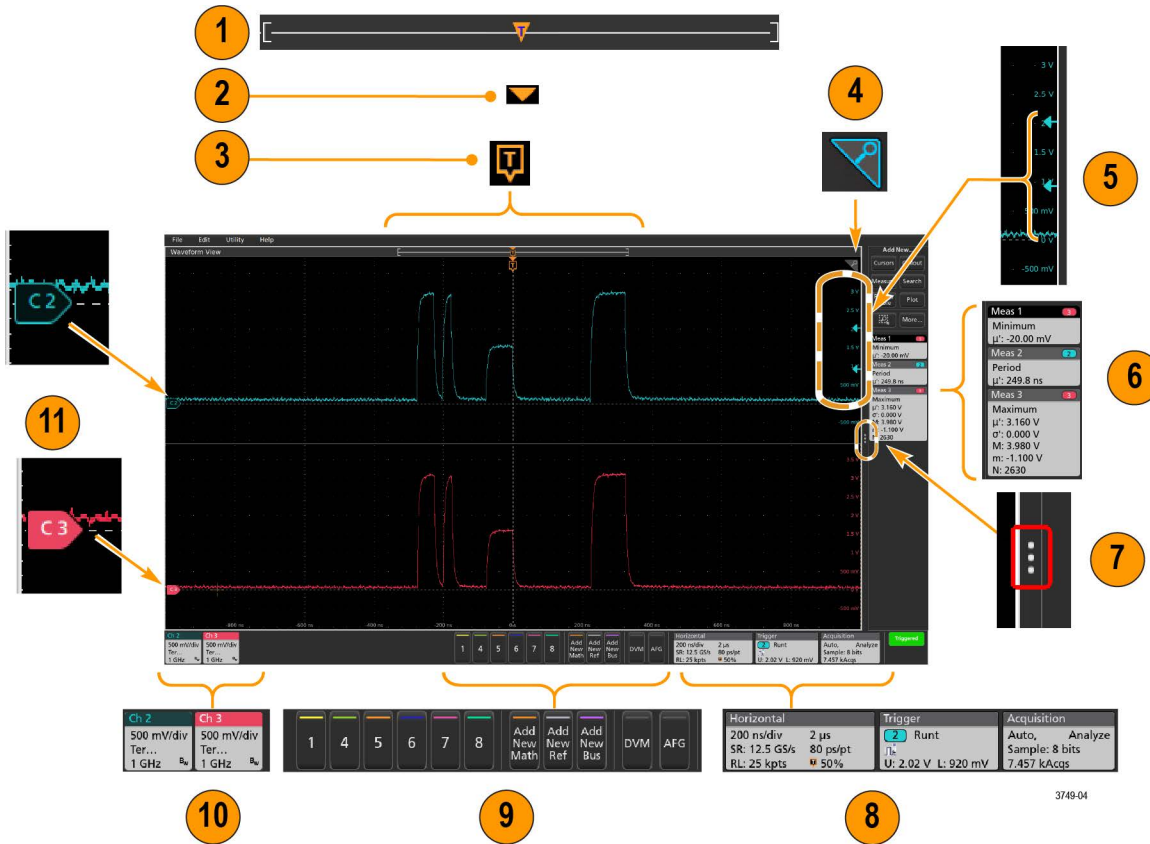

1. The Waveform Record View is a graphical high-level view of the overall waveform record length, how much of the record is on the screen (shown in brackets), the location of key time events including the trigger event, and the current position of waveforms cursors.





If you are displaying a Reference waveform that is shorter than the current acquisition record length, or you are changing the horizontal time scale while the oscilloscope acquisition is stopped, the brackets change position to show the part of the waveform record that is being viewed relative to the current acquisition total record length.



If cursors are active on a waveform, the Waveform Record View shows the relative cursor positions as small vertical dashed lines.



When in Zoom mode, the Waveform Record View is replaced with the Zoom Overview. See [Zoom user interface](#) on page 67.

2. The Expansion Point icon on the waveform view shows the center point around which the waveform expands and compresses when changing horizontal settings.
 
3. The Trigger Position Indicator shows where the trigger event occurred in the waveform record. The trigger icon is displayed in the waveform slice that is the trigger source.
 

- The Zoom icon (in upper right corner of Waveform and Plot views) toggles zoom on and off. The front panel **Zoom** button and knobs also turn on zoom mode and change the position and horizontal size of the Zoom Box.



- The Trigger Level Indicator icon(s) shows the trigger level on the trigger source waveform. Some trigger types require two trigger levels.
- Measurement and Search badges show measurement and search results. See [Badges](#) on page 55. See [Add a measurement](#) on page 95.
- The Results Bar Handle opens or closes the **Results bar**, to maximize waveform screen viewing when needed. To reopen the **Results bar**, either tap the handle icon or swipe left from the right side of the display.
- The System badges show global instrument settings (**Horizontal**, **Trigger**, **Acquisition**, Run/Stop status, and Date/Time). See [Badges](#) on page 55.
- The Inactive Channel buttons add channel waveforms to the Waveform view and add an associated Channel badge to the Settings bar.

The **Add New Math**, **Add New Ref**, and **Add New Bus** buttons add the corresponding signal to the Waveform view, and add an associated Waveform badge to the **Settings** bar. You can add any number of Math, Reference, and Bus waveforms, limited only by system memory.

The optional **AFG** button opens the AFG configuration menu to set and enable the AFG output. This button is only present if the AFG option is installed.

The optional **DVM** button lets you use an analog probe to take DC, AC RMS, or DC+AC RMS voltage measurements on your DUT. Tap the button to add a DVM badge to the Results Bar and open a configuration menu. The DVM option also enables a trigger frequency counter, accessible from the **Mode & Holdoff** panel in the **Trigger** badge menu. This button is only present if the DVM option is installed.

- Double-tap a badge to open its associated configuration menu. See [Badges](#) on page 55. See [Configuration menus](#) on page 66.

If you add more Channel or Waveform badges than can fit in the waveform badge display area, tap the scroll buttons at each end of the waveform badge area to scroll and display hidden badges.

- The Waveform Handles on each waveform identify the source of that waveform (Cx for channels, Mx for Math waveforms, Rx for Reference waveforms, Bx for bus waveforms). The waveform handles are at the zero-volt level of the waveform by default. The currently selected waveform handle is a solid color; unselected waveform handles are outlined.

Double-tapping a waveform handle opens the configuration menu for that waveform.

For digital channels, the waveform handle shows the channel number, each individual digital signal labeled D0–D7 and displayed with a different color.



Double-tapping a digital waveform handle opens the digital channel configuration menu.

Dragging a digital signal handle over another handle swaps those two signals on the waveform.

- The probe Dynamic Range Limit Markers are displayed just within the left-hand graticule edge, based at the channel vertical trace handle position and extending up and down to the dynamic range limits of the probe. The markers are only displayed if compatible probes are used. Signals must be within the probe dynamic range for the oscilloscope to correctly display and measure the signals.

The markers are displayed, for about three seconds, after any **Offset**, **Position**, or **Scale** control change that leaves the channel dynamic range limits within the acquisition window. After about three seconds the markers become short lines at the left edge of the graticule. If the dynamic range is too small to display the arrows, the arrows are omitted. Examples of all three marker versions are shown.

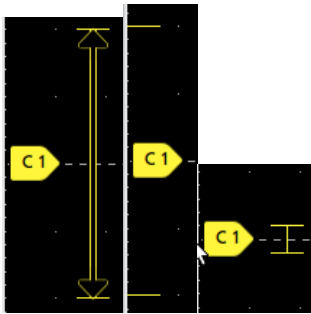

## Badges

Badges are rectangular icons that show waveform, measurement, and instrument settings or readouts. Badges also provide fast access to configuration menus. The badge types are Channel, Waveform, Measurement, Search, and System.

### Channel and Waveform badges

Channel and Waveform (**Math**, **Ref**, **Bus**, **Trend**) badges are shown in the settings bar, located along the bottom left of the screen. Each waveform has its own badge. The badges show high-level settings for each displayed channel or waveform. Double-tap a badge to open its configuration menu.

Ch 2	Ch 3	Ch 4	Math 1	Trend 1
1 V/div 1 GHz <sup>B<sub>w</sub></sup>	1 V/div 1 GHz <sup>B<sub>w</sub></sup>	1 V/div 1 MΩ 500 MHz <sup>B<sub>w</sub></sup>	860 mV/div Ch2 + Ch3	Meas 9 731.3963... Frequency

Most Channel and Waveform badges also have Scale buttons, shown by single-tapping the badge. Use the Scale buttons to increase or decrease the vertical scale setting for that waveform.

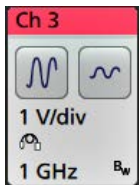

You can drag Channel and Waveform badges to change their position in the **Settings** bar and open the badge right-click menu to access a quick-action menu.

There are two ways to delete Channel and Waveform badges.

- Right-click the badge and turn it off.
- Flick the badge off the bottom edge of the display to remove it from the **Settings** bar. Flicking upwards from the bottom edge of the **Settings** bar recovers the badge. Badge recovery is only possible within 10 seconds of removal.

Channel badges are listed in the channel order unless you have moved them. Channel badges may also display short error or warning messages. For more information double-tap the badge to open its configuration menu, or search the instrument Help.

Waveform badges (**Math**, **Ref**, **Bus**, **Trend**) are listed in the order created (unless they have been moved), and are grouped together by type. Deleting a Waveform badge does not change the order or names of the remaining badges.

## Measurement badges

Measurement badges are located in the **Results** bar. They show measurements or search results. The badge title also shows the measurement source or sources. To add a Measurement badge, tap the **Add New Measurement** button and select a measurement.

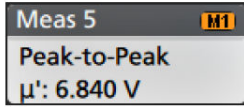

Double-tap a Measurement badge to open its configuration menu to change or refine settings. The default measurement badge readout shows the measurement's mean ( $\mu$ ) value.

Some measurements and their badges are only available as options. For example, Power measurements are only listed in the Add New Measurement menu if the required power option is installed.

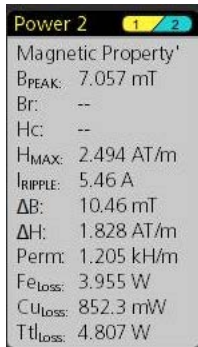

**Wide Badge:** Wide badge displays all the phases results in a separate column. All sub-measurements are listed in the results badge in the first column. The common result such as Frequency is applicable to all the (3) phases and displayed as single value. The configured sources for each phase are displayed in channel colors. The Wide Badge applies to IMDA measurements only.

	IMDA Meas 1: Cyc Power Quality'		
	VaN:Ia	VbN:Ib	VcN:Ic
V <sub>RMS</sub> (V):	14.74	14.74	14.48
V <sub>MAG</sub> (V):	8.197	8.383	8.423
I <sub>RMS</sub> (A):	879.4 m	999.4 m	975.0 m
I <sub>MAG</sub> (A):	453.7 m	574.3 m	562.9 m
V CF:	2.953	2.931	3.053
I CF:	3.196	3.407	3.575
TrPwr(W):	4.795	5.914	4.546
RePwr(VAR):	-12.04	-13.49	-13.36
ApPwr(VA):	12.96	14.73	14.12
PF:	593.2 m	659.6 m	511.6 m
Phase:	-53.61 °	-48.73 °	-59.23 °
Freq:	287.6 Hz		
Σ TrPwr:	15.25 W		
Σ RePwr:	-38.90 VAR		
Σ ApPwr:	41.82 VA		

To add statistical readouts to individual measurement badges, double-tap a measurement badge to open its configuration menu and select **Show Statistics in Badge**. The measurement badge displays the standard deviation ( $\sigma$ ) value. The standard deviation is zero, when the population is one.

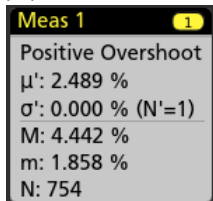

Some Measurement badges also have Navigation buttons, shown by single-tapping the badge.

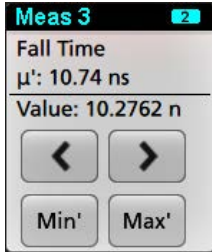

The < (Previous) and > (Next) buttons center the waveform in the display at the position of the previous or next measurement point in the record (for measurements that take more than one measurement per acquisition).

The **Min'** and **Max'** navigation buttons center the waveform in the display at the minimum or maximum value for that measurement in the current acquisition.

The prime symbol (') shown on measurement readings and Min/Max buttons indicates that the value shown (or moved to in the case of **Min/Max** buttons and waveforms) is from the current acquisition. Lack of a prime symbol means the value is from all acquisitions.

The Measurement badge displays **Status** and **Failures** information when pass/fail testing is enabled through the configuration menu. The Status line shows **Pass** (green) or **Fail** (red) according to the conditions defined in the **Pass/Fail Testing** panel. The number of Failures are displayed when statistics are shown in the badge. The Pass/Fail status, number of Failures, and the Limit(s) set in the Pass/Fail Testing panel are available in the Measurement Results table.

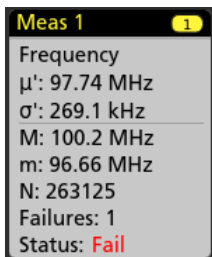
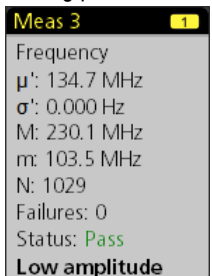

Measurement badges are listed in the order created, starting at the top of the Results bar. Deleting a Measurement badge does not change the order or names of the remaining badges.

You can drag Measurement badges to change their position in the **Results** bar and open the badge right-click menu to access a quick-action menu.

There are two ways to delete Channel and Waveform badges.

- Right-click the badge and turn it off.
- Flick the badge off the right edge of the display to remove it from the **Results** bar. Flicking left from the right edge of the **Results** bar recovers the badge. Badge recovery is only possible within 10 seconds of removal.

## Mask Test badge

The mask test results and measurement statistics are displayed in the **Mask Test** badge in the Results bar. The badge is created when the first segment of a mask is defined.



Badge readout	Description
Label (optional readout)	A label defined in the badge configuration menu.
Tested	The total number of waveforms tested against the mask.
Passed	The number of waveforms that contained no samples that violated the mask.
Failed	The number of waveforms that contained one or more samples that violated the mask. Displays in red if greater than or equal to the total failures threshold.
Cons	The highest number of consecutively failed waveforms in the test run. Displays in red if greater than or equal to the consecutive failures threshold.
Status	The status of the mask test. It can be On, Off, Passed/Passing (green) or Failed/Failing (red).
Seg n (optional readout)	The number of waveforms that contained one or more samples that violated mask segment n.

Double-tap a Mask Test badge to open its configuration menu to change or refine settings.

You can drag the badge to change its position in the **Results** bar and open the badge right-click menu to access a quick-action menu.

There are two ways to delete Channel and Waveform badges.

- Right-click the badge and turn it off.
- Flick the badge off the right edge of the display to remove it from the **Results** bar. Flicking left from the right edge of the **Results** bar recovers the badge. Badge recovery is only possible within 10 seconds of removal.

See for the mask test configuration settings [Create a Mask](#) on page 157 for more information masks and [Mask Test badge configuration menu](#) on page 458

## Waveform Histogram badges

The Waveform Histogram badges are located in the **Results** bar. The badge title shows the histogram source.

To add the Waveform Histogram badge to Results bar, set the **Display** to **On** from the Result Badge menu. Double-tap a Waveform Histogram badge to open its configuration menu to change settings.

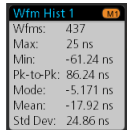

The histogram badge displays the measurements which are checked in the Result Badge menu. To add more histogram measurements to the badge refer [Waveform Histogram Result Badge menu](#) on page 620.

You can drag the badge to change its position in the **Results** bar and open the badge right-click menu to access a quick-action menu.

There are two ways to delete Waveform Histogram badges.

- Right-click the badge and select **Delete Histogram**.

- Flick the badge off the right edge of the display to remove it from the Results bar. Flicking left from the right edge of the Results bar recovers the badge. Badge recovery is only possible within 10 seconds of removal.

See also

- [Create a waveform histogram](#) on page 163
- [Waveform Histogram configuration menu](#) on page 619

## Cursor Badges

You can display the cursor readouts in a **Cursors** badge in the Results bar. The badge contents depend on the cursor in use.

Cursors	Cursors	Cursors
A t: 26.800 ms v: 4.802 V B t: 31.500 ms v: 2.936 V Δt: 4.700 ms 1/Δt: 212.76 Hz Δv: 1.866 V 1/Δv: 535.9 mV/s	A t: 26.800 ms B t: 31.500 ms Δt: 4.700 ms 1/Δt: 212.76 Hz	A v: 4.802 V B v: 2.936 V Δv: 1.866 V 1/Δv: 535.9 mV/s

To create a cursor readouts badge, turn on **Cursors**, double-tap a cursor readout to open its configuration menu, and set the **Readouts** mode to **Badge**.



**Note:** You can only view cursor readouts in one location at a time; either on the waveform or in a Cursors badge. You cannot move cursor readouts to a badge for Spectrum View cursors.

You can drag the badge to change its position in the **Results** bar and open the badge right-click menu to access a quick-action menu.

There are two ways to delete Channel and Waveform badges.

- Right-click the badge and turn it off.
- Flick the badge off the right edge of the display to remove it from the **Results** bar. Flicking left from the right edge of the **Results** bar recovers the badge. Badge recovery is only possible within 10 seconds of removal.

## Search badges

**Search** badges are also shown in the Results bar, below the Measurement badges. A search badge lists the search source, search type, and the number of search event occurrences in the current acquisition. The instrument marks the waveform where those events occur with small down-pointing triangles along the top of the waveform graticule. Double-tap a search badge to open its configuration menu to change or refine search settings.

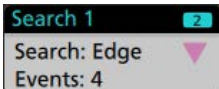

Search badges are created by tapping the **Add New... Search** button. Use the displayed configuration menu to set the search criteria.

Search badges have < (Previous) and > (Next) Navigation buttons that open the Zoom mode and center the waveform in the display at the position of the previous or next search mark in the waveform record. Search badge Navigation buttons are only usable when the oscilloscope is in single acquisition mode. Single-tap a badge to close the Navigation buttons.



Some searches also provide **Min** and **Max** navigation buttons that open the Zoom mode and center the waveform in the display at the minimum or maximum value for that search event in the current acquisition.

**Search** badges are listed in the order created. Deleting a **Search** badge does not change the order or names of the remaining badges. You can drag Search badges to change their position in the **Results** bar and open the badge right-click menu to access a quick-action menu.

There are two ways to delete Channel and Waveform badges.

- Right-click the badge and turn it off.
- Flick the badge off the right edge of the display to remove it from the **Results** bar. Flicking left from the right edge of the **Results** bar recovers the badge. Badge recovery is only possible within 10 seconds of removal.

### Deleting mass Measurements/Searches badges at once

This badge helps you to delete/remove many number measurements or searches, which are in the Results bar.

1. Select and right click on the Measurement/Search badge in the **Results** bar, which displays the dialog box as shown:

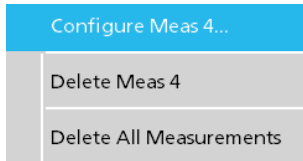

Controls	Description
<b>Configure Measurement/Search</b>	Configure Measurement or Search badges
<b>Delete Measurement/Search/Histogram</b>	Deletes the selected Measurement (standard, power, jitter, DDR, etc.)/Search/Histogram badge in the Results bar.
<b>Delete All Measurement/Search/Histogram</b>	Deletes all the Measurement (standard, power, jitter, DDR, etc.)/Search/Histogram badges in the Results bar.

2. When **Delete All Measurements** is selected, the oscilloscope asks for the confirmation to delete all the measurements/search at a time.

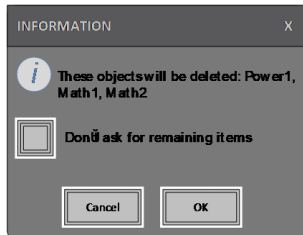

3. The dialog box provides you a checkbox that gives the choice to bypass remaining information dialogs.
  - **Don't ask for remaining items:** Default is unchecked. If you leave it unchecked and clear the information dialog, then the dialog will appear again for the next measurement deletion.
  - If the box is checked, it proceeds with deleting the rest of the items without bringing up the dialog box again. The dialog box appears for each set of measurements you want to delete.

### Signal Clipping and Badges



**WARNING:** Clipping is caused by excessive or dangerous voltage at the probe tip, and/or a vertical scale setting that is not adequate to display the entire vertical range of the waveform. Excessive voltage at the probe tip can injure the operator and cause damage to the probe and/or instrument.

This instrument shows a warning triangle symbol and the words Clipping in a Channel badge when a vertical clipping condition exists. Any measurement badges associated with that channel also indicate a clipping condition by turning the measurement text red and listing the type of clipping (positive or negative).





To close the clipping message, change the vertical scale to show the entire waveform, disconnect the probe tip from the excessive voltage source, and check that you are probing the correct signal using the correct probe.

Clipping causes inaccurate amplitude-related measurement results. Clipping also causes inaccurate amplitude values in saved waveform files. If a math waveform is clipped, it will not affect amplitude measurements on that math waveform.

## Error Messages and Badges

This instrument shows a warning triangle symbol and an error message abbreviation in a Channel badge when an error occurs.

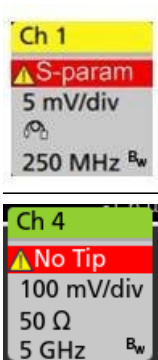

To remove the message from the badge, clear the error as indicated in the table.

**Table 1: Probe errors**

Error message	Description
Prb Comm	Accessory communication timed out. Please re-attach the accessory.
Prb ROM	Unable to read probe ROM. Please re-attach the accessory.
Unsup	Accessory is unsupported.
Prb Fault	Critical accessory fault. Please re-attach the accessory. If the problem persists, contact Tektronix service.
Over Rng	The signal voltage or current is over range. Please reduce the signal amplitude.
Temp	The probe has experienced an over temperature condition. Please remove the probe from the high temperature area.
No Tip	No probe tip detected. Please install a compatible probe tip.
Tip Fault	The probe tip has a fault. Please remove and replace the probe tip.
S-param	Error during S-parameter transfer. Please reattach the probe. If the problem persists, contact Tektronix Service.

## History badge

The History badge is shown in the **Results** bar. Navigate the history acquisitions by using the Previous/Next or Play/Pause buttons.

Timestamp shows the time difference between the previous acquisition and the selected acquisition.



Badge readout	Function	Description
	Previous	The previous button takes you to the previous acquisition.
	Next	The next button takes you to the next acquisition.
	Play/Pause	Acquisitions are played at the specified playback speed and begin from the currently selected acquisition. The Play button changes to a Pause button when playback is active. Acquisitions are played until playback reaches the end of the history. At this point, playback stops, and the Play button is grayed out.
	Rewind	The Rewind button takes you back to the acquisitions where you pressed the Play button.
	Reset	The Reset button takes you back to the first acquisition in the history. When you are at the beginning of the history the button is grayed out.

The waveforms can be viewed in the graticule for the selected acquisitions from history badge. You can navigate the total number of acquisitions in history. Double-tap a badge to open its configuration menu.

When **Include Reference Acquisition in Badge** is selected from the right click menu of the History badge, the badge displays the following information:

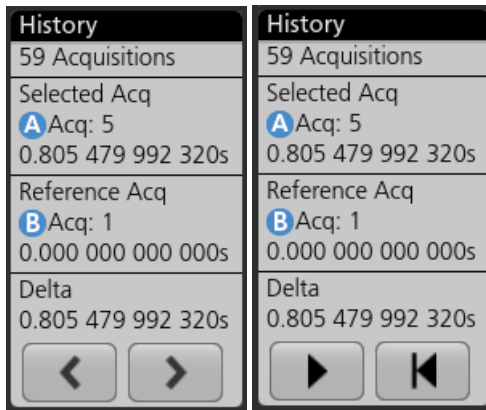

The Reference acquisition readout shows the timestamp when the acquisition occurred in time in history. It also displays the delta between the Selected acquisition and the Reference acquisition timestamps.

There are two ways to delete the History badge.

- Right-click the badge and select **Disable Acquisition History**.
- Flick the badge off the right edge of the display to remove it from the **Results** bar. Flicking left from the right edge of the **Results** bar recovers the badge. Badge recovery is only possible within 10 seconds of removal.

## System badges



System badges (in the settings bar) display the main Horizontal, Acquisition, and Trigger settings. You cannot delete System badges.

Horizontal	Trigger	Acquisition
1 $\mu$ s/div    10 $\mu$ s SR: 3.125 GS/s    320 ps/pt RL: 31.25 kpts    50%	<b>2</b> Runt  U: 2.28 L: 800 m	Auto, Analyze High Res: 12 bits 10.379 kAcqs

Double-tap a System badge to open its configuration menu.

The Horizontal badge also has Scale buttons, shown by single-tapping the badge. Use the Horizontal Scale buttons to increase or decrease the horizontal time setting.

## Common badge actions

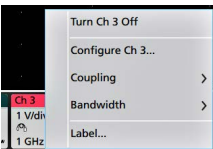
Action	Result	Example
Single tap	Immediate access controls (Scale, Navigation).	
Double tap	Configuration menu with access to all settings for the badge.	
Touch and hold	Right-click menu with single tap access to common actions. Typical actions include turning off a channel and deleting a measurement or search badge.	
Flick	Flick the badge off the bottom edge of the display to remove it from the <b>Settings</b> bar. Flick the badge off the right edge of the display to remove it from the <b>Results</b> bar. Flick from the right or bottom edge to recover a removed badge. This action is only possible within 10 seconds of badge removal.	

## Badge selection status

The appearance of a badge indicates its selection status (selected or unselected), or if a measurement needs to be deleted to close a channel or waveform badge.

Badge type	Selected	Unselected	Turned off or in use
Channel or Waveform			
Measurement			N/A

A dimmed Channel badge means the screen waveform is turned off (but not deleted). A dimmed Waveform badge means that the waveform display is turned off, or it is being used as a source by a measurement and cannot be deleted until the measurement is deleted.

## Moving waveform and measurement badges

You can move waveform and measurement badges within their display bars to meet your measurement needs. Simply touch and drag the badge to a new position.

### Moving waveform badges in the Settings Bar

- A waveform badge can only be moved within the Settings Bar.
- Dragging a waveform badge to a new location selects that waveform.
- Dragging a badge to a new location causes the non-selected badges to move slightly to create the position at which to insert the badge.
- To move a badge to a position that is off screen of the displayed bar badges (scroll buttons are present), drag the badge that you're moving onto one of the scroll buttons. The badges that are off screen shift onscreen one at a time until you move the badge off of the scroll button and position it in the displayed badges.
- Changing the order of waveform badges or badge groups also changes the order of displayed waveforms in the Waveform view. The order of badges or badge groups (left to right) in the Settings bar determines the order of slices in the display (top to bottom).
- Once you have moved any waveform badge (Channel, Math, Ref, Bus, Trend) on the Settings bar to a new position, adding a new badge adds that badge to the right of the existing badges. This differs from the default badge addition action, which listed badges together by category (Channels, Math, Ref, Bus) and arranged the badges in numerical order within each badge category. To restore the default badge addition method, tap **File > Default Setup** and add the waveform badges back onto the Settings bar.
- Changing the order of bus waveform badges changes the order of the tabs in a bus decode Results table.

### Moving badges in the measurement Results Bar

- A Measurement or Search badge can only be moved within the Results Bar.
- Dragging a badge to a new location causes the non-selected badges to move to create the position at which to insert the badge.
- Once you have moved any Results badge to a new position, adding a new Measurement or Search badge adds that badge to the bottom of the Results bar badges.
- To move a badge to a position that is off screen of the displayed bar badges (scroll buttons are present), drag the badge that you're moving onto one of the scroll buttons. The badges that are off screen shift onscreen one at a time until you move the badge off of the scroll button and position it in the displayed badges.
- Changing the order of Measurement badges in the Results bar changes the order of measurements shown in a Results table.

- Changing the order of Search badges in the Results Bar changes the order of the tabs shown in a Search Results table.
- Changing the order of harmonics badges in the Results bar changes the order of the tabs shown in a Harmonics Results table.

## Badge grouping

You can group signal badges in the Settings bar to display multiple waveforms in a single slice. See [Group signal badges in the Settings bar](#) on page 65 for more information. See the [Group signal badges in the Settings bar](#) topic.

## Group signal badges in the Settings bar

You can group signal badges in any combination of channel, waveform, math, reference and bus badges to display related waveforms in the same display slice. Use this feature to group related signals for easier visual comparisons.

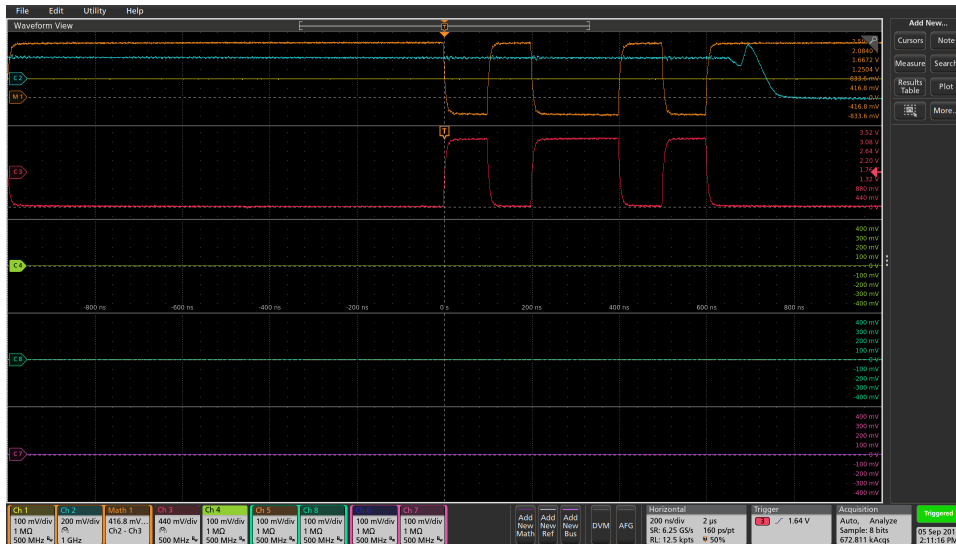

To group one or more signal badges, drag a badge onto another badge until the background badge turns red, then release. Repeat to add other badges to a group. Each group is shown in its own slice as a set of overlaid waveforms.

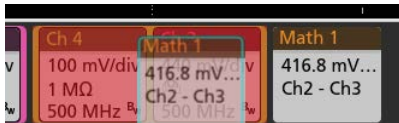

## Badge group characteristics

- Badges in a group are listed left to right in the order they were added to the group.
- The badge group color is the color of the last selected badge in the group.
- Use standard touch and menu interactions to select and change individual badge settings.
- You can drag and move badge groups the same way as individual badges.
- The order of badges or badge groups (left to right) determines the order of slices in the display (top to bottom).
- To ungroup a single badge, drag it vertically and release. You can also ungroup a single badge by touching and holding a badge in the group to open its right-click menu, and select Ungroup Badge(x) to ungroup the selected badge.
- To ungroup the entire group, touch and hold any badge in the group to open its right-click menu. Select to ungroup the selected badge or ungroup all of the badges.

## Badge group caveats

- You cannot drag badges within a group to change their order.

- You cannot add one badge group to another.
- You cannot drag a badge group onto an individual badge to group those badges.
- You cannot drag a badge group onto the Trash icon to ungroup or delete those badges.

## Configuration menus

Configuration menus let you quickly set the parameters for channels, system settings (Horizontal, Trigger, Acquisition), measurements, cursor readouts, Waveform and Plot views, callout text, and so on.

Double-tap an item (badge, **Waveform View** or **Plot View**, cursor readouts, callout text, and so on) to open its configuration menu. For example, double-tap a Channel badge in the **Settings Bar** to open its configuration menu.

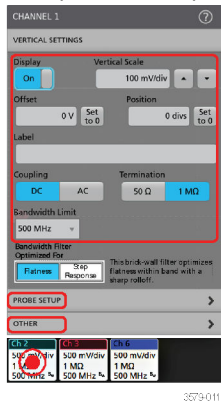

3573-011

Selections or values that you enter take effect immediately. Menu contents are dynamic, and can change depending on your selections, instrument options, or attached probes.

Related settings are grouped into 'panels'. Tap the panel name to show those settings. Changes to panel settings can change the values and/or fields shown in that panel and other panels.

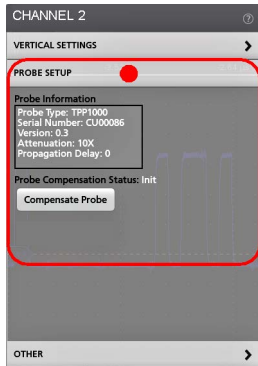

Tap anywhere outside a configuration menu to close it.

To open Help content for a configuration menu, tap the question mark icon in the upper right corner of the menu.

## Zoom user interface

Use the zoom tools to magnify waveforms to view signal details.



1. The **Zoom Overview** shows the entire waveform record. All waveforms are shown in Overlay mode in the Zoom Overview area. Using pinch and expand gestures on the Zoom Overview waveforms changes the horizontal time base settings.
2. The **Zoom Box** shows the area of the Zoom Overview to display in the Zoom View (see 5). You can touch and drag the box to move the area to view. Moving the Zoom Box, or changing its position, does not change the horizontal time base settings. You can also use the zoom **Pan** knob to move the Zoom Box left or right.
3. The **Zoom** icon (in the upper right corner of the Waveform View) switches zoom mode on and off.
4. The **DRAW-A-BOX** button toggles between drawing a zoom box (default mode), drawing areas for the **Visual Trigger** function, drawing segments for **Mask** testing, and drawing the **Waveform Histogram** for waveform analysis. The button is located at the bottom of the **Results Bar**.

A zoom box lets you quickly draw a box around an area of interest in the Waveform or Zoom Overview. Drawing a box immediately puts the oscilloscope into zoom mode. To draw a zoom box, tap the DRAW-A-BOX button (while in Zoom mode), then touch and drag on the waveform to draw a box waveform. You can continue to draw zoom boxes until you single tap anywhere on the screen or open a menu.

To toggle between **Zoom** mode, **Visual Trigger** mode, and **Mask** mode, double-tap the **DRAW-A-BOX** button and select one of the options. Search for the **Visual Trigger** and **Mask Testing** topics in the oscilloscope Help for more information.

5. The **Zoom View** shows the zoomed waveforms, as marked by the Zoom Box, in the Zoom Waveform Record View. Use pinch and/or drag options in the zoom view to change the zoomed area of interest. Pinch, expand, and drag gestures in the Zoom View only change zoom magnification settings and Zoom Box position.
6. Use the **Zoom Title Bar** controls to adjust the vertical and horizontal size of the zoom area. Click or tap the + or - buttons or use the A and B multipurpose knobs.

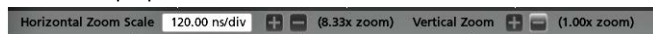

In a waveform view, if both Cursor and Zoom are turned on, use the **Zoom Box** and **Cursors** button to change the multipurpose knob functionality. Tap the **Zoom Title Bar** to assign the knobs to adjust the zoom or tap the **Cursors** button to assign knobs to adjust the cursors.

Double tap the **Horizontal Zoom Position** or **Horizontal Zoom Scale** fields to enter a value using a numerical keypad.



To exit the zoom display mode, tap the Zoom icon in the corner of display or tap the X in the Zoom Title Bar.

## Using the touch screen interface for common tasks

Use standard touch screen actions, similar to those found on smart phones and tablets, to interact with most screen objects. You can also use a mouse to interact with the UI. The equivalent mouse operation is shown for each touch operation.

The oscilloscope has a user interface tutorial. Tap **Help > User Interface Tutorial** to quickly learn the fundamental touch operations.

**Table 2: Common touchscreen UI tasks with mouse equivalents**

Task	Touchscreen UI action	Mouse action
Add a channel, math, reference, or bus waveform to the screen.	Tap an inactive channel button, <b>Add New Math</b> , <b>Add New Reference</b> , or <b>Add New Bus</b> button.	Click an inactive channel button, <b>Add New Math</b> , <b>Add New Reference</b> , or <b>Add New Bus</b> button.
Select a channel, math, reference, or bus waveform to make it active	Stacked or Overlay mode: Tap the Channel or Waveform badge.	Stacked or Overlay mode: Left-click the Channel or Waveform badge.
	Stacked mode: Tap the channel, math, reference, or bus waveform slice or handle.	Stacked mode: Left-click the channel, math, reference, or bus waveform slice or handle.
	Overlay mode: Tap the channel or waveform handle.	Overlay mode: Left-click the channel or waveform handle.
Display scale or navigation buttons on a badge (waveform, measurement, search, horizontal). Not all measurement or search badges display navigation buttons.	Tap the badge.	Click the badge.
Open a configuration menu on any item (all badges, views, cursor readouts, labels, and so on).	Double-tap the badge, view, or other object.	Double-click the badge, view, or other object.
Open a right-click menu (badges, views).	Touch and hold on the badge, Waveform View, Plot view, or other screen item until a menu opens.	Right-click the object.
Close a configuration menu. Some dialog boxes will not close until you click an OK, Close, or other button in the dialog.	Tap anywhere outside the menu or dialog.	Click anywhere outside the menu or dialog.
Move a menu.	Touch and hold the menu title bar or a blank area in the menu, then drag the menu to new position.	Click and hold the right mouse button on title or blank area, drag to new position.
Move a callout. Callouts are screen objects and are not associated with any particular waveform channel or slice.	Touch and hold on a callout and quickly start to drag, then move to new position. Start to move the callout as soon as selected (highlighted), otherwise the UI opens the right-click menu.	Click and hold the right mouse button on the callout and quickly start to drag, then move to the new position.
Change horizontal or vertical settings directly on a waveform. Vertical changes only apply to the selected channel or waveform; horizontal changes apply to all channels and waveforms.	Tap a badge and use the Scale buttons.	Left-click a channel, waveform, or <b>Horizontal</b> badge and click on the Scale buttons.
	Touch and hold two fingertips on the waveform view, move them together or apart vertically or horizontally, lift from screen; repeat.	

Table continued...



Task	Touchscreen UI action	Mouse action
Increase or decrease the zoom area while in Zoom mode.	Touch and hold two fingertips on the waveform view, move them together or apart vertically or horizontally, lift from screen; repeat.	Click the <b>+</b> or <b>-</b> buttons on the Zoom Title bar. Click the <b>Draw-a-Box</b> button, draw a box around the waveform area of interest.
Quickly scroll or pan a waveform or list.	Touch and drag in the waveform or list.	Click and drag in the waveform or list.
Close or open the <b>Results Bar</b> to increase the <b>Waveform View</b> area.	Tap on the <b>Results Bar Handle</b> (three vertical dots in border) or anywhere in the border between the <b>Waveform View</b> and the <b>Results Bar</b> .	Click the <b>Results Bar Handle</b> (three vertical dots in border) or anywhere in the border between the <b>Waveform View</b> and the <b>Results Bar</b> .
		Click and drag the Results Bar divider.
Change the position of badges in the <b>Settings Bar</b> or <b>Results Bar</b> .	Touch and drag the badge to a new position in the same bar.	Click and drag the badge to a new position in the same bar.

## Accessing application help

Use the instrument online help to quickly get information about a function or assistance in performing a task.

### Using context-sensitive help

To access the user interface on a Low Profile instrument, connect a monitor to a video port on the rear of the instrument, and connect a mouse to any USB Host port. You do not need to connect a mouse if your remote monitor is touch-capable. You can also remotely access the user interface of a network-connected instrument by entering the instrument's IP address in a web browser.

To open help on a particular menu or item, tap the Help button (question mark symbol) in the title bar. The browser opens with content relevant to the menu or item.

### Navigating the online help

Select **Help > Help**. The Help Browser is similar in look and feel to PC-based Help tools.



**Note:** The Help tool does not have a virtual keyboard. Connect a keyboard to your instrument to enter text in the search fields of the Search or Index tabs.

From the help browser, select one of the following tabs:

- **Contents Tab.** Click any entry to display information on the subject.
- **Search Tab.** Type in the keyword you are looking for; then click List Topics. Every topic that contains the keyword will be displayed. Select a topic, and then click Display to open the topic.

### Other help features

Zoom on help text. Use the magnifying glass icons to zoom in or out of the help text.

## ESD Prevention Guidelines

Electrostatic discharge (ESD) can damage oscilloscope and some probe inputs. This topic discusses how to avoid this type of damage.

Electrostatic discharge (ESD) is a concern when handling any electronic equipment. The instrument is designed with robust ESD protection, however it is still possible that large discharges of static electricity directly into the signal input may damage the instrument. Use the following techniques to prevent electrostatic discharge from damaging the instrument.

- Discharge the static voltage from your body by wearing a grounded antistatic wrist strap while connecting and disconnecting cables, probes, and adapters. The instrument provides a ground connection to which to attach a wrist strap (on the Probe Comp ground connector).
- A cable that is left unconnected on a bench can develop a large static charge. Discharge the static voltage from all cables before connecting them to the instrument or device under test by momentarily grounding the center conductor of the cable, or by connecting a 50  $\Omega$  termination to one end, before attaching the cable to the instrument.
- Before you apply power, connect the instrument to an electrically-neutral reference point, such as earth ground. To do this, plug the three-pronged power cord into an outlet grounded to earth ground. Grounding the oscilloscope is necessary to ensure safety and to take accurate measurements.
- If you are working with static sensitive components, ground yourself. Static electricity that builds up on your body can damage static-sensitive components. Wear a wrist strap to safely send static charges on your body to earth ground.
- The oscilloscope must share the same ground as any circuits that you plan to test.

# Configure the instrument

Configurations to help operate your instrument efficiently.

## Set the time zone and clock readout format

Set the time zone to your region so that saved files are marked with the correct date and time information. You can also set the time format (12 or 24 hour clock).

### About this task

To access the user interface on a Low Profile instrument, connect a monitor to a video port on the rear of the instrument, and connect a mouse to any USB Host port. You do not need to connect a mouse if your remote monitor is touch-capable. You can also remotely access the user interface of a network-connected instrument by entering the instrument's IP address in a web browser.

To remotely set a control or run this task on a Low Profile instrument, see the instrument Programmer Manual (Tektronix part number 077-1305-xx) for the correct command or commands to use.

### Procedure

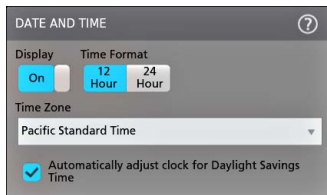

1. Double-tap the **Date/Time** badge (bottom-right of screen) to open the configuration menu.
2. To turn off showing the date and time on the screen, tap **Display** button to **Off**.  
To turn on date/time display again, double-tap in the blank area where the date/time badge was displayed to open the configuration menu, and set the **Display** button to **On**.
3. Select a time format (**12 Hour** or **24 Hour**).
4. Tap the **Time Zone** field and select the time zone that applies to your location.
5. Tap anywhere outside of the menu to close it.

## Functional check

Use this procedure to quickly verify that the oscilloscope can display a waveform and take a measurement.

To access the user interface on a Low Profile instrument, connect a monitor to a video port on the rear of the instrument, and connect a mouse to any USB Host port. You do not need to connect a mouse if your remote monitor is touch-capable. You can also remotely access the user interface of a network-connected instrument by entering the instrument's IP address in a web browser.

To remotely set a control or run this task on a Low Profile instrument, see the instrument Programmer Manual (Tektronix part number 077-1305-xx) for the correct command or commands to use.

1. Power on the oscilloscope.
2. Tap **Utility** > **Self test**. Check that all tests listed show **Pass**.
3. Connect an analog probe to the Channel 1 connector.
4. Connect the oscilloscope tip and ground lead to the probe compensation connectors.
5. Push the **Autoset** button. You should see a square wave in the display (approximately 5 V<sub>P-P</sub>).
6. Tap the **Add New...Measure** button.

7. Tap the **Timing Measurements** panel in the Add Measurements configuration menu.
8. Double-tap the **Frequency** button to add the frequency measurement to the Results bar.
9. Check that the **Frequency** measurement reads 1 kHz.
10. Repeat these steps to check the other channels on the oscilloscope. Make sure that you set the source in the Add Measurement configuration menu to use the correct channel before adding the Frequency measurement.

## Download and install the latest instrument firmware

Installing the latest firmware helps ensure that your instrument has the latest features and is taking the most accurate measurements.

### Before you begin

Save any important on-instrument files (waveforms, screen captures, setups, and so on) to a USB drive or network. The installation process does not remove user-created files, but it is a good idea to back up important files before an update.

To access the user interface on a Low Profile instrument, connect a monitor to a video port on the rear of the instrument, and connect a mouse to any USB Host port. You do not need to connect a mouse if your remote monitor is touch-capable. You can also remotely access the user interface of a network-connected instrument by entering the instrument's IP address in a web browser.

### Procedure

1. Power on the oscilloscope.
2. Determine the current version of firmware installed on the instrument in the **About** window under the **Help** menu
3. Check the version of the latest available firmware at the [tek.com/software](http://tek.com/software). Enter the model number of your oscilloscope in the search box and search for the firmware.  
If the firmware version on the web is newer than what is currently installed, update your instrument firmware.
4. Install the firmware on embedded OS instruments.
  - a) Download the latest firmware and unzip the files on your PC.  
For the MSO44 and MSO46, follow the installation instructions that came with the downloaded firmware to create the firmware install file or files.
  - b) Copy the designated firmware file into the root folder of a USB flash drive.
  - c) Insert the USB flash drive into a USB port on your oscilloscope. The instrument automatically recognizes the firmware install file and starts the installation process.  
For the MSO44 and MSO46, follow the instructions that came with the downloaded firmware to install the firmware.
  - d) Follow any on-screen instructions. The oscilloscope take about 10 minutes to install the new firmware.  
Do not remove the USB flash drive or power off the instrument during this time.
  - e) After the oscilloscope displays a message that it has completed the upgrade, the scope will reboot automatically.  
For the MSO44 and MSO46, you must manually power off the instrument after installation. Remove the USB from the MSO44 and MSO46 while the instrument is powered off.
5. Install firmware on instruments with the Windows option.
  - a) Close **TekScope** before updating the firmware.
  - b) Insert the USB drive into an instrument USB Host port.
  - c) Open the Windows desktop File Explorer and select the install file.
  - d) Run the firmware update file from the USB drive, or copy the firmware update file to the desktop and run the file from there.
  - e) Follow the on-screen instructions to install the firmware.  
Do not remove the USB flash drive or power off the instrument during this time.
  - f) When the firmware install is finished, remove the USB drive and restart the instrument.

## What to do next

To confirm the firmware update, locate the version number found in the **About** window under the **Help** menu. Confirm that the instrument firmware version number matches the firmware version number that you just installed.

## Run Signal Path Compensation (SPC)

Run SPC when you first receive an instrument, and at regular intervals, for best measurement accuracy. You should run SPC whenever the ambient (room) temperature has changed by more than 5 °C (9 °F), or once a week if you use vertical scale settings of 5 mV per division or less.

### About this task

To access the user interface on a Low Profile instrument, connect a monitor to a video port on the rear of the instrument, and connect a mouse to any USB Host port. You do not need to connect a mouse if your remote monitor is touch-capable. You can also remotely access the user interface of a network-connected instrument by entering the instrument's IP address in a web browser.

Signal Path Compensation (SPC) corrects for DC level inaccuracies in the internal signal path, caused by temperature variations and/or long-term signal path drift. Failure to run SPC on a regular basis may result in the instrument not meeting warranted performance levels at low volts per division settings.

### Before you begin

Disconnect all probes and cables from the front-panel channel inputs and rear-panel signal connectors.



**Note:** You do not need to disconnect input signal cables from an LPD64 to run SPC. The LPD64 has a new unique input isolation capability that lets you keep signal cables connected during SPC.

### Procedure

1. Power on and warm up the instrument for at least 20 minutes.
2. Tap **Utility > Calibration**.
3. Tap **Run SPC**. The **SPC Status** readout shows **Running** while SPC is running. SPC can take three minutes approximately per channel to run, so wait until the SPC Status message changes to **Pass** before reconnecting probes or cables and using the instrument.



**CAUTION:** You can abort the SPC calibration by tapping **Abort SPC**. This may leave some channels uncompensated, resulting in possible inaccurate measurements. If you do abort the SPC, make sure to run the SPC procedure completely before using the instrument to take measurements.

4. Close the **Calibration** configuration dialog when SPC has completed.  
If the SPC fails, write down any error message text. Make sure that all probes and cables are disconnected (except for the LPD64) and run the SPC again. If the SPC still fails, contact Tektronix Customer Support.

## Compensate the TPP Series probes

Probe compensation adjusts the high frequency response of a probe for best waveform capture and measurement accuracy. The oscilloscope can automatically test and store compensation values for an unlimited number of probe/channel combinations.

### About this task

To access the user interface on a Low Profile instrument, connect a monitor to a video port on the rear of the instrument, and connect a mouse to any USB Host port. You do not need to connect a mouse if your remote monitor is touch-capable. You can also remotely access the user interface of a network-connected instrument by entering the instrument's IP address in a web browser.

To remotely set a control or run this task on a Low Profile instrument, see the instrument Programmer Manual (Tektronix part number 077-1305-xx) for the correct command or commands to use.



**Note:** Probe compensation does not apply to the LPD64 instrument.

The oscilloscope stores the compensation values for each probe/channel combination, and automatically recalls the compensation values when you plug in the probe. Probe compensation status is shown in the Probe Setup panel of the Channel configuration menu.

- If the Probe Compensation Status field displays **Pass**, the probe is compensated and ready for use.
- If the Probe Compensation Status field displays **Default**, the attached probe has not been compensated and needs to have this probe compensation procedure run.
- If the Probe Compensation Status field displays **Fail**, the attached probe has failed the probe compensation procedure. Reconnect the probe and run probe compensation again.
- If there is no probe compensation status field shown in the panel, the oscilloscope cannot store compensation values for that probe. See the oscilloscope Help for how to manually compensate passive probes not supported by the probe compensation function.

### Before you begin

The oscilloscope must be powered on for at least 20 minutes before compensating a probe.

### Procedure

Use this procedure to compensate supported TPP-family probes that show a **Default** status when connected to the oscilloscope.



**Note:** Doing a **Default Setup** does not delete probe compensation values. A factory calibration does delete all stored probe compensation values.

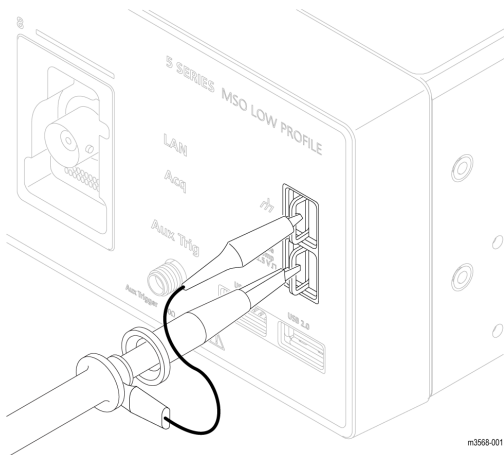
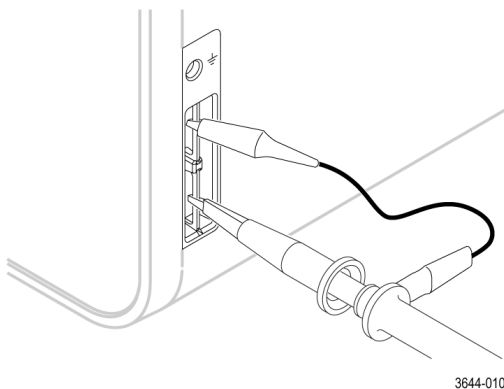

1. Connect a supported probe to an input channel.
2. Connect the probe tip and ground lead of the probe to the **PROBE COMP** terminals.



**Note:** Connect only one probe at a time to the PROBE COMP terminals.

3. Turn off all channels.
4. Turn on the channel to which the probe is connected.
5. Push the front-panel **Autoset** button. On the MSO58LP, select **File > Autoset** from the menu bar. The screen displays a square wave.
6. Double-tap the badge of the channel that you want to compensate.
7. Tap the **Probe Setup** panel.  
If the Probe Compensation Status says **Pass**, the probe is already compensated for this channel. You can move the probe to another channel and start again from step 1, or connect a different probe to this channel and start from step 1. If the Probe Compensation Status says **Default**, continue with this procedure.
8. Tap **Compensate Probe** to open the **Probe Compensation** dialog.
9. Tap **Compensate Probe** to run the probe compensation.
10. The probe compensation is finished when the Probe Compensation Status displays **Pass**. Disconnect the probe tip and ground from the PROBE COMP terminals.
11. Repeat these steps for each supported passive probe that you want to compensate for this channel.
12. Repeat these steps to compensate supported probes on other channels of the oscilloscope.



**Note:** For most accurate measurements, open the **Probe Setup** panel and verify the Probe Compensation Status is **Pass** whenever you attach a probe to a channel.

## Compensate passive probes

Probe compensation adjusts the high frequency response of a probe for best waveform capture and measurement accuracy. Use this procedure to adjust probe compensation for probes with a manual adjustment.

To access the user interface on a Low Profile instrument, connect a monitor to a video port on the rear of the instrument, and connect a mouse to any USB Host port. You do not need to connect a mouse if your remote monitor is touch-capable. You can also remotely access the user interface of a network-connected instrument by entering the instrument's IP address in a web browser.

To remotely set a control or run this task on a Low Profile instrument, see the instrument Programmer Manual (Tektronix part number 077-1305-xx) for the correct command or commands to use.



**Note:** Probe compensation does not apply to the LPD64 instrument.

A passive probe is only adjusted for one channel at a time. If you move a passive probe to another channel, you must compensate that probe to that channel.

1. Connect the probe to the channel where you want to use it to take measurements. Remove all other probes.
2. Turn on the channel to which the probe is connected. Turn off all other channels.
3. Attach the probe tip and reference lead to the probe compensation connectors.
4. Push the **Autoset** button to display a square wave.
5. Adjust the vertical **Scale** and **Position** knobs to display as large a waveform as possible.
6. Use the adjustment tool provided with the probe to adjust the probe until the square wave has as flat a top as possible. See your probe manual for adjustment location and instructions.

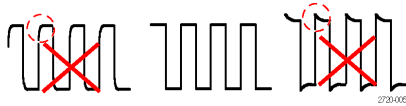

## Connect to a network (LAN)

Connecting to a network allows you to remotely access the instrument.

To access the user interface on a Low Profile instrument, connect a monitor to a video port on the rear of the instrument, and connect a mouse to any USB Host port. You do not need to connect a mouse if your remote monitor is touch-capable. You can also remotely access the user interface of a network-connected instrument by entering the instrument's IP address in a web browser.

Work with your network administrator to obtain the required information to connect to your network (IP address, Gateway IP address, Subnet Mask, DNS IP address, and so on).

1. Connect a CAT5 cable from the instrument LAN connector to your network.
2. Select **Utility > I/O** on the menu bar to open the I/O configuration menu.
3. Obtain or enter the network address information:
  - If your network is DHCP-enabled, and the IP address field does not already show an address, tap **Auto** to obtain the IP address information from the network. DHCP mode is the default mode.
  - If your network is not DHCP-enabled, or you need a permanent (non-changing) IP address for this instrument, tap **Manual** and enter the IP address and other values provided by your IT or system administrator resource.
4. Tap **Test Connection** to verify that the network connection is working. The **LAN Status** icon turns green when the instrument successfully connects to your network. If you have problems connecting to your network, contact your system administration resource for help.

The front panel LAN status LED colors display the network connection status:

- Off: No power to the instrument
- Green: Network connection is good
- Red: Network connection has a fault or is not connected

## Mount a network drive from a standard instrument

Use this procedure to mount (map) a network Linux mount point or Windows shared directory on a standard (non Windows OS) instrument.

**Prerequisites:** The oscilloscope must be connected to a network that has access to the directories to mount or unmount. See [Connect to a network \(LAN\)](#) on page 76.

To mount a Linux network drive on the oscilloscope, the network Linux mount point (drive, host) that you want to mount must be exported. If the mount point is not exported, work with your organization's IT resource to get that location exported and accessible to your network.

To mount a Windows network drive on the oscilloscope, the network Windows directory location that you want to mount must be set to shared. If the Windows directory is not shared, work with your organization's IT resource to get that location shared and accessible to your network.

To mount a network drive on your standard oscilloscope:

1. Tap **File > File Utilities**.
2. Tap **Mount** to open the **Mount Drive** menu.
3. Select **Network** in the Drive Type.
4. Select the drive letter to assign to the network drive from the **Drive Letter** list.



5. Tap **Name** or **IP** to specify how you will enter the host name (server) of the network mount location or PC.
6. Enter the network host name or IP address of the Linux mount point or Windows PC or server in the **Server Name** or **Server IP Address** field. Example: ACME-PC0205
7. Enter the path to the location of the mount point or shared directory of the server in the **Path** field.  
Linux example: /opt/testing/batch1 (Linux requires forward slashes in path definitions. Linux assumes that the path starts at the root directory.)
  - Linux example: /opt/testing/batch1 (Linux requires forward slashes in path definitions. Linux assumes that the path starts at the root directory.)
  - Windows example: \\Users\adamt\Desktop\testing\batch1 (Windows requires back slashes in path definitions. The double back slashes (\\) denotes the root directory as the starting point for locating the specified directory.)
8. If access to this network location is controlled, enter the required information in the **User Name**, **Password**, and **Domain/Workgroup** fields.
9. Tap **OK**. The oscilloscope mounts the drive and adds the specified drive letter to the **Drive** column in the **File Utilities** menu.  
The oscilloscope displays an error message if it cannot mount the drive. Work with your organization's IT resource to verify that the access information is correct and to resolve the network access problems.



**CAUTION:** The Linux ScopeApp does not support SMB version 1.0 for CIFS network mounts.

## Mount a network drive on the Windows 10 instrument

Use this procedure to mount (map) a network Linux mount point or Windows shared directory on a Windows OS instrument. Use the network drive to store or access files from the oscilloscope.

**Prerequisites:** The oscilloscope must be connected to a network that has access to the directories to mount or unmount.

See [Connect to a network \(LAN\)](#) on page 76.

The oscilloscope must be added to your organization's network domain to mount network drives and be set to enable network discovery. Work with your organization's IT resource to configure the instrument.

To mount a Linux network drive on the oscilloscope, the network Linux mount point (drive, host) that you want to mount must be exported. If the mount point is not exported, work with your organization's IT resource to get that location exported and accessible to your network.

To mount a Windows network drive/folder on the oscilloscope, the network Windows folder location that you want to mount must be set to shared. If the Windows folder is not shared, work with your organization's IT resource to get that folder shared and accessible to your network.

To mount a network folder on your Windows OS oscilloscope:

1. Tap **File > File Utilities** to open the file utilities window.
2. Select **Network** in the Drive Type.
3. Click on **Open File Explorer** to open the windows explorer window.
4. Tap **This PC** in the path field to move to the This PC directory.
5. Tap and hold the **This PC** text on the left side of the pane to open the context menu.
6. Tap **Map Network Drive** to open the **Map Network Drive** menu.
7. Use standard Windows practices to set the drive letter and specify the path to the network folder. If access to the specified folder has security settings, you must enter the correct user and password information when requested.
8. The network folder is added to **This PC > Devices and Drives** listing.

If you have problems accessing a network folder, work with your organization's IT resource to verify that the folder is shared and that you are using the correct user name and password.

## Mount TekDrive

TekDrive is a collaborative T&M data workspace provided with the purchase a supported Tektronix product.

### Before you begin

This mounting procedure is applicable for both Windows and LINUX platforms. You must have internet connectivity access to perform this procedure.

Browse to [drive.tekcloud.com](https://drive.tekcloud.com), register, and create a new account.

- The TekDrive mount feature is supported on 4/5/6 Series MSO instruments.
- The maximum upload file size limit to TekDrive is restricted to 25 GB.
- When the TekDrive is enabled, you cannot copy and paste for files and folders in the TekDrive.
- In some scenarios, recalling the files from the TekDrive is not supported and you will not see it listed in the file browser, but you can continue recalling the file through USB/Network or Local drives. For example, Math Filter files cannot be recalled/applied from the Math advanced menu if it is stored in the TekDrive.
- When a TekDrive is unmounted or auto-disconnected, the waveform files activated from it would continue to work until you recall the defaults, run TekSecure®, or change the reference waveform file.

### About this task

Use TekDrive to upload, store, organize, search, download, and share arbitrary files from any connected device. Use the following procedure to mount (map) a TekDrive.

### Procedure

1. Tap **File > File Utilities**.
2. Tap **Mount** to open the **Mount Drive** menu.
3. Select the **TekDrive** button under **Drive Type**
4. Enter the **Drive Name**.
5. Select the required **Auto Disconnect** option.
6. Tap **Connect to TekDrive** to display the window with the QR and numeric code for TekDrive activation.
7. Browse to [drive.tekcloud.com/activate](https://drive.tekcloud.com/activate) to login using your credentials and enter the numeric code displayed in the Mount Drive window.  
Register and create a new account if you are a new user.  
A message is displayed when activation is successful.
8. After activation, click **OK, mount Tekdrive** to complete the mounting process.  
The connected TekDrive is available in all file browsing windows.

## Unmount a network drive from a standard instrument

Use this procedure to unmount (remove, disconnect) a network Linux mount point from a standard (non-Windows 10) instrument.

To unmount a network drive from your instrument:

1. Tap **File > File Utilities**.
2. Select the drive to unmount in the **Drive** column.
3. Tap **Unmount**. The instrument immediately unmounts the drive and removes it from the Drive column.

## Unmount a network drive from the Windows 10 instrument

Use this procedure to unmount (remove, disconnect) a network drive from a Windows 10 instrument.

To unmount a network drive from your Windows 10 instrument:

1. Open Windows Explorer window.
2. Tap **This PC** in the list to move to the This PC directory.
3. Select the network drive/folder to unmount.
4. Tap and hold, or right/click, the selected drive to open a context menu.
5. Tap **Disconnect** to unmount the drive. the drive is immediately removed from the list.

## Unmount a TekDrive

Use this procedure to unmount (remove, disconnect) a TekDrive.

### Procedure

1. Tap **File > File Utilities**.
2. Select the TekDrive to unmount in the **Drive** column.
3. Tap **Unmount**.  
The drive is unmounted and it is removed from the **Drive** column.

## Connect the oscilloscope to a PC using a USB cable

Use a USB cable to connect the oscilloscope directly to a PC for remote instrument control.

1. On the oscilloscope, select **Utility > I/O** from the menu bar.
2. Tap **USB Device Port Settings**.
3. Confirm that the USB Device Port control is **On** (default setting).
4. Connect a USB cable from the PC to the USB **Device** port on the instrument.
5. If using the USB connection to remotely control the oscilloscope using GPIB commands, set the **GPIB Talk/Listen Address** for your configuration (0 - 30).

## Remote access from a Web browser

You can remotely access your network-connected standard instrument (not running Windows) from a Web browser to display the instrument user interface on a PC.

This procedure describes how to remotely access the UI controls and screen for standard (non Windows 10) instruments. To remotely access the UI controls and screen for Windows 10 instruments, see the *Remote access to a Windows 10 instrument* topic in the Help.

### Prerequisites:

- The instrument must be connected to, and accessible from, the network to which the PC is connected. See [Connect to a network \(LAN\)](#) on page 76
- The IP address of the instrument that you want to access. To determine the instrument's IP address, select **Utility > IO** in the instrument menu bar and view the network settings in the **LAN** panel.
- You are accessing a standard (instrument that does not have the Windows OS option installed).

Use below procedure to remotely access the UI controls and screen for standard (non Windows 10) instruments using e\*Scope® functionality.

1. Open a Web browser on a PC connected to the same network as the instrument.
2. Enter just the instrument IP address on the URL line of the browser and press **Enter**. For example: 135.62.88.157. The browser searches for and opens the Web page for the instrument.
3. Select **Instrument Control (e\*Scope)**. The browser displays the instrument screen. If a password is set for the e\*Scope, an Enter Password window will popup. Enter the password and tap **Submit**. If the password is input incorrectly five times, it will block the e\*Scope for five minutes.
4. Use a mouse to select and interact with the instrument controls shown in the Web browser. If your remote PC or laptop has a touch screen monitor, you can use the remote touchscreen monitor to access the instrument controls.

Close the browser to logout the session.

**Note:** If connection error occurs, refresh the page in the web browser or restart the web browser for seamless interaction with the instrument remotely.

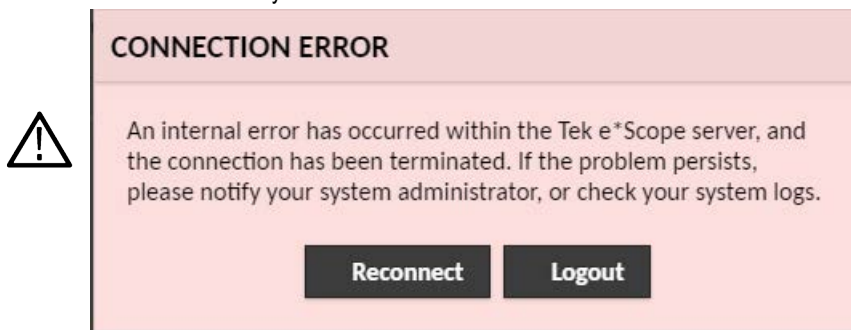

When you access the instrument from an e\*Scope browser, you cannot directly paste text (such as path, IP address information, and so on) from the PC to an instrument menu field. You must use an intermediate clipboard function that is available in the e\*Scope application. Use the following steps to copy text from an e\*Scope-connected PC to the instrument:

1. Open a connection to the instrument using **e\*Scope**.
2. Select and copy the text on your PC.
3. In e\*Scope, press **Ctrl-Alt-Shift** to open the **Clipboard** menu.
4. Paste the text into the Clipboard field.
5. Press **Ctrl-Alt-Shift** to close the browser Clipboard menu.
6. Use e\*Scope to open the instrument menu to which to paste content, and position the cursor in the field where you want to paste the text.
7. Press **Ctrl-V** (on real keyboard or from virtual keyboard) to paste the text from the e\*Scope browser clipboard to the menu field.
8. Repeat steps 2 on page 80 through 7 on page 80 to copy and paste other text from the PC to the instrument.

## Remote access to a Windows 10 instrument

Access to the graphical interface of a Windows 10 instrument requires installing software called TightVNC on both the PC and the oscilloscope. This procedure describes how to use TightVNC to access the instrument UI, and has links to the procedures to install TightVNC on the PC and the instrument.

 **Note:** This procedure does not apply to 4 Series MSO instruments.

**Prerequisites:**

- The oscilloscope must be connected to, and accessible from, the network to which the PC is connected. See [Connect to a network \(LAN\)](#) on page 76
  - The IP address or hostname of the oscilloscope that you want to access. Select **Utility > IO** in the oscilloscope menu bar and view the network settings in the **LAN** panel.
  - TightVNC software must be installed on both the Windows 10 oscilloscope and the PC used to remotely access the oscilloscope. See [Install TightVNC on the Windows 10 instrument](#) on page 81 and [Install TightVNC on a PC](#) on page 82.
1. On the PC, run the **TightVNC Viewer** application. If it is not on the Task Bar or the Startup menu, use the search window in the **Start** menu to locate the **TightVNC Viewer** application.



**Note:** Make sure that you select the **TightVNC Viewer** application. Do not select the **TightVNC Server** application.

2. Enter either the oscilloscope IP address or hostname in the **New TightVNC Connection** dialog and click **Connect**.
3. If an access password was set in the oscilloscope TightVNC Server, enter that password and click **OK**. The **TightVNC Viewer** opens and displays the oscilloscope screen.
4. To close the TightVNC viewer, click the **X** button in the upper right corner of the application.

## Install TightVNC on the Windows 10 instrument

The **TightVNC Server** application enables a PC to connect to and display the Windows 10 oscilloscope UI on the PC. You must install the TightVNC software on both the PC and the Windows 10 oscilloscope. This procedure describes how to install the software on the Windows 10 oscilloscope.

1. Download the **TightVNC** software:
  - a. Open a web browser and navigate to [www.tightvnc.com](http://www.tightvnc.com).
  - b. Under the **Download TightVNC for Windows (Version 2.8.8)** heading, click **Installer for Windows (64 bit)**.
  - c. Click **Save File** in the dialog box to save the .MSI file to your PC.
  - d. Close the browser.
2. Navigate to where you saved the **TightVNC** installation file.
3. Copy the .MSI file to a USB memory device.
4. Attach the USB memory device to the Windows 10 oscilloscope.
5. Minimize the oscilloscope screen to display the desktop.
6. Use the Windows Explorer to navigate to and select the .MSI installation file on the USB device.
7. Right-click on the installation file and select **Install**.
8. Follow the on-screen instructions. Select **Typical** for the installation, leave all other settings at their default settings. Click **Next** when prompted.
9. Click **Install**.
10. Click **Yes** to allow software changes to the PC.
11. For best security, create user and administrator passwords for accessing the **TightVNC Server** from the **TightVNC Viewer**. The User password will be required whenever logging into the oscilloscope with the **TightVNC Viewer**.
12. Click **Finish**. The oscilloscope is now ready to enable connection from the TightVNC Viewer. See [Remote access to a Windows 10 instrument](#) on page 80.

## Install TightVNC on a PC

The **TightVNC Viewer** application connects the PC to the Windows 10 oscilloscope to display the oscilloscope UI on the PC. You must install the TightVNC software on both the PC and the Windows 10 oscilloscope. This procedure describes how to install the software on the PC.

1. Download the **TightVNC** software:
  - a. Open a web browser and navigate to [www.tightvnc.com](http://www.tightvnc.com).
  - b. Under the **Download TightVNC for Windows (Version 2.8.8)** heading, click **Installer for Windows (64 bit)**.
  - c. Click **Save File** in the dialog box to save the .MSI file to your PC.
  - d. Close the browser.
2. Navigate to where you saved the **TightVNC** installation file.
3. Right-click on the installation file and select **Install**.
4. Follow the on-screen instructions. Select **Typical** for the installation, leave all other settings at their default settings. Click **Next** when prompted.
5. Click **Install**.
6. Click **Yes** to allow software changes to the PC.
7. Select **Do Not Change** for both password fields in the **Set Passwords** dialog box.
8. Click **Finish**. The PC is now ready to connect to a Windows 10 oscilloscope that has **TightVNC** software installed on it. See [Remote access to a Windows 10 instrument](#) on page 80.

## Deskew analog input channels

Critical Timing measurements on multiple channels require that all probes be adjusted, or deskewed, to compensate for signal timing differences between probes.

To access the user interface on a Low Profile instrument, connect a monitor to a video port on the rear of the instrument, and connect a mouse to any USB Host port. You do not need to connect a mouse if your remote monitor is touch-capable. You can also remotely access the user interface of a network-connected instrument by entering the instrument's IP address in a web browser. To remotely set a control or run this task on a Low Profile instrument, see the instrument Programmer Manual (Tektronix part number 077-1305-xx) for the correct command or commands to use.



**Note:** Once probes have been deskewed for a particular channel, you should only use the probes on the channels for which they were deskewed, when taking critical Timing measurements.

### Measurement method

Use the following procedure to more accurately minimize timing differences between probes.

1. Connect all probes that you want to deskew to the oscilloscope.
2. Connect up to four probe tips and ground leads to the Probe Compensation connector (maximum of four channels at a time).
3. Turn on all the channels of the first four channels that you want to deskew.
4. Push the **Autoset** button.
5. Change the vertical Scale of all active channels to **500 mV/div** and adjust the vertical Position so that the waveforms are centered in their respective slices.
6. Determine the channel you want to use as your reference.
7. Tap the **Add New...Measure** button and tap the **Timing Measurements** panel.
8. Select the **Delay** measurement and set your chosen reference channel as **Source 1** and your channel being deskewed as **Source 2**, then tap the **Add** button.

9. Double-tap the Channel badge of the channel being deskewed (Source 2) and tap the **Other** panel.
10. Tap the **Deskew** field and use the multipurpose knob to align this channel with the reference waveform such that the measured delay between channels becomes a minimum. For fine adjust, double-tap the **Deskew** field to open a number pad.
11. Double-tap the **Delay** measurement badge and set the Source 2 channel to the next channel to deskew.
12. Repeat steps 9 through 11 for each additional channel you want to deskew in the first set of four.
13. To deskew additional channels:
  - a. Disconnect all probe tips except the reference probe from the Probe Compensation connections.
  - b. Connect up to three probe tips and ground leads to the Probe Compensation connector (maximum of four channels at a time).
  - c. Repeat steps 3 through 13 for the additional channels to deskew.

### Quick visual method

Use the following procedure to visually align waveform edges to compensate for timing differences between probes.

1. Connect all probes that you want to deskew.
2. Connect up to four probe tips and ground leads to the Probe Compensation connector (maximum of four channels at a time).
3. Turn on (display on screen) the connected channels that you want to deskew.
4. Double-tap in the Waveform view and set **Waveform Mode** to **Overlay**.
5. Push the **Autoset** button.
6. Adjust the vertical **Scale** and **Position** controls for each channel so that the signals overlap and are centered on the display.
7. Adjust the horizontal **Scale** so that the differences in the channel delays are clearly visible.
8. Determine the channel you want to use as your reference.
9. Double-tap the Channel badge of a channel other than the reference channel and tap the **Other** panel.
10. Tap the **Deskew** field and use the multipurpose knob to align this channel with the reference channel waveform such that the waveforms cross the trigger point at the same time. For fine adjust, double-tap the **Deskew** field to open a number pad.
11. Repeat steps 9 and 10 for each additional channel you want to deskew.
12. To deskew additional channels:
  - a. Disconnect all probe tips except the reference probe from the Probe Compensation connections.
  - b. Connect up to three probe tips and ground leads to the Probe Compensation connector (maximum of four channels at a time).
  - c. Repeat steps 3 through 12 for the additional channels to deskew.

## Connect a keyboard or mouse

The instrument supports most standard USB-connected keyboards and mice, and wireless-connected keyboards and mice (using a USB-connected dongle).

Connect a keyboard and/or mouse by connecting their USB cable, or USB dongle, into any available USB Host port. The keyboard or mouse should work immediately. If it does not, try the following:

1. Remove and reinsert the USB cable or dongle in the same port.
2. Insert the USB cable or dongle into a different USB port.

## Connect an external monitor or projector

Use the video outputs to send the instrument display to a projector or to a flat-panel LCD monitor.

1. Power on the oscilloscope.

2. Connect the appropriate video cable to the projector or monitor. Connect the other end to the correct DVI, Display Port, or VGA connector on the oscilloscope.
3. Power on the projector or monitor.
4. Follow the projector or monitor instructions to set up and adjust the image.



# Analog channel operating basics

## Acquiring a signal

After acquiring a signal you can take measurements and plot the results.

Use the following procedure to set the scale and position parameters for analog signal acquisition.

1. Press the Default Setup button.
2. Connect the probe output to the desired oscilloscope channel, and connect the probe input to the input signal source using proper probing/connecting techniques.



**Note:** Some probes automatically set their termination and other values.

3. Tap the channel button to add the channel waveform to the waveform view and add a channel badge to the setting bar. A channel button lights when its channel is on.
4. Double-tap the channel badge to open the channel Vertical Settings menu. To change the input coupling, select the appropriate coupling button.
  - Select DC to couple both the AC and DC components of an input signal.
  - Select AC to couple only the AC components of an input signal.
5. Use the Vertical knobs to scale and position the waveform vertically on the screen. The Knobs should be highlighted with the active channel's color. Dragging the waveform handle also positions the waveform.
6. Use the Vertical Settings menu to change the offset. Tap Offset, and then use a multipurpose knob to adjust the offset.
7. Use the Horizontal knobs to scale and position the waveform horizontally on the screen and to set the record length. Dragging the reference icon also positions the waveform.
8. Use the Horizontal menu to set the record length and sample rate (when in Manual mode).
9. You may attempt to stabilize the display by pressing the trigger Level knob to set the trigger level to 50%. The 50% level is calculated as the midpoint between the highest and lowest samples of the acquired waveform. If your signal is periodic you should see a stable, triggered signal. This method will not work as well with random signals.

## Autoset to quickly display a waveform

The Autoset function analyzes the signal characteristics and changes the instrument Horizontal, Vertical, and Trigger settings to automatically display a triggered waveform. You can then make further changes to trigger and horizontal settings to view the waveform point of interest.

1. Connect the probe with the signal of interest to an available channel. The signal can be analog or digital.
2. Double-tap the **Trigger** badge and set the trigger source to that of the signal of interest.
3. Connect any other associated signal(s) to available channel input(s).
4. Add the channel waveforms to the Waveform view. See [Add a channel waveform to the display](#) on page 89.
5. Tap **File > Autoset** or push the front-panel **Autoset** button. When using the Stacked Display mode, the instrument analyzes the signal characteristics of the trigger source channel (analog or digital) and adjusts the horizontal, vertical, and trigger settings accordingly to display a triggered waveform for that channel. The Vertical scale is adjusted in each waveform slice of all active waveforms to maximize ADC utilization.

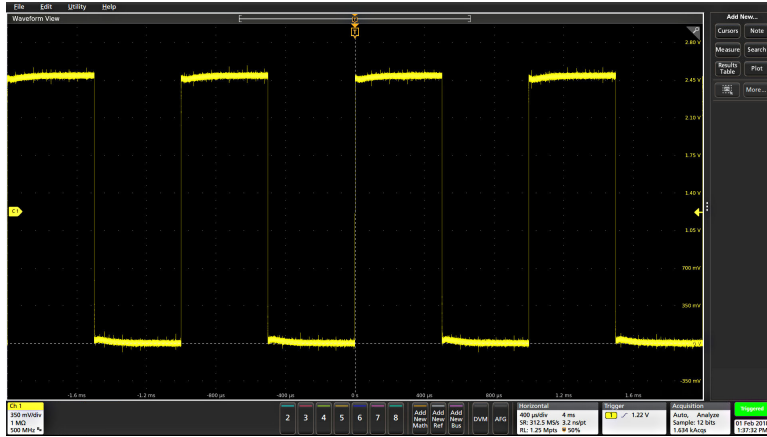

When using the **Overlay Display** mode, the instrument adjusts the horizontal and trigger settings of the trigger source channel to display a triggered waveform for that channel. Vertical scale and position adjustments for all active channels in Overlay Display mode are controlled by the **Autoset in Overlay Display Mode Optimizes** selection in the **Autoset** panel of the **User Preferences** menu. If the selection is **Visibility**, Autoset vertically scales and positions all active channel waveforms such that they are uniformly spaced on screen. If the selection is **Resolution**, Autoset vertically scales and positions all active channel waveforms such that they each use as much of the ADC's range as possible.

 **Note:** You can set which parameters the instrument can adjust when running an Autoset. Access the Autoset panel in **Utility > User Preferences > Autoset**. See [User Preferences \(Utility menu\)](#) on page 486.

### Autoset guidelines

- Autoset displays three or four cycles (depending on the detected signal) with the trigger level near the midlevel of the signal.
- The trigger is set to type Edge, rising slope, DC coupling.
- If no channels are displayed before pushing **Autoset**, the oscilloscope adds Ch 1 to the Waveform view whether it has a signal or not.
- Autoset ignores math, reference, and bus waveforms.
- A channel or waveform with a frequency less than 40 Hz is classified as no signal.

## Set Horizontal parameters

Use this procedure to set the horizontal time base parameters such as mode, minimum sample rate, horizontal scale, delay, and trigger delay time (relative to the center of the waveform record).

1. Double-tap the **Horizontal** badge on the Settings bar to open the Horizontal configuration menu.

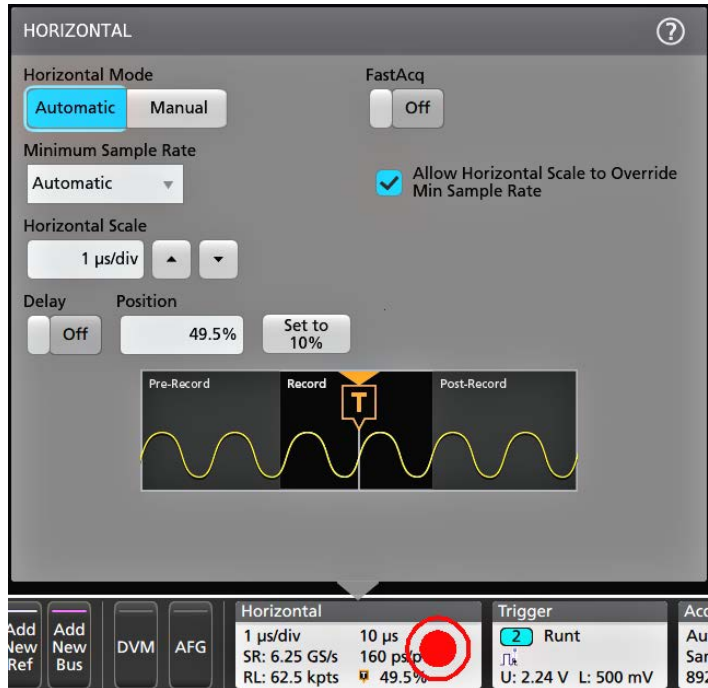

2. Use the menu selections to set horizontal parameters.
3. Tap the Help icon on the menu title for more information on these settings.

## How to trigger on a signal

Use this procedure to open the Trigger menu to select and configure the trigger event type and conditions.

1. Double-tap the **Trigger** badge on the Settings bar to open the Trigger configuration menu.
2. Select a trigger from the **Trigger Type** list. The trigger type sets what fields are available in the menu and also updates the illustration to show a graphic of the trigger type.

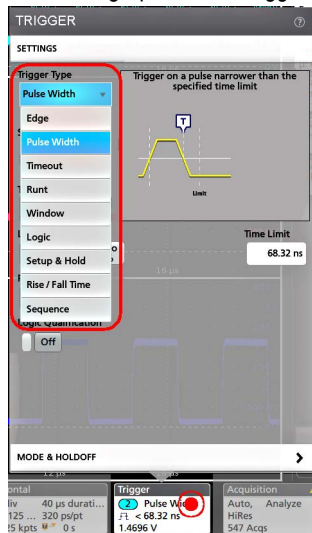

**Note:** For the MSO58LP, the AUX In external trigger input only supports Edge triggering.

To trigger on a bus, you must first add the bus to the Waveform view. See [Add a math, reference, or bus waveform](#) on page 93



**Note:** Triggering on buses other than Parallel requires purchasing and installing serial trigger and analysis options.

3. Select the other fields and panels to refine the trigger conditions. The menu fields and trigger graphic updates as you make changes to the trigger settings. Displayed fields depend on the selected trigger type. Selection changes take effect immediately.

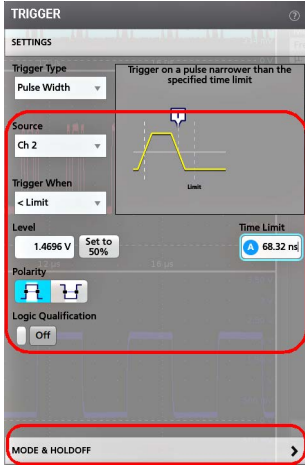

4. Tap the Help icon on the menu title for more information on these settings.
5. Tap outside the menu to close the menu.

## Set the acquisition mode

Use this procedure to set the method the instrument uses to acquire and display the signal.

1. Double-tap the **Acquisition** badge on the Settings bar to open the Acquisition configuration menu.
2. Select the acquisition method from the **Acquisition Mode** list. Set any other parameters associated with the selected acquisition type.

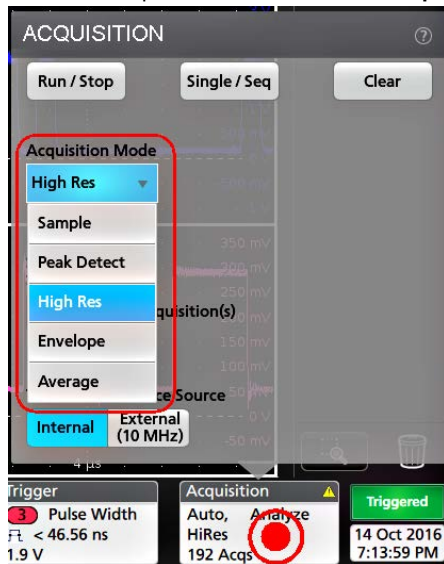

3. Tap the Help icon on the menu title for more information on these settings.
4. Tap outside the menu to close the menu.

## Start and stop an acquisition

Acquisition controls the start and stop of waveform acquisition.

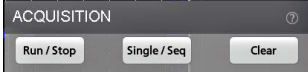
1. To start an acquisition, double-tap the Acquisition badge and tap **Run/Stop** in the Acquisition configuration menu. You can also push the **Run/Stop** button on the front panel.
- 
2. To stop an acquisition, tap **Run/Stop** again or push the **Run/Stop** button.
  3. To take a single acquisition, double-tap the Acquisition badge and tap **Single/Seq** in the Acquisition configuration menu, or push the **Single/Seq** button on the front panel.
  4. The color of the **Run/Stop** and **Single/Seq** buttons on the front panel indicate the acquisition status (green = acquiring, red = stopped).
  5. To clear the current acquisition data from waveform memory, double-tap the Acquisition badge and tap **Clear** in the Acquisition configuration menu, or push the **Clear** button on the front panel.

## Enable the History

Use this procedure to enable history of the acquisitions.

1. Double-tap the Acquisition badge on the Settings bar to open the Acquisition configuration menu.
2. Select the **Enable Acquisition History** box.



1303-024

3. Tap the Help icon for more information on these settings.
4. Tap outside the menu to close the menu.

## Add a channel waveform to the display

Use this procedure to add a channel signal to the Waveform View.

1. Connect signal(s) to the channel input(s).

2. Tap an Inactive Channel button (in the Settings bar) of a connected channel.



The selected channel is added to the Waveform View and a Channel badge is added to the Settings bar.

3. Continue tapping Inactive Channel buttons to add more channels (digital or analog). Channels are displayed from lowest-numbered channel at the top, to highest-numbered channel at the bottom of the view, regardless of the order they were added (in stacked mode).
4. Double-tap a channel badge to open that channel's configuration menu to check or change settings. See [Configure channel and waveform settings](#) on page 90.

## Configure channel and waveform settings

Use the channel and waveform configuration menus to set parameters such as vertical scale and offset, coupling, bandwidth, probe settings, deskew values, external attenuation values, and other settings.

Use this procedure to set up analog signal input.

- An analog probe or cable is connected to the channel before setting up the channel.
  - There is a channel or waveform badge in the Settings bar.
1. Double-tap a **Channel** or **Waveform** badge to open the configuration menu to the Vertical Settings panel. Displayed fields and controls can change depending on menu selections.

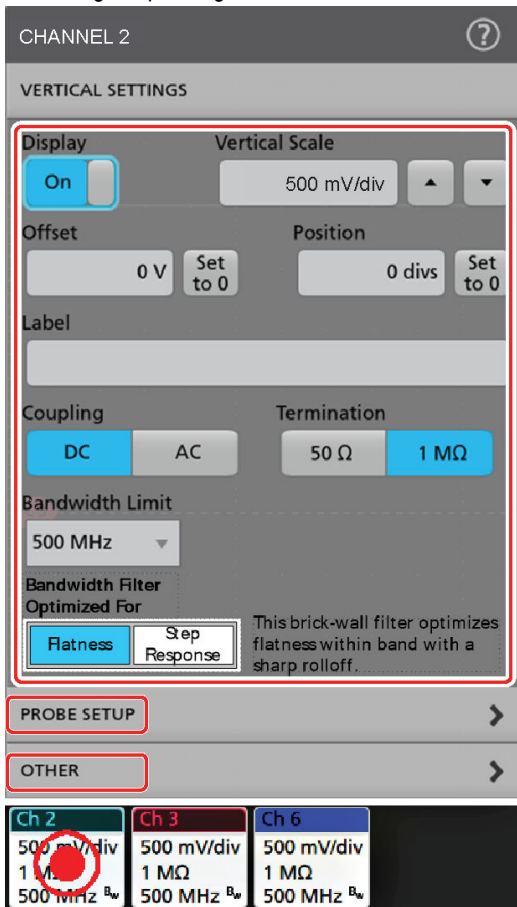

3514-021

Field or control	Description
<b>Display</b>	Enables <b>(On)</b> or disables <b>(Off)</b> displaying the channel waveform in the Waveform View window.
<b>Invert</b>	Reverses the amplitude polarity of each sample point. When On, Invert adds a down arrow symbol to the channel badge.  See <a href="#">Invert channel guidelines</a> on page 440.
<b>Vertical Scale</b>	Sets the vertical scale using the multipurpose knob, double-tap to bring up the virtual keypad, or tap the up and down arrows to change the scale.
<b>Offset</b>	Sets the channel signal vertical offset.  When there is an offset, the channel handle displays it in the waveform view.
<b>Set to 0</b>	Sets the channel signal vertical offset to 0 units.
<b>Position</b>	Double-tap the field to set the vertical position using the virtual keypad.
<b>Set to 0</b>	Tap to set the waveform zero volt level to the center of the slice or waveform view.
<b>Label</b>	Double-tap the field to add a label to the channel display using the virtual keypad.
<b>Bandwidth Limit</b>	Tap to select the bandwidth limit from the drop-down list.
<b>Coupling</b>	Tap to set the input coupling to DC or AC.
<b>Termination</b>	Tap to set the input termination to 1 M $\Omega$ or 50 $\Omega$ . If you are using a supported TekVPI probe, this value is automatically set by the probe and these controls are not available.
<b>Bandwidth Filter Optimized For</b>	Tap to select a bandwidth filter that is optimized for flatness or step response. This selection is only available on 6 Series MSO instruments.  <b>Flatness</b> selects a brick-wall filter optimized for flatness within band with a sharp rolloff. Flatness filtering is not compatible with Peak Detect and Envelope acquisition modes.  <b>Step Response</b> selects a Bessel-Thompson filter that minimizes overshoot with a gradual rolloff.  <b>High Res</b> acquisition mode requires Flatness filtering.

- To set up your probe, tap the **PROBE SETUP** panel. The fields and controls in the Probe Setup panel vary with the type of probe connected to the channel. A TPP probe is shown in this example, for other probes, see the probe user documentation.

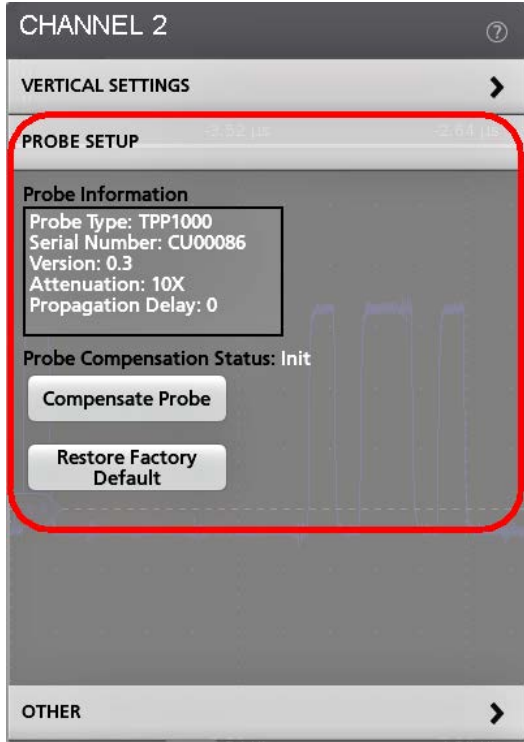

Field or control	Description
Probe Information	Displays the probe type, serial number, and attenuation, if it is available.
Probe Compensation Status	Displays the compensation status of the attached probe.
Compensate Probe	Starts the probe compensation procedure.
Restore Factory Default	Returns the compensation to the factory default settings.

- To set up deskew, external attenuation, or alternate units, tap the **OTHER** setup panel.

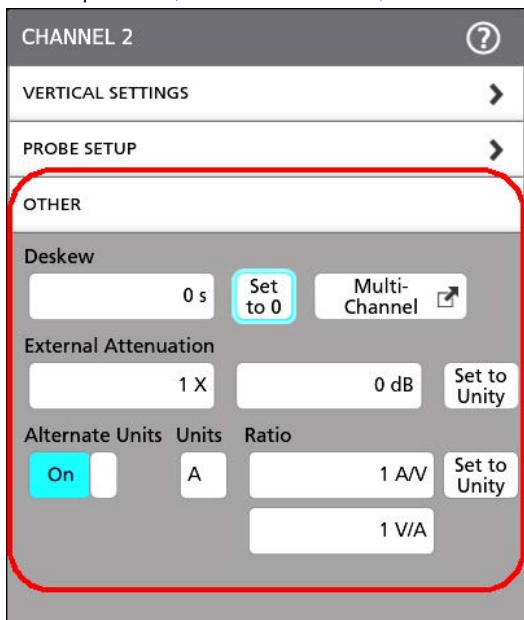



Field or control	Description
<b>Deskew</b>	Allows setting the channel deskew value.
<b>Set to 0</b>	Sets the channel deskew to 0.
<b>Multi-Channel</b>	Brings up the Deskew configuration menu.
<b>External Attenuation</b>	Allows setting an external attenuation for the channel. As one field is edited, the other field changes to reflect the corresponding value.
<b>Set to Unity</b>	Sets left numeric input field to 1X and right input to 0.0 dB.
<b>Alternate Units</b>	Toggles alternate units on or off.
<b>Units</b>	Sets the ratio units. This field is disabled when the Alternate Units switch is off.
<b>Ratio</b>	Sets the desired ratio value. As one field is edited, the other field changes to reflect the corresponding value. This button is disabled when the Alternate Units switch is off.
<b>Set to Unity</b>	Sets the ratio to 1. This button is disabled when the Alternate Units switch is off.

- When **Multi-Channel** in the **Other** panel is selected, the DESKEW configuration menu is displayed.



Field or control	Description
<b>From Source</b>	Selects the From Source to Deskew.
<b>Probe</b>	Displays the probe name or a drop-down list to select the probe connected to the From Source.
<b>Propagation Delay</b>	Displays the propagation delay of the probe shown in the Probe control.
<b>To Source</b>	Selects the To Source to Deskew.
<b>Probe</b>	Displays the probe name or a drop-down list to select the probe connected to the To Source.
<b>Propagation Delay</b>	Displays the propagation delay of the probe shown in the Probe control.
<b>OK, Deskew</b>	Uses the deskew values to adjust the horizontal delay between channels

- Tap outside the menu to close the menu.

## Add a math, reference, or bus waveform

Math waveforms let you create new waveforms based on operations between two or more waveforms or by applying equations to waveform data. A reference waveform is a static waveform record displayed for comparison. Bus waveforms let you view and analyze serial or parallel data.

There is no set limit to the number of Math, Reference, or Bus waveforms you can add to the Waveform View, other than system physical memory constraints.

- Tap the **Add New Math**, **Add New Ref**, or **Add New Bus** button in the Settings bar.



- The instrument adds the waveform to the Waveform view, adds a Waveform badge to the Settings bar, and opens a configuration menu. This example shows adding a Math waveform.

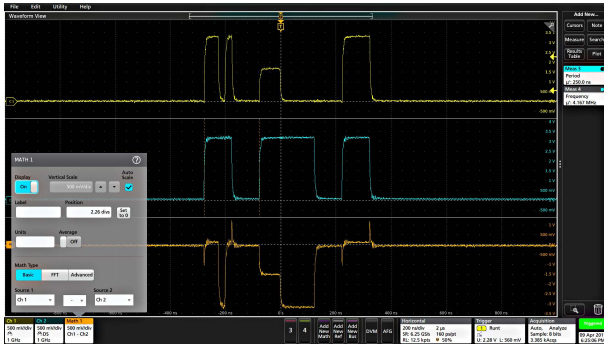

- Use the configuration menus to refine the waveform parameters. Displayed fields depend on the waveform and selections made in the menu. Selection changes take effect immediately.

This example shows adding a Math waveform, using the Math **Source** fields to select Ch 1 and Ch 2 as the waveform sources, set the math type to **Basic** math operation, and subtracting channel 2 from channel 1.

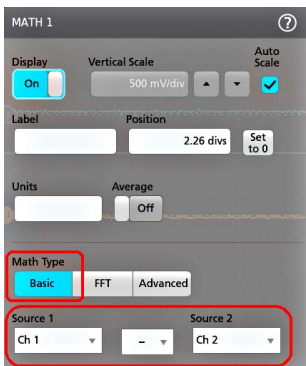

- When adding a Reference waveform, the instrument displays a **Recall** configuration menu. Navigate to and select the reference waveform file (\*.wfm) to recall, then tap the **Recall** button. The instrument displays the Reference waveform.
- Double-tap a math, reference, or bus badge to check or change the waveform settings.
- Tap the Help icon on a configuration menu title for more information on math, reference, and bus waveform settings.
- Tap outside the menu to close the menu.

## Analog view of digital waveform

Use this procedure to see the digital waveforms in analog view.

- Tap the **Add New Bus** button in the Settings bar.



The instrument adds the Bus waveforms to the Waveform view, adds a Bus badge to the Settings bar, and opens a configuration menu.

- Tap the **Add New Math** button in the Settings bar.

The instrument adds the Math waveforms to the Waveform view, adds a Waveform badge to the Settings bar, and opens a configuration menu.

- Set the **Math Type** as **Basic** from Math configuration menu.
- Select the **Bus <x>** you want to decode from **Source 1** drop-down list. Source 1 sets the available fields in the menu.
- Select the **Field** that you want to plot for the selected bus.

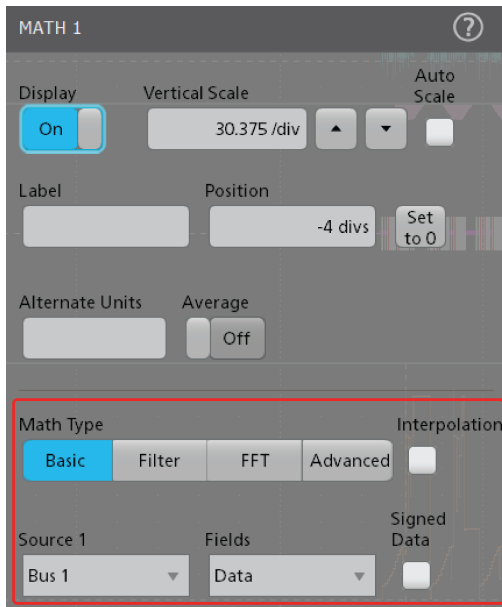

1303-025

- Select the other fields and panels to refine the waveform parameters.
- Tap the Help icon for more information on math waveform settings.
- Tap outside the menu to close the menu.

## Add a measurement

Use this procedure to select and add measurements.

- Acquire the channel(s) and/or waveform(s) on which you want to take measurements.

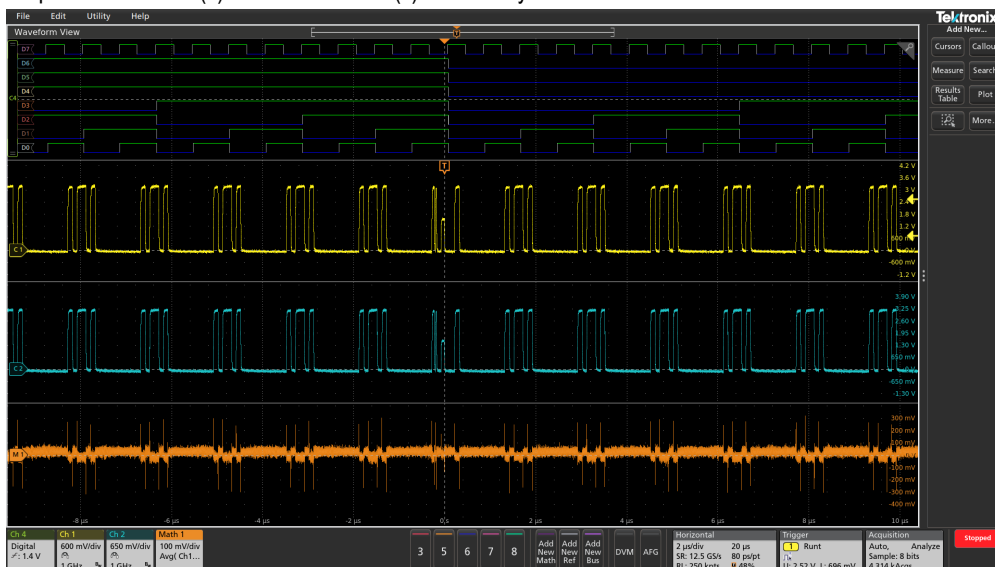



**Note:** Waveforms do not need to be displayed to be used for measurements, as long as the channel or waveform badge is on the **Settings** bar and is acquiring the signal to measure.

2. Tap the **Add New...Measure** button to open the **Add Measurements** configuration menu or drag the Measure button onto a waveform in the waveform display area to automatically set the source.

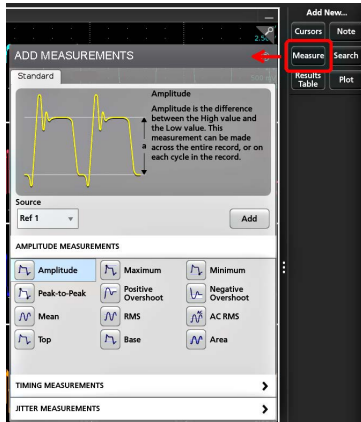

**Note:** If the menu shows tabs other than **Standard**, then optional measurement types have been installed on the instrument. Select a tab to show the measurements for that option.

3. Tap the **Source** field and select the measurement source. The list shows all available sources that are valid for the measurement.

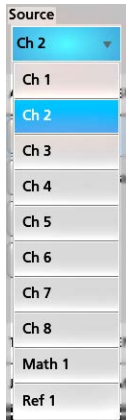

4. Select a measurement category panel, such as **Amplitude Measurements** or **Timing Measurements**, to display measurements for those categories.
5. Some optional measurement packages are available in this menu as well like PWR, DJA, DBDDR3, DPM, IMDA, and WBG-DPT.
6. Select a measurement and tap **Add** to add the measurement to the **Results** bar. You can also double-tap a measurement to add it to the **Results** bar.

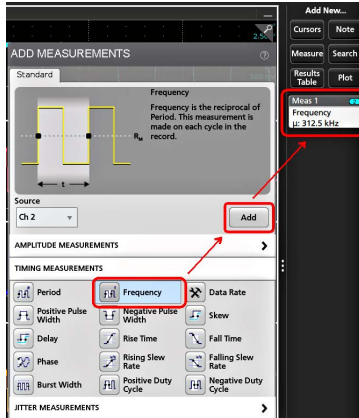

7. Select and add other measurements for the current source. Tap the measurement category panels to display and select other measurements to add.
8. To add measurements for other sources, select a different source, select a measurement, and add the measurement.

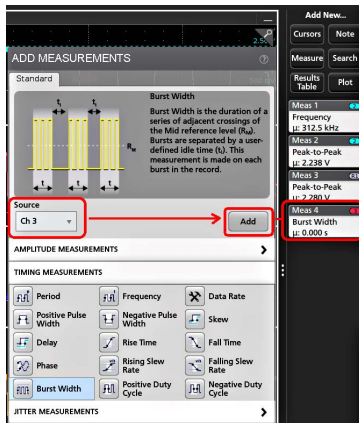

9. Tap outside the **Add Measurements** menu to close the menu.
10. To further adjust a measurement's settings, double-tap a measurement badge to open a configuration menu for that measurement. See [Configure a measurement](#) on page 97.
11. Tap the Help icon on the menu title for more information on settings.

## Configure a measurement

Use this procedure to add statistical readouts to the measurement badge, display plots for the measurement, and refine measurement parameters (configuration, global versus local scope of settings, gating, filtering, and so on).

1. Double-tap a measurement badge to open its **Measurement** configuration menu.

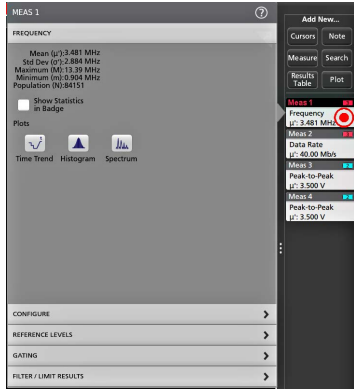

2. Tap **Show Statistics in Badge** to add statistical readouts to the measurement badge.

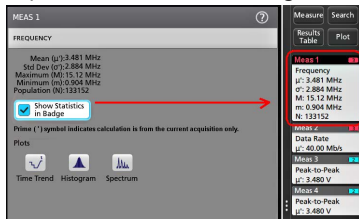

3. Tap available panel titles to make changes for those categories.

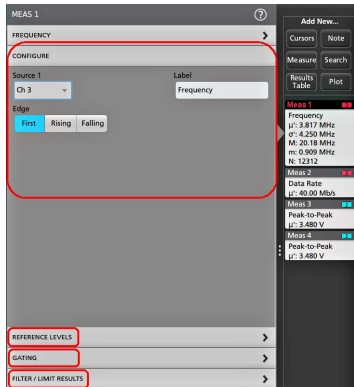

4. Use the available fields to refine the measurement conditions. Displayed fields depend on the measurement. Selection changes take effect immediately. Selection changes can also change fields in other panels.
5. Tap the Help button on the menu title for more information on this menu's settings.
6. Tap outside the menu to close the menu.

## Delete a Measurement or Search badge

Use this procedure to remove a Measurement or Search badge from the Results bar.

1. Touch and hold the Measurement or Search badge that you want to delete. The instrument opens a right-click menu.
2. Select **Delete Meas** to delete that badge from the Results bar.

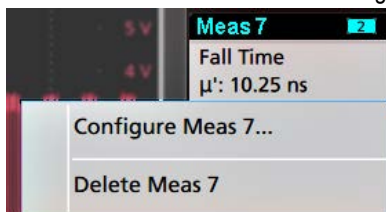



**Note:** You can undo a measurement delete.

- The second way to delete a Measurement or Search badge is by flicking it off the right edge of the display. Flicking to the left from the right edge of the display recovers the badge.



**Note:** Badge recovery is possible within 10 seconds only of removal.

## Add a plot of a measurement

Measurement plots let you graph the distribution of waveform data point occurrences (histogram), plot the frequency components (spectrum) of a waveform, show the time trend of a measurement, display an eye diagram, and other supported plots. Available plots depend on the measurement.

- Double-tap a Measurement badge to open the **Meas** configuration menu.

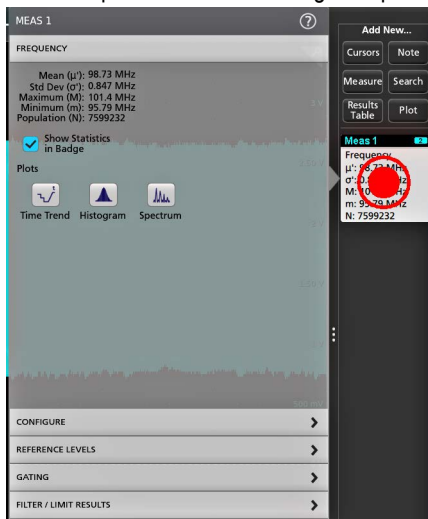

- Tap a **Plots** button to add that plot for the measurement to the screen.

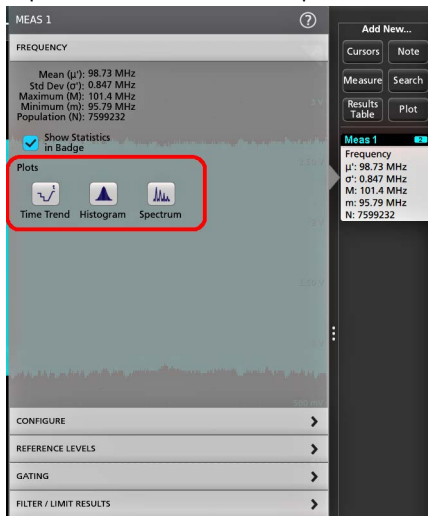

The following shows adding a Histogram plot.

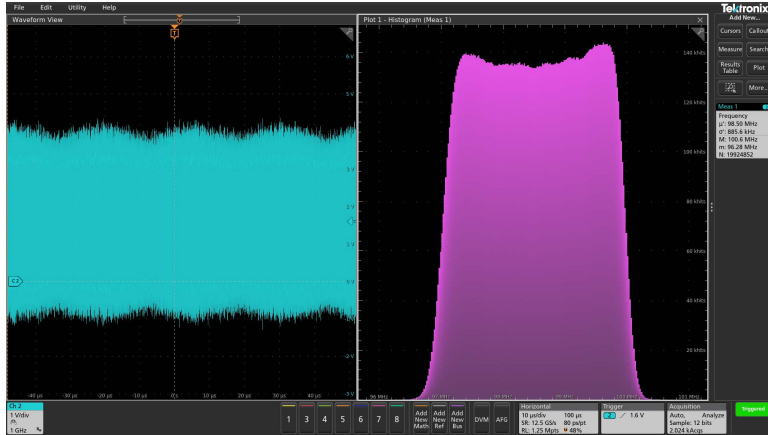

You can add more than one plot to measurements (to different measurements or the same measurement). For example, you can add two histogram plots for the same measurement, set one to display the X-Axis with a Logarithmic scale, and the other plot to display the X-Axis with a Linear scale.

3. You can move plot windows by dragging the Plot view title bar to a new position. The blue background area moves to show where the plot will be located when you remove your finger from the title bar. You can also resize plot windows by selecting and dragging the Plot view border. You should use a mouse to do these operations, as it is easier to select and drag plots with a mouse.

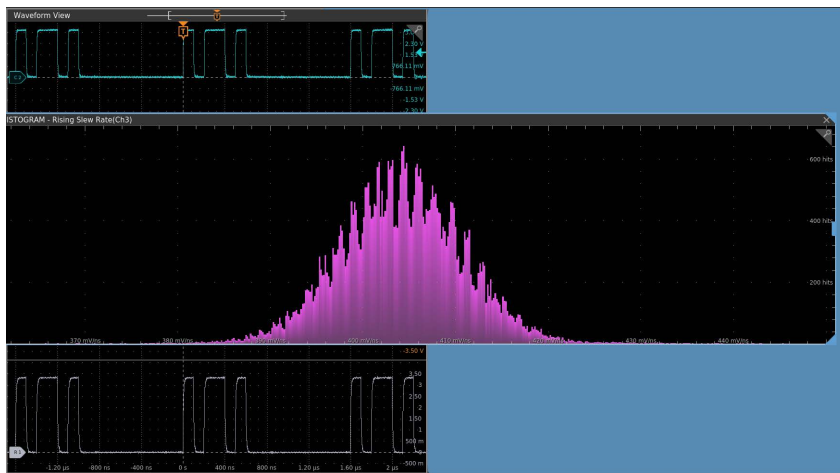

4. Double-tap within a Plot view to open a configuration menu to set display characteristics. Tap the Help icon on the configuration menu title for more information on that menu's settings. Tap outside the menu to close the menu.

## Display a Histogram plot

Use this procedure to display a histogram plot.

To display a histogram plot you must be taking a measurement.

1. Double-tap a measurement badge.  
The Measurement configuration menu is displayed.
2. Tap the **Histogram** plot button.  
The Histogram plot is displayed in a separate Plot view.
3. Double-tap in the plot view to open a configuration menu for that plot.



## Display a Time Trend plot

Use this procedure to display a time trend plot.

To display a time trend plot you must be taking a measurement.

1. Double-tap a measurement badge. The Measurement configuration menu is displayed.
2. Tap the **Time Trend** plot button. The Time Trend plot is displayed. Time Trend plots are shown in the Waveform View rather than in a separate Plot view.

## Display a Acq Trend plot

Use this procedure to display a acq trend plot.

To display a acq trend plot you must be taking a measurement.

1. Double-tap a measurement badge. The Measurement configuration menu is displayed.
2. Tap the **Acq Trend** plot button.

**Note:**



- Plot rendering resets when there is change in the oscilloscope settings such as the vertical settings, horizontal, acquisition and trigger etc.
- When oscilloscope acquisition is stopped and restarted again, the plot will continue to render without resetting.
- Acq trend plot does not support Save/Recall session feature.
- Cursors can be enabled on the plot.

The Acq Trend plot is displayed in a separate Plot view.

3. Double-tap in the plot view to open a configuration menu for that plot.

## Display a Spectrum plot

Use this procedure to display a spectrum plot.

To display a time spectrum plot you must be taking a measurement.

1. Double-tap a measurement badge. The Measurement configuration menu is displayed.
2. Tap the **Spectrum** plot button.

The Spectrum plot is displayed in a separate Plot view.

3. Double-tap in the plot view to open a configuration menu for that plot.

## Display an XY or XYZ plot

Use this procedure to display an XY or XYZ plot.

1. Tap **Add New... Plot**. The Plot configuration menu is displayed.
2. If creating an XY plot, tap **XY**.
3. If creating an XYZ plot, tap **XYZ**.
4. Tap the **X Source** drop down and select the X Source from the list.
5. Tap the **Y Source** drop down and select the Y Source from the list.
6. If creating an XYZ plot, tap the **Z Source** drop down and select the Z Source from the list.

7. Tap **Add**. The plot is displayed in a separate Plot view.
8. Double-tap in the Plot view to open a configuration menu for that plot.

## Display an Eye Diagram plot

Use this procedure to display an eye diagram of a waveform.

**Prerequisite:** An active signal for which you want to plot an eye diagram.



**Note:** 4 Series MSO does not support Eye Diagram plot.

1. Tap **Add New... Plot** to open the Plot configuration menu.
2. Tap **Eye Diagram**.
3. Tap the **Source** drop down and select the signal source from the list.
4. Tap **Add**. The instrument adds the eye diagram in a separate plot window and adds a TIE measurement badge to the Results bar.
5. Double-tap in the Plot view to open a configuration menu for that plot.

## Display a Phasor Diagram for Power Quality measurement

Use this procedure to display a phasor diagram plot.

To display a phasor diagram plot, you must be taking an Power Quality measurement (**Add New... Measurement** > **IMDA** tab > **Electrical Analysis** panel > **Power Quality** measurement).

1. Double-tap a **Power Quality** measurement badge. The Measurement configuration menu is displayed.
2. Tap the **Phasor Diagram** button.  
The Phasor Diagram plot is displayed in a separate Plot view.
3. Double-tap in the Plot view to open the configuration menu for that plot.

## Display a Phasor Diagram for DQ0 measurement

Use this procedure to display a phasor diagram plot for DQ0 measurement.

To display a phasor diagram plot, you must be adding a DQ0 measurement (**Add New... Measurement** > **IMDA** tab > **Electrical Analysis** > **DQ0** measurement).

1. Double-tap an **DQ0** measurement badge. The Measurement configuration menu is displayed.
2. Tap the **Phasor Diagram** button. The Phasor Diagram plot is displayed in a separate Plot view.
3. Double-tap in the Plot view to open the configuration menu for that plot.

## Display a Harmonics Bar Graph plot for IMDA Harmonics measurement

Use this procedure to display a bar graph.

To display a harmonics bar graph, you must be taking a Harmonics measurement (**Add New... Measurement** > **IMDA** tab > **Electrical Analysis** panel > **Harmonics** measurement)

1. Double-tap a **Harmonics** measurement badge. The Measurement configuration menu is displayed.
2. Tap the **Bar graph** button. The Bar graph is displayed in a separate Plot view.

3. Double-tap in the Plot view to open the configuration menu for that plot.

## Add Mask Testing to an Eye Diagram plot

Use this procedure to add mask test segments to an eye diagram plot and display the mask segment hits information in the Results bar.

**Prerequisites:** An eye diagram plot is on the screen.



**Note:** 4 Series MSO does not support Eye Diagram plot.

A mask configuration file (.msk) that matches the time scale (unit interval) and vertical settings of the eye diagram.

1. Double-tap in the eye diagram plot to open the **Eye Diagram** configuration menu.
2. Tap the **Mask** panel.
3. Use the **Mask** panel fields to select and load a mask configuration file and set the bit type for testing. See [Eye Diagram plot configuration menu](#) on page 513.



**Note:** The mask configuration file that you load must match the time scale (unit interval) and vertical settings of the active eye diagram.

This step also adds a **Mask** badge to the Results bar.

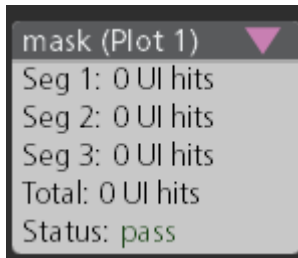
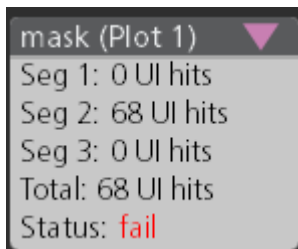

The **Mask** badge shows the number of unit interval hits per segment and the pass/fail status. You can expand the Mask badge when acquisition is stopped to show the Navigation buttons.

When **Autofit Mask to Minimize Hits** box is checked, the mask violations are displayed in sample hits.

Use the Navigation buttons to center the source waveform on the previous or next mask search mark where a mask hit occurred. In the case of mask hit groups (see the following text), the Navigation buttons center the source waveform on the beginning mask hit group search mark where the successive mask hits started.

The mask hit search marks on the source waveform are not precise due to the interpolated waveform used to create the eye diagram.

When a set of successive waveform sample points (for example, 50 sequential sample points) touch a mask, then the whole series of successive sample points is considered as one mask hit group. The successive mask hit groups are marked with a beginning and ending search mark, instead of individual search marks for each hit.

4. Tap the **Mask Test** button to set it to **On** and display the mask segments in the eye diagram.
5. Tap outside of the menu to close it.

6. To set the number of hits required to fail a mask test, double-tap the **Mask** badge in the Results bar to open the **Mask Hits** menu and set the hit fail value. See [Mask Badge configuration menu](#) on page 453.

## Display an FFT math waveform

Use this procedure to display an FFT math waveform.

The FFT process mathematically converts the standard time-domain signal (repetitive or single-shot acquisition) into its frequency components. The FFT function processes the waveform record and displays the FFT frequency domain record, which contains the input signal frequency components from DC (0 Hz) to  $\frac{1}{2}$  the sample rate (also called the Nyquist frequency).

1. Tap **Add New Math** to create a math waveform and open the Math configuration menu.
2. Tap **Source** and select the signal source from the list.
3. Set Math Type to **FFT**. The FFT of the waveform is displayed in an FFT Math waveform view.
4. Double-tap on the FFT waveform display to open a configuration menu to further refine the FFT display. See [Math FFT plot configuration menu \(Math waveform\)](#) on page 525.

## Display a B-H curve plot for Magnetic Property measurement

Use this procedure to display a B-H curve plot for a power measurement.

To display a B-H Curve plot, you must be taking a Magnetic Property measurement (**Add New... Measurement > Power tab > Magnetic Analysis panel > Magnetic Property** measurement).

1. Double-tap the **Magnetic Property** measurement badge to open the configuration menu.
2. Tap **B-H Curve** to add a new B-H Curve Plot view to the screen.
3. Double-tap in the Plot view to open a configuration menu for that plot.

## Display an I vs (integral of) V plot for I vs V measurement

Use this procedure to display an I vs.  $\int V$  plot for I vs.  $\int V$  measurement.

To display an I vs.  $\int V$  plot, you must be taking a I vs.  $\int V$  measurement (**Add New... Measurement > Power tab > Magnetic Analysis > I vs.  $\int V$**  measurement).

1. Double-tap the **I vs.  $\int V$**  measurement badge to open the configuration menu.
2. Tap **I vs.  $\int V$**  to add a new **I vs.  $\int V$**  Plot view to the screen.
3. Double-tap in the Plot view to open a configuration menu for that plot.

## Display an Inductance Curve plot for Inductance measurement

Use this procedure to display an inductance curve plot.

To display an inductance curve plot, you must be taking an Inductance measurement (**Add New... Measurement > Power tab > Magnetic Analysis panel > Inductance** measurement).

1. Double-tap an **Inductance** measurement badge.  
The Measurement configuration menu is displayed.
2. Tap the **Inductance** button.  
The Inductance Curve plot is displayed in a separate Plot view.

3. Double-tap in the Plot view to open the configuration menu for that plot.

## Display a Safe Operating Area (SOA) measurement and plot

Use this procedure to display a SOA plot. This is an XY plot with a mask.

To display an SOA power measurement and plot:

1. Tap the **Add New... Measurement** button.
2. Tap the **Power** tab.
3. Set the voltage and current sources for the measurement.
4. Tap the **Switching Analysis** panel.
5. Select the **SOA** measurement and tap **Add**.

The SOA measurement adds a Power measurement badge to the Results bar, and automatically adds the SOA plot to the screen.

6. Double-tap in the Plot view to open a configuration menu for that plot.

## Display a power Switching Loss (SWL) Trajectory plot

Use this procedure to display a trajectory plot for a power measurement.

To display a trajectory power plot, you must be taking a Switching Loss measurement (**Add New... Measurement** > **Power** tab > **Switching Analysis** panel > **Switching Loss** measurement).

1. Double-tap the **Switching Loss** measurement badge to open the configuration menu.
2. Tap **Trajectory Plot** to add a new Trajectory Plot view to the screen.
3. Double-tap in the Plot view to open a configuration menu for that plot.

## Display instantaneous power and energy plots from the Power Quality measurement

Use this procedure to display a power/energy plot from the Power Quality measurement.

To display the power and energy plots you must be taking the Power Quality measurement.

1. Tap the **Add New... Measurement** button.
2. Tap the **Power** tab.
3. Set the Voltage and Current sources for the measurement.
4. Tap the **Electrical Analysis** panel.
5. Select the **Power Quality** measurement and tap **Add**.

The measurement is added to the Results bar, and automatically adds **PQ: Power** and **PQ: Energy** math waveforms (plots) to the Waveform view. Math plots are shown in the Waveform View rather than in a separate Plot view.

- PQ: Power displays the power waveform computed from the Power Quality input sources.
- PQ: Energy displays the energy waveform computed from the Power Quality input sources. See [Waveform View configuration menu](#) on page 622.

## Display a Harmonics Bar Graph plot for the Power Harmonics measurement

Use this procedure to display a bar graph.

To display a harmonics bar graph, you must be taking a Harmonics measurement (**Add New... Measurement** > **Power** tab > **Electrical Analysis** panel > **Harmonics** measurement).

1. Double-tap a **Harmonics** measurement badge.  
The Measurement configuration menu is displayed.
2. Tap the **Bar graph** button.  
The Bar graph is displayed in a separate Plot view.
3. Double-tap in the Plot view to open the configuration menu for that plot.

## Display a Power Supply Rejection Ratio plot

Use this procedure to display a Power Supply Rejection Ratio plot for a power measurement.

To display a Power Supply Rejection Ratio power measurement and plot:

1. Tap the **Add New... Measurement** button.
2. Tap the **Power** tab.
3. Set the voltage and current sources for the measurement.
4. Tap the **Power Supply Rejection Ratio** panel.
5. Select the **Power Supply Rejection Ratio** measurement and tap **Add**.

The Power Supply Rejection Ratio measurement adds a Power measurement badge to the Results bar, and automatically adds the Power Supply Rejection Ratio plot to the screen.

6. Double-tap in the Plot view to open a configuration menu for that plot.

## Display a Control Loop Response (Bode) plot

Use this procedure to display a Control Loop Response (Bode) plot for a power measurement.

To display an Control Loop Response power measurement and plot:

1. Tap the **Add New... Measurement** button.
2. Tap the **Power** tab.
3. Set the voltage and current sources for the measurement.
4. Tap the **Frequency Response Analysis** panel.
5. Select the **Control Loop Response** measurement and tap **Add**.

The Control Loop Response measurement adds a Power measurement badge to the Results bar, and automatically adds the Control Loop Response plot to the screen.

6. Double-tap in the Plot view to open a configuration menu for that plot.



**Note:** Gain Margin (GM) represents the margin value and not the actual value annotated in the Bode plot. The GM value indicates distance (basically how far) from the reference value (zero dB line). The margin is computed as zero minus the measured value. The measured value becomes negative when it is below 0 dB, then margin is positive and vice versa.

## Add a Search

Use this procedure to set search criteria and mark a waveform where those events occur.

You can search on analog and digital signals, math waveforms, and reference waveforms. You can add searches to different waveforms and multiple searches to the same waveform.

**Prerequisite:** Display the channel or waveform signal on which to search. The waveform must be displayed to create a search for it.

1. Tap the **Add New...Search** button to open the Search configuration menu.

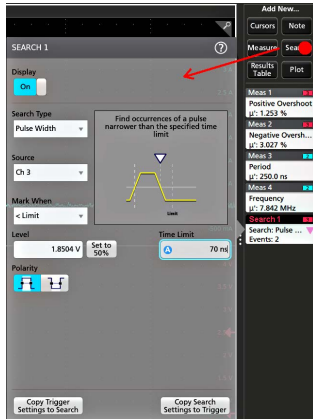

2. Use the configuration menu fields to set the search criteria in the same way that you would set for a trigger condition (select the **Search Type**, **Source**, and conditions on which to search).



**Note:** You cannot search for sequential events (there is no Sequence search type).

3. The searched waveform is marked with one or more triangles as soon as the search criteria becomes true. Each search uses a different color for its markers. The example image shows search criteria set to find positive pulse widths that are less than 70 ns wide.

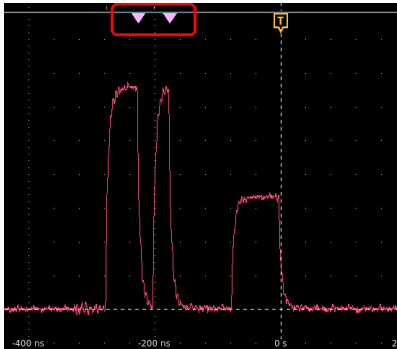

4. To stop showing marks on a waveform, double-tap the **Search** badge and tap **Display to Off**.
5. To move the waveform to center marks on the display, push the **Run/Stop** front panel button to stop acquisition, single-tap a **Search** badge, and tap the < or > Navigation button.



**Note:** Navigation buttons are only functional when the oscilloscope acquisition mode is set to **Stop**.

This opens the **Zoom** mode and moves the waveform to the previous or next event mark on the waveform.

6. If available for a search, tap the **Min** or **Max** button to center the waveform in the display at the minimum or maximum value of the search events in the waveform record.
7. To return the instrument to normal acquisition mode, tap the **Zoom** icon in the upper right corner of the Waveform View to turn off **Zoom** mode, and push the **Run/Stop** front-panel button to set it to Run mode.

## Change waveform view settings

Use this procedure to change the waveform display mode (Stacked or Overlay), waveform trace interpolation algorithm, waveform persistence, style and intensity, and graticule style and intensity.

1. Double-tap on an open graticule area to open the **Waveform View** configuration menu.

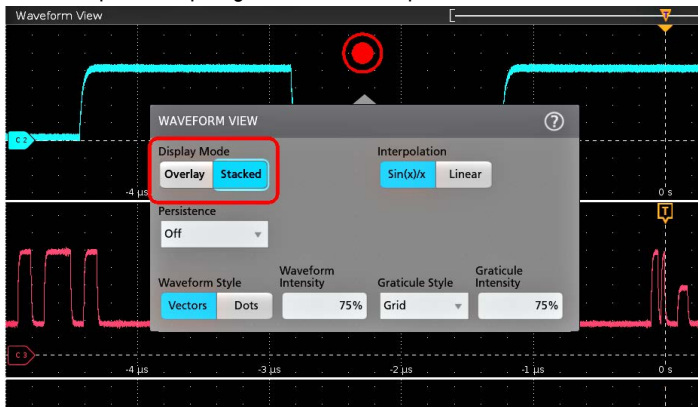

2. Tap the buttons in the **Display Mode** to toggle between **Overlay** and **Stacked** modes.

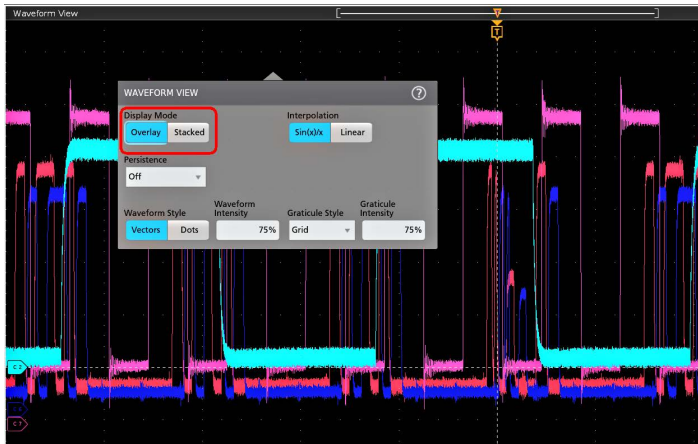

3. Use the other controls to set the waveform interpolation algorithm, waveform point persistence, style, and intensity, and graticule style and intensity.
4. Tap the **Help** icon on the menu title to open the Waveform View menu help topic for more information on the waveform view parameters.
5. Tap outside the menu to close the menu.



## Display and configure cursors

Cursors are on-screen lines that you can move to take measurements on specific parts of a waveform **or** plot, or between two different waveforms. Cursor readouts show both current position values and the difference (delta) between cursors. Polar cursor readouts are available through the cursor configuration menu for XY and XYZ plots.

1. Tap the waveform slice (in Stacked mode), or the channel or waveform badge (in Overlay mode) to which you want to add cursors.
2. Tap the **Add New...Cursors** button, or push the front-panel button. The cursors are added to the display.

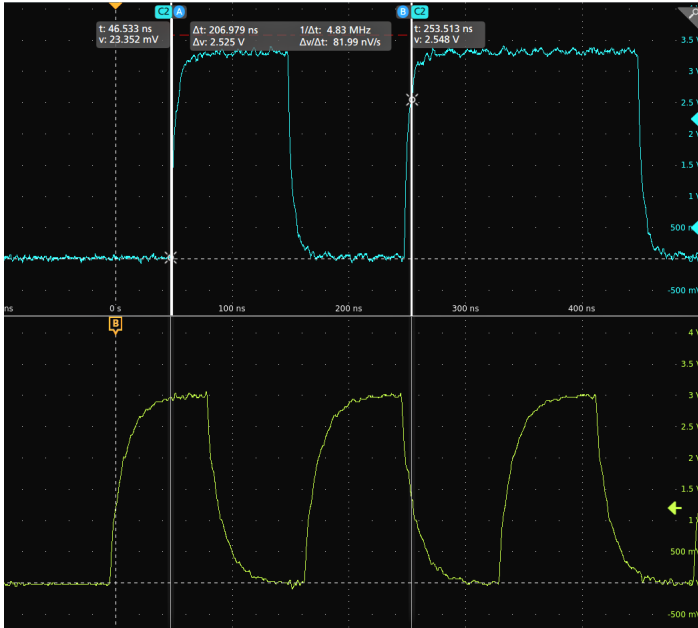

3. Use Multipurpose Knobs **A** and **B** to move the cursors, or touch and drag a cursor. Cursors show readouts that show position and difference measurements between the cursors.
4. To move the cursors to a different channel or waveform, just tap in that waveform graticule.

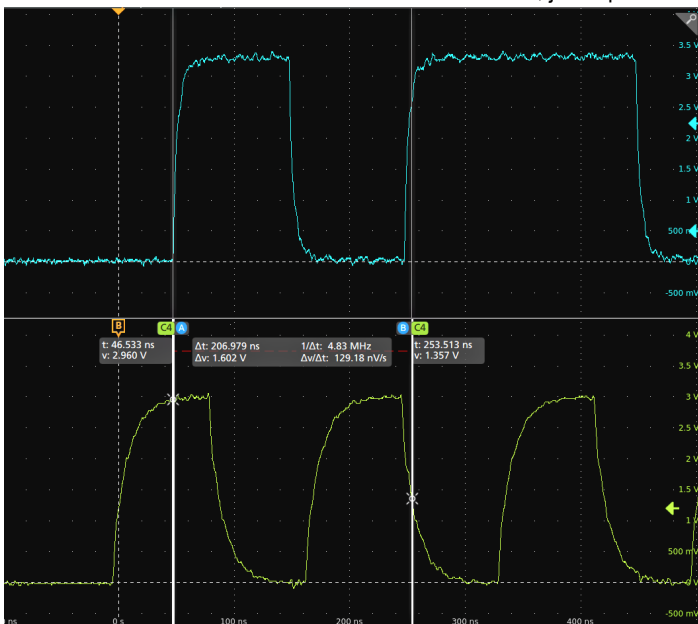

- To further configure cursors, double-tap on either cursor line or the cursor readouts to open the **Cursors** configuration menu. For example, tap the Cursor type to select the cursors to display, such as Waveform, V Bars, H Bars, and V&H Bars. See [Cursor configuration menu](#) on page 447.

The cursor configuration menu in the waveform view.

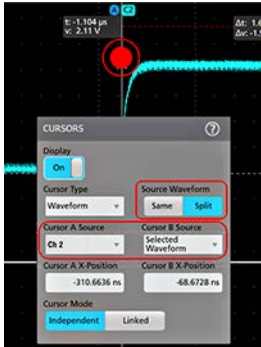

The cursor configuration menu in an XY plot.

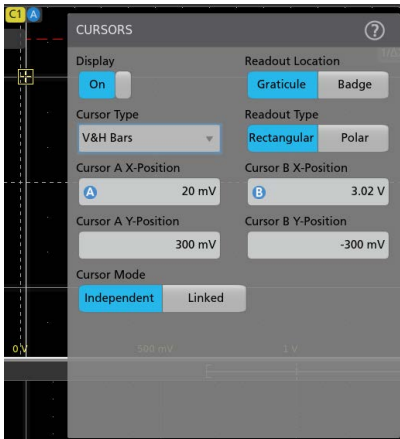

- To split the cursors between two waveforms, tap the **Source** field and select **Split** and select the source for each cursor. The cursors are moved to the specified waveforms.

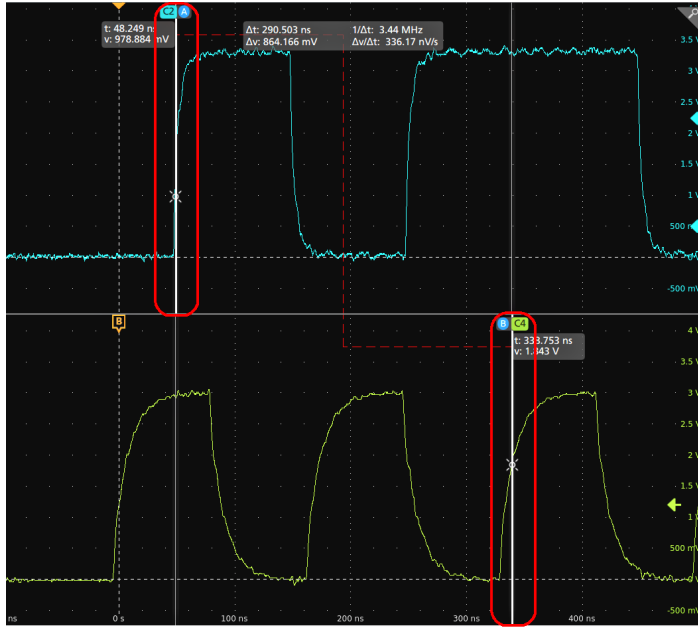

7. Tap the Help icon on the menu title for more information on the menu settings.
8. To stop showing cursors, push the front panel **Cursor** button, press and hold to open the right-click menu and turn cursors off, or open the Cursors configuration menu and set Display to **Off**.

## Display and configure Multi-source cursor readouts

Multi-source cursor readouts are displayed for waveform cursor type. It display amplitude and delta values between cursors for all the active sources in Stacked display mode. The readouts also display the time and delta values on the selected source. The cursor time values are common for all the active sources.

1. Tap the waveform slice (in Stacked mode), the channel, or the waveform badge (in Overlay mode) you want to add cursors to.
2. Tap the **Add New... Cursors** button, or push the front panel **Cursor** button. The cursors are added to the display.

Use Multipurpose Knobs **A** and **B** to move the cursors, or touch and drag a cursor. Cursors display position and difference measurements readouts between the cursors.

3. Double-tap on the cursor line or the cursor readouts to open the **Cursors** configuration menu.
4. Tap **Cursor Type** and select **Waveform** from the drop-down menu.
5. Tap **Source** and select **ALL** from the drop-down menu.

All includes time domain analog waveforms like math, reference, trend, etc.

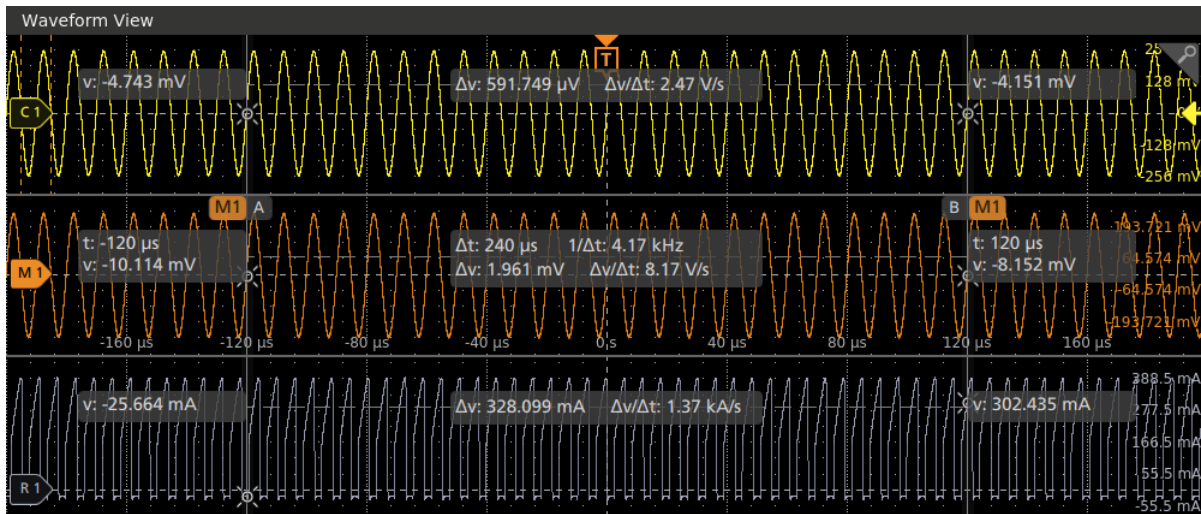
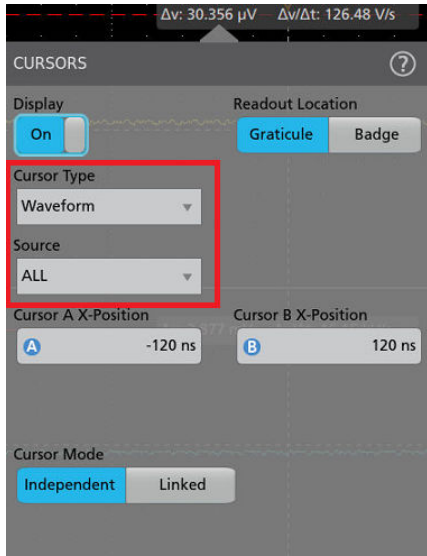

6. Tap the Help icon for more information on the menu settings.
7. To stop displaying cursors,
  - a. push the front panel **Cursor** button,
  - b. press and hold to open the right-click menu and turn cursors off, or
  - c. open the Cursors configuration menu and set **Display** to **Off**.

### Multi-source cursor readouts guidelines

The waveform in each slice displays the crosshairs where the cursors intersect the waveform.

If the cursor **Readout Location** is set to **Graticule** in the configuration menu:

- The cursor readouts display the amplitude and amplitude delta values for all the active sources.
- The cursor readouts for the selected waveform shows both time and amplitude values and deltas.
- If you select a different waveform or channel, the cursor readouts and horizontal in-graticule labels moves to the selected waveform.

If the cursor **Readout Location** is set to **Badge** in the configuration menu:

- All active waveforms in the Waveform View have cursor readout results associated with them, even if they are overlaid in a slice.

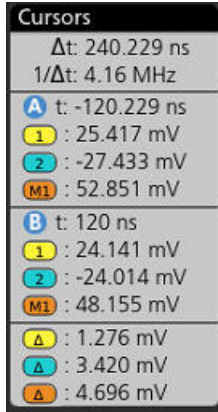

- The first section of the badge shows the delta time information.
- The second section of the badge shows the time and amplitude values associated with Cursor A.
- The third section of the badge shows the time and amplitude values associated with Cursor B.
- The fourth section of the badge shows the delta amplitude information.

## Using Default Setup

Use Default Setup to restore instrument settings to their factory defaults.

1. Press the front panel **Default Setup** button to return the instrument to its factory default settings (horizontal, vertical, scale, position, and so on).

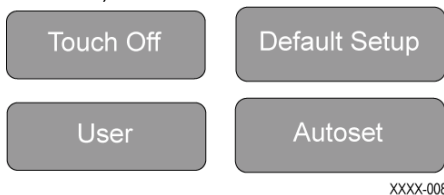

2. You can also select **File > Default Setup** to restore default settings.

## Using Fast Acq

Fast Acq (fast acquisition mode) reduces the dead time between waveform acquisitions, enabling the capture and display of transient events such as glitches or runt pulses. Fast acquisition mode can also display waveform occurrences at intensity levels that reflect their rate of occurrence. Badge displays **Analyze** when FastAcq is in OFF position, and **FastAcq** when it is in ON position.

1. To use Fast Acquisition mode, double-tap the **Horizontal** badge and tap **Fast Acq** to toggle Fast Acq to On. You can also push the **Fast Acq** front-panel button.

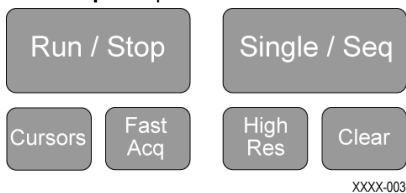

2. To display waveform with an intensity that reflects the rate-of-occurrence, double-tap the Horizontal badge, tap the **Fast Acq Palette** field, and select a display palette from the drop-down.

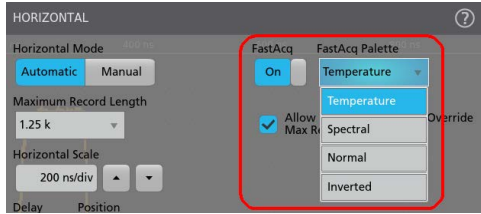

3. View the waveform to find glitches, transients, or other random events. When you have identified an anomaly, use the advanced trigger system to capture the event of interest for further analysis.



**Note:** If Fast Acquisitions mode is on and you attempt to activate a feature that conflicts with this mode, Fast Acquisitions mode will be disabled. When the conflicting feature is turned off, Fast Acquisitions will resume in most cases.



**Note:** Enabling FastAcq mode disables Fast Frame mode (if it was enabled). Likewise, enabling Fast Frame mode disables FastAcq mode (if it was enabled).

## Add a callout to a view

Tap the **Add New... Callout** button to add callouts at the default position, but you can relocate it later.

1. Tap the **Add New... Callout** button on the upper right of the results bar. The oscilloscope adds a text placeholder with default text as *Double tap to edit* at the center of the screen. However, you can move it around to place it at your choice.
2. The default callout field wraps text at about 15 characters. Use a mouse to select the callout and select any point from the available 8 touch points to resize the callout field to a larger size, to autowrap the callout text for the longer callout.



3. Double-tap or Double-click on the callout text top to open the callout Settings configuration menu.



4. Select the type of callout from the drop-down list. The types of callout available are as follow:

Callout Type	Description
Note	Adds a callout as a text.
Arrow	Adds a callout text with an arrow.
Rectangle	Adds a callout text with an arrow pointing to a rectangle. The rectangle can be dragged to any position.
Bookmark	Adds a callout text with a bookmark added for either Waveform view (ch, math, ref), Spectrum view (freq domain traces, rf vs time domain traces), or Time Trends. Specify the source channel from the drop-down list and X-position of the callout.

- Tap in the **Text** field and use a keyboard to enter the callout text, or double-tap in the Text field and use the on-screen keyboard to enter the callout text.



**Note:** You can enter only one row of text in the Text field of the Text Settings configuration menu (using an attached keyboard). You can enter multiple rows using the on-screen keyboard entry field.

- If you used the on-screen keyboard to enter text, tap the **Enter** button on the keyboard to close the keyboard and show the callout on the screen.
- Use the format menu controls to set font type, size, color and other characteristics. See [Text Settings configuration](#) for details.

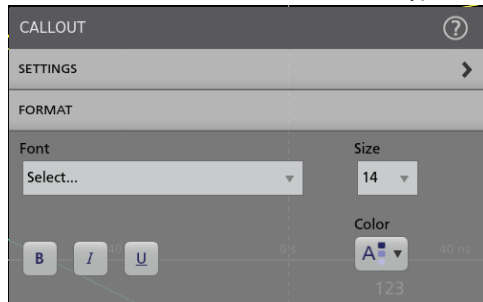

- Tap outside the callout Settings configuration menu to close it.
- To move a callout, touch and drag the callout text to a new position.

## Delete a Callout

Tap and hold on a callout text to open a menu to delete that Callout.

- Touch and hold on the callout text you want to delete (or right-click with the mouse). The oscilloscope opens the right-click menu.
- Select **Delete**. The callout is deleted immediately.

# Acquiring digital signals

Connect a TLP058 FlexChannel digital logic probe to any oscilloscope input channel. Connect the logic probe inputs to the DUT (see the probe instructions). Then use the following instructions to set up, acquire and display digital signals.

## Connect and set up digital signals

Use the digital channel configuration menu to set the digital channels to acquire signals.

The digital channel configuration menus are available only if a FlexChannel-supported digital logic probe is attached to the oscilloscope.



**CAUTION:** To prevent damage to the instrument always wear an antistatic wrist strap when making connections to the instrument and DUT. Always observe the maximum input voltage ratings for input connectors.

1. Connect the FlexChannel digital logic probe to the instrument. The digital signal waveforms display on the screen.
2. Connect the probe to the signal sources. Use the accessories in the Tektronix Probe Accessory Kit (shipped with the probe) to connect to your DUT.
3. Push the Menu button on the logic probe to open the digital channel configuration menu. Set up digital channels to match your digital logic requirements.

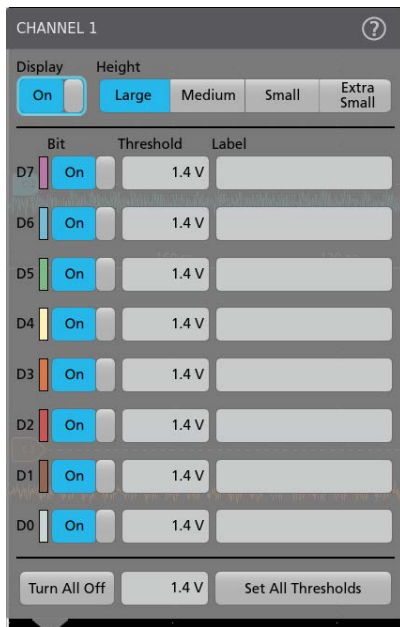

4. Tap **Display** to toggle the digital channel group On or Off. Doing this closes the menu and removes the Digital channel badge from the Settings bar.
5. To change the displayed height of the digital channels, tap a **Height** button. The height settings are only available when the display mode is set to Overlay in the Waveform View configuration menu.
6. Use the upper **Label** field to enter a custom label for the overall digital channel. Double-tap on the field and use the virtual keyboard or tap the field and use an attached keyboard.
7. Tap the **Bit** control to toggle individual digital channel bits On or Off and remove them from the displayed logic waveform.
8. Tap a **Threshold** field and use multipurpose knob **A** to set individual channel bit threshold levels. You can also set the bit threshold by double-tapping the field and setting the threshold using the virtual keypad.
9. Use the bit **Label** fields to enter labels for the individual digital channel bits (D0-D7). Double-tap on the field and use the virtual keyboard or tap the field and use an attached keyboard.
10. Tap to turn all digital bits Off. Doing this closes the menu and removes the associated channel badge from the Settings bar.



- To set all bit thresholds to the same value, enter a threshold value in the lower threshold field and tap **Set All Thresholds**.

## Add a serial bus to the Waveform view

Use this procedure to add a serial bus to the Waveform view.

This instrument supports decoding parallel buses (standard with the instrument) and several serial buses options. All serial bus functions are options that must be purchased and installed before they are available in the instrument menus.

Use a Bus configuration menu to define a bus from which to acquire, decode, and display data.

- Tap the **Add New Bus** button on the Settings bar to add a Bus badge to the Settings bar, add a bus waveform to the screen, and open the Bus configuration menu. The default bus type is parallel.



- Tap **Bus Type** and select the bus type from the drop-down list.

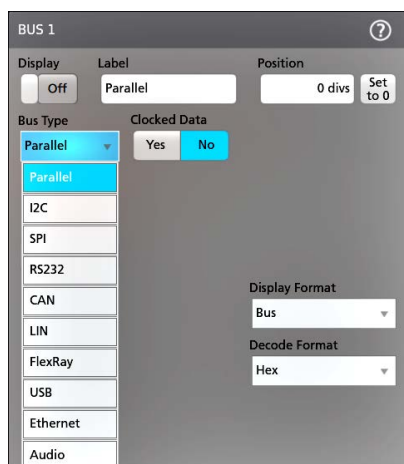

- Use the fields and controls to select the bus signal sources, thresholds, other parameters, and the output format. The following image shows the settings for an Audio I2S serial bus.

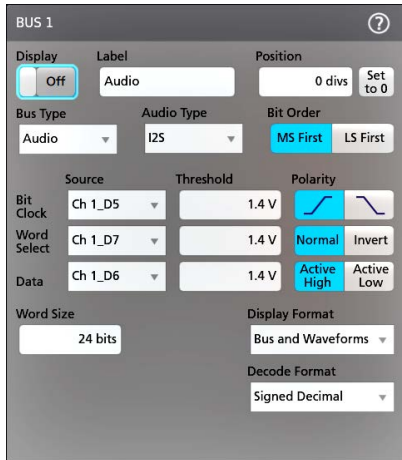

The decoded bus is updated on the screen as you make changes to the settings.

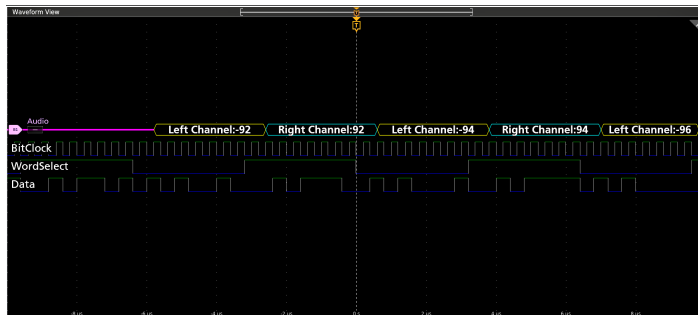

4. Tap outside of the Bus configuration menu to close it.
5. Double-tap the **Trigger** badge and use the Trigger configuration menu to trigger on a specific condition in the bus.

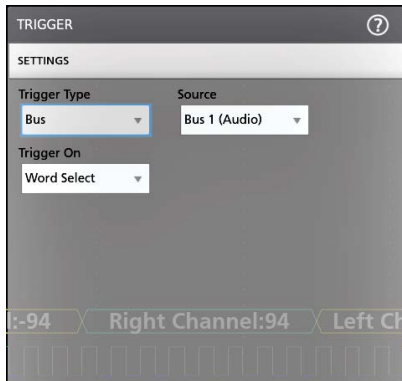

6. For more information on serial bus settings, tap the Help button on the Bus configuration menu.

## Add a parallel bus to the Waveform view

Use this procedure to add a parallel bus to the Waveform view.

When you acquire data from a Parallel bus, you can set up the bus to be clocked or unclocked. If the bus is not clocked, the instrument acquires all data from the parallel bus at the sample rate of the instrument.

1. Tap the **Add New Bus** button on the Settings bar. This adds a Bus badge bus to the Settings bar, adds a bus waveform to the screen, and opens the Bus configuration menu. The default bus type is parallel.



2. If setting up a clocked bus:

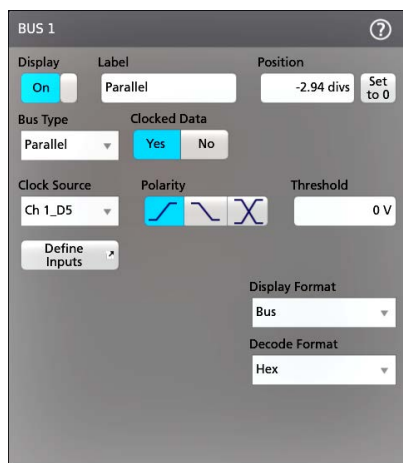

- a. Set Clocked Data to **Yes**.
  - b. Tap the **Clock Source** field and select the source for the parallel bus clock signal.
  - c. Tap the **Polarity** and **Threshold** controls and set the clock signal transition to detect and threshold level, respectively.
3. Tap **Define Inputs** and select the signal sources for the parallel bus. Signal sources can be analog, digital, math, or reference. Tap a signal in the Sources list to add it to the bus list on the left.

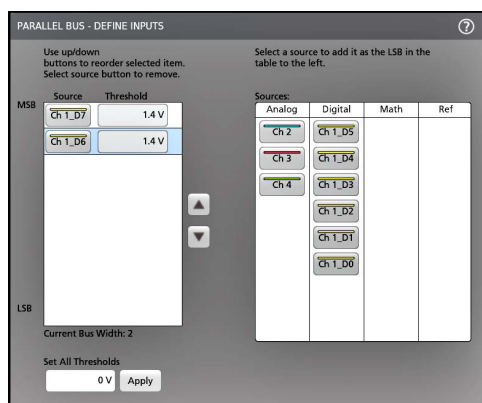

The bus waveform updates as you make changes on the configuration menu. Tap the + symbol next to the waveform handle to turn on and off showing the signals associated with the bus waveform.

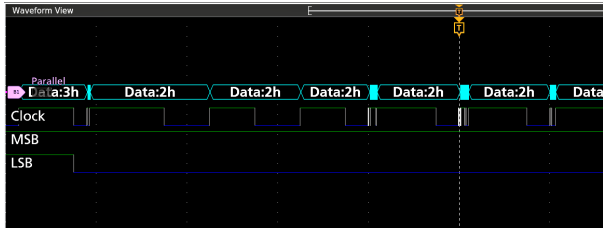

4. Use the rest of the fields and controls in the configuration menu to set up the parallel bus parameters (label, position, display and decode formats).
5. Tap outside of the Bus configuration menu to close it.
6. To get a stable triggered waveform, double-tap the **Trigger** badge, set the Trigger Type to **Bus**, select the bus Source to the parallel bus you just set up, and enter the data condition on which to trigger in the **Data** field.
7. For information on parallel bus menu settings, tap the Help button on the Bus configuration menu.

# Advanced triggering

You can check the advanced trigger status in the trigger menu. The menu indicates the trigger type and then shows sources, levels, or any other parameters that are important for the particular trigger type.

## Triggering concepts

User selected trigger conditions are used to capture waveforms for measurement and analysis.

The next figure shows how triggers fit into the overall instrument operation.

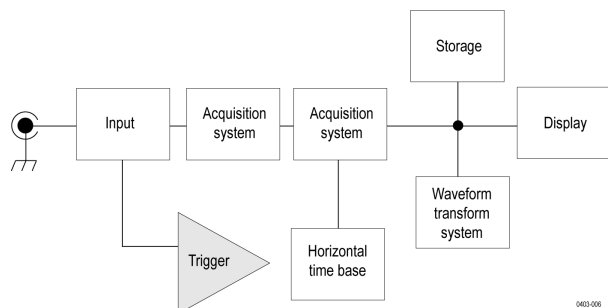

Trigger helps you to capture meaningful waveforms to display on screen. This instrument has simple edge triggers as well as a variety of advanced triggers.

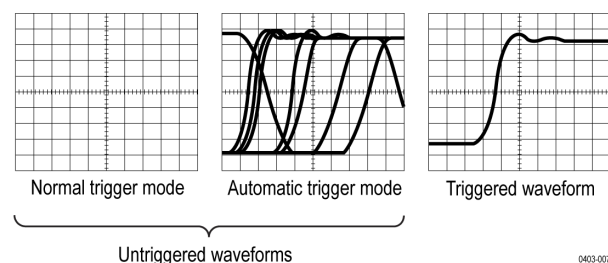

## The trigger event

The trigger event establishes the time-zero point in the waveform record. All waveform record data are located in time with respect to that point. The instrument continuously acquires and retains enough sample points to fill the pretrigger portion of the waveform record (that part of the waveform that is displayed before or to the left of the triggering event on screen).

When a trigger event occurs, the instrument starts acquiring samples to build the post-trigger portion of the waveform record (displayed after or to the right of the trigger event). Once a trigger is recognized, the instrument will not accept another trigger until the acquisition is complete and the holdoff time has expired.

## Trigger on a pulse width event

Pulse-width triggering triggers the oscilloscope when a signal pulse width is less than, greater than, equal to, or not equal to a specified pulse width. This trigger is useful for digital logic troubleshooting.

To trigger on a pulse width event:

1. Double-tap the **Trigger** badge to open the Trigger configuration menu.
2. Tap **Trigger Type** and select **Pulse Width**. See [Pulse Width Trigger configuration menu](#) on page 598.
3. Tap **Source** and select the trigger source.

4. Tap **Trigger When** and select the pulse width condition on which to trigger (> Limit, < Limit, = Limit, ≠ Limit, Outside Range, Inside Range).

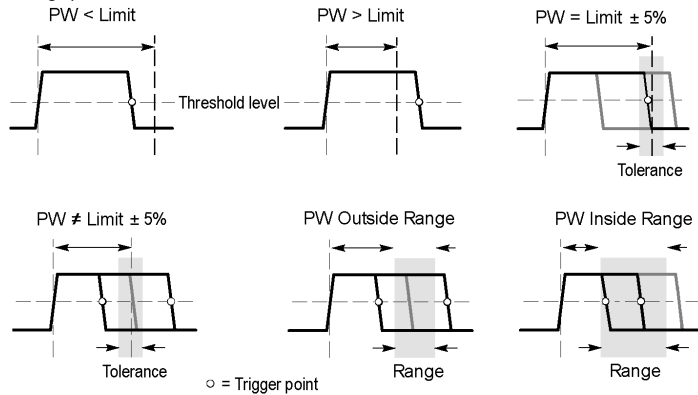

5. Set the pulse width time constraints:
  - a. For all trigger when conditions except Outside Range or Inside Range, tap the **Time Limit** field and use the assigned multipurpose knob to set the pulse width time condition to meet.
  - b. For Outside Range or Inside Range conditions, tap the **High Time Limit** and **High Time Limit** fields and use the assigned multipurpose knobs to set the pulse width time range condition to meet.
6. Tap the **Level** field and set the threshold value at which you want to measure pulse width.
7. Select the pulse polarity on which to trigger.
8. To further refine the trigger conditions, set **Logic Qualification** to **On** and tap the **Define inputs** button to define the logic condition of any other signals that must be true at the same time as the pulse width trigger event is true. See [Logic Qualification - Define Inputs configuration menu](#) on page 612.

## Trigger on a timeout event

Use Timeout triggering to trigger the oscilloscope when a signal stays above, stays below, or stays above or below a specified level for longer than a specified time limit.

To trigger on a timeout event:

1. Double-tap the **Trigger** badge to open the Trigger configuration menu.
2. Tap **Trigger Type** and select **Timeout**. See [Timeout Trigger configuration menu](#) on page 610.
3. Tap **Source** and select the signal source.
4. Tap **Trigger When** and select the condition on which to trigger (**Stays High**, **Stays Low**, or **Either**).

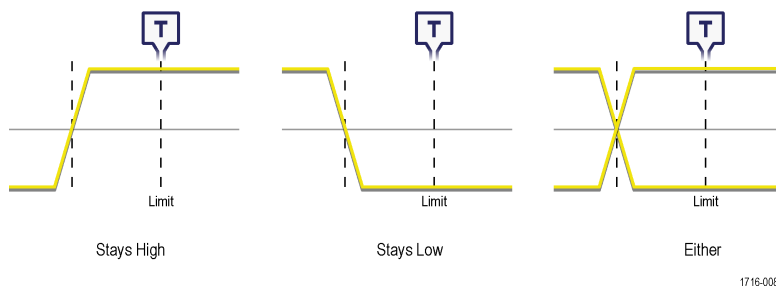

5. Tap the **Threshold** field and use the assigned multipurpose knob (or double-tap the field and use the keypad to enter a value) to set the threshold value that determines when the signal is high or low.
6. Tap the **Time Limit** field and use the assigned multipurpose knob (or double-tap the field and use the keypad to enter a value) to set the maximum time that a signal can stay high or low before transitioning to the opposite state.

- To further refine the trigger conditions, set **Logic Qualification** to **On** and tap the **Define inputs** button to define the logic condition of any other signals that must be true at the same time as the pulse width trigger event is true. See [Logic Qualification - Define Inputs configuration menu](#) on page 612.

## Trigger on a runt signal event

Use Runt triggering to locate signal pulses that do not make a full logic level transition.

To trigger on a runt event:

- Double-tap the **Trigger** badge to open the Trigger configuration menu.
- Tap **Trigger Type** and select **Runt**. See [Runt Trigger configuration menu](#) on page 602.
- Tap **Source** and select the trigger source.
- Tap **Trigger When** and select the condition on which to trigger.

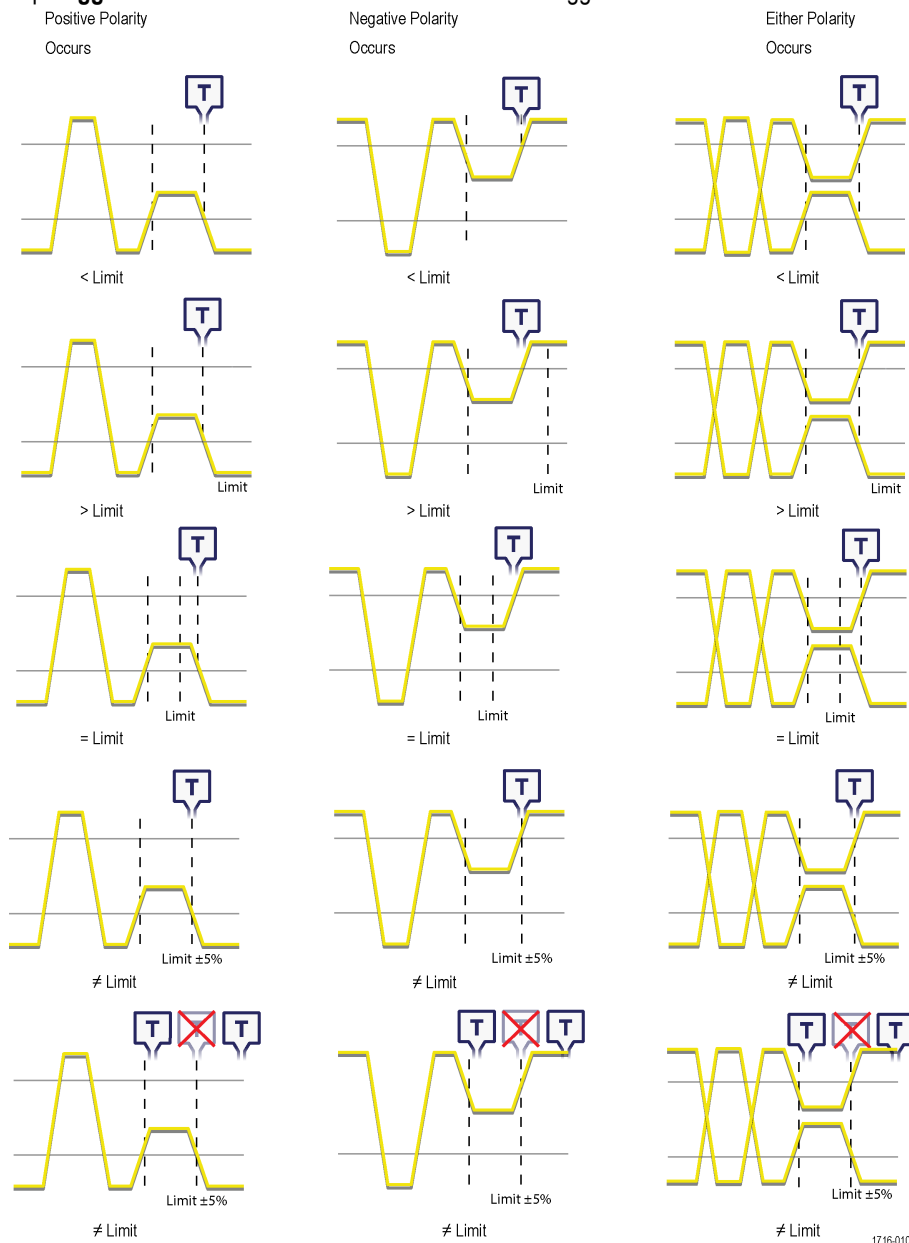

5. Tap the **Upper Threshold** field and use the assigned multipurpose knob to set the threshold value that defines the upper limit that the signal must cross to be a valid signal transition (or double-tap the field and use the keypad to enter a value).
6. Tap the **Lower Threshold** field and use the assigned multipurpose knob to set the threshold value that defines the lower limit that the signal must cross to be a valid signal transition (or double-tap the field and use the keypad to enter a value).
7. If **Trigger When** is set to a limit value, use the **Time Limit** field to set the runt signal time constraints.
8. To further refine the trigger conditions, set **Logic Qualification** to **On** and tap the **Define inputs** button to define the logic condition of any other signals that must be true at the same time as the pulse width trigger event is true. See [Logic Qualification - Define Inputs configuration menu](#) on page 612.

## Trigger on a signal window event

Use Window triggering to trigger when a signal enters or exits a specified threshold range (window), or remains inside or outside the window for a specified time limit.

To trigger on a window event:

1. Double-tap the **Trigger** badge to open the **Trigger** configuration menu.
2. Tap **Trigger Type** and select **Window**. See [Window Trigger configuration menu](#) on page 612.
3. Tap **Source** and select the signal source.
4. Tap **Trigger When** and select the condition on which to trigger.
5. Tap the **Time Limit** field to set the time value for the **Trigger When** condition.
6. Tap the **Upper Threshold** field and use the assigned multipurpose knob (or double-tap the field and use the keypad to enter a value) to set the value that defines the upper window threshold.
7. Tap the **Lower Threshold** field and use the assigned multipurpose knob (or double-tap the field and use the keypad to enter a value) to set the value that defines the lower window threshold.
8. If **Trigger When** is set to a limit value, use the **Time Limit** field to set the time constraints for how long a signal stays within or outside the window.
9. Use the **Threshold Crossing** field drop-down list to set the window threshold to cross when **Trigger When** is set to **Inside > Limit** or **Outside > Limit**.
10. To further refine the trigger conditions, set **Logic Qualification** to **On** and tap the **Define inputs** button to define the logic condition of any other signals that must be true at the same time as the pulse width trigger event is true. See [Logic Qualification - Define Inputs configuration menu](#) on page 612.

## Trigger on a logic event

Use the Logic trigger to trigger the oscilloscope when the specified logic conditions occur on any combination of analog and digital inputs.

To trigger on a Logic event:

1. Double-tap the **Trigger** badge to open the **Trigger** configuration menu.
2. Tap **Trigger Type** and select **Logic**. See [Logic Trigger configuration menu](#) on page 595.
3. Set **Use Clock Edge?** to enable or disable finding logic patterns that occur on the clock edge of a specified channel.
4. Tap **Logic Pattern Define Inputs** and use the Logic Trigger menu to set the logic state and the signal logic threshold level for each analog or digital signal.
5. Tap **Clock Source** and select the signal to use as the clock.



6. Use the **Clock Edge** controls to set the signal transition edge to use to evaluate the logic condition at the clock transition.

Clock edge logic

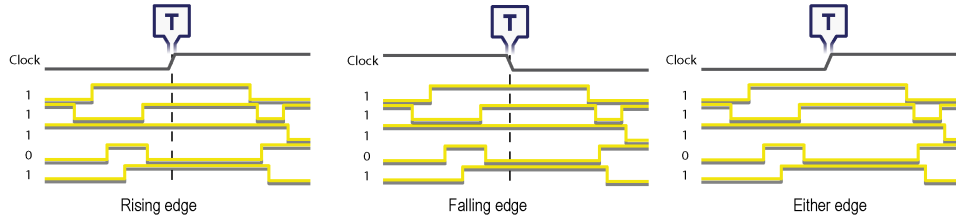

1716-011

7. Tap the **Clock Threshold** field and set the threshold level that the clock signal must pass through to be considered a valid transition. The clock threshold value is independent of the input signal threshold(s).

8. Tap **Trigger When** and select the waveform condition on which to trigger when not using a clock edge.

No clock edge logic

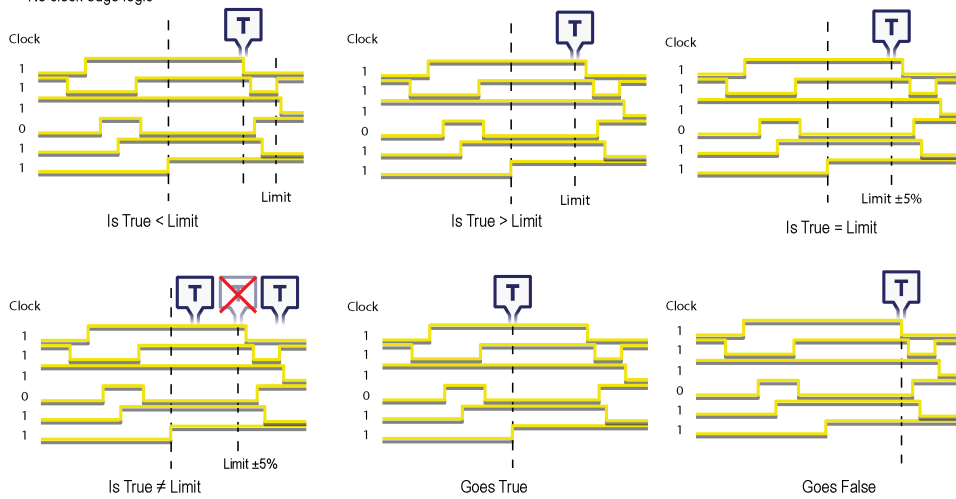

1716-012

9. Tap **Define Logic** and set the logic condition that must occur with all specified signals to cause a trigger event.

## Trigger on a setup-hold event

Use the Setup & Hold trigger to trigger on a waveform when a data signal changes state inside of a specified setup and hold time, relative to a clock edge.

To trigger on a Setup/Hold event:

1. Double-tap the **Trigger** badge to open the Trigger configuration menu.
2. Tap **Trigger Type** and select **Setup & Hold**. See [Setup and Hold Trigger configuration menu](#) on page 608.
3. Tap **Clock Source** and select the signal to use as the clock.
4. Tap the **Clock Level** field and set the threshold level that the clock signal must pass through to be considered a valid transition. The clock threshold value is independent of the input signal threshold(s).
5. Use **Clock Edge** to set which clock signal edge to use to start the trigger evaluation.
6. Tap **Define Inputs** and use the **Define Inputs** menu to set the signal input sources and their threshold levels. See [Setup and Hold Trigger - Define Inputs configuration menu](#) on page 610.
7. Tap the **Setup Time** field and set the length of setup time that the data signal must be stable before a clock edge occurs.
8. Tap the **Hold Time** field and set the length of hold time that the data signal must be stable after a clock edge occurs.

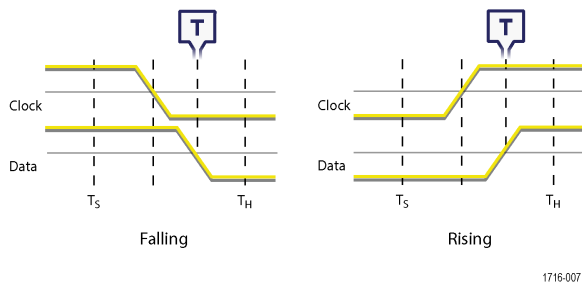

## Trigger on a rise or fall time event

Use the Rise/Fall Time trigger to trigger when the rise or fall time of a signal is less than, greater than, equal to, or not equal to a specified time limit

To trigger on a Rise/Fall event:

1. Double-tap the **Trigger** badge to open the Trigger configuration menu.
2. Tap **Trigger Type** and select **Rise/Fall**. See [Rise/Fall Time Trigger configuration menu](#) on page 600.
3. Tap **Source** and select the trigger signal source.
4. Tap **Trigger When** and select the condition on which to trigger.

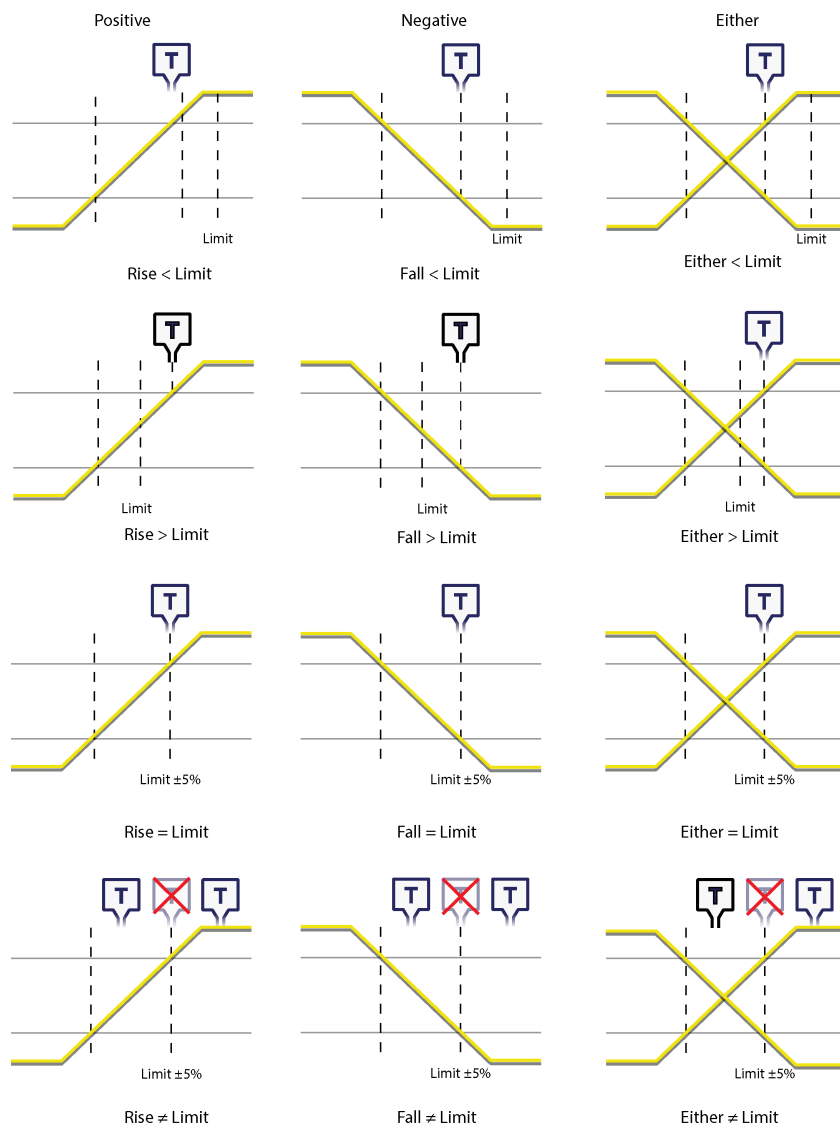

5. Tap the **Time Limit** field to set the time value for the **Trigger When** condition.
6. Tap the **Upper Threshold** field and use the assigned multipurpose knob (or double-tap the field and use the keypad to enter a value) to set the length of setup time that the data signal must be stable before a clock edge occurs.
7. Tap the **Lower Threshold** field and use the assigned multipurpose knob (or double-tap the field and use the keypad to enter a value) to set the length of hold time that the data signal must be stable after a clock edge occurs.
8. Use the **Slope** controls to set the signal transition direction to detect. (rising, falling, or either direction).
9. To further refine the trigger conditions, set **Logic Qualification** to **On** and tap the **Define Inputs** button to define the logic conditions of other signals that must be true at the same time as the setup and hold event. See [Logic Qualification - Define Inputs configuration menu](#) on page 612.

## Set up trigger on a parallel bus

Use this procedure to set up triggering on a parallel bus.

Use this procedure if you have already created a parallel bus.

1. Double-tap the **Trigger** badge.
2. Tap the **Trigger Type** field and select **Bus** from the list.
3. Tap the **Source** field and select the parallel bus on which to trigger.
4. Tap either the **Binary** or **Hex** Data boxes to enter the parallel bus data value, in either Binary or Hexadecimal format, on which to trigger. The number of bits shown depends on the number of sources (channels) in the parallel bus.
  - a. Use multipurpose knob A to select the digit or digits to change.
  - b. Use multipurpose knob B to change the value of the selected digits.

## Set up trigger on a serial bus

Use this procedure to set up triggering on a serial bus.

Use this procedure if you have already created a serial bus. Serial buses require purchasing and installing serial bus options. To trigger on a Rise/Fall event:

1. Double-tap the **Trigger** badge on the Settings bar.
2. Tap **Trigger Type** and select **Bus** from the list.
3. Tap **Source** and select a serial bus from the list.
4. Tap **Trigger On** and select what to trigger on from the list. The displayed fields and controls depend on the bus type and Trigger On selection. Use these fields to trigger on a specific bus condition. See [Bus Trigger configuration](#) on page 561.

## Trigger on sequential events (A and B triggers)

Use the A and B Trigger Events to trigger on a second event after a first event occurs.

### Set up sequential triggering

1. Double-tap the **Trigger** badge to open the Trigger configuration menu.
2. Tap **Trigger Type** and select **Sequence**. [Sequence Trigger configuration menu](#) on page 604
3. Set up the A Trigger Event:
  - a. Tap the **A Trigger Event** button to open the A Trigger Event menu.
  - b. Tap **Trigger Type** and select a trigger type from the drop-down list. This example uses Edge.
  - c. Tap **Source** and select the A event trigger source.
  - d. If displayed, tap **Coupling** and select the trigger coupling.
  - e. Tap **Level** and set the desired trigger level using the multipurpose knob. Or double-tap the field to set the value using the virtual keypad.
  - f. Tap a **Slope** button to select the slope of the signal on which to trigger (Rise, Fall, Either).
  - g. Tap anywhere outside the A Trigger Event menu to close it.
4. Set up the B Trigger Event:
  - a. Tap the **B Trigger Event** button in the main Trigger configuration menu to open the B Trigger Event menu.
  - b. Tap **Trigger Type** and select a trigger type. This example uses Runt.
  - c. Tap **Source** and select a trigger source.
  - d. Tap **Trigger When** and select the condition on when to trigger on a runt signal.
  - e. Tap a **Polarity** icon to set the runt pulse polarity to detect (positive, negative, or either).
  - f. Tap the **Upper Threshold** and **Lower Threshold** fields and set the levels that a signal must cross to be considered a valid signal. Signals that don't cross both these thresholds are runt signals.

- g. Tap anywhere outside the B Trigger Event menu to close it.
5. To trigger on a specific occurrence of the B trigger event:
  - a. Tap After the A Trigger Event is found: **Trigger on the Nth Trigger Event** button in the main Trigger menu.
  - b. Tap **Where N is:** and use the multipurpose knob to set the oscilloscope to trigger on the Nth occurrence of a B trigger event.
6. To trigger on the B event after a specific time delay:
  - a. Tap After the A Trigger Event is found: **Trigger on the 1st B Event** button.
  - b. Tap **After a Delay of:** and use the multipurpose knob to set the desired delay time to wait before detecting and triggering on a B trigger event. You can also double-tap the field and use the virtual keypad to enter a delay time.

## Set Trigger Holdoff

Trigger Holdoff sets the time, after triggering on an event, that the instrument waits before detecting the same trigger event to start the next acquisition.

Setting the correct holdoff time is important to get a stable trigger. The longer holdoff time for the top waveform causes unstable triggering. The shorter holdoff set for the bottom waveform only triggers on the first pulse in the burst to remedy the unstable trigger.

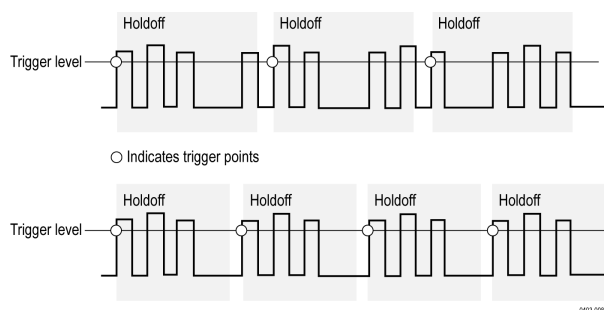

**Prerequisite:** You have set up a trigger event for a signal.

1. Double-tap the **Trigger** badge on the Settings bar to open the **Trigger** configuration menu.
2. Tap the **Mode & Holdoff** panel.
3. To set a specific holdoff time, tap **Time**, then tap **Holdoff Time** and use the assigned multipurpose knob to specify a holdoff time. Or double-tap the field and use the virtual keypad to enter a holdoff time.
4. To delay the trigger a random amount of time between triggers, tap **Random**.

## Trigger on an external signal using the AUX input (MSO58LP, MSO64, LPD64 only)

Use this procedure to trigger the instrument from an external signal connected to the AUX input (MSO58LP, MSO64, LPD64 only).

To access the user interface on a Low Profile instrument, connect a monitor to a video port on the rear of the instrument, and connect a mouse to any USB Host port. You do not need to connect a mouse if your remote monitor is touch-capable. You can also remotely access the user interface of a network-connected instrument by entering the instrument's IP address in a web browser.

To remotely set a control or run this task on a Low Profile instrument, see the instrument Programmer Manual (Tektronix part number 077-1305-xx) for the correct command or commands to use.

1. Double-tap the **Trigger** badge on the Settings bar.
2. Tap **Trigger Type** and select **Edge** from the list.
3. Tap **Source** and select **Aux**.



**Note:** The **Aux** setting is available only for the **Edge** trigger type.

4. Set the values for **Coupling**, **Level**, and **Slope** to trigger on the Aux connector signal.  
Settings take effect immediately.

## Create Visual Trigger areas

The Visual Trigger function extends standard triggering by letting you easily draw and define areas on the screen to further qualify trigger conditions. This procedure describes how to enable the visual trigger mode and draw areas on the screen.

1. Set the standard trigger conditions to trigger on and display the waveforms to which you want to add visual trigger areas.
2. Double-tap the **More** button and select the **Visual trigger** button on the **DRAW A BOX** menu window. This sets the Draw-a-Box function to Visual trigger mode.

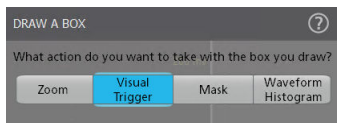

3. Tap outside the menu to close the **Draw A Box** menu. The Draw-a-Box icon is highlighted to show that it is in Visual Trigger draw mode.
4. Tap the Draw-A-Box **Zoom icon** at the up right of the **Results Bar** to draw a rectangle on the waveform screen for the first area to define. The area created is associated with the channel to which it was added (in Stacked mode) or the active channel (in Overlay mode), and assigned the default area logic condition of **In** (the area is true when the waveform intersects any part of the area).
5. Continue drawing rectangles to add other visual trigger areas:
  - a. If in Stacked mode, you can draw visual trigger areas in different waveform slices.
  - b. If in Overlay mode, select a channel before creating areas for that channel.
6. When you are done drawing visual trigger areas, single-tap anywhere to end the area draw function.
7. To draw areas again, tap the Draw-A-Box **zoom** icon again. Single tap allow you to draw the box once following which the Draw-A-Box is reset automatically. Whereas double tap allow you to draw boxes multiple times continuously.



**Note:** The draw box button autoselects if you choose an option in the More context panel.

8. To change the shape of an area, see [Edit visual trigger areas on the screen](#) on page 130 and [Edit visual trigger areas using the Area menu](#) on page 132.

## Edit visual trigger areas on the screen

Use the touchscreen or a mouse to directly edit an area, including moving, changing size, duplicating an area, moving individual vertices, adding and deleting vertices, and rotating the area.

1. To move a visual trigger area, touch and drag the area to a new position.



**Note:** You cannot drag a visual trigger area from one waveform slice to another while in Stacked display mode.

2. To delete a visual trigger area:
  - a. Touch and Hold or right-click on the area to delete.
  - b. Select **Delete Area** from the menu.
3. To resize a visual trigger area:

- a. Single-tap an area to enable resize area mode. Resize mode draws resize points on all four sides and the corners of a boundary area that contains the area.

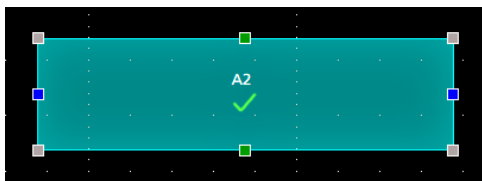

- b. Touch and drag a top, bottom, left, or right resize point to resize the area vertically or horizontally.
- c. Touch and drag a corner resize point to resize both the length and height of the area in the dragged direction.



**Note:** You cannot move an area while in resize mode.

- d. To exit resize mode, tap outside the visual trigger area. The instrument returns to normal operation.
4. To add vertices to or delete vertices from a visual trigger area:
    - a. Tap an area twice to enable add/delete vertex mode. Add/delete mode draws a crosshair at each existing vertex, and a plus symbol midway between each existing vertex.



**Note:** A triangular area does not draw the existing vertices with crosshairs, as they cannot be deleted; only the midway plus symbols are shown to let you add vertices to a triangle.

- b. Tap a vertex crosshair to delete that vertex.
- c. Tap a plus symbol to add a new vertex at that location. The area is redrawn to show the new vertex. You can continue to add vertices; there is no limit to the number of vertices in an area.



**Note:** You cannot move vertices while in add/delete vertex mode.

- d. To exit add/remove vertex mode, tap outside the visual trigger area. The instrument returns to normal operation.
5. To move vertices in a visual trigger area:
    - a. Tap the area three times to enable move vertex mode. The move vertex mode draws crosshairs on all vertices of the area.



- b. Touch and drag a vertex to move it to a new position.
  - c. To exit move vertex mode, tap outside the visual trigger area. The instrument returns to normal operation.
6. To rotate a visual trigger area:
    - a. Tap four times in the area to enable rotate area mode.

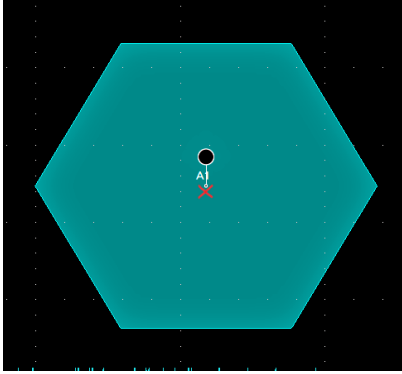

- b. Touch and drag the dot in the area to rotate the area.



**Note:** Once you are touching and dragging the rotate dot, you can move your finger outside of the area to get finer control over the rotation increments.

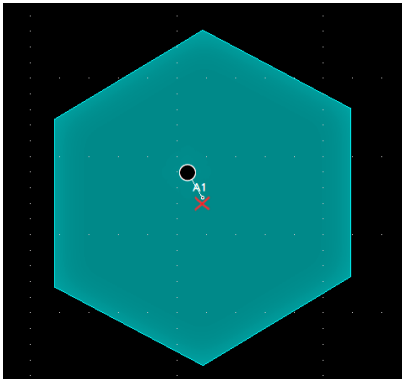

- c. To exit rotate area mode, tap outside the visual trigger area. The instrument returns to normal operation.

## Edit visual trigger areas using the Area menu

Use these procedures to edit Visual Trigger areas using the Area menu, including moving, changing size, moving individual vertices, adding and deleting vertices, and rotating the area.

See [Visual Trigger Area configuration menu](#) on page 616 for more information on the Area menu.

See [Edit visual trigger areas on the screen](#) on page 130 for information on graphically editing an area on the screen.

1. To change the input source of an area using the Area menu:
  - a. Double-tap on the area to edit.
  - b. Tap the **Source** field.
  - c. Select a new source channel. The area moves to the selected source. If the selected source is not displayed, the instrument does not display that channel when the area is changed to that source.
  - d. Tap outside the menu to exit.
2. To change the shape of an area using the Area menu:
  - a. Double-tap on the area to edit.
  - b. Tap the **Shape** field.
  - c. Select the shape to which to change the area. The area changes shape immediately.
  - d. Tap outside the menu to exit.



3. To change the area waveform logic condition using the Area menu: The waveform logic condition defines the logic true condition to assign an area when any part of a waveform intersects any part of an area:
  - **In** means that the area is true if any part of a waveform intersects any part of the area.
  - **Out** means that the area is true if a waveform never intersects any part of the area.
  - **Don't Care** ignores any waveform intersections. This creates a placeholder area to let you experiment with area definitions while developing your visual trigger.
  - a. Double-tap on the area to edit.
  - b. Tap the **Waveform Must Be** button of the logic true condition to assign to the area (**In, Out, Don't Care**). The selected logic condition is assigned immediately to the area.
  - c. Tap outside the menu to exit.
4. To change the height of an area using the Area menu:
  - a. Double-tap on the area to edit.
  - b. Tap the **Height** field and enter the height value as units of the current vertical channel settings (volts, amps, and so on). Or double-tap on the field and use the A knob to change the value. The shape immediately changes height while maintaining the vertical center position of the area.
  - c. Tap outside the menu to exit.
5. To change the vertical center of an area using the Area menu:
  - a. Double-tap on the area to edit.
  - b. Tap the **Vertical Center** field and enter the height value as units of the current vertical channel settings (volts, amps, and so on). Or double-tap on the field and use the A knob to change the value. The shape immediately changes the vertical center position of the area.
  - c. Tap outside the menu to exit.
6. To change the width of an area using the Area menu:
  - a. Double-tap on the area to edit.
  - b. Tap the **Width** field and enter the width value as horizontal time (seconds). Or double-tap on the field and use the A knob to change the value. The shape immediately changes width while maintaining the horizontal center position of the area.
  - c. Tap outside the menu to exit.
7. To change the horizontal center of an area using the Area menu:
  - a. Double-tap on the area to edit.
  - b. Tap the **Horizontal Center** field and enter the new horizontal center position value. Or double-tap on the field and use the A knob to change the value. The shape immediately changes the horizontal center position.
  - c. Tap outside the menu to exit.
8. To flip an area vertically using the Area menu:
  - a. Double-tap on the area to edit.
  - b. Tap the **Flip Vertical** button. The area immediately flips vertically around its center position.
  - c. Tap outside the menu to exit.
9. To flip an area horizontally using the Area menu:
  - a. Double-tap on the area to edit.
  - b. Tap the **Flip Horizontal** button. The area immediately flips horizontally around its center position.
  - c. Tap outside the menu to exit.
10. To rotate an area using the Area menu:
  - a. Double-tap on the area to edit.

- b. Tap the **Rotate** field and use the **A** knob to change the value. The area immediately rotates when you enter a value or change the value with the **A** knob. Or double-tap on the field and enter the number of degrees to rotate the area, where zero (0) degrees is the position when the area was created. You can rotate an area from 0° to 360°.
  - c. Tap outside the menu to exit.
11. To add a point (vertex) to an area using the Area menu:
- a. Double-tap on the area to edit.
  - b. Tap the **Edit Vertices** panel.
  - c. Select the vertex in the **Define Area** list counter-clockwise from you want to insert a new vertex. Selecting a vertex highlights that vertex on the area.
  - d. Tap **Insert Point**. A new vertex is added to the area, marked with an X, and is highlighted in the list.
  - e. Continue adding vertices as needed.
  - f. Tap outside the menu to exit.
12. To delete a point (vertex) from an area using the Area menu:
- a. Double-tap on the area to edit.
  - b. Tap the **Edit Vertices** panel.
  - c. Select the vertex in the **Define Area** list that you want to delete. Selecting a vertex highlights that vertex on the area.
  - d. Tap **Delete Point**. A new vertex is deleted to the area, marked with an X, and is highlighted in the list.
  - e. Continue deleting vertices as needed.
  - f. Tap outside the menu to exit.
13. To move individual vertices in an area using the Area menu:
- a. Double-tap on the area to edit.
  - b. Tap the **Edit Vertices** panel.
  - c. Select the vertex in the **Define Area** list that you want to move. Selecting a vertex highlights that vertex on the area.
  - d. Tap the X (time) axis or Y (Ampl.) field in the list and use the **A** and **B** knobs to change the position values. Or double-tap on each field and enter the new positional values for that vertex.
  - e. Tap outside the menu to exit.
14. To reset the shape using the Area menu:
- a. Double-tap on the area to edit.
  - b. Tap the **Edit Vertices** panel.
  - c. Tap **Reset Points**. The shape changes to a triangle centered in the display or slice.
  - d. Tap outside the menu to exit.

## RF vs Time trigger

Use the Time Domain Traces available in the Spectrum View tab to trigger a time domain signal. Select the Magnitude or Frequency control to enable these sources in the Trigger Settings menu.

Below is the example of trigger on an amplitude modulated signal with carrier 1 GHz modulated with a 20 KHz square wave.

1. In the **Channel** menu > Go to **Vertical Settings** tab > set 50 ohm in the termination.
2. Set the maximum licensed bandwidth (8 GHz for MSO6).

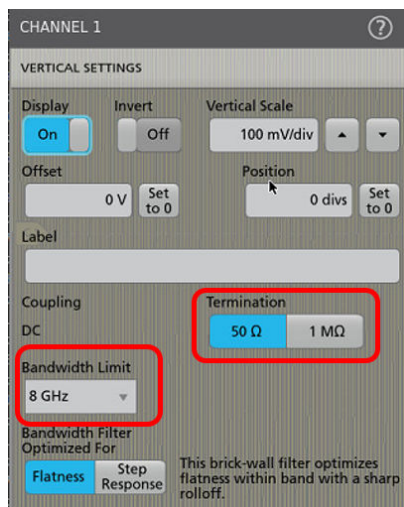

- In the **Channel** menu > **Spectrum view** tab, under RF vs. Time Waveforms, select **Magnitude**.
- Select the **Display** toggle to **On**.

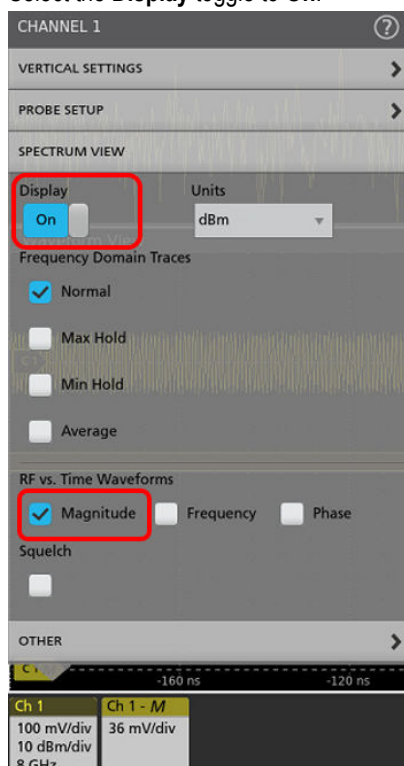

- In the **Spectrum view** tab, set Center Frequency and span to the region of interest (1 GHz center frequency with 100 MHz span is used).
- Change the horizontal scale to 10 us/div to view 2 periods of the modulation signal.
- Open the **Magnitude vs. Time** menu and adjust the Vertical Scale and Position until you view the Magnitude vs. Time trace on Oscilloscope UI.



**Note:** Use pinch and drag to adjust the height and position.

The waveform displayed will not be stable, as it is still in triggering on CH1.

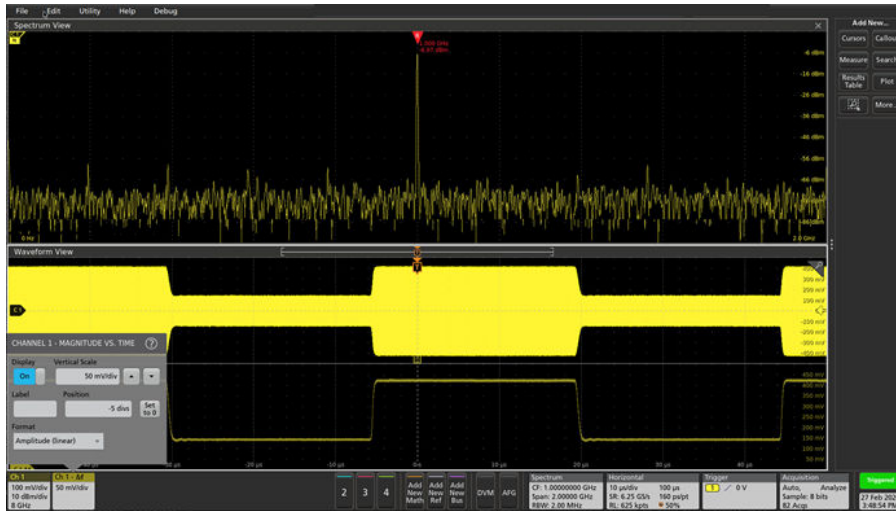

8. In the **Trigger** menu, select CH1 > Mag\_vs\_Time.

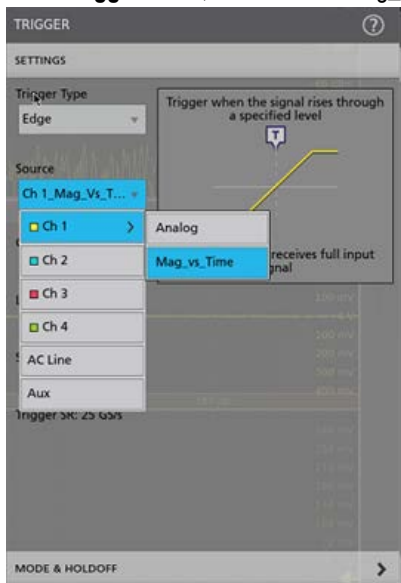

9. Adjust the trigger level to the center of the Magnitude vs. Time waveform.  
The displayed waveform is now stable because it is triggered on the Magnitude vs. Time.

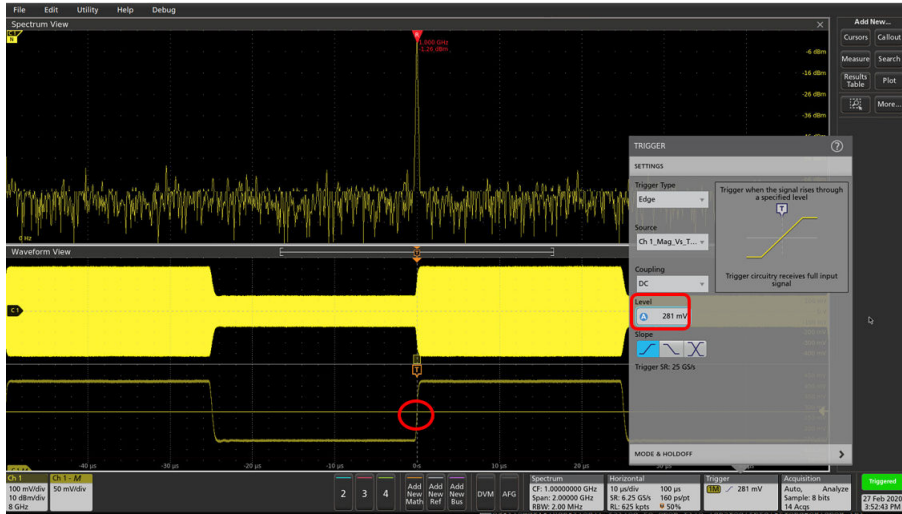

## Using Spectrum View

Spectrum View provides a time domain view of the frequency components of a signal.

### Spectrum View concepts

Typical oscilloscope displays show electrical signals as a graph of time on the x-axis versus amplitude on the y-axis (time domain). A spectrum trace shows the same electrical signals as a graph of frequency on the x-axis versus amplitude on the y-axis (frequency domain).

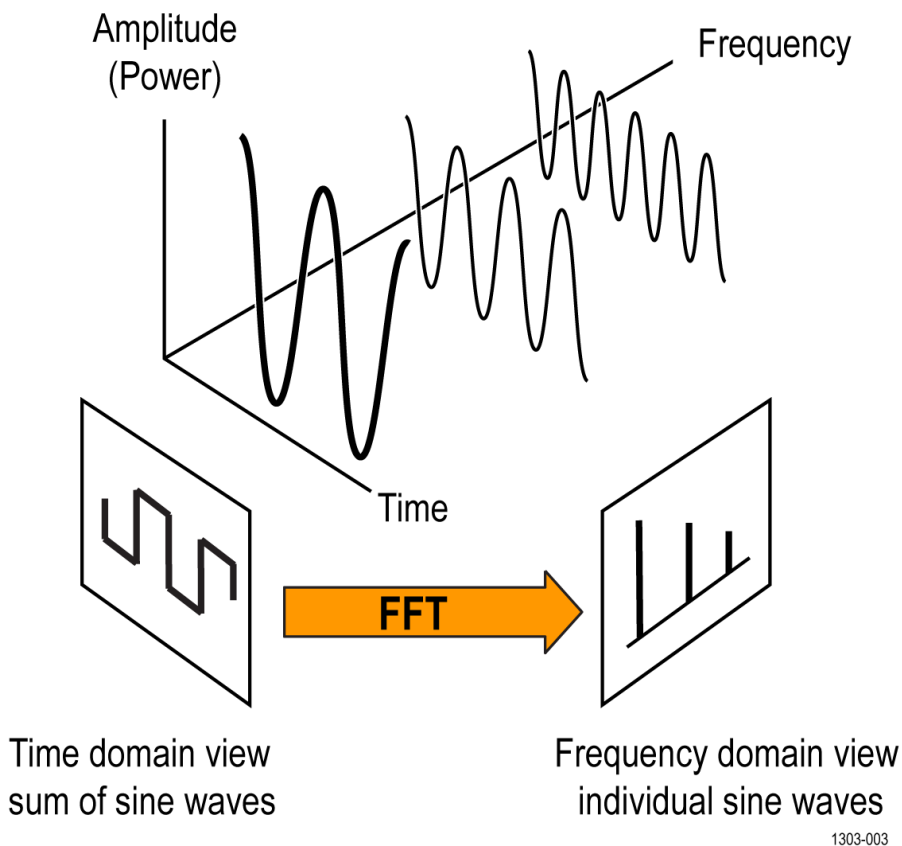

Time domain view  
sum of sine waves

Frequency domain view  
individual sine waves

1303-003

Figure 11: The time and frequency domain components of a waveform.

All time-domain signals can be defined as a composite of discrete sine waves, each with their own frequency, magnitude, and phase. The frequency-domain waveform (or spectrum trace) is a Fast Fourier Transform (FFT) decomposition of the time-domain signal into its constituent sine wave frequency components.

There are several advantages to examining signals in the frequency domain:

- It is easier to analyze signal noise characteristics. In the time domain, noise can appear as a fuzzy waveform, but in the frequency domain you can determine if it is broadband, random noise, or perhaps cross-talk from another signal on your DUT.
- It is easier to analyze and measure the distortions on signals. Although a 1% distortion on a sine wave may not be discernible in the time domain, it will be very obvious in the frequency domain as harmonics of the signal.
- Wireless communication measurements are described in the frequency domain in terms of frequency bands and channels. A spectrum trace lets you focus analysis on the relevant frequency range and make specialized measurements such as occupied bandwidth and modulation quality.

## FFT and Spectrum View

Most modern oscilloscopes provide a Math FFT function to display the frequency-domain spectrum of a signal. The typical approach to creating an FFT is to use the same data acquisition used for the time-domain waveform (1), process it through an FFT, and display that data in a separate area or window (2).

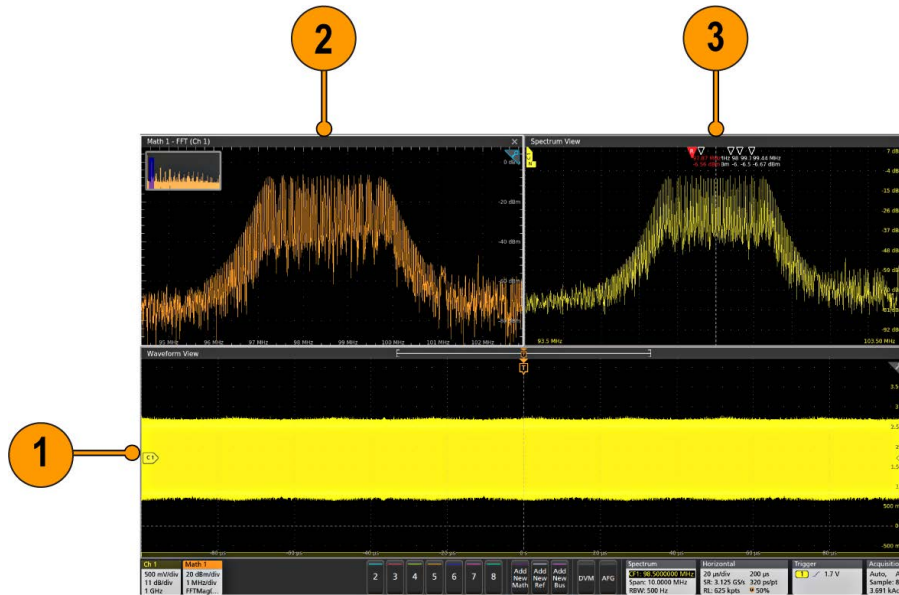

The disadvantage of a standard **Math FFT** is that the instrument uses the same acquisition data for both the time- and frequency-domain views. Therefore, the instrument settings for sample rate and record length affect both the time-domain and **Math FFT** acquisitions. Displaying an optimized FFT trace often involves manual calculations of the time-domain parameters like sample rate and record length. This also means that the instrument settings often cannot be optimized to show relevant information in both the waveform and **Math FFT** views at the same time. The following image shows a change in the Horizontal Scale setting that quickly changes the **Math FFT** plot.

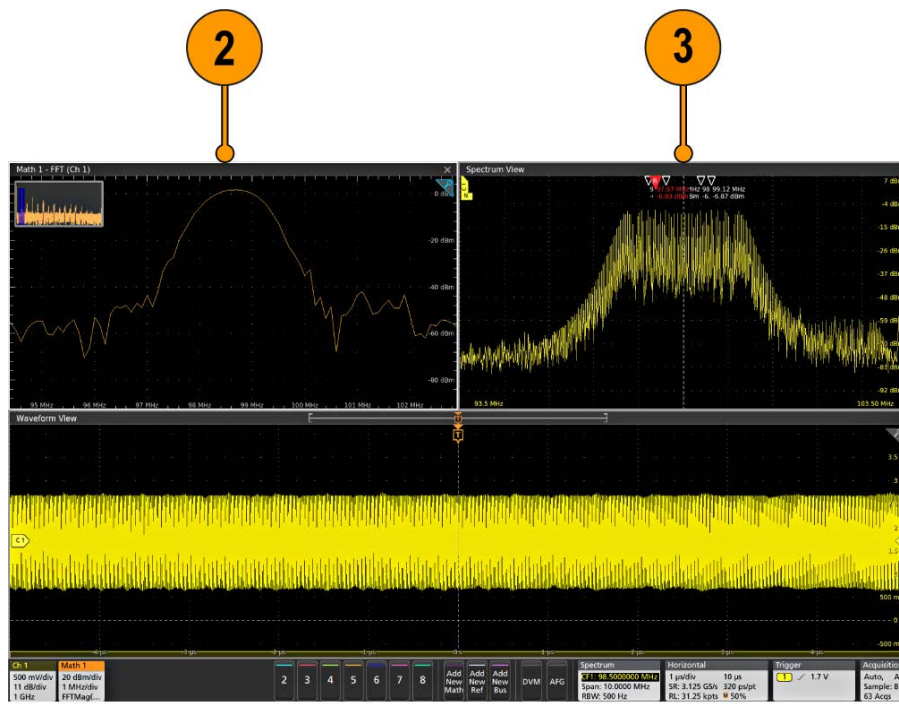

1303-012



The **Spectrum View** feature in 4/5/6 Series instruments solves this problem by using a separate hardware path in the acquisition engine of each channel to acquire the frequency-domain data in parallel with the time-domain data. This frequency-domain data is processed, transformed, and displayed in a separate **Spectrum View** window (3) that is optimized to display and adjust spectrum traces independently of the time-domain waveform. Notice that the **Spectrum View** trace has not changed in the above images with changes to the time-domain signal, but the **Math FFT** signal is not usable for measurements in the second image.

Another key feature of **Spectrum View** is that you can display a spectrum trace for each **FlexChannel** input, along with their corresponding time-domain waveforms. The **Spectrum View** user interface is optimized to display and control frequency-domain parameters such as reference level, center frequency, span, and resolution bandwidth. Changing settings when the **Spectrum View** window is active (selected) does not change settings of the associated time-domain waveform in the **Waveform View**.



1303-016

## Time Domain Traces concepts

Time Domain Traces let you view and analyze Magnitude, Frequency, and/or Phase versus time traces for each Spectrum View trace.

### Overview

Time Domain Traces display information collected from Spectrum View alongside other time domain waveforms. This allows for analysis of spectral content as it changes over time, providing some features of a real-time spectrum analyzer. Because the Spectrum View controls are not tied to the horizontal settings of the oscilloscope, these traces can be examined in detail without sacrificing Span or RBW.

The data in these traces is derived from the IQ data of the acquired signal. This is the same source that is used to calculate the spectrum trace.

### Magnitude Vs. Time

The **Magnitude Vs. Time** trace shows the magnitude (amplitude) of the Spectrum View signal span versus time. Typical uses include viewing and analyzing RF pulse power and transmission/channel power.



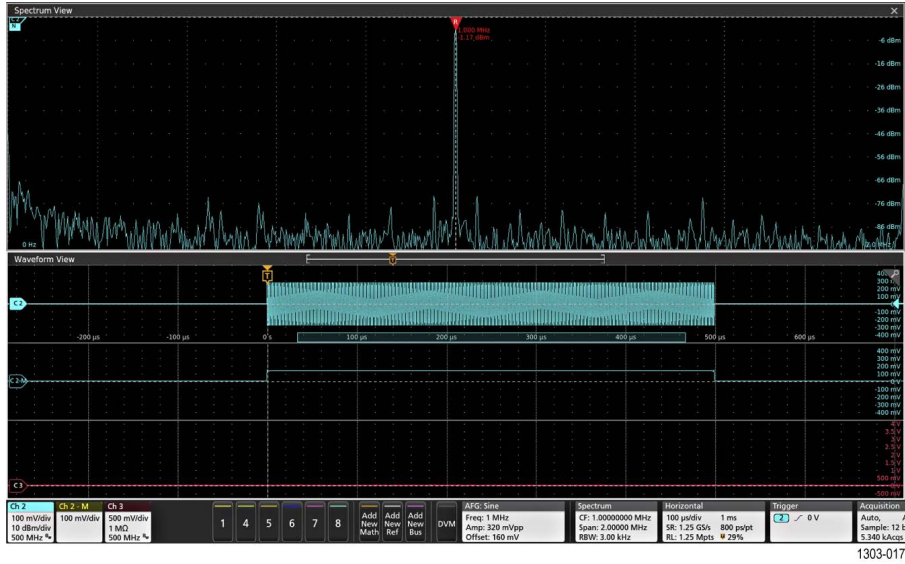

This trace provides three different ways to calculate and present RF magnitude:

- Linear Power: Direct use of linear power
- Linear Amplitude: Square root of the linear power values
- Log Power (dB)

## Frequency Vs. Time

The **Frequency Vs. Time** trace shows the dominant frequency of the Spectrum View signal and the change in frequency over time.



This trace can help characterize frequency modulation, frequency drift, and brief changes in frequency that might not be obvious in the spectrum trace.

## Phase Vs. Time

The **Phase Vs. Time** trace shows the change in the signal phase over time, where the instrument measures the incoming signal's dominant or carrier frequency to derive a reference signal to use as the phase reference.

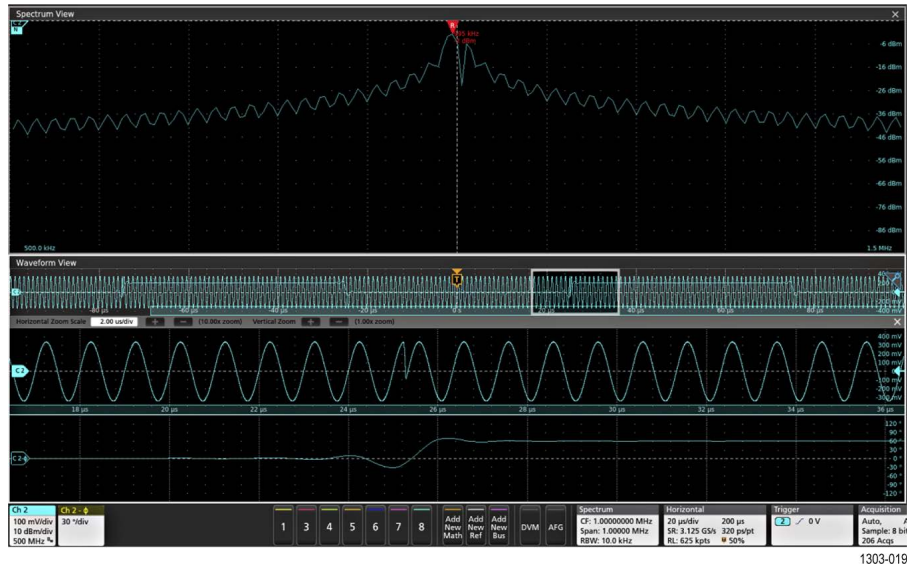

This trace can help characterize phase modulation and phase drift. Changes in phase are not visible in the spectrum trace, and can be difficult to locate in the time-domain signal.

## Display a spectrum trace

Spectrum traces are initially set up from each channel's badge menu.

1. Display the channel signal for which you want a spectrum trace.
2. Double-tap the channel badge.
3. Tap the **Spectrum View** panel.
4. Set **Display** to **On**. The instrument opens the **Spectrum View** window and adds a **Spectrum** badge to the Settings bar.
5. Select the **Frequency Domain Traces** to show in the **Spectrum View** (**Normal**, **Max Hold**, **Min Hold**, and/or **Average**).
6. Select the vertical **Units** (default is dBm).
7. Select which RF vs. Time waveforms to display.
8. Double-tap the **Spectrum** badge. See [Spectrum badge menu](#) on page 554.
9. Use the **Center Frequency**, **Span**, **FFT Window**, and **RBW Mode** controls to set these parameters to display the spectrum trace for the channel waveform. This menu also controls the **Spectrum Time Bar** (see [Spectrum View and Spectrum Time](#) on page 145).
10. To change the **Span**, use a horizontal pinch or expand motion on the touchscreen, or use the front-panel **Horizontal Scale** knob.



**Note:** Setting Span sets the same span value across all spectrum traces, regardless of the center frequency. For example, the trace 1 center frequency is set to 40 MHz, and span is set to 20 MHz, so trace 1 shows frequencies from 30 MHz to 50 MHz. If you add a spectrum trace for channel 2 with a center frequency of 60 MHz, trace 2 uses the same 20 MHz to show frequencies from 50 MHz to 70 MHz.

11. To change the vertical **Scale**, use a vertical pinch or expand motion on the touchscreen, or use the front-panel **Vertical Scale** knob.
12. To add peak markers to the trace, double-tap in a spectrum slice to open the **Spectrum View** menu and tap the **Markers** panel. Use the controls to set the number of markers to display, the threshold level at which to detect peaks, and the excursion range required by the peaks. See [Spectrum View window configuration menu](#) on page 548

## Enable the spectrogram

Use this procedure to display the spectrogram.

Spectrogram is initially set up from each channel's badge menu.

1. Display the channel signal for which you want a spectrogram.
2. Double-tap the channel badge.
3. Tap the Spectrum View panel.
4. Set **Display** to **On**. The instrument opens the Spectrum View window.
5. Select the **Frequency Domain Traces** to show in the Spectrum View (**Normal**, **Max Hold**, **Min Hold**, and/or **Average**).
6. Select the **Spectrogram** box.

The spectrogram displays in the spectrum view.

## The Spectrum View user interface

A spectrum trace shows the magnitudes of the frequency components that make up the time-domain waveform. Use spectrum traces in the **Spectrum View** to view noise, distortion, and crosstalk information of time-domain signals.

### The Spectrum View elements

Predominant frequencies (with greater magnitude) are shown as peaks in the view. The vertical graticule represents the signal magnitude, and the horizontal axis represents frequency, with the starting (lowest) frequency at the left side of the graticule.

Each spectrum trace can display up to four spectrum trace types for each source channel: **Normal**, **Max Hold**, **Min Hold**, and **Average**. You can turn each of these traces on and off independently. You can display all or some of them simultaneously.

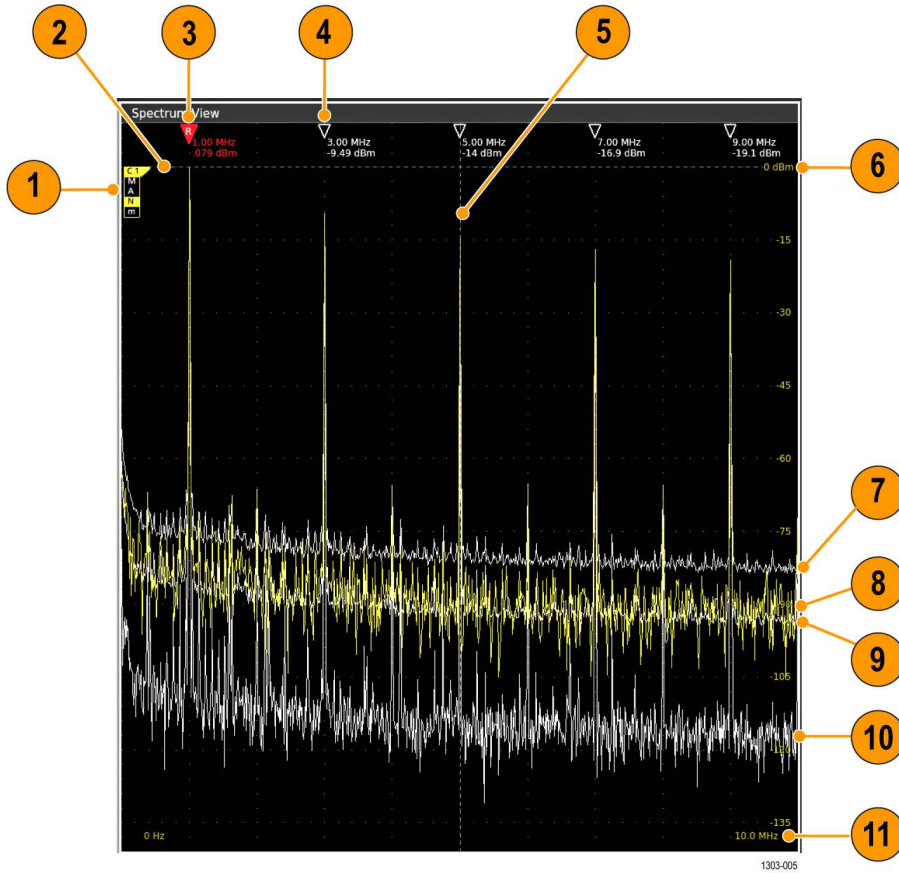

Figure 12: The Spectrum View window elements

1. The trace handle. See [Spectrum trace handle and trace types](#) on page 149.
2. The Reference level. The vertical scale (V/div) setting of the source time-domain waveform sets the spectrum trace reference level as follows:

Source vertical scale	Trace reference level	Source vertical scale	Trace reference level
500 $\mu$ V/div	-42 dBm	100 mV/div	4 dBm
1 mV/div	-36 dBm	200 mV/div	10 dBm
2 mV/div	-30 dBm	500 mV/div	18 dBm
5 mV/div	-22 dBm	1 V/div	24 dBm
10 mV/div	-16 dBm	2 V/div	30 dBm
20 mV/div	-10 dBm	5 V/div	38 dBm
50 mV/div	-2 dBm	10 V/div	44 dBm

3. The Reference marker labels and measures the highest-magnitude peak of the visible spectrum trace.
4. The Automatic markers label and measure the adjacent next-highest-magnitude peaks of the spectrum trace. The frequency and magnitude readouts can be absolute values or values relative to the Reference marker. See [Spectrum peak markers](#) on page 150.
5. The **Center Frequency** is a specified frequency at the center of the spectrum display. For many measurements it is the frequency of interest to measure, such as a carrier frequency. It may or may not be the highest magnitude peak in the trace. Each trace can have a separate center frequency setting. Changing the horizontal position of a trace in the **Spectrum View** window changes the center frequency of that trace and repositions the trace as needed.

6. The Amplitude (magnitude) scale. The vertical scale setting of the spectrum trace (pinch/expand actions on the touch screen, or the Vertical Scale knob on the front panel) sets the scale values.
7. The **Max Hold** trace shows the maximum data values that are accumulated and displayed over multiple acquisitions of the Normal trace.
8. The **Normal** trace shows each acquisition as new data is acquired. This is the default trace mode. The trace is shown in the same color as the source channel.
9. **Average** trace shows data that is averaged over multiple acquisitions. This is true power averaging, which occurs before the log conversion. Each power of 2 averaging reduces the displayed noise by 3 dB.
10. **Min Hold** trace shows the minimum data values accumulated over a specified number of acquisitions.
11. The **Span** is the range of frequencies (lowest to highest) to show on the spectrum trace. All spectrum traces have the same span regardless of the center frequency setting.

## Spectrum View guidelines

- The **Spectrum View** window supports stacked and overlay display modes. When in Overlay display mode:
  - The vertical and horizontal in-graticule labels apply to the currently selected channel.
  - The MANm spectrum trace handle (see [Spectrum trace handle and trace types](#) on page 149) for the currently selected channel is shown highlighted, just like with analog channels.
  - The MANm trace handle for non-selected traces are shown in the same fashion as non-selected analog channels.
- The **Spectrum View** does not support zoom.
- Horizontal pinch and expand touch gestures adjust the spectrum span in the same style as a horizontal pinch/expand in the **Waveform View**.
- A horizontal pan adjusts the center frequency. While panning, the pan motion will pause momentarily when the Reference Marker reaches the middle of the graticule. This provides a very simple Marker to Center functionality.
- Vertical pinch and expand touch gestures adjust the spectrum vertical scale in the same style as a vertical pinch/expand in the **Waveform View**.
- A vertical pan adjusts the vertical position. While panning, the pan motion will pause momentarily when the trace handle reference level reaches the top of the graticule. This provides a very simple reference level to top functionality.

## Spectrum View and Spectrum Time

Spectrum Time controls the area in the time-domain acquisition used to create the **Spectrum View** trace. Conceptually like gating, use Spectrum Time to examine the spectrum of specific areas of interest in the acquisition record.

**Spectrum View** is the part of the time-domain waveform acquisition used to create the **Spectrum View** trace for that channel.

**Spectrum Time** is shown by a shaded bar along the bottom of a Channel graticule in the **Waveform View**. This bar is called the **Spectrum Time Bar**. The Spectrum Time Bar visually indicates both the range and time position in the acquisition record used to create the spectrum trace.



1303-015

The Spectrum Time width (amount of the acquisition record) is determined by the FFT Window factor divided by Resolution Bandwidth (RBW). Changing the FFT window type and/or the RBW parameters changes the Spectrum time width.

The Spectrum Time position can be moved through the time domain acquisition using a variety of methods including tapping and dragging it, using the **Wave Inspector Pan** knob, or with the **Spectrum Time** position control in the **Spectrum** configuration menu.

The FFT Window, **RBW**, and **Spectrum Time** settings are in the **Spectrum** menu (see [Spectrum badge menu](#) on page 554).

The Spectrum Time Bar is shown whenever a **Spectrum View** trace is enabled for a channel.

**Table 3: Spectrum View RF vs Time, Acquisition time vs Span**

Oscilloscope	6 Series / 6 Series B 25 GS/s	6 Series B 12.5 GS/s	5 Series 6.25 GS/s	4 Series 6.25 GS/s
Span	Max RFvT (seconds)	Max RFvT (seconds)	Max RFvT (seconds)	Max RFvT (seconds)
2 GHz	0.086			
1.25 GHz	0.172			
1 GHz	0.172	0.086		
500 MHz	0.344	0.172	0.086	0.021

Table continued...







Using cursors in the **Waveform View**, the measured time from power-up to when the SS clock signal is stable was 4.847 seconds.

## Spectrum Time guidelines

- Spectrum Time can be as long as, but never longer than, the RF acquisition time.
- To position the Spectrum Time Bar to areas of interest, tap and drag the bar, or use the front-panel **Pan** knob to move the bar of the selected Waveform View channel.
- You can set the Spectrum Time Bars to lock together across all input channels, so that moving one moves all Spectrum Time bars. The Spectrum Time Bars can also be unlocked and moved to show the Spectrum of different portions of different channels.
- When **Spectrum Time** is not locked across all channels (**Lock Spectrum Time Across All Channels** is not selected), and zoom is **On**, the **Pan** front-panel knob controls the **Zoom Box** of the selected channel.
- When **Spectrum Time** is not locked across all channels (**Lock Spectrum Time Across All Channels** is not selected), and zoom is **Off**, the **Pan** front-panel knob controls the **Spectrum Time Bar** of the selected channel.



## Spectrum trace handle and trace types

The spectrum trace handle provides details on the trace reference level, the source channel for the trace, and which trace types are displayed and selected.

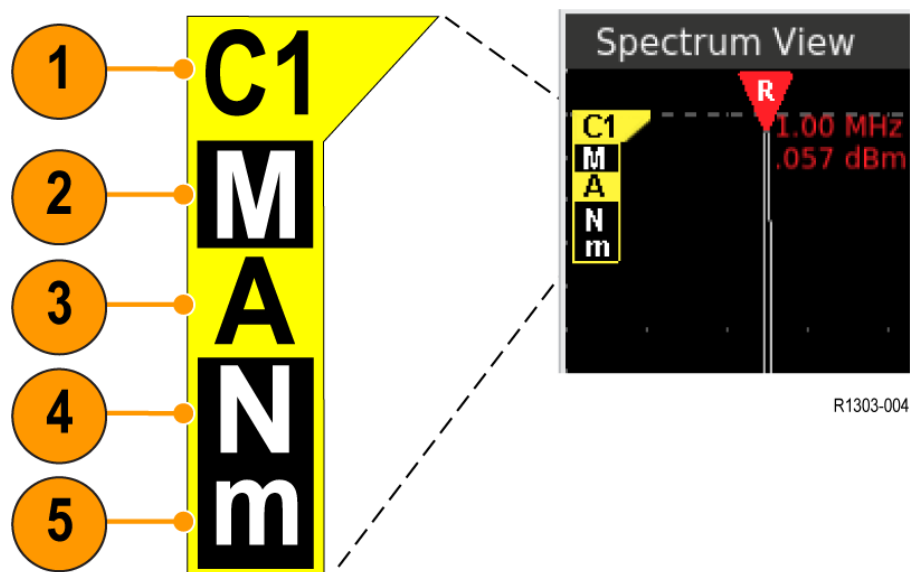

Figure 13: The Spectrum View trace handle elements

1. The trace's source channel (at top of the handle) and trace reference level (top edge of the handle, with dashed line extending across the screen). Spectrum View shows the spectrum traces relative to a Reference Level reference point. The color of the handle is the same as the source channel.

If the Reference level is outside of the displayed trace (above or below the graticule), the handle is drawn with the channel source text pointing toward the Reference level.

2. A capital **M** indicates that the maximum trace is enabled. If the maximum trace is not enabled, this letter is not shown.
3. A capital **A** indicates that the average trace is enabled. If the average trace is not enabled, this letter is not shown.
4. A capital **N** indicates that the normal trace is enabled. If the normal trace is not enabled, this letter is not shown.
5. A small **m** indicates that the minimum trace is enabled. If the maximum trace is not enabled, this letter is not shown.

The above image shows all traces enabled and the **A (Average)** trace selected. Highlighting around a letter indicates that trace type is selected.

### Trace handle and trace type guidelines

There are important distinctions between enabled (displayed) and selected traces:

- An enabled trace is a trace type that is enabled in the **Spectrum View** panel of the source channel badge and is shown in the spectrum view window. If the trace type is not enabled, its corresponding letter is not shown in the trace handle and there is no corresponding trace shown on the screen.
- A selected trace (highlighted around the letter) is the trace that is used for marker and cursor readouts. Only one trace type can be selected at a time. Double-tap the trace handle to change the selected trace type.
- You can enable and display any combination of trace types for each spectrum trace.
- Disabling all trace types causes the spectrum view for that channel to close.
- If there is only one spectrum trace shown in the **Spectrum View**, and you disable all trace types or turn off the spectrum function for that channel, the **Spectrum View** window closes.

## Spectrum peak markers

Automatic peak markers assist with quickly identifying the frequency and amplitude of peaks in the spectrum trace. Access the marker settings by double-tapping in a spectrum trace slice window (Stacked mode) or trace (Overlay mode) to open the **Spectrum View** menu.

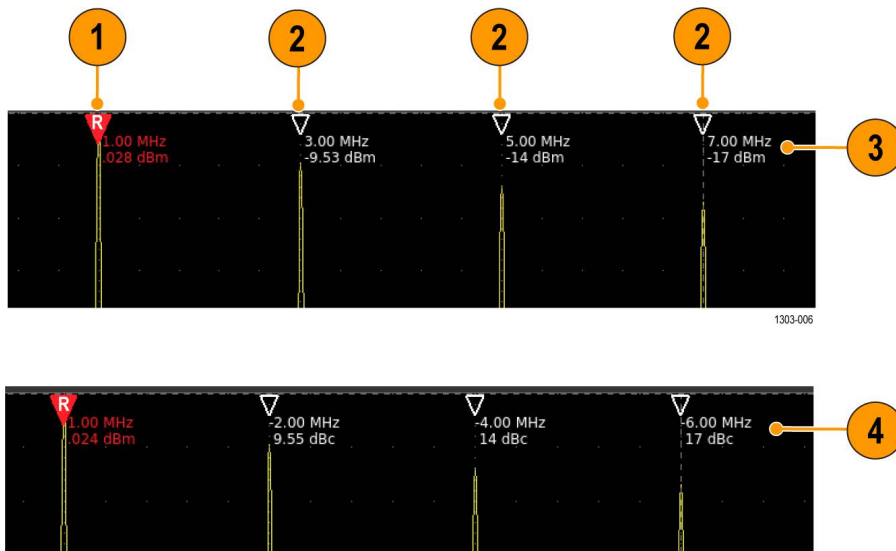

Figure 14: The spectrum peak markers

1. The highest peak shown is considered the **Reference** peak, and is labeled with a red Reference marker triangle. The **Reference** marker readout (also in red) always shows the absolute amplitude and frequency of that peak, regardless of the Readout type setting (**Absolute** or **Delta**).
2. The **Automatic** peak markers are hollow white triangles that mark the next highest peaks in the trace, depending on the marker parameters.
3. **Absolute** readouts on markers show the actual frequency and amplitude values of the marked peaks of the selected trace.
4. **Delta** readouts on Automatic markers show the delta frequency and delta amplitude of the marked peaks, of the selected trace, relative to the Reference marker readout.

### Marker parameters

To set marker parameters, double-tap in the **Spectrum View** window and tap the **Markers** panel (see [Spectrum View window configuration menu](#) on page 548). Marker parameters include:

- Turning marker display **On** or **Off**.
- The number of markers to display (1 to 11). Selecting 1 shows just the **Reference** marker.
- The peak **Threshold** value, which is the minimum absolute peak level that peaks must equal or exceed to display a mark on that peak.
- The peak **Excursion** value, which is the minimum magnitude (excursion range) that peaks must equal or exceed to display a mark on a peak.
- The type of readout values to display (**Absolute** or **Delta**).

## Spectrum View and front panel controls

The front panel controls provide direct access to many spectrum-related parameters when you select the **Spectrum View** window.

- The **Vertical Scale** knob controls the vertical scale of the currently selected spectrum trace. Note that this is purely a display function. It does not change the source channel's volts/div setting or the reference level of the spectrum.

- The **Vertical Position** knob controls the vertical position of the currently selected spectrum. This is a display function to visually position the spectrum trace.
- Pushing the **Vertical Position** knob resets the vertical position such that the spectrum reference level is at the top of the slice (**Stacked** mode) or the top of the display (**Overlay** mode).
- The front panel vertical channel buttons only function for time domain (analog) channels. If you are in **Spectrum View** mode, pushing a channel button activates the **Waveform View** window and selects the button's channel.
- The **Horizontal Scale** knob controls span. This affects all spectrum traces.
- The **Horizontal Position** knob controls center frequency. This affects all channels if center frequencies are locked. If not, it affects only the currently selected spectrum trace.
- Pressing the **Horizontal Position** knob moves the Reference Marker to center screen.

## Spectrum View and badges

Spectrum View makes changes to channel badges and adds a new Spectrum badge.

When a channel is set to show a **Spectrum View** trace, the second row of the channel badge changes from the probe symbol or input impedance readout to the vertical units of that channel's spectrum trace.

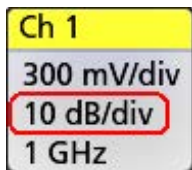

When the first spectrum trace is enabled for any analog channel, the instrument opens the **Spectrum View** window and adds the **Spectrum** badge to the **Settings Bar**. The first line of the Spectrum badge shows the center frequency of the selected spectrum trace.



Tap the **Spectrum** badge to show the **Span** buttons to quickly increase or decrease the Spectrum trace span. Changing the span for one Spectrum trace changes the span for all traces.

The Spectrum badge shows a Spectrum Time which indicates the width of the Spectrum Time bar.

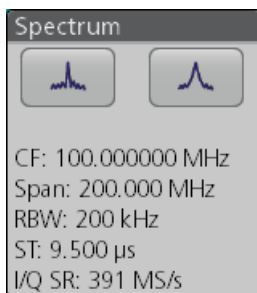

When more than one Spectrum trace is enabled and at least two center frequencies are defined, the Spectrum badge lists the center frequency for each enabled Spectrum trace.

Double-tap the **Spectrum** badge to open the **Spectrum** menu to set Span, RBW, and other parameters.

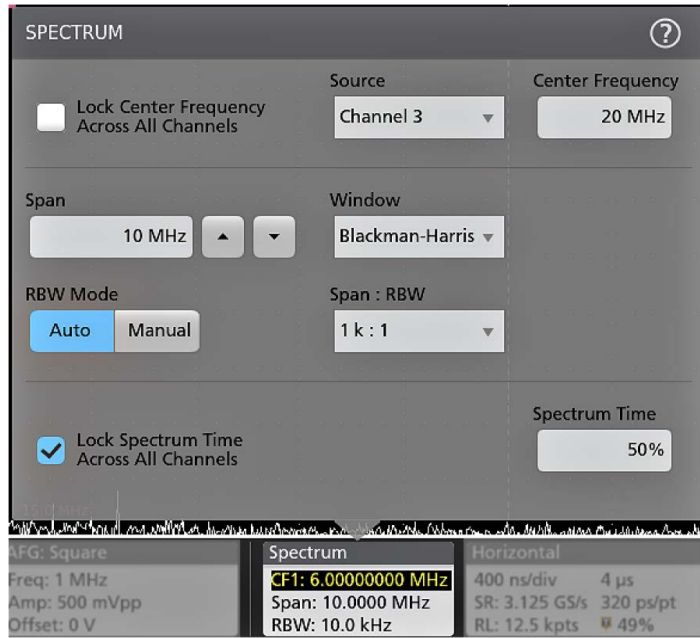

1303-010

The spectrum **Span**, **RBW** (resolution bandwidth), and (FFT) **Window** settings apply to all spectrum traces. The **Center Frequency** and **Spectrum Time** can be set for each Spectrum trace. See the [Spectrum badge menu](#) on page 554.

### Spectrum View Time Domain trace badges

The **Spectrum View Time Domain** traces (**Magnitude Vs. Time**, **Frequency Vs. Time**, **Phase Vs. Time**) are shown when you enable these functions in the **Spectrum View** panel of a **Channel** badge configuration menu.

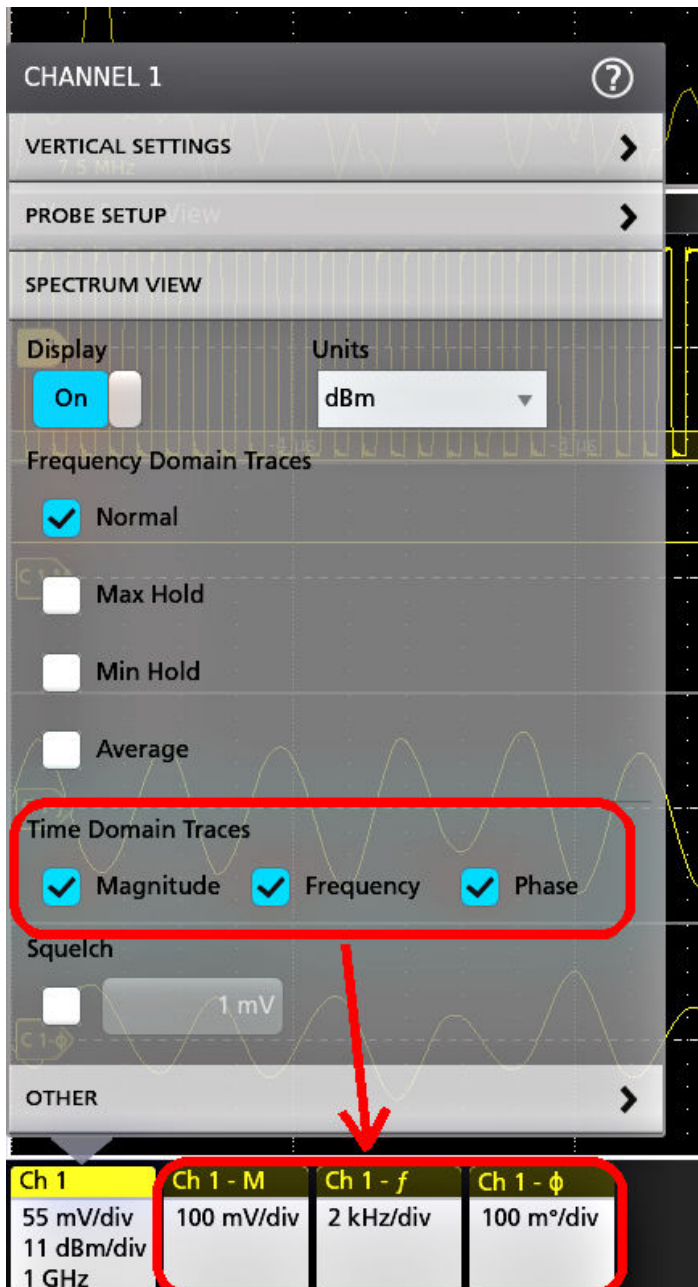

Each time domain trace has its own badge for each channel, and each badge has its own configuration menu. Open a badge menu by double-tapping on the badge.

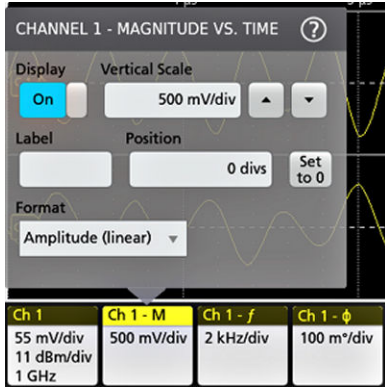

## Save and recall spectrum traces

You can save spectrum trace data to a file, and recall the trace to use as a reference trace or for other analysis purposes. Recalled spectrum traces are shown in the **Spectrum View** window.

### Save a spectrum trace

Use the **File > Save As** menu to save spectrum trace data to a specified location. See [Save a waveform or spectrum trace to a file](#) on page 172.

In the **Source** field, select the spectrum trace source channel and select the spectrum trace type from the expanded list. The **Source** list shows all available sources (**Analog**, **SV\_Normal**, **Normal**, **Max Hold**, and so on) that are enabled in the **Spectrum View** panel of the Channel badge.

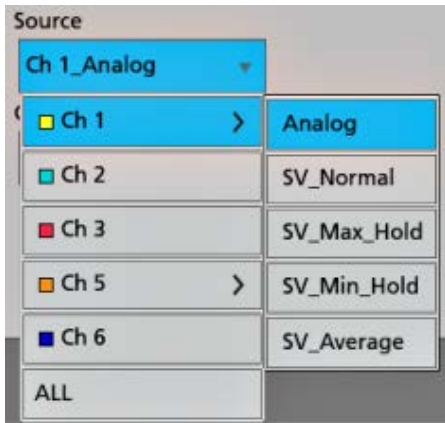

### Recall a spectrum trace

Use the **File > Recall** menu to navigate to and select a spectrum trace file to recall. See [Recall a reference waveform or spectrum trace](#) on page 175. Select the spectrum trace file to recall in the **Name** field.

Spectrum trace file names include the name of the source channel (rf1 = Ch1, rf2 = Ch2, and so on) and the spectrum trace type (normal, average, and so on). For example, the file name `SpreadSpectrum_022_rf5_average.wfm` indicates that the spectrum trace was from channel 5, and is an averaged spectrum trace.

# Setting waveform display parameters

Use waveform display controls to set the display mode, persistence, style, and intensity display parameters, and graticule style and intensity.

## Set waveform display mode (Stacked or Overlay)

Use this procedure to change the waveform display mode (Stacked or Overlay).

1. Double-tap on an open graticule area to open the Waveform View configuration menu.
2. Tap the **Display Mode** buttons to toggle between **Overlay** and **Stacked** modes.

In stacked display mode, each waveform is stacked vertically in separate graticule slices. This is the default display mode.

In overlay display mode, all waveforms are displayed in a single graticule (traditional waveform view).

## Set the Waveform Interpolation mode

Use this procedure to set the waveform interpolation mode, which sets how waveform data points are calculated between record data points.

1. Double-tap on an open graticule area to open the Waveform View configuration menu.
2. Tap the buttons under **Interpolation** to select either Sin(x)/x or Linear.

**Sin(x)/x** calculates record points along a curve between the actual acquired samples. This form of interpolation is useful when acquiring rounded waveforms such as sine waves. It is good for general-purpose uses but may introduce overshoot or undershoot in signals with fast rise times. This interpolation is also useful for looking at high-frequency signals, especially where the frequency components are just below the Nyquist frequency.

**Linear** calculates record points between actual acquired samples using a straight-line fit. This interpolation is useful for measuring waveforms with fast rise times, such as pulse trains.

## Set the waveform persistence, style, and intensity

Use the Waveform View configuration menu to set waveform persistence, style, and intensity.

1. Double-tap on an open graticule area to open the Waveform View menu.
2. Tap the **Persistence** field to select the persistence option.
  - a. **Off** disables display persistence.
  - b. **Auto** lets the oscilloscope automatically determine a persistence time for you.
  - c. **Infinite** persistence continuously accumulates record points until you change one of the acquisition display settings. Use infinite persistence for displaying unique signal anomalies, such as glitches.
  - d. **Variable** persistence accumulates record points for a specified time interval. Each record point decays independently according to the time interval. Use variable persistence for displaying infrequently appearing signal anomalies, such as glitches.
 

If you select Variable persistence, tap **Variable Persistence Time** and set the time using the multipurpose knob, or double-tap the field and use the virtual keypad to enter the time value.
3. Tap the Waveform Style buttons to set waveforms to draw as vectors (continuous lines) or dots.
  - **Vectors** displays the waveform with the waveform sample values connected using the selected interpolation method.
  - **Dots** displays the individual waveform sample values with no interpolation.

4. Tap the **Waveform Intensity** field and use the multipurpose knob to set the brightness of all waveforms.

## Set the graticule style and intensity

Use this procedure to set the graticule (display grid) style and intensity.

1. Double-tap on an open graticule area to open the Waveform View configuration menu.
2. Tap the **Graticule Style** field to select a graticule style from the list.
  - **Grid** provides a grid, cross hairs, and frame on the instrument display.
  - **Time** provides a vertical grid of time marks, cross hairs, and frame on the instrument display.
  - **Full** shows a frame and a grid on the instrument display. This style is useful for making quick, full-screen measurements with cursors and automatic readouts when cross hairs are not needed.
  - **None** provides a frame without a grid and cross hairs.
3. Tap the Graticule Intensity field and use the multipurpose knob to set the brightness of all graticules.



**Note:** Changing the graticule intensity also changes the intensity of vertical scale readouts and horizontal time readouts on the screen. Graticule intensity does not change the intensity of callout text on the screen.



# Mask testing waveforms

Mask testing determines how well your signals conform to expected signal quality and provides instant automated statistical analysis. A mask defines a portion of the instrument display that a signal must not enter. Mask testing is supported for analog channels, analog math waveforms, analog reference waveforms, and RF vs. Time waveforms.

## Create a Mask

Use the **More** button to create a new mask on the instrument display.

1. Double-tap the **More** button and select the **Mask** button on the **DRAW A BOX** menu window. This sets the DRAW A BOX function to Mask mode.

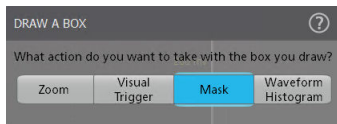

2. Tap outside the menu to close the **DRAW A BOX** menu. The Draw a Box icon is highlighted to show that it is in Mask draw mode.
3. Tap the Draw-A-Box **Zoom icon** at the up right of the **Results Bar** to draw a rectangle on the waveform screen for the first segment to define. The segment created is associated with the channel to which it was added (in Stacked mode) or the active channel (in Overlay mode).
4. Continue drawing rectangles to add other mask segments:
  - a. If in Stacked mode, you can draw mask segments in different waveform slices.
  - b. If in Overlay mode, select a channel before creating segments for that channel.
5. When you are done drawing the mask segments, tap anywhere to end the segment draw function.
6. To draw segments again, tap the Draw A Box **zoom** icon again.
7. To change the shape of a segment, see and [Edit visual trigger areas using the Area menu](#) on page 132.

## Edit mask segments on the screen

Use the touchscreen or a mouse to directly edit a segment, including moving, changing size, duplicating a segment, moving individual vertices, adding and deleting vertices, and rotating the segment.

1. To move a mask segment, touch and drag the segment to a new position.



**Note:** You cannot drag a mask segment from one waveform slice to another while in Stacked display mode.

2. To delete a mask segment:
  - a. Touch and Hold or right-click on the segment to delete.
  - b. Select **Delete Segment** from the menu.

3. To resize a mask segment:

- a. Single-tap a segment to enable resize segment mode. Resize mode draws resize points on all four sides and the corners of a boundary area that contains the segment.



- b. Touch and drag a top, bottom, left, or right resize point to resize the segment vertically or horizontally.
- c. Touch and drag a corner resize point to resize both the length and height of the segment in the dragged direction.



**Note:** You cannot move a segment while in resize mode.

- d. To exit resize mode, tap outside the mask segment. The instrument returns to normal operation.

4. To add vertices to or delete vertices from a mask segment:

- a. Tap a segment twice to enable add/delete vertex mode. Add/delete mode draws a crosshair at each existing vertex, and a plus symbol midway between each existing vertex.

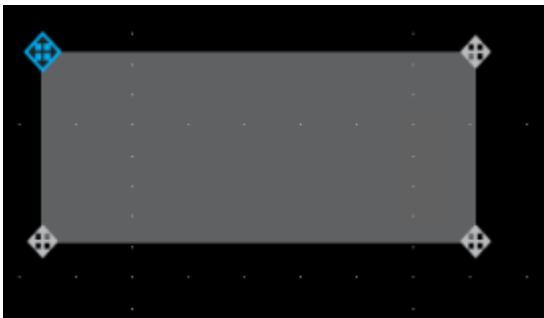

**Note:** A triangular segment does not draw the existing vertices with crosshairs, as they cannot be deleted; only the midway plus symbols are shown to let you add vertices to a triangle.

- b. Tap a vertex crosshair to delete that vertex.
- c. Tap a plus symbol to add a new vertex at that location. The segment is redrawn to show the new vertex. You can continue to add vertices; there is no limit to the number of vertices in a segment.



**Note:** You cannot move vertices while in add/delete vertex mode.

- d. To exit add/remove vertex mode, tap outside the mask segment. The instrument returns to normal operation.

5. To move vertices in a mask segment:

- a. Tap the segment three times to enable move vertex mode. The move vertex mode draws crosshairs on all vertices of the segment.

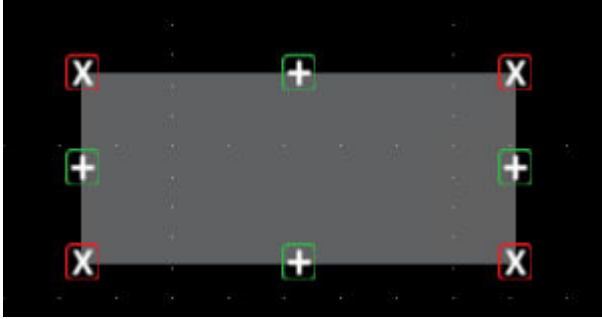

- b. Touch and drag a vertex to move it to a new position.
  - c. To exit move vertex mode, tap outside the mask segment. The instrument returns to normal operation.
6. To rotate a mask segment:
- a. Tap four times in the segment to enable rotate segment mode.



- b. Touch and drag the dot in the segment to rotate it.



**Note:** Once you are touching and dragging the rotate dot, you can move your finger outside of the segment to get finer control over the rotation increments.

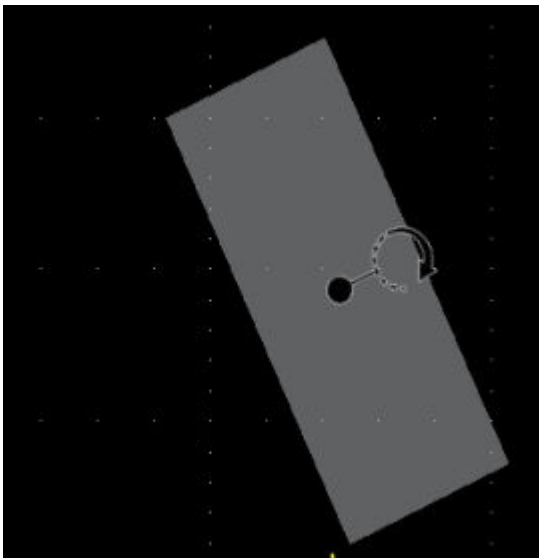

- c. To exit rotate segment mode, tap outside the mask segment. The instrument returns to normal operation.

## Edit mask segments using the Mask Definition menu

The Mask Definition menu allows you to edit the mask, including moving, changing size, moving individual vertices, adding and deleting vertices, and rotating the segment. You have the choice to edit a mask by segments or waveform tolerance with the **Mask Defined By** options in the Mask Settings panel.

See [Mask Definition configuration menu](#) on page 454

See [Edit mask segments on the screen](#) on page 157 for information on graphically editing a segment on the screen.



**CAUTION:** Do not toggle between the **Mask Defined By** options without saving your mask settings. When **Waveform Tolerances** is selected, a mask generated by the **Segment** settings are replaced with a mask generated by the tolerance fields.

See for more information on the mask settings.

1. To change the shape of a segment using the Mask Settings menu:
  - a. Double-tap on the segment to edit.
  - b. Select **Segments** under the **Mask Defined By** options.
  - c. Tap the **Shape** field.
  - d. Select the shape to which to change the segment. The segment changes shape immediately.
2. To change the height of a segment using the Mask Settings menu:
  - a. Double-tap on the segment to edit.
  - b. Select **Segments** under the **Mask Defined By** options.
  - c. Tap the **Height** field and enter the height value as units of the current vertical channel settings (volts, amps, and so on). Or double-tap on the field and use the **A** knob to change the value. The shape immediately changes height while maintaining the vertical center position of the segment.
3. To change the vertical center of a segment using the Mask Settings menu:
  - a. Double-tap on the segment to edit.
  - b. Select **Segments** under the **Mask Defined By** options.
  - c. Tap the **Vertical Center** field and enter the height value as units of the current vertical channel settings (volts, amps, and so on). Or double-tap on the field and use the **A** knob to change the value. The shape immediately changes the vertical center position of the segment.
4. To change the width of a segment using the Mask Settings menu:
  - a. Double-tap on the segment to edit.
  - b. Select **Segments** under the **Mask Defined By** options.
  - c. Tap the **Width** field and enter the width value as horizontal time (seconds). Or double-tap on the field and use the **A** knob to change the value. The shape immediately changes width while maintaining the horizontal center position of the segment.
5. To change the horizontal center of a segment using the Mask Settings menu:
  - a. Double-tap on the segment to edit.
  - b. Select **Segments** under the **Mask Defined By** options.
  - c. Tap the **Horizontal Center** field and enter the new horizontal center position value. Or double-tap on the field and use the **A** knob to change the value. The shape immediately changes the horizontal center position.
6. To flip a segment vertically using the Mask Settings menu:
  - a. Double-tap on the segment to edit.
  - b. Select **Segments** under the **Mask Defined By** options.
  - c. Tap the **Flip Vertical** button. The segment immediately flips vertically around its center position.
7. To flip a segment horizontally using the Mask Settings menu:

- a. Double-tap on the segment to edit.
  - b. Select **Segments** under the **Mask Defined By** options.
  - c. Tap the **Flip Horizontal** button. The segment immediately flips horizontally around its center position.
8. To rotate a segment using the Mask Settings menu:
  - a. Double-tap on the segment to edit.
  - b. Select **Segments** under the **Mask Defined By** options.
  - c. Tap the **Rotate** field and use the **A** knob to change the value. The segment immediately rotates when you enter a value or change the value with the **A** knob. Or double-tap on the field and enter the number of degrees to rotate the segment, where zero (0) degrees is the position when the segment was created. You can rotate a segment from 0° to 360°.
9. To add a point (vertex) to a segment using the Edit Vertices menu:
  - a. Double-tap on the segment to edit.
  - b. Select **Segments** under the **Mask Defined By** options.
  - c. Tap the **Edit Vertices** panel.
  - d. Select the vertex in the **Define Area** list counter-clockwise from you want to insert a new vertex. Selecting a vertex highlights that vertex on the segment.
  - e. Tap **Insert Point**. A new vertex is added to the segment, marked with an X, and is highlighted in the list.
  - f. Continue adding vertices as needed.
10. To delete a point (vertex) from a segment using the Edit Vertices menu:
  - a. Double-tap on the segment to edit.
  - b. Select **Segments** under the **Mask Defined By** options.
  - c. Tap the **Edit Vertices** panel.
  - d. Select the vertex in the **Define Area** list that you want to delete. Selecting a vertex highlights that vertex on the segment.
  - e. Tap **Delete Point**. A new vertex is added to the segment, marked with an X, and is highlighted in the list.
  - f. Continue deleting vertices as needed.
11. To move individual vertices in a segment using the Edit Vertices menu:
  - a. Double-tap on the segment to edit.
  - b. Select **Segments** under the **Mask Defined By** options.
  - c. Tap the **Edit Vertices** panel.
  - d. Select the vertex in the **Define Area** list that you want to move. Selecting a vertex highlights that vertex on the segment.
  - e. Tap the X (time) axis or Y (Ampl.) field in the list and use the **A** and **B** knobs to change the position values. Or double-tap on each field and enter the new positional values for that vertex.
12. To reset the shape using the Edit Vertices menu:
  - a. Double-tap on the segment to edit.
  - b. Select **Segments** under the **Mask Defined By** options.
  - c. Tap the **Edit Vertices** panel.
  - d. Tap **Reset Points**. The shape changes to a triangle centered in the display or slice.
13. To save the segment edits:
  - a. Tap the **Save** panel.
  - b. Tap **Save Mask**. Only edits to the segment settings are saved.
  - c. Tap outside the menu to exit.
14. To change the vertical tolerance of a segment using the Mask Settings menu:
  - a. Double-tap on the segment to edit.



# Waveform histogram

Histograms visually shows the distribution of how many sample points fall in selected section of waveform record. Waveform Histogram provides you tool to statistically analyze the waveforms using histograms in the graticule. This helps you to quickly determine how your device is responding to the inputs at discrete intervals of time and make the right decisions to change the device parameters.

## Create a waveform histogram

Use the More button to create a waveform histogram on the instrument display.

1. Tap the **More** button and select the **Waveform Histogram** button in the **DRAW A BOX** menu window. This sets the DRAW A BOX function to Waveform Histogram mode.

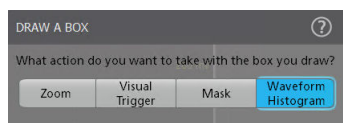

2. Tap outside the menu to close the **DRAW A BOX** menu. The DRAW A BOX icon is highlighted to show waveform histogram draw mode is active.
3. Draw a rectangle on the waveform screen. The rectangle created is associated with the channel to which it was added (Stacked mode) or the active channel (Overlay mode).
4. Double-tap the **DRAW A BOX** button to add multiple histograms in the areas of interest of waveform record.
5. Continue drawing histograms on different waveforms:
  - a. In Stacked mode, you can draw histograms in different waveform slices.
  - b. In Overlay mode, select a channel before creating histograms for that channel.
6. When you are done drawing the histogram, tap anywhere to end the histogram draw function.
7. To draw a new histogram box again, tap the **DRAW A BOX** button again.

## Edit histogram on the screen

Use the touchscreen or a mouse to directly edit a histogram, including moving, changing size, duplicating a histogram.

1. To move a histogram, drag the histogram box to a new position.



**Note:** You cannot drag a waveform histogram from one waveform slice to another while in Stacked display mode.

2. To delete a histogram:
  - Touch and hold or right-click on the histogram and select **Delete Histogram** or **Delete All Histograms** from the menu.
  - Touch and hold or right-click on the histogram badge and select **Delete Histogram** or **Delete All Histograms** from the menu.
  - Select the histogram badge and press the Delete key on the keyboard.
3. To resize a histogram:
  - a. Single-tap a histogram to enable resize histogram mode. Resize mode draws resize points on all four sides and the corners of a boundary area that contains the histogram.

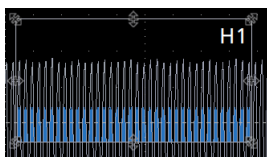

- b. Touch and drag a top, bottom, left, or right resize point to resize the histogram vertically or horizontally.
- c. Touch and drag a corner resize point to resize length and height of the histogram in a direction.



**Note:** You cannot move a histogram while in resize mode.

## Waveform Histogram guidelines

- The waveform histogram is based on a single source.
- You can draw unlimited histograms per source waveform.
- The waveform histogram are supported on analog channels, analog math waveforms, analog reference waveforms, and RF vs. Time waveforms.
- The waveform histograms are compatible with FastAcq, it only update with the intermittent waveforms that are sent to host for analysis processing as opposed to being updated with every waveform acquired by FastAcq.
- The waveform histograms are compatible with Fast Frame, it shows accumulated view across all frames.
- The waveform histograms are compatible with History acquisitions, it shows accumulated view across all acquisitions.
- The waveform histograms are compatible with roll mode.
- The waveform histogram are not supported on Digital channels, Bus waveforms, Time-trend waveforms, and Math FFTs.
- A single waveform histogram can be either vertical or horizontal, but not both.
- Measurement Results Table includes result from histogram measurements that appear in the one or more histogram results badges.

To add measurement results table for waveform histogram, see [Add Results Table configuration menu](#) on page 337



# Zoom in on waveforms

Use the zoom tools to magnify waveforms to view signal details.

## Turn on Zoom mode

Zoom mode lets you look at a portion of your waveform in greater detail. Enable Zoom mode and touch and drag on-screen to select the area to zoom.

To enable Zoom mode, use one of the following methods:

1. Double-tap the **More** button and select the **Zoom** button on the **DRAW A BOX** menu window. This sets the Draw-a-Box function to Zoom mode.

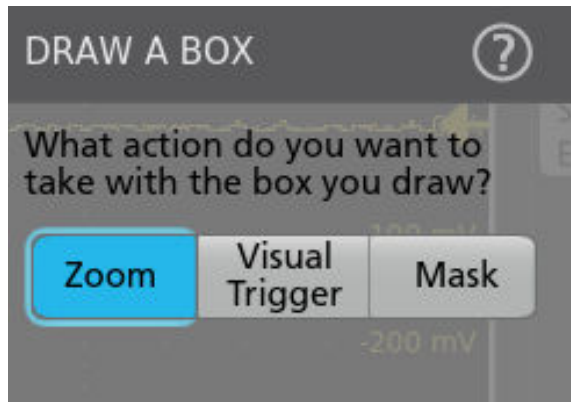

Tap the Draw-A-Box **Zoom icon** button at the up right of the **Results Bar**, then touch and drag in the Waveform view to draw a box on the area of interest. The Zoom mode stays enabled so that you can draw boxes to zoom in different areas of the Zoom Overview, or draw boxes to further zoom in on the same area.

2. Push the front-panel **Zoom** button.

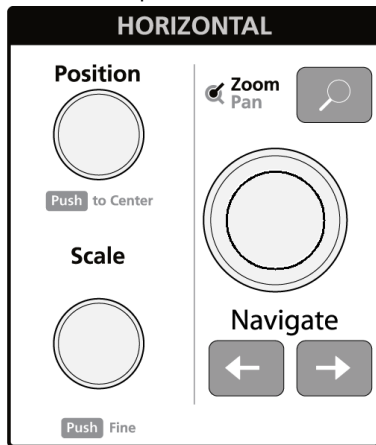

3514-014

3. Tap the Zoom icon in the corner of Waveform and Plot views.

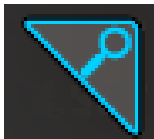

4. Zoom overview:

- a. To use Zoom once enabled, tap the zoom icon touch and draw a box around an area of interest in the Waveform or Plot view to immediately display the zoomed waveform and the Zoom Overview window.
  - b. You can draw boxes in the Waveform view, most plots, and the Zoom Overview area.
  - c. The **Zoom** mode stays enabled so that you can draw boxes to zoom in different areas of the Zoom Overview, or draw boxes to further zoom in on the same area.
  - d. Single-tapping anywhere disables the zoom box draw mode.
  - e. To exit the zoom display mode, tap the Zoom icon in the corner of Waveform and Plot views, or push the front-panel **Zoom** button.
5. For more information on zoom:
- [Zoom user interface](#) on page 67
  - [Zoom mode and Searches](#) on page 166
  - [Using Wave Inspector front-panel controls for zoom](#) on page 166

## Using Wave Inspector front-panel controls for zoom

Use the Wave Inspector controls to increase or decrease the area of the zoom box and to control the part of the waveform shown in the main Zoom view.

1. Push the front-panel **Zoom** button to open Zoom mode. Push the Zoom button again to exit zoom mode.
2. Turn the **Zoom** knob (center knob) to increase or decrease the horizontal area of the zoom box in the Zoom Waveform Overview, which in turn controls the amount of the waveforms shown in the main Zoom view.
3. Turn the **Pan** knob (outer knob) to move the Zoom box left or right in the Zoom Waveform Overview, which in turn controls the part of the waveform shown in the main Zoom view.
4. For information on the Zoom interface, see [Zoom user interface](#) on page 67.

## Zoom mode and Searches

Use Zoom and Searches to find events of interest on a waveform.

Searches provide a way to mark a waveform event or events for reference. You can set marks automatically with search criteria such as particular edges, pulse widths, runts, logic states, rise/fall times, setup and hold, and bus data types.

When in Zoom mode, you can use the front-panel left and right arrow buttons to position the waveform in the Zoom Overview and Zoom View window to the previous or next search mark on the waveform. Push and hold a front-panel navigation button to continuously step to and show the next search mark.

You can also tap a Search badge and use its navigation buttons to position the waveform to previous or next search marks.

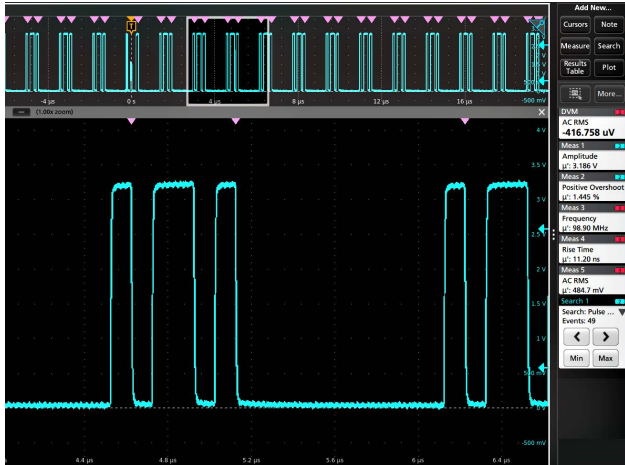

### Search tables and Zoom mode

- When you select a row in the Search Results Table, Zoom mode adjusts the position of the zoom window to place the selected search event in the middle of the zoom window.
- If zoom was not already on, it is turned on with its previous zoom factor and the zoom window position adjusted to show the selected search event.
- When a Search Results Table is selected, Multipurpose knob **A** is assigned to the index column. Use knob **A** to scroll through the table and display the selected event in the zoom window.
- If you pan (move horizontally) the zoom window by dragging it, or by using the front panel **Pan** control, the search table highlights which (if any) search result is at the center of the zoom window.

For information on creating a Search, see [Add a Search](#) on page 107.

# Measurement configuration

After adding a measurement, you can customize the measurement for more precise results.

To customize measurements, double-tap a Measurement badge in the Results bar to open the [measurement configuration menu](#).

## Label a measurement

Use this procedure to add a custom label to a measurement.

Measurement labels appear on the Measurement badge and can be added to Results tables.

Labels are set in the Measurement panel of the Measurements configuration menu. See [Measurement configuration menu overview](#) on page 210.

**Prerequisite:** To set measurement reference levels you must be taking a measurement. See [Add a measurement](#) on page 95.

1. Double-tap a **Measurement** badge in the Results bar to open the [Measurement configuration menu](#).
2. Tap the **Configure** panel.
3. Use one of the following methods to enter label text:
  - Tap the **Label** field and enter the label text using a keyboard and press the keyboard Enter key to add the label text to the Measurement badge.
  - Double-tap the **Label** field and enter the label text using the virtual keyboard, then tap the **Enter** button to add the label text to the Measurement badge. Tap outside the virtual keyboard to close it.



**Note:** The new label text replaces the default measurement name on the Measurement badge that shows the measurement type (Frequency, Peak-to-Peak, and so on). To view the measurement type for a relabeled measurement, double-tap the Measurement badge and look at the topmost panel name, which has the measurement name.

Custom measurement labels can be added to a Results table.

4. Tap anywhere outside the Measurement menu to close it.

## Set measurement reference levels

Use this procedure to set measurement reference levels.

Reference levels are set in the Reference Levels panel of the Measurements configuration menu. See [Measurement configuration menu overview](#) on page 210.

**Prerequisite:** To set measurement reference levels you must be taking a measurement. See [Add a measurement](#) on page 95.

### Procedure

1. Double-tap a Measurement badge. The Measurement configuration menu is displayed.
2. Tap the **Reference Levels** panel.
3. Select either Global (default) or Local:
  - **Global** causes changes in this panel to be updated in all other measurements that also have Global selected in this panel.When switching from Global to Local:
  - If a specific measurement has not been set to Local before then no changes are made to any of the values. You can update the parameters.
  - If a specific measurement has been set to Local before, then changed back to Global and then again switched to Local, the last used Local values are shown.

- **Local** causes changes in this panel to only effect this measurement. When switching from Local to Global, all fields will update to the current Global parameters.
4. Tap **Set Levels In** and select either **%** or **Absolute**.
    - **%** sets the High, Mid, and Low reference levels as percentages of the calculated Top and Base signal levels. Tap the Levels **10% - 90%**, **20% - 80%**, or **Custom** button to select the type of percent value to set.
      - **10% - 90%** sets the Low, Mid and High Ref values to 10%, 50% and 90% respectively for both rising and falling edges.
      - **20% - 80%** sets the Low, Mid and High Ref values to 20%, 50% and 80% respectively for both rising and falling edges.
      - **Custom** opens the Rising and Falling Edge numeric entry fields to set High, Mid and Low Ref levels to different values for the rising and falling edges of a waveform. Tap the Rising Edge and Falling Edge **High**, **Mid**, or **Low** fields and set the level using the assigned multipurpose knob. Or double-tap the field and use the virtual keypad to enter a value.
    - **Absolute** sets the High, Mid, and Low reference levels to specific signal levels. Tap the Levels **Same** or **Unique** buttons to select the type of absolute value to set.
      - **Same** sets the High, Mid, and Low reference for both rising and falling edges of a signal to the specified values. Tap the Threshold **High**, **Mid**, or **Low** field and set the threshold using a multipurpose knob. Or double-tap the field and use the virtual keypad to enter a value.
      - **Unique** opens the Rising and Falling Edge numeric entry fields to set High, Mid and Low Ref levels to different values for the rising and falling edges of a waveform. Tap the Rising Edge and Falling Edge **High**, **Mid**, or **Low** fields and set the level using the assigned multipurpose knob. Or double-tap the field and use the virtual keypad to enter a value.
  5. Tap the **Base Top Method** drop down tab and select the method from the list. This setting is only available when using the % level setting.
  6. Touch **Hysteresis** and use the assigned multipurpose knob to set the value.
  7. Tap anywhere outside the Measurement configuration menu to close it.

## Set measurement gates

Use this procedure to specify which portion of your waveform is used to take measurements.

**Gating** is set in the **Gating** panel of the **Measurements** configuration menu. See [Measurement configuration menu overview](#) on page 210.

To set measurement gates you must be taking a measurement. See [Add a measurement](#) on page 95.

### Procedure

1. Double-tap a measurement badge to open the Measurement configuration menu.
2. Tap the **Gating** panel.
3. Tap **Gating** and select either **Global** or **Local** gating:
  - **Global** causes changes in this panel to be updated in all other measurements that also have Global selected in this panel.  
When switching from Global to Local:
    - If a specific measurement has not been set to Local before then no changes are made to any of the values. You can update the parameters.
    - If a specific measurement has been set to Local before, then changed back to Global and then again switched to Local, the last used Local values are shown.
  - **Local** causes changes in this panel to only effect this measurement. When switching from Local to Global, all fields will update to the current Global parameters.
4. Tap the **Gating Type** drop down tab and select the gating type from the list:
  - **None** takes measurement across the entire waveform record.

- **Screen** takes measurements on that portion of the waveform shown in the display. When Zoom is on, the display is the zoom window.
  - **Cursors** takes measurements on that portion of the waveform between the cursors. Selecting Cursors opens cursors on the measurement source. Set the cursors so that the waveform area of interest is between the cursors.
  - **Logic** takes measurements only when the logical state of a specified waveform is true. If Logic gating is selected, continue with the following steps.
  - **Search** takes measurements between the start and stop times defined by a specified search. Search gating is only valid for optional DDR3 measurements on a 6 Series MSO instrument.
  - **Time** takes measurements between the times specified in the **Start Gate Time** and **End Gate Time** fields, relative to the trigger point.
5. For the Logic and Search gates, tap the **Source** field and select the source from the list.
  6. For the Logic gate, tap the **Threshold** field and use the assigned multipurpose knob to set the desired threshold dividing a logic Low or High state.
  7. For the Logic gate, tap the **Hysteresis** field and use the assigned multipurpose knob to set the desired hysteresis.
  8. For the Logic gate, tap **Active** and select either the High or Low active state. High sets the gating to take measurements when the specified waveform is an active High. Low sets the gating to take measurements when the specified waveform is an active Low logic state.
  9. Tap anywhere outside the Measurement configuration menu to close it.
  10. Tap on a gating-enabled measurement badge to display the vertical gate bars on the waveform for that measurement.
  11. To return measurement gating to its default value, open the **Gating** panel and select a gating type of **None**.

## Set measurement filters

Use this procedure to set measurement filters.

Filters are set in the Filter/Limit Results panel of the Measurements configuration menu. See [Measurement configuration menu overview](#) on page 210.

To set measurement filters you must be taking a measurement. See [Add a measurement](#) on page 95.

### Procedure

1. Double-tap a Measurement badge in the Results bar to open the Measurement configuration menu.
2. Tap the **Filter/Limit Results** panel.
3. Select either Global or Local.
  - **Global** causes changes in this panel to be updated in all other measurements that also have Global selected in this panel.

When switching from Global to Local:

  - If a specific measurement has not been set to Local before then no changes are made to any of the values. You can update the parameters.
  - If a specific measurement has been set to Local before, then changed back to Global and then again switched to Local, the last used Local values are shown.
  - **Local** causes changes in this panel to only effect this measurement. When switching from Local to Global, all fields will update to the current Global parameters.
4. Tap the **High Pass Filter** field and select the type of filter from the drop down list.
 

If you select a filter other than None, tap the **HPF Freq (F1)** field and set the frequency using the assigned multipurpose knob. Or double-tap the field and use the virtual keypad to enter a value.
5. Tap the **Low Pass Filter** field and select the type of filter from the drop down list.

If you select a filter other than None, tap the **LPF Freq (F2)** field and set the frequency using the assigned multipurpose knob. Or double-tap the field and use the virtual keypad to enter a value.

6. Tap anywhere outside the Measurement configuration menu to close it.

## Set measurement limits

Use this procedure to set measurement limits. Measurement limits let you set boundaries to eliminate nonrelevant values from a measurement.

Measurement limits are set in the Filter/Limit Results panel of the Measurements configuration menu. See [Measurement configuration menu overview](#) on page 210.

To set measurement limits you must be taking a measurement. See [Add Measurements configuration menu overview](#) on page 188.

1. Double-tap a Measurement badge in the Results bar to open the Measurements configuration menu.
2. Tap the **Filters/Limit Results** panel.
3. Tap **Limit Measurement Results** to let you restrict displayed measurements to only those that are within a specified range.
  - Tap the **Min Value** field and set the minimum acceptable measurement value using the assigned multipurpose knob. Or double-tap the field and use the virtual keypad to enter a value.
  - Tap **Max Value** and set the maximum acceptable measurement value using the assigned multipurpose knob. Or double-tap the field and use the virtual keypad to enter a value.
4. Tap **Limit Measurement Population** to let you set the number of measurement acquisitions (population) to acquire before stopping acquisitions for this measurement.

Tap the **Limit** field and set the population limit using the assigned multipurpose knob. Or double-tap the field and use the virtual keypad to enter a value.



**Note:** If Limit Measurement Results and Limit Measurement Population are both On, the values in the Measurement badge are for the number of measurement acquisitions set in the population Limit field that were within the Limit Measurement Results settings.

5. Tap anywhere outside the Measurement configuration menu to close it.

## Saving and recalling information

Use these procedures to save or recall waveforms, setups, or sessions.

### Save a screen image

Use this procedure to save a screen image.

1. Tap the **File** menu and select **Save As**.

The Save As configuration menu opens.

2. Tap **Screen Capture** to open the Screen Capture tab.
3. Tap **Save Location** or **Browse** to select the location to save the file.
  - a. Tap the drop down arrow in the **Save Location** field and select the location to save the file from a list of recent save locations. Or double-tap the field and use the virtual keyboard to enter a path to the save location.
  - b. Tap **Browse** to open the *Browse Save As Location* configuration menu to navigate to and select a location at which to save the file.
4. **File Name** shows the name last used to save a file. The default name is Tek000. To change the file name, double-tap the file name and enter a new file name using the virtual keyboard.
5. Tap **Auto Increment File Name** to enable or disable automatic incrementing of a file name. Auto Increment File Name lets you save sequential files without needing to manually rename them each time. The count number is added to the end of the file name.
  - If Auto Increment File Name is enabled the **Count** defaults to 000 if there are no files at the specified location and file name that already use incremented file names. If there are files at the save location that already use the specified file name, and have already been saved using count increments, the Count field shows the next count value that will be added to the file name when the file is saved.
  - To change the starting count value, tap the Count field and use the assigned knob to change the value, or double-tap the field and use the virtual keypad to change the value.
6. Tap **Save As Type** and select the desired graphic image file type from the list.
7. Tap **Save** to save the screen image to the specified file name, location, and type.



**Note:** Once you have saved a file using the Save As configuration menu, you can push the front-panel **User** button to immediately save the same type file again, without opening any menus.

### Save a waveform or spectrum trace to a file

Use this procedure to save channel waveform (analog or digital) data to a comma-separated values (csv) or Tektronix waveform data (wfm) file, for later analysis or inclusion in reports. You can also save Spectrum View traces to files.

1. Tap the **File** menu and select **Save As**.

The Save As configuration menu opens.

2. Tap **Waveform** to open the Waveform tab.
3. Tap **Save Location** or **Browse** to select the location to save the file.
  - a. Tap the **Save Location** drop down arrow and select the location to save the file from a list of recent save locations. Or double-tap the field and use the virtual keyboard to enter a path to the save location.
  - b. Tap **Browse** to open the *Browse Save As Location* configuration menu to navigate to and select a location at which to save the file.
4. **File Name** shows the name last used to save a file. The default name is Tek000. To change the file name, double-tap the file name and enter a new file name using the virtual keyboard.
5. Tap **Auto Increment File Name** to enable or disable automatic incrementing of a file name. Auto Increment File Name lets you save sequential files without needing to manually rename them each time. The count number is added to the end of the file name.



- If Auto Increment File Name is enabled the **Count** defaults to 000 if there are no files at the specified location and file name that already use incremented file names. If there are files at the save location that already use the specified file name, and have already been saved using count increments, the Count field shows the next count value that will be added to the file name when the file is saved.
  - To change the starting count value, tap the Count field and use the assigned knob to change the value, or double-tap the field and use the virtual keypad to change the value.
6. Tap **Save As Type** and select the desired waveform data type from the list.
  7. Tap **Source** and select the source of the waveform to save from the list. You can save a single waveform or all waveforms.

The **Source** menu shows a right arrow in the source list if a source has more than one waveform available to save, such as an analog channel and its corresponding spectrum trace(s). Tap the source menu item to expand that item to show available waveform sources.

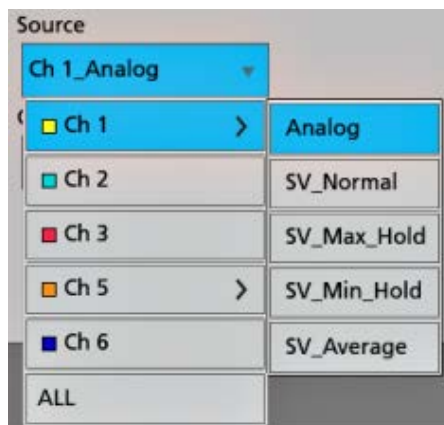

8. Tap **Save** to save the waveform to the specified file name, location, and type.



**Note:** Once you have saved a file using the **Save As** configuration menu, you can push the front-panel User button to immediately save the same type file again, without opening any menus.

## Save instrument settings to a file

Use this procedure to save instrument settings to a Tektronix setup (.set) file.

1. Tap the **File** menu and select **Save As**.  
The Save As configuration menu opens.
2. Tap **Setup** to open the Setup tab.
3. Tap **Save Location** or **Browse** to select the location to save the file.
  - a. Tap the **Save Location** drop down arrow and select the location to save the file from a list of recent save locations. Or double-tap the field and use the virtual keyboard to enter a path to the save location.
  - b. Tap **Browse** to open the *Browse Save As Location* configuration menu to navigate to and select a location at which to save the file.
4. **File Name** shows the name last used to save a file. The default name is Tek000. To change the file name, double-tap the file name and enter a new file name using the virtual keyboard.
5. Tap **Auto Increment File Name** to enable or disable automatic incrementing of a file name. Auto Increment File Name lets you save sequential files without needing to manually rename them each time. The count number is added to the end of the file name.
  - If Auto Increment File Name is enabled the **Count** defaults to 000 if there are no files at the specified location and file name that already use incremented file names. If there are files at the save location that already use the specified file name, and have already been saved using count increments, the Count field shows the next count value that will be added to the file name when the file is saved.

- To change the starting count value, tap the Count field and use the assigned knob to change the value, or double-tap the field and use the virtual keypad to change the value.
6. Enable **Include Reference Waveforms** to include waveform files for all active waveforms in the setup file.
  7. Tap **Save** to save the setup information to the specified file name and location.



**Note:** Once you have saved a file using the Save As configuration menu, you can push the front-panel **User** button to immediately save the same type file again, without opening any menus.

## Save reports

Use this procedure to save reports.

1. Tap the **File** menu and select **Save As**.  
The Save As configuration menu opens.
2. Tap **Report** to open the Report tab.
3. Tap **Save Location** or **Browse** to select the location to save the file.
  - a. Tap the **Save Location** drop down arrow and select the location to save the file from a list of recent save locations. Or double-tap the field and use the virtual keyboard to enter a path to the save location.
  - b. Tap **Browse** to open the [Browse Save As Location](#) configuration menu to navigate to and select a location at which to save the file.
4. **File Name** shows the name last used to save a file. The default name is Tek000. To change the file name, double-tap the file name and enter a new file name using the virtual keyboard.
5. Tap **Auto Increment File Name** to enable or disable automatic incrementing of a file name. Auto Increment File Name lets you save sequential files without needing to manually rename them each time. The count number is added to the end of the file name.
  - If Auto Increment File Name is enabled the **Count** defaults to 000 if there are no files at the specified location and file name that already use incremented file names. If there are files at the save location that already use the specified file name, and have already been saved using count increments, the Count field shows the next count value that will be added to the file name when the file is saved.
  - To change the starting count value, tap the Count field and use the assigned knob to change the value, or double-tap the field and use the virtual keypad to change the value.
6. Tap **Save As Type** and select the report file format from the list.
7. Tap **Append Report** to enable appending this report to a previous report that uses the same file name.
8. Double-tap **Comments** and use the virtual keyboard to add descriptive comments to the report.
9. Tap **Include Images and Annotations** to include screen images and annotations in the report.
10. Tap **Include Setup Configuration** to include the instrument settings data in the report.
11. Tap **Save** to save the report file to the specified file name, location, and type.



**Note:** Once you have saved a file using the Save As configuration menu, you can push the front-panel **User** button to immediately save the same type file again, without opening any menus.

## Save sessions

Use this procedure to save a session file. A session file contains instrument setup information, measurements, reference waveforms of active signals, plots, and eye diagram masks if enabled.

1. Tap the **File** menu and select **Save As**.  
The Save As configuration menu opens.

2. Tap **Session** to open the Session tab.
3. Tap **Save Location** or **Browse** to select the location to save the file.
  - a. Tap the **Save Location** drop down arrow and select the location to save the file from a list of recent save locations. Or double-tap the field and use the virtual keyboard to enter a path to the save location.
  - b. Tap **Browse** to open the *Browse Save As Location* configuration menu to navigate to and select a location at which to save the file.
4. **File Name** shows the name last used to save a file. The default name is Tek000. To change the file name, double-tap the file name and enter a new file name using the virtual keyboard.
5. Tap **Auto Increment File Name** to enable or disable automatic incrementing of a file name. Auto Increment File Name lets you save sequential files without needing to manually rename them each time. The count number is added to the end of the file name.
  - If Auto Increment File Name is enabled the **Count** defaults to 000 if there are no files at the specified location and file name that already use incremented file names. If there are files at the save location that already use the specified file name, and have already been saved using count increments, the Count field shows the next count value that will be added to the file name when the file is saved.
  - To change the starting count value, tap the Count field and use the assigned knob to change the value, or double-tap the field and use the virtual keypad to change the value.
6. Tap **Save** to save the session data to the specified file name, location, and type.



**Note:** Once you have saved a file using the Save As configuration menu, you can push the front-panel **User** button to immediately save the same type file again, without opening any menus.

## Recall a reference waveform or spectrum trace

Use this procedure to recall (load) and display a saved waveform or spectrum trace as a Reference waveform. There is no set limit to the number of reference waveforms that you can load and display.

1. Tap the **Math Ref Bus >Add New Ref** button on the Settings bar.
 

The *Recall configuration menu* opens to the last location used to recall a waveform or spectrum trace file. If the location is not available, the menu defaults to the instrument C drive.
2. Tap **Files of Type:** and select the file type from the list.
 

The files list updates to show all files that match the selected file type.
3. Tap the file name in the list to add the file to the **File Name** field.
4. Tap **Open** to exit the menu and add the reference waveform to the screen.
5. If the file location shown in the **Look In** field does not contain the file to recall, navigate to the folder that contains the file to recall, using one of the following methods:
  - To recall files from recently accessed file locations, tap the drop down arrow in the **Look in** field and select from the list of recently accessed locations.
  - Tap in the **Drive** column and use the displayed contents to navigate to locations on the internal storage location C, a connected USB drive (E -K), or a network-connected drive.
  - Double-tap the **Look in** field and use the virtual keyboard to manually enter a path to the file location (folder).

As you navigate the folders, the files list area shows all files that match the file type selected in the Files of Type field.

6. Select the file to recall, using one of the following methods:
  - If the file was recently recalled, tap the drop down arrow in the **File Name:** field and select from a drop-down list of recently recalled files.
  - Select a file name in the main files list. The file **Name** field updates to show the selected file name.



**Note:** You can double-tap on a file name to immediately recall the file and close the menu.

## 7. Tap **Recall**.

The reference waveform is loaded and displayed, and a **Ref** badge is added to the Settings bar. If you recalled a spectrum trace waveform, that waveform is shown in the **Spectrum View** window, with the handle name of R1, R2, and so on.

## Recall a Setup file

Use this procedure to recall (load) and configure instrument settings from a Setup file.

1. Select **File > Recall** from the Menu bar to open the *Recall configuration* menu.
2. Tap **Setup** to open the Setup tab.

The Recall configuration menu opens to show the settings last used to recall a setup file.

3. Tap **Files of Type:** and select the file type from the list.

The files list updates to show any files that match the selected file type.

4. Navigate to the folder that contains the file to recall, using one of the following methods:

- To recall files from recently accessed file locations, tap the drop down arrow in the **Look in** field and select from the list of recently accessed locations.
- Tap in the **Drive** column and use the displayed contents to navigate to locations on the internal storage location C, or on a connected USB drive (E -K).
- Double-tap the **Look in** field and use the virtual keyboard to manually enter a path to the file location (folder).

As you navigate the folders, the files list area shows all files that match the file type selected in the Files of Type field.

5. Select the file to recall, using one of the following methods:

- If the file was recently recalled, tap the drop down arrow in the **File Name:** field and select from a drop-down list of recently recalled files.
- Select a file name in the main files list. The File Name field updates to show the selected file name.



**Note:** You can double-tap on a file name to immediately recall the file and close the menu.

6. Tap **Recall**.

The instrument loads the setup file and reconfigures the oscilloscope to the setup file settings.

## Recall a Session file

Use this procedure to recall (load) instrument settings and associated waveforms (as Reference waveforms) from a Session file.

1. Select **File > Recall** from the Menu bar to open the *Recall configuration* menu.
2. Tap **Session** to open the Session tab.

The Recall configuration menu opens to show the settings last used to recall a session file.

3. Tap **Files of Type:** and select the file type from the list.

The files list updates to show any files that match the selected file type.

4. Navigate to the folder that contains the file to recall, using one of the following methods:

- To recall files from recently accessed file locations, tap the drop down arrow in the **Look in** field and select from the list of recently accessed locations.
- Tap in the **Drive** column and use the displayed contents to navigate to locations on the internal storage location C, or on a connected USB drive (E -K).

- Double-tap the **Look in** field and use the virtual keyboard to manually enter a path to the file location (folder).

As you navigate the folders, the files list area shows all files that match the file type selected in the Files of Type field.

5. Select the file to recall, using one of the following methods:

- If the file was recently recalled, tap the drop down arrow in the **File Name:** field and select from a drop-down list of recently recalled files.
- Select a file name in the main files list. The File Name field updates to show the selected file name.



**Note:** You can double-tap on a file name to immediately recall the file and close the menu.

6. Tap **Recall**.

The instrument loads the session file and reconfigures the oscilloscope to the session file settings.

## Open a mask test file for an Eye Diagram plot

Use this procedure to open (load) and display an eye diagram mask for an eye diagram plot.

**Prerequisites:**

An eye diagram plot. To display an eye diagram plot, see [Display an Eye Diagram plot](#) on page 102.

An eye diagram mask file that defines at least three segments.

An eye diagram mask file that matches the time scale (unit interval) and vertical settings of the eye diagram.

1. Double-tap anywhere in the eye diagram plot to open the plot configuration menu.
2. Tap the **Mask** panel.
3. Tap **Browse**.
4. Use the **Browse Mask File Location** menu to navigate to and select an eye diagram mask file. See [Recall Mask File configuration menu](#) on page 517.

If the file was recently recalled, tap the arrow in the **File Name:** field and select from the list of recently recalled files.



**Note:** You can double-tap on a name in the File Name field to immediately recall the file and close the menu.

5. Tap **Recall** to close the menu and display the three eye diagram masks in the eye diagram plot.

# Menus and dialog boxes

All of the menus on your instrument and the available settings within each menu.

## Act On Event configuration menu

Use this configuration menu to set the actions the instrument takes when specified conditions are met (trigger event, measurement limit failure, mask hit failure, and so on).

To open the **Act On Event** menu, select the **Act On Event** button in menus where this button is available.

### Act On Event menu fields and controls

Displayed fields and controls can change depending on menu selections.

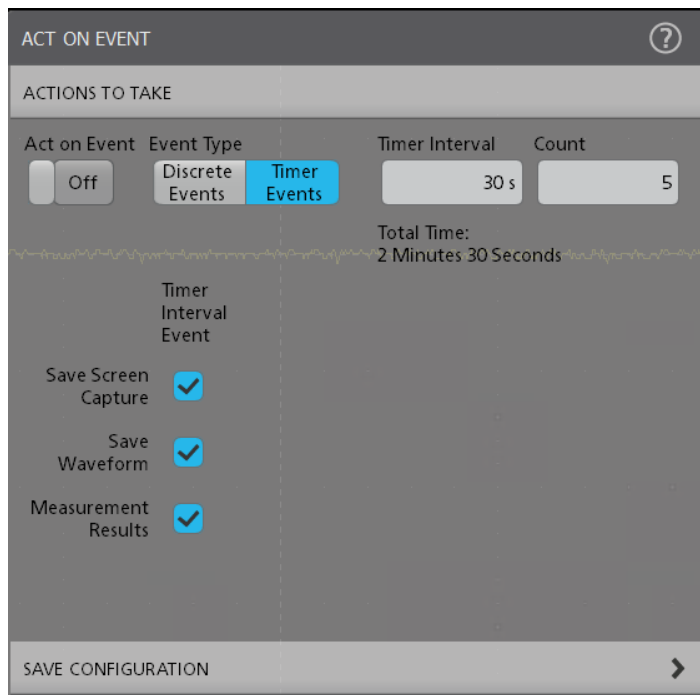

Field or control	Description
<b>Actions To Take panel</b>	
<b>Act on Event On/Off</b>	Allows you to configure Act On Event before enabling. If the maximum number of saves is hit, this control turns off.
<b>Event Type</b>	Select the event type as <b>Discrete Events</b> or <b>Timer Events</b> for saving screen capture, measurement result statistics logging, and saving waveforms.   <b>Note:</b> The Timer events does not work with Single/sequence. It runs for Run/Stop sequencing only.
<b>Timer Interval</b>	Sets the time interval between two timer events. Available when <b>Event Type</b> is <b>Timer Events</b> .
<b>Count</b>	Sets number of timer events that should happen before stopping Run/Stop sequencing. Available when <b>Event Type</b> is <b>Timer Events</b> .

Table continued...

Field or control	Description
<b>Save Screen Capture</b>	Saves the screen image at the time of the event, to the format designated in the <b>Save Configuration</b> panel.
<b>Save Waveform</b>	Saves the waveform data at the time of the event, to the format designated in the <b>Save Configuration</b> panel.
<b>Stop Acquisitions</b>	Stops the instrument from acquiring any more data.
<b>SRQ</b>	This is a signal sent via the VISA connection to alert listeners that an event has occurred. Enabling this will send such an event when the action has occurred and if the status registers are configured correctly.
<b>Number of Saves</b>	Allows you to toggle between <i>Unlimited</i> or <i>Specify a Maximum</i> for number of saves. Default option selected is Unlimited.
<b>Maximum</b>	Enter the maximum number of saves in the text field. This is enabled when Number of Saves is set to Specify a Maximum.
<b>Save Configuration panel</b>	
<b>Save Location</b>	Choose the location of the saved files when an action triggers a save event.
<b>Browse</b>	Browse to the save location through a visual file tree.
<b>File Name</b>	Name the saved file. When a file is saved, the file name is followed by a time stamp.
<b>Screen Capture Format</b>	Choose format of the screen capture save files.
<b>Waveform Format</b>	Choose waveform format for the screen capture save files.
<b>Source</b>	Choose the source for the waveform save files.

## Actions guidelines

- All actions are taken on a per acquisition basis. This means that if Save Screen Capture is checked in multiple columns and during a single acquisition the criteria is met in multiple columns, only a single screen capture is saved.
- For a timer event if there is no change in waveform dataset, the active measurement does not compute and log, instead shows an \* symbol next to the measurement in the selected log file.
- The waveform save and screen capture save happens even if the waveform data is same for the two timer events.
- If there is no change in the waveform dataset and if any measurement configuration changed in between two timer events then the measurements are computed and the measurement result statistics are added in the log file (without \* symbol).

## Acquisition configuration menu

Use this configuration menu to set which data points are used to acquire waveforms, and enable automatically saving acquisitions to files.

### The Acquisition menu fields and controls

To open the Acquisition menu, double-tap the **Acquisition** badge on the Settings bar.

Displayed fields and controls can change depending on menu selections.

Field or control	Description
<b>Run/Stop</b>	Toggles the oscilloscope between constant acquisition (Run) and no acquisitions (Stop). When stopped, the oscilloscope shows waveforms from the last completed acquisition.
<b>Single/Seq</b>	Acquires a single acquisition or a set number of acquisitions, then stops.

Table continued...

Field or control	Description
<b>Clear</b>	Erases acquired waveform data points from memory. Applies to all live acquisition waveforms.
<b>Acquisition Mode</b>	<b>Sample</b> creates a record point by saving one or more samples during each acquisition interval. Sample mode is the default acquisition mode. The instrument does no post processing of the acquired samples in this mode.
	<b>Peak Detect</b> alternates between saving the highest sample in one acquisition interval and the lowest sample in the next acquisition interval. Useful for capturing fast and random events such as narrow waveform pulses.
	<b>High Res</b> applies unique finite impulse response (FIR) filters based on the current sample rate. This FIR filter maintains the maximum bandwidth possible for that sample rate while rejecting aliasing. The filter removes noise from the oscilloscope amplifiers and ADC above the usable bandwidth for the selected sample rate. Implementation of the filter in hardware, ahead of the trigger and storage, reduces trigger jitter and enables using Fast Acq mode while in High Res mode. High Res mode also guarantees at least 12 bits of vertical resolution. The number of bits of resolution is displayed in the Acquisition badge in the Settings bar. The High Res sample rate and record length settings are displayed in the Horizontal badge. High Res mode sets the maximum real time sample rate to half the maximum sample rate.
	<b>Envelope</b> acquires and displays a waveform record that shows the extremes in variations over several acquisitions. The instrument saves the highest and lowest values in two adjacent intervals (similar to the Peak Detect mode). Unlike Peak Detect mode, the peaks are gathered over many trigger events.
	<b>Average</b> acquires and displays a waveform record that is the average result of several acquisitions. This mode reduces random noise.
	<b>Roll Mode</b> scrolls sequential waveform points across the display in a right-to-left rolling motion. Roll Mode starts automatically when the timebase is set to $\geq 40$ ms/div. Roll Mode works at sample rates up to 10 MS/s.
<b>Single Sequence/Stop After</b>	Enables stopping acquisitions after a specified number of acquisitions. Only works when using the Single/Sequence button.
<b>Enable Acquisition History</b>	Enables the acquisition history. By default, the option is unchecked. When checked, the History badge is enabled even if the acquisitions are running or stopped.
<b>Timebase Reference Source</b>	Sets the time base source used by the oscilloscope to acquire and measure signals. Internal sets the oscilloscope to use an internal reference signal. External sets the oscilloscope to use a 10 MHz signal connected to the rear-panel Ref In connector.
	On some instruments External is divided into External ( $\pm 2$ ppm) and External ( $\pm 1$ k ppm) selections. The narrow External ( $\pm 2$ ppm) setting locks the timebase within 2 ppm of 10 MHz. The wide External ( $\pm 1$ k ppm) allows the timebase to be within 1 k ppm of 10 MHz.
<b>Fast Frame panel</b>	Sets the Fast Frame acquisition mode. See <a href="#">Fast Frame Panel</a> on page 180

## Fast Frame Panel

Use this panel to enable FastFrame™ mode and select the number of frames to acquire.

The Fast Frame panel is accessed from the Acquisition badge menu.

To open the Acquisition menu:

1. Double-tap the **Acquisition** badge.
2. Tap the **Fast Frame** panel.
3. Use the fields to set the Fast Frame parameters.



## Fast Frame menu fields and controls

Field or control	Description
<b>Fast Frame</b>	Enables or disables the Fast Frame mode. When enabled (On), the screen shows either the last acquisition frame captured, or will wait for a acquisition completion of all the framed events.
<b>Number of Frames</b>	Shows the number of frames acquired. Tap on the field and use the multipurpose knob set the number of frames to acquire, or double-tap on the field and use the virtual keypad to enter a frame count. The maximum number of frames you can capture is displayed in the frame information readout area.
<b>Frame information readout area</b>	Displays frame acquisition information. The information changes depending on instrument settings, primarily the timebase, sampling rate and record length.
<b>Summary Frame</b>	Enables or disables creating and displaying a summary frame at the end of the frame record.  When the current acquisition mode is either Sample or High Res, the Summary Frame shows an average of all frames.  When the current acquisition mode is Peak Detect, the Summary Frame shows an envelope of all frames.

## Fast Frame usage guidelines

- Enabling Fast Frame mode disables FastAcq mode (if it was enabled). Likewise, enabling FastAcq mode disables Fast Frame mode (if it was enabled).
- You should define the trigger conditions to capture only the waveform, or waveform segment, in which you are interested, before enabling Fast Frame mode.
- You can use Fast Frame mode to acquire and compare frames for multiple signal inputs (analog, digital, math).
- You can use Zoom mode to view details of frames.
- Use **Single/Seq** triggering to acquire a single set of frames.
- While in Fast Frame mode, measurements are taken across all frames, not just the currently selected frame. Measurement badges show the ‘ symbol to indicate that the values are from the current acquisition (all frames). Lack of a ‘ means the values are across many Fast Frame acquisitions.
- To obtain rapid statistical results on massive populations, open the **Acquisition** badge menu, select **Single Sequence**, and set the **Single Sequence/ Stops After** field to acquire multiple sets of frames and keep statistics on all of them. When the sequence finishes, the last set of frames is still in memory and the instrument has accrued statistical data for a large number of frames.
- Use the **Run/Stop** button to manually start and stop the acquisition. Frames are acquired continuously until stopped, at which point the last N frames are in memory.
- Search works across all frames, not just the currently selected frame.
- In search mode, the Navigation buttons (Prev/Next arrow buttons) move from frame to frame as needed based on where the event is found.
- You can save Fast Frame waveforms as reference waveforms using the normal Save As process. Saved Fast Frame waveforms can be recalled as Reference waveforms.
- You can save and recall sessions with Fast Frame active. All frames are restored when the Session is recalled.
- If you display a regular (non-Fast Frame) reference waveform, the Reference waveforms is always displayed regardless of the currently selected frame.

## Fast Frame badge

Use the Fast Frame badge in the Results bar to select which frame to view and enable frame waveforms overlay mode. Fast Frame works on all displayed analog, digital, and math waveforms.

The Fast Frame badge is opened when you enable the Fast Frame mode in the [Fast Frame panel](#) of the Acquisition configuration menu.

### Fast Frame badge fields and controls

Field or control	Description
Frame count	Shows the total number of frames captured at the top of the badge.
<b>Selected Frame</b>	<p>Shows the selected frame in all displayed waveforms (analog, digital, and math). Use Multipurpose A knob to scroll through and select specific frames.</p> <p>To enter a specific frame number to display, use the Selected Frame field in the <a href="#">Fast Frame configuration menu</a>.</p> <p>Frame scrolling uses a wrap-around method. For example, when you reach the end of the frame list, scrolling further displays frame 1.</p> <p>If you have enabled overlay mode, the current frame's waveform is highlighted in blue in all displayed waveforms (analog, digital, and math).</p>
<b>Reference Frame</b>	<p>Selects a frame in the current frame acquisition that you want to use as a time reference against which to compare the selected frame. Displays a Delta readout that shows the difference between the Selected Frame and the Reference Frame.</p> <p>To directly enter a specific frame number to display, use the <b>Reference Frame</b> field in the <a href="#">Fast Frame configuration menu</a>.</p> <p>Available only when <b>Include Reference Frame in Badge</b> is selected in the Fast Frame configuration menu.</p>
Time stamps	<p>Shows the time difference between frame one and the Selected frame. If <b>Include Reference Frame in Badge</b> is enabled, each frame readout area (Selected and Reference) in the badge shows the time difference between frame one and the Selected and Reference frames.</p> <p>When both Selected and Reference frames are enabled, a <b>Delta</b> time readout shows the time difference between the Selected frame and the Reference frame.</p> <p>If the difference time displayed goes beyond 10 seconds, then digits are dropped from the right as needed and the displayed timestamp is rounded. Note that this is just for UI display purposes. The full, precise value is stored and available.</p>
Navigation buttons	Tap to display the previous or next frame. Navigation buttons are only displayed when acquisition is set to Stopped.
<b>Summary</b>	Displays the summary frame. the Summary frame button is only displayed when the Summary Frame button is enabled in the Acquisition menu Fast Frame panel.

## Fast Frame badge configuration menu

Use the Fast Frame configuration menu to set Fast Frame overlay mode, enable reference frame timestamp readouts, and display Fast Frame-related plots.

The Fast Frame configuration menu is accessed from the Fast Frame badge. To open the Fast Frame configuration menu, double-tap the upper (readouts) area of the **Fast Frame** badge.

## Fast Frame configuration menu fields and controls

Field or control	Description
Frame count	Shows the total number of frames captured at the top of the badge.
<b>Overlay Frames</b>	Overlays all acquired frames for each displayed source (analog, digital, and math).  If you have enabled overlay mode, the current frame's waveform is highlighted in blue in all displayed waveforms (analog, digital, and math).
<b>Selected Frame</b>	Sets or shows the current Selected frame number, and also shows the associated frame waveform in the Waveform View. Tap the field and use the Multipurpose knob A to scroll through the frame list.  Frame scrolling uses a wrap-around method. For example, when you reach the end of the frame list, scrolling further displays frame 1.  To enter a specific frame number, double-tap on the <b>Selected Frame</b> field and use the virtual keypad to enter a frame number.
<b>Include Reference Frame in Badge</b>	Enables or disables providing a Reference frame readout in the Fast Frame badge. A Reference frame readout shows a difference timestamp between Frame one and the Reference frame, and also the delta between the Selected frame and the Reference frame timestamps.  A Reference frame is not shown or highlighted in the Waveform View
<b>Reference Frame</b>	Set a Reference frame number.  Tap the field and use the Multipurpose knob B to set a frame number. To enter a specific frame number, double-tap on the <b>Selected Frame</b> field and use the virtual keypad to enter a frame number.  Available only when <b>Include Reference Frame in Badge</b> is selected.
<b>Plot Fast Frame Results</b>	Opens and displays the selected plot type.  <b>Timestamp Time Trend</b> plots the delta values from frame to frame for the current acquisition (full set of frames). The first data point is the delta time between frame 1 and frame 2. The second data point is the delta time between frame 2 and frame 3 and so on. It does not add data points with subsequent acquisitions.

## History badge configuration menu

Use the History configuration menu to set overlay acquisition, enable reference acquisition timestamp readouts, and display acquisition-related plots. The History configuration menu is accessed from the History badge. To open the History configuration menu, double-tap the **History** badge.

### History configuration menu: Settings panel fields and controls

Field or control	Description
<b>Overlay Acquisitions</b>	Overlays all acquired acquisitions for each displayed source (analog, digital, and math).  If you have enabled overlay mode, the current acquisition waveform is highlighted in blue in all displayed waveforms (analog, digital, and math).

Table continued...

Field or control	Description
<b>Selected Acquisition</b>	Shows the waveforms associated with the Selected acquisition. Along with that the results of all active analysis elements (Example: Math/Measurements/Search/Protocol buses) are computed as well. Tap the field and use the Multipurpose knob A to scroll through the acquisition list.  To enter a specific acquisition number, double-tap on the <b>Selected Acquisitions</b> field and use the virtual keypad to enter a acquisition number.
<b>Include Reference Acquisitions in Badge</b>	Enables or disables a Reference acquisitions readout in the History badge. A Reference acquisition readout shows the difference between Selected acquisition and the Reference acquisition. It also displays the delta between the Selected acquisition and the Reference acquisition timestamps.  The Reference acquisitions are not shown or highlighted in the Waveform View.
<b>Reference Acquisitions</b>	Set a Reference acquisition number.  Tap the field and use Multipurpose knob B to set a acquisition number. To enter a specific acquisition number, double-tap on the <b>Selected Acquisitions</b> field and use the virtual keypad to enter a frame number.  Available only when <b>Include Reference Acquisitions in Badge</b> is selected.
<b>Plots/Tables</b>	Opens and displays the Timestamp Time Trend plot and Timestamp Results Table.  The Timestamp Time Trend plots the delta values for each current acquisition. See <a href="#">History Timestamp Trend plot configuration menu</a> on page 186  The Timestamp Results Table displays a result table of timestamp for all acquired acquisitions. See <a href="#">History Timestamp Result Table configuration menu</a> on page 187

### History configuration menu: Other panel fields and controls

Field or control	Description
<b>Navigation Method</b>	Sets the navigation method as <b>Previous / Next</b> or <b>Play / Pause</b> . The default is <b>Previous / Next</b> .
<b>Playback Speed</b>	Sets the playback speed as <b>Slow</b> , <b>Medium</b> , or <b>Fast</b> . The default is <b>Medium</b> . Available when <b>Navigation Method</b> is <b>Play / Pause</b> .
<b>Cumulative Statistics / Plot Results Based On</b>	The Statistics and Plot results based on the selection of <b>All Acquisitions</b> or <b>History Only</b> . The default is <b>All Acquisitions</b> .  <b>All Acquisitions:</b> Statistics and plots update with each acquisition. Once you stop acquisitions, the results remain static.  <b>History Only:</b> With History Only selected, statistics and plots update only after acquisitions have been stopped and are calculated only over the set of acquisitions stored in history. These results remain static until you start acquiring again. When this happens, cumulative results remains blank until acquisitions are stopped.

### Right click menu for History badge

The following functions are available when you right click on a History badge.

Field or control	Description
Disable Acquisition History	Select to disable acquisition history or to delete history badge. Disable Acquisition History does not clear the history acquisitions.   <b>Note:</b> The current acquired history data will be cleared, if any Horizontal or Acquisition parameters are changed.
Configure Acquisition History	Select to configure the acquisition history.

## Guidelines to save History acquisitions

- When you saves a setup, no channel data is stored (only reference waveforms are saved with setups).
- When you saves a session, all History/FastFrame data is stored with the session.
- When you saves a waveform, all history/frames associated with that waveform are saved.
- When either History or FastFrame is active and you go to Save As menu, the **Gating** dropdown includes a option called **Selected Acq.**
- If **Selected Acq** is selected when the save happens, only the currently selected Acq/frame is saved.

## History usage guidelines

- Enabling History mode allows you to review the last acquisitions after acquisitions are stopped or completed.
- As you navigate through the history, you will see the acquired waveforms associated with each acquisition and all active analysis features will run on the selected acquisition.
- Any acquisition change (anything that can cause the acquisitions counter to reset or measurement statistics to reset) causes the History buffer to be flushed and restart accumulation.
- **Single/Seq** contributes to History mode.
- Analysis results are provided in two categories
  - **Single:** This refers to the readouts/views within a single acquisition. These include:
    - Cursors, when placed on a waveform generated from a single acquisition
    - Math waveforms
    - Measurements and statistics related to the measurements that come from a single acquisition.
    - All plots except Histogram
    - Searches
    - Bus Decode
  - **Cumulative:** This refers to a readout/view from multiple acquisitions. These include:
    - Cursors, when placed on a waveform generated from many acquisitions (Spectrum View Max Hold, Min Hold, and Average traces).
    - Statistics that are accumulated across multiple acquisitions.
    - Histogram plots
- Measurement and search results report across all acquisition in History and can be navigated through, including from acquisition to acquisition.
- If Visual Trigger is on when the oscilloscope is running, the only acquisitions that meet the Visual Trigger criteria are saved to History memory.
- History Timestamp Time Trend plot and Timestamp Results Table get updated when the acquisitions are stopped.
- The following features are not compatible with History mode:
  - FastAcq mode
  - FastFrame

- Roll mode
- Average, Peak Detect, and Envelope acquisition modes
- Math average

### History Timestamp Trend plot configuration menu

Use this menu to change settings of a displayed History Timestamp Time Trend plot.

To open the History Timestamp Time Trend plot configuration menu, double-tap anywhere in a **Timestamp Time Trend** plot view.

### History Timestamp Time Trend plot configuration menu fields and controls

Field or control	Description
<b>AutoScale</b>	Toggles AutoScale <b>On</b> or <b>Off</b> . Default is On. Turn AutoScale off to set the X and Y-axis range to view an area of interest.  When AutoScale is Off (unchecked), the Plot view zoom mode enables and a small Zoom window appears in the plot. Drag the blue zoom area box in the small Zoom window to view that area in the main Plot view. You can also use the Zoom and Pan front-panel knobs to change the zoom area and horizontal position.
<b>Gridlines</b>	Selects which gridlines to show in the plot. Available gridlines are <b>Horizontal</b> , <b>Vertical</b> , and <b>Both</b> .
<b>X-Axis From, To</b>	Sets the beginning and end scale range to display in the plot for the X-axis scales.  These values also define the horizontal area shown in the small Zoom window.  Available when <b>AutoScale</b> is <b>Off</b> .
<b>Y-Axis From, To</b>	Sets the beginning and end scale range to display in the plot for the Y-axis scales.  These values also define the vertical area shown in the small Zoom window.  Available when <b>AutoScale</b> is <b>Off</b> .

### Save panel fields and controls

Use the Save panel controls to save the plot image or data to a file for inclusion in reports or further analysis in other applications.

Field or control	Description
<b>Save Plot Image</b>	Tap to open the Save As menu. Navigate to the location where you want to save the plot image. Enter a file name in the File Name field. Select the image file format (PNG, BMP, or JPG).  Tap <b>OK</b> to save the plot image.
<b>Save Plot Data</b>	Tap to open the Save As menu. Navigate to the location where you want to save the plot data. Enter a file name in the File Name field.  Tap <b>OK</b> to save the plot data as a comma-separated values (.csv) file.

### Closing a plot view

To close (delete) a Plot view, tap the **X** in the upper right corner of the view.

Deleting the Measurement badge that enabled the plot also closes the plot.

## History Timestamp Result Table configuration menu

Use this menu to configure the Timestamp Results Table.

To open the Timestamp Results Table configuration menu, double-tap anywhere in the timestamp results table. If there are multiple timestamp results tables, tap the tab of the timestamp results table to configure and then double-tap anywhere in that table.

### Timestamp Results Table menu

Field or control	Description
<b>Column Visibility panel</b>	
<b>Acquisition Number</b>	Sets the acquisition number for each acquisition.
<b>Datestamp</b>	Sets the acquisition datestamp for each acquisition.
<b>Timestamp</b>	Sets the acquisition timestamp for each acquisition.
<b>Delta time</b>	Sets the delta time to display the deltas. Delta shows the time difference between the acquisitions.
<b>Other panel</b>	
<b>Save Table</b>	Opens a menu with which to save the results table data to a file. See <a href="#">Save As configuration menu (Timestamp Results Table)</a> on page 187.

### Timestamp Results Table operations

- Double-tap anywhere on a results table to open its configuration menu.
- To scroll up and down in a results table, tap the table and use Multipurpose knob A to scroll and select table rows.
- To move a column, touch and drag the column title to a new position in the table.
- To add or remove a column from the table, double-tap the results table to open the table configuration menu and select from the available columns to add or remove.
- To resize a column width, use the mouse to position the cursor on the column name border to change, then click and drag the column border to resize that column. If the column width change forces the truncation of data, hovering over a cell displays the full information content of that cell (subject to significant digits limitations on numeric entries).
- You cannot sort the contents of a column.
- You cannot change the order of rows.
- The History badge and Timestamp Results Table works in sync for selected acquisition. The History badge shows the same acquisition that selected in results table. The results table row will be highlighted for acquisition currently showing in the history badge.

### Save As configuration menu (Timestamp Results Table)

Use the Save As configuration menu to set the location and file name to which to save the contents of a results table, as a comma-separated value (csv) format file.

To open the Save As configuration menu to save a results table

1. Double-tap anywhere in the Timestamp Results Table to open the timestamp table configuration menu.
2. Tap the **Other** panel.
3. Tap **Save Table**.

## Save As menu, Timestamp Results Table fields and controls

Field or control	Description
<b>Save Location</b>	<p>Sets the save location for the file. The default value is the last location to which a file was saved.</p> <p>Tap on the file path and use a keyboard to enter a new save location. Or double-tap on the file name to open the on-screen keyboard and enter a path.</p> <p>Tap the down arrow icon on the right end of the field to open a list of recent file save locations, for the current save type, up to a maximum of 20 locations.</p>
<b>Browse</b>	<p>Tap to open the Browse Save As Location dialog, to navigate to and select the location to which to save the file. See <a href="#">Browse Save As Location configuration menu</a> on page 477.</p>
<b>File Name</b>	<p>The file name assigned to the file. The default file name is Tek000. The file name increments on the next save (Tek001, Tek002, and so on).</p> <p>Tap on the file name and use a keyboard to enter a new file name. Or double-tap on the file name to open the on-screen keyboard and enter a file name.</p>
<b>Save as Type</b>	<p>You can save only results table as comma separated values (.csv) files.</p>

## Add Measurements configuration menu overview

Use this configuration menu to select measurements you want to take on waveforms and add the measurements to the Results bar.

To open the **Add Measurements** configuration menu, tap the **Add New... Measure** button in the **Analysis** controls area.

The **Add Measurements** configuration menu always opens on the **Standard** measurement tab. The listed tabs and measurements depend on the installed measurement options and the selected signal source.

To add a measurement, select the measurement type tab, select the input source or sources, select the measurement, and either tap the **Add** button or double-tap the measurement. The measurement is added to the Results bar.



To change individual measurement settings, double-tap the Measurement badge to open a configuration menu for that measurement. See [Measurement configuration menu overview](#) on page 210.

## Add Measurements menu fields and controls

Field or control	Description
<b>Measurement tabs</b>	<p>The tabs along the top organize measurements by their type. The Standard tab is the default set of measurements that are built in to the instrument. Other tabs are shown when you install measurement options. See <a href="#">The Jitter tab (Advanced Jitter and Eye Analysis)</a> on page 196. See <a href="#">The Power tab</a> on page 199.</p>
<b>Measurement description</b> (graphic and text)	<p>Shows a graphic and short description of the selected measurement. Use this information to verify that the selected measurement is correct for what you want to measure.</p>
<b>Source</b>	<p>Selects the measurement source. If the measurement requires more than one source (for example, Skew, Phase, or many Power measurements), the menu shows two source fields from which to select.</p>
<b>Add button</b>	<p>Adds the selected measurement as a measurement badge to the Results bar. You can also double-tap a listed measurement to add it to the Results bar.</p>



## Standard tab measurement panels

Panel	Description
Amplitude Measurements panel	Tap the panel bar to list the available amplitude measurements. Touch and drag the list to scroll through all measurements. See <a href="#">Amplitude Measurements panel</a> on page 190.
Timing Measurements panel	Tap the panel bar to list the available time measurements. Touch and drag the list to scroll through all measurements. See <a href="#">Timing Measurements panel</a> on page 191.
Jitter Measurements panel	Tap the panel bar to list the available standard jitter measurements. See <a href="#">Jitter Measurements panel</a> on page 195.   <b>Note:</b> If you have installed the Advanced Jitter and Eye Analysis option, the <b>Jitter Measurements</b> panel is removed from the <b>Standard</b> measurement tab and is replaced with a <b>Jitter</b> tab at the top of the <b>Add Measurements</b> menu. See <a href="#">The Jitter tab (Advanced Jitter and Eye Analysis)</a> on page 196.
Spectrum Measurements panel	Tap the panel bar to list the available spectrum measurements. See <a href="#">Spectrum Measurements panel</a> on page 193   <b>Note:</b> The Spectrum Measurements panel is only available when <b>Spectrum View</b> is set from the analog channel badge menu. See the <a href="#">Spectrum Measurements panel</a> on page 193 settings.

## Other tab measurements (require optional licenses)

Add Measurement tab	Description
Jitter	Advanced Jitter and Eye Analysis measurements (option). Provides triggers and measurements for advanced jitter and eye analysis. See <a href="#">The Jitter tab (Advanced Jitter and Eye Analysis)</a> on page 196.
Power	Advanced Power Analysis (option). Provides measurements for electrical analysis, output analysis, amplitude analysis, timing analysis, and switching analysis. See <a href="#">The Power tab</a> on page 199.
DPM	Digital Power Management Analysis (option). Provides measurements for ripple analysis, transient analysis, power sequence analysis, jitter and eye analysis. See <a href="#">The DPM tab</a> on page 204.
DDR	DDR (option). Provides measurements for DDR amplitude and timing analysis. See <a href="#">The DDR measurements tab</a> on page 207.
IMDA	IMDA (Inverter Motors and Drive Analysis) (option). 3 phase measurement is provided for Electrical analysis and Mechanical analysis. See <a href="#">The IMDA tab</a> on page 203.
WBG-DPT	WBG-DPT (Wide Band Gap-Double Pulse Test) (option). Provides measurements for Switching parameter analysis, Switching timing analysis, and Diode recovery analysis. See <a href="#">The WBG-DPT tab</a> on page 208.

## The Standard measurements tab

The **Standard** tab lists the default set of amplitude, Timing, and jitter measurements that are included with the instrument.

To open the **Standard** measurements tab, tap the **Add New... Measure** button. The Add Measurements configuration menu opens on the Standard tab by default.

To add a measurement to the Results bar:

1. Select the signal source.
2. Tap a measurement panel:

[Amplitude Measurements panel](#) on page 190

[Timing Measurements panel](#) on page 191

[Jitter Measurements panel](#) on page 195

[Spectrum Measurements panel](#) on page 193

3. Select a measurement. If a measurement requires two signal sources, select the sources in the Source 1 and Source 2 fields.
4. Tap **Add**. You can also double-tap a measurement to add it immediately to the Results bar.



**Note:** If you have installed Advanced Jitter and Eye Analysis option, all jitter measurements are in the **Jitter** tab. See [The Jitter tab \(Advanced Jitter and Eye Analysis\)](#) on page 196.

## Amplitude Measurements panel

The Amplitude Measurements panel lists available amplitude-related measurements that you can take on analog channel signals, math waveforms (time-domain), and reference waveforms. Amplitude measurements are not available for digital signals. The measurement annotations are supported for all amplitude measurements.

To open the Amplitude Measurements panel:

1. Tap **Add New... Measure** button.
2. Tap the **Amplitude Measurements** panel.

To add a measurement to the Results bar:

1. Select the signal source.
2. Select a measurement.
3. Tap **Add**. You can also double-tap a measurement to add it immediately to the Results bar.

### The Amplitude Measurements panel measurements

Measurement	Description
<b>AC RMS</b>	The true Root Mean Square voltage, minus any DC component, of the waveform data points that are above the Mean signal level. You can take this measurement on each cycle in the waveform record or on the entire waveform record.
<b>Amplitude</b>	The difference between the Top value and the Base value. You can take this measurement on each cycle in the waveform record or on the entire waveform record.
<b>Area</b>	The area between the waveform and the Mean value, calculated by integrating the data points. The area above ground (0 V) is positive, while the area below ground is negative. You can take this measurement on each cycle in the waveform record or on the entire waveform record.
<b>Base<sup>2</sup></b>	The most common data point value below the midpoint of the waveform, over the measurement region. Base is used as the 0% value whenever low reference values are calculated, such as in rise time or fall time measurements. You can take this measurement on each cycle in the waveform record or on the entire waveform record.
<b>Maximum</b>	The maximum data point value. You can take this measurement on each cycle in the waveform record or across the entire waveform record.
<b>Mean</b>	The arithmetic mean of all data points over the measurement region. You can take this measurement on each cycle in the waveform record or on the entire waveform record.
<b>Minimum</b>	The minimum data point value. You can take this measurement on each cycle in the waveform record or on the entire waveform record.

Table continued...

<sup>2</sup> Changing your Base Top Method in the Reference Levels panel of the Measurement configuration menu may change how this value is calculated.

Measurement	Description
<b>Negative Overshoot<sup>2</sup></b>	The difference between the Minimum and Base values, divided by the Amplitude, and multiplied by 100 to express the measurement as a percentage of amplitude. You can take this measurement on each cycle in the waveform record or on the entire waveform record.
<b>Peak-To-Peak</b>	The absolute difference between the Maximum and Minimum amplitudes in the measurement region. You can take this measurement on each cycle in the waveform record or on the entire waveform record.
<b>Positive Overshoot<sup>2</sup></b>	The difference between the Maximum value and the Top value, divided by the Amplitude, and multiplied by 100 to express the measurement as a percentage of amplitude. You can take this measurement on each cycle in the waveform record or on the entire waveform record.
<b>RMS</b>	The true Root Mean Square (The square root of the mean (average) value of the squared function of the waveform data points.) You can take this measurement on each cycle in the waveform record or on the entire waveform record.
<b>Top<sup>2</sup></b>	The most common data point value above the midpoint of the waveform over the measurement region. Base is used as the 100% reference value whenever high reference values are calculated, such as in rise time or fall time measurements. You can take this measurement on each cycle in the waveform record or on the entire waveform record.

## See also

[Measurement configuration menu overview](#) on page 210

## Timing Measurements panel

Use the Timing Measurements panel to add timing-related measurements to the Results bar. **Timing** measurements can be taken on time-domain analog, math, and reference waveforms. Timing measurements can also be taken on some digital channel signals. The measurement annotations are supported for all time measurements.

To open the Timing Measurements panel:

1. Tap **Add New... Measure** button.
2. Tap the **Timing Measurements** panel.

To add a measurement to the Results bar:

1. Select the signal source.
2. Select a measurement. If a measurement requires two signal sources, select the sources in the Source 1 and Source 2 fields.
3. Tap **Add**. You can also double-tap a measurement to add it immediately to the Results bar.

## Timing Measurements panel

Measurement	Description
<b>Burst Width<sup>3</sup></b>	The duration of a series of adjacent crossings of the Mid reference level. Bursts are separated by a specified idle time.  The measurement is taken on each burst in a waveform record.

Table continued...

<sup>3</sup> This measurement can also be taken on digital signals.

Measurement	Description
<b>Data Rate</b> <sup>3</sup>	Data Rate is the reciprocal of Unit Interval. The measurement is taken on each bit of the waveform record.
<b>Delay</b>	The time difference between the mid reference (default 50%) amplitude point of two different waveforms. You can specify the signal edges to measure in the measurement's Configuration menu. The measurement requires two sources.
<b>Duration N-Periods</b> <sup>3</sup>	The time required to complete N cycles. A cycle is the time between two adjacent (same direction) crossings of the mid reference level. The measurement is taken on each cycle in the waveform record.
<b>Fall Time</b>	The time required for the trailing edge of the first pulse in the measurement region to fall from the high reference value (default = 90%) to the low reference value (default = 10%). The measurement is taken on each cycle of the waveform record.
<b>Falling Slew Rate</b>	The rate of change (in volts/second) as an edge transitions from a high reference level to a low reference level. The measurement is taken on each cycle of the record in the measurement region.
<b>Frequency</b> <sup>3</sup>	The frequency of the waveform. Frequency is the reciprocal of Period (Frequency = 1/Period).
<b>High Time</b>	The time the signal remains above the Top reference level. The measurement is taken on each cycle in the waveform record.
<b>Hold Time</b> <sup>3</sup>	The time between the specified Mid reference level crossing on the clock signal to the closest Mid reference level crossing on the specified data signal. The measurement is taken on each specified clock edge in the waveform record.
<b>Low Time</b>	The time the signal remains below the Base reference level. The measurement is taken on each cycle in the waveform record.
<b>Negative Duty Cycle</b> <sup>3</sup>	The ratio of the negative pulse width to the signal period, expressed as a percentage. The duty cycle is measured on the first cycle in the measurement region.
<b>Negative Pulse Width</b> <sup>3</sup>	The distance (time) between the mid reference (default 50%) amplitude points of a negative pulse. The measurement is taken on each cycle in the waveform record or measurement region.
<b>Period</b> <sup>3</sup>	The time between two adjacent crossings of the Mid reference level (one cycle) of the waveform. The measurement is taken on each cycle of the waveform record or measurement region.
<b>Phase</b> <sup>3</sup>	The time difference (phase shift) between the specified signal edges of waveform source 1 and waveform source 2. The measurement is expressed in degrees, where 360° comprise one waveform cycle. This measurement requires two sources. The measurement is taken on each cycle of the waveform record.
<b>Positive Duty Cycle</b> <sup>3</sup>	The ratio of the positive pulse width to the signal period, expressed as a percentage. The duty cycle is measured on the first cycle in the measurement region.

Table continued...

Measurement	Description
<b>Positive Pulse Width</b> <sup>3</sup>	The distance (time) between the mid reference (default 50%) amplitude points of a positive pulse. The measurement is made on the first pulse in the measurement region.
<b>Rise Time</b>	The time required for the leading edge of the first pulse in the measurement region to rise from the low reference value (default = 10%) to the high reference value (default = 90%). The measurement is taken on each cycle of the waveform record.
<b>Rising Slew Rate</b>	The rate of change (in volts/second) as an edge transitions from a low reference level to a high reference level. The measurement is taken on each cycle of the record in the measurement region.
<b>Setup Time</b> <sup>3</sup>	The time between the specified Mid reference level crossing on the data signal to the closest Mid reference level crossing on the specified clock signal. The measurement is made on each specified clock edge in the waveform record.
<b>Skew</b> <sup>3</sup>	The time between the specified Mid reference level crossing on one source to the closest Mid reference level crossing on the second source signal. The measurement is made on each cycle in the waveform record.
<b>Time Outside Level</b>	The time the specified signal remains above the Top reference level and/or below the Base reference level. The measurement is made on each occurrence in the waveform record.
<b>Time to Min</b>	Time to Min is the amount of time from the trigger point to the minimum data point. This measurement can be made across the entire record or on each cycle in the record.
<b>Time to Max</b>	Time to Max is the amount of time from the trigger point to the maximum data point. This measurement can be made across the entire record or on each cycle in the record.
<b>Unit Interval</b> <sup>3</sup>	The time difference between two successive bits. The measurement is taken on each bit of the waveform record.

## See also

[Measurement configuration menu overview](#) on page 210

## Spectrum Measurements panel

The Spectrum Measurements panel lists available measurements that you can take on analog channel signals with Spectrum View enabled.

Spectrum measurements are initially configured from the badge menu for each channel. To open the Spectrum Measurements panel:

1. Double-tap the channel badge.
2. Tap the Spectrum View panel.
3. Set **Display** to **On**. The instrument opens the Spectrum View menu.

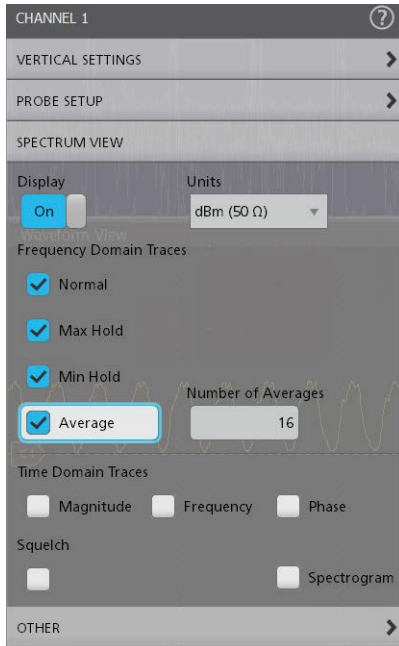

4. Select the **Frequency Domain Traces** to show in the Spectrum View (**Normal**, **Max Hold**, **Min Hold**, and/or **Average**).
5. Tap **Add New... Measure**.
6. Set the signal **Source** for the selected analog channel as **Ch\_X\_SV\_Average**, **Ch\_X\_SV\_Max\_Hold**, **Ch\_X\_SV\_Min\_Hold**, or **Ch\_X\_SV\_Normal**.

The Spectrum Measurements panel displays in the Standard tab.

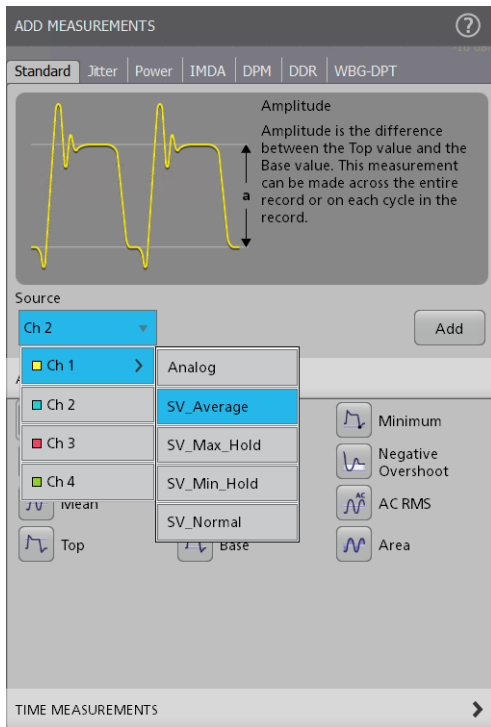

To add a measurement to the Results bar:

1. Select the signal **Source**.

2. Select a measurement.
3. Tap **Add**. You can also double-tap a measurement to add it immediately to the Results bar.

## Spectrum Measurements panel

Measurement	Description
<b>Channel Power</b>	<p>Measures the total RF power within the bandwidth defined by the channel width. It is measured as a unit of dBm, Vrms, dBuW, dBmV, dbuV, dBmA, or dBuA.</p> <p>The channel power of an RF signal is the total power within the specified channel width. The resulting channel power is an absolute power measurement. The Channel Width is indicated by the non-shaded portion of the Spectrum View display.</p>
<b>ACPR</b>	<p>Measures the signal power leaking from the main channel into adjacent channels. It is measured as a unit of Vrms, dBm, dBuW, dBmV, dbuV, dBmA, or dBuA.</p> <p>ACPR is ratio of total power in adjacent channels to the main channel power. Each adjacent channel has upper and lower bands decided by channel width and channel spacing. The Channel width for all the channels is indicated by the non-shaded portion of the Spectrum View Display.</p>
<b>Occupied Bandwidth</b>	<p>Measures the occupied bandwidth. It is measured in Hz.</p> <p>Occupied Bandwidth (OBW) is the bandwidth that contains the specified power within the Analysis Bandwidth. The Analysis Bandwidth is indicated by the non-shaded portion of the Spectrum View display.</p>

## See also

[Spectrum measurements configuration menu overview](#) on page 222

[Configure panel \(Spectrum measurements configuration menu\)](#) on page 223

[Pass/Fail Testing panel \(Spectrum measurement configuration menu\)](#) on page 225.

## Jitter Measurements panel

The Jitter Measurements panel lists the standard jitter-related measurements that you can add to the Results bar. These jitter measurements are part of the Standard measurements that are provided by default.

To open the Jitter Measurements panel:

1. Tap the **Add New... Measure** button.
2. Tap the **Jitter Measurements** panel.

To add a measurement to the Results bar:

1. Select the signal source.
2. Select a measurement.
3. Tap **Add**. You can also double-tap a measurement to add it immediately to the Results bar.



**Note:** If you have installed Advanced Jitter and Eye Analysis option, the jitter measurements are moved to the **Jitter** tab of the **Add Measurements** menu. See [The Jitter tab \(Advanced Jitter and Eye Analysis\)](#) on page 196.

### Jitter Measurements panel measurements

Measurement	Description
Phase Noise	The RMS magnitude of all integrated jitter falling within a specified offset range of the fundamental clock frequency. This measurement is taken on the entire waveform record.
TIE	The difference in time between an edge in the source waveform and the corresponding edge in a recovered reference clock signal. The measurement is made on each waveform edge in the measurement region.

### See also

[Measurement configuration menu overview](#) on page 210

### The Jitter tab (Advanced Jitter and Eye Analysis)

The Jitter tab lists advanced jitter, eye, amplitude, and timing measurements that you can add to the Results bar. The Jitter tab is only shown if you have purchased and installed the Advanced Jitter and Eye Analysis option.

To open the Jitter measurements tab:

1. Tap **Add New... Measure** button.
2. Tap the **Jitter** tab.

To add a measurement to the Results bar:

1. Select the signal source.
2. Select a measurement panel.
3. Select a measurement.
4. Tap **Add**. You can also double-tap a measurement to add it to the Results bar.

### Adding eye diagram plots for a jitter measurement

To display an eye diagram plot for a jitter measurement, double-tap the jitter measurement badge for which you want to show an eye diagram. If available, tap the **Eye Diagram** plot button.

### Jitter Measurements panel

Measurement	Description
DCD	Duty cycle distortion. The peak-to-peak amplitude for the component of the deterministic jitter correlated with the signal polarity.  The measurement is taken on the entire record.
DDJ	Data dependent jitter. The peak-to-peak amplitude for the component of the deterministic jitter correlated with the data pattern in the waveform.  The measurement is taken on the entire record.
DJ	Deterministic jitter. The peak-to-peak amplitude of all timing errors that exhibit deterministic behavior.  The measurement is taken across the entire record.

Table continued...



Measurement	Description
DJ- $\delta\delta$	Dual-Dirac deterministic jitter. The deterministic jitter on a simplifying assumption that the histogram of all deterministic jitter can be modeled as a pair of equal-magnitude Dirac functions. The measurement is taken on the entire record.
F/2	The peak-to-peak amplitude of the periodic jitter occurring at a rate of Fb (data rate) divided by two. The measurement is taken on the entire record.
F/4	The peak-to-peak amplitude of the periodic jitter occurring at a rate of Fb (data rate) divided by four. The measurement is taken across the entire record.
F/8	The peak-to-peak amplitude of the periodic jitter occurring at a rate of Fb (data rate) divided by eight. The measurement is taken on the entire record.
J2	The total jitter at a bit error rate of 2.5e-3 (TJ@2.5e-3). The measurement is taken on the entire record.
J9	The total jitter at a bit error rate of 2.5e-3 (TJ@2.5e-3). The measurement is taken on the entire record.
CC-Jitter	Cycle to Cycle Jitter measures the clock period change between any two adjacent cycles. The measurement is taken on the entire record.
Jitter Summary	Adds multiple jitter measurements to the measurement badge, and displays Bathtub, TIE Spectrum trend plot, TIE Histogram, Eye Diagram plots on the screen.
NPJ	Nonperiodic jitter. The portion of the BUJ (Bounded uncorrelated jitter) that is random. BUJ excludes DDJ, DCD, and RJ. The measurement is taken on the entire record.
Phase Noise	The RMS magnitude of all integrated jitter falling within a specified offset range of the fundamental clock frequency. The measurement is taken on the entire record.
PJ	Periodic jitter. The peak-to-peak amplitude of the uncorrelated sinusoidal components of the deterministic jitter. The measurement is taken on the entire record.
RJ	Random jitter. The RMS magnitude of all random timing errors following a Gaussian distribution. The measurement is taken on the entire record.
RJ- $\delta\delta$	Dual-Dirac random jitter. The random jitter on a simplifying assumption that the histogram of all deterministic jitter can be modeled as a pair of equal-magnitude Dirac functions. The measurement is taken on the entire record.
SRJ	Sub-rate jitter. The composite jitter due to periodic components at $\frac{1}{2}$ , $\frac{1}{4}$ , and $\frac{1}{8}$ of the data rate. The measurement is taken on the entire record.

Table continued...

Measurement	Description
TIE	Time Interval Error. The difference in time between an edge in the source waveform and the corresponding edge in a recovered reference clock signal.  The measurement is taken on each waveform edge.
TJ@BER	Total error at a specified bit error rate. The predicated peak-to-peak amplitude of jitter that will only be exceeded with a probability equal to the bit error rate.  The measurement is taken on the entire record.

### Eye Measurements panel

Measurement	Description
Eye Height	The minimum vertical eye opening at the center of the recovered unit interval.  The measurement is taken on the entire waveform record.
Eye High	The amplitude of a high (one) bit measured at a specified location within the recovered unit interval.  The measurement is taken on each high bit in the waveform record.
Eye Low	The amplitude of a low (zero) bit measured at a specified location within the recovered unit interval.  The measurement is taken on each low bit in the waveform record.
Eye Width	The minimum horizontal eye opening at the center of the recovered unit interval.  The measurement is taken on the entire waveform record.
EyeHeight@BER	The predicted vertical eye opening that will be violated with a probability equal to the bit error rate.  The measurement is taken on the entire waveform record.
EyeWidth@BER	The predicted horizontal eye opening that will be violated with a probability equal to the bit error rate.  The measurement is taken on the entire waveform record.
Q-Factor	The ratio of the vertical eye opening to RMS vertical noise measured at a specified location in the recovered unit interval.  The measurement is taken on the entire waveform record.

### Amplitude Measurements panel

Measurement	Description
AC Common Mode (Pk-Pk)	The peak-to-peak of the common mode voltage of the two specified sources.  The measurement is taken on the entire record.
Bit Amplitude	The difference between the amplitudes of the 1 and 0 bits surrounding a transition. The amplitude is measured over a specified part of at the center of the recovered time interval.  The measurement is taken on each transition bit of the entire record (Mean) or on the entire record (Mode).

Table continued...

Measurement	Description
<b>Bit High</b>	The amplitude of a 1 bit, measured over a specified percent of the center of the recovered time interval. The measurement is taken on each high bit of the entire record (Mean) or on the entire record (Mode).
<b>Bit Low</b>	The amplitude of a 0 bit, measured over a specified percent of the center of the recovered time interval. The measurement is taken on each low bit of the entire record (Mean) or on the entire record (Mode).
<b>DC Common Mode</b>	The arithmetic mean of the common mode voltage of two sources. The measurement is taken on the entire record.
<b>Differential Crossover</b>	The voltage level of a differential signal pair at the crossover point(s). The measurement is taken at each crossover point in the record.
<b>T/nT Ratio</b>	The ratio of a nontransition bit voltage (second and subsequent bit voltage after a transition) to its nearest preceding transition bit voltage (first bit voltage after the transition). Bit voltage is measured at the interpolated midpoint of the recovered unit interval. The measurement is taken on each nontransition bit in the record.

### Timing Measurements panel

Measurement	Description
<b>SSC Freq Dev</b>	The spread spectrum clock frequency deviation. This measurement enables a time trend plot of the spread spectrum clock modulation profile. The measurement is taken on each cycle of the entire record.
<b>SSC Modulation Rate</b>	The modulation frequency of a spread spectrum clock. The measurement is taken on each cycle of the entire record.

### See also

[Measurement configuration menu overview](#) on page 210

## The Power tab

The Power tab lists the optional power-related measurements that you can add to the Results bar. Power measurements include input analysis, amplitude analysis, timing analysis, switching analysis, and output analysis.

To open the Power measurements tab:

1. Tap the **Add New... Measure** button.
2. Tap the **Power** tab.

To add a measurement to the Results bar:

1. Select the signal sources. If the measurement requires two signal sources, select the sources in the Source 1 and Source 2 fields.
2. Tap a measurement panel:

[Input Analysis Measurements panel](#) on page 200

[Amplitude Analysis Measurements panel](#) on page 200

[Timing Analysis Measurements panel](#) on page 200

[Switching Analysis Measurements panel](#) on page 201

[Magnetic Analysis Measurements panel](#) on page 201

[Output Analysis Measurements panel](#) on page 202

[Frequency Response Analysis \(FRA\) Measurements panel](#) on page 202

3. Select the measurement.
4. Tap **Add**. You can also double-tap a measurement to add it to the Results bar.

### Input Analysis Measurements panel

Measurement	Description
Power Quality	Measures the Frequency, RMS values of the voltage and current, Crest Factors of the voltage and current, Real Power, Reactive Power, Apparent Power, Power Factor, and Phase Angle of the signal.
Harmonics	Plots the signal amplitudes at the fundamental line frequency and its harmonics. Measures the RMS amplitude and Total Harmonic Distortion of the signal. Plots the Harmonics Bar Graph.
Input Capacitance	Measures the DUT input capacitance when powered on.
Inrush Current	Measures the positive and negative peak input current during DUT power-on.



**Note:** You should take the Input Capacitance and Inrush Current measurements independently. Input Capacitance and Inrush Current measurements use **Power Preset** to optimize the settings and trigger to measure the DUT power on signal, which may result in inaccurate measurements for other measurement types.

### Amplitude Analysis Measurements panel

Measurement	Description
Cycle Amplitude	The difference between the Top value and the Base value. Measurement can be made across the entire record or on each cycle in the record.
Cycle Top	The most common data point value above the midpoint of the waveform over the measurement region. This measurement is made on each cycle in the record.
Cycle Base	The most common data value below the midpoint of the waveform. This measurement is made on each cycle in the record.
Cycle Peak-to-Peak	The difference between the Maximum and Minimum values in the measurement region. This measurement is made on each cycle in the record.
Cycle Maximum	The maximum data point. This measurement is made on each cycle in the record.
Cycle Minimum	The minimum data point. This measurement is made on each cycle in the record.

### Timing Analysis Measurements panel

Measurement	Description
Period	The time between two adjacent crossings of the Mid reference level (one cycle) of the waveform. This measurement is taken on each cycle of the waveform record or measurement region.

Table continued...

Measurement	Description
Frequency	Frequency is the reciprocal of Period (Frequency = 1/Period). This measurement is made on each cycle in the record.
Positive Duty Cycle	The ratio of the positive-pulse width to the signal period. This measurement is taken on each cycle of the waveform record or measurement region.
Negative Duty Cycle	The ratio of the negative-pulse width to the signal period. This measurement is taken on each cycle of the waveform record or measurement region.
Positive Pulse Width	The time the signal remains above the Mid-reference level. This measurement is taken on each cycle of the waveform record or measurement region.
Negative Pulse Width	The time the signal remains below the Mid-reference level. This measurement is taken on each cycle of the waveform record or measurement region.



### Switching Analysis Measurements panel

Measurement	Description
Switching Loss	The mean instantaneous power and energy in the turn-on, turn-off, and conduction regions of a switching device. Provides the SWL trajectory plot.
dv/dt	The rate of change (slew rate) of the voltage, as it rises from the Base reference level ( $R_B$ ) to the Top reference level ( $R_T$ ), and as it falls from the Top reference level ( $R_T$ ) to the Base reference level ( $R_B$ ).
di/dt	The rate of change (slew rate) of the current, as it rises from the Base reference level ( $R_B$ ) to the Top reference level ( $R_T$ ), and as it falls from the Top reference level ( $R_T$ ) to the Base reference level ( $R_B$ ).
SOA	An X-Y plot of switching device voltage and current. The SOA mask testing provides pass/fail testing to component specifications.
$R_{DS(on)}$	The resistance (the slope of the V-I curve) when the switching device is conducting.

### Magnetic Analysis Measurements panel

Measurement	Description
Inductance	The integral of the voltage divided by the current of a magnetic component during circuit operation.
Magnetic Property	The B-H curve for a magnetic component during circuit operation.
Magnetic Loss	The average value of the product of the voltage and current through the inductor. This represents the total loss of the magnetic device and consists of resistive and eddy current losses during circuit operation.
I vs. $\int V$	The integral of voltage against current.

## Output Analysis Measurements panel

Measurement	Description
Line Ripple	The RMS and peak-to-peak values of the line frequency portion of the AC signal.  <b>Note:</b> RMS is measured at the configured ripple frequency.
Switching Ripple	The RMS and peak-to-peak values of the input signal.  <b>Note:</b> RMS is measured at the configured ripple frequency.
Efficiency	The ratio of output power to input power for a power conversion circuit.
Turn On Time	Measures the time from when the input voltage is applied to the DUT to the time when the output voltage reaches a steady level.
Turn Off Time	Measures the time from when the input voltage is removed from the DUT to the time when the output voltage reaches a zero level.



**Note:** You should take the Turn On Time and Turn Off Time measurements independently. Turn On Time and Turn Off Time measurements use the **Power Preset** function to optimize the settings and trigger to measure the DUT power-on signal, which may result in inaccurate measurements for other measurement types.



**Note:** If you save a session file that includes power measurements, make sure to recall (load) the session file into an instrument with the same number of channels that was used to create the session file.

## Frequency Response Analysis (FRA) Measurements panel

Measurement	Description
Control Loop Response (Bode)	Plots the gain as $20 \log (V_{out}/V_{in})$ and phase difference between $V_{in}$ and $V_{out}$ at each frequency within the swept band. The resulting plot is commonly referred to as a Bode Plot.
Power Supply Rejection Ratio	Measures both the modulated input and output AC voltage levels and plots the rejection ratio as $20 \log (V_{in}/V_{out})$ at each frequency within the specified band.
Impedance	Computes and plots the channel ratio ( $V_{out}/V_{in}$ ) at each frequency within the swept band. The impedance curve displays maximum annotations of 3 peaks, if they are available only.  <b>Note:</b> It is recommended to use a splitter with the built-in AFG source for Impedance measurements. If you use an external AFG, use a single channel with a splitter.



**Note:** By default on selecting Preset, Spectral Averaging for the configured channel is set to Average mode with number 2. The Acquisition mode will be in Sample mode with RUN. For FRA measurements, on Preset in Auto RBW, Spectrum View is set to Average trace of two samples. The Acquisition mode is set to sample in RUN/STOP.



**Note:** After Preset, you can un-check Spectrum View Average and retain Normal trace. After selecting the Scope RUN function, the Acquisition mode will be set to Single Sequence. In Single SEQ, there may be a minor flicker on the plot update.

### See also

[Power measurement configuration menu overview](#) on page 238

## The IMDA tab

The IMDA tab lists the IMDA-related measurements that you can add to the Results bar. IMDA measurements include electrical analysis, switching analysis, and output analysis.

To open the IMDA Measurements tab:

1. Tap the **Add New... Measure** button.
2. Tap the **IMDA** tab.



**Note:** IMDA tab is available only for 5 and 6 Series Oscilloscopes. The 3-Phase tab is available for 4 Series Oscilloscopes.

To add a measurement to the Results bar:

1. Tap a measurement panel:
2. Select the measurement.

[Electrical Analysis Measurements panel](#) on page 203

[Mechanical Analysis Measurements panel](#) on page 203

3. Tap **Add**. You can also double-tap a measurement to add it to the Results bar.

### Electrical Analysis Measurements panel

Measurement	Description
<b>Power Quality</b>	Measures the operating Frequency, RMS values of the voltage and current, Crest Factors of the voltage and current, Real Power, Reactive Power, Apparent Power, Power Factor, and Phase Angle of the AC signal. Plots the Phasor diagram and Acq Trend.
<b>Harmonics</b>	Measures the signal amplitudes at the fundamental line frequency and its harmonics. Measures the RMS amplitude and Total Harmonic Distortion of the signal. Plots the Harmonics Bar Graph and Acq Trend.
<b>Ripple</b>	The RMS and peak-to-peak values of the 3-Phase signal.
<b>Efficiency</b>	Measures the ratio of output power to input power per phase for a AC/DC input and AC/DC Drive output. Measures the total efficiency of the system. Plots the Acq Trend.
<b>DQ0</b>	Transforms three-phase AC (Voltage or Current) time domain waveforms into DC signals and are graphically represented as vectors on a phasor plot.   <b>Note:</b> Supported only when 3V3I wiring is selected.

### Mechanical Analysis Measurements panel

Measurement	Description
<b>Speed, Acceleration</b>	Measures the speed and acceleration.  Plots the Acq Trend, Time Trend, and Histogram.  Speed defines the number of revolutions per minute of the motor.  Acceleration is defined as the speed difference computed per time at each speed value.

Table continued...

Measurement	Description
<b>Direction</b>	<p>Defines the direction of rotation of the motor. Set the direction A-B-C or A-C-B for Hall sensors and CW or CCW for QEI based on the motor configuration.</p> <p>Plots the Acq Trend and Time Trend.</p>
<b>Angle</b>	<p>Measures the phase angle. Configure QEI or Hall sensor to compute the angle measurement.</p> <p>For QEI, set the number of Pulses per Rotation (PPR).</p> <p>For Hall Sensor, set the number of Pole pairs.</p> <p>Plots the Time Trend.</p>
<b>Torque</b>	<p>Measures the torque of the motor. Configure Sensor (analog) or Current method to measure the torque.</p> <p>Plots the Acq Trend, Time Trend, and Histogram.</p> <p>If you want to measure torque over a long range, ensure that the vertical scale is properly set. If the vertical scale or horizontal scale needs to be updated, Acq Trend plot gets reset.</p>
<b>Mechanical Power</b>	<p>Measures the mechanical power of the motor drive system. It is determined by the Speed and Torque. It is measured in watts.</p> <p>IMDA supports different sensor types to measure torque, speed, and angular position of the motor. Mechanical power generated at the output of the motor is computed as a product of motor measured speed and torque values.</p>
<b>System Efficiency</b>	<p>Measures the total efficiency of the motor drive system.</p> <p>System Efficiency is also known as Electro-Mechanical efficiency. It indicates how much electrical energy is converted to mechanical energy. It is measured as the ratio of mechanical power to the input electrical power.</p>

**See also**

[IMDA measurement configuration menu overview](#) on page 262

**The DPM tab**

The DPM tab lists the optional DPM-related (Digital Power Management) measurements that you can add to the Results bar. DPM measurements include ripple analysis, transient analysis, power sequence analysis, jitter and eye analysis.

Power rail probes are recommended for DPM measurements. For turn on time and turn off time measurements, optional to use passive probe at the input voltage and recommended to power rail probes at the output side. The power rail probe is recommended because it takes care of the DC rail output voltage offset and measurement results will be precise.

To open the DPM Measurements tab:

1. Tap the **Add New... Measure** button.
2. Tap the **DPM** tab.

To add a measurement to the Results bar:

1. Tap a measurement panel:
  - [Ripple Analysis Measurements panel](#) on page 205
  - [Transient Analysis Measurements panel](#) on page 205



[Power Sequence Analysis Measurements panel](#) on page 205

[Power Integrity - Signal Integrity Analysis Measurement panel](#) on page 206

2. Select the measurement.
3. Select the number of rails in the **Power Rails** field.
4. Tap **Add**. You can also double-tap a measurement to add it to the Results bar.

### Ripple Analysis Measurements panel

Measurement	Description
Ripple	Measures RMS and peak-to-peak values of the 3-Phase signal on the DC Rail. RMS is measured at the configured ripple frequency.

### Transient Analysis Measurements panel

Measurement	Description
Overshoot	Overshoot is the difference between Maximum and Top, divided by the Amplitude. This measurement can be made across the entire record or on each cycle in the record.
Undershoot	Undershoot is the difference between Minimum and Base, divided by the Amplitude. This measurement can be made across the entire record or on each cycle in the record.
Turn on Overshoot	Turn on Overshoot computes the maximum amplitude value of the dc rail output voltage during turn ON of the DUT. This supports multiple rail outputs. User has to provide input signal level to trigger properly and measurement happens on output rail. Annotation of max value on the output is shown as cross hair per rail output.
DC Rail Voltage	DC Rail Voltage is the mean value of each rail output. This can be performed per cycle or for the entire record. In cycle mode, the user can specify Edge qualifier as the source to find edges. Annotation and navigation available in cycle mode. One can traverse in navigation mode using Prev and Next buttons.

### Power Sequence Analysis Measurements panel

Measurement	Description
Turn On Time	Measures the time delay difference between the input voltage applied to the system and the time to develop the steady state output voltage.
Turn Off Time	Measures the time delay difference between the input voltage removed from the system and the time for the output voltage to become zero.

### Jitter Analysis Measurements panel

Measurement	Description
TIE	TIE (Time Interval Error) is the difference in time between an edge in the source waveform and the corresponding edge in a reference clock. The reference clock is usually determined by a clock recovery process performed on the source waveform. For Explicit-Clock clock recovery, the process is performed on an explicitly identified source. User can specify the jitter frequency and BW limit for each rail in the measurement configuration. The measurement supports Spectrum, Eye diagram and Histogram plots per rail.

Table continued...

Measurement	Description
RJ	Random Jitter (RJ) is the rms magnitude of all timing errors not exhibiting deterministic behavior. A single RJ value is determined for each acquisition, by means of RJ-DJ separation analysis. User can specify the jitter frequency and BW limit for each rail in the measurement configuration. The measurement supports Eye diagram and Histogram plots per rail.
DJ	Deterministic Jitter (DJ) is the peak-to-peak amplitude for all timing errors that follow deterministic behavior. A single DJ value is determined for each acquisition, by means of RJ-DJ separation analysis. User can specify the jitter frequency and BW limit for each rail in the measurement configuration. The measurement supports Eye diagram and Histogram plots per rail.
PJ	Periodic Jitter (PJ) is the peak-to-peak amplitude for that portion of the deterministic jitter which is periodic, but for which the period is not correlated with any data pattern in the waveform. A single PJ value is determined for each acquisition, by means of RJ-DJ separation analysis. User can specify the jitter frequency and BW limit for each rail in the measurement configuration. The measurement supports Eye diagram and Histogram plots per rail.
EYEHEIGHT	Eye Height is the minimum vertical eye opening at the mid of the unit interval. This measurement is made across the entire record. User can specify the jitter frequency for each rail in the measurement configuration. The measurement supports Eye diagram and Histogram plots per rail.
EYEWIDTH	Eye Width is the minimum horizontal eye opening at the user-specified reference level. This measurement is made across the entire record. User can specify the jitter frequency and BW limit for each rail in the measurement configuration. The measurement supports Eye diagram and Histogram plots per rail.
EYEHIGH	Eye High calculates the voltage at a selected horizontal position across the unit interval, for all High bits in the waveform. Configure the measurement to include all bits, only transition bits, or only non-transition bits. A histogram of the Eye High measurement corresponds to a vertical slice through the upper half of a three-dimensional eye diagram. User can specify the jitter frequency and BW limit for each rail in the measurement configuration. The measurement supports Eye diagram and Histogram plots per rail.
EYELOW	Eye Low calculates the voltage at the selected horizontal position across the unit interval, for all Low bits in the waveform. A histogram of the Eye Low measurement corresponds to a vertical slice through the lower half of a three-dimensional eye diagram. User can specify the jitter frequency and BW limit for each rail in the measurement configuration. The measurement supports Eye diagram and Histogram plots per rail.

### Power Integrity - Signal Integrity Analysis Measurement panel

Measurement	Description
PSIJ	PSIJ measurement correlates the PJ component in High Speed Signals (Victim) with Power Supply (Aggressor) output waveform using jitter suppression technique. Jitter suppression filters out the specified frequencies from the victim signal which were induced from power rail signal.  Configure Notch Filter with the required center frequency that needs to be removed. It is recommended to run PSIJ measurement with constant clock recovery method.

#### See also

[Configure panel \(DPM measurement configuration menu\)](#) on page 278

## The DDR measurements tab

The DDR tab lists the optional double data rate (DDR) measurements that you can add to the Results bar. DDR measurements include amplitude and timing analysis.

To open the DDR Measurements tab and add a measurement to the Results bar:

1. Tap the **Add New... Measure** button.
2. Tap the **DDR** tab.

To add a measurement to the Results bar:

1. Select the signal source/s.
2. Tap a measurement panel:
  - [Amplitude Analysis measurement panel](#)
  - [Timing Analysis measurement panel](#)
3. Select a measurement. If the measurement requires two signal sources, select the sources in the **Source 1** and **Source 2** fields.
4. Tap **Add**. You can also double-tap a measurement to add it to the Results bar.

### Amplitude Measurements panel

Measurement	Description
AOS	The total area of the signal above the specified reference level.
AUS	The total area of the signal below the specified reference level.
Vix(ac)	The differential input cross-point voltage measured from the actual crossover voltage and its complement signal to a designated reference voltage. This is measured on a single ended signal.
AOS Per tCK	The total area of the signal that crosses the specified reference level calculated over consecutive periods. It is applicable to clock and address/command waveforms only.
AUS Per tCK	The total area of the signal that crosses the specified reference level calculated over consecutive periods. It is applicable to clock and address/command waveforms only.
AOS Per UI	The total area of the signal that crosses the specified reference level calculated over consecutive unit intervals. It is applicable to data and data strobe waveforms only.
AUS Per UI	The total area of the signal that crosses the specified reference level calculated over consecutive unit intervals. It is applicable to data and data strobe waveforms only.

### Timing Measurements panel

Measurement	Description
tRPRE	The width of the Read burst preamble. This is measured from the exit of tristate to the first driving edge of the differential strobe.
tWPRE	The width of the Write burst preamble. It is measured from the exit of tristate to the first driving edge of the differential strobe.
tPST	The width of Read or Write burst' postamble. It is measured from the last falling edge crossing the mid reference level to the start of an undriven state (as measured by a rising trend per JEDEC specification).

Table continued...

Measurement	Description
<b>Hold Diff</b>	The elapsed time between the designated edge of the single ended waveform and the designated edge of a differential waveform.  The measurement uses the closest single ended waveform edge to the differential waveform edge that falls within the range limits.
<b>Setup Diff</b>	The elapsed time between the designated edge of a single ended waveform and when the differential waveform crosses its own voltage reference level.  The measurement uses the closest single ended waveform edge to the differential waveform edge that falls within the range limits.
<b>tCH(avg)</b>	The average high pulse width calculated across a sliding 200 cycle window of consecutive high pulses.
<b>tCK(avg)</b>	The average clock period across a sliding 200-cycle window.
<b>tCL(avg)</b>	The average low pulse width calculated across a sliding 200 cycle window of consecutive low pulses.
<b>tCH(abs)</b>	The high pulse width of the differential clock signal. It is the amount of time the waveform remains above the mid reference voltage level.
<b>tCL(abs)</b>	The low pulse width of the differential clock signal. It is the amount of time the waveform remains below the mid reference voltage level.
<b>tJIT(duty)</b>	The largest elapsed time between tCH and tCH(avg) or tCL and tCL(avg) for a 200-cycle window.
<b>tJIT(per)</b>	The largest elapsed time between tCK and tCK(avg) for a 200-cycle sliding window.
<b>tJIT(cc)</b>	The absolute difference in clock period between two consecutive clock cycles.
<b>tERR(n)</b>	The cumulative error across multiple consecutive cycles from tCK(avg). It measures time difference between the sum of clock period for a 200-cycle window to n times tCK(avg).
<b>tERR(m-n)</b>	The cumulative error across multiple consecutive cycles from tCK(avg). It measures the time difference between the sum of clock periods for a 200-cycle window to n times tCK(avg).
<b>tDQSCK</b>	The strobe output access time from the differential clock. It is measured between the rising edge of the clock before or after the differential strobe Read preamble time. The edge locations are determined by the mid-reference voltage levels.
<b>tCMD-CMD</b>	The elapsed time between two logic states.
<b>tCKSRE</b>	The valid clock cycles required after Self Refresh Entry (SRE) command. Changing the input clock frequency or the supply voltage is permissible only after tCKSRE time when the SRE command is registered.
<b>tCKSRX</b>	The valid clock cycles required before the Self Refresh Exit (SRX) command. Changing the input clock frequency or the supply voltage is permissible provided the new clock frequency or supply voltage is stable for the tCKSRX time prior to SRX command.

**See also**

[DDR measurement configuration menu overview](#) on page 285

**The WBG-DPT tab**

The WBG-DPT tab lists the optional WBG-DPT-related measurements that you can add to the Results bar. WBG-DPT measurements include switching parameter analysis, switching timing analysis, and diode recovery analysis. The WBG-DPT measurements are supported for 4/5/6 Series oscilloscopes.

To open the WBG-DPT Measurement tab:

1. Tap the **Add New... Measure** button.
2. Tap the **WBG-DPT** tab.

To add a measurement to the Results bar:

1. Select the sources in the **Source** fields as per the measurement requirement. Example: if the measurement requires three signal sources, select the sources in the Source 1, Source 2, and Source 3 fields.
2. Select the **Power Device** as **MOSFET** or **IGBT**.
3. Tap a measurement panel:
  - [Switching Parameter Analysis measurements panel](#) on page 209
  - [Switching Timing Analysis measurements panel](#) on page 209
  - [Diode Recovery Analysis measurements panel](#) on page 209
  - [Capacitance Analysis measurements panel](#) on page 210
4. Select the measurement.
5. Tap **Add**. You can also double-tap a measurement to add it to the Results bar.

### Switching Parameter Analysis measurements panel

Measurement	Description
<b>Eon</b>	Measures the energy dissipated in the Power Device during on region using the configured levels.
<b>Eoff</b>	Measures the energy dissipated in the Power Device during off region using the configured levels.
<b>Vpeak</b>	Measures the peak voltage of the Power Device in the off region.
<b>Ipeak</b>	Measures the peak current of the Power Device in the on region.

### Switching Timing Analysis measurements panel

Measurement	Description
<b>Td(on)</b>	Measures the turn on delay time of the Power Device in the on region using the configured levels.
<b>Td(off)</b>	Measures the turn off delay time of the Power Device in the off region using the configured levels.
<b>Tr</b>	Measures the rise time of the Power Device in the on region using the configured levels.
<b>Tf</b>	Measures the fall time of the Power Device in the off region using the configured levels.
<b>Ton</b>	Measures the turn on time of the Power Device. It is the sum of the turn on delay time and the rise time.
<b>Toff</b>	Measures the turn off time of the Power Device. It is the sum of the turn off delay time and the fall time.
<b>d/dt</b>	Measures the rate of change of voltage or current (slew rate) from the configured start level to the stop level.

### Diode Recovery Analysis measurements panel

Measurement	Description
<b>Trr</b>	Measures the reverse recovery time of the Power Device using the configured levels.
<b>Qrr</b>	Measures the reverse recovery charge in the Power Device using the configured levels.
<b>Err</b>	Measures the reverse recovery energy dissipated in the Power Device using the configured levels.
<b>Irrm</b>	Measures the maximum current dissipated in the Power Device in the reverse recovery region.

Table continued...

Measurement	Description
Diode d/dt	Measures the rate of change of voltage or current (slew rate) during the specified start and stop integration levels. Diode d/dt can be measured during rising or falling edge.

### Capacitance Analysis measurements panel

Measurement	Description
Qoss	The output charge Qoss of Wide Band Gap (WBG) device is the charge that must be supplied to the parasitic output capacitances of a Power Device during each switching cycle.

### See also

[WBG-DPT measurement configuration menu overview](#) on page 288

## Measurement configuration menu overview

Use this configuration menu to add statistics to a measurement badge readout, plot a measurement, and change measurement settings including source, scope (global or local), reference levels, gating, clock recovery, bandwidth filters, results limits, and pass/fail testing.

To open a Measurement configuration menu for a measurement, double-tap a Measurement badge in the Results bar. The configuration menu and panels only show fields and controls relevant to the selected measurement.

The menu opens on the measurement name panel (the name of the measurement), which provides controls to display additional statistics to the measurement badge, display plots of the measurement, and so on. The content of the measurement name panel depends on the measurement. The most common Measurement Name fields are listed in the following table.

### Measurement configuration menu fields, controls, and panels

Field, control, or panel	Description
<b>Measurement Statistics</b> (Measurement name panel)	A list of measurement statistics related to the measurement. You can add these statistics to a measurement badge by selecting the <b>Show Statistics in Badge</b> control.
<b>Show Statistics in Badge</b> (Measurement name panel)	Adds the listed statistical measurement readouts to the measurement badge readout.
<b>Plots</b> (Measurement name panel)	Buttons that open Plot views of the measurement. Available plots depend on the measurement. Plot types include Time Trend, Histogram, Spectrum, and Eye Diagram (for jitter measurements). To add a plot to the screen, tap the plot button.  See <a href="#">Add Plot configuration menu</a> on page 336.
<b>Configure panel</b>	Sets the source, label text, and other fields that are specific to each measurement type.  See <a href="#">Configure panel (Measurement configuration menu)</a> on page 212.
<b>Reference Levels panel</b>	Sets the reference levels and units used to take measurements, the scope of the reference level settings (global or local), and the method used to calculate the Top and Base waveform values.  See <a href="#">Reference Levels panel (Measurement configuration menu)</a> on page 212.

Table continued...

Field, control, or panel	Description
<b>Clock Recovery panel</b> (jitter measurements)	Sets the clock recovery settings for some jitter measurements. See <a href="#">Clock Recovery panel (Measurement configuration menu)</a> on page 214.
<b>Gating panel</b>	Sets the measurement region (gate) used to take measurements. Select the scope of the gate setting (global or local), and the type of gating to use. See <a href="#">Gating panel (Measurement configuration menu)</a> on page 218.
<b>Filter/Limit Results panel</b>	Sets the scope of the filtering setting (global or local), high and low pass filter settings, the range of measurement result limits, and the limit measurement population size. See <a href="#">Filter/Limit Results panel (Measurement Settings menu)</a> on page 220.
<b>Pass/Fail Testing panel</b>	Sets the conditions for pass/fail testing for measurements and sets actions to take when a measurement fails. See <a href="#">Pass/Fail Testing panel (Measurement Settings menu)</a> on page 221.

## Measurement Name panel (Measurement configuration menu)

The Measurement Name panel (the name of the measurement) provides controls for adding display statistics to the measurement badge and opening plots of the measurement.

To open the measurement name panel, double-tap a Measurement badge. This is the default panel shown when you open a Measurement settings menu.

The content of the Measurement Name panel depends on the measurement.

Field or control	Description
<b>Measurement Statistics</b>	A list of measurement statistics. You can add these statistics to a measurement badge by selecting the <b>Show Statistics in Badge</b> control.
<b>Show Statistics in Badge</b>	Select to add the listed statistical measurement readouts to the measurement badge.
<b>Plots</b>	Adds a Plot view of the measurement value to the screen. Available plots depend on the measurement. Plot types include Time Trend, Histogram, Spectrum, and Eye Diagram (for jitter measurements).  Trend adds the trend plot to the Waveform view.

### See also

[Configure panel \(Measurement configuration menu\)](#) on page 212

[Reference Levels panel \(Measurement configuration menu\)](#) on page 212

[Clock Recovery panel \(Measurement configuration menu\)](#) on page 214

[Gating panel \(Measurement configuration menu\)](#) on page 218

[Filter/Limit Results panel \(Measurement Settings menu\)](#) on page 220

[Pass/Fail Testing panel \(Measurement Settings menu\)](#) on page 221

## Configure panel (Measurement configuration menu)

Use the Configure panel to set the measurement source(s), add a custom name (label) for the measurement, and other parameters.

To open the Configure panel:

1. Double-tap a Measurement badge to open the Measurement configuration menu.
2. Tap the **Configure** panel.

Not all items listed are shown for all measurements; The panel only shows fields and controls relevant to the selected measurement.

Field or control	Description
<b>Source</b>	Sets the signal source used to take the measurement. Tap the field to show the list of available sources. If the measurement requires more than one source, multiple Source fields are displayed.
<b>Label</b>	Sets the name of the measurement. You can use the default name, or double-tap in the field and change the label using a connected keyboard or the virtual keyboard.
<b>Signal Type</b>	Sets the signal type (Clock, Data, Auto) of the source signal for some measurements.
<b>Edge, Clock edge</b>	Sets the edge of the signal to use for starting the measurement.
<b>From Edge</b>	Sets the Source 1 waveform edge on which to start the measurement, for two-source measurements.
<b>To Edge</b>	Sets the Source 2 waveform edge on which to stop the measurement, for two-source measurements.
<b>Calculate One Measurement Per</b>	Sets the amount of waveform data to use to calculate one measurement; one measurement across the entire waveform record or one measurement for each cycle of the waveform in the record.
<b>Pattern Detection</b>	Auto attempts to detect the type of pattern and set
<b>Pattern Type</b>	Sets whether the source signal data is a Repeating pattern or an Arbitrary pattern type.
<b>Pattern Length</b>	Sets the pattern length to use when Pattern Type = Repeating.
<b>Window Length</b>	Sets the overall window length to use when Pattern Type = Arbitrary.

### Other measurement panels

[Measurement Name panel \(Measurement configuration menu\)](#) on page 211

[Reference Levels panel \(Measurement configuration menu\)](#) on page 212

[Clock Recovery panel \(Measurement configuration menu\)](#) on page 214

[Clock Recovery- Advanced Settings configuration menu](#) on page 217

[Gating panel \(Measurement configuration menu\)](#) on page 218

[Filter/Limit Results panel \(Measurement Settings menu\)](#) on page 220

[Pass/Fail Testing panel \(Measurement Settings menu\)](#) on page 221

## Reference Levels panel (Measurement configuration menu)

Use the Reference Levels panel to set the scope of the reference level settings (global or local), the reference levels (High, Mid, and Low), the units used to take measurements, and the method used to calculate the Top and Base waveform values. You can set the levels to be the same or different for rising and falling edges.

To open the Reference Levels panel:

1. Double-tap a Measurement badge.
2. Tap the **Reference Levels** panel.



## Reference Levels panel- fields and controls

Not all items listed in the table are shown for all measurements; The panel only shows fields and controls relevant to the selected measurement.

Field or control	Description
<b>Reference Levels</b>	<p>Global sets whether the reference levels defined in this measurement apply to all measurements that are set to global (the default setting).</p> <p>Local sets the Reference Level parameters to apply to just this measurement.</p>
<b>Source</b>	Lists the source signals used for each edge of the measurement.
<b>Set Levels In</b>	Sets the method used to set or calculate the High, Mid, and Low reference levels. Select % or Units and use the Multipurpose Knob to set custom reference values.
<b>Levels</b>	<p>Sets the reference levels as specified percentages of the Top and Base waveform measurement.</p> <p>To set custom reference values, tap <b>Custom</b>, tap a setting field, and use the Multipurpose Knob to set the different % (relative) or absolute values.</p> <p><b>High</b> and <b>Low</b> references are used to calculate rise and fall times. The default High reference is 90% and Low reference is 10%.</p> <p><b>Mid</b> reference is primarily used for measurements between edges such as pulse widths. The default level is 50%.</p>
<b>Base Top Method</b>	<p>Sets the method to calculate the waveform Base and Top values, which is then used to calculate the High, Mid, and Low reference levels.</p> <p><b>Auto</b> is the default method, and automatically determines the best Base Top method to use. Most commonly sets the Top Base method to Histogram Mode.</p> <p><b>MinMax</b> Uses the minimum and maximum values in the waveform record to determine the base and top amplitude. Useful on a waveform with low noise and free from excessive overshoot.</p> <p><b>Histogram Mean</b> uses histogram analysis to calculate the mean or average value using all values above and below the waveform midpoint. Top is set to the mean high value, and Base is set to the mean low value.</p> <p><b>Histogram Mode</b> uses histogram analysis to calculate the most common values above and below the waveform midpoint. Top is set to the common high value, and Base is set to the common low value.</p> <p><b>Histogram Eye Center</b> uses histogram analysis to determine the base top amplitude. Creates a histogram of the amplitudes in the center of each bit (unit interval) while ignoring the waveform during bit transitions. The histogram should have a peak at the nominal high level and another peak at the nominal low level.</p> <p> <b>Note:</b> If you set the Base Top Method to other than Auto, and do not change the Reference Levels mode to Local, many existing measurements, as well as measurements that you add to the Results bar, will use the new Base Top Method values for taking measurements. This may result in measurement values that you are not expecting.</p>
<b>Hysteresis</b>	Sets the threshold margin to the reference level which the signal must cross to be recognized as changing; the margin is the relative reference level plus or minus half the hysteresis. Use hysteresis to filter out spurious events. Tap the field and use the Multipurpose Knob to change the value.

## Other measurement settings panels

[Measurement Name panel \(Measurement configuration menu\)](#) on page 211

[Configure panel \(Measurement configuration menu\)](#) on page 212

[Clock Recovery panel \(Measurement configuration menu\)](#) on page 214

[Clock Recovery- Advanced Settings configuration menu](#) on page 217

[Gating panel \(Measurement configuration menu\)](#) on page 218

[Filter/Limit Results panel \(Measurement Settings menu\)](#) on page 220

[Pass/Fail Testing panel \(Measurement Settings menu\)](#) on page 221

## Clock Recovery panel (Measurement configuration menu)

Clock recovery refers to the process of establishing a reference clock, the edges of which can be used as a basis for timing comparisons. Use the Clock Recovery panel to configure the clock recovery settings for measurements that require a clock signal.

To access the Clock Recovery panel:

1. Double-tap a Measurement badge on the Results bar that uses clock recovery (such as jitter measurements), to open the Meas configuration menu.
2. Tap the **Clock Recovery** panel.

### Measurement configuration menu, Clock Recovery panel

Field or control	Description
<b>Clock Recovery</b>	<p><b>Global</b> sets whether the Clock Recovery settings defined in this panel apply to all measurements with clock recovery settings that are set to global (the default setting).</p> <p><b>Local</b> sets the Clock Recovery parameters to apply to just this measurement.</p>
<b>Method</b>	<p><b>PLL</b> simulates the behavior of the specified hardware Phase Locked Loop clock recovery circuit to derive the clock signal.</p> <p><b>Constant Clock</b> uses linear regression so that the recovered clock minimizes the mean squared sum of the Time Interval Error (TIE) for that waveform.</p> <p><b>Explicit Clock</b> derives the reference clock from a specified channel other than the one upon which the measurement is defined.</p>
<b>Standard</b>	<p>Sets the standard to use for the PLL model. Information for a selected standard is listed under the drop-down list.</p> <p>Available only when <b>Method</b> is <b>PLL</b>.</p>

Table continued...

Field or control	Description
<b>Mode</b>	<p><b>Mean</b> chooses both the frequency and the phase to minimize the mean squared error. Available when <b>Method</b> is <b>Constant Clock</b>.</p> <p><b>Median</b> chooses the phase so that the median error between the recovered and measured edges is zero. Available when <b>Method</b> is <b>Constant Clock</b>.</p> <p><b>Fixed</b> uses the specified frequency but chooses the phase so that the median error between the recovered and measured edges is zero. Available when <b>Method</b> is <b>Constant Clock</b>.</p> <p><b>Select Explicit Clock-Edge</b> method if you want to use the edges found in the selected clock source (possibly multiplied up by an integral number). If the Clock Multiplier is set to 1 (the default), only these edges will be used. If the Clock Multiplier is set to a number N other than 1, linear interpolation will be used between each pair of actual edges to create N-1 additional reference edges. The interpolated edge times, combined with the actual edges, give a total of N reference edge times per actual edge. Available when <b>Method</b> is <b>Explicit Clock</b>.</p> <p><b>Select Explicit Clock-PLL</b> as the clock recovery method if you want to feed the edges from the selected clock source through a PLL rather than using them directly. The actual edges from the clock source will be used to drive a software PLL model, and the edge times coming out of the PLL will be used as the reference edges for the target measurement. If the Clock Multiplier is set to a number N other than 1, the output of the PLL will have N edges per actual edge. Only available when <b>Method</b> is <b>Explicit Clock</b>.</p>
<b>Calculate On</b>	<p><b>First Acq.</b> sets the clock-recovery algorithm to choose a new best-fit clock frequency and phase on just the first acquisition. Subsequent acquisitions will choose a best fit on clock phase but retain the clock frequency found in the first acquisition.</p> <p><b>Every Acq.</b> the clock-recovery algorithm to choose a new best-fit clock frequency and phase for each new oscilloscope acquisition.</p> <p>Clearing the measurement results will reset the clock recovery so that both frequency and phase are optimized on the subsequent acquisition.</p> <p>Available when <b>Method</b> is <b>Constant Clock</b> and <b>Mode</b> is <b>Mean</b> or <b>Median</b>.</p>
<b>Clock Frequency</b>	<p>Sets the clock frequency to use in Fixed mode. The clock in the waveform is ignored; the instrument uses the specified frequency, with the clock phase determined by best fit.</p> <p> <b>Note:</b> This method typically results in a closed eye.</p> <p>Available when <b>Method</b> is <b>Constant Clock</b> and <b>Mode</b> is <b>Fixed</b>.</p>
<b>Loop BW</b>	<p>Sets the PLL loop bandwidth. Displays the Closed Loop bandwidth that has been configured based on the current standard.</p> <p>Available when <b>Method</b> is <b>PLL</b>.</p>
<b>Clock Source</b>	<p>Sets the source for the explicit clock.</p> <p>Available when <b>Method</b> is <b>Explicit Clock</b>.</p>
<b>Clock Edge</b>	<p>Set whether the rising, falling or both edges of the clock source should be considered.</p> <p>Available when <b>Method</b> is <b>Explicit Clock</b>.</p>

Table continued...

Field or control	Description
<b>Clock Multiplier</b>	<p>Set the number of edges to be used.</p> <p>If the Clock Multiplier is set to 1 (the default), only these edges will be used. If the Clock Multiplier is set to a number N other than 1, linear interpolation will be used between each pair of actual edges to create N-1 additional reference edges. The interpolated edge times, combined with the actual edges, give a total of N reference edge times per actual edge.</p> <p>Available when <b>Method</b> is <b>Explicit Clock</b>.</p>
<b>Clock Offset</b>	<p>Set to <b>Auto</b> or <b>Manual</b>.</p>
<b>Offset</b>	<p>Sets the clock offset amount relative to data.</p> <p>To compare the reference clock times to the edge times from the data source, some assumptions must be made about how they align. The default assumption is that each data source edge is associated with the reference clock edge to which it is nearest in time. This assumption may not be optimum, for example if the probes for the reference clock and data signal have different cable lengths.</p> <p>Available when <b>Clock Offset</b> is <b>Manual</b>.</p>
<b>PLL Model</b>	<p>Select the PLL model type. The PLL control area provides control over the phase-locked loop used for clock recovery. You can choose the loop bandwidth and the loop order, and if a Type II loop is chosen, you can specify the damping factor.</p> <p>To set the loop bandwidth automatically, based on a serial standard, select PLL: Standard BW as the clock recovery method. From the Standard: b/s list box, select the standard that matches your data link. For example, choose "PCI-E: 2.5" to test a 2.5 Gbit/second PCI Express link. In this case, the PLL bandwidth will be set to 1.5 MHz, which is 1/1667 of the baud rate as specified in PCI Express standard.</p> <p>You can use the PLL Model list box to choose between Type I and Type II loop. A Type I loop has a transfer function that approaches zero frequency with a slope of 1/s and a Type II loop approaches zero frequency with a 1/s<sup>2</sup> slope (In much of the PLL literature, these terms are used interchangeably with First-Order and Second-Order loops. For a thorough discussion of loop type versus order, see Frequency Synthesis by Phase Lock, by William Egan).</p> <p>Available when <b>Method</b> is <b>Explicit Clock</b> and <b>Mode</b> is <b>Explicit Clock - PLL</b>.</p>
<b>JTF BW</b>	<p>Displays or sets the Jitter Transfer Function bandwidth that has been configured based on the current standard.</p> <p>Available when <b>Method</b> is <b>Explicit Clock</b> and <b>Mode</b> is <b>Explicit Clock - PLL</b> and <b>PLL Model</b> is <b>Type II</b>.</p>
<b>Damping</b>	<p>Sets the damping factor for the PLL. It is enabled only for Type II phase-locked loop.</p> <p>Available when <b>Method</b> is <b>Explicit Clock</b> and <b>Mode</b> is <b>Explicit Clock - PLL</b> and <b>PLL Model</b> is <b>Type II</b>.</p>
<b>Automatic Transition Density Compensation</b>	<p>Toggles the automatic transition density compensation to <b>On</b> or <b>Off</b>. By default it is <b>Off</b>.</p> <p>When on, the loop feedback time constants are adjusted to make the actual transfer function more closely match a mathematical filter polynomial. When off, the clock recovery algorithm is configured for an assumed 50% transition density.</p> <p>Available when <b>Method</b> is <b>PLL</b> or <b>Explicit clock</b> and <b>Mode</b> is <b>Explicit Clock-PLL</b>.</p>

Table continued...

Field or control	Description
<b>Advanced</b>	<p>Opens the Clock Recovery-Advanced Settings configuration menu to refine the recovered clock signal. See <a href="#">Clock Recovery- Advanced Settings configuration menu</a> on page 217.</p> <p>Available when <b>Method</b> is <b>PLL</b>.</p>

## About constant clock recovery

In Constant Clock Recovery, the clock is assumed to be of the form  $A \sin(2\pi ft + \text{phase})$ , where the frequency (f) and phase are treated as unknown constants. Once a source waveform has been acquired and the edges extracted, one or both of these constants are determined using linear regression, so that the recovered clock minimizes the mean squared sum of the Time Interval Error (TIE) for that waveform.

## About PLL loop BW versus JTF BW

Phase locked loops are characterized according to their bandwidth (BW), and several different bandwidths are commonly used. The terminology used for these bandwidths is described here, since it varies somewhat across different industries.

- Loop BW (or Closed Loop BW) is the frequency at which the closed-loop gain has fallen to -3 dB (half power) relative to unity-gain. The closed-loop gain function has the character of a low-pass filter.
- JTF BW (Jitter Transfer Function BW or Error Function BW) is the frequency below which input jitter to a tracking loop is removed. The JTF BW has a high-pass filter characteristic.

For Type I loops, the Loop BW and the JTF BW are always equal. For Type II loops, these two bandwidths are different, and their ratio depends on the PLL damping factor. You can choose to specify either bandwidth, and the other is displayed for reference.

## PLL-based clock recovery

PLL-based clock recovery is implemented using a software model of a hardware PLL circuit, sequentially processing waveform transitions and adjusting the clock period in a feedback loop. This approach means that the transition density of the input signal has subtle effects on the effective bandwidth and damping factor of the feedback loop, just as it does with actual hardware PLLs. The influence of transition density is only relevant for data signals, since clock signals (or data signals with a two bit pattern) have 100% transition density.

## Other measurement settings panels

[Measurement Name panel \(Measurement configuration menu\)](#) on page 211

[Configure panel \(Measurement configuration menu\)](#) on page 212

[Reference Levels panel \(Measurement configuration menu\)](#) on page 212

[Clock Recovery- Advanced Settings configuration menu](#) on page 217

[Gating panel \(Measurement configuration menu\)](#) on page 218

[Filter/Limit Results panel \(Measurement Settings menu\)](#) on page 220

[Pass/Fail Testing panel \(Measurement Settings menu\)](#) on page 221

## Clock Recovery- Advanced Settings configuration menu

Sets advanced clock recovery settings such as defining a nominal data rate or basing clock recovery on a known data pattern.

To open the Clock Recovery-Advanced Settings configuration menu:

1. Double-tap a measurement that requires clock recovery information (such as jitter measurements).
2. Tap the **Clock Recovery** panel
3. Tap the **Advanced** button.

## Clock Recovery-Advanced Settings configuration menu, fields and controls

Field or control	Description
<b>Advanced Clock Recovery Method</b>	Sets the method used to recover a clock from the measured signal. Available selections are <b>None</b> (default), <b>Nominal Data Rate</b> and <b>Known Data Pattern</b> .
<b>Bit Rate</b>	Sets the clock bit rate. The <b>Bit Rate</b> field is only present when <b>Advanced Clock Recovery Method</b> is set to <b>Nominal Data Rate</b> .
<b>Pattern File</b>	Drop-down list with 20 most recent pattern files loaded onto the oscilloscope. Available when Advanced Clock Recovery = Known Data Pattern.
<b>Browse</b>	Opens a standard file navigation window. Use to navigate to and select a pattern file.

### See also

[Measurement Name panel \(Measurement configuration menu\)](#) on page 211

[Configure panel \(Measurement configuration menu\)](#) on page 212

[Reference Levels panel \(Measurement configuration menu\)](#) on page 212

[Clock Recovery panel \(Measurement configuration menu\)](#) on page 214

[Gating panel \(Measurement configuration menu\)](#) on page 218

[Filter/Limit Results panel \(Measurement Settings menu\)](#) on page 220

[Pass/Fail Testing panel \(Measurement Settings menu\)](#) on page 221

## Gating panel (Measurement configuration menu)

Use Gating to confine a measurement to a certain part of a waveform.

To open the **Gating** panel:

1. Double-tap a Measurement badge in the Results bar to open the Measurement configuration menu.
2. Tap the **Gating** panel.

### Gating panel, fields and controls

Not all items listed in the table are shown for all measurements; The panel shows fields and controls relevant to the selected measurement.

Field or control	Description
<b>Gating</b>	Sets whether this measurement's gating settings are <b>Global</b> or <b>Local</b> .  When <b>Global</b> is selected, changing anything in this panel causes the same change to all other measurements that also have <b>Global</b> selected.  When <b>Local</b> is selected, settings in this panel only effect this measurement.

Table continued...

Field or control	Description
<b>Gating Type</b>	<p>Sets the gate type used to take measurements.</p> <p><b>None:</b> Measurements are taken across the entire record.</p> <p><b>Screen:</b> Measurements are taken on the portion of the waveform shown on the display. When zoom is on, the 'display' on which to measure is the zoom window.</p> <p><b>Cursors:</b> Measurements are taken on the portion of the waveform between the cursors.</p> <p><b>Logic:</b> Measurements are taken only when the logical state of a specified waveform is true.</p> <p><b>Search:</b> Measurements are taken between the start and stop times defined by a specified search. Search gating is only valid for DDR3 measurements on a 6 Series MSO instrument.</p> <p><b>Time:</b> Measurements are taken between the times specified in the <b>Start Gate Time</b> and <b>End Gate Time</b> fields, relative to the trigger point (0 s).</p>
<b>Source</b>	<p>Sets the signal source to use for Logic or Search gates.</p> <p>If <b>Gating Type</b> is <b>Logic</b>, the <b>Source</b> field lists all available sources.</p> <p>If <b>Gating Type</b> is <b>Search</b>, the <b>Source</b> field lists all available searches.</p>
<b>Threshold</b>	<p>Sets the threshold value for the Logic gate source to be considered a logic 1 value. Available when <b>Source</b> is <b>Logic</b>.</p>
<b>Hysteresis</b>	<p>Sets the Hysteresis value for the Logic gate source. Available when <b>Source</b> is <b>Logic</b>.</p>
<b>Active</b>	<p>Sets the logic state value for the Logic gate source. Available when <b>Source</b> is <b>Logic</b>.</p>
<b>Start Gate Time</b> <b>End Gate Time</b>	<p>Sets the starting time (Start Gate) and ending time (End Gate) between which to take a measurement. The starting and ending gate times are relative to the trigger time (0 s). Available when <b>Gating Type</b> is <b>Time</b>.</p>

## Guidelines

- Only one gated region is allowed per measurement. You can create duplicate measurements and define different gates for each one.
- Tap on a gating-enabled measurement badge to display the vertical gate bars on the waveform for that measurement.
- Gating is indicated by two vertical bars; one at the start of the gated region and one at the end.
- If the measurement has more than one source, gate bars are drawn on both sources.
- Time gates can be placed anywhere. They can precede acquisition start value and extend beyond the acquisition value.
- The Time Gating bars are shown in both the overview and zoomed view when zoom is on.

## See also

[Measurement Name panel \(Measurement configuration menu\)](#) on page 211

[Configure panel \(Measurement configuration menu\)](#) on page 212

[Reference Levels panel \(Measurement configuration menu\)](#) on page 212

[Clock Recovery panel \(Measurement configuration menu\)](#) on page 214

[Clock Recovery- Advanced Settings configuration menu](#) on page 217

[Filter/Limit Results panel \(Measurement Settings menu\)](#) on page 220

[Pass/Fail Testing panel \(Measurement Settings menu\)](#) on page 221

## Filter/Limit Results panel (Measurement Settings menu)

Use these settings to apply a High Pass and/or Low Pass filter to block specified frequency band components when taking measurements. Use the limit controls to set range of measurement values to measure, and the number of measurements to take (population).

To open the **Filter/Limit Results** panel:

1. Double-tap a Measurement badge.
2. Tap the **Filter/Limit Results** panel.

### Filter/Limit Results panel fields and controls

Not all items listed in the table may be shown for all measurements; The panel only shows fields and controls relevant to the selected measurement.

Field or control	Description
<b>Filter Measurement Results</b>	Sets whether this measurement's filter and limits settings are <b>Global</b> or Local.  When set to <b>Global</b> (the default), changing anything in this panel causes the same change to all other measurement filter and limit settings that also have Global selected.  When set to <b>Local</b> , changing anything in this panel only effects this measurement.
<b>High Pass Filter</b>	Blocks the low frequency band and passes only the high frequency band of the waveform.  Select a Butterworth filter order (No Filter (default), 1st, 2nd, or 3rd) and enter the roll-off frequency in the field.
<b>FP Freq (F1)</b>	High Pass filter cut-off frequency at which the filter magnitude falls by 3 dB.
<b>Low Pass Filter</b>	Blocks the high frequency band and passes only the low frequency band of the waveform.  Select a Butterworth filter order (No Filter (default), 1st, 2nd, or 3rd) and enter the roll-off frequency in the field.
<b>LP Freq (F2)</b>	Low Pass filter cut-off frequency at which the filter magnitude falls by 3 dB.
<b>Limit Measurement Results</b>	Limit taking measurements results to those that are within the specified Min Value and Max value range.
<b>Limit Measurement Population</b>	Limit measurements to the specified number of measurements.

### Other measurement settings panels

[Measurement Name panel \(Measurement configuration menu\)](#) on page 211

[Configure panel \(Measurement configuration menu\)](#) on page 212

[Reference Levels panel \(Measurement configuration menu\)](#) on page 212

[Clock Recovery panel \(Measurement configuration menu\)](#) on page 214

[Clock Recovery- Advanced Settings configuration menu](#) on page 217

[Gating panel \(Measurement configuration menu\)](#) on page 218

[Pass/Fail Testing panel \(Measurement Settings menu\)](#) on page 221



## Pass/Fail Testing panel (Measurement Settings menu)

Use these settings to test measurement values against a specified limit and set actions for the instrument to take on failure.

To open the **PASS/FAIL TESTING** panel:

1. Double-tap a Measurement badge.
2. Tap the **Pass/Fail Testing** panel.

### Pass/Fail Testing panel fields and controls

Not all items listed in the table may be shown for all measurements; The panel only shows fields and controls relevant to the selected measurement.

Field or control	Description
<b>Pass/Fail Test</b>	Turns pass/fail testing on or off. Default is off.
<b>Fail When</b>	Sets the condition for when the test on the measurement will fail. Default is <b>&lt; Limit</b> .
<b>Limit</b>	Sets the measurement limit value. This control is present when <b>Fail When</b> is not set to <b>Inside Range</b> or <b>Outside Range</b> .
<b>Low Limit</b>	Sets the low limit for the measurement value. This control is only present when Fail When is set to <b>Inside Range</b> or <b>Outside Range</b> .
<b>High Limit</b>	Sets the high limit for the measurement value. This control is only present when Fail When is set to <b>Inside Range</b> or <b>Outside Range</b> .
<b>Actions on Failure</b>	Opens a configuration menu to set the actions the instrument takes when the test fails. See <a href="#">Act On Event configuration menu</a> on page 178.
<b>Badge Navigation</b>	Sets the navigation in the results badge. Tap to toggle to view <b>Failures</b> or <b>All Occurrences</b> . When Failure is selected the navigation buttons move from failure to failure. When All Occurrences is selected, the navigation button moves through each occurrence.

### Other measurement settings panels

[Measurement Name panel \(Measurement configuration menu\)](#) on page 211

[Configure panel \(Measurement configuration menu\)](#) on page 212

[Reference Levels panel \(Measurement configuration menu\)](#) on page 212

[Clock Recovery panel \(Measurement configuration menu\)](#) on page 214

[Clock Recovery- Advanced Settings configuration menu](#) on page 217

[Gating panel \(Measurement configuration menu\)](#) on page 218

[Filter/Limit Results panel \(Measurement Settings menu\)](#) on page 220

## Spectrum measurements configuration menu overview

Use this configuration menu to add statistics to a Spectrum measurement badge readout, plot a measurement, and change measurement settings including; source and pass/fail testing.

To open the Spectrum measurement configuration menu, double-tap a Spectrum measurement badge in the Results bar. The configuration menu and panels only show fields and controls relevant to the selected measurement.

The menu opens on the measurement name panel, which provides controls to display additional statistics to the measurement badge, display plots of the measurement, and so on. The Measurement Name panel only shows fields and controls relevant to the selected measurement. The most common Spectrum measurement name fields are listed in the following table.

### Spectrum measurement configuration menu fields, controls, and panels

Field,control, or panel	Description
Measurement Name panel	<p>Displays the list of measurement statistics related to the measurement. You can add these to a measurement badge by selecting the <b>Show Statistics in Badge</b> control. The measurement badge displays the listed statistical measurement readouts.</p> <p>Opens Plot views of the measurement. To add a plot to the screen, tap the <b>Plot</b> button. Plot type includes Histogram only.</p> <p>See <a href="#">Histogram plot configuration menu</a> on page 522.</p>
Configure panel	<p>Sets the source, label text, and other fields that are specific to each measurement type.</p> <p>See <a href="#">Configure panel (Spectrum measurements configuration menu)</a> on page 223</p>
Pass/Fail Testing panel	<p>Sets the conditions for pass/fail testing for measurements and sets actions to take when a measurement fails.</p> <p>See <a href="#">Pass/Fail Testing panel (Spectrum measurement configuration menu)</a> on page 225.</p>

### Spectrum Measurements Name panel (Measurement configuration menu)

The Spectrum Measurements Name panel provides controls for adding display statistics to the measurement badge and opening plots of the measurement.

To open the Spectrum Measurements Name panel, double-tap a Spectrum Measurements badge. This is the default panel shown when you open a Spectrum Measurements settings menu.

The contents of the Measurement Name panel depends on the selected measurement.

Field,control, or panel	Description
Measurement Statistics	A list of statistics related to the measurement. You can add these to a measurement badge by selecting the <b>Show Statistics in Badge</b> control.
Show Statistics in Badge	<p>Adds the listed statistical measurement readouts to the measurement badge readout.</p> <p>The show statistics in badge is available for Channel Power and Occupied Bandwidth measurements only.</p>
Plots	<p>Opens Plot views of the measurement. Available plot is Histogram.</p> <p>To add a plot to the screen, tap the <b>Plot</b> button. See <a href="#">Histogram plot configuration menu</a> on page 522.</p>

## See also

[Spectrum measurements configuration menu overview](#) on page 222

[Configure panel \(Spectrum measurements configuration menu\)](#) on page 223

[Pass/Fail Testing panel \(Spectrum measurement configuration menu\)](#) on page 225.

## Configure panel (Spectrum measurements configuration menu)

Use the configure panel to set the measurement source, add a custom label for the measurement and other parameters.

To open the Configure panel for a Spectrum measurements:

1. Double-tap a Spectrum measurement badge to open the configuration menu.
2. Tap the **Configure** panel.

### Channel Power measurement: Configure panel

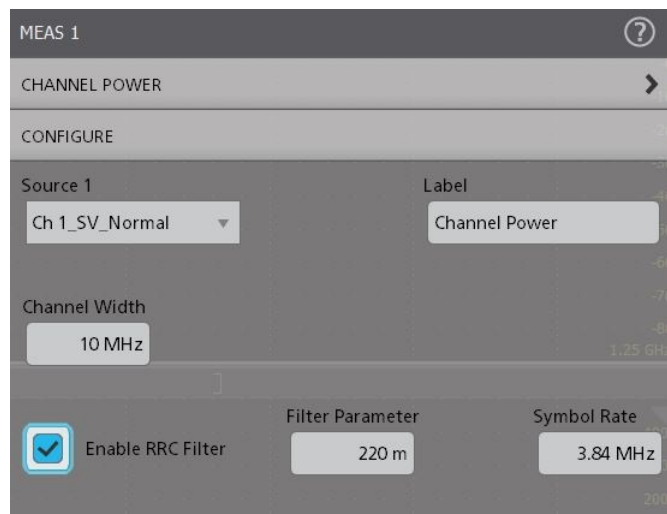

Field, control, or panel	Description
<b>Source</b>	Select the input signal channel from the Source drop-down menu.
<b>Label</b>	Sets the name of the measurement. You can use the default name, or double-tap in the field and change the label using a connected keyboard or the virtual keyboard.
<b>Channel Width</b>	Sets the channel width. Default width is 10 MHz.
<b>Enable RRC Filter</b>	Enables the RRC filter. Default is unchecked.
<b>Filter Parameter</b>	Sets the filter parameter. Available when <b>Enable RRC Filter</b> box is checked. Default value is 0.22.
<b>Symbol Rate</b>	Sets the symbol rate. Available when <b>Enable RRC Filter</b> box is checked. Default rate is 3.84 MHz.

### Occupied Bandwidth measurement: Configure panel

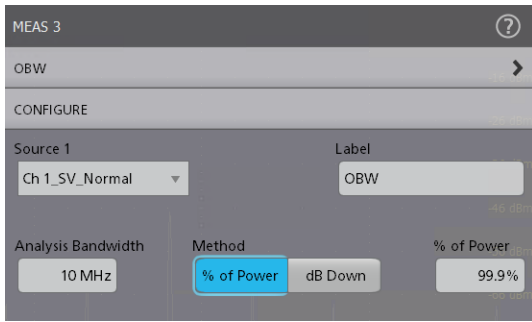

Field, control, or panel	Description
Source	Select the input signal channel from the Source drop-down menu.
Label	Sets the name of the measurement. You can use the default name, or double-tap in the field and change the label using a connected keyboard or the virtual keyboard.
Analysis Bandwidth	Sets the analysis bandwidth. Default bandwidth is 10 MHz.
Method	Sets the method as <b>% of Power</b> or <b>dB Down</b> . Default method is <b>% of Power</b> .
% of Power	Sets the percentage of power. Default value is 99.9%. Available when <b>Method</b> is <b>% of Power</b> .
dB Down	Sets the db down. Default is -26 dB. Available when <b>Method</b> is <b>dB Down</b> .

### ACPR measurement: Configure panel



Field, control, or panel	Description
Source	Select the input signal channel from the Source drop-down menu.
Label	Sets the name of the measurement. You can use the default name, or double-tap in the field and change the label using a connected keyboard or the virtual keyboard.

Table continued...

Field, control, or panel	Description
<b>Adjacent Channels</b>	Sets the number of adjacent channels. Default adjacent channel is 1.
<b>Channel Width</b>	Sets the channel width. Default channel width is 4 MHz.
<b>Channel Spacing</b>	Sets the channel spacing. It is a difference in frequency between the centers of each channel. Default channel spacing is 5 MHz.

## Pass/Fail Testing panel (Spectrum measurement configuration menu)

Use these settings to test measurement values against a specified limits and set actions for the instrument to take on failure.

See [Pass/Fail Testing panel \(Measurement Settings menu\)](#) on page 221 for the Pass/Fail Testing panel fields and controls.

Pass/fail testing panel is available for Channel Power and Occupied Bandwidth measurements only.

### See also

[Spectrum Measurements Name panel \(Measurement configuration menu\)](#) on page 222

[Configure panel \(Spectrum measurements configuration menu\)](#) on page 223

## Jitter measurement configuration menu overview

Use this configuration menu to add statistics to a Jitter measurement badge readout, plot a measurement, and change measurement settings including; source, scope (global or local), reference levels, and gating.

To open the Jitter measurement configuration menu for a measurement, double-tap a Jitter measurement badge in the Results bar. The configuration menu and panels only show fields and controls relevant to the selected measurement.

The menu opens on the measurement name panel (the name of the measurement), which provides controls to display additional statistics to the measurement badge, display plots of the measurement, and so on. The measurement name panel only shows fields and controls relevant to the selected measurement. The most common Jitter measurement name fields are listed in the following table.

### Jitter Measurement configuration menu fields, controls, and panels

Field, control, or panel	Description
<b>Measurement Statistics</b> (Measurement name panel)	A list of measurement statistics related to the measurement. You can add these to a measurement badge by selecting the <b>Show Statistics in Badge</b> control.
<b>Show Statistics in Badge</b> (Measurement name panel)	Adds the listed statistical measurement readouts to the measurement badge readout.
<b>Plots</b> (Measurement name panel)	Opens Plot views of the measurement. Available plots depend on the measurement. Plot types include Bathtub, TIE Spectrum, Time trend plot, TIE Histogram, Eye Diagram plot.  To add a plot to the screen, tap the Plot button.  See <a href="#">Add Plot configuration menu</a> on page 336.
<b>Configure panel</b>	Sets the source, label text, and other fields that are specific to each measurement type.  See <a href="#">Configure panel (Jitter measurement configuration menu)</a> on page 227.

Table continued...

Field, control, or panel	Description
<b>Reference Levels panel</b>	Sets the reference levels and units used to take measurements, the scope of the reference level settings (global or local), and the method used to calculate the Top and Base waveform values.  See <a href="#">Reference Levels panel (Measurement configuration menu)</a> on page 212.
<b>Clock Recovery panel</b>	Sets the clock recovery settings for some jitter measurements.  See <a href="#">Clock Recovery panel (Measurement configuration menu)</a> on page 214.
<b>Gating panel</b>	Sets the measurement region (gate) used to take measurements. Select the scope of the gate setting (global or local), and the type of gating to use.  See <a href="#">Gating panel (Measurement configuration menu)</a> on page 218.
<b>Filter/Limit Results panel</b>	Sets the scope of the filtering setting (global or local), high and low pass filter settings, the range of measurement result limits, and the limit measurement population size.  See <a href="#">Filter/Limit Results panel (Measurement Settings menu)</a> on page 220.
<b>Pass/Fail Testing panel</b>	Sets the conditions for pass/fail testing for measurements and sets actions to take when a measurement fails.  See <a href="#">Pass/Fail Testing panel (Measurement Settings menu)</a> on page 221.

## Jitter Measurement Name panel (Measurement configuration menu)

The Jitter Measurement Name panel (the name of the measurement) provides controls for adding display statistics to the measurement badge and opening plots of the measurement.

To open the jitter measurement name panel, double-tap a Jitter Measurement badge. This is the default panel shown when you open a Jitter Measurement settings menu.

The contents of the Measurement Name panel depends on the measurement.

Field or control	Description
<b>Measurement Statistics</b>	Shows a list of measurement statistics. You can add these statistics to a measurement badge by selecting the <b>Show Statistics in Badge</b> control.
<b>Show Statistics in Badge</b>	Adds the listed statistical measurement readouts to the measurement badge.
<b>Plots</b>	Adds a Plot view of the measurement value to the screen. Available plots depend on the measurement. Plot types include Bathtub, TIE Spectrum trend plot, TIE Histogram, Eye Diagram plot. Trend adds the trend plot to the Waveform view.

### See also

[Configure panel \(Jitter measurement configuration menu\)](#) on page 227

[Reference Levels panel \(Measurement configuration menu\)](#) on page 212

[Clock Recovery panel \(Measurement configuration menu\)](#) on page 214

[Gating panel \(Measurement configuration menu\)](#) on page 218

[Filter/Limit Results panel \(Measurement Settings menu\)](#) on page 220

[Pass/Fail Testing panel \(Measurement Settings menu\)](#) on page 221

## Configure panel (Jitter measurement configuration menu)

Use the configure panel to add a custom name (label) for the measurement and other parameters.

To open the Configure panel for a Jitter measurement:

1. Double-tap a Jitter measurement badge to open the Jitter measurement configuration menu.
2. Tap the **Configure** panel.

## Jitter Measurements panel

### Jitter Summary and TJ@BER measurements: Configuration panel

Field or control	Description
<b>Source 1</b>	Select the input signal channel from the Source 1 fields.
<b>Label</b>	Sets the name of the measurement. You can use the default name, or double-tap in the field and change the label using a connected keyboard or the virtual keyboard.
<b>Signal Type</b>	Set the signal type as <b>Clock</b> , <b>Data</b> , or <b>Auto</b> .
<b>Clock Edge</b>	Set the edge of the clock signal. Available clock edges are rising, falling, and both. Available when <b>Signal Type</b> is <b>Clock</b> or <b>Auto</b> .
<b>Pattern Detection</b>	Set the pattern detection method as <b>Auto</b> or <b>Manual</b> . Auto method causes the data pattern to be detected automatically on the first acquisition following a configuration change. Based on this detection, the Pattern Type and associated controls are then configured optimally for the given record length. Manual method allows (and requires) that the Pattern Type and associated controls be set manually.
<b>Pattern Type</b>	Set the pattern type as <b>Repeating</b> or <b>Arbitrary</b> . If the data signal is repeating pattern of N bits, then Repeating pattern type should be selected. If the data signal is non-repeating pattern or unknown then Arbitrary pattern type should be selected. Available when <b>Pattern Detection</b> is <b>Auto</b> .
<b>Pattern Length</b>	Enter the pattern length. Default length is 2 UI. When Pattern Detection is Auto, this field shows the detected pattern length. When Pattern Detection is Manual, this control must be set to match the actual pattern length. If the manually-set pattern length is inconsistent with the detected pattern length, process stops but a warning will be logged. Double-tap in the field to change the value using a connected keyboard or the virtual keyboard. Available when <b>Pattern Type</b> is <b>Repeating</b> .
<b>Window Length</b>	Enter the window length. Default length is 10 UI. Determines the number of unit intervals over which pattern correlation effects are analyzed. The window should be set to a large enough value that the impulse response of the serial data transmitter and channel have settled. Double-tap in the field to change the value using a connected keyboard or the virtual keyboard. Available when <b>Pattern Type</b> is <b>Arbitrary</b> .
<b>Target BER</b>	Sets the Bit Error Rate exponent, thereby setting the statistical level at which total jitter and eye opening are reported. Default value is 12. The minimum value is 2 and maximum value is 18. Double-tap in the field to change the value using a connected keyboard or the virtual keyboard.

**TIE measurement: Configuration panel**

Field or control	Description
Source 1	Select the input signal channel from the Source 1 fields.
Label	Sets the name of the measurement. You can use the default name, or double-tap in the field and change the label using a connected keyboard or the virtual keyboard.
Signal Type	Set the signal type as <b>Clock</b> , <b>Data</b> , or <b>Auto</b> .
Clock Edge	Set the edge of the clock signal. Available clock edges are rising, falling, and both.  Available when <b>Signal Type</b> is <b>Clock</b> or <b>Auto</b> .

**Phase Noise measurement: Configure panel**

Field or control	Description
Source 1	Select the input signal channel from the Source 1 fields.
Source 2	Select the input signal channel from the Source 2 fields.
Label	Sets the name of the measurement. You can use the default name, or double-tap in the field and change the label using a connected keyboard or the virtual keyboard.
Upper Noise Integration Limit	Sets the upper noise intergration limit.
Lower Noise Integration Limit	Sets the lower noise intergration limit.
Smoothing Filter	Toggles the smoothing filter On or Off to smoothen the phase noise plot. The default is <b>On</b> .

**RJ  $\delta\delta$ , DJ  $\delta\delta$ , PJ, RJ, DJ, SRJ, J2, J9, NPJ, F/2, F/4, and F/8 measurements: Configuration panel**

Field or control	Description
Source 1	Select the input signal channel from the Source 1 fields.
Label	Sets the name of the measurement. You can use the default name, or double-tap in the field and change the label using a connected keyboard or the virtual keyboard.
Signal Type	Set the signal type as <b>Clock</b> , <b>Data</b> , or <b>Auto</b> .
Clock Edge	Set the edge of the clock signal. Available clock edges are rising, falling, and both.  Available when <b>Signal Type</b> is <b>Clock</b> or <b>Auto</b> .
Pattern Detection	Set the pattern detection method as <b>Auto</b> or <b>Manual</b> .  Auto method causes the data pattern to be detected automatically on the first acquisition following a configuration change. Based on this detection, the Pattern Type and associated controls are then configured optimally for the given record length.  Manual method allows (and requires) that the Pattern Type and associated controls be set manually.
Pattern Type	Set the pattern type as <b>Repeating</b> or <b>Arbitrary</b> . If the data signal is repeating pattern of N bits, then Repeating pattern type should be selected.  If the data signal is non-repeating pattern or unknown then Arbitrary pattern type should be selected.  Available when <b>Pattern Detection</b> is <b>Auto</b> .

Table continued...



Field or control	Description
<b>Pattern Length</b>	<p>Enter the pattern length. Default length is 2 UI. When Pattern Detection is Auto, this field shows the detected pattern length. When Pattern Detection is Manual, this control must be set to match the actual pattern length. If the manually-set pattern length is inconsistent with the detected pattern length, process stops but a warning will be logged. Double-tap in the field to change the value using a connected keyboard or the virtual keyboard.</p> <p>Available when <b>Pattern Type</b> is <b>Repeating</b>.</p>
<b>Window Length</b>	<p>Enter the window length. Default length is 10 UI. Determines the number of unit intervals over which pattern correlation effects are analyzed. The window should be set to a large enough value that the impulse response of the serial data transmitter and channel have settled. Double-tap in the field to change the value using a connected keyboard or the virtual keyboard.</p> <p>Available when <b>Pattern Type</b> is <b>Arbitrary</b>.</p>

#### DDJ measurement: Configuration panel

Field or control	Description
<b>Source 1</b>	Select the input signal channel from the Source 1 fields.
<b>Label</b>	Sets the name of the measurement. You can use the default name, or double-tap in the field and change the label using a connected keyboard or the virtual keyboard.
<b>Pattern Detection</b>	<p>Set the pattern detection method as <b>Auto</b> or <b>Manual</b>.</p> <p>Auto method causes the data pattern to be detected automatically on the first acquisition following a configuration change. Based on this detection, the Pattern Type and associated controls are then configured optimally for the given record length.</p> <p>Manual method allows (and requires) that the Pattern Type and associated controls be set manually.</p>
<b>Pattern Type</b>	<p>Set the pattern type as <b>Repeating</b> or <b>Arbitrary</b>. If the data signal is repeating pattern of N bits, then Repeating pattern type should be selected.</p> <p>If the data signal is non-repeating pattern or unknown then Arbitrary pattern type should be selected.</p> <p>Available when <b>Pattern Detection</b> is <b>Auto</b>.</p>
<b>Pattern Length</b>	<p>Enter the pattern length. Default length is 2 UI. When Pattern Detection is Auto, this field shows the detected pattern length. When Pattern Detection is Manual, this control must be set to match the actual pattern length. If the manually-set pattern length is inconsistent with the detected pattern length, process stops but a warning will be logged. Double-tap in the field to change the value using a connected keyboard or the virtual keyboard.</p> <p>Available when <b>Pattern Type</b> is <b>Repeating</b>.</p>
<b>Window Length</b>	<p>Enter the window length. Default length is 10 UI. Determines the number of unit intervals over which pattern correlation effects are analyzed. The window should be set to a large enough value that the impulse response of the serial data transmitter and channel have settled. Double-tap in the field to change the value using a connected keyboard or the virtual keyboard.</p> <p>Available when <b>Pattern Type</b> is <b>Arbitrary</b>.</p>

**DCD measurement: Configuration panel**

Field or control	Description
<b>Source 1</b>	Select the input signal channel from the Source 1 fields.
<b>Label</b>	Sets the name of the measurement. You can use the default name, or double-tap in the field and change the label using a connected keyboard or the virtual keyboard.
<b>Signal Type</b>	Set the signal type as <b>Clock</b> , <b>Data</b> , or <b>Auto</b> .
<b>Pattern Detection</b>	Set the pattern detection method as <b>Auto</b> or <b>Manual</b> .  Auto method causes the data pattern to be detected automatically on the first acquisition following a configuration change. Based on this detection, the Pattern Type and associated controls are then configured optimally for the given record length.  Manual method allows (and requires) that the Pattern Type and associated controls be set manually.
<b>Pattern Type</b>	Set the pattern type as <b>Repeating</b> or <b>Arbitrary</b> . If the data signal is repeating pattern of N bits, then Repeating pattern type should be selected.  If the data signal is non-repeating pattern or unknown then Arbitrary pattern type should be selected.  Available when <b>Pattern Detection</b> is <b>Auto</b> .
<b>Pattern Length</b>	Enter the pattern length. Default length is 2 UI. When Pattern Detection is Auto, this field shows the detected pattern length. When Pattern Detection is Manual, this control must be set to match the actual pattern length. If the manually-set pattern length is inconsistent with the detected pattern length, process stops but a warning will be logged. Double-tap in the field to change the value using a connected keyboard or the virtual keyboard.  Available when <b>Pattern Type</b> is <b>Repeating</b> .
<b>Window Length</b>	Enter the window length. Default length is 10 UI. Determines the number of unit intervals over which pattern correlation effects are analyzed. The window should be set to a large enough value that the impulse response of the serial data transmitter and channel have settled. Double-tap in the field to change the value using a connected keyboard or the virtual keyboard.  Available when <b>Pattern Type</b> is <b>Arbitrary</b> .

**CC-Jitter measurement: Configuration panel**

Field or control	Description
<b>Source 1</b>	Select the input signal channel from the Source 1 fields.
<b>Label</b>	Sets the name of the measurement. You can use the default name, or double-tap in the field and change the label using a connected keyboard or the virtual keyboard.
<b>Edge</b>	Set the edge of the signal as <b>First</b> , <b>Rising</b> , or <b>Falling</b> .
<b>N=</b>	Specifies number of cycles or unit interval in each N-period group. Double-tap in the field to change the value using a connected keyboard or the virtual keyboard.

**Eye Measurements panel**

## Eye Height measurement: Configuration panel

Field or control	Description
<b>Source 1</b>	Select the input signal channel from the Source 1 fields.
<b>Source 2</b>	Select the input signal channel from the Source 2 fields.
<b>Label</b>	Sets the name of the measurement. You can use the default name, or double-tap in the field and change the label using a connected keyboard or the virtual keyboard.
<b>Bit Type</b>	<p>Sets the waveform bit types as <b>Trans</b>, <b>Non-Trans</b>, or <b>All</b>.</p> <p>Trans bit type does eye analysis only on transition bits. A transition bit is a bit that is changing from low to high or high to low.</p> <p>Non-trans bit type does eye analysis only on non-transition bits. A non-transition bit is a bit that is not changing state.</p> <p>All bit type does eye analysis using both transition and non-transition bits.</p>
<b>Analysis Method</b>	Set the analysis method as <b>Parametric</b> or <b>Histogram</b> (Non-parametric) for the measurement.
<b>Set Levels In</b>	Sets the levels as <b>%</b> or <b>Absolute</b> . It defines the exact time in percentage terms or absolute values.
<b>Measure at % of the Unit Interval</b>	<p>Set the horizontal position where the measurement is taken as a percentage of the unit interval. Double-tap in the field to change the value using a connected keyboard or the virtual keyboard.</p> <p>Available when <b>Set Levels In</b> is <b>%</b>.</p>
<b>Measure at 'X' seconds</b>	<p>Sets the horizontal position where the measurement is taken in terms of seconds.</p> <p>Available when <b>Set Levels In</b> is <b>Absolute</b>.</p>
<b>Width</b>	<p>Sets the window around the set level to search for the maximum eye width.</p> <p>Available when <b>Analysis Method</b> is <b>Histogram</b>.</p>
<b>Eye Interpolation</b>	<p>Select the interpolation for eye rendering.</p> <p>When checked, Eye Interpolation performs the interpolation between samples and gives a finer rendering appearance.</p> <p>When unchecked, it renders all samples of the valid UIs (Unit Intervals) without performing any interpolation.</p> <p>Available when <b>Analysis Method</b> is <b>Histogram</b>.</p>
<b>Eye Rendering</b>	<p>Set the eye rendering as <b>Fast</b> or <b>Complete</b>.</p> <p>Fast considers only a subset of the record length for the analysis, which defines the boundaries of the eye.</p> <p>Complete considers entire record length for the analysis.</p> <p>Available when <b>Analysis Method</b> is <b>Histogram</b> and <b>Eye Interpolation</b> box is checked.</p>
<b>UIs</b>	<p>Sets the number of unit intervals considered for the analysis.</p> <p>Available when <b>Analysis Method</b> is <b>Histogram</b>, <b>Eye Interpolation</b> box is checked, and <b>Eye Rendering</b> is <b>Fast</b>.</p>

**Eye Width measurement: Configuration panel**

Field or control	Description
<b>Source 1</b>	Select the input signal channel from the Source 1 fields.
<b>Source 2</b>	Select the input signal channel from the Source 2 fields.
<b>Label</b>	Sets the name of the measurement. You can use the default name, or double-tap in the field and change the label using a connected keyboard or the virtual keyboard.
<b>Analysis Method</b>	Set the analysis method as <b>Parametric</b> or <b>Histogram</b> (Non-parametric) for the measurement.
<b>Set Levels In</b>	Sets the levels as % or <b>Absolute</b> . It defines the exact time/voltage point in percentage terms or absolute values.  Available when <b>Analysis Method</b> is <b>Histogram</b> .
<b>Measure at % of the Unit Amplitude</b>	Sets the horizontal position where the measurement is taken, as a percentage of the unit amplitude.  Available when <b>Analysis Method</b> is <b>Histogram</b> and <b>Set Levels In</b> is %.
<b>Measure at 'X' voltage</b>	Sets the vertical position where the measurement is taken in terms of volts.  Available when <b>Analysis Method</b> is <b>Histogram</b> and <b>Set Levels In</b> is <b>Absolute</b> .
<b>Width</b>	Sets the window around the set level to search for the maximum eye width.  Available when <b>Analysis Method</b> is <b>Histogram</b> .
<b>Eye Interpolation</b>	Select the interpolation for eye rendering.  When checked, Eye Interpolation performs the interpolation between samples and gives a finer rendering appearance.  When unchecked, it renders all samples of the valid UIs (Unit Intervals) without performing any interpolation.  Available when <b>Analysis Method</b> is <b>Histogram</b> .
<b>Eye Rendering</b>	Set the eye rendering as <b>Fast</b> or <b>Complete</b> .  Fast considers only a subset of the record length for the analysis, which defines the boundaries of the eye.  Complete considers entire record length for the analysis.  Available when <b>Analysis Method</b> is <b>Histogram</b> and <b>Eye Interpolation</b> box is checked.
<b>UIs</b>	Sets the number of unit intervals considered for the analysis.  Available when <b>Analysis Method</b> is <b>Histogram</b> , <b>Eye Interpolation</b> box is checked, and <b>Eye Rendering</b> is <b>Fast</b> .

**Height@BER measurement: Configuration panel**

Field or control	Description
<b>Source 1</b>	Select the input signal channel from the Source 1 fields.
<b>Label</b>	Sets the name of the measurement. You can use the default name, or double-tap in the field and change the label using a connected keyboard or the virtual keyboard.

Table continued...

Field or control	Description
<b>Bit Type</b>	<p>Sets the waveform bit types as <b>Trans</b>, <b>Non-Trans</b>, or <b>All</b>.</p> <p>Trans bit type does eye analysis only on transition bits. A transition bit is a bit that is changing from low to high or high to low.</p> <p>Non-trans bit type does eye analysis only on non-transition bits. A non-transition bit is a bit that is not changing state.</p> <p>All bit type does eye analysis using both transition and non-transition bits.</p>
<b>Measurement Range Start, Finish</b>	Sets the measurement range. The default value is 50%. Double-tap in the field to change the value using a connected keyboard or the virtual keyboard.
<b>Number of Bins</b>	Set the number of bins. Defines the resolution by the number of bins into which Span is divided: 25, 50, 100, 250, 500, 2000, or Maximum. Double-tap in the field to change the value using a connected keyboard or the virtual keyboard.
<b>Target BER</b>	Sets the Bit Error Rate exponent, thereby setting the statistical level at which total jitter and eye opening are reported. Default value is 12. The minimum value is 2 and maximum value is 18. Double-tap in the field to change the value using a connected keyboard or the virtual keyboard.

#### Width@BER measurement: Configuration panel

Field or control	Description
<b>Source 1</b>	Select the input signal channel from the Source 1 fields.
<b>Label</b>	Sets the name of the measurement. You can use the default name, or double-tap in the field and change the label using a connected keyboard or the virtual keyboard.
<b>Signal Type</b>	Set the signal type as <b>Clock</b> , <b>Data</b> , or <b>Auto</b> .
<b>Clock Edge</b>	<p>Set the edge of the clock signal. Available clock edges are rising, falling, and both.</p> <p>Available when <b>Signal Type</b> is <b>Clock</b> or <b>Auto</b>.</p>
<b>Pattern Detection</b>	<p>Set the pattern detection method as <b>Auto</b> or <b>Manual</b>.</p> <p>Auto method causes the data pattern to be detected automatically on the first acquisition following a configuration change. Based on this detection, the Pattern Type and associated controls are then configured optimally for the given record length.</p> <p>Manual method allows (and requires) that the Pattern Type and associated controls be set manually.</p>
<b>Pattern Type</b>	<p>Set the pattern type as <b>Repeating</b> or <b>Arbitrary</b>. If the data signal is repeating pattern of N bits, then Repeating pattern type should be selected.</p> <p>If the data signal is non-repeating pattern or unknown then Arbitrary pattern type should be selected.</p> <p>Available when <b>Pattern Detection</b> is <b>Auto</b>.</p>
<b>Pattern Length</b>	<p>Enter the pattern length. Default length is 2 UI. When Pattern Detection is Auto, this field shows the detected pattern length. When Pattern Detection is Manual, this control must be set to match the actual pattern length. If the manually-set pattern length is inconsistent with the detected pattern length, process stops but a warning will be logged. Double-tap in the field to change the value using a connected keyboard or the virtual keyboard.</p> <p>Available when <b>Pattern Type</b> is <b>Repeating</b>.</p>

Table continued...

Field or control	Description
<b>Window Length</b>	Enter the window length. Default length is 10 UI. Determines the number of unit intervals over which pattern correlation effects are analyzed. The window should be set to a large enough value that the impulse response of the serial data transmitter and channel have settled. Double-tap in the field to change the value using a connected keyboard or the virtual keyboard.  Available when <b>Pattern Type</b> is <b>Arbitrary</b> .
<b>Target BER</b>	Sets the Bit Error Rate exponent, thereby setting the statistical level at which total jitter and eye opening are reported. Default value is 12. The minimum value is 2 and maximum value is 18. Double-tap in the field to change the value using a connected keyboard or the virtual keyboard.

**Eye High, Eye Low, and Q-Factor measurements: Configuration panel**

Field or control	Description
<b>Source 1</b>	Select the input signal channel from the Source 1 fields.
<b>Label</b>	Sets the name of the measurement. You can use the default name, or double-tap in the field and change the label using a connected keyboard or the virtual keyboard.
<b>Bit Type</b>	Sets the waveform bit types as <b>Trans</b> , <b>Non-Trans</b> , or <b>All</b> .  Trans bit type does eye analysis only on transition bits. A transition bit is a bit that is changing from low to high or high to low.  Non-trans bit type does eye analysis only on non-transition bits. A non-transition bit is a bit that is not changing state.  All bit type does eye analysis using both transition and non-transition bits.
<b>Measure at % of the Unit Interval</b>	The default value is 50%.

**Amplitude Measurements panel**

**Bit Low, Bit High, and Bit Amplitude measurements: Configuration panel**

Field or control	Description
<b>Source 1</b>	Select the input signal channel from the Source 1 fields.
<b>Label</b>	Sets the name of the measurement. You can use the default name, or double-tap in the field and change the label using a connected keyboard or the virtual keyboard.
<b>Bit Type</b>	Sets the waveform bit types as <b>Trans</b> , <b>Non-Trans</b> , or <b>All</b> .  Trans bit type does analysis only on transition bits. A transition bit is a bit that is changing from low to high or high to low.  Non-trans bit type does analysis only on non-transition bits. A non-transition bit is a bit that is not changing state.  All bit type does analysis using both transition and non-transition bits.
<b>Measure the Center % of Bit</b>	Set the center % of bit. The default value is 1%.
<b>Method</b>	Set the method as <b>Mean</b> or <b>Mode</b> .

**DC Common Mode measurements: Configuration panel**

Field or control	Description
Source 1	Select the input signal channel from the Source 1 fields.
Source 2	Select the input signal channel from the Source 2 fields.
Label	Sets the name of the measurement. You can use the default name, or double-tap in the field and change the label using a connected keyboard or the virtual keyboard.

**AC Common Mode (PK-PK) measurements: Configuration panel**

Field or control	Description
Source 1	Select the input signal channel from the Source 1 fields.
Source 2	Select the input signal channel from the Source 2 fields. Source 2 field enables when <b>Measurement Type</b> is <b>Double</b> .
Label	Sets the name of the measurement. You can use the default name, or double-tap in the field and change the label using a connected keyboard or the virtual keyboard.
Measurement Type	Set the measurement type as <b>Single</b> or <b>Double</b> .
>30 kHz High Pass Filter	Enables or disables the high pass filter.

**Differential Crossover measurements: Configuration panel**

Field or control	Description
Source 1	Select the input signal channel from the Source 1 fields.
Source 2	Select the input signal channel from the Source 2 fields.
Label	Sets the name of the measurement. You can use the default name, or double-tap in the field and change the label using a connected keyboard or the virtual keyboard.
Main Edge	Set the edge type.

**T/nT measurements: Configuration panel**

Field or control	Description
Source 1	Select the input signal channel from the Source 1 fields.
Label	Sets the name of the measurement. You can use the default name, or double-tap in the field and change the label using a connected keyboard or the virtual keyboard.

**Time measurement panel****SSC Freq Dev measurement: Configure panel**

Field or control	Description
Source 1	Select the input signal channel from the Source 1 fields.
Label	Sets the name of the measurement. You can use the default name, or double-tap in the field and change the label using a connected keyboard or the virtual keyboard.

Table continued...

Field or control	Description
<b>Bitrate Detection</b>	Set the bitrate to <b>Auto</b> or <b>Manual</b> . Default is Auto.  Auto bitrate detection enables the automatic detection of the data rate on the first acquisition following a configuration change.  In Manual configuration, allows you to specify the approximate data rate in bits per second (b/s).
<b>Detected Bitrate</b>	Auto bitrate is 2.5 Gb/s. The readout displayed when <b>Bitrate Detection</b> is <b>Auto</b> .  Enter the bitrate value manually using keyboard or double-tap and enter the value using virtual keypad. Available when <b>Bitrate Detection</b> is <b>Manual</b> .

**SSC Modulation Rate measurement: Configure panel**

Field or control	Description
<b>Source 1</b>	Select the input signal channel from the Source 1 fields.
<b>Label</b>	Sets the name of the measurement. You can use the default name, or double-tap in the field and change the label using a connected keyboard or the virtual keyboard.

**Reference Levels panel (Jitter measurement configuration menu)**

Use the Reference Levels panel to set the scope of the reference level settings (global or local), the measurement reference levels (High, Mid, and Low), the units used to take measurements, and the method used to calculate the Top and Base waveform values. Hysteresis settings are critical for PWM edge extraction.

See [Reference Levels panel \(Measurement configuration menu\)](#) on page 212 for the Reference panel fields and controls.

**Other measurement settings panels**

- [Jitter measurement configuration menu overview](#) on page 225
- [Jitter Measurement Name panel \(Measurement configuration menu\)](#) on page 226
- [Configure panel \(Jitter measurement configuration menu\)](#) on page 227
- [Clock Recovery panel \(Jitter measurement configuration menu\)](#) on page 236
- [Filter/Limit Results panel \(Jitter measurement configuration menu\)](#) on page 237
- [Gating panel \(Jitter measurement configuration menu\)](#) on page 237
- [Pass/Fail Testing panel \(Jitter measurement configuration menu\)](#) on page 237

**Clock Recovery panel (Jitter measurement configuration menu)**

Clock recovery refers to the process of establishing a reference clock, the edges of which can be used as a basis for timing comparisons. Use the Clock Recovery panel to configure the clock recovery settings for measurements that require a clock signal.

See [Clock Recovery panel \(Measurement configuration menu\)](#) on page 214 for the Clock Recovery panel fields and controls.

**Other measurement settings panels**

- [Jitter measurement configuration menu overview](#) on page 225
- [Jitter Measurement Name panel \(Measurement configuration menu\)](#) on page 226



[Configure panel \(Jitter measurement configuration menu\)](#) on page 227

[Reference Levels panel \(Jitter measurement configuration menu\)](#) on page 236

[Gating panel \(Jitter measurement configuration menu\)](#) on page 237

[Filter/Limit Results panel \(Jitter measurement configuration menu\)](#) on page 237

[Pass/Fail Testing panel \(Jitter measurement configuration menu\)](#) on page 237

## Gating panel (Jitter measurement configuration menu)

Use Gating to confine a measurement to a certain part of a waveform.

See [Gating panel \(Measurement configuration menu\)](#) on page 218 for the Gating panel fields and controls.

### Other measurement settings panels

[Jitter measurement configuration menu overview](#) on page 225

[Jitter Measurement Name panel \(Measurement configuration menu\)](#) on page 226

[Configure panel \(Jitter measurement configuration menu\)](#) on page 227

[Reference Levels panel \(Jitter measurement configuration menu\)](#) on page 236

[Clock Recovery panel \(Jitter measurement configuration menu\)](#) on page 236

[Filter/Limit Results panel \(Jitter measurement configuration menu\)](#) on page 237

[Pass/Fail Testing panel \(Jitter measurement configuration menu\)](#) on page 237

## Filter/Limit Results panel (Jitter measurement configuration menu)

Use these settings to apply a High Pass and/or Low Pass filter to block specified frequency band components when taking measurements. Use the limit controls to set range of measurement values to measure, and the number of measurements to take (population).

See [Filter/Limit Results panel \(Measurement Settings menu\)](#) on page 220 for the Filter/Limit Results panel fields and controls.

### Other measurement settings panels

[Jitter measurement configuration menu overview](#) on page 225

[Jitter Measurement Name panel \(Measurement configuration menu\)](#) on page 226

[Configure panel \(Jitter measurement configuration menu\)](#) on page 227

[Reference Levels panel \(Jitter measurement configuration menu\)](#) on page 236

[Clock Recovery panel \(Jitter measurement configuration menu\)](#) on page 236

[Gating panel \(Jitter measurement configuration menu\)](#) on page 237

[Pass/Fail Testing panel \(Jitter measurement configuration menu\)](#) on page 237

## Pass/Fail Testing panel (Jitter measurement configuration menu)

Use these settings to test measurement values against a specified limit and set actions for the instrument to take on failure.

See [Pass/Fail Testing panel \(Measurement Settings menu\)](#) on page 221 for the Pass/Fail Testing panel fields and controls.

## Other measurement settings panels

- [Jitter measurement configuration menu overview](#) on page 225
- [Jitter Measurement Name panel \(Measurement configuration menu\)](#) on page 226
- [Configure panel \(Jitter measurement configuration menu\)](#) on page 227
- [Clock Recovery panel \(Jitter measurement configuration menu\)](#) on page 236
- [Filter/Limit Results panel \(Jitter measurement configuration menu\)](#) on page 237
- [Gating panel \(Jitter measurement configuration menu\)](#) on page 237
- [Pass/Fail Testing panel \(Jitter measurement configuration menu\)](#) on page 237

## Power measurement configuration menu overview

Use this configuration menu to add statistics to a Power measurement badge readout, plot a measurement, and change measurement settings including source, scope (global or local), reference levels, and gating.

To open the Power measurement configuration menu for a measurement, double-tap a Power measurement badge in the Results bar. The configuration menu and panels only show fields and controls relevant to the selected measurement.

The menu opens on the measurement name panel (the name of the measurement), which provides controls to display additional statistics to the measurement badge, display plots of the measurement, and so on. The measurement name panel only shows fields and controls relevant to the selected measurement. The most common Power measurement Name fields are listed in the following table.

### Power Measurement configuration menu fields, controls, and panels

Field, control, or panel	Description
<b>Measurement Statistics</b> (Measurement name panel)	A list of measurement statistics related to the measurement. You can add these to a measurement badge by selecting the <b>Show Statistics in Badge</b> control.
<b>Show Statistics in Badge</b> (Measurement name panel)	Adds the listed statistical measurement readouts to the measurement badge readout.
<b>Plots</b> (Measurement name panel)	Buttons that open Plot views of the measurement. Available plots depend on the measurement. Plot types include Time Trend, Histogram, Harmonic bar graph, SOA, Switching Loss Trajectory, B-H curve, I vs. $\int V$ , Inductance, Power Supply Rejection Ratio, Control Loop Response, and Instantaneous Math.  To add a plot to the screen, tap the plot button.  See <a href="#">Add Plot configuration menu</a> on page 336.
<b>Configure panel</b>	Sets the source, label text, and other fields that are specific to each measurement type.  See <a href="#">Configure panel (Power measurement configuration menu)</a> on page 239.
<b>Reference Levels panel</b>	Sets the reference levels and units used to take measurements, the scope of the reference level settings (global or local), and the method used to calculate the Top and Base waveform values.  See <a href="#">Reference Levels panel (Measurement configuration menu)</a> on page 212.
<b>Gating panel</b>	Sets the measurement region (gate) used to take measurements. Select the scope of the gate setting (global or local), and the type of gating to use.  See <a href="#">Gating panel (Measurement configuration menu)</a> on page 218.

## Power Measurement Name panel (Measurement configuration menu)

The Power Measurement Name panel (the name of the measurement) provides controls for adding display statistics to the measurement badge and opening plots of the measurement.

To open the power measurement name panel, double-tap a Power Measurement badge. This is the default panel shown when you open a Power Measurement settings menu.

The contents of the Measurement Name panel depends on the measurement.



**Note:** The Power Measurement Name panel and the Configure panel are merged together for Input Capacitance, Inrush Current, Turn On Time, Turn Off Time, Control Loop Response, Power Supply Rejection Ratio (PSRR), and Impedance measurements.

Field or control	Description
<b>Power Autoset</b>	Sets the oscilloscope acquisition system for optimal results for all active power measurements except Inrush Current, Input Capacitance, Turn-on Time, and Turn-off time. See <a href="#">Power Autoset</a> .
<b>Power Preset</b>	Sets the oscilloscope acquisition system for optimal results for Turn On Time, Turn Off Time, Input Capacitance, and Inrush Current power measurements. See <a href="#">Power Preset</a> on page 256.  Available only for Turn On Time, Turn Off Time, Input Capacitance, Inrush Current, Power Supply Rejection Ratio, and Control Loop Response power measurements.
<b>Measurement Statistics</b>	Shows a list of measurement statistics. You can add these statistics to a measurement badge by selecting the <b>Show Statistics in Badge</b> control.
<b>Show Statistics in Badge</b>	Adds the listed statistical measurement readouts to the measurement badge.
<b>Plots</b>	Adds a Plot view of the measurement value to the screen. Available plots depend on the measurement. Plot types include SWL Trajectory, Bar Graph, Time Trend, Histogram, Control Loop Response, PSRR, SOA, and Transient Response.  Trend adds the trend plot to the Waveform view.

### See also

[Configure panel \(Measurement configuration menu\)](#) on page 212

[Reference Levels panel \(Measurement configuration menu\)](#) on page 212

[Gating panel \(Measurement configuration menu\)](#) on page 218

## Configure panel (Power measurement configuration menu)

Use the configure panel to set the measurements source(s), add a custom name (label) for the measurement and other parameters.

To open the Configure panel for a power measurement:

1. Double-tap a power measurement badge to open the Power measurement configuration menu.
2. Tap the **Configure** panel.

### di/dt and dv/dt measurement: Configure panel

Field or control	Description
<b>Source</b>	Sets the signal source used to take the measurement. Tap the field to show the list of available sources. Select the current source.
<b>Label</b>	Sets the name of the measurement. You can use the default name, or double-tap in the field and change the label using a connected keyboard or the virtual keyboard.

Table continued...

Field or control	Description
Edge	Sets the signal edges to detect (rise or fall).

### Harmonics measurement: Configure panel

Field or control	Description
Standard	<p>Sets the standard to use for measurements. None (no Standard), IEC 61000-3-2, MIL-STD-1399, AM14, or D0-160G (Standard for Airborne equipment. Supported for harmonics measurement for single phase DUT).</p> <p> <b>Note:</b> When standard is set as None with the current source, it displays an error as Low Amplitude. Change relevels method to MinMax manually. This error is displayed when you recall the demo setup files for this measurement.</p>
Harmonics	Sets the harmonics order (number of harmonics) for the selected standard. Ranges from 40 to 100.
Voltage Source	Selects the voltage source used to take the measurement. Tap the field to show the list of available sources.
Current Source	Selects the current source used to take the measurement. Tap the field to show the list of available sources.
Line Frequency	<p>Sets the line frequency of the power signal source.</p> <p>In Auto mode, the application measures the frequency of the input signal automatically. Input signal is used to compute harmonics in the current source. Default is Auto.</p>
Label	Sets the name of the measurement. You can use the default name, or double-tap in the field and change the label using a connected keyboard or the virtual keyboard.
Harmonics Source	Selects the source of harmonics calculation source (Voltage or Current) for computation of the Harmonics.
Power Level (MIL-STD-1399)	Selects the required power level, High or Low. It is used to compute limit values for MIL-STD-1399.
Current (MIL-STD-1399)	Selects either rated or measured. Specify the value for rated or measure the Input current signal.
Start Frequency	<p>Specify the fundamental frequency to be measured for each standard.</p> <ul style="list-style-type: none"> <li>• <b>None:</b> The values are <b>Auto</b>, 50, 60, 400, or <b>Custom</b> (specify the start Frequency)</li> <li>• <b>IEC-61000-3-2:</b> The values are <b>Auto</b>, 50, 60, or <b>Custom</b></li> <li>• <b>MIL-STD-1399:</b> The values are <b>Auto</b>, 400, or <b>Custom</b></li> <li>• <b>AM-14:</b> The values are <b>Auto</b>, 50, 60, or <b>Custom</b></li> <li>• <b>D0-160G:</b> The values are <b>Auto</b>, 360, 400, 800, or <b>Custom</b></li> </ul> <p>Default is <b>Auto</b>. The measured frequency value is displayed in the measurement badge.</p>

### Power Quality measurement: Configure panel

Field or control	Description
Voltage Source	Select the voltage source used to take the measurement. Tap the field to show the list of available sources.

Table continued...

Field or control	Description
<b>Current Source</b>	Select the current source used to take the measurement. Tap the field to show the list of available sources.
<b>Label</b>	Set the name of the measurement. You can use the default name, or double-tap in the field and change the label using a connected keyboard or the virtual keyboard.
<b>Calculate Over Full Cycles</b>	Enables calculating the measurement over the entire acquisition.
<b>Frequency Reference</b>	Select the signal source (Voltage or Current) to use to determine the measurement frequency.
<b>Source Type</b>	Selects the source type (AC or DC).

### Input Capacitance measurement: Configure panel

Field or control	Description
<b>Voltage Source</b>	Selects the voltage source used to take the measurement. Tap the field to show the list of available sources.
<b>Current Source</b>	Selects the current source used to take the measurement. Tap the field to show the list of available sources.
<b>Label</b>	Sets the name of the measurement. You can use the default name, or double-tap in the field and change the label using a connected keyboard or the virtual keyboard.
<b>Peak Voltage</b>	Sets the peak voltage value of the DUT. <b>Power Preset</b> uses the specified peak voltage value to compute the vertical scale.
<b>Peak Current</b>	Sets the peak current value of the DUT. <b>Power Preset</b> uses the specified peak current value to compute the vertical scale.

### Inrush Current measurement: Configure panel

Field or control	Description
<b>Current Source</b>	Selects the current source used to take the measurement. Tap the field to show the list of available sources.
<b>Label</b>	Sets the name of the measurement. You can use the default name, or double-tap in the field and change the label using a connected keyboard or the virtual keyboard.
<b>Peak Current</b>	Sets the peak current value of the DUT. <b>Power Preset</b> uses the specified peak current value to compute the vertical scale.

### SOA measurement: Configure panel

Field or control	Description
<b>Voltage Source</b>	Selects the voltage source used to take the measurement. Tap the field to show the list of available sources.
<b>Current Source</b>	Selects the current source used to take the measurement. Tap the field to show the list of available sources.
<b>Label</b>	Sets the name of the measurement. You can use the default name, or double-tap in the field and change the label using a connected keyboard or the virtual keyboard.

Table continued...

Field or control	Description
Define Mask	Defines the linear mask for SOA measurements. See <a href="#">Define Mask</a>

### Switching Loss measurement: Configure panel

Field or control	Description
Voltage Source	Selects the voltage source used to take the measurement. Tap the field to show the list of available sources.
Current Source	Selects the current source used to take the measurement. Tap the field to show the list of available sources.
Label	Sets the name of the measurement. You can use the default name, or double-tap in the field and change the label using a connected keyboard or the virtual keyboard.
Type	<p>Select SMPS / PFC/ Flyback:</p> <ul style="list-style-type: none"> <li>• <b>SMPS:</b> Select this option in case of signals without noise and ringing. The Vg source is not required. Select Vg source (Source 3), in case of noisy signal.</li> <li>• <b>PFC:</b> Select this option when input DUT signals are from Power Factor Correction Circuit. For this case, Vg source is mandatory.</li> <li>• <b>Flyback:</b> This option does not need a Vg source and works with switching voltage and current sources.</li> </ul> <p> <b>Note:</b> For SMPS and PFC settings to correctly calculate results, set REF Level to "Units" instead of "Percentage".</p>
Gate Voltage (Vg)	<p>Sets the Vg input source, which is a clean signal.</p> <p>Available when Type = <b>SMPS</b> or <b>PFC</b>.</p>
Vg Level Ton - Start	<p>Selects the source of computation of the harmonic. In the voltage source, standard is always <b>None</b>.</p> <p>Available when Gate Voltage (Vg) <math>\neq</math> <b>None</b>.</p>
PWM Type	Select <b>Fixed</b> or <b>Variable</b> based on the varying pulse width of the switching signal.
Conduction calculation	Select <b>MOSFET</b> or <b>BJT/IGBT</b> semiconductor types.
Use Profile	Select the <b>Use Profile</b> box to set the <b>Current Variance Co-efficients</b> for the selected source.
Setup	<p>Sets the Current Variance Settings to set the co-efficients for the <math>R_{DS}</math> and <math>V_{CE}</math>. Available when <b>Use Profile</b> box is selected.</p> <p><math>R_{DS}</math> is available when <b>Conduction Calculation</b> is <b>MOSFET</b>.</p> <p><math>V_{CE}</math> is available when <b>Conduction Calculation</b> is <b>BJT/IGBT</b>.</p>
Current Variance Settings	<p>Sets the <math>R_{DS}</math>, <math>V_{CE}</math>, and Co-efficient to be multiplied with current for the selected source.</p> <p>Available when <b>Use Profile</b> box and <b>Setup</b> selected.</p> <p>For the <math>R_{DS(on)}</math>, sets the minimum <math>R_{DS(min)}</math> value with the current Co-efficient. Available when <b>Conduction Calculation</b> is <b>MOSFET</b>.</p> <p>For <math>V_{CE(sat)}</math>, sets the minimum <math>V_{CE(min)}</math> value with the current Co-efficients <b>a</b>, <b>b</b>, <b>c</b>, and <b>d</b>. Available when <b>Conduction Calculation</b> is <b>BJT/IGBT</b>.</p>

Table continued...

Field or control	Description
$R_{DS(on)}$	If <b>MOSFET</b> is selected, then $R_{DS(on)}$ is used to compute for conduction Loss. Available when <b>Conduction Calculation</b> is <b>MOSFET</b>
$V_{CE(sat)}$	If <b>BJT/IGBT</b> is selected, then $V_{CE(sat)}$ is used to compute for conduction loss. Available when <b>Conduction Calculation</b> is <b>BJT/IGBT</b> .
<b>Set On/Off Levels In:</b>	Sets the REF levels for computation of the $T_{ON}$ and $T_{OFF}$ regions. Levels can be set in % or <b>Units</b> .
<b><math>T_{on}</math>-Start &amp; <math>T_{off}</math>-Stop Current Level</b>	Sets the $T_{on}$ -Start and $T_{off}$ -Stop of the max switch current.
<b><math>T_{on}</math>-Stop &amp; <math>T_{off}</math>-Start Voltage Level</b>	Sets the voltage level value for $T_{off}$ -Stop and $T_{on}$ . Can be entered as a percent or as a voltage, depending on the setting of the <b>Set On/Off Levels In:</b> control.

### Inductance measurement: Configure panel

Field or control	Description
<b>Voltage Source</b>	Selects the voltage source used to take the measurement. Tap the field to show the list of available sources.
<b>Current Source</b>	Selects the current source used to take the measurement. Tap the field to show the list of available sources.
<b>Label</b>	Sets the name of the measurement. You can use the default name, or double-tap in the field and change the label using a connected keyboard or the virtual keyboard.
<b>Edge Source</b>	Selects the voltage or current source for computing edges.



**Note:** When you are measuring the inductance of a transformer, do not load the secondary winding. The measurement of the inductance at the primary winding under no load condition is as good as measuring the inductance for a single winding. When you are measuring the inductance of the coupled inductor with multiple windings on the same core, the measured value of the inductance will deviate from the actual value due to the influence of the current on other windings. You can use this measured value to calculate the Ripple current.

### Magnetic Loss and $I$ vs. $\int V$ measurement: Configure panel

Field or control	Description
<b>Voltage Source</b>	Selects the voltage source used to take the measurement. Tap the field to show the list of available sources.
<b>Current Source</b>	Selects the current source used to take the measurement. Tap the field to show the list of available sources.
<b>Label</b>	Sets the name of the measurement. You can use the default name, or double-tap in the field and change the label using a connected keyboard or the virtual keyboard.

### Efficiency measurement: Configure panel

Field or control	Description
<b>Voltage Source</b>	Selects the input voltage source used to take the measurement. Tap the field to show the list of available sources.
<b>Current Source</b>	Selects the input current source used to take the measurement. Tap the field to show the list of available sources.
<b>Label</b>	Sets the name of the measurement. You can use the default name, or double-tap in the field and change the label using a connected keyboard or the virtual keyboard.
<b>No of Outputs (1, 2, or 3)</b>	Sets the number of outputs on the SMPS DUT, up to a maximum of three. You can configure these outputs in the application, and set up the sources (V and I), so that the efficiency per output and total efficiency for all available outputs are displayed.
<b>Output 1 Voltage</b>	Selects the voltage source for output one when the number of outputs is set to one.
<b>Output 1 Current</b>	Selects the current source for output one when the number of outputs is set to one.

### Turn On Time measurement: Configure panel

Field or control	Description
<b>Input Source</b>	Selects the channel connected to the input side of the DUT.
<b>Type</b>	Selects the input to output power conversion type. Default is <b>DC-DC</b> .
<b>Label</b>	Sets the name of the measurement. You can use the default name, or double-tap in the field and change the label using a connected keyboard or the virtual keyboard.
<b>Maximum Voltage</b>	Sets the maximum input voltage, in the range of 1 V to 500 V.
<b>Input Trigger</b>	Sets the input trigger level, in the range of 1 V to 500 V.
<b>Frequency</b>	Sets the DUT input AC signal frequency, in the range of 1 Hz to 1 MHz.  Available when <b>Type = AC-DC</b>
<b>Maximum Time</b>	Sets the maximum time window in which to capture the turn on time measurement (from the initial state to a steady state), in the range of 1 $\mu$ s to 500 s, with a resolution of 0.1 $\mu$ s.
<b>Number of Outputs (1, 2, 3, 4, 5, 6, or 7)</b>	Sets the number of outputs to measure on the DUT (maximum of seven).
<b>Output Source</b>	Selects the channel source to use for the listed output.
<b>Output Voltage</b>	Sets the expected maximum voltage for each listed output, in the range of -6 kV to +6 kV, with a resolution of 0.001 V. The measurement uses this value to set the vertical scale units for each output waveform.  The instrument measures the actual maximum voltage on each output, and uses this value to determine the output On/Off state levels, where On is $\geq 90\%$ of the measured value, and Off is $\leq 10\%$ of the measured value.



**Note:** The configuration value for maximum voltage and trigger level will not be remembered when it changes from AC-AC, AC-DC, DC-AC, and DC-DC modes. It displays the default values.



**Turn Off Time measurement: Configure panel**

Field or control	Description
Input Source	Selects the channel connected to the input side of the DUT.
Type	Selects the input to output power conversion type. Default is <b>AC-DC</b> .
Label	Sets the name of the measurement. You can use the default name, or double-tap in the field and change the label using a connected keyboard or the virtual keyboard.
Maximum Voltage	Specify the maximum input voltage, in the range of 1 V to 500 V.
Input Trigger	Specify the input trigger level, in the range of 1 V to 500 V.
Frequency	Specify the DUT input AC signal frequency, in the range of 1 Hz to 1 MHz. Available when <b>Type = AC-DC</b> .
Maximum Time	Sets the maximum time window to capture the turn off time measurement (from the initial state to a steady state), in the range of 1 $\mu$ s to 5 s, with a resolution of 0.1 $\mu$ s.
Number of Outputs (1, 2, 3, 4, 5, 6, or 7)	Sets the number of outputs to measure on the DUT (maximum of seven).
Output Source	Selects the channel source to use for the listed output.
Output Voltage	Sets the expected maximum voltage for each listed output, in the range of -6 kV to +6 kV, with a resolution of 0.001 V. The measurement uses this value to set the vertical scale units for each output waveform.  The instrument measures the actual maximum voltage on each output, and uses this value to determine the output On/Off state, where $\geq 90\%$ of the measured value = On, and $\leq 10\%$ of the measured value = Off.

**RDS<sub>(on)</sub> measurement: Configure panel**

Field or control	Description
Voltage Source	Selects the source used to take the voltage measurement. Tap the field to show the list of available sources.
Current Source	Selects the source used to take the current measurement. Tap the field to show the list of available sources.
Label	Sets the name of the measurement. You can use the default name, or double-tap in the field and change the label using a connected keyboard or the virtual keyboard.
Device Type	Sets the semiconductor (transistor device) type.  <b>Switching (v/i)</b> is the ratio of voltage to current in Ohms.  <b>PN Junction / Diode (dv/di)</b> is the ratio of rate of change of voltage to current in Ohms.

**Magnetic Property measurement: Configure panel**

Field or control	Description
Primary Voltage Source	Selects the source used to take the voltage measurement. Tap the field to show the list of available sources.

Table continued...

Field or control	Description
<b>Primary Current Source</b>	Selects the source used to take the current measurement. Tap the field to show the list of available sources.
<b>Primary Turns</b>	Sets the number of turns used on the primary winding. Tap the field and use the knob to set the value, or double-tap on the field and use the keyboard to enter a value.
<b>Label</b>	Sets the name of the measurement. You can use the default name, or double-tap in the field and change the label using a connected keyboard or the virtual keyboard.
<b>Edge Source</b>	<p>Sets the source used to detect the edge. Select either <b>Voltage</b> or <b>Current</b>. Default is <b>Voltage</b>.</p> <p> <b>Note:</b> For a variable switching operation, connect the gated drive signal to the edge source, as in variable mode the amplitude of the voltage acquired across the inductor varies with time. It is recommended to use gate drive signal as it is clean with no variations.</p>
<b>Units</b>	<p>Sets the measurement units.</p> <p><b>SI</b> sets the dimensions of the component in meters and units of magnetics in Tesla and Amperes Turns per meter.</p> <p><b>CGS</b> sets the unit of measurement to centimeters, and the result units are in Gauss and Oersted.</p>
<b>Cross Section</b>	<p>Sets the cross section dimensions of the magnetic component. The values are:</p> <ul style="list-style-type: none"> <li>• 1 nm<sup>2</sup> to 1 Mm<sup>2</sup> for <b>SI</b></li> <li>• 1 ncm<sup>2</sup> to 1 Mcm<sup>2</sup> for <b>CGS</b></li> </ul>
<b>Magnetic Length</b>	<p>Sets the cross section dimensions of the magnetic length. The values are:</p> <ul style="list-style-type: none"> <li>• 0 m to 1 Mm for <b>SI</b></li> <li>• 0 cm to 1 Mcm for <b>CGS</b></li> </ul>
<b>Voltage Phase</b>	Set the secondary voltage phase.



Table continued...

Field or control	Description
<b>Number of sec windings</b>	<p>Sets the number of secondary windings to measure. The range is from 1 to 6 if enable voltage sources is not checked, otherwise it is 1 to 3 secondary windings. Measure the magnetic property of secondary windings such as in a coupled inductor or a transformer that has multiple windings on the same core.</p> <p>Follow the connection combinations of the voltage and current probe at the primary or the main winding at the secondary or the other windings to the dot as shown in the following figure. The voltage probe should be connected such that the voltage is read as positive when the current rises.</p>  <p><b>WARNING:</b> When connecting to a circuit with hazardous voltages, see the warnings for the individual products and verify that the probes and other components used are within their ratings. For more information, refer to the topic <i>General safety summary</i>.</p>
<b>Winding (1-6)</b>	Sets the signal source used to measure the selected winding. The range is from 1 to 6.
<b>Turns (1-6)</b>	Sets the number of turns in the respective secondary winding.
<b>Enable Voltage Source</b>	Configures the transformer secondary voltage source when <b>Enable Voltage Source</b> is checked.
<b>Secondary Voltage Source</b>	Selects the source used to take the secondary voltage. Tap the field to show the list of available sources.
<b>Secondary Current Source</b>	Selects the source used to take the secondary current. Tap the field to show the list of available sources.

### Amplitude Analysis, Ripple Analysis, Timing Analysis power measurements: Configure panel

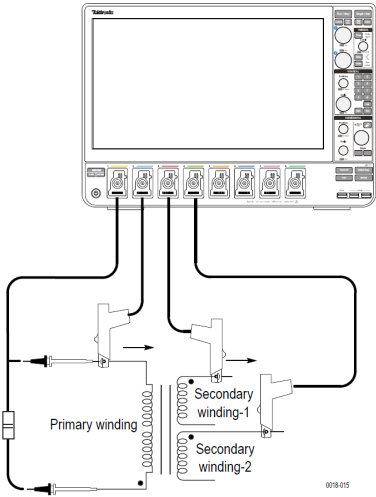
Field or control	Description
<b>Source</b>	Sets the signal source or sources used to take the measurement. If the measurement requires more than one source, multiple source fields are displayed. Tap the field to show the list of available sources.
<b>Label</b>	Sets the name of the measurement. You can use the default name, or double-tap in the field and change the label using a connected keyboard or the virtual keyboard.
<b>Edge</b>	Sets the signal edge to detect (rise or fall). Used in most <b>Timing Analysis</b> measurements. Available when the power measurement = <b>Frequency</b> .

Table continued...

Field or control	Description
<b>Clock Edge</b>	Sets the clock signal edge to detect (rise, fall, or either). Used in <b>Timing Analysis</b> measurements. Available when the power measurement = <b>Positive Duty Cycle</b> or <b>Negative Duty Cycle</b> .
<b>Line Frequency</b>	Sets the line frequency of the power signal source. <b>Power Autoset</b> uses the selected frequency to setup the scope acquisition parameters.  <b>Note:</b> Ripple RMS is measured at the configured ripple frequency Available when the power measurement = <b>Line Ripple</b> .
<b>Custom Frequency</b>	<b>Custom Frequency</b> Sets the custom frequency of the power signal source. Available only when <b>Line Frequency = Custom</b> .
<b>Switching Frequency</b>	Specify the operating frequency of the switching device. <b>Power Autoset</b> uses the selected frequency to set the oscilloscope acquisition parameters. Frequency range is 50 Hz to 1 MHz. Only available when the power measurement = <b>Switching Ripple</b> .  <b>Note:</b> Ripple RMS is measured at the configured ripple frequency.

### Control Loop Response measurement configuration panel

See [Connection setup for Frequency Response Analysis \(FRA\) measurements](#) on page 252.

Field or control	Description
<b>Input Source</b>	Selects the channel connected to the input side of the DUT. Tap the field to show the list of available input sources.
<b>Output Source</b>	Selects the channel connected to the output side of the DUT. Tap the field to show the list of available output sources.
<b>Label</b>	Sets the name of the measurement. You can use the default name, or double-tap in the field and change the label using a connected keyboard or the virtual keyboard.
<b>Generator</b>	Sets the signal source to <b>Internal</b> or <b>External</b> and generates stimulus as a series of sine waves with configured amplitude. The sine waves are sent to the input of the DUT. The AFG31000 Series and AFG3000 Series are the supported external signal source.
<b>Connection</b>	When Generator is set to External, Connection opens the AFG configuration menu. Enter the IP address and tap Test Connection to connect to the signal generator.
<b>Impedance</b>	A user configurable Impedance for the generator. Sets the impedance as <b>50 Ω</b> or <b>High Z</b> .
<b>Points Per Decade</b>	Sets the number of frequency points between the start and stop frequency in terms of log scale. The minimum and default value is 10 frequency points. The maximum value is 100.
<b>Start Frequency</b>	Sets the generator start frequency. The default start frequency is 100 Hz. The minimum value of start frequency is 10 Hz. Double-tap in the field and change the start frequency using a connected keyboard or the virtual keyboard.

Table continued...

Field or control	Description
<b>Stop Frequency</b>	Sets the generator stop frequency. The default stop frequency is 20 MHz. The maximum stop frequency depends on the generator. The maximum stop frequency is 50 MHz or internal generator. Double-tap in the field and change the stop frequency using a connected keyboard or the virtual keyboard.
<b>Amplitude Mode</b>	Sets the built-in signal generator output amplitude mode. <b>Constant</b> Sets the constant amplitude for all frequencies in the internal signal generator. <b>Profile</b> Opens a configuration menu to set the amplitude for each frequency band. The generator uses the amplitude values to set the output amplitude as the frequency changes. Refer <a href="#">Sample amplitude values for a DC-DC convertor DUT</a> on page 255 table for amplitude values.
<b>Configure Profile</b>	Opens the <b>Profile</b> configuration menu to enter the frequency range with amplitude values. See <a href="#">Configure Profile</a> on page 254. Available when <b>Amplitude Mode</b> is <b>Profile</b> .
<b>Amplitude</b>	Sets the generator to apply the same amplitude to all frequencies output from the generator. The minimum value is 20 mV for the internal generator. Refer <a href="#">Sample amplitude values for a DC-DC convertor DUT</a> on page 255 table for amplitude values. The default value is 100 mV. Available when <b>Amplitude Mode</b> is <b>Constant</b> .
<b>Analysis Method</b>	Allows you to toggle between FFT or Spectrum view. Default is Spectrum View.
<b>Auto RBW</b>	Allows you to automatically calculate RBW and Span based on the center frequency. Available when <b>Analysis Method</b> is <b>Spectrum view</b> .
<b>Measure On</b>	Allows you to toggle between Spectrum Average or Single Sequence. Default is Single Sequence. Available when <b>Analysis Method</b> is set to <b>Spectrum View</b> .
<b>Phase Wrap</b>	When <b>Phase Wrap</b> is checked, the phase trace is unwrapped where the trace jumps more than the number of degrees set in the adjacent field. The default value is 180°.



**Note:** Math sources are not supported for Control Loop Response (Bode) , PSRR, and Impedance measurements.

## Power Supply Rejection Ratio (PSRR) measurement: Configure panel

See [Connection setup for Frequency Response Analysis \(FRA\) measurements](#) on page 252.

Field or control	Description
<b>Generator</b>	Generates stimulus, as a series of sine waves with configured amplitude, which are sent to the input of the DUT.  Supported signal generator is Internal and External signal source. AFG31000 series and AFG 3K series are the supported external signal source.
<b>Connection</b>	Opens AFG configuration menu. Enter the IP address and click <b>Test Connection</b> to connect to the signal generator.  Available only when Generator = <b>External</b> .
<b>Impedance</b>	Sets the output impedance of the built-in signal generator

Table continued...

Field or control	Description
<b>Points Per Decade</b>	Sets the number of frequency points between the start and stop frequency in terms of log scale. The minimum value is 10, maximum value is 100, and the default is 10.
<b>Start/Stop Frequency</b>	Sets the generator start and stop frequency. The maximum stop frequency depends on the built-in signal generator. The start frequency is 100 Hz, the stop frequency is 20 MHz, and the default is 100 Hz.
<b>Amplitude Mode</b>	Sets the built-in signal generator output amplitude mode. <b>Constant:</b> Sets the constant amplitude to all frequencies in the built-in signal generator. <b>Profile:</b> Opens a configuration menu that lets you set the amplitude for each frequency band. The generator uses the values in the table to set the output amplitude as the frequency changes.
<b>Configure Profile</b>	Opens <b>Profile</b> configuration menu to enter the frequency range with amplitude values. See <a href="#">Configure Profile</a> on page 254. Available only when Amplitude mode = <b>Profile</b> .
<b>Amplitude</b>	Sets the generator to apply the same amplitude to all frequencies output from the generator. The minimum value is 20 mV as per internal generator, the maximum value is whatever the generator supports, and the default is 100 mV. Available when Amplitude mode = <b>Constant</b> .
<b>Analysis Method</b>	Allows you to toggle between FFT or Spectrum view. Default is Spectrum.
<b>Auto RBW</b>	Allows you to automatically calculate RBW and Span based on the center frequency. Available when Analysis method = <b>Spectrum view</b> .

### Impedance measurement: Configure panel

See [Connection setup for Frequency Response Analysis \(FRA\) measurements](#) on page 252.

Field or control	Description
<b>Splitter</b>	Select the splitter as <b>Passive</b> or <b>Active</b> . By default splitter is Active. <a href="#">Connection setup for Frequency Response Analysis (FRA) measurements</a> on page 252 to view the connection diagram for active and passive splitter.
<b>Generator</b>	Generates stimulus, as a series of sine waves with configured amplitude, that is sent to the DUT input. Supported signal generator is Internal and External signal source. AFG31000 series and AFG 3K series are the supported external signal source.
<b>Connection</b>	Opens the AFG configuration menu. Enter the IP address of the external generator and click <b>Test Connection</b> to connect to the signal generator. Available only when <b>Generator</b> is <b>External</b> .
<b>Impedance</b>	Sets the output impedance of the built-in signal generator to 50 Ω.
<b>Analysis Method</b>	Allows you to toggle between FFT or Spectrum view. Default is Spectrum.

Table continued...

Field or control	Description
<b>Points Per Decade</b>	Sets the number of frequency points between the start and stop frequency in terms of log scale. The minimum value is 10, maximum value is 100, and the default is 10.
<b>Start/Stop Frequency</b>	Sets the generator start and stop frequency. The maximum stop frequency depends on the built-in signal generator. The start frequency is 100 Hz, the stop frequency is 20 MHz.
<b>Amplitude Mode</b>	Sets the built-in signal generator output amplitude mode. <b>Constant:</b> Sets the constant amplitude to all frequencies in the built-in signal generator. <b>Profile:</b> Opens a configuration menu that lets you set the amplitude for each frequency band. The generator uses the values in the table to set the output amplitude as the frequency changes.
<b>Configure Profile</b>	Opens the <b>Profile</b> configuration menu to enter the frequency range with amplitude values. See <a href="#">Configure Profile</a> on page 254. Available when <b>Amplitude Mode</b> is <b>Profile</b> .
<b>Amplitude</b>	Sets the generator output to apply the same amplitude to all frequencies. The minimum value is 20 mV for the internal generator, the maximum value is whatever the generator supports, and the default is 100 mV. Available when <b>Amplitude Mode</b> is <b>Constant</b> .
<b>Auto RBW</b>	Allows you to automatically calculate RBW and Span based on the center frequency. Available when <b>Analysis Method</b> is <b>Spectrum View</b> .
<b>Measure On</b>	Allows you to toggle between Spectrum Average or Single Sequence. Default is Single Sequence. Available when <b>Analysis Method</b> is set to <b>Spectrum View</b> .
<b>Phase Wrap</b>	When <b>Phase Wrap</b> is checked, the phase trace is unwrapped where the trace jumps more than the number of degrees set in the adjacent field. The default value is 180°.



**Note:** For Impedance measurement, you are recommended to use constant amplitude for all frequencies.

## Other measurement configuration panels

[Reference Levels panel \(Measurement configuration menu\)](#) on page 212

[Power Measurement Name panel \(Measurement configuration menu\)](#) on page 239

[Configure panel \(Measurement configuration menu\)](#) on page 212

[Gating panel \(Power measurement configuration menu\)](#) on page 262

## Connection setup for Frequency Response Analysis (FRA) measurements

Frequency Response Analysis (FRA) measurements include Control Loop Response (Bode), Power Supply Rejection Ratio (PSRR), and Impedance measurements.

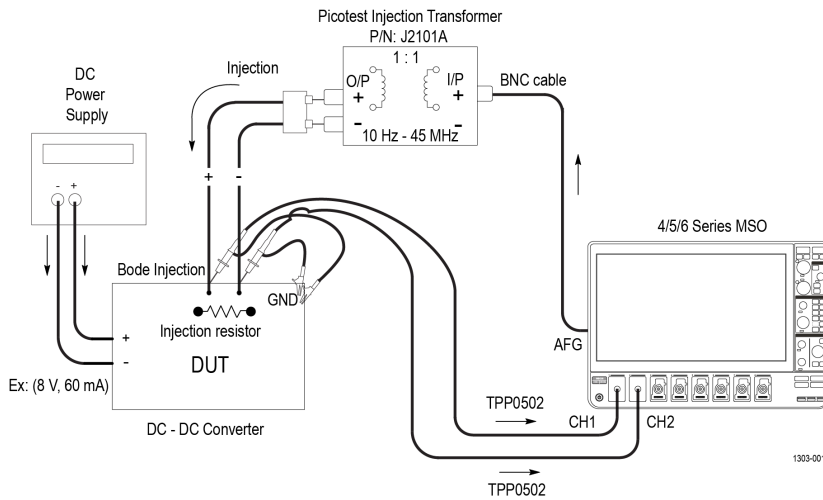

Note: To perform BODE measurement, inject stimulus signal from AFG over a band of frequencies to the control loop feedback path of the power convertor. To facilitate the signal injection, a small resistor needs to be inserted in the feedback loop. The injection resistor value should be of < 10 Ohms (recommended value is around 5 Ohms).

Figure 15: Connection diagram for Bode measurement

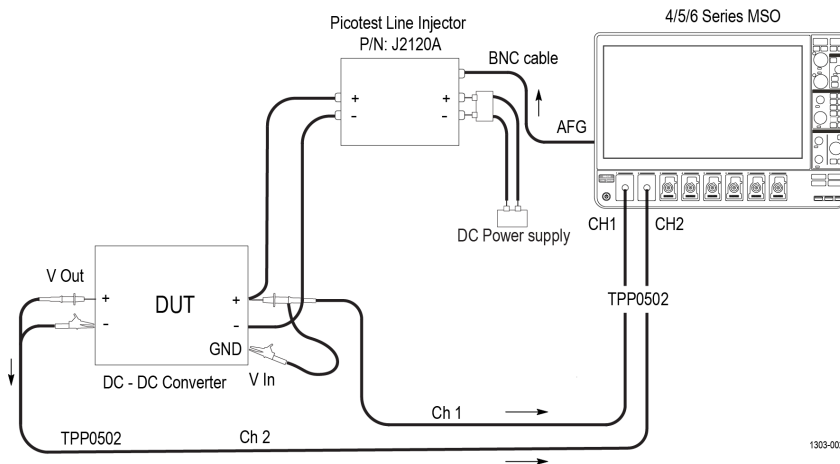
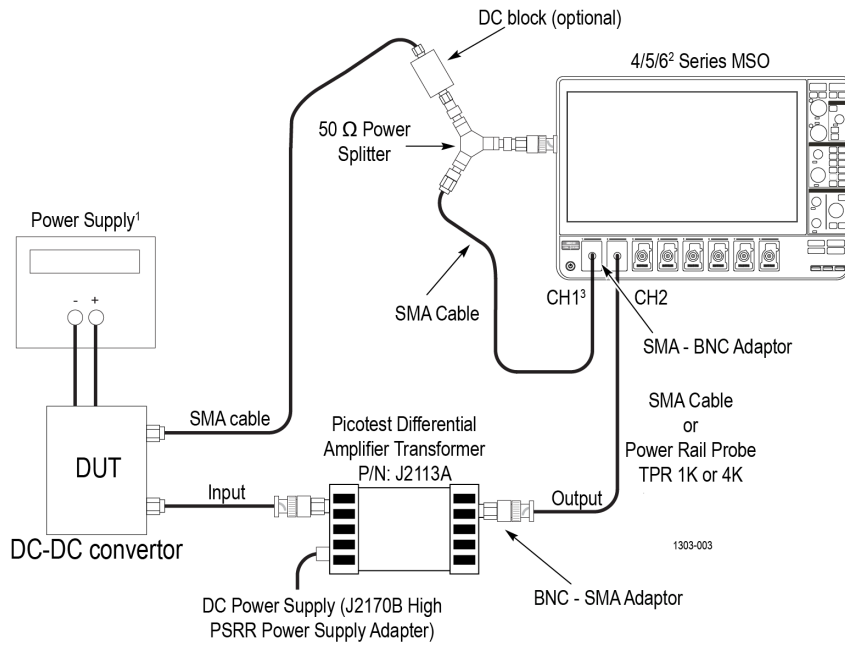

Figure 16: Connection diagram for PSRR measurement





<sup>1</sup>Source of power supply can be a DC power supply unit or USB connector  
<sup>2</sup>6 Series MSO Oscilloscope contains 4 channels only  
<sup>3</sup>It is recommended to use DC block at CH1/CH2 of the oscilloscope, if there is a DC offset in the signal.

Figure 17: Connection diagram for Impedance measurement (Passive Splitter)

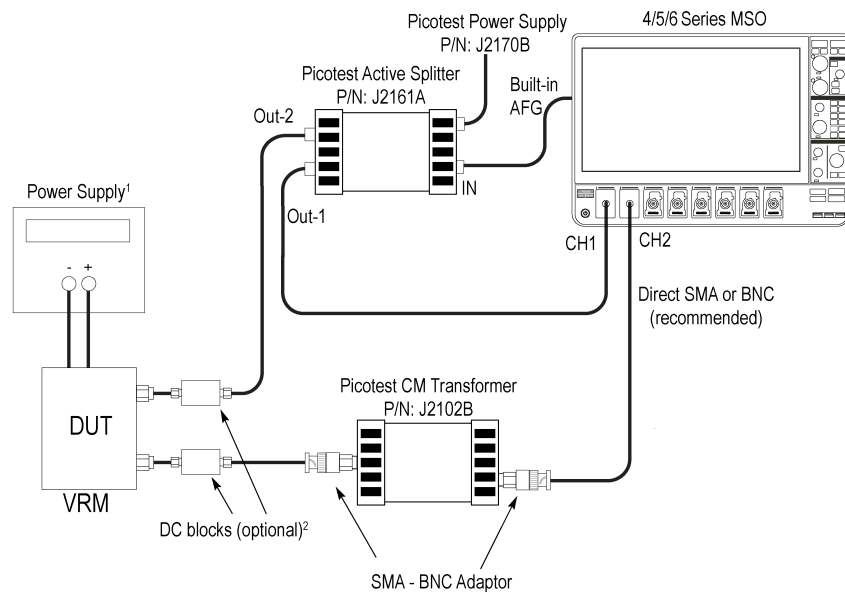

<sup>1</sup>Source of power supply can be a DC power supply unit or USB connector.  
<sup>2</sup>DC Blocks are optional for passive DUTs. They are required if DC voltage is being applied to the DUT (Active DUT).

1303-006

Figure 18: Connection diagram for Impedance measurement (Active Splitter)

FRA measurements are supported for 4/5/6 oscilloscope models.

**Note:**



1. It is recommended to use a splitter with the built-in AFG source for Impedance measurements. If you use an external AFG, use a single channel with a splitter.

2. Negative values are not displayed in the impedance plot. They are replaced by the most previous positive value.

Use the following steps to make the FRA measurements:

1. Make the connections as shown in the diagram.
2. Power on the DUT and transformer, if required.
3. Configure the measurements and analyze the results.

## Connect to an external signal generator

Use the Generator Connection Information menu to connect to a signal generator. This option is available only when the generator configuration is set to External.

Field or control	Description
IP address	Enter the IP address of the instrument.
Test Connection	Click to test the connection with the instrument.



**Note:** It is recommended to use the internal signal generator with splitter for impedance measurement. If you use an external signal generator, use a single channel with splitter.

## Configure Profile

Use the **Configure Profile** menu to configure the amplitude profile for the Power Supply Rejection Ratio (PSRR), and Control Loop Response (Bode) measurements, and Impedance measurements.

It is recommended to customize the internal signal generator amplitude values using the amplitude profile configuration. Profiling allows you to set the generator to a lower amplitudes, at different frequencies where the DUT is sensitive, and set the higher amplitudes where the DUT is less sensitive to distortion. A Switched-mode Power Supply (SMPS) is very sensitive near the zero degree cross over frequency, so it is advisable to define a profile, instead of using a constant amplitude output signal.

The following table list the available configurations.

Field or control	Description
Start	Displays the start frequency.
Stop	Displays the stop frequency.
Amplitude	Shows the amplitude value used to set the AFG level.
Insert Step	Inserts an additional row displaying start, stop, and amplitude values.
Delete Step	Deletes the selected row.
Clear Table	Clears all the values in the table.

Use the following steps to configure the amplitude profile for a PSRR and Control Loop Response (Bode) measurement:

1. Tap **Configure Profile** button. The configure profile dialog is displayed. The configure profile dialog displays two rows:
  - The start frequency in the first row is the start frequency from the PSRR/Control Loop Response measurement configuration panel.
  - The stop frequency in the first row is the mean of start and stop frequency values from the PSRR/Control Loop Response measurement configuration panel.
  - The start frequency of the second row is greater than the stop frequency from the PSRR/Control Loop Response/Impedance measurement configuration panel.

- The stop frequency in the second row is the stop frequency from the PSRR/Control Loop Response measurement configuration panel.
2. Edit the values as necessary to reduce the variations in the gain curve at particular frequencies where the DUT is sensitive to distortion. Adjust by making configuration changes and viewing the response in the gain/phase curve of the Control Loop Response/ PSRR plot.
  3. Tap outside the configure profile table save your updates.

### Sample amplitude values for a DC-DC convertor DUT

Start	Stop	Amplitude
10 Hz	100 Hz	1 V
100 Hz	500 Hz	800 mV
500 Hz	1 kHz	600 mV
1 kHz	10 kHz	400 mV
10 kHz	100 kHz	350 mV
100 kHz	1 MHz	300 mV
1 MHz	10 MHz	250 mV
10 MHz	20 MHz	200 mV



**Note:** The maximum stop frequency value for the internal signal generator is 50 MHz.

## Power Autose

Sets the oscilloscope acquisition system for optimal measurement results for all active power measurements except Turn On Time, Turn Off Time, Input Capacitance, Inrush Current, Control Loop Response, Power Supply Rejection Ratio (PSRR), and Impedance measurement.

Use the following steps to run a **Power Autose** on applicable power measurements:

1. Add the power measurements that you want to take to the Results bar.
2. Configure each power measurement individually (input voltage sources, current sources, label name, and so on).
3. Connect the input signals to the instrument and confirm the waveforms are correct and not clipping.
4. Double-tap the power measurement result badge for which you want to take a measurement.
5. Tap the **Power Autose** button for the measurement and wait for the busy indicator to disappear. The instrument has now been optimized for that power measurement.

#### Note:

- In case of failure, the instrument displays a popup error message. See [Errors and Warnings](#).
- When different frequency signals are connected to different channels, **Power Autose** uses the AC signal of the lowest-numbered channel to evaluate and set up the instrument parameters. For example, if Channel 1 is connected to a DC signal, Channel 2 is connected to an AC signal of 1 MHz, and Channel 4 is connected to an AC signal of 1 kHz, then **Power Autose** uses Channel 2 (the first channel with an AC signal) to set up the instrument parameters. Channel 4 may not be set up to see the minimum number of cycles properly; you may need to manually set the Channel 4 parameters.
- **Power Autose** runs all parts of instrument Autose, even if some parts have been disabled in the **User Preferences > Autose** panel. See [Autose panel fields and controls](#) on page 487 for more information on the Autose function.
- **Power Autose** is available per measurement. You should run the Power Autose for each measurement separately when you add measurements, to ensure optimum power measurement setup for that measurement.



6. Record the power measurement after the **Power Autoset** completes.
7. Repeat steps 4 on page 255 - 6 on page 256 for other Power measurements that you want to take.

## Power Preset

Sets the oscilloscope vertical, horizontal and acquisition parameters using the user inputs like peak voltage and current for Input Capacitance, Inrush Current, Turn On Time, and Turn Off Time. For Control Loop response and PSRR measurements, it sets the built-in generator such as start frequency, impedance, and amplitude values and also sets the vertical and horizontal acquisition parameters, so that oscilloscope is ready to acquire the desired waveform once the measurement starts.



**Note:** The **Power Preset** button is available only for Input Capacitance, Inrush Current, Turn On Time, Turn Off Time, Control Loop Response, and Power Supply Rejection Ratio power measurements.

Use the following steps to run a **Power Preset** on applicable power measurements:

1. Add the supported power measurements to the **Results** bar.
2. Double-tap each Measurement badge and configure the measurement (input voltage sources, current sources, label name, and so on).
3. Connect the input signals.
4. Tap the **Power Preset** button in the measurement configuration to set.

To set the vertical and horizontal acquisition parameters:

- a. Measurement configuration begins and displays a window (displayed only for FRA measurements).

**Note:**



- When the measurement runs, you cannot operate oscilloscope front panel buttons.
- You can change the ACQ modes to Sample mode after **Power Preset** is clicked and before oscilloscope **RUN/STOP** is performed

- b. To stop the measurement configuration or to operate the front panel buttons, click the **Abort** button on the window.

**Note:**



- When the FRA measurement is configured, the window disappears.
- When FRA measurement is run with Spectrum view and if the Acquisition subsystem error message is displayed, click OK button and proceed with the measurement. There is no need to power cycle the instrument as indicated in the message.

- c. Tap **Run/Stop** on the front panel of the oscilloscope.
5. Follow the instructions on the Measurement badge to take the power measurement.

## SOA Mask definition controls and fields

Use the SOA Mask dialog to configure the parameters to add point, delete point, save mask, and recall mask.

Use the parameters to define the linear mask for an SOA measurement.

### Define Mask fields and controls

Field or control	Description
X (Volts)	Define voltage values for the mask point.
Y (Amps)	Define current values for the mask point.
Insert Point	Add voltage and current points to define mask. Points are added to the end of the existing list.
Delete Point	Deletes the selected point data row.

Table continued...

Field or control	Description
<b>Save Mask</b>	Opens the <b>Save As</b> menu to navigate to and select the location at which to save the SOA mask data as a .pwrmsk file.
<b>Recall Mask</b>	Opens the <b>Open</b> menu to navigate to and select the location from which to recall (load) the SOA mask data .pwrmsk file.   <b>Note:</b> Mask files created with oscilloscope firmware version 1.4.x cannot be used in firmware version 1.6.x. Use version 1.6.x and later to create and recall mask files.
<b>Clear Table</b>	Clears the values of the mask coordinates in the table.

The following image shows the default SOA mask and its associated mask point table.

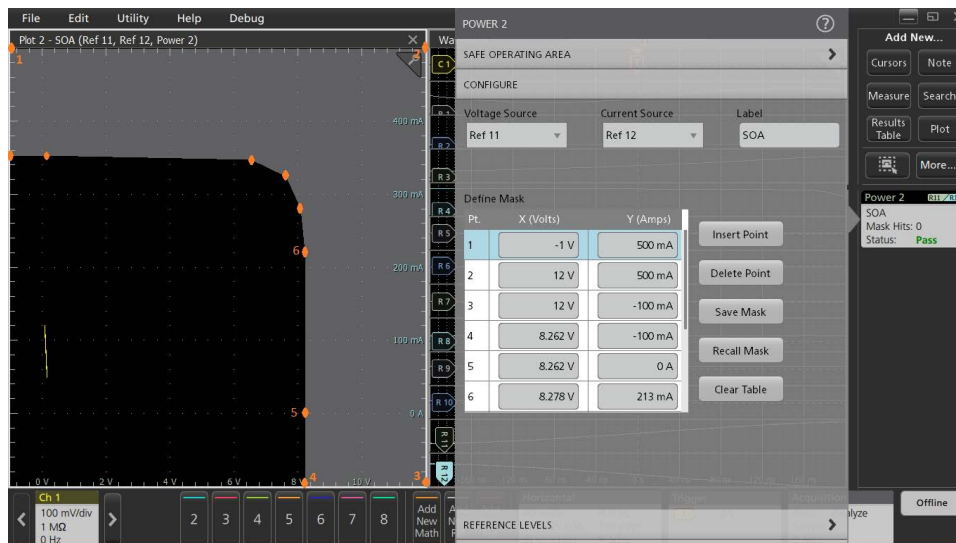

**Note:** You need to define both internal and external points.

## Save Mask menu (SOA power measurement)

Use this menu to save a SOA power measurement mask file to a specified location.

**Prerequisite:** Open the **Configure** panel of the SOA measurement for which you want to save a mask file (.pwrmsk).

To open the Save Mask configuration menu:

1. Tap the **Save Mask** button to open the **Save As** menu.
2. Use the menu fields and controls to navigate to and select the location to save the SOA mask file.

## Save As configuration menu (SOA mask file)

Field or control	Description
<b>Save Location</b>	<p>Lists the location where the file will be saved. The default value is the last location to which a file was saved.</p> <p>Use the <b>Browse</b> button to quickly navigate to the location to which to save the file. Or you can tap on the file path and use a keyboard to enter a new save location. Or double-tap on the file name to open the virtual keyboard and enter a path.</p> <p>Tap the down arrow icon on the right end of the field to open a list of recent file save locations for the current save type.</p>
<b>Browse</b>	<p>Tap to open the Browse Save As Location configuration menu, to navigate to the location to which to save the file. See <a href="#">Browse Save As Location configuration menu</a> on page 477.</p> <p>You can navigate to TekDrive for saving mask files.</p>
<b>File Name</b>	<p>The file name assigned to the file. The default value is either the user-entered name used to last save this file type, or the default value of Tek000.</p> <p>Tap the down arrow on the right edge of the field to display and select from a list of recently-saved file names.</p> <p>Tap on the file name and use a keyboard to enter a new file name. Or double-tap on the file name to open the virtual keyboard and enter a file name.</p>
<b>Save As Type</b>	You can only save SOA mask files as type .pwrmsk.
<b>Cancel</b>	Cancels the file save action and closes the configuration menu. You can also cancel the save operation by tapping anywhere outside the menu.
<b>Save</b>	Saves the file to the specified location, closes the Save As configuration menu, and displays a confirmation message.

## Recall Mask menu (SOA power measurement)

Use this menu to recall (load) a .pwrmsk mask file for an SOA power measurement plot.

**Prerequisite:** Open the **Configure** panel of the SOA measurement for which you want to recall a mask (pwrmsk) file.



**Note:** Mask files created with oscilloscope firmware version 1.4.x cannot be used in firmware version 1.6.x. Use version 1.6.x and later to create and recall mask files.

To open the Recall Mask configuration menu:



1. Tap the **Recall Mask** button to open the **Recall** menu.
2. Use the menu fields and controls to navigate to and select the mask file to recall.

## File operations and Microsoft Windows 10 Operating System SSD

Instruments with Windows 10 SSD will display the standard Windows file tools to navigate to and select files and folders.

The Windows operating system assigns the first available drive letter (typically E:) to the first USB device attached to the oscilloscope, regardless of which port the USB device is plugged into. The next plugged-in USB device is assigned the next available drive letter (such as F:) and so on for other installed devices. This is different from standard instruments (without Windows 10 installed), which assign a non-changing drive letter to each USB port.

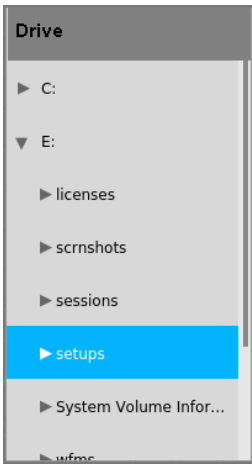
## Recall file configuration menu (SOA mask file)

Field or control	Description
Look in:	Shows the current directory path to the location of a file. Tap on the file path and use a keyboard to enter a new save location. Or double-tap on the file name to open the virtual keyboard and enter a path. Tap the down arrow icon on the right end of the field to open a list of recent file save locations, up to a maximum of 20 locations.
	The Drive column lists the directory structure, opening at the root (/) level. Use to quickly navigate to a location. Tap to list the contents of the directory in the Name pane. Double-tap an item to display the directory and any subdirectories under it. Double-tap again to close that directory structure. Drag the list up and down to show more entries. You can navigate to the TekDrive location for recalling the saved mask files.
	Use the arrow buttons to navigate the file directory. The left arrow navigates back to the previously visited folder. The Right arrow navigates forward to the previously visited folder. The Up arrow navigates up one level from the current folder.
	Use to create a new directory (folder) at the current location. Opens the new directory after it is created.
File name	Lists the selected file name to recall. Tap on the file name in the Name column to add it to this field.
Files of type	The SOA mask file type (.pwrmsk) cannot be changed.
Cancel	Cancels the file recall action and closes the menu.
Recall	Recalls the selected SOA mask file and plots it on the SOA Plot view.

## USB port drive names and locations

Use the following table to determine which drive to select when navigating to and/or selecting a file on system memory or a connected USB memory device.

Drive name	Drive letter	Drive or physical USB port location
<b>MSO44B and MSO46B</b>		
Root drive	C	User-accessible memory on the oscilloscope.

Table continued...

Drive name	Drive letter	Drive or physical USB port location
Front panel	E	USB 2.0 (top)
	F	USB 2.0 (middle)
	G	USB 2.0 (bottom)
Rear panel	H	USB 3.0 (left)
	I	USB 3.0 (right)

Drive name	Drive letter	Drive or physical USB port location
<b>MSO44 and MSO46</b>		
Root drive	C	User-accessible memory on the oscilloscope.
Front panel	E	USB 2.0 (top)
	F	USB 2.0 (middle)
	G	USB 2.0 (bottom)
Rear panel	H	USB 2.0 (left)
	I	USB 2.0 (right)

Drive name	Drive letter	Drive or physical USB port location
<b>MSO54, MSO56, MSO58, MSO54B, MSO56B, MSO58B, MSO64, LPD64, MSO64B, MSO66B, and MSO68B without Windows OS</b>		
Root drive	C	User-accessible memory on the oscilloscope.
Front panel	E	USB 3.0 (left)
	F	USB 2.0 (center)
	G	USB 2.0 (right)
Rear panel	H	USB 2.0 (top)
	I	USB 2.0 (bottom)
	J	USB 3.0 (top)
	K	USB 3.0 (bottom)
<b>Instruments with Windows OS</b>		
Root drive	C	User-accessible memory on the oscilloscope.
USB ports	<b>Dynamic port letter assignment</b>	If Windows operating system is installed, the Windows operating system assigns the first available drive letter (typically E:) to the first USB device attached to the oscilloscope, regardless of which port the USB device is plugged into. The next plugged-in USB device is assigned the next available drive letter (such as F:) and so on for other installed devices.  Use standard Windows procedures to mount and access network drives.

Drive name	Drive letter	Drive or physical USB port location
<b>MSO58LP without Windows OS</b>		
Root drive	C	User-accessible memory on the oscilloscope.

Table continued...



Drive name	Drive letter	Drive or physical USB port location
Front panel	E	USB 3.0 (left)
	F	USB 2.0 (right)
Rear panel	G	USB 2.0 (top)
	H	USB 2.0 (bottom)
	I	USB 3.0 (top)
	J	USB 3.0 (bottom)
<b>Instruments with Windows OS</b>		
Root drive	C	User-accessible memory on the oscilloscope.
USB ports	<b>Dynamic port letter assignment</b>	If Windows operating system is installed, the Windows operating system assigns the first available drive letter (typically E:) to the first USB device attached to the oscilloscope, regardless of which port the USB device is plugged into. The next plugged-in USB device is assigned the next available drive letter (such as F:) and so on for other installed devices.  Use standard Windows procedures to mount and access network drives.

Drive name	Drive letter	Drive or physical USB port location
<b>LPD64 without Windows OS</b>		
Root drive	C	User-accessible memory on the oscilloscope.
Front panel	F	USB 3.0 (left)
	E	USB 2.0 (center)
	G	USB 2.0 (right)
Rear panel	H	USB 2.0 (top)
	I	USB 2.0 (bottom)
	J	USB 3.0 (top)
	K	USB 3.0 (bottom)

## Reference Levels panel (Power measurement configuration Menu)

Use the Reference Levels panel to set the scope of the reference level settings (global or local), the measurement reference levels (High, Mid, and Low), the units used to take measurements, and the method used to calculate the Top and Base waveform values. You can set the reference levels to be the same or different for rising and falling edges.

See [Reference Levels panel \(Measurement configuration menu\)](#) on page 212 for the Reference panel fields and controls.

### Other measurement settings panels

[Power Measurement Name panel \(Measurement configuration menu\)](#) on page 239

[Configure panel \(Power measurement configuration menu\)](#) on page 239

[Gating panel \(Power measurement configuration menu\)](#) on page 262

## Gating panel (Power measurement configuration menu)

Use Gating to confine a measurement to a certain part of a waveform.

See [Gating panel \(Measurement configuration menu\)](#) on page 218 for the Gating panel fields and controls.

### See also

[Power Measurement Name panel \(Measurement configuration menu\)](#) on page 239

[Reference Levels panel \(Power measurement configuration Menu\)](#) on page 261

[Configure panel \(Power measurement configuration menu\)](#) on page 239

## IMDA measurement configuration menu overview

Use this configuration menu to configure the measurement that is added in the IMDA tab. You can plot a measurement, and change measurement settings including source, scope (global or local), reference levels, and gating.

**Prerequisites:** To get accurate results, do the following steps:

- Degauss current probe
- Deskew voltage and current channels
- Perform Oscilloscope SPC

To open the IMDA measurement configuration menu for a measurement, double-tap a IMDA measurement badge in the Results bar. The configuration menu and panels only show fields and controls relevant to the selected measurement.

The menu opens on the measurement name panel (the name of the measurement), which provides controls, display plots of the measurement, and so on. The measurement name panel only shows fields and controls relevant to the selected measurement.

1. Select the Sources of interest.
2. Select Edge configuration.
3. Provide information about the abc for electrical analysis order configured as the ABC connection on the DUT and xyz for output analysis measurements.
4. Configure the LPF and its order with the cut off frequency.
5. Configure REF levels based on noise on the acquired signals.
6. Configure gating to place cursors at the integral cycles.

### IMDA Measurement configuration menu fields, controls, and panels for Motor Analysis

Field, control, or panel	Description
Plots (Measurement name panel)	<p>Adds Phasor plot by default when Power Quality and DQ0 is added.</p> <p>Buttons that open Plot views of the measurement. Available plots depend on the measurement. Plot types include Phasor Diagram and Harmonics.</p> <p> <b>Note:</b> For PQ, Harmonics, DQ0 and Efficiency measurements Filtered Math waveform is added in the waveform view.</p> <p>To add a plot to the screen, tap the plot button.</p> <p>See <a href="#">Add Plot configuration menu</a> on page 336.</p>

Table continued...

Field, control, or panel	Description
<b>Configure panel</b>	Sets the label text, and other fields that are specific to each measurement type. See <a href="#">Configure panel (Measurement configuration menu)</a> on page 212.
<b>Reference Levels panel</b>	Sets the reference levels and units used to take measurements, the scope of the reference level settings (global or local), and the method used to calculate the Top and Base waveform values. See <a href="#">Reference Levels panel (Measurement configuration menu)</a> on page 212.
<b>Gating panel</b>	Sets the measurement region (gate) used to take measurements. Select the scope of the gate setting (global or local), and the type of gating to use. See <a href="#">Gating panel (Measurement configuration menu)</a> on page 218.

## IMDA Measurement Name panel (Measurement configuration menu)

The IMDA Measurement Name panel (the name of the measurement) provides controls for adding display statistics to the measurement badge and opening plots of the measurement.

To open the IMDA measurement name panel, double-tap a IMDA Measurement badge. This is the default panel shown when you open a IMDA Measurement settings menu.

The contents of the Measurement Name panel depends on the measurement.

Field or control	Description
<b>Three Phase Autose</b>	Sets the oscilloscope for optimal Horizontal, Vertical and Acquisition parameters for configured three phase wiring, based on the measurement.  Three Phase Autose sets up voltages and current sources based on the wiring configuration. The Autose optimally set up the vertical, horizontal, acquisition, and trigger parameters on the oscilloscope and will turn off all the unused channel sources and turn on the configured sources.
<b>Information</b>	Displays the warning details.
<b>Plots</b>	Adds a Plot view of the measurement value to the screen. Available plots depend on the measurement. Plot types include Phasor Diagram and Harmonics.

### See also

[Configure panel \(Measurement configuration menu\)](#) on page 212

[Reference Levels panel \(Measurement configuration menu\)](#) on page 212

[Gating panel \(Measurement configuration menu\)](#) on page 218

## Source Setup panel - Motor Analysis

Field or control	Description
<b>Source Setting</b>	Configure the Global or Local input or output, source, filter, and LL-LN conversion settings.
<b>Global</b>	Settings configured in the source setup panel is applicable to all active IMDA measurements.
<b>Local</b>	Settings configured in the source setup panel is applicable only to that measurement.
Table continued...	

Field or control	Description
<b>Configuration</b>	Configure to run IMDA measurements on either input or output side of the motor drive. Available options are: <ul style="list-style-type: none"> <li>• Input</li> <li>• Output</li> </ul>
<b>Input</b>	Sets source labels to Vab, Vbc, Vca, Ia, Ib, and Ic based on the selected wiring.
<b>Output</b>	Sets source labels to Vxy, Vyz, Vza, Ix, Iy, and Iz based on the selected wiring.
<b>Input Wiring</b>	Select the input wiring configuration from the drop-down: <ul style="list-style-type: none"> <li>• 1 Phase-2 Wire (1V1I)</li> <li>• 1 Phase-3 Wire (2V2I)</li> <li>• 3 Phase-3 Wire (2V2I)</li> <li>• 3 Phase-3 Wire (3V3I)</li> <li>• 3 Phase-4 Wire (3V3I)</li> <li>• 1 Phase-2 Wire DC (1V1I)</li> </ul>
<b>Output Wiring</b>	Select the output wiring configuration from the drop-down: <ul style="list-style-type: none"> <li>• 1 Phase-2 Wire (1V1I)</li> <li>• 1 Phase-2 Wire DC (1V1I)</li> <li>• 3 Phase-3 Wire (2V2I)</li> <li>• 3 Phase-3 Wire (3V3I)</li> <li>• 3 Phase-4 Wire (3V3I)</li> </ul>
<b>LL to LN Conversion</b>	Converts Line-to-Line into Line-to-Neutral using mathematical equation when Wiring = 3 Phase-3 Wire (3V3I). When there is no true Neutral wire, LL to LN conversion can be used instead of 3 Phase-4 Wire (3V3I) wiring. Available when <b>Wiring = 3 Phase-3 Wire (3V3I)</b>
<b>Connection</b>	Read only control; <ul style="list-style-type: none"> <li>• Line-to-Line for 3 Phase-3 Wire 2V2I and 3 Phase-3 Wire 3V3I</li> <li>• Line-to-Neutral for all other wirings.</li> </ul>
<b>Select Lines</b>	Sets the select lines as ab-cb, ac-bc, ba-ca for input configuration or xy-zy, xz-yz, yx-zx for Output configuration. Select line is available only for 3Phase-3Wire 2V2I wiring.
<b>Voltage Source</b>	Select the voltage source for the measurement. Tap the field to view the list of available sources.
<b>Current Source</b>	Select the current source for the measurement. Tap the field to view the list of available sources.
<b>Sensor Type</b>	Sets the sensor type as Hall Sensor, Quadrature Encoder Interface (QEI), or Resolver.
<b>Source</b>	Sets the source for the sensor type. <ul style="list-style-type: none"> <li>• <b>Hall Sensor:</b> Hall A, Hall B, and Hall C</li> <li>• <b>QEI:</b> Phase A, Phase B, and index Z</li> <li>• <b>Resolver:</b> Sin, Cos, and Ref</li> </ul>

Table continued...









Field or control	Description
<b>Index Z</b>	Select index Z box to enable the <b>Index Z</b> source. Available when <b>Sensor Type</b> is <b>QEI</b> .  <b>Note:</b> Index Z is disabled for Angle and DQ0 measurements.
<b>Index Z (Source)</b>	Set the input source for Index Z to identify zero degree mechanical rotor angle or position. Available when <b>Sensor Type</b> is <b>QEI</b> .
<b>Pulse per Rotation (PPR)</b>	Set the total number of Phase A and Phase B sequences per single shaft rotation. The minimum value is 1, and the maximum value is 100k. The default value is 1250. Available when <b>Sensor Type</b> is <b>QEI</b> .
<b>Pole Pairs</b>	Sets the number of pole pairs. The number of rotor pole pairs can be configured in the measurement pole pairs numeric keypad. Available when <b>Sensor Type</b> is <b>Hall Sensor</b> or <b>Resolver</b> .
<b>Gear Ratio</b>	Sets the gear ratio to increase or decrease the motor shaft speed compared to rotor speed.
<b>Edge Qualifier</b>	Configure the best source (with less noise) to extract the proper edges from the PWM source.  <b>Note:</b> Edge qualifier is not available for <b>Wiring = 1 Phase-2 Wire DC (1V1I)</b> .
<b>Low Pass Filter</b>	Blocks the high frequency band and passes only the low frequency band of the waveform. Select the Low pass filter (LPF) order ( <b>No Filter</b> , <b>1st</b> (default), <b>2nd</b> , or <b>3rd</b> ) to be applied on the configured analog sources.  <b>Note:</b> LPF is not applicable for digital channels.   <b>Note:</b> You can define IIR low pass filter for the input signal of interest by setting advanced math expression to "STATIC[LowPassFilterOrder = <filterOrder>,LowPassCutOffFreq = <cutoffFreq>] IIRFilterNV Ch<x> or Ref<x> or Math<x>)". Example of 1st order LPF with 500 Hz cutoff frequency: "STATIC[LowPassFilterOrder = First,LowPassCutOffFreq = 500]IIRFilterNV(ch1)".
<b>Cutoff Frequency (Fc)</b>	Sets the cutoff frequency for LPF. Default value is 500 Hz.
<b>Apply Filter On</b>	Applies filter on Edge qualifier or All sources.  <b>Note:</b> This option is available for Power quality and DQ0 measurement.   <b>Note:</b> Edge qualifier is not available for <b>Wiring = 1 Phase-2 Wire DC (1V1I)</b> .

Table continued...

Field or control	Description
Calculate Electrical theta using sensor input	<p>Set to calculate the theta using sensor output.</p> <p> <b>Note:</b> IMDA-MECH license is required.</p> <p> <b>Note:</b> This option is available for DQ0 measurement.</p>

## Configure panel (IMDA measurement configuration menu) - Motor Analysis

Use the configure panel to add a custom name (label) for the measurement and other parameters.

To open the Configure panel for a IMDA measurement:

1. Double-tap a IMDA measurement badge to open the IMDA measurement configuration menu.
2. Tap the **Configure** panel.

### Direct Quadrature Zero Transformation (DQ0-IMDA DQ0 license is required)

Field or control	Description
Label	Sets the name of the measurement. You can use the default name, or double-tap in the field and change the label using a connected keyboard or the virtual keyboard.
Source Type	Toggle between voltage source or current source.
Units	Sets the unit as Degree or Radians.
Offset Angle	<p>Sets the offset angle. Configure the offset (electrical) angle:</p> <ul style="list-style-type: none"> <li>• To adjust if there is any position misalignment of the mounted encoder/sensors.</li> <li>• If there is any low pass filter delay after applying the filter on the electrical signals.</li> </ul>



**Note:** When **Apply Filter On** is selected for **All Sources**, the filter is applied only on all electrical sources.



**Note:** If analog sources are configured for electrical measurement and digital sources for mechanical measurement then enter the low pass filter phase delay and position misalignment combined as offset angle.

### See also

[Source Setup panel - Motor Analysis](#) on page 263

## Power Quality measurement: Configure panel

Field or control	Description
Label	Sets the name of the measurement. You can use the default name, or double-tap in the field and change the label using a connected keyboard or the virtual keyboard.
Calculate One Measurement Per Cycle or Record	Calculates the measurements per cycle or record. Default is Cycle.

Table continued...

Field or control	Description
<b>Calculate Over Full Cycles</b>	Calculates over the complete cycles. Default it is enabled. Available only when <b>Calculate Measurement Per Cycle or Record = Record</b> .
<b>Calculate Over Fundamental Frequency</b>	Set the analysis method to determine the measurement frequency. Fundamental configuration does analysis on Fundamental component. All frequencies does analysis on Fundamental and all harmonics. Available only when <b>Calculate Measurement Per Cycle or Record = Cycle</b> .  <b>Note:</b> Currently this method works for PF and Phase values.

For Line to Line in 2V2I and 3V3I 3-Phase 3-wire wiring displays PQ results as the SUM of True, Apparent, and Reactive power components of all phases.

For Line to Neutral in 3P3W (with LN mathematical conversion) and 3P4W mode displays both True, Apparent and Reactive power values per phase and SUM powers of all the phases.



**Note:** The sign of reactive power is not accounted for 2V2I for Sum of Reactive powers and in case of 3V3I the sign of per phase Reactive power components are computed in LL-LN mode.

## See also

[Source Setup panel - Motor Analysis](#) on page 263

## Harmonics measurement: Configure panel

Field or control	Description
<b>Label</b>	Sets the name of the measurement. You can use the default name, or double-tap in the field and change the label using a connected keyboard or the virtual keyboard.
<b>Line Frequency</b>	Sets the line frequency of the power signal source. In Auto mode, the application measures the frequency of the input signal automatically. Input signal is used to compute harmonics in the current source. Default is Auto.
<b>Fundamental Frequency</b>	Sets the motor operating frequency. Available when <b>Line Frequency</b> is <b>Custom</b> .
<b>Harmonics Range From, To</b>	Sets the beginning and end of range of harmonics values. Range is from 1 and 200 (Default is 1 to 50).
<b>Standard</b>	<ul style="list-style-type: none"> <li>• NONE</li> <li>• IEC61000-3-2</li> <li>• IEEE 519-2014</li> <li>• IEEE 519-2022</li> <li>• CUSTOM</li> </ul> See <a href="#">Set modify custom limits</a> on page 275

Table continued...

Field or control	Description
<b>Load Limits</b>	Sets the limits for the measurement. Pass/Fail status uses the custom limits. Sample limits are available for Path to default custom limits file.  Available only when <b>Standard is Custom</b> .
<b>Harmonics Source</b>	Compute the harmonics. For example IEC61000-3-2 will use Current source. <ul style="list-style-type: none"> <li>• Voltage</li> <li>• Current</li> </ul> Available only when <b>Standard is None</b> .
<b>Class</b>	Sets the class for standard as Class A, Class B, Class C, and Class D.  Available only when <b>Standard is IEC61000-3-2</b> .
<b>Power Factor</b>	Sets the power factor. Available when <b>Standard is IEC61000-3-2</b> and <b>Class is Class C</b> .
<b>Fundamental Current</b>	Sets the fundamental current for the signal. Available when <b>Standard is IEC61000-3-2</b> and <b>Class is Class C</b> .
<b>Input Power</b>	Sets the input power of the signal. Available when <b>Standard is IEC61000-3-2</b> and <b>Class is Class C or Class D</b> .

**See also**

[Source Setup panel - Motor Analysis](#) on page 263

**Efficiency measurement: Configure panel**

Efficiency measurement related configurations are done in **Source Setup** panel. See [Source Setup panel - Motor Analysis](#) on page 263

**Ripple measurement: Configure panel**

Field or control	Description
<b>Label</b>	Sets the name of the measurement. You can use the default name, or double-tap in the field and change the label using a connected keyboard or the virtual keyboard.
<b>Ripple Frequency</b>	Sets the ripple frequency of the voltage/current source.  Input signal is used to compute ripple in the configured source. Default is 50 Hz.
<b>Custom Frequency</b>	Custom Frequency Sets the custom frequency of the power signal source. Available only when <b>Ripple Frequency = Custom</b> .

**See also**

[Source Setup panel - Motor Analysis](#) on page 263

**Speed measurement: Configure panel**

Field or control	Description
<b>Units</b>	Sets the units for speed as RPM or Hz.

Table continued...



Field or control	Description
Label	Sets the name of the measurement. You can use the default name, or double-tap in the field and change the label using a connected keyboard or the virtual keyboard.
Calculate One Measurement Per	Sets the amount of waveform data to use to calculate one measurement; one measurement across the entire mechanical rotation or for each cycle of the waveform.

**See also**

[Source Setup panel - Motor Analysis](#) on page 263

**Direction measurement: Configure panel****Direction measurement: Configure panel for Hall Sensor**

Field or control	Description
Sequence of Hall Edges	Sets the sequence of direction. Select the sequence of Hall Edges as A-B-C or A-C-B.
Label	Sets the name of the measurement. You can use the default name, or double-tap in the field and change the label using a connected keyboard or the virtual keyboard.

**Direction measurement: Configure panel for QEI**

Field or control	Description
Direction of Motor Rotation	Sets the sequence of motor direction as CW or CCW. The Ph A- Ph B sequence of edges represents CW (clockwise) rotation and Ph B- Ph A represents CCW (counter clockwise) rotation.
Label	Sets the name of the measurement. You can use the default name, or double-tap in the field and change the label using a connected keyboard or the virtual keyboard.

**See also**

[Source Setup panel - Motor Analysis](#) on page 263

**Angle measurement: Configure panel**

Field or control	Description
Units	Sets the units for angle as Degrees or Radians. The default is degrees.
Label	Sets the name of the measurement. You can use the default name, or double-tap in the field and change the label using a connected keyboard or the virtual keyboard.
Offset Angle	Sets the mechanical offset angle.

**See also**

[Source Setup panel - Motor Analysis](#) on page 263

## Torque measurement measurement: Configure panel

Use this configuration menu to configure the torque and mechanical power measurements.



**Note:** Torque measurement does not support Source Setup panel configuration since the configuration is unique to Torque measurement only.

Field or control	Description
<b>Torque Method</b>	Sets the torque method as <b>Sensor</b> or <b>Current</b> .
<b>Label</b>	Sets the name of the measurement. You can use the default name, or double-tap in the field and change the label using a connected keyboard or the virtual keyboard.
<b>Torque Source</b>	Sets the torque source for the measurement. Tap the field to view the list of available sources.
<b>Low Pass Filter</b>	Blocks the high frequency band and passes only the low frequency band of the waveform. Select the Low pass filter (LPF) order (No Filter, 1st (default), 2nd, or 3rd) to be applied for the configured analog sources.  Available when <b>Torque Method</b> is <b>Current</b> .
<b>Cutoff Frequency (Fc)</b>	Sets the cutoff frequency for LPF. Default value is 500 Hz.  Available when <b>Torque Method</b> is <b>Current</b> .
<b>Units</b>	Sets the unit for torque as <b>N-m</b> , <b>Oz-inch</b> , <b>ft-lb</b> , or <b>inch-lb</b> . <ul style="list-style-type: none"> <li>• Newton Meters (N-m)</li> <li>• Foot pounds (ft-lb)</li> <li>• Inch ounces (Oz-inch)</li> <li>• Inch pounds (inch-lb).</li> </ul>
<b>Sensor Specification</b>	
<b>Low Torque</b>	Sets the low torque value for the sensor.  Available when <b>Torque Method</b> is <b>Sensor</b> .
<b>High Torque</b>	Sets the high torque value for the sensor.  Available when <b>Torque Method</b> is <b>Sensor</b> .
<b>Low Voltage</b>	Sets the low voltage output value for the sensor.  Available when <b>Torque Method</b> is <b>Sensor</b> .
<b>High Voltage</b>	Sets the high voltage output value for the sensor.  Available when <b>Torque Method</b> is <b>Sensor</b> .
<b>Torque Constant</b>	Sets the torque constant value to be multiplied with the RMS value of the current.  Available when <b>Torque Method</b> is <b>Current</b> .

## Mechanical Power measurement: Configure panel

Mechanical Power measurement configuration menu has two configuration panel.

For Torque configuration panel, refer [Torque measurement measurement: Configure panel](#) on page 270.

For Speed configuration panel, refer [Speed measurement: Configure panel](#) on page 268.

## System Efficiency measurement: Configure panel

For Electrical configuration panel, refer [Source Setup panel - Motor Analysis](#) on page 263.

For Torque configuration panel, refer [Torque measurement measurement: Configure panel](#) on page 270.

For Speed configuration panel, refer [Speed measurement: Configure panel](#) on page 268.

## Other measurement configuration panels

[Reference Levels panel \(Measurement configuration menu\)](#) on page 212

[IMDA Measurement Name panel \(Measurement configuration menu\)](#) on page 263

[Configure panel \(Measurement configuration menu\)](#) on page 212

[Gating panel \(IMDA measurement configuration menu\)](#) on page 276

## Connection setup for IMDA measurements

Following are the connection setup diagrams for 2V2I and 3V3I wiring:

1Phase2 Wire (1V1I): This is applicable to single phase AC input as in Industrial and single pair DC bus as in Inverter. This is also applicable to Half and Full Bridge configurations.

1Phase3 Wire (2V2I): This is applicable for AC input for Line-to-Neutral configuration.

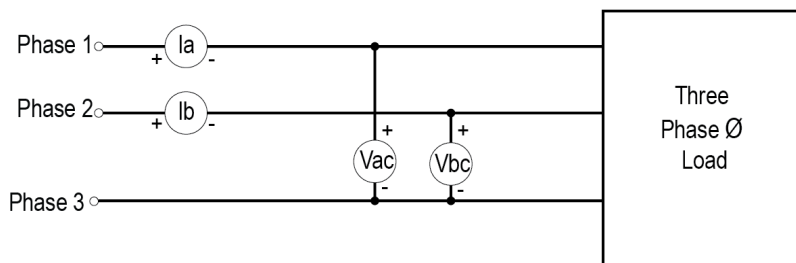

Figure 19: 2V2I 3Phase3Wire

Specify 2 voltage and 2 current sources.

Considers 3 voltage and 3 current sources.

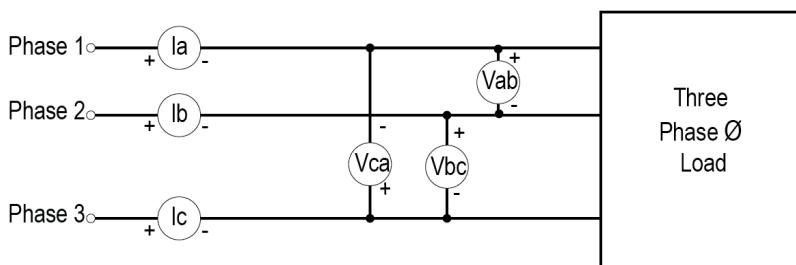

Figure 20: 3V3I 3Phase3Wire

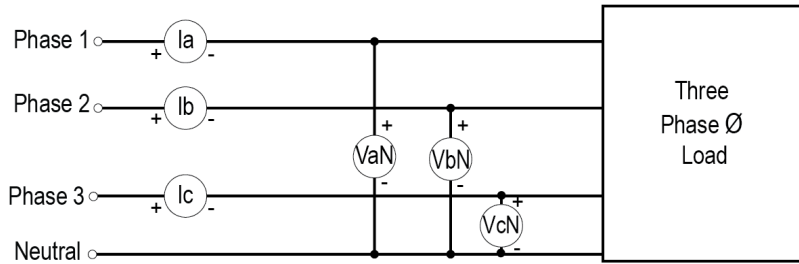
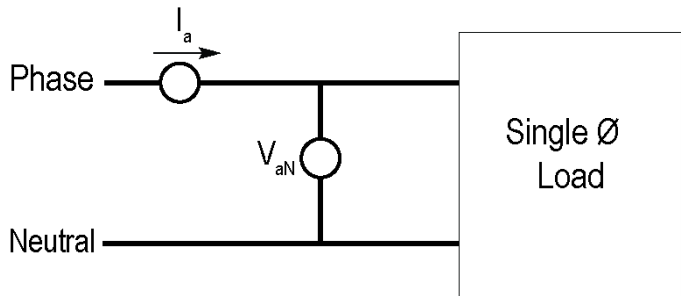
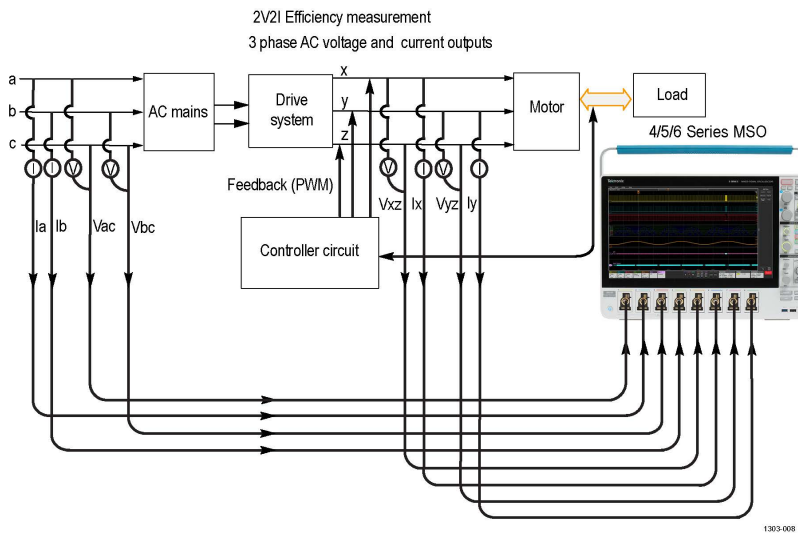

Figure 21: 3V3I 3Phase4Wire



1310\_007

Figure 22: 1V1I 1Phase2Wire



1303\_008

Figure 23: 3 phase motor system, as 2V2I Efficiency measurement using 3 Phase motor setup

The voltage probes that is used is THDP0100/0200 and current probe that is used is TCP0030A.

Where,

a,b,c is for Input Analysis

x,y,z is for Output Analysis

Drive system is for Ripple measurements.

## Connection setup for Speed and Direction measurements

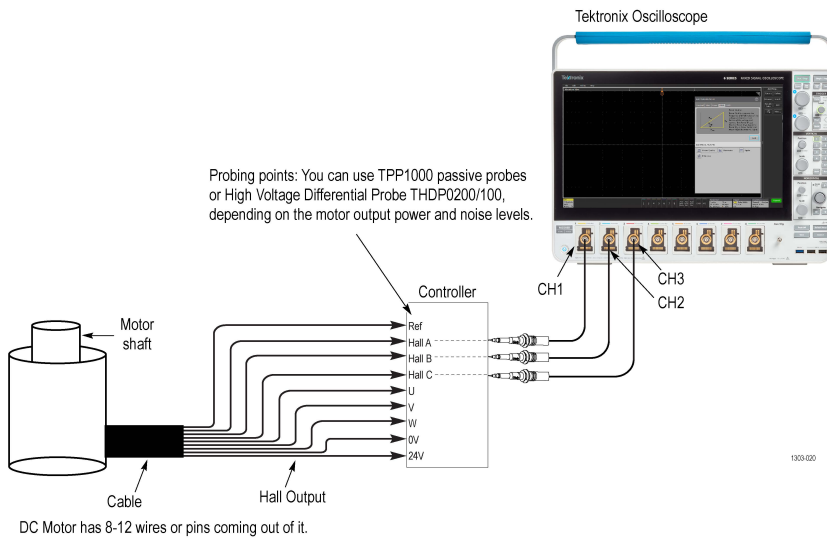

## Connection setup for Torque measurement using Sensor method

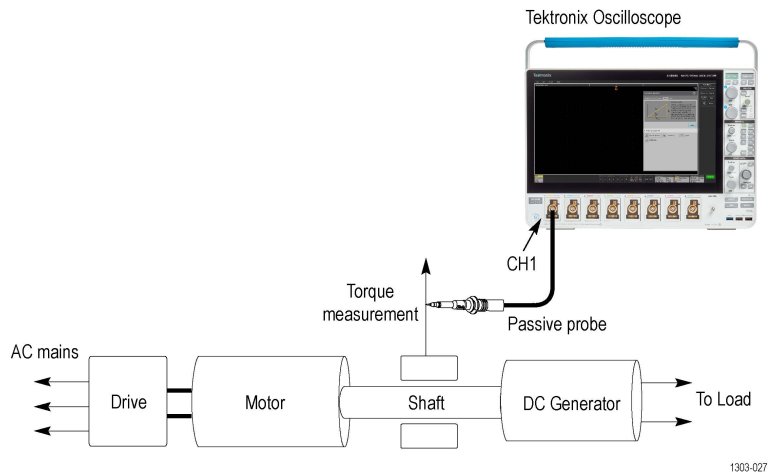

## Connection setup for Torque measurement using Current method

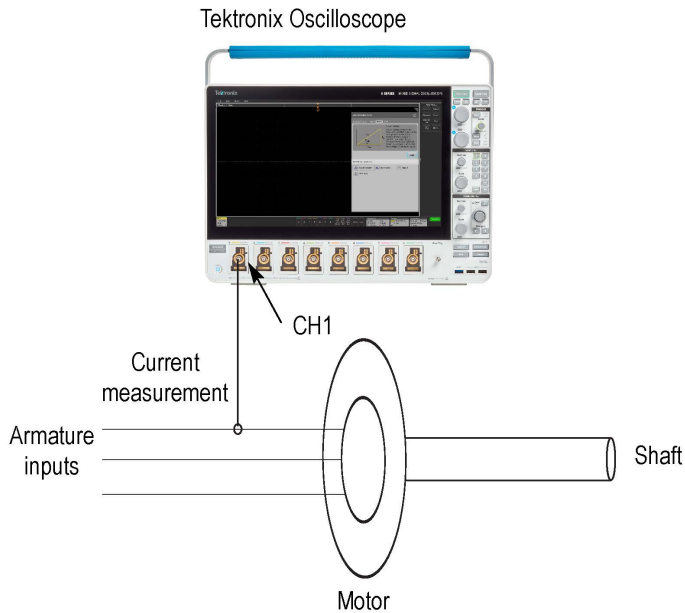

1303-028

## IMDA Autose

IMDA Autose sets up the Voltages Current sources based on the wiring configuration. The IMDA Autose will optimally set up the vertical, horizontal, acquisition, and trigger parameters on the oscilloscope and will be done on all active IMDA measurements. Autose updates the RefLevels to MinMax and sets the Hysteresis to 10%.

Use the following steps to run a **IMDA Autose** on applicable IMDA measurements:

1. Add the IMDA measurements that you want to take to the Results bar.
2. Configure each IMDA measurement individually (input voltage sources, current sources, label name, and so on).
3. Connect the input signals to the instrument and confirm the waveforms are correct and not clipping.
4. Double-tap the IMDA measurement result badge for which you want to take a measurement.
5. Tap the **IMDA Autose** button for the measurement and wait for the busy indicator to disappear. The instrument has now been optimized for that measurement.

**Note:**



The IMDA Autose may not work and can fail for higher DC voltages (>200 V). You have to manually adjust the Horizontal Scale and Vertical Scale/Offset to get the proper waveform.

In case of failure, the instrument displays a pop-up error message. See [Errors and Warnings](#).

6. Record the IMDA measurement after the **IMDA Autose** completes.
7. Repeat steps 4 - 6 for other IMDA measurements that you want to take.

**Note:**



- IMDA Autose will turn off unused channel sources and turn on configured sources.
- When IMDA Autose fails or there are insufficient cycles in the signal after autose, adjust the hysteresis or low pass filter settings in the measurement configuration menu and then rerun IMDA Autose.

- If you view **Input source mismatch** error when using a Rogowski probe (TRCP series), update the **Vertical Channel** -> **Probe setup** to **Other** and set as **A**.

## Set modify custom limits

You can set and modify the custom limits for IMDA Harmonics measurement.

### Set custom limits

To set the custom limits:

1. Go to **IMDA** tab, add **Harmonics** measurement from **Electrical analysis** measurement tab.
2. Select **Harmonics** measurement.
3. Select the limits as **Custom**.
4. Click **Load Limits**.
5. Browse to **C:\Users\Public\Tektronix\TekScope\Applications\Power\HarmonicsLimits** path.
6. Select **IECStdClassALimits.csv**. This is a sample file provided by default by the installer.

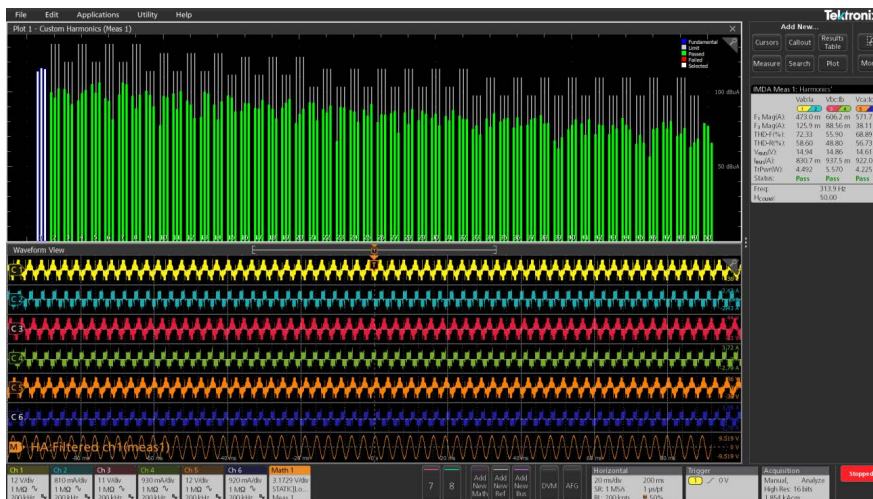

Figure 24: Harmonics with custom limits

### Modify custom limits

To modify the custom limits:

1. Open the sample limits file in excel tool.

A	B	C
Harmonics	Limits	
1	NA	
2	1.08	
3	2.3	
4	0.43	
5	1.14	
6	0.3	
7	0.77	
8	0.23	
9	0.4	
10	0.184	
11	0.33	
12	0.1533	
13	0.21	
14	0.1314	
15	0.15	
16	0.115	
17	0.1324	
18	0.1022	
19	0.1184	
20	0.092	
21	0.1071	

A	B	C
1	Harmonics	Limits
2	1	NA
3	2	1.08
4	3	2.3
5	4	0.43
6	5	1.14
7	6	0.3
8	7	0.77
9	8	0.23
10	9	0.4
11	10	0.184
12	11	0.33
13	12	0.1533
14	13	0.21
15	14	0.1314
16	15	0.15
17	16	0.115
18	17	0.1324
19	18	0.1022
20	19	0.1184
21	20	0.092
22	21	0.1071

Figure 25: Harmonics with custom limits

2. Edit the limits value by adding the custom limits or you can save as another file as '*...sample\_custom.csv*' and recall this file.

## Reference Levels panel (IMDA measurement configuration Menu)

Use the Reference Levels panel to set the scope of the reference level settings (global or local), the measurement reference levels (High, Mid, and Low), the units used to take measurements, and the method used to calculate the Top and Base waveform values. Hysteresis settings are critical for PWM edge extraction.

See [Reference Levels panel \(Measurement configuration menu\)](#) on page 212 for the Reference panel fields and controls.

### Other measurement settings panels

[IMDA Measurement Name panel \(Measurement configuration menu\)](#) on page 263

[Configure panel \(IMDA measurement configuration menu\) - Motor Analysis](#) on page 266

[Gating panel \(IMDA measurement configuration menu\)](#) on page 276

## Gating panel (IMDA measurement configuration menu)

Use Gating to confine a measurement to a certain part of a waveform.

See [Gating panel \(Measurement configuration menu\)](#) on page 218 for the Gating panel fields and controls.

### See also

[IMDA Measurement Name panel \(Measurement configuration menu\)](#) on page 263

[Reference Levels panel \(IMDA measurement configuration Menu\)](#) on page 276

[Configure panel \(IMDA measurement configuration menu\) - Motor Analysis](#) on page 266



## DPM measurement configuration menu overview

Use this configuration menu to add a measurement and change measurement settings including source, scope (global or local), and reference levels.

To open the DPM (Digital Power Management) measurement configuration menu for a measurement, double-tap a DPM measurement badge in the Results bar. The configuration menu and panels only show fields and controls relevant to the selected measurement.

The menu opens on the measurement name panel (the name of the measurement), which provides controls to display additional statistics to the measurement badge, display plots of the measurement, and so on. The most common DPM measurement Name fields are listed in the following table.

### DPM Measurement configuration menu fields, controls, and panels

Field, control, or panel	Description
<b>Plots</b> (Measurement name panel)	Displays Plot views of the measurement. Available plots depend on the measurement. To add a plot to the screen, tap the plot button. See <a href="#">Add Plot configuration menu</a> on page 336.
<b>Configure panel</b>	Sets the source, label text, and other fields that are specific to each measurement type. See <a href="#">Configure panel (Measurement configuration menu)</a> on page 212.
<b>Reference Levels panel</b>	Sets the reference levels and units used to take measurements, the scope of the reference level settings (global or local), and the method used to calculate the Top and Base waveform values. See <a href="#">Reference Levels panel (Measurement configuration menu)</a> on page 212.

### DPM Measurement Name panel (Measurement configuration menu)

The DPM Measurement Name panel (the name of the measurement) provides controls for opening plots of the measurement.

To open the DPM measurement name panel, double-tap a DPM Measurement badge. This is the default panel shown when you open a DPM Measurement settings menu.

The contents of the Measurement Name panel depends on the measurement.

Field or control	Description
<b>Power Rail Autose</b>	Sets the oscilloscope acquisition system for optimal results for all active DPM measurements. See <a href="#">Power Rail Autose</a> .
<b>Spectrum View Autose</b>	Sets the oscilloscope to acquire the frequency-domain data in parallel with the time-domain data. This frequency-domain data is processed, transformed, and displayed in a separate Spectrum View window, that is optimized to display and adjust spectrum traces independently of the time-domain waveform.
<b>Plots</b>	Adds a Plot view of the measurement value to the screen. Available plots depend on the measurement.

### Other measurement configuration panels

[Configure panel \(Measurement configuration menu\)](#) on page 212

[Reference Levels panel \(Measurement configuration menu\)](#) on page 212

## Configure panel (DPM measurement configuration menu)

Use the configure panel to set the measurements source(s), add a custom name (label) for the measurement and other parameters.

To open the Configure panel for a DPM measurement:

1. Double-tap a DPM measurement badge to open the DPM measurement configuration menu.
2. Tap the **Configure** panel.

### Ripple configure panel

Field or control	Description
<b>Label</b>	Sets the name of the measurement. You can use the default name, or double-tap in the field and change the label using a connected keyboard or the virtual keyboard.
<b>Power Rail</b>	Sets the power rail source(s) used to take the measurement. Tap the field to show the list of available sources. Select the current source.
<b>Ripple Frequency</b>	Sets the ripple frequency used to calculate the RMS.
<b>Bandwidth Limit</b>	Tap to select the bandwidth limit from the drop-down list.
<b>Calculate One Measurement Per:</b>	Select <b>Record</b> or <b>Cycle</b> .
<b>Edge Qualifier (CLK)</b>	Sets the edge qualifier to PWM clock source and computes ripple, overshoot or undershoot values at each cycle.  Available when Calculate One Measurement Per = <b>Cycle</b> .

### Turn On Overshoot measurements configure panel

Field or control	Description
<b>Trigger Source</b>	Select the source for triggering when the DUT is turned ON.
<b>Bandwidth Limit</b>	Tap to select the bandwidth limit from the drop-down list.
<b>Label</b>	Sets the name of the measurement. You can use the default name, or double-tap in the field and change the label using a connected keyboard or the virtual keyboard.
<b>Maximum Input Voltage</b>	Set the maximum input voltage for the trigger source.
<b>Input Trigger Level</b>	Set the input trigger level for the trigger source.
<b>Acquisition Time</b>	Set the acquisition time for the horizontal time base.
<b>Power Rail Output</b>	Sets the power rail source(s) used to take the measurement. Tap the field to show the list of available sources.
<b>Output Voltage</b>	Set the output voltage for the power rail output source. This is used to set the vertical scale of the power rail output source.
<b>Power Rail Preset</b>	Sets the oscilloscope with the configured inputs to acquire the signals of interest with a single acquisition. After performing a Power Preset, press the Run/Stop button on the front panel and then power Off/On the device under test.

### Overshoot and Undershoot measurements configure panel

Field or control	Description
Label	Sets the name of the measurement. You can use the default name, or double-tap in the field and change the label using a connected keyboard or the virtual keyboard.
Power Rail	Sets the power rail source(s) used to take the measurement. Tap the field to show the list of available sources.
Reference Level	Sets the reference level needed to calculate the overshoot and undershoot of the signal.
Bandwidth Limit	Tap to select the bandwidth limit from the drop-down list.
Calculate One Measurement Per:	Select <b>Record</b> or <b>Cycle</b> .
Edge Qualifier (CLK)	Sets the edge qualifier to PWM clock source and computes ripple, overshoot or undershoot values at each cycle.  Available when Calculate One Measurement Per = <b>Cycle</b> .

### Turn On Time and Turn Off Time measurements configure panel

Field or control	Description
Input Source	Selects the channel connected to the input side of the DUT.
Bandwidth Limit	Tap to select the bandwidth limit from the drop-down list.
Label	Sets the name of the measurement. You can use the default name, or double-tap in the field and change the label using a connected keyboard or the virtual keyboard.
Maximum Input Voltage	Sets the maximum input voltage, in the range of -500 V to 500 V.
Input Trigger Level	Sets the input trigger level, in the range of 1 V to 500 V.
Wait Time	Sets the wait time in seconds.
Power Rail Output	Sets the sources as Analog sources or Ref or Math connected to DC rail output from the DUT.
Output Voltage	Sets the DC rail output voltages for the corresponding power rail output.
Power Rail Preset	Sets the oscilloscope with the configured inputs to acquire the signals of interest with a single acquisition. After performing a Power Preset, press the Run/Stop button on the front panel and then power Off/On the device under test.

### DC Rail Voltage measurement configure panel

Field or control	Description
Label	Sets the name of the measurement. You can use the default name, or double-tap in the field and change the label using a connected keyboard or the virtual keyboard.
Power Rail	Sets the power rail source(s) used to take the measurement. Tap the field to show the list of available sources. Select the current source.
Bandwidth Limit	Tap to select the bandwidth limit from the drop-down list.
Calculate One Measurement Per:	Select <b>Record</b> or <b>Cycle</b> .

Table continued...

Field or control	Description
Edge Qualifier (CLK)	Sets the edge qualifier to PWM clock source and computes ripple, overshoot or undershoot values at each cycle.  Available when Calculate One Measurement Per = <b>Cycle</b> .

### Eye Width measurement configure panel

Field or control	Description
Label	Sets the name of the measurement. You can use the default name, or double-tap in the field and change the label using a connected keyboard or the virtual keyboard.
Power Rail	Sets the power rail source(s) used to take the measurement. Tap the field to show the list of available sources. Select the current source.
Jitter Frequency	Sets the jitter frequency required for the power rail autotest.
Bandwidth Limit	Tap to select the bandwidth limit from the drop-down list.
Power Rail Clock	Sets the power rail clock source(s) used to take the measurement. Tap the field to show the list of available sources. Select the current source.  Available when Method = <b>Explicit Clock</b> , in Clock Recovery panel.

### DJ, PJ, RJ, and TIE measurements configure panel

Field or control	Description
Label	Sets the name of the measurement. You can use the default name, or double-tap in the field and change the label using a connected keyboard or the virtual keyboard.
Power Rail	Sets the power rail source(s) used to take the measurement. Tap the field to show the list of available sources. Select the current source.
Jitter Frequency	Sets the jitter frequency required for the power rail autotest.
Bandwidth Limit	Tap to select the bandwidth limit from the drop-down list.
Power Rail Clock	Sets the power rail clock source(s) used to take the measurement. Tap the field to show the list of available sources. Select the current source.  Available when Method = <b>Explicit Clock</b> , in Clock Recovery panel.
Clock Edge	Sets the signal transition edge (rising, falling, or either) for evaluating the logic condition at that clock transition.

### Eye High, Eye Low, and Eye Height measurements configure panel

Field or control	Description
Label	Sets the name of the measurement. You can use the default name, or double-tap in the field and change the label using a connected keyboard or the virtual keyboard.
Power Rail	Sets the power rail source(s) used to take the measurement. Tap the field to show the list of available sources. Select the current source.

Table continued...

Field or control	Description
<b>Bandwidth Limit</b>	Tap to select the bandwidth limit from the drop-down list.
<b>Power Rail Clock</b>	Sets the power rail clock source(s) used to take the measurement. Tap the field to show the list of available sources. Select the current source.  Available when Method = <b>Explicit Clock</b> , in Clock Recovery panel.
<b>Bit Type</b>	Sets the waveform bit types for eye height analysis (Transition, Non-Transition, or All).  All does eye analysis using both transition and non-transition bits.  Transition does eye analysis only on transition bits. A transition bit is a bit that is changing from low to high or high to low.  Non-Transition does eye analysis only on nontransition bits. A nontransition bit is a bit that is not changing state.
<b>Measure at % of the Unit Interval</b>	Sets the horizontal position where the measurement is taken, as a percentage of the Unit Interval.

### PSIJ measurements configure panel

Field or control	Description
<b>Label</b>	Sets the name of the measurement. You can use the default name, or double-tap in the field and change the label using a connected keyboard or the virtual keyboard.
<b>Power Rail Source (Aggressor)</b>	Sets the power rail source to take the measurement. Tap the field to show the list of available sources. Select the current source.  Power rail source can be set to None when PSIJ is measured only on the high speed source.
<b>High Speed Source</b>	Sets the high speed source. Tap the field to show the list of available sources.
<b>Signal Type</b>	Set the signal type as <b>Clock</b> , <b>Data</b> , or <b>Auto</b> . The default signal type is Auto.
<b>Clock Edge</b>	Set the clock edge of the signal as <b>Rise</b> , <b>Fall</b> , or <b>Both</b> . The default clock edge is rise.
<b>Pattern Detection</b>	Set <b>Auto</b> or <b>Manual</b> to detect pattern. The default pattern detection is auto.
<b>PJ Threshold</b>	Set the PJ threshold limit. The measurement considers PJ components above the threshold value and ignores PJ components below the threshold. This helps to identify power rail noise coming from the switching or from the power supply.
<b>PJ Max Frequency</b>	Set the maximum PJ frequency. The signal below max PJ frequency component is considered as valid. This helps to isolate if there are multiple PJ components.
<b>Notch Filter Settings</b>	
<b>Center Frequency</b>	Configure notch filter with center frequency that needs to be suppressed from the high speed or victim signal.
<b>Span</b>	Set the span of notch filter. This value is the percentage of center frequency.
<b>Low Frequency and High Frequency</b>	Low and high frequency values are calculated using the configured center frequency and span. These are readouts to show the range of frequencies over the filtering that is performed.



**Note:** PSIJ measurement supports Constant Clock Recovery and External Clock Recovery methods only.

## Other measurement configuration panels

[DPM Measurement Name panel \(Measurement configuration menu\)](#) on page 277

[Configure panel \(Measurement configuration menu\)](#) on page 212

[Reference Levels panel \(Measurement configuration menu\)](#) on page 212

## Reference Levels panel (DPM measurement configuration Menu)

Use the Reference Levels panel to set the scope of the reference level settings (global or local), the measurement reference levels (High, Mid, and Low), the units used to take measurements, and the method used to calculate the Top and Base waveform values. You can set the reference levels to be the same or different for rising and falling edges.

See [Reference Levels panel \(Measurement configuration menu\)](#) on page 212 for the Reference panel fields and controls.

You can select different reference levels for all DPM measurement sources. To set the different reference levels, select **Utility>Preferences**. In the User Preferences window, click **Measurements** panel and select the Shared Reference Levels as **Per Source**.

## Other measurement configuration panels

[DPM Measurement Name panel \(Measurement configuration menu\)](#) on page 277

[Configure panel \(Measurement configuration menu\)](#) on page 212

## Connection setup for Digital Power Management (DPM) measurements

Connection diagram for Ripple, Overshoot, and Undershoot

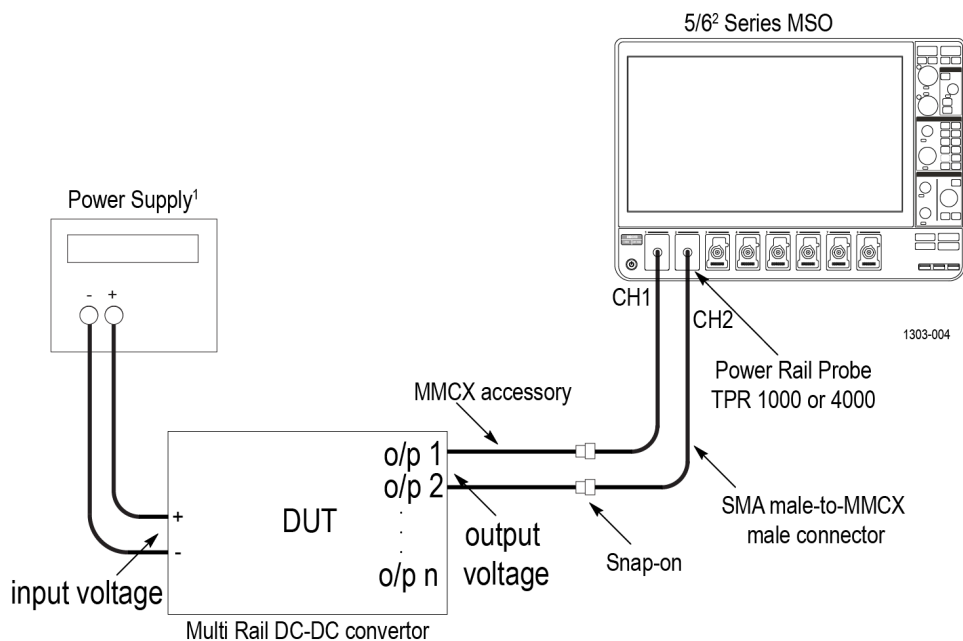

<sup>1</sup>Source of power supply can be a DC power supply unit or USB connector

<sup>2</sup>6 Series MSO Oscilloscope contains 4 channels only

n is the number of DC rail output of the DUT. The total number of outputs you can connect to the oscilloscope is x-1, where x is the total number of channels.

Figure 26: Connection setup for Digital Power Management (DPM) measurements

## Power Rail Autoset

Sets the oscilloscope acquisition system for optimal measurement results for DPM measurements.

Use the following steps to run a **Power Rail Autoset** on applicable DPM measurements:

1. Add the DPM measurements that you want to take to the Results bar.
2. Configure each DPM measurement individually (input voltage sources, label name, and so on).
3. Connect the power rail signals to the oscilloscope channels using power rail probe.
4. Double-tap the DPM measurement result badge for which you want to take a measurement.
5. Tap the **Power Rail Autoset** button for the measurement and wait for the busy indicator to disappear. The instrument has now been optimized for that DPM measurement.

### Note:

- In case of failure, the instrument displays a popup error message. See [Errors and Warnings](#).
- **Power Rail Autoset** runs all parts of instrument Autoset, even if some parts have been disabled in the **User Preferences** > **Autoset** panel. See [Autoset panel fields and controls](#) on page 487 for more information on the Autoset function.
- **Power Rail Autoset** is available per measurement. You should run the Power Rail Autoset for each measurement separately when you add measurements, to ensure optimum DPM measurement setup for that measurement. The power rail autoset configured for a DPM jitter measurement will supersede the power rail autoset configuration of all other DPM measurements.



6. View the DPM measurement results in the results badge, after the **Power Rail Autoset** is complete.

7. Repeat steps 4 on page 255 - 6 on page 256 for other DPM measurements that you want to take.



**Note:** When you select multiple rails with different ripple or jitter frequencies, the Power Rail Autoset uses the best frequency value to set up the oscilloscope horizontal parameters.

## Power Rail Preset

Sets the oscilloscope vertical, horizontal and acquisition parameters using the user inputs like peak voltage and current for Turn Off Time and Turn On Time measurements.



**Note:** The **Power Rail Preset** button is available only for **Turn On Time**, **Turn Off Time**, and **Turn on Overshoot** measurements.

Use the following steps to run a **Power Rail Preset** on applicable DPM measurements:

1. Add the supported DPM measurements to the **Results** bar.
2. Double-tap each Measurement badge and configure the measurement (input voltage sources, current sources, label name, and so on).
3. Connect the input signals.
4. Tap the **Power Rail Preset** button in the measurement configuration to set.

To set the vertical and horizontal acquisition parameters:

- a. Measurement configuration begins and displays a window.

**Note:**



- You cannot operate the oscilloscope front panel controls while the measurement runs.
- You can change the ACQ modes to Sample mode after **Power Rail Preset** is clicked and before the oscilloscope **Single/Seq** is performed.

- b. Press **Single Seq** on the front panel and Turn Off/On the DUT.

5. Follow the instructions on the Measurement badge to take the DPM measurement.

## Spectrum View Autoset

The Spectrum View Autoset feature in 4/5/6 series instruments uses a separate hardware path in the acquisition of each channel to acquire the frequency-domain data in parallel with the time-domain data. This frequency-domain data is processed, transformed, and displayed in a separate Spectrum View window, that is optimized to display and adjust spectrum traces independently of the time-domain waveform.

Use the following steps to run a **Spectrum View Autoset** on DPM measurements:

1. Add the DPM measurements that you want to take to the Results bar.
2. Configure each DPM measurement individually (input voltage sources, label name, and so on).
3. Connect the power rail signals to the oscilloscope channels using power rail probe.
4. Double-tap the DPM measurement result badge for which you want to take a measurement.
5. Tap the **Spectrum View Autoset** button for the measurement. This performs the following settings:
  - Sets the SpectrumVu center frequency to Ripple frequency.
  - RBW and Span are set automatically to account for ripple frequencies.
  - Sets FFT Window as Kaiser-Bessel since this has less spectral leakage.
  - Turns on Spectrum View window for the configured sources.



**Note:**

- In case of failure, the instrument displays a popup error message. See [Errors and Warnings](#).



- It is recommended to run **Power Rail Autoset** before **Spectrum View Autoset**.

## Spectrum GSRB configuration

Field or Control	Description
<b>Lock Center Frequency Across All Channels</b>	Select to configure the <b>Center Frequency</b> value selected for all channels. Unselecting will enable the <b>Source</b> option, which will allow you to set the center frequency per source.
<b>Source</b>	Select the channel source from the drop-down list and configure the <b>Center Frequency</b> value. Only available when <b>Lock Center Frequency Across All Channels</b> is unselected.
<b>Center Frequency</b>	Set the center frequency value.
<b>Span</b>	Set the Span to a factor of Center Frequency. Span is common to all channels. Set a value that works for multiple rail frequencies.
<b>Window</b>	Select the window type from the drop-down list: <ul style="list-style-type: none"> <li>• Flattop2</li> <li>• Kaiser-Bessel</li> <li>• Rectangular</li> <li>• Hamming</li> <li>• Hanning</li> <li>• Blackman-Harris</li> </ul>
<b>RBW Mode</b>	Select the RBW Mode as <b>Auto</b> or <b>Manual</b> .
<b>Span: RBW</b>	Set the RBW in span. Only available when <b>RBW Mode = Auto</b>
<b>RBW</b>	Set the RBW in absolute values. Only available when <b>RBW Mode = Manual</b>
<b>Lock Spectrum Time Across All Channels</b>	Select to configure the <b>Spectrum Time</b> value selected for all channels. Unselecting will enable the <b>Source</b> option, which will allow you to set the spectrum time per source.
<b>Source</b>	Select the channel source from the drop-down list and configure the <b>Spectrum Time</b> value. Only available when <b>Lock Spectrum Time Across All Channels</b> is unselected.
<b>Spectrum Time</b>	Set the spectrum time value.

## See also

[Using Spectrum View](#)

## DDR measurement configuration menu overview

Use this configuration menu to add statistics to a DDR measurement badge readout, plot a measurement, and change measurement settings including source, measurement scope (global or local), reference levels, gating, and filter/limit results.

To open the DDR measurement configuration menu for a measurement, double-tap a DDR measurement badge in the Results bar. The configuration menu and panels only show fields and controls relevant to the selected measurement.

The menu opens on the measurement name panel (the name of the measurement). The measurement name panel only shows fields and controls relevant to the selected measurement. Common controls include displaying statistics in the measurement badge and creating plots of the measurement.

The most common DDR measurement name fields are listed in the following table.

### DDR Measurement configuration menu fields, controls, and panels

Field, control, or panel	Description
<b>Show Statistics in Badge</b> (Measurement name panel)	Adds the listed statistical measurement readouts to the measurement badge readout.
<b>Plots</b> (Measurement name panel)	Buttons that open Plot views of the measurement. Available plots depend on the measurement. Plot types include Time Trend, Histogram, and Spectrum.  To add a plot to the screen, tap the plot button.  See <a href="#">Add Plot configuration menu</a> on page 336.
<b>Panels</b>	
<b>Configure panel</b>	Sets the source, label text, and other fields that are specific to each measurement type.  See <a href="#">Configure panel (DDR measurement configuration menu)</a> on page 287.
<b>Reference Levels panel</b>	Sets the reference levels and units used to take measurements, the scope of the reference level settings (global or local), and the method used to calculate the Top and Base waveform values.  See <a href="#">Reference Levels panel (DDR measurement configuration Menu)</a> on page 287.
<b>Gating panel</b>	Sets the measurement region (gate) used to take measurements. Select the scope of the gate setting (global or local), and the type of gating to use.  See <a href="#">Gating panel (DDR measurement configuration menu)</a> on page 287.
<b>Filter/Limit Results panel</b>	Sets the scope of the filtering setting (global or local), high and low pass filter settings, the range of measurement result limits, and the limit measurement population size.  See <a href="#">Filter/Limit results panel (DDR measurement configuration Menu)</a> on page 288.

### DDR measurement name panel (Measurement configuration menu)

The DDR measurement name panel (the name of the measurement) provides controls for adding display statistics to the measurement badge and opening plots of the measurement.

To open and configure a DDR measurement, double-tap a DDR measurement badge.

The contents of the measurement configuration menu depend on the measurement.

Field or control	Description
<b>Show Statistics in Badge</b>	Adds the listed statistical measurement readouts to the measurement badge.
<b>Plots</b>	Adds a Plot view of the measurement to the screen. Available plots depend on the measurement. Plot types include <b>Time Trend</b> , <b>Histogram</b> , and <b>Spectrum</b> .

#### See also

[Configure panel \(DDR measurement configuration menu\)](#) on page 287

[Filter/Limit results panel \(DDR measurement configuration Menu\)](#) on page 288

[Reference Levels panel \(DDR measurement configuration Menu\)](#) on page 287

[Gating panel \(DDR measurement configuration menu\)](#) on page 287

## Configure panel (DDR measurement configuration menu)

Use the configure panel to set the measurements source(s), add a custom name (label) for the measurement, and other parameters.

To open the Configure panel for a DDR measurement:

1. Double-tap a DDR measurement badge to open the DDR measurement configuration menu.
2. Tap the **Configure** panel.

### Configure panel

Field or control	Description
Source	Sets the signal source used to take the measurement. Tap the field to show the list of available sources. Select the current source.
Label	Sets the name of the measurement. You can use the default name, or double-tap in the field and change the label using a connected keyboard or the virtual keyboard.

### Other measurement configuration panels

[Filter/Limit results panel \(DDR measurement configuration Menu\)](#) on page 288

[Reference Levels panel \(DDR measurement configuration Menu\)](#) on page 287

[Gating panel \(DDR measurement configuration menu\)](#) on page 287

## Reference Levels panel (DDR measurement configuration Menu)

Use the Reference levels panel to set the scope of the reference level settings (global or local), the measurement reference levels (High, Mid, and Low), the units used to take measurements, and the method used to calculate the Top and Base waveform values. You can set the reference levels to be the same or different for rising and falling edges.

See [Reference Levels panel \(Measurement configuration menu\)](#) on page 212 for the Reference panel fields and controls.

### Other measurement settings panels

[Configure panel \(DDR measurement configuration menu\)](#) on page 287

[Filter/Limit results panel \(DDR measurement configuration Menu\)](#) on page 288

[Gating panel \(DDR measurement configuration menu\)](#) on page 287

## Gating panel (DDR measurement configuration menu)

Use Gating to confine a measurement to a certain part of a waveform.

See [Gating panel \(Measurement configuration menu\)](#) on page 218 for the Gating panel fields and controls.

### See also

[Configure panel \(DDR measurement configuration menu\)](#) on page 287

[Filter/Limit results panel \(DDR measurement configuration Menu\)](#) on page 288

[Reference Levels panel \(DDR measurement configuration Menu\)](#) on page 287

## Filter/Limit results panel (DDR measurement configuration Menu)

Use these settings to apply a High Pass and/or Low Pass filter to block specified frequency band components when taking measurements. Use the limit controls to set range of measurement values to measure, and the number of measurements to take (population).

See [Filter/Limit Results panel \(Measurement Settings menu\)](#) on page 220 for the Filter/Limit Results panel fields and controls.

### Other measurement settings panels

[Configure panel \(DDR measurement configuration menu\)](#) on page 287

[Reference Levels panel \(DDR measurement configuration Menu\)](#) on page 287

[Gating panel \(DDR measurement configuration menu\)](#) on page 287

## WBG-DPT measurement configuration menu overview

Use this configuration menu to preset the WBG-DPT measurement, change measurement settings including source, scope (global or local), reference levels, and gating.

To open the WBG-DPT measurement configuration menu for a measurement, double-tap a WBG-DPT measurement badge in the Results bar. The configuration menu and panels only show fields and controls relevant to the selected measurement. The menu opens on the measurement name panel. The most common WBG-DPT measurement name fields are listed in the following table.

### WBG-DPT measurement configuration menu fields, controls, and panels

Field, control, or panel	Description
Measurement Name panel	Sets the maximum voltage and current limits and pulse width for power preset.
Configure panel	Sets the source, label text, and other fields that are specific to each measurement type.
Deskew panel	Sets the circuit parameters to calculate the skew between voltage and current.
Generator Setup panel	Configure the AFG 31000 Series to generate the double pulse signal of the required amplitude and pulse widths. The Generator setup is not supported on 4 Series MSO but it is supported on 4 Series B MSO.
Reference Levels panel	Sets the reference levels and units used to take measurements, the scope of the reference level settings (global or local), and the method used to calculate the Top and Base waveform values.
Gating panel	Sets the measurement region (gate) used to take measurements. Select the scope of the gate setting (global or local), and the type of gating to use.

## WBG-DPT Measurement Name panel (WBG-DPT measurement Preset menu)

To open the WBG-DPT measurement name panel, double-tap a WBG-DPT Measurement badge. This is the default panel shown when you open a WBG-DPT Measurement settings menu.

This panel provides controls to preset the oscilloscope for optimal vertical, horizontal, trigger, and acquisition settings. The contents of the Measurement Name Panel depends on the selected measurement.

Field or control	Description
Max Voltage (Vds/Vce)	Sets the maximum drain source or collector emitter voltage based on Power Device.
Max Current (Id/Ic)	Sets the maximum drain or collector current based on Power Device.

Table continued...

Field or control	Description
<b>Max Gate Voltage (Vgs/Vge)</b>	Sets the maximum drain source or gate emitter voltage based on Power Device.
<b>Pulse Width</b>	Sets the horizontal scale of the oscilloscope.
<b>Power Preset</b>	Power Preset uses the inputs above to preset the oscilloscope for optimal Vertical, Horizontal, Trigger, and Acquisition settings. Before Power Preset, turn OFF power supply and configure AFG31000 Series. After performing Power Preset, turn on the power supply with lower Vcc.
<b>Gate Stimulus</b>	<p>Gate Stimulus sets the oscilloscope to Single Sequence. Configure the AFG31000 Series using Generator Setup (refer to <a href="#">Generator Setup: Configure AFG 31000 Series section</a>).</p> <p>Turn on the power supply with lower Vcc. If AFG31000 is connected, Gate Stimulus generates double pulse signal on the AFG. The signal is sent to the WBG device and the signals of interest are acquired.</p> <p> <b>Note:</b> Do not change any settings in the Generator Setup Configure panel if you are not using the AFG31000 generator.</p>
<b>Plots</b>	Adds a Plot view of the measurement value to the screen. The Overlapped Recovery plot is available for Trr measurement. This plot displays single or overlay plot based on the selected pulse region.

### Other measurement settings panels

[Configure panel \(WBG-DPT measurement configuration menu\)](#) on page 289

[Reference Levels panel \(WBG-DPT measurement configuration Menu\)](#) on page 295

[Gating panel \(WBG-DPT measurement configuration menu\)](#) on page 295

### Configure panel (WBG-DPT measurement configuration menu)

1. Double-tap a WBG-DPT measurement badge to open the WBG-DPT measurement configuration menu.
2. Tap the **Configure** panel.

### Switching Parameter and Switching Timing measurements: Configure panel

Field or control	Description
<b>Pulse Region</b>	Sets the pulse region for the signal. Tap the field to show the list of available pulses.
<b>Number of Pulses</b>	Sets the number of pulses in the input signal. Available when <b>Pulse Region</b> is <b>Multiple Pulse</b> .
<b>Label</b>	Sets the name of the measurement. You can use the default name, or double-tap in the field and change the label using a connected keyboard or the virtual keyboard.
<b>Signal Type</b>	Sets the signal type as <b>Voltage</b> or <b>Current</b> . Available only for d/dt measurement.
<b>Edge</b>	Measures d/dt either on the rising slope or falling slope. Available only for d/dt measurement.
<b>Voltage Source (Vds/Vce)</b>	Sets the voltage signal source for the power device. Vds is the drain-source voltage when <b>Power Device</b> is <b>MOSFET</b> . Vce is the collector-emitter voltage when <b>Power Device</b> is <b>IGBT</b> .
<b>Current Source (Id/Ic)</b>	Sets the current signal source for the power device. Id is the drain current when <b>Power Device</b> is <b>MOSFET</b> . Ic is the collector current when <b>Power Device</b> is <b>IGBT</b> . It represents reverse recovery current.
<b>Gate Source (Vgs/Vge)</b>	Sets the voltage signal source for the power device. Vgs is the gate-source voltage when <b>Power Device</b> is <b>MOSFET</b> . Vge is the gate-emitter voltage when <b>Power Device</b> is <b>IGBT</b> .
<b>Levels</b>	Sets the levels for <b>Auto</b> or <b>Custom</b> .

Table continued...

Field or control	Description
Set Levels In	Sets the levels as % or <b>Absolute</b> . Available when <b>Levels</b> is <b>Custom</b> .
Start Level and Stop Level	Sets the <b>Start level</b> and <b>Stop level</b> of the pulse. The Start Level and Stop Level values are fixed and calculated as per IEC 60747-8: Switching times ON/OFF for MOSFET, IEC 60747-9 for IGBT standards when <b>Levels</b> is <b>Auto</b> . Double-tap in the field and enter the values using a connected keyboard or the virtual keyboard when <b>Levels</b> is <b>Custom</b> .
Refine Edge	Finds the optimum pulse region when the edge signal is ringing or has glitches.  <b>Note:</b> You can view the filtered edge signal by setting advanced math expression to "[avgcount = 32] wbgsignalcondition(chx)". Chx is the gate voltage source.
Start Search Direction	Finds the start level by traversing the signal from <b>Forward</b> or <b>Backward</b> direction. Available when <b>Levels</b> is set to <b>Custom</b> .
Stop Search Direction	Finds the stop level by traversing the signal from <b>Forward</b> or <b>Backward</b> direction. Available when <b>Levels</b> is set to <b>Custom</b> .

### Trr measurement: Configure panel

Field or control	Description
Pulse Region	Sets the pulse region for the signal. Tap the field to show the list of available pulses.
Number of Pulses	Sets the number of pulses in the input signal. Available when <b>Pulse Region</b> is <b>Multiple Pulse</b> .
Label	Sets the name of the measurement. You can use the default name, or double-tap in the field and change the label using a connected keyboard or the virtual keyboard.
Current Source (Id/Ic)	Sets the current signal source for the power device. Id is the drain current when <b>Power Device</b> is <b>MOSFET</b> . Ic is the collector current when <b>Power Device</b> is <b>IGBT</b> . It represents reverse recovery current.
Edge Qualifier	Enables the gate voltage source for Power device. When edge qualifier is unchecked, the <b>Pulse Region</b> is set to <b>Multiple Pulse</b> .
Edge Qualifier (Vgs/Vge)	Sets the gate signal source for Power device.
Extrapolated Current Levels	Sets the extrapolated current levels as <b>Auto</b> or <b>Custom</b> .
Set Levels In	Sets the levels as % or <b>Absolute</b> . Available when <b>Extrapolated Current Levels</b> is <b>Custom</b> .
Extrapolated Current	The extrapolated current level values are fixed and calculated as per JESD24-10: MOSFET and IEC 60747-9: IGBT standards when <b>Extrapolated Current Levels</b> is <b>Auto</b> . Sets the extrapolated levels for the current <b>Start Value (A)</b> and <b>Stop Value (B)</b> when <b>Extrapolated Current Levels</b> is <b>Custom</b> . Double-tap in the field and enter the value using a connected keyboard or the virtual keyboard.

Table continued...

Field or control	Description
Refine Edge	Finds the optimum pulse region when the edge signal is ringing or has glitches.
Start Search Direction	Finds the start level by traversing the signal from <b>Forward</b> or <b>Backward</b> direction.
Stop Search Direction	Finds the stop level by traversing the signal from <b>Forward</b> or <b>Backward</b> direction.

### Qrr measurement: Configure panel

Field or control	Description
Pulse Region	Sets the pulse region for the signal. Tap the field to show the list of available pulses.
Number of Pulses	Sets the number of pulses in the input signal. Available when <b>Pulse Region</b> is <b>Multiple Pulse</b> .
Label	Sets the name of the measurement. You can use the default name, or double-tap in the field and change the label using a connected keyboard or the virtual keyboard.
Current Source (Id/Ic)	Sets the current signal source for the power device. Id is the drain current when <b>Power Device</b> is <b>MOSFET</b> . Ic is the collector current when <b>Power Device</b> is <b>IGBT</b> . It represents reverse recovery current.
Edge Qualifier	Enables the gate voltage source for Power device. When edge qualifier is unchecked, the <b>Pulse Region</b> is set to <b>Multiple Pulse</b> .
Edge Qualifier (Vgs/Vge)	Sets the gate signal source for Power device.
Integration Current Level	Sets the integration level for the current as <b>Auto</b> or <b>Custom</b> .
Set Levels In	Sets the levels as % or <b>Absolute</b> . Available when <b>Integration Current Level</b> is <b>Custom</b> .
Integration Current Stop Level	The integration level value is fixed when <b>Integration Current Level</b> is <b>Auto</b> . Sets the integration level for the current <b>Stop Level</b> when <b>Integration Current Level</b> is <b>Custom</b> . Double-tap in the field and enter the value using a connected keyboard or the virtual keyboard.
Refine Edge	Finds the optimum pulse region when the edge signal is ringing or has glitches.
Stop Search Direction	Finds the stop level by traversing the signal from <b>Forward</b> or <b>Backward</b> direction.

### Err measurement: Configure panel

Field or control	Description
Pulse Region	Sets the pulse region for the signal. Tap the field to show the list of available pulses.
Number of Pulses	Sets the number of pulses in the input signal. Available when <b>Pulse Region</b> is <b>Multiple Pulse</b> .
Label	Sets the name of the measurement. You can use the default name, or double-tap in the field and change the label using a connected keyboard or the virtual keyboard.
Voltage Source (Vrr)	Sets the voltage signal source for Power device. Vrr is the reverse recovery voltage.
Current Source (Id/Ic)	Sets the current signal source for the power device. Id is the drain current when <b>Power Device</b> is <b>MOSFET</b> . Ic is the collector current when <b>Power Device</b> is <b>IGBT</b> . It represents reverse recovery current.
Edge Qualifier	Enables the gate voltage source for Power device. When edge qualifier is unchecked, the <b>Pulse Region</b> is set to <b>Multiple Pulse</b> .

Table continued...

Field or control	Description
Edge Qualifier (Vgs/Vge)	Sets the gate signal source for Power device.
Integration Current Levels	Sets the integration current levels as <b>Auto</b> or <b>Custom</b> .
Set Levels In	Sets the levels as % or <b>Absolute</b> . Available when <b>Integration Current Levels</b> is <b>Custom</b> .
Start Level and Stop Level	Shows the integration levels for the current values. The integration levels values are fixed when <b>Integration Current Levels</b> is <b>Auto</b> . Sets the integration level for the current <b>Start Level</b> and <b>Stop Level</b> when <b>Integration Current Levels</b> is <b>Custom</b> . Double-tap in the field and enter the values using a connected keyboard or the virtual keyboard.
Refine Edge	Finds the optimum pulse region when the edge signal is ringing or has glitches.
Start Search Direction	Finds the start level by traversing the signal from <b>Forward</b> or <b>Backward</b> direction.
Stop Search Direction	Finds the stop level by traversing the signal from <b>Forward</b> or <b>Backward</b> direction.

### Irrm measurement: Configure panel

Field or control	Description
Pulse Region	Sets the pulse region for the signal. Tap the field to show the list of available pulses.
Number of Pulses	Sets the number of pulses in the input signal. Available when <b>Pulse Region</b> is <b>Multiple Pulse</b> .
Label	Sets the name of the measurement. You can use the default name, or double-tap in the field and change the label using a connected keyboard or the virtual keyboard.
Current Source (Id/Ic)	Sets the current signal source for the power device. Id is the drain current when <b>Power Device</b> is <b>MOSFET</b> . Ic is the collector current when <b>Power Device</b> is <b>IGBT</b> . It represents reverse recovery current.
Edge Qualifier	Enables the gate voltage source for Power device. When edge qualifier is unchecked, the <b>Pulse Region</b> is set to <b>Multiple Pulse</b> .
Edge Qualifier (Vgs/Vge)	Sets the gate signal source for Power device.
Refine Edge	Finds the optimum pulse region when the edge signal is ringing or has glitches.

### Diode d/dt measurement: Configure panel

Field or control	Description
Pulse Region	Sets the pulse region for the signal. Tap the field to show the list of available pulses.
Number of Pulses	Sets the number of pulses in the input signal. Available when <b>Pulse Region</b> is <b>Multiple Pulse</b> .
Label	Sets the name of the measurement. You can use the default name, or double-tap in the field and change the label using a connected keyboard or the virtual keyboard.
Current Source (Id/Ic)	Sets the current signal source for the power device. Id is the drain current when <b>Power Device</b> is <b>MOSFET</b> . Ic is the collector current when <b>Power Device</b> is <b>IGBT</b> . It represents reverse recovery current.

Table continued...



Field or control	Description
Edge Qualifier	Enables the gate voltage source for Power device. When edge qualifier is unchecked, the <b>Pulse Region</b> is set to <b>Multiple Pulse</b> .
Edge Qualifier (Vgs/Vge)	Sets the gate signal source for Power device.
Signal Type	Sets the signal type as <b>Voltage</b> or <b>Current</b> .
Edge	Measures d/dt either on the rising slope or falling slope.
Levels	Sets the levels for <b>Auto</b> or <b>Custom</b> .
Set Levels In	Sets the levels as % or <b>Absolute</b> .
Start Level and Stop Level	<p>Double-tap in the field and enter the values using a connected keyboard or the virtual keyboard when <b>Levels</b> is <b>Custom</b>.</p> <p>The default values for the start level is 90% and for stop level 10%.</p> <p> <b>Note:</b> When <b>Set Levels In</b> is %, 0% to 100% maps negative part of the waveform (below zero). To measure d/dt above the zero crossing line, ensure that <b>Levels</b> is set to <b>Custom</b> and <b>Set Levels In</b> is <b>Absolute</b>.</p>
Refine Edge	Finds the optimum pulse region when the edge signal is ringing or has glitches.
Start Search Direction	Finds the start level by traversing the signal from <b>Forward</b> or <b>Backward</b> direction.
Stop Search Direction	Finds the stop level by traversing the signal from <b>Forward</b> or <b>Backward</b> direction.

### QOSS measurement: Configure panel

Field or control	Description
Pulse Region	Sets the pulse region for the signal. Tap the field to show the list of available pulses. Default value is First Pulse.
Number of Pulses	Sets the number of pulses in the input signal. Available when <b>Pulse Region</b> is <b>Multiple Pulse</b> .
Label	Sets the name of the measurement. You can use the default name, or double-tap in the field and change the label using a connected keyboard or the virtual keyboard.
Voltage Source (Vds/Vce)	Sets the voltage signal source for the power device.
Current Source	Sets the current signal source for the power device. Id is the diode current measured at the low side of the power device.
Edge Qualifier (Vgs/Vge)	Enables the gate voltage source for the power device.
Gate Source (Vgs/Vge)	Sets the voltage signal source for the power device. Vgs is the gate-source voltage when <b>Power Device</b> is <b>MOSFET</b> . Vge is the gate-emitter voltage when <b>Power Device</b> is <b>IGBT</b> .
Vds Level	Sets the Vds levels as <b>Auto</b> or <b>Custom</b> .
Set Levels In	Sets the levels as % or <b>Absolute</b> . Available when <b>Vds Level</b> is <b>Custom</b> .
Stop Level	Shows the Vds/Vce levels for the current values. The Vds level values are fixed when <b>Vds Level</b> is <b>Auto</b> . Sets the Vds level for the voltage <b>Stop Level</b> when <b>Vds Level</b> is <b>Custom</b> . Double-tap in the field and enter the values using a connected keyboard or the virtual keyboard.
Refine Edge	Finds the optimum pulse region when the edge signal is ringing or has glitches.

Table continued...

Field or control	Description
Stop Search Direction	Finds the stop level by traversing the signal from <b>Forward</b> or <b>Backward</b> direction.



**Note:** The level is searched from left to right or from right to left on the source waveform for the particular pulse region. This will give the first or last occurrence of the level respectively.

### Other measurement settings panels

[WBG-DPT Measurement Name panel \(WBG-DPT measurement Preset menu\)](#) on page 288

[Deskew panel \(WBG-DPT measurement configuration menu\)](#) on page 294

[Generator Setup: Configure AFG31000 Series \(WBG-DPT measurement configuration menu\)](#) on page 294

[Reference Levels panel \(WBG-DPT measurement configuration Menu\)](#) on page 295

[Gating panel \(WBG-DPT measurement configuration menu\)](#) on page 295

### Deskew panel (WBG-DPT measurement configuration menu)

Use the deskew panel to adjust the skew between voltage and current in WBG-DPT measurements. To open the Deskew panel for a WBG-DPT measurement:

1. Double-tap a WBG-DPT measurement badge to open the WBG-DPT measurement configuration menu.
2. Tap the **Deskew** panel.

Deskew panel is available for Switching Parameter and Switching Timing measurements except d/dt measurement.

Field or control	Description
Probe Resistance	Sets the probe resistance for the current measuring probe.
Effective Inductance	Sets the effective inductance value of the power loop.
Bias Voltage	Sets the bias voltage for mathematical model. The skew is found at the bias voltage.
Differential Order	Sets the filter order for differential filter which is used in mathematical model.
WBG Deskew	<p>WBG Deskew performs a double pulse test twice to compute and set the skew between <math>V_d</math>s and <math>I_d</math> or <math>V_{ce}</math> and <math>I_c</math>. Turn on the power supply and perform Preset before running the WBG Deskew. Use Generator Setup for gate stimulus automation. The effective inductance and differential order should be set iteratively to match the mathematical model. Refer <a href="#">WBG-DPT Deskew Algorithm</a> on page 714 for the WBG Deskew procedure.</p> <p> <b>Note:</b> WBG Deskew's generator automation is optional. If Generator Setup is not performed, WBG Deskew sets the oscilloscope in Single Sequence mode with 5 seconds timeout for manual trigger of the generator.</p>

### Generator Setup: Configure AFG31000 Series (WBG-DPT measurement configuration menu)

Configure AFG31000 Series to generate a double pulse signal of required amplitude and pulse widths. The AFG output should be given to the low side of the power device for switching, timing, and capacitance measurements, and the high side of the power device for recovery measurements.

To open the Generator Setup panel for a WBG-DPT measurement:

1. Double-tap a WBG-DPT measurement badge to open the WBG-DPT measurement configuration menu.

2. Tap the Generator Setup panel.

Field or control	Description
IP address	Enter the IP address of the AFG instrument.
Test Connection	Click to test the AFG connection. If the IP address of the generator is valid and the AFG model is the 31000 Series, a <b>Connected</b> message displays in the Generator Setup panel. If not, a <b>Not Connected</b> message will be displayed. Tap <b>Gate Stimulus</b> from the Measurement panel to generate the output from AFG31000.
AFG Source	Displays the configured AFG source. The source readout is <b>Ch1 - Low Side</b> for Switching, Timing, and Capacitance measurements and <b>Ch1 - High Side</b> for Recovery measurements.
High	Set the high amplitude value of the double pulse signal.
Low	Set the low amplitude value of the double pulse signal.
Load	Toggle between <b>50 Ohm</b> or <b>High Z</b> . Default load is High Z.
Number of Pulses	Sets the number of pulses the AFG needs to generate. The maximum number of pulses can be generated is 8 with the given width and gap. Default pulse count is 2.
Pulse Width	Sets the width of each pulse in seconds.
Gap	Sets the gap between each pulse in seconds.



**Note:** Do not change any settings in the Generator Setup Configure panel if you are not using the AFG31000 generator.

## Connection setup for WBG-DPT measurements

Please refer to WBG-DPT datasheet at [www.tek.com](http://www.tek.com) for more information on connection setup for WBG-DPT measurements.

## Reference Levels panel (WBG-DPT measurement configuration Menu)

Use the Reference Levels panel to set the scope of the reference level settings (global or local), the measurement reference levels (High, Mid, and Low), the units used to take measurements, and the method used to calculate the Top and Base waveform values. You can set the reference levels to be the same or different for rising and falling edges.

See [Reference Levels panel \(Measurement configuration menu\)](#) on page 212 for the Reference panel fields and controls.



**Note:** It is recommended to use Histogram mean or mode for Base top method instead of Auto. It works better for noisy waveforms with glitches and oscillations.

## Other measurement settings panels

[WBG-DPT Measurement Name panel \(WBG-DPT measurement Preset menu\)](#) on page 288

[Configure panel \(WBG-DPT measurement configuration menu\)](#) on page 289

[Gating panel \(WBG-DPT measurement configuration menu\)](#) on page 295

## Gating panel (WBG-DPT measurement configuration menu)

Use Gating to confine a measurement to a certain part of a waveform.

See [Gating panel \(Measurement configuration menu\)](#) on page 218 for the Gating panel fields and controls.

## Other measurement settings panels

[WBG-DPT Measurement Name panel \(WBG-DPT measurement Preset menu\)](#) on page 288

[Configure panel \(WBG-DPT measurement configuration menu\)](#) on page 289

[Reference Levels panel \(WBG-DPT measurement configuration Menu\)](#) on page 295

## Bus configuration menu

Use the Bus menu to select the bus type to display, configure the input sources, and set how to display the bus on the screen.

To open the Bus configuration menu:

- For an existing bus, double-tap the **Bus** badge in the Settings bar.
- To add a new Bus badge on the Settings bar, tap the **Add New Bus** button. This adds the Bus badge to the Settings bar and opens the Bus configuration menu.

### Bus configuration menu - fields and controls

Field or control	Description
<b>Display</b>	Toggles bus display <b>On</b> or <b>Off</b> .
<b>Label</b>	Enter label text in this field. The default label is the name of the bus type.
<b>Position</b>	Sets the vertical position of the bus waveform. Default is 0 (center of graticule).
<b>Set to 0</b>	Sets the vertical position of the bus waveform to 0 (center graticule).
<b>Bus Type</b>	Select a bus from the drop down list. The Parallel bus type comes standard on the instrument. Serial buses require purchase and installation of serial bus triggering and analysis options.
<b>Source configuration</b>	A set of fields and controls that set the bus signal input parameters. Shown fields depend on the selected bus type. See the individual bus configuration help topics for information on their settings.
<b>Display format</b>	Enables showing just the decoded bus or both the bus and its digital waveforms. You can also tap on the + symbol on the bus waveform to toggle between showing the bus only or showing bus and source waveforms.
<b>Decode format</b>	Sets how decoded data information is shown in the bus. Select from listed formats. Available formats depend on the bus type.

### Bus type configuration menus

Use the following links to access information on specific Bus configuration menus.

[ARINC 429 serial bus menu](#)

[Audio serial bus configuration menu](#) on page 300

[Auto Ethernet serial bus configuration menu](#) on page 301

[CAN serial bus configuration menu](#) on page 303

[Ethernet serial bus menu](#) on page 309

[EtherCAT serial bus configuration menu](#) on page 310

[eUSB serial bus configuration menu](#) on page 311

[FlexRay serial bus configuration menu](#) on page 313

[I2C serial bus configuration menu](#) on page 314

- [LIN serial bus configuration menu](#) on page 316
- [MDIO serial bus configuration menu](#) on page 318
- [MIL-STD-1553 serial bus menu](#) on page 319
- [NFC serial bus configuration menu](#) on page 320
- [Parallel Bus configuration menu](#) on page 322
- [RS232 serial bus menu](#) on page 326
- [SDLC serial bus configuration menu](#) on page 327
- [SENT serial bus configuration menu](#) on page 328
- [SMBus serial bus configuration menu](#) on page 329
- [SpaceWire serial bus configuration menu](#) on page 330
- [SPI serial bus configuration menu](#) on page 331
- [SPMI serial bus configuration menu](#) on page 333
- [SVID serial bus configuration menu](#) on page 334
- [USB serial bus configuration menu](#) on page 335

## 1-Wire serial bus configuration menu

Use the 1-Wire bus menu to set up and display an 1-Wire serial bus waveform.

To set up the 1-Wire serial bus:

- To add a new 1-Wire bus, tap the **Add New Bus** button on the Settings bar. Open the bus configuration menu by double clicking on the badge. Set the **Bus Type** to **1-Wire**.
- To change the settings on an existing 1-Wire serial bus, double-tap the 1-Wire **Bus** badge and make necessary changes.

### 1-Wire serial bus menu fields and controls

Field or control	Description
<b>Display</b>	Turns on or off displaying the bus on the Waveform view.
<b>Label</b>	Enter a label for the bus. The default label is the selected bus type.  To enter the label text, double-tap the field and enter label using the virtual keyboard, or tap the field and enter the text from an attached keyboard.
<b>Position</b>	Sets the vertical position of the bus waveform. The default position is vertically centered in a slice (in Stacked mode), or center screen in Overlay mode. The unit of position is screen divisions.
<b>Set to 0</b>	Sets the vertical position to 0 divisions (centered vertically in a slice or on the screen).
<b>Bus Type</b>	Set to <b>1-Wire</b> .
<b>Mode</b>	Selects the standard.  Available options are <b>Standard (15.4 Kbps)</b> and <b>Overdrive (125 Kbps)</b> . Default is <b>Standard (15.4 Kbps)</b> .
<b>Source</b>	Select the channel source for the signal.
<b>Threshold</b>	Select the threshold for the signal.
<b>Display Format</b>	Sets the waveform view to show just the decoded bus information.

Table continued...

Field or control	Description
<b>Decode Format</b>	Sets the decode format used to display the bus information. Formats are <b>Hex</b> , <b>Mixed Hex</b> , and <b>Binary</b> .

### Other bus types

Other serial bus types are available as purchasable options. Once purchased and installed, the new bus types are shown in the Bus Type menu. The serial bus options also add corresponding bus trigger capabilities (when supported) to the **Trigger** menu. See the [Bus configuration menu](#) on page 296 for links to all serial bus configuration menus.

### See also

[Bus Trigger configuration](#) on page 561

[Bus Search configuration menus](#) on page 347

[1-Wire serial bus search configuration menu](#) on page 348

## 8b10b serial bus configuration menu

Use the 8b10b bus menu to set up and display an 8b10b serial bus waveform.

To set up a 8b10b serial bus:

- To add a new 8b10b bus waveform, tap the **Add New Bus** button on the Settings bar. Open the bus configuration menu by double-tapping the badge. Set the **Bus Type** to **8b10b**.
- To change the settings on an existing 8b10b serial bus waveform, double-tap the **8b10b** waveform badge on the Settings bar to open the configuration menu, and make necessary changes.

You can [configure search for 8b10b](#) and define conditions to search for and mark on an 8b10 bus waveform.

### 8b10b serial bus menu fields and controls

Field or control	Description
<b>Display</b>	Turns on or off displaying the bus on the Waveform view.
<b>Label</b>	Enter a label for the bus. The default label is the selected bus type.  To enter label text, double-tap the field and enter label using the virtual keyboard, or tap the field and enter text from an attached keyboard.
<b>Position</b>	Sets the vertical position of the bus waveform. The default position is vertically centered in a slice (in Stacked mode), or center screen in Overlay mode. The unit of position is screen divisions.
<b>Set to 0</b>	Sets the vertical position to 0 divisions (centered vertically in a slice or on the screen).
<b>Bus Type</b>	Set to <b>8b10b</b> .
<b>Source</b>	Select the signal source from listed analog and digital channels.
<b>Threshold</b>	Sets the threshold value for the signal source.
<b>Bit Rate</b>	Set the bit rate. You can configure values from 1 bps to 1 Gbps.
<b>Display Format</b>	Sets the waveform view to show just the decoded bus information, or the decoded bus plus the source signal waveforms.
<b>Decode Format</b>	Sets the decode format used to display the bus information. Formats are Hex, Binary, and Symbolic Decode.

## Other bus types

Other serial bus types are available as purchasable options. Once purchased and installed, the new bus types are shown in the Bus Type menu. The serial bus options also add corresponding bus trigger capabilities (when supported) to the **Trigger** menu. See the [Bus configuration menu](#) on page 296 for links to all serial bus configuration menus.

## See also

[Bus Trigger configuration](#) on page 561

[Bus Search configuration menus](#) on page 347

[8b10b serial bus search configuration menu](#) on page 350

## ARINC 429 serial bus menu

Use the ARINC 429 bus menu to set up and decode a ARINC 429 avionics network serial data bus waveform.

To set up the ARINC 429 avionics serial data bus:

- Tap the **Add New Bus** button on the Settings bar. Open the bus configuration menu by double clicking on the new Bus badge. Set the **Bus Type** to **ARINC429**.
- To change the settings on an existing ARINC 429 serial bus waveform, double-tap the **Bus** waveform badge and make necessary changes.

## ARINC 429 serial bus menu fields and controls

Field or control	Description
<b>Display</b>	Turns on or off displaying the bus on the Waveform view.
<b>Label</b>	Enter a label for the bus. The default label is the selected bus type.  To enter label text, double-tap the field and enter label using the virtual keyboard, or tap the field and enter text using an attached keyboard.
<b>Position</b>	Sets the vertical position of the bus waveform. The default position is vertically centered in a slice (in Stacked mode), or center screen in Overlay mode. The unit of position is screen divisions.
<b>Set to 0</b>	Sets the vertical position to 0 divisions (centered vertically in a slice or on the screen).
<b>Bus Type</b>	Set to <b>ARINC429</b> .
<b>Polarity</b>	Select the polarity to match the ARINC 429 bus being acquired.
<b>Source</b>	Select the ARINC 429 signal source.
<b>High Threshold, Low Threshold</b>	Sets the valid high and low threshold values for the signal source.
<b>Bit Rate</b>	Sets the bit rate to 12,500, 100,000, or Custom.
<b>Custom Rate</b>	Sets a custom data bit rate. To set the value, tap the field and use the Multipurpose knob, double-tap the field and use the Custom Rate virtual keypad, or double-tap the field and use an attached keyboard.  Only available when Bit Rate = Custom.
<b>Data Format</b>	Sets the data format to Data (19 bits), SDI (Source/Destination Identifiers) plus data (21 bits), or SDI plus Data plus Sign/Status Matrix (SSM) (23 bits).
<b>Display Format</b>	Sets the waveform view to show just the decoded bus information, or the decoded bus plus the source signal waveforms.

Table continued...

Field or control	Description
Decode Format	Sets the decode format used to display the bus information. Formats are Hex, Binary, and Mixed Hex.

### Other bus types

Other serial bus types are available as purchasable options. Once purchased and installed, the new bus types are shown in the Bus Type menu. The serial bus options also add corresponding bus trigger capabilities (when supported) to the **Trigger** menu. See the [Bus configuration menu](#) on page 296 for links to all serial bus configuration menus.

### See also

[Bus Trigger configuration](#) on page 561

[Bus Search configuration menus](#) on page 347

[ARINC 429 serial bus search configuration menu](#) on page 351

## Audio serial bus configuration menu

Use the Audio bus menu to set up and display Audio Type I2S, Left Justified (LJ), Right Justified (RJ), or TDM Audio serial bus waveforms.

To set up the Audio serial bus:

- To create a new Audio bus waveform, tap the **Add New Bus** button on the Settings bar and open the Bus configuration menu. Set the **Bus Type** to **Audio**.
- To change the settings on an existing Audio serial bus waveform, double-tap the **Bus** waveform badge and make the necessary changes.

### Audio serial bus menu fields and controls

Field or control	Description
Display	Turns on or off displaying the bus on the Waveform view.
Label	Enter a label for the bus. The default label is the selected bus type.  To enter label text, double-tap the field and enter label using the virtual keyboard, or tap the field and enter text from an attached keyboard.
Position	Sets the vertical position of the bus waveform. The default position is vertically centered in a slice (in Stacked mode), or center screen in Overlay mode. The unit of position is screen divisions.
Set to 0	Sets the vertical position to 0 divisions (centered vertically in a slice or on the screen).
Bus Type	Set to <b>Audio</b> .
Audio Type	Sets the digital audio signal type. Select from the drop-down list.
Bit Order	Set the waveform to decode with most-significant (MS) bit first or least-significant (LS) bit first.
Bit Clock	Set the signal source, logic level threshold, and polarity for the Bit Clock signal.
Word Select	Set the signal source, logic level threshold, and normal or invert signal setting for the Word signal.
Data	Set the signal source, logic level threshold, and logic definition (active high or low) for the Data signal.
Word Size (Audio Type = I2S, LJ, or RJ)	Set the number of bits used in a Word for the selected audio type (8, 12, 16, 18, 20, 24, 28, or 32-bits).

Table continued...



Field or control	Description
Display Format	Sets the waveform view to show just the decoded bus information, or the decoded bus plus the source signal waveforms.
Decode Format	Sets the decode format used to display the bus information.
<b>TDM-specific settings</b>	
Frame Sync	Set the signal source, logic level threshold, and polarity for the frame sync signal.
Data Bits per Channel	Set the number of data bits per audio channel.
Clock Bits per Channel	Set the number of clock bits per audio channel.
Channels per Frame	Set the number of audio channels per data frame.
Bit Delay	Sets the bit delay (number of bits).

## Other bus types

Other serial bus types are available as purchasable options. Once purchased and installed, the new bus types are shown in the Bus Type menu. The serial bus options also add corresponding bus trigger capabilities (when supported) to the **Trigger** menu. See the [Bus configuration menu](#) on page 296 for links to all serial bus configuration menus.

## See also

[Bus Trigger configuration](#) on page 561

[Bus Search configuration menus](#) on page 347

[Audio serial bus search configuration menu](#) on page 353

## Auto Ethernet serial bus configuration menu

Use the Auto Ethernet bus menu to set up and display an Auto Ethernet serial bus waveform.

To set up a Auto Ethernet serial bus:

- To add a new Auto Ethernet serial bus waveform, tap the **Add New Bus** button on the Settings bar. Open the bus configuration menu by double clicking on the badge. Set the **Bus Type** to **Auto Ethernet**.
- To change the settings on an existing Auto Ethernet serial bus waveform, double-tap the **Bus** waveform badge on the Settings bar to open the configuration menu, and make necessary changes.

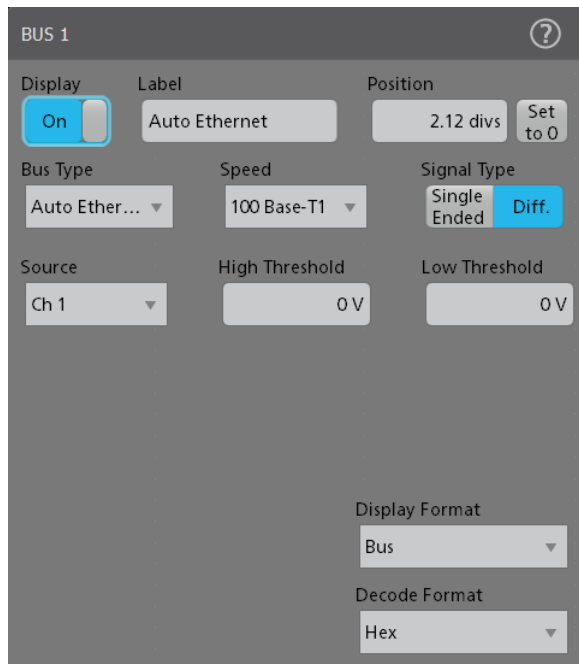

You can [configure search for Auto Ethernet](#) and define conditions to search for and mark on an Auto Ethernet bus waveform.

### Auto Ethernet serial bus menu fields and controls

Field or control	Description
<b>Display</b>	Turns on or off displaying the bus on the Waveform view.
<b>Label</b>	Enter a label for the bus. The default label is the selected bus type. To enter label text, double-tap the field and enter label using the virtual keyboard, or tap the field and enter text from an attached keyboard.
<b>Position</b>	Sets the vertical position of the bus waveform. The default position is vertically centered in a slice (in Stacked mode), or center screen in Overlay mode. The unit of position is screen divisions.
<b>Set to 0</b>	Sets the vertical position to 0 divisions (centered vertically in a slice or on the screen).
<b>Bus Type</b>	Set to <b>Auto Ethernet</b> .
<b>Speed</b>	Sets the network signal speed as <b>100Base-T1</b> .
<b>Signal type</b>	Sets the signal type to Single-Ended or Differential.
<b>Source</b>	Select the channel source for the signal from a differential probe. Only available when Signal Type = Diff.
<b>High Threshold</b>	Sets the threshold value for a logic 1 value. Only available when Signal Type = Diff.
<b>Low Threshold</b>	Sets the threshold value for a logic 0 value. Only available when Signal Type = Diff.
<b>D+ Input, D- Input</b>	Sets the signal sources and threshold values for the Single Ended data+ and - signals. Only available when Signal Type = Single-Ended.

Table continued...

Field or control	Description
Display Format	Sets the waveform view to show just the decoded bus information, or the decoded bus plus the source signal waveforms.
Decode Format	Sets the decode format used to display the bus information. Formats are Hex and Binary.

## Other bus types

Other serial bus types are available as purchasable options. Once purchased and installed, the new bus types are shown in the Bus Type menu. The serial bus options also add corresponding bus trigger capabilities (when supported) to the **Trigger** menu. See the [Bus configuration menu](#) on page 296 for links to all serial bus configuration menus.

## See also

[Bus Trigger configuration](#) on page 561

[Bus Search configuration menus](#) on page 347

[Auto Ethernet serial bus search configuration menu](#) on page 354

## CAN serial bus configuration menu

Use the CAN bus menu to set up and display a CAN (Controller Area Network) or CAN FD (CAN Flexible Datarate) serial bus waveform.

- To create a new CAN bus waveform:
  - Tap **Add New Bus** on the Settings bar.
  - Double-tap the **CAN** badge to open the bus configuration menu.
  - Set the **Bus Type** to **CAN**.
- To change the settings on an existing CAN serial bus waveform, double-tap the **CAN** waveform badge on the Settings bar to open the configuration menu.

## CAN serial bus menu fields and controls

Field or control	Description
Display	Turns on or off displaying the bus on the Waveform view.
Label	Enter a label for the bus. The default label is the selected bus type.  To enter label text, double-tap the field and enter label using the virtual keyboard, or tap the field and enter text from an attached keyboard.
Position	Sets the vertical position of the bus waveform. The default position is vertically centered in a slice (in Stacked mode), or center screen in Overlay mode. The unit of position is screen divisions.
Set to 0	Sets the vertical position to 0 divisions (centered vertically in a slice or on the screen).
Bus Type	Set to <b>CAN</b> to set up and display a CAN bus waveform.
Signal Type	Sets the CAN signal type to decode. The default is <b>CAN_H</b> .
CAN Standard	Sets the CAN signal standard to decode. The default is <b>CAN 2.0</b> .
Source	Select the signal source from listed analog and digital channels.
Threshold	Sets the high/low logic transition level.
Sample Point	Sets the sample point from 5% to 95% of the position within the bit period or the unit interval.

Table continued...

Field or control	Description
<b>Bit Rate</b>	<p>Sets the bit rate of your CAN bus serial data.</p> <p>To enter a custom bit rate, select <b>Custom</b> and enter the custom bit rate in the <b>Custom Rate</b> input box.</p> <p>Available when <b>CAN Standard</b> is <b>CAN 2.0</b>.</p>
<b>SD Bit Rate</b>	<p>Sets the SD bit rate of your CAN FD serial bus data.</p> <p>To enter a custom bit rate, select <b>Custom</b> and enter the custom bit rate in the <b>Custom Rate</b> input box.</p> <p>Available when <b>CAN Standard</b> is <b>CAN FD (ISO)</b> or <b>CAN FD (non-ISO)</b>.</p>
<b>FD Bit Rate</b>	<p>Sets the FD bit rate of your CAN FD serial bus data.</p> <p>To enter a custom bit rate, select <b>Custom</b> and enter the custom bit rate in the <b>Custom Rate</b> input box.</p> <p>Available when <b>CAN Standard</b> is <b>CAN FD (ISO)</b> or <b>CAN FD (non-ISO)</b>.</p>
<b>Custom rate</b>	<p>Sets the custom bit rate to use to decode the signal. Tap the field and use the Multipurpose knob to change the value, or double-tap on the field and use the virtual keypad to enter a custom bit rate.</p> <p>Available when <b>Bit Rate</b> or <b>SDI Bit Rate</b> is <b>Custom</b>.</p>
<b>Display Format</b>	<p><b>Bus</b> sets the Waveform view to show just the decoded bus information.</p> <p><b>Bus and Waveform</b> sets the Waveform view to show both the decoded bus and the source signal waveforms.</p> <p>You can also tap on the + symbol on the bus waveform to toggle between showing the bus only or showing bus and source waveforms.</p>
<b>Decode Format</b>	<p>Sets the decode format used to display the bus information. Formats are <b>Hex</b>, <b>Binary</b>, <b>Mixed Hex</b>, and <b>Symbolic</b>.</p> <p>Selecting <b>Symbolic</b> lets you navigate to and load a dbc decode label file for the current CAN waveform. The .dbc file is a proprietary description of a CAN bus system and its message and signal labels. Loading the .dbc file displays the message and signal information on the decoded CAN waveform. Selecting a .dbc file immediately loads the .dbc contents into the instrument.</p> <p> <b>Note:</b> .dbc files are not saved as part of a save session operation.</p> <p>To remove the .dbc symbolic information from the waveform, select a different <b>Decode Format</b>.</p>
<b>Browse</b>	<p>Opens the standard <b>File Open</b> dialog to navigate to and load a .dbc file to apply to the bus being created. You can navigate to TekDrive to load .dbc file. The <b>File Open</b> dialog automatically filters for the .dbc file extension.</p> <p>Available when <b>Decode Format</b> is <b>Symbolic</b>.</p>
<b>Path field</b>	<p>Use to enter the path to a .dbc file, or select from a drop-down list of recently accessed .dbc files.</p> <p>Available when <b>Decode Format</b> is <b>Symbolic</b>.</p>

### Other bus types

Other serial bus types are available as purchasable options. Once purchased and installed, the new bus types are shown in the Bus Type menu. The serial bus options also add corresponding bus trigger capabilities (when supported) to the **Trigger** menu. See the [Bus configuration menu](#) on page 296 for links to all serial bus configuration menus.

## See also

[Bus Trigger configuration](#) on page 561

[Bus Search configuration menus](#) on page 347

[CAN serial bus search configuration menu \(when not using a .dbc symbol definition file\)](#) on page 356

## CPHY serial bus configuration menu

Use the CPHY bus menu to set up and display an CPHY serial bus waveform.

To set up the CPHY serial bus:

- To add a new CPHY bus, tap the **Add New Bus** button on the Settings bar. Open the bus configuration menu by double clicking on the badge. Set the **Bus Type** to **CPHY**.
- To change the settings on an existing CPHY serial bus, double-tap the CPHY **Bus** badge and make necessary changes.

### CPHY serial bus menu fields and controls

Field or control	Description
<b>Display</b>	Turns on or off displaying the bus on the Waveform view.
<b>Label</b>	Enter a label for the bus. The default label is the selected bus type.  To enter the label text, double-tap the field and enter label using the virtual keyboard, or tap the field and enter the text from an attached keyboard.
<b>Position</b>	Sets the vertical position of the bus waveform. The default position is vertically centered in a slice (in Stacked mode), or center screen in Overlay mode. The unit of position is screen divisions.
<b>Set to 0</b>	Sets the vertical position to 0 divisions (centered vertically in a slice or on the screen).
<b>Bus Type</b>	Set to <b>CPHY</b> .
<b>Sub Type</b>	Sets the sub type.  Available options are <b>CSI</b> , <b>DSI</b> , <b>Word</b> , <b>Symbol</b> .
<b>Signal Type</b>	Sets the signal type.  Available options are <b>Single Ended</b> and <b>Diff</b> .
<b>Bit Rate</b>	Sets the bit rate.
<b>Source</b>	Select the channel source for the signal.
<b>Threshold</b>	Select the threshold for the signal.
<b>LP Direction</b>	Sets the LP direction to forward or reverse.  Available only when <b>Sub Type = DSI</b>
<b>LP Threshold</b>	Select the LP threshold for the signal.  Available only when <b>Signal Type = Single Ended</b>
<b>Display Format</b>	Sets the waveform view to show just the decoded bus information.
<b>Decode Format</b>	Sets the decode format used to display the bus information. Formats are <b>Hex</b> , <b>Mixed Hex</b> , and <b>Binary</b> .

## Other bus types

Other serial bus types are available as purchasable options. Once purchased and installed, the new bus types are shown in the Bus Type menu. The serial bus options also add corresponding bus trigger capabilities (when supported) to the **Trigger** menu. See the [Bus configuration menu](#) on page 296 for links to all serial bus configuration menus.

### See also

[Bus Trigger configuration](#) on page 561

[Bus Search configuration menus](#) on page 347

[CPHY serial bus search configuration menu](#) on page 359

## CXPI serial bus configuration menu

Use the CXPI bus menu to set up and display an CXPI serial bus waveform

To set up the CXPI serial bus:

- To add a new CXPI bus, tap the **Add New Bus** button on the Settings bar. Open the bus configuration menu by double clicking on the badge. Set the **Bus Type** to **CXPI**.
- To change the settings on an existing CXPI serial bus, double-tap the CXPI **Bus** badge and make necessary changes.

### CXPI serial bus menu fields and controls

Field or control	Description
<b>Display</b>	Turns on or off displaying the bus on the Waveform view.
<b>Label</b>	Enter a label for the bus. The default label is the selected bus type.  To enter the label text, double-tap the field and enter label using the virtual keyboard, or tap the field and enter the text from an attached keyboard.
<b>Position</b>	Sets the vertical position of the bus waveform. The default position is vertically centered in a slice (in Stacked mode), or center screen in Overlay mode. The unit of position is screen divisions.
<b>Set to 0</b>	Sets the vertical position to 0 divisions (centered vertically in a slice or on the screen).
<b>Bus Type</b>	Set to <b>CXPI</b> .
<b>Bit Rate</b>	Sets the bit rate to decode the waveform.
<b>Data Input</b>	Sets the source and threshold (recessive) level for the signal.
<b>Display Format</b>	Sets the waveform view to show just the decoded bus information.
<b>Decode Format</b>	Sets the decode format used to display the bus information. Formats are <b>Hex</b> , <b>Mixed Hex</b> , and <b>Binary</b> .

## Other bus types

Other serial bus types are available as purchasable options. Once purchased and installed, the new bus types are shown in the Bus Type menu. The serial bus options also add corresponding bus trigger capabilities (when supported) to the **Trigger** menu. See the [Bus configuration menu](#) on page 296 for links to all serial bus configuration menus.

### See also

[Bus Trigger configuration](#) on page 561

[Bus Search configuration menus](#) on page 347

[CXPI serial bus search configuration menu](#) on page 362

## DPHY serial bus configuration menu

Use the DPHY bus menu to set up and display an DPHY (clock, data + and data -) serial bus waveform.

To set up the DPHY serial bus:

- To add a new DPHY bus, tap the **Add New Bus** button on the Settings bar. Open the bus configuration menu by double clicking on the badge. Set the **Bus Type** to **DPHY**.
- To change the settings on an existing DPHY serial bus, double-tap the DPHY **Bus** badge and make necessary changes.

### DPHY serial bus menu fields and controls

Field or control	Description
<b>Display</b>	Turns on or off displaying the bus on the Waveform view.
<b>Label</b>	Enter a label for the bus. The default label is the selected bus type.  To enter label text, double-tap the field and enter label using the virtual keyboard, or tap the field and enter text from an attached keyboard.
<b>Position</b>	Sets the vertical position of the bus waveform. The default position is vertically centered in a slice (in Stacked mode), or center screen in Overlay mode. The unit of position is screen divisions.
<b>Set to 0</b>	Sets the vertical position to 0 divisions (centered vertically in a slice or on the screen).
<b>Bus Type</b>	Set to <b>DPHY</b> .
<b>Protocols</b>	Select the protocol to decode.  Available options are <b>CSI</b> and <b>DSI</b> . Default is CSI.
<b>LP Direction</b>	Set the LP (Low Power) direction, host to peripheral or peripheral to host.  Available options are <b>Forward</b> and <b>Reverse</b> .  Available only when <b>Protocols = DSI</b> .
<b>Source</b>	Select the channel source for the signal.
<b>Data Threshold</b>	Select the data threshold for Dp and Dn signals.
<b>LP Threshold</b>	Select the LP threshold for Dp and Dn signals.
<b>Dp Input, Dn Input</b>	Sets the signal sources.
<b>8b9b Encoding</b>	Turns on or off 8b9b line encoding to support additional control features. Default is OFF.
<b>Display Format</b>	Sets the waveform view to show just the decoded bus information.
<b>Decode Format</b>	Sets the decode format used to display the bus information. Formats are <b>Hex</b> , <b>Mixed Hex</b> , and <b>Binary</b> .

### Other bus types

Other serial bus types are available as purchasable options. Once purchased and installed, the new bus types are shown in the Bus Type menu. The serial bus options also add corresponding bus trigger capabilities (when supported) to the **Trigger** menu. See the [Bus configuration menu](#) on page 296 for links to all serial bus configuration menus.

### See also

[Bus Trigger configuration](#) on page 561

[Bus Search configuration menus](#) on page 347

[DPHY serial bus search configuration menu](#) on page 363

## eSPI serial bus configuration menu

Use the eSPI bus menu to set up and display an eSPI (Enhanced Serial Peripheral Interface) serial bus waveform.

To set up the eSPI serial bus:

- To add a new eSPI bus, tap the **Add New Bus** button on the Settings bar. Open the bus configuration menu by double clicking on the badge. Set the **Bus Type** to **eSPI**.
- To change the settings on an existing eSPI serial bus, double-tap the eSPI **Bus** badge and make necessary changes.

### eSPI serial bus menu fields and controls

Field or control	Description
<b>Display</b>	Turns on or off displaying the bus on the Waveform view.
<b>Label</b>	Enter a label for the bus. The default label is the selected bus type.  To enter the label text, double-tap the field and enter label using the virtual keyboard, or tap the field and enter the text from an attached keyboard.
<b>Position</b>	Sets the vertical position of the bus waveform. The default position is vertically centered in a slice (in Stacked mode), or center screen in Overlay mode. The unit of position is screen divisions.
<b>Set to 0</b>	Sets the vertical position to 0 divisions (centered vertically in a slice or on the screen).
<b>Bus Type</b>	Set to <b>eSPI</b> .
<b>I/O Mode</b>	Toggles between <b>Single</b> and <b>Dual</b> mode.
<b>Alert</b>	Turns on or off the alert signal.
<b>SCLK Input</b>	Select the channel source and threshold level for the Serial Clock signal.  Set the Polarity to rising or falling edge of the clock signal used by the master device to start transferring bits.
<b>CS Input</b>	Select the channel source and threshold level for the Chip Select signal.  Set the Polarity to use Active High or Active Low logic for the CS signal.
<b>Command Input</b>	Select the channel source and threshold level for the command input signal.  Set the Polarity to use Active High or Active Low logic for the command signal.  Available only when <b>I/O mode = Single</b> .
<b>Response Input</b>	Select the channel source and threshold level for the response input signal.  Set the Polarity to use Active High or Active Low logic for the response signal.  Available only when <b>I/O mode = Single</b> .
<b>IO[0]Input</b>	Select the channel source and threshold level for the IO[0] signal.  Available only when <b>I/O mode = Dual</b> .

Table continued...



Field or control	Description
<b>IO[1]Input</b>	Select the channel source and threshold level for the IO[1] signal. Available only when <b>I/O mode = Dual</b> .
<b>Display Format</b>	Sets the waveform view to show the decoded bus information.
<b>Decode Format</b>	Sets the decode format used to display the bus information. Formats are <b>Hex</b> , <b>Mixed Hex</b> , and <b>Binary</b> .

## Other bus types

Other serial bus types are available as purchasable options. Once purchased and installed, the new bus types are shown in the Bus Type menu. The serial bus options also add corresponding bus trigger capabilities (when supported) to the **Trigger** menu. See the [Bus configuration menu](#) on page 296 for links to all serial bus configuration menus.

## See also

[Bus Trigger configuration](#) on page 561

[Bus Search configuration menus](#) on page 347

[eSPI serial bus search configuration menu](#) on page 365

## Ethernet serial bus menu

Use the Ethernet bus menu to set up and display an Ethernet 10BaseT or 100BaseT serial bus waveform.

To use the Ethernet serial bus menu:

- To create a new Ethernet bus waveform, tap the **Add New Bus** button on the Settings bar. Open the bus configuration menu by double clicking on the badge. Set the **Bus Type** to **Ethernet**.
- To change the settings on an existing Ethernet serial bus waveform, double-tap the Ethernet **Bus** waveform badge to open the configuration menu.

## Ethernet serial bus menu fields and controls

Field or control	Description
<b>Display</b>	Turns on or off displaying the bus on the Waveform view.
<b>Label</b>	Enter a label for the bus. The default label is the selected bus type. To enter label text, double-tap the field and enter label using the virtual keyboard, or tap the field and enter text from an attached keyboard.
<b>Position</b>	Sets the vertical position of the bus waveform. The default position is vertically centered in a slice (in Stacked mode), or center screen in Overlay mode. The unit of position is screen divisions.
<b>Set to 0</b>	Sets the vertical position to 0 divisions (centered vertically in a slice or on the screen).
<b>Bus Type</b>	Set to <b>Ethernet</b> .
<b>Speed</b>	Sets the network signal speed.
<b>Signal Type</b>	Sets the signal type to Single Ended or Differential.
<b>Source</b>	Sets the signal source for Differential. Only available when Signal Type = Diff.

Table continued...

Field or control	Description
<b>D+ Input, D- Input</b>	Defines the signal sources and threshold values for the Single Ended data+ and - signals. Only available when Signal Type = Single Ended.
<b>High Threshold</b>	Sets the threshold value for a logic 1 value. Only available when Signal Type = Diff.
<b>Low Threshold</b>	Sets the threshold value for a logic 0 value. Only available when Signal Type = Diff.
<b>IPv4</b>	Set to Yes if the Ethernet signal being measured uses Internet Protocol version 4 (IPv4).
<b>Q-(VLAN)</b>	Set to Yes if the Ethernet signal being measured uses IEEE 802.1Q virtual LANs.
<b>Display Format</b>	Sets the waveform view to show just the decoded bus information, or the decoded bus plus the source signal waveforms.
<b>Decode Format</b>	Sets the decode format used to display the bus information. Formats are Hex, Binary, Mixed ASCII, and Mixed Hex.

### Other bus types

Other serial bus types are available as purchasable options. Once purchased and installed, the new bus types are shown in the Bus Type menu. The serial bus options also add corresponding bus trigger capabilities (when supported) to the **Trigger** menu. See the [Bus configuration menu](#) on page 296 for links to all serial bus configuration menus.

### See also

[Bus Trigger configuration](#) on page 561

[Bus Search configuration menus](#) on page 347

[Ethernet serial bus search configuration menu](#) on page 369

## EtherCAT serial bus configuration menu

Use the EtherCAT bus menu to set up and display an EtherCAT serial bus waveform.

To set up a EtherCAT serial bus:

- To create a new EtherCAT bus waveform, tap the **Add New Bus** button on the Settings bar. Open the bus configuration menu by double clicking on the badge. Set the **Bus Type** to **EtherCAT**.
- To change the settings on an existing EtherCAT serial bus waveform, double-tap the EtherCAT **Bus** waveform badge on the Settings bar to open the configuration menu, and make necessary changes.

### EtherCAT serial bus menu fields and controls

Field or control	Description
<b>Display</b>	Enables or disables displaying the bus on the Waveform view.
<b>Label</b>	Enter a label for the bus. The default label is the selected bus type.  To enter label text, double-tap the field and enter label using the virtual keyboard, or tap the field and enter text from an attached keyboard.

Table continued...

Field or control	Description
<b>Position</b>	Sets the vertical position of the bus waveform. The default position is vertically centered in a slice (Stacked mode), or center screen (Overlay mode). The unit of position is screen divisions.
<b>Set to 0</b>	Sets the vertical position to 0 divisions (centered vertically in a slice or on the screen).
<b>Bus Type</b>	Set to <b>EtherCAT</b> .
<b>Signal Type</b>	Set the signal type to <b>Single Ended</b> or <b>Diff</b> .
<b>D+ Input, D- Input</b>	Defines the signal sources and threshold values for the Single Ended data + and - signals. Available only when <b>Signal Type</b> is <b>Single Ended</b> .
<b>Source</b>	Set the signal source as <b>Diff</b> for differential source. Available only when <b>Signal Type</b> is <b>Diff</b> .
<b>Threshold</b>	Set the threshold value for the differential signal. Available only when <b>Signal Type</b> is <b>Diff</b> .
<b>Display Format</b>	Set the waveform view to show the decoded bus information.
<b>Decode Format</b>	Sets the decode format used to display the bus information. Available formats are Hex, Binary, and Mixed Hex.

## Other bus types

Other serial bus types are available as purchasable options. Once purchased and installed, the new bus types are shown in the Bus Type menu. The serial bus options also add corresponding bus trigger capabilities (when supported) to the **Trigger** menu. See the [Bus configuration menu](#) on page 296 for links to all serial bus configuration menus.

## See also

[Bus Trigger configuration](#) on page 561

[Bus Search configuration menus](#) on page 347

[EtherCAT serial bus search configuration menu](#) on page 371

## eUSB serial bus configuration menu

Use the Embedded USB bus menu to set up and display an eUSB 2.0 (Embedded Universal Serial Bus) waveform.

To set up a eUSB serial bus:

- To create a new eUSB bus waveform, tap the **Add New Bus** button on the Settings bar. Open the bus configuration menu by double clicking on the badge. Set the **Bus Type** to **eUSB**.
- To change the settings on an existing eUSB serial bus waveform, double-tap the **Bus** waveform badge on the Settings bar to open the configuration menu, and make necessary changes.

## eUSB serial bus menu fields and controls

Field or control	Description
<b>Display</b>	Turns on or off displaying the bus on the Waveform view.

Table continued...

Field or control	Description
<b>Label</b>	Enter a label for the bus. The default label is the selected bus type.  To enter label text, double-tap the field and enter label using the virtual keyboard, or tap the field and enter text from an attached keyboard.
<b>Position</b>	Sets the vertical position of the bus waveform. The default position is vertically centered in a slice (in Stacked mode), or center screen in Overlay mode. The unit of position is screen divisions.
<b>Set to 0</b>	Sets the vertical position to 0 divisions (centered vertically in a slice or on the screen).
<b>Bus Type</b>	Set to <b>eUSB</b> .
<b>Speed</b>	Set the speed to match the acquiring speed of the eUSB bus.  Available data rate options are <b>Full (12 Mbps)</b> , <b>High Speed (480 Mbps)</b> , and <b>Low (1.5 Mbps)</b> .
<b>Mode</b>	Set the mode of operation to Native or Repeater. Default is Native. <ul style="list-style-type: none"> <li>• <b>Native</b> mode is used for inter chip disconnect.</li> <li>• <b>Repeater</b> is used to communicate eUSB2 port with USB2.0 through repeater that translates between 2USB2 signaling and USB2.0 signaling.</li> <li>• <b>Repeater Peripheral</b></li> </ul>
<b>Signal Type</b>	Set to match the eUSB signal you are acquiring (Single Ended or Differential). Use a differential probe to acquire the differential USB signal.  Both Single Ended and Diff can be used to measure High speed USB signals. Single Ended is used to measure Full (12 Mbps) and Low (1.2 Mbps) speed USB signals.   <b>Note:</b> Signal Type selection is applicable only in High Speed.
<b>Source</b>	Select the channel source for the signal from a differential probe.  Only available when <b>Signal Type = Diff</b> .
<b>Threshold</b>	Set the threshold level.
<b>Data Threshold</b>	Set the data threshold for D+ signal and D- signal.  Only available when <b>Signal Type = Single Ended</b> .
<b>High Threshold</b>	Set the high threshold for D+ signal and D- signal.
<b>Low Threshold</b>	Set the low threshold for D+ signal and D- signal.
<b>D+ Input</b>	Select the channel source and set the threshold level for the Data+ signal.
<b>D- Input</b>	Select the channel source and set the threshold level for the Data- signal.
<b>Display Format</b>	Sets the waveform view to show the decoded bus information or the decoded bus plus the source signal waveforms.
<b>Decode Format</b>	Sets the decode format used to display the bus information. Formats are <b>Hex</b> , <b>Binary</b> , <b>Mixed ASCII</b> , and <b>Mixed Hex</b> .

### Other bus types

Other serial bus types are available as purchasable options. Once purchased and installed, the new bus types are shown in the Bus Type menu. The serial bus options also add corresponding bus trigger capabilities (when supported) to the **Trigger** menu. See the [Bus configuration menu](#) on page 296 for links to all serial bus configuration menus.

## See also

[Bus Trigger configuration](#) on page 561

[Bus Search configuration menus](#) on page 347

[eUSB serial bus search configuration menu](#) on page 376

## FlexRay serial bus configuration menu

Use the Flexray bus menu to set up and display a Flexray automotive network serial bus waveform.

To set up the FlexRay serial bus:

- To create a new FlexRay bus waveform, tap the **Add New Bus** button on the Settings bar. Open the bus configuration menu by double clicking on the badge. Set the **Bus Type** to **FlexRay**.
- To change the settings on an existing FlexRay serial bus waveform, double-tap the **Bus** waveform badge and make necessary changes.

## FlexRay serial bus menu fields and controls

Field or control	Description
<b>Display</b>	Turns on or off displaying the bus on the Waveform view.
<b>Label</b>	Enter a label for the bus. The default label is the selected bus type. To enter label text, double-tap the field and enter label using the virtual keyboard, or tap the field and enter text using an attached keyboard.
<b>Position</b>	Sets the vertical position of the bus waveform. The default position is vertically centered in a slice (in Stacked mode), or center screen in Overlay mode. The unit of position is screen divisions.
<b>Set to 0</b>	Sets the vertical position to 0 divisions (centered vertically in a slice or on the screen).
<b>Bus Type</b>	Set to <b>FlexRay</b> .
<b>Signal Type</b>	Select the FlexRay signal type being measured.
<b>Channel Type</b>	Set to A or B channel.
<b>Source</b>	Select the FlexRay signal source.
<b>Threshold</b>	Sets the threshold value for the TX or RX signal type.
<b>High Threshold, Low Threshold</b>	Sets the high and low threshold values for the BM Inverted and Bdiff/BP signal types.
<b>Bit Rate</b>	Select a bit rate. To set a custom bit rate, select Custom and enter a value in the Custom Rate field.
<b>Display Format</b>	Sets the waveform view to show just the decoded bus information, or the decoded bus plus the source signal waveforms.
<b>Decode Format</b>	Sets the decode format used to display the bus information. Formats are Hex and Binary.

## Other bus types

Other serial bus types are available as purchasable options. Once purchased and installed, the new bus types are shown in the Bus Type menu. The serial bus options also add corresponding bus trigger capabilities (when supported) to the **Trigger** menu. See the [Bus configuration menu](#) on page 296 for links to all serial bus configuration menus.

## See also

[Bus Trigger configuration](#) on page 561

[Bus Search configuration menus](#) on page 347

[FlexRay serial bus search configuration menu](#) on page 379

## I2C serial bus configuration menu

Use the I2C bus menu to set up and display an I<sup>2</sup>C (Inter-Integrated Circuit) serial bus waveform.

To set up the I<sup>2</sup>C serial bus menu:

- To create a new I<sup>2</sup>C bus waveform, tap the **Add New Bus** button on the Settings bar. Open the bus configuration menu by double clicking on the badge. Set the **Bus Type** to **I2C**.
- To change the settings on an existing I<sup>2</sup>C serial bus waveform, double-tap the I<sup>2</sup>C **Bus** waveform badge and make necessary changes in the configuration menu.

## I2C serial bus menu fields and controls

Field or control	Description
<b>Display</b>	Turns <b>On</b> or <b>Off</b> displaying the bus on the Waveform view.
<b>Label</b>	Enter a label for the bus. The default label is the selected bus type.  To enter label text, double-tap the field and enter label using the virtual keyboard, or tap the field and enter text from an attached keyboard.
<b>Position</b>	Sets the vertical position of the bus waveform. The default position is vertically centered in a slice (in Stacked mode), or center screen in Overlay mode. The unit of position is screen divisions.
<b>Set to 0</b>	Sets the vertical position to 0 divisions (centered vertically in a slice or on the screen).
<b>Bus Type</b>	Set to <b>I2C</b> .
<b>SCLK Input</b>	Sets the source and threshold level for the Serial Clock Line signal.
<b>SDA Input</b>	Sets the source and threshold level for the Serial Data signal.
<b>Include R/W bit in Address</b>	Select <b>Yes</b> to display 7-bit addresses as eight bits, where the eighth bit (LSB) is the R/W bit, or display 10-bit addresses as 11 bits, where the third bit is the R/W bit.  Select <b>No</b> to display 7-bit addresses as seven bits, and 10-bit addresses as ten bits.
<b>Display Format</b>	Sets the waveform view to show just the decoded bus information, or the decoded bus plus the source signal waveforms.
<b>Decode Format</b>	Sets the decode format used to display the bus information. Formats are Hex and Binary.

## Other bus types

Other serial bus types are available as purchasable options. Once purchased and installed, the new bus types are shown in the Bus Type menu. The serial bus options also add corresponding bus trigger capabilities (when supported) to the **Trigger** menu. See the [Bus configuration menu](#) on page 296 for links to all serial bus configuration menus.

## See also

[Bus Trigger configuration](#) on page 561

[Bus Search configuration menus](#) on page 347

[I2C serial bus search configuration menu](#) on page 381

## I3C serial bus configuration menu

Use the I3C bus menu to set up and display a decoded I<sup>3</sup>C serial bus waveform.

To set up the I<sup>3</sup>C serial bus menu:

- To create a new I<sup>3</sup>C bus waveform, tap the **Add New Bus** button on the Settings bar. Open the bus configuration menu by double clicking on the badge. Set the **Bus Type** to **I3C**.
- To change the settings on an existing I<sup>3</sup>C serial bus waveform, double-tap the I<sup>3</sup>C **Bus** waveform badge and make necessary changes in the configuration menu.

### I3C serial bus menu fields and controls

Field or control	Description
<b>Display</b>	Turns <b>On</b> or <b>Off</b> displaying the bus on the Waveform view.
<b>Label</b>	Creates a label for the bus. The default label is the selected bus type. To enter label text, double-tap the field and enter label using the virtual keyboard, or tap the field and enter text from an attached keyboard.
<b>Position</b>	Sets the vertical position of the bus waveform. The default position is vertically centered in a slice (in <b>Stacked</b> mode), or center screen in <b>Overlay</b> mode. The unit of position is screen divisions.
<b>Set to 0</b>	Sets the vertical position to 0 divisions (centered vertically in a slice or on the screen).
<b>Bus Type</b>	Set to <b>I3C</b> .
<b>Version</b>	Sets the version as <b>1.0</b> or <b>1.1</b> for I3C bus.
<b>SCLK Input</b>	Sets the source and threshold level for the Serial Clock Line signal.
<b>SDA Input</b>	Sets the source and threshold level for the Serial Data signal.
<b>Display Format</b>	Sets the waveform view to show just the decoded bus information, or the decoded bus plus the source signal waveforms.
<b>Decode Format</b>	Sets the decode format used to display the bus information. Formats are <b>Hex</b> , <b>Binary</b> , and <b>Mixed Hex</b> .

### Other bus types

Other serial bus types are available as purchasable options. Once purchased and installed, the new bus types are shown in the Bus Type menu. The serial bus options also add corresponding bus trigger capabilities (when supported) to the **Trigger** menu. See the [Bus configuration menu](#) on page 296 for links to all serial bus configuration menus.

### See also

[Bus Trigger configuration](#) on page 561

[Bus Search configuration menus](#) on page 347

[I3C serial bus Search configuration menu](#) on page 382

## LIN serial bus configuration menu

Use this menu to set up and display a LIN (Local Interconnect Network) serial bus waveform.

To set up the LIN serial bus:

- To create a new LIN bus waveform, tap the **Add New Bus** button on the Settings bar. Open the bus configuration menu by double clicking on the badge. Set the **Bus Type** to **LIN**.
- To change the settings on an existing LIN serial bus waveform, double-tap the LIN **Bus** waveform badge and make necessary changes.

### LIN serial bus menu fields and controls

Field or control	Description
<b>Display</b>	Turns <b>On</b> or <b>Off</b> displaying the bus on the Waveform view.
<b>Label</b>	Enter a label for the bus. The default label is the selected bus type.  To enter label text, double-tap the field and enter label using the virtual keyboard, or tap the field and enter text from an attached keyboard.
<b>Position</b>	Sets the vertical position of the bus waveform. The default position is vertically centered in a slice (in Stacked mode), or center screen in Overlay mode. The unit of position is screen divisions.
<b>Set to 0</b>	Sets the vertical position to 0 divisions (centered vertically in a slice or on the screen).
<b>Bus Type</b>	Set to <b>LIN</b> .
<b>Source</b>	Set the signal source from available analog or digital channels.
<b>Threshold</b>	Set the threshold level to define a logic high level.
<b>Polarity</b>	Select the polarity to match the LIN bus being acquired.
<b>LIN Standard</b>	Select the standard to match the LIN bus being acquired.
<b>Bit rate</b>	Sets the bit rate.  To enter a custom bit rate, tap Custom and enter the custom bit rate in the Custom Rate input box.
<b>Include Parity Bits with ID</b>	Set to Yes to include parity bits with the ID.
<b>Sample Point</b>	Sets the sample point from 5% to 95% of the position within the bit period or the unit interval.
<b>Display Format</b>	Sets the waveform view to show just the decoded bus information, or the decoded bus plus the source signal waveforms.
<b>Decode Format</b>	Sets the decode format used to display the bus information. Formats are Hex, Binary, and Mixed.

### Other bus types

Other serial bus types are available as purchasable options. Once purchased and installed, the new bus types are shown in the Bus Type menu. The serial bus options also add corresponding bus trigger capabilities (when supported) to the **Trigger** menu. See the [Bus configuration menu](#) on page 296 for links to all serial bus configuration menus.

### See also

[Bus Trigger configuration](#) on page 561

[Bus Search configuration menus](#) on page 347

[LIN serial bus search configuration menu](#) on page 391



## Manchester serial bus configuration menu

Use the Manchester bus menu to set up and display a manchester waveform.

To set up a Manchester serial bus:

- To create a new Manchester bus waveform, tap the **Add New Bus** button on the Settings bar. Open the bus configuration menu by double clicking on the badge. Set the **Bus Type** to **Manchester**.
- To change the settings on an existing Manchester serial bus, double-tap the **Bus** waveform badge on the Settings bar to open the configuration menu, and make necessary changes.

### Manchester serial bus menu fields and controls

Field or control	Description
<b>Display</b>	Turns on or off displaying the bus on the Waveform view.
<b>Label</b>	Enter a label for the bus. The default label is the selected bus type.  To enter label text, double-tap the field and enter label using the virtual keyboard, or tap the field and enter text from an attached keyboard.
<b>Position</b>	Sets the vertical position of the bus decode. The default position is vertically centered in a slice (in Stacked mode), or center screen in Overlay mode. The unit of position is screen divisions.
<b>Set to 0</b>	Sets the vertical position to 0 divisions (centered vertically in a slice or on the screen).
<b>Bus Type</b>	Set to <b>Manchester</b> .
<b>Set the edge for bit '0'</b>	Set the edge for bit 0.
<b>Data Rate</b>	Set the data rate for the manchester bus. Default data rate is 125 kb/s.
<b>Source</b>	Select the signal source.
<b>Threshold</b>	Set the threshold level.
<b>Start Index</b>	Select the start index. Default is one edge. Unit is edge.
<b>Packet View</b>	Set to <b>On</b> to show packet field level decode and <b>Off</b> show bit level decode. Default is ON.
<b>Idle Bits</b>	Set the idle bits depending on the idle period of time. Default is 1.2.
<b>Tolerance</b>	Set the tolerance for giving bandwidth to edge in the bit for bit error. Default is 10 %.
<b>Sync Bits</b>	Set the number of bits that define sync pattern for the manchester bus. Default is 1 bit.  Available only when <b>Packet View</b> is <b>On</b> .
<b>Parity</b>	Set the manchester decode in the packet from the waveform being acquired. Default is None.  Available only when <b>Parity View</b> is <b>On</b> .
<b>Bit Order</b>	Set the order of bit to Most Significant Bit first (MSB) or Least Significant Bit first (LSB). Default is MSB.  Available only when <b>Packet View</b> is <b>On</b> .
<b>Word Count</b>	Set the number of words to be decoded in a packet. Default is 1.  Available only when <b>Packet View</b> is <b>On</b> .
<b>Word Size</b>	Set the number of bits in each payload. Default is 8 bits.  Available only when <b>Packet View</b> is <b>On</b> .
<b>Display Format</b>	Sets the waveform view to show the decoded bus information. Format is <b>Bus</b> .

Table continued...

Field or control	Description
Header	Set the number of bits in the header of a packet. Default is 0 bits. Available only when <b>Packet View</b> is <b>On</b> .
Trailer	Set the number of bits in the trailer of a packet. Default is 0 bits. Available only when <b>Packet View</b> is <b>On</b> .
Decode Format	Sets the decode format used to display the bus information. Formats are <b>Hex</b> and <b>Binary</b> .

### Other bus types

Other serial bus types are available as purchasable options. Once purchased and installed, the new bus types are shown in the Bus Type menu. The serial bus options also add corresponding bus trigger capabilities (when supported) to the **Trigger** menu. See the [Bus configuration menu](#) on page 296 for links to all serial bus configuration menus.

### See also

[Bus Trigger configuration](#) on page 561

[Bus Search configuration menus](#) on page 347

[Manchester serial bus search configuration menu](#) on page 392

## MDIO serial bus configuration menu

Use the MDIO bus menu to set up and display an MDIO (Management Data Input Output) serial bus waveform.

To set up the MDIO serial bus:

- To create a new MDIO bus waveform, tap the **Add New Bus** button on the Settings bar. Open the bus configuration menu by double clicking on the badge. Set the **Bus Type** to **MDIO**.
- To change the settings on an existing MDIO serial bus waveform, double-tap the MDIO **Bus** waveform badge and make necessary changes.

### MDIO serial bus menu fields and controls

Field or control	Description
Display	Turns on or off displaying the bus on the Waveform view.
Label	Enter a label for the bus. The default label is the selected bus type. To enter label text, double-tap the field and enter label using the virtual keyboard, or tap the field and enter text from an attached keyboard.
Position	Sets the vertical position of the bus waveform. The default position is vertically centered in a slice (in Stacked mode), or center screen in Overlay mode. The unit of position is screen divisions.
Set to 0	Sets the vertical position to 0 divisions (centered vertically in a slice or on the screen).
Bus Type	Set the <b>MDIO</b> to set up and display a MDIO bus waveform.
Clock Input	Set the source and threshold level for the clock input signal.
Data Input	Set the source and threshold level for the data input signal.
Threshold	Set the threshold level to define a logic high level. Sets the threshold value for the signal source.

Table continued...

Field or control	Description
Display Format	Sets the waveform view to show the decoded bus information, or the decoded bus and the source signal waveforms.
Decode Format	Sets the decode format used to display the bus information. Formats are <b>Hex</b> , <b>Binary</b> , and <b>Mixed Hex</b> .

## Other bus types

Other serial bus types are available as purchasable options. Once purchased and installed, the new bus types are shown in the Bus Type menu. The serial bus options also add corresponding bus trigger capabilities (when supported) to the **Trigger** menu. See the [Bus configuration menu](#) on page 296 for links to all serial bus configuration menus.

## See also

[Bus Trigger configuration](#) on page 561

[Bus Search configuration menus](#) on page 347

[MDIO serial bus search configuration menu](#) on page 394

## MIL-STD-1553 serial bus menu

Use the MIL-STD-1553 bus menu to set up and decode a MIL-STD-1553 aeronautic network serial data bus waveform.

To set up the MIL-STD-1553 serial data bus:

- To create a new MIL-STD-1553 bus waveform, tap the **Add New Bus** button on the Settings bar. Open the bus configuration menu by double clicking on the badge. Set the **Bus Type** to **MIL-STD-1553**.
- To change the settings on an existing FlexRay serial bus waveform, double-tap the **Bus** waveform badge and make necessary changes.

## MIL-STD-1553 serial bus menu fields and controls

Field or control	Description
Display	Turns on or off displaying the bus on the Waveform view.
Label	Enter a label for the bus. The default label is the selected bus type.  To enter label text, double-tap the field and enter label using the virtual keyboard, or tap the field and enter text using an attached keyboard.
Position	Sets the vertical position of the bus waveform. The default position is vertically centered in a slice (in Stacked mode), or center screen in Overlay mode. The unit of position is screen divisions.
Set to 0	Sets the vertical position to 0 divisions (centered vertically in a slice or on the screen).
Bus Type	Set to <b>MIL-STD-1553</b> .
Polarity	Select the polarity to match the MIL-STD-1553 bus being acquired.
Source	Select the MIL-STD-1553 signal source.
High Threshold, Low Threshold	Sets the valid high and low threshold values for the signal source.
RT Maximum	Sets the maximum valid response time (RT) for a command.
RT Minimum	Sets the minimum valid response time (RT) for a command.
Display Format	Sets the waveform view to show just the decoded bus information, or the decoded bus plus the source signal waveforms.

Table continued...

Field or control	Description
Decode Format	Sets the decode format used to display the bus information. Formats are Hex, Binary, Mixed ASCII, and Mixed Hex.

### Other bus types

Other serial bus types are available as purchasable options. Once purchased and installed, the new bus types are shown in the Bus Type menu. The serial bus options also add corresponding bus trigger capabilities (when supported) to the **Trigger** menu. See the [Bus configuration menu](#) on page 296 for links to all serial bus configuration menus.

### See also

[Bus Trigger configuration](#) on page 561

[Bus Search configuration menus](#) on page 347

[MIL-STD-1553 serial bus search configuration menu](#) on page 396

## NFC serial bus configuration menu

Use the NFC bus menu to setup and decode a NFC serial bus waveform.

Follow the procedure to setup the NFC serial bus.

1. Enable the Spectrum View from Channel configuration menu. See [Analog Channel configuration menu](#) on page 439
2. Configure the Spectrum badge menu. See [Spectrum badge menu](#) on page 554



**Note:** The center frequency should be 13.56 MHz.

3. Configure the NFC bus menu.
  - To create a new NFC waveform, tap the **Add New Bus** button on the Settings bar. Open the bus configuration menu by double clicking on the badge. Set the **Bus Type** to **NFC**.
  - To change the settings on an existing NFC serial bus waveform, double-tap the NFC **Bus** waveform badge and make necessary changes in the configuration menu.

### NFC serial bus menu fields and controls

Field or control	Description
Display	Enables or disables displaying the bus on the Waveform view.
Label	Enter a label for the bus. The default label is the selected bus type.  To enter label text, double-tap the field and enter a label using the virtual keyboard, or tap the field and enter text from an attached keyboard.
Position	Sets the vertical position of the bus waveform. The default position is vertically centered in a slice (Stacked mode), or center screen (Overlay mode). The unit of position is screen divisions.
Set to 0	Sets the vertical position to 0 divisions (centered vertically in a slice or on the screen).
Bus Type	Set to <b>NFC</b> .
Standard	Sets the NFC standard to decode. The default is 15693. The available decode standards are 15693, 14443A, 14443B, and FeliCa.

Table continued...

Field or control	Description
<b>Data Rate</b>	Set the data rate for the NFC bus. You can configure the data rate from 1 bps to 1000 Mbps. The default rate is 106 kbps for 15693, 14443A, and 14443B. For FeliCa, the default data rate is 212 kbps.
<b>Source</b>	Set the source and threshold level for the NFC input signal.
<b>Command Threshold</b>	Set the command threshold value, refer math waveform with the label CMD for setting the threshold. The command threshold range is -8 V to 8 V.
<b>Response Threshold</b>	Set the response threshold value, refer math waveform with the label RSP for setting the threshold. The response threshold range is -8 V to 8 V.
<b>Transition For '0'</b>	Select the transition for 0 depending on manchester type (IEEE or GE). Available when <b>Standard</b> is <b>15693</b> , <b>14443A</b> , or <b>FeliCa</b> .
<b>Tolerance</b>	Set the tolerance value. The valid tolerance range is from 1% to 50%. The default tolerance is 10%. Available when <b>Standard</b> is <b>15693</b> , <b>14443A</b> , and <b>FeliCa</b> .
<b>Decode Start Edge</b>	Set the decode start edge for the signal. Available when <b>Standard</b> is <b>14443A</b> or <b>FeliCa</b> .
<b>Polarity</b>	Set the polarity as <b>Normal</b> or <b>Inverted</b> . Available when <b>Standard</b> is <b>14443B</b> .
<b>Response Load Demod</b>	Tap <b>Yes</b> or <b>No</b> to apply the demodulation. Available when <b>Standard</b> is <b>14443A</b> or <b>14443B</b> .
<b>Display Format</b>	Set the waveform view to show the decoded bus information.
<b>Decode Format</b>	Set the decode format used to display the bus information. Available formats are Hex, Binary, or Mixed hex.

## Other bus types

Other serial bus types are available as purchasable options. Once purchased and installed, the new bus types are shown in the Bus Type menu. The serial bus options also add corresponding bus trigger capabilities (when supported) to the **Trigger** menu. See the [Bus configuration menu](#) on page 296 for links to all serial bus configuration menus.

## See also

[Bus Trigger configuration](#) on page 561

[Bus Search configuration menus](#) on page 347

[NFC serial bus search configuration menu](#) on page 398

## NRZ serial bus configuration menu

Use the NRZ bus menu to set up and display an NRZ serial bus waveform.

To set up a NRZ serial bus:

- To add a new NRZ bus waveform, tap the **Add New Bus** button on the Settings bar. Open the bus configuration menu by double-tapping the badge. Set the **Bus Type** to **NRZ**.
- To change the settings on an existing NRZ serial bus waveform, double-tap the **NRZ** waveform badge on the Settings bar to open the configuration menu, and make necessary changes.

You can [configure search for NRZ](#) and define conditions to search for and mark on an NRZ bus waveform.

## NRZ serial bus menu fields and controls

Field or control	Description
<b>Display</b>	Turns on or off displaying the bus on the Waveform view.
<b>Label</b>	Enter a label for the bus. The default label is the selected bus type.  To enter label text, double-tap the field and enter label using the virtual keyboard, or tap the field and enter text from an attached keyboard.
<b>Position</b>	Sets the vertical position of the bus waveform. The default position is vertically centered in a slice (in Stacked mode), or center screen in Overlay mode. The unit of position is screen divisions.
<b>Set to 0</b>	Sets the vertical position to 0 divisions (centered vertically in a slice or on the screen).
<b>Bus Type</b>	Set to <b>NRZ</b> .
<b>Bit Order</b>	Set the waveform to decode with most-significant (MS) bit first or least-significant (LS) bit first.
<b>Source</b>	Select the signal source from listed analog and digital channels.
<b>Threshold</b>	Sets the threshold value for the signal source.
<b>Polarity</b>	Select the polarity to match the NRZ bus being acquired.
<b>Bit Rate</b>	Set the bit rate. You can configure values from 1 bps to 1 Gbps.
<b>Display Format</b>	Sets the waveform view to show just the decoded bus information, or the decoded bus plus the source signal waveforms.
<b>Decode Format</b>	Sets the decode format used to display the bus information. Formats are Hex and Binary.

## Other bus types

Other serial bus types are available as purchasable options. Once purchased and installed, the new bus types are shown in the Bus Type menu. The serial bus options also add corresponding bus trigger capabilities (when supported) to the **Trigger** menu. See the [Bus configuration menu](#) on page 296 for links to all serial bus configuration menus.

## See also

[Bus Trigger configuration](#) on page 561

[Bus Search configuration menus](#) on page 347

[NRZ serial bus search configuration menu](#) on page 399

## Parallel Bus configuration menu

Use this menu to set up and display a parallel bus waveform. Parallel bus decoding and triggering is included with the oscilloscope.

To set up the parallel bus:

- To create a new parallel bus, tap the **Add New Bus** button on the Settings bar. Open the bus configuration menu by double clicking on the badge. Set the **Bus Type** to **Parallel**.
- To change the settings on an existing parallel bus waveform, double-tap the **Bus** waveform badge to open the configuration menu, and make necessary changes.

## Parallel bus configuration menu fields and controls

Field or control	Description
<b>Display</b>	Turns <b>On</b> or <b>Off</b> displaying the bus on the Waveform view.
<b>Label</b>	Enter a label for the bus. The default label is the selected bus type.  To enter label text, double-tap the field and enter label using the virtual keyboard, or tap the field and enter text from an attached keyboard.
<b>Position</b>	Sets the vertical position of the bus waveform. The default position is vertically centered in a slice (in Stacked mode), or center screen in Overlay mode. The unit of position is screen divisions.
<b>Set to 0</b>	Sets the vertical position to 0 divisions (centered vertically in a slice or on the screen).
<b>Bus Type</b>	Set to <b>Parallel</b> to define a parallel bus.
<b>Clocked Data</b>	Toggles <b>Yes</b> or <b>No</b> to use a clock signal to recover the data bits from the bus inputs.
<b>Clock Source</b>	Sets the source for the bus clock signal. The source can be an analog or digital channel.  Available when <b>Clocked Data</b> is set to <b>Yes</b> .
<b>Polarity</b>	Sets the clock signal edge to use for timing reference.  Available when <b>Clocked Data</b> is set to <b>Yes</b> .
<b>Threshold</b>	Sets the threshold value to determine high logic value.  Available when <b>Clocked Data</b> is set to <b>Yes</b> .
<b>Define Inputs</b>	Opens a Parallel Bus - Define Inputs configuration menu to set the signal sources and the bit order (MSB to LSB) for the bus. See <a href="#">Parallel Bus - Define Inputs menu</a> on page 323.
<b>Display Format</b>	Sets the waveform view to show just the decoded bus information, or the decoded bus plus the source signal waveforms.
<b>Decode Format</b>	Sets the decode format used to display the bus information. Formats are Hex and Binary.

## Other bus types

Other serial bus types are available as purchasable options. Once purchased and installed, the new bus types are shown in the Bus Type menu. The serial bus options also add corresponding bus trigger capabilities (when supported) to the **Trigger** menu. See the [Bus configuration menu](#) on page 296 for links to all serial bus configuration menus.

## See also

[Bus Trigger configuration](#) on page 561

[Bus Search configuration menus](#) on page 347

[Parallel bus search configuration menu](#) on page 400

## Parallel Bus - Define Inputs menu

Use this menu to select the signal sources and order for the parallel bus waveform

To access the Parallel Bus - Define Inputs menu, double-tap a Parallel Bus badge to open the configuration menu, and tap the **Define Inputs** button.

## Parallel Bus - Define Inputs menu fields and controls

Field or control	Description
<b>Parallel bus definition list</b>	<p>Lists the signal source and thresholds of selected channels or waveforms. The MSB is at the top of the list.</p> <p>To add a signal to the Parallel bus definition list, tap a source button in the Sources list. The button moves from the Sources list to the bottom of the bus list.</p> <p>Use the arrow buttons to the right of the field to move a selected signal up or down in the list.</p> <p>To remove a signal from the Parallel bus (and return it to the Sources list), tap on the signal source button.</p> <p>To change the threshold value for individual channels, tap in a selected Threshold field and use the assigned multipurpose knob, or double-tap the field to open the keypad and enter values.</p>
<b>Sources</b>	<p>Lists all available sources to use for a parallel bus. To add a source to the Parallel bus definition list, tap a source button. The button moves from the Sources list to the bottom of the bus list.</p>
<b>Set All Thresholds</b>	<p>Sets all thresholds in the Parallel bus definition list to the specified value. Enter a value and tap <b>Apply</b> to set the values.</p>

## Other bus types

Serial bus decode and analysis features are available as purchasable options. Once purchased and installed, the new bus types are shown in the Bus Type menu. The serial bus options also add corresponding bus trigger capabilities (when supported) to the **Trigger** menu. See the [Bus configuration menu](#) on page 296 for links to all serial bus configuration menus.

## See also

[Bus Trigger configuration](#) on page 561

[Bus Search configuration menus](#) on page 347

[Parallel bus search configuration menu](#) on page 400

## PSI5 serial bus configuration menu

Use the PSI5 bus menu to set up and display an PSI5 (Peripheral Sensor Interface) serial bus waveform.

To set up the PSI5 serial bus:

- To create a new PSI5 bus waveform, tap the **Add New Bus** button on the Settings bar. Open the bus configuration menu by double clicking on the badge. Set the **Bus Type** to **PSI5**.
- To change the settings on an existing PSI5 serial bus waveform, double-tap the PSI5 **Bus** waveform badge and make necessary changes.

## PSI5 serial bus menu fields and controls

Field or control	Description
<b>Display</b>	<p>Turns on or off displaying the bus on the Waveform view.</p>
<b>Label</b>	<p>Enter a label for the bus. The default label is the selected bus type.</p> <p>To enter label text, double-tap the field and enter label using the virtual keyboard, or tap the field and enter text from an attached keyboard.</p>

Table continued...



Field or control	Description
<b>Position</b>	Sets the vertical position of the bus waveform. The default position is vertically centered in a slice (in Stacked mode), or center screen in Overlay mode. The unit of position is screen divisions.
<b>Set to 0</b>	Sets the vertical position to 0 divisions (centered vertically in a slice or on the screen).
<b>Bus Type</b>	Set to <b>PSI5</b> to set up and display a PSI5 bus waveform.
<b>Direction</b>	Select the direction.
<b>Sensor To ECU</b>	Sets the BUS to Sensor to ECU mode.
<b>ECU to Sensor</b>	Sets the BUS to ECU to Sensor mode.
<b>Source</b>	Set the signal source from available analog or digital channels.
<b>Threshold</b>	Set the threshold level to define a logic high level.
<b>Mode</b>	<ul style="list-style-type: none"> <li>• Configure the speed.</li> <li>• Standard (125 kbps)</li> <li>• Fast (189 kbps)</li> <li>• Slow (83.3 kbps)</li> </ul>
<b>Data A</b>	Set the number of bits for data region A.
<b>Data B</b>	Set the number of bits for data region B.
<b>Serial Messaging</b>	Turns On/Off the Serial channel messaging
<b>Frame Control</b>	Indicates the type of frame, data content or identifies the sensor. The values are 0,1,2,3, and 4.
<b>Status</b>	Set the sensor status from 0 to 2 bits.
<b>Sync Mode</b>	<ul style="list-style-type: none"> <li>• Tooth Gap</li> <li>• Pulse Width</li> </ul> <p>Only available when <b>Direction = ECU to Sensor</b> .</p>
<b>Bit Period</b>	Only available when <b>Direction = ECU to Sensor</b> and <b>Sync Mode = Tooth Gap</b> .
<b>Data Format</b>	<ul style="list-style-type: none"> <li>• Nibble</li> <li>• Byte</li> </ul> <p>Only available when <b>Direction = ECU to Sensor</b> .</p>
<b>Display Format</b>	Sets the waveform view to show just the decoded bus information, or the decoded bus plus the source signal waveforms.
<b>Decode Format</b>	Sets the decode format used to display the bus information. Formats are <b>Hex</b> , <b>Binary</b> , and <b>Mixed Hex</b> .

## Other bus types

Other serial bus types are available as purchasable options. Once purchased and installed, the new bus types are shown in the Bus Type menu. The serial bus options also add corresponding bus trigger capabilities (when supported) to the **Trigger** menu. See the [Bus configuration menu](#) on page 296 for links to all serial bus configuration menus.

## See also

[Bus Trigger configuration](#) on page 561

[Bus Search configuration menus](#) on page 347

[PSI5 serial bus search configuration menu](#) on page 401

## RS232 serial bus menu

Use this menu to set up and display an RS232 serial bus waveform.

To set up a RS232 serial bus:

1. To create a new RS232 bus waveform, tap the **Add New Bus** button on the Settings bar. Open the bus configuration menu by double clicking on the badge. Set the **Bus Type** to **RS232**.
2. To change the settings on an existing RS232 serial bus waveform, double-tap the RS232 **Bus** waveform badge to open the configuration menu and make necessary changes.

### RS232 serial bus menu fields and controls

Field or control	Description
<b>Display</b>	Turns <b>On</b> or <b>Off</b> displaying the bus on the Waveform view.
<b>Label</b>	Enter a label for the bus. The default label is the selected bus type.  To enter label text, double-tap the field and enter label using the virtual keyboard, or tap the field and enter text from an attached keyboard.
<b>Position</b>	Sets the vertical position of the bus waveform. The default position is vertically centered in a slice (in Stacked mode), or center screen in Overlay mode. The unit of position is screen divisions.
<b>Set to 0</b>	Sets the vertical position to 0 divisions (centered vertically in a slice or on the screen).
<b>Bus Type</b>	Set to <b>RS232</b> .
<b>Data Inputs</b>	Set the data input as <b>One</b> or <b>Two</b> .
<b>Bit Order</b>	Set the bit order for the bit as <b>LSB</b> or <b>MSB</b> .
<b>Bit Rate</b>	Sets the data bit rate.  To enter a custom bit rate, select Custom and enter the custom bit rate in the <b>Custom Rate</b> input box.
<b>Data Bits</b>	Set the number of bits that define a data packet for your RS232 bus.
<b>Source</b>	Set the signal source from available analog or digital channels.
<b>Threshold</b>	Set the threshold level to define a logic high level.
<b>Polarity</b>	Select the polarity to match the RS232 bus being acquired. Use Normal polarity for RS-232 signals, and Inverted polarity for RS-422, RS-485, and UART buses.
<b>Parity</b>	Set the parity to match the RS232 bus being acquired.
<b>Packet View</b>	Set to <b>On</b> to show decoded packet level information on the bus waveform.
<b>End of packet</b>	select the appropriate end of packet value to match the RS232 bus being acquired.  Available when <b>Packet View</b> is <b>On</b> .
<b>Display Format</b>	Sets the waveform view to show just the decoded bus information, or the decoded bus plus the source signal waveforms.
<b>Decode Format</b>	Sets the decode format used to display the bus information. Formats are Hex, Binary, and ASCII.

## Other bus types

Other serial bus types are available as purchasable options. Once purchased and installed, the new bus types are shown in the Bus Type menu. The serial bus options also add corresponding bus trigger capabilities (when supported) to the **Trigger** menu. See the [Bus configuration menu](#) on page 296 for links to all serial bus configuration menus.

## See also

[Bus Trigger configuration](#) on page 561

[Bus Search configuration menus](#) on page 347

[RS-232 serial bus search configuration menu](#) on page 404

## SDLC serial bus configuration menu

Use the SDLC bus menu to set up and display a SDLC (Serial Data Link Control) serial bus waveform.

To create a new SDLC bus waveform:

1. Tap **Add New Bus** on the Settings bar.
2. Double-tap the **SDLC** badge to open the bus configuration menu.
3. Set the **Bus Type** to **SDLC**.

To change the settings on an existing CAN serial bus waveform, double-tap the **SDLC** waveform badge on the Settings bar to open the configuration menu.

## SDLC serial bus menu fields and controls

Field or control	Description
<b>Display</b>	Turns On or Off.  Displays the decode bus on the waveform view, when the <b>Display</b> is set to <b>On</b> .
<b>Label</b>	Enter a label for the bus. The default label is the selected bus type.  To enter label text, double-tap the field and enter label using the virtual keyboard, or tap the field and enter text from an attached keyboard.
<b>Position</b>	Sets the vertical position of the bus waveform. The default position is vertically centered in a slice (in Stacked mode), or center screen in Overlay mode. The unit of position is screen divisions.
<b>Set to 0</b>	Sets the vertical position to 0 divisions (centered vertically in a slice or on the screen).
<b>Bus Type</b>	Set to <b>SDLC</b> to set up and display a <b>SDLC</b> bus waveform.
<b>Modulo</b>	Turn Modulo to <b>8</b> for 8 bit control field or Modulo to <b>128</b> for 16 bit control field in SDLC transmission frame.
<b>Encoding</b>	Turns <b>Discrete Transmission</b> or <b>Invert On Zero</b> SDLC line encoding for Non Return to Zero (NRZ) and Non return to Zero Invert (NRZI) standards.
<b>Data Input</b>	Sets the source, threshold and bitrate for the data input signal.
<b>Source</b>	Select the channel source for the signal from a differential probe.
<b>Threshold</b>	Sets the threshold level to define a logic high level. Sets the threshold value for the signal source.
<b>Bit Rate</b>	Sets the data bit rate.  To enter a data bit rate, double-tap and enter the value in the input box.

Table continued...

Field or control	Description
Display Format	Sets the waveform view to show the decoded bus information.
Decode Format	Sets the decode format used to display the bus information. Formats are Hex, Binary, and mixed Hex.

## SENT serial bus configuration menu

Use the SENT bus menu to set up and display a SENT (Single Edge Nibble Transmission) serial bus waveform.

- To add a new SENT bus waveform
  1. Tap **Add New Bus** on the Settings bar.
  2. Double-tap the new bus badge to open the bus configuration menu.
  3. Set the **Bus Type** to **SENT**.
  4. Use the menu fields and controls to configure the **SENT** bus parameters.
- Double-tap the Bus waveform badge to change the settings on an existing SENT serial bus waveform.

## SENT serial bus menu fields and controls

Field or control	Description
Display	Turns <b>On</b> or <b>Off</b> displaying the bus in the Waveform view.
Label	Enter a label for the bus. The default label is the selected bus type.  To enter label text, double-tap the field and enter label using virtual keyboard, or tap the field and enter text from an attached keyboard.
Position	Sets the vertical position of the bus waveform. The default position is vertically centered in a slice (in Stacked mode), or center screen in Overlay mode. The unit of position is screen divisions.
Set to 0	Sets the vertical position to 0 divisions (centered vertically in a slice or on the screen).
Bus Type	Set to <b>SENT</b> to set up and display a SENT serial bus waveform.
Source	Select the signal source from the listed analog and digital channels.
Threshold	Sets the high/low logic transition level.
Polarity	Sets the signal edge to use to determine the width of the clock tick pulse.  <b>Normal</b> (default) corresponds to a falling edge polarity that determines how many ticks wide a pulse is. <b>Inverted</b> corresponds to a rising edge polarity.
Clock Tick	Sets the time period of the clock tick. The valid range is from 1 $\mu$ s to 300 $\mu$ s. The default is 3 $\mu$ s.
Tick Tolerance	Sets the tolerance, as a percent, that is acceptable for the clock tick signal to be recognized. The valid tolerance range is from 1% to 30%. The default tolerance is 20%.
Fast Data Channels	Sets the number of fast data channels. The default is <b>2</b> .
Data Nibbles	Sets the number of data nibbles to detect in the serial signal ( <b>3, 4, or 6</b> ).  Available when <b>Fast Data Channels</b> is <b>1</b> .
Channel Widths (C1/C2)	Sets the number of bits per channel when using two fast data channels ( <b>12/12, 14/10, or 16/8</b> ).  Available when <b>Fast Data Channels</b> is <b>2</b> .
Pause Pulse	Sets the instrument to detect a Pause pulse in the serial data. The default value is <b>Yes</b> .

Table continued...

Field or control	Description
<b>Slow Channel</b>	Sets the slow channel characteristics. Tap and select from the available list of slow channel types. The default value is <b>None</b> .
<b>Display Format</b>	<p>Sets the display format for waveforms as <b>Bus</b> or <b>Bus and Waveform</b>.</p> <p><b>Bus</b> sets the waveform view to display just the decoded bus information.</p> <p><b>Bus and Waveform</b> sets the waveform view to display both the decoded bus and the source signal waveforms.</p> <p>You can also tap on the + symbol on the bus waveform to toggle between showing the bus only or showing bus and source waveforms.</p>
<b>Decode Format</b>	Sets the decode format used to display the bus information. Formats are <b>Hex</b> , <b>Binary</b> , <b>Mixed Decimal</b> , and <b>Mixed Hex</b> .

## Other bus types

Other serial bus types are available as purchasable options. Once purchased and installed, the new bus types are shown in the Bus Type menu. The serial bus options also add corresponding bus trigger capabilities (when supported) to the **Trigger** menu. See the [Bus configuration menu](#) on page 296 for links to all serial bus configuration menus.

## See also

[Bus Trigger configuration](#) on page 561

[Bus Search configuration menus](#) on page 347

[SENT serial bus search configuration menu](#) on page 408

## SMBus serial bus configuration menu

Use the SMBus menu to set up and display a SMBus serial bus waveform.

To set up the SMBus serial bus menu:

- To create a new SMBus waveform, tap the **Add New Bus** button on the Settings bar. Open the bus configuration menu by double clicking on the badge. Set the **Bus Type** to **SMBus**.
- To change the settings on an existing SMBus serial bus waveform, double-tap the SMBus **Bus** waveform badge and make necessary changes in the configuration menu.

## SMBus serial bus menu fields and controls

Field or control	Description
<b>Display</b>	Enables or disables displaying the bus on the Waveform view.
<b>Label</b>	<p>Enter a label for the bus. The default label is the selected bus type.</p> <p>To enter label text, double-tap the field and enter label using the virtual keyboard, or tap the field and enter text from an attached keyboard.</p>
<b>Position</b>	Sets the vertical position of the bus waveform. The default position is vertically centered in a slice (Stacked mode), or center screen (Overlay mode). The unit of position is screen divisions.
<b>Set to 0</b>	Sets the vertical position to 0 divisions (centered vertically in a slice or on the screen).
<b>Bus Type</b>	Set to <b>SMBus</b> .

Table continued...

Field or control	Description
PEC Byte	Set PEC Byte. By default PEC Byte is false.
SMBCLK Input	Set the source and threshold level for the SMBus input clock signal.
SMBDAT Input	Set the source and threshold level for the SMBus input data signal.
Display Format	Set the waveform view to show just the decoded bus information, or the decoded bus plus the source signal waveforms.
Decode Format	Set the decode format used to display the bus information. Available formats are Hex, Mixed Hex, and Binary.

### Other bus types

Other serial bus types are available as purchasable options. Once purchased and installed, the new bus types are shown in the Bus Type menu. The serial bus options also add corresponding bus trigger capabilities (when supported) to the **Trigger** menu. See the [Bus configuration menu](#) on page 296 for links to all serial bus configuration menus.

### See also

[Bus Trigger configuration](#) on page 561

[Bus Search configuration menus](#) on page 347

[SMBus serial bus search configuration menu](#) on page 410

## SpaceWire serial bus configuration menu

Use the SpaceWire bus menu to set up and display an SpaceWire serial bus waveform.

To set up a SpaceWire serial bus:

1. To add a new SpaceWire bus waveform, tap the **Add New Bus** button on the Settings bar. Open the bus configuration menu by double-tapping the badge. Set the **Bus Type** to **SpaceWire**.
2. To change the settings on an existing SpaceWire serial bus waveform, double-tap the **SpaceWire** waveform badge on the Settings bar to open the configuration menu, and make necessary changes.

You can [configure search for SpaceWire](#) and define conditions to search for and mark on an SpaceWire bus waveform.

### SpaceWire serial bus menu fields and controls

Field or control	Description
Display	Turns on or off displaying the bus on the Waveform view.
Label	Enter a label for the bus. The default label is the selected bus type.  To enter label text, double-tap the field and enter label using the virtual keyboard, or tap the field and enter text from an attached keyboard.
Position	Sets the vertical position of the bus waveform. The default position is vertically centered in a slice (in Stacked mode), or center screen in Overlay mode. The unit of position is screen divisions.
Set to 0	Sets the vertical position to 0 divisions (centered vertically in a slice or on the screen).
Bus Type	Set to Bus type to <b>SpaceWire</b> .
Strobe Input	Sets the source and threshold level for the signal.

Table continued...

Field or control	Description
Data Input	Sets the source and threshold level for the signal.
Sync	Sets the synchronization. Available options are Data, Auto, NULL, and Custom.
Data	Set the data. Available when <b>Sync = Data</b> . Use <a href="#">Configure pattern editor</a> on page 418 to customize the data.
Count	Displays the count. Available when <b>Sync = NULL</b> .
Custom	Set the custom value. Available when <b>Sync = Custom</b> . Use <a href="#">Configure pattern editor</a> on page 418 to customize the custom value.
Display Format	Sets the waveform view to show just the decoded bus information, or the decoded bus plus the source signal waveforms.
Decode Format	Sets the decode format used to display the bus information. Formats are Hex and Binary.

## Other bus types

Other serial bus types are available as purchasable options. Once purchased and installed, the new bus types are shown in the Bus Type menu. The serial bus options also add corresponding bus trigger capabilities (when supported) to the **Trigger** menu. See the [Bus configuration menu](#) on page 296 for links to all serial bus configuration menus.

## See also

[Bus Trigger configuration](#) on page 561

[Bus Search configuration menus](#) on page 347

[SpaceWire serial bus search configuration menu](#) on page 414

## SPI serial bus configuration menu

Use the SPI bus menu to set up and display an SPI (Serial Peripheral Interface) synchronous serial bus waveform.

To set up the SPI serial bus:

1. To create a new SPI bus waveform, tap the **Add New Bus** button on the Settings bar. Open the bus configuration menu by double clicking on the badge. Set the **Bus Type** to **SPI**.
2. To change the settings on an existing SPI serial bus waveform, double-tap the **Bus** waveform badge to open the configuration menu, and make necessary changes.

## SPI serial bus menu fields and controls

Field or control	Description
Display	Turns <b>On</b> or <b>Off</b> displaying the bus on the Waveform view.

Table continued...

Field or control	Description
<b>Label</b>	Enter a label for the bus. The default label is the selected bus type.  To enter label text, double-tap the field and enter label using the virtual keyboard, or tap the field and enter text from an attached keyboard.
<b>Position</b>	Sets the vertical position of the bus waveform. The default position is vertically centered in a slice (in Stacked mode), or center screen in Overlay mode. The unit of position is screen divisions.
<b>Set to 0</b>	Sets the vertical position to 0 divisions (centered vertically in a slice or on the screen).
<b>Bus Type</b>	Set to <b>SPI</b> .
<b>Data Inputs</b>	Select the number of inputs as <b>One</b> or <b>Two</b> .  One enables to configure one data input. Two enables to configure MOSI and MISO.
<b>Framing</b>	Set to Slave Select (SS) or Idle framing modes.
<b>SCLK Input</b>	Select the channel source and threshold level for the Serial Clock signal (output from master).  Set the Polarity to rising or falling edge of the clock signal used by the master device to start transferring bits.  Available when <b>Framing</b> is <b>SS</b> and <b>Data Inputs</b> is <b>One</b> , and <b>Framing</b> is <b>Idle</b> .
<b>SS Input</b>	Select the channel source and threshold level for the Slave Select signal to start communications with the slave device.  Set the Polarity to use Active High or Active Low logic for the SS signal.  Available when <b>Framing</b> is <b>SS</b> .
<b>Data Input</b>	Select the channel source and threshold level for the data input.  Set the Polarity to use Active High or Active Low for the SS signal.  Available when <b>Data Inputs</b> is <b>One</b> .
<b>MOSI Input</b>	Select the channel source and threshold level for the MOSI (Master In Slave Input) input.  Set the Polarity to use Active High or Active Low logic for the MOSI signal.  Available when <b>Data Inputs</b> = <b>Two</b> , and <b>Framing</b> = <b>SS/Idle</b> .
<b>MISO Input</b>	Select the channel source and threshold level for the MISO (Master In Slave Output) input.  Set the Polarity to use Active High or Active Low logic for the MISO signal.  Available when <b>Framing</b> is <b>SS/Idle</b> and <b>Data Inputs</b> is <b>Two</b> .
<b>Word Size</b>	Enter the word size, in bits. Minimum is 4, maximum is 32, and default is 8.
<b>Bit Order</b>	Set to most significant bit <b>MS First</b> or least significant bit <b>LS First</b> .
<b>Idle Time (Framing = )</b>	Set the idle frame time.  Available when <b>Framing</b> is <b>Idle</b> .
<b>Display Format</b>	Sets the waveform view to show just the decoded bus information, or the decoded bus plus the source signal waveforms. This depends on data input.  Available only when <b>Data Input</b> is <b>One</b> .
<b>Decode Format</b>	Sets the decode format used to display the bus information. Formats are <b>Hex</b> and <b>Binary</b> .



## Other bus types

Other serial bus types are available as purchasable options. Once purchased and installed, the new bus types are shown in the Bus Type menu. The serial bus options also add corresponding bus trigger capabilities (when supported) to the **Trigger** menu. See the [Bus configuration menu](#) on page 296 for links to all serial bus configuration menus.

## See also

[Bus Trigger configuration](#) on page 561

[Bus Search configuration menus](#) on page 347

[SPI serial bus search configuration menu](#) on page 411

## SPMI serial bus configuration menu

Use the SPMI bus menu to set up and display an SPMI (System Power Management Interface) serial bus waveform.

To add an SPMI serial bus waveform to the display:

1. Tap **Add New Bus** on the Settings bar.
2. Set the **Bus Type** to **SPMI**.
3. Use the menu fields and controls to configure the **SPMI** bus parameters.

To change the settings on an existing SPMI serial bus waveform, double-tap the **SPMI** bus badge to open the configuration menu.

## SPMI serial bus menu fields and controls

Field or control	Description
<b>Display</b>	Turns on or off displaying the bus on the Waveform view.
<b>Label</b>	Enter a label for the bus. The default label is the selected bus type.  To enter label text, double-tap the field and enter label using the virtual keyboard, or tap the field and enter text from an attached keyboard.
<b>Position</b>	Sets the vertical position of the bus waveform. The default position is vertically centered in a slice (in Stacked mode), or center screen in Overlay mode. The unit of position is screen divisions.
<b>Set to 0</b>	Sets the vertical position to 0 divisions (centered vertically in a slice or on the screen).
<b>Bus Type</b>	Set to <b>SPMI</b> to set up and display a SPMI bus waveform.
<b>SCLK Input</b>	Sets the signal <b>Source</b> and the high/low logic transition <b>Threshold</b> level for the <b>SCLK</b> input signal.
<b>SDATA Input</b>	Sets the signal <b>Source</b> and the high/low logic transition <b>Threshold</b> level for the <b>SDATA</b> input signal.
<b>Display</b>	<b>Bus</b> sets the waveform view to show just the decoded bus information.  <b>Bus and Waveforms</b> sets the waveform view to show both the decoded bus and the source signal waveforms.  You can also tap on the + symbol on the bus waveform to toggle between showing the bus only or showing bus and source waveforms.
<b>Decode Format</b>	Sets the decode format used to display the bus information. Formats are <b>Hex</b> , <b>Binary</b> , and <b>Mixed Hex</b> .

## Other bus types

Other serial bus types are available as purchasable options. Once purchased and installed, the new bus types are shown in the Bus Type menu. The serial bus options also add corresponding bus trigger capabilities (when supported) to the **Trigger** menu. See the [Bus configuration menu](#) on page 296 for links to all serial bus configuration menus.

### See also

[Bus Trigger configuration](#) on page 561

[Bus Search configuration menus](#) on page 347

[SPMI serial bus search configuration menu](#) on page 412

## SVID serial bus configuration menu

Use the SVID bus menu to set up and display an SVID (Serial VID (clock, data, alert)) serial bus waveform.

To set up the SVID serial bus:

- To create a new SVID bus waveform, tap the **Add New Bus** button on the Settings bar. Open the bus configuration menu by double clicking on the badge. Set the **Bus Type** to **SVID**.
- To change the settings on an existing SVID serial bus waveform, double-tap the SVID **Bus** waveform badge and make necessary changes.

### SVID serial bus menu fields and controls

Field or control	Description
<b>Display</b>	Turns on or off displaying the bus on the Waveform view.
<b>Label</b>	Enter a label for the bus. The default label is the selected bus type.  To enter label text, double-tap the field and enter label using the virtual keyboard, or tap the field and enter text from an attached keyboard.
<b>Position</b>	Sets the vertical position of the bus waveform. The default position is vertically centered in a slice (in Stacked mode), or center screen in Overlay mode. The unit of position is screen divisions.
<b>Set to 0</b>	Sets the vertical position to 0 divisions (centered vertically in a slice or on the screen).
<b>Bus Type</b>	Set the <b>SVID</b> to set up and display a SVID bus waveform.
<b>Version</b>	Sets the version to <b>Non VR14</b> or <b>VR14</b> .
<b>Clock Input</b>	Set the source and threshold level for the clock input signal.
<b>Data Input</b>	Sets the source and threshold level for the data input signal.
<b>Alert Input</b>	Sets the source and threshold level for the alert input signal.
<b>Threshold</b>	Set the threshold level to define a logic high level. Sets the threshold value for the signal source.
<b>Display Format</b>	Sets the waveform view to show the decoded bus information, or the decoded bus and the source signal waveforms.
<b>Decode Format</b>	Sets the decode format used to display the bus information. Formats are <b>Hex</b> , <b>Binary</b> , and <b>Mixed Hex</b> .

## Other bus types

Other serial bus types are available as purchasable options. Once purchased and installed, the new bus types are shown in the Bus Type menu. The serial bus options also add corresponding bus trigger capabilities (when supported) to the **Trigger** menu. See the [Bus configuration menu](#) on page 296 for links to all serial bus configuration menus.

## See also

[Bus Trigger configuration](#) on page 561

[Bus Search configuration menus](#) on page 347

[SVID serial bus search configuration menu](#) on page 415

## USB serial bus configuration menu

Use the USB bus menu to set up and display an USB 2.0 (Universal Serial Bus) waveform.

To set up a USB serial bus:

1. To create a new USB bus waveform, tap the **Add New Bus** button on the Settings bar. Open the bus configuration menu by double clicking on the badge. Set the **Bus Type** to **USB**.
2. To change the settings on an existing USB serial bus waveform, double-tap the **Bus** waveform badge on the Settings bar to open the configuration menu, and make necessary changes.

## USB serial bus menu fields and controls

Field or control	Description
<b>Display</b>	Turns on or off displaying the bus on the Waveform view.
<b>Label</b>	Enter a label for the bus. The default label is the selected bus type.  To enter label text, double-tap the field and enter label using the virtual keyboard, or tap the field and enter text from an attached keyboard.
<b>Position</b>	Sets the vertical position of the bus waveform. The default position is vertically centered in a slice (in Stacked mode), or center screen in Overlay mode. The unit of position is screen divisions.
<b>Set to 0</b>	Sets the vertical position to 0 divisions (centered vertically in a slice or on the screen).
<b>Bus Type</b>	Set to <b>USB</b> .
<b>Speed</b>	Set the speed to match the USB bus you are acquiring.  Selecting High Speed (480 Mbps) sets the Signal Type to Differential.
<b>Signal type</b>	Set to match the USB signal you are acquiring (Single Ended or Differential). Use a differential probe to acquire the differential USB signal.  Selecting High Speed (480 Mbps) sets the Signal Type to Differential.  Both Single Ended and Diff can be used to measure Full (12 Mbps) and Low (1.2 Mbps) speed USB signals.
<b>Source</b>	Select the channel source for the signal from a differential probe.  Only available when Signal Type = Diff.
<b>High Threshold</b>	Set the high threshold level for the differential signal.
<b>Low Threshold</b>	Set the low threshold level for the differential signal.
<b>D+ Input</b>	Select the channel source and set the threshold level for the Data+ signal.  Only available when Signal Type = Single Ended.

Table continued...

Field or control	Description
D- Input	Select the channel source and set the threshold level for the Data- signal. Only available when Signal Type = Single Ended.
Display Format	Sets the waveform view to show just the decoded bus information, or the decoded bus plus the source signal waveforms.
Decode Format	Sets the decode format used to display the bus information. Formats are Hex and Binary.

### Other bus types

Other serial bus types are available as purchasable options. Once purchased and installed, the new bus types are shown in the Bus Type menu. The serial bus options also add corresponding bus trigger capabilities (when supported) to the **Trigger** menu. See the [Bus configuration menu](#) on page 296 for links to all serial bus configuration menus.

### See also

[Bus Trigger configuration](#) on page 561

[Bus Search configuration menus](#) on page 347

[USB serial bus search configuration menu](#) on page 416

## Add Plot configuration menu

Use this configuration menu to select and plot the amplitude and time relationship of two (XY) or three (XYZ) signals, which can be sourced from channel, math, or reference waveforms, or plot a TIE measurement eye diagram.

These plots differ from the Measurement plots (added from a Measurement configuration menu), which plot that measurement's value, not the signal source value(s).

To open the **Add Plot** configuration menu, tap the **Add New... Plot** button.

To add a plot:

1. Select a plot type.
2. Select the signal source or sources.
3. Tap **Add**. You can also double tap a plot to add it to the screen. The plot is added to the screen.

### Add Plot menu fields and controls

Field or control	Description
Sources	Sets the input sources for the plot. The number of source fields listed depends on the plot.
XY, XYZ, Eye Diagram	Select the plot type to add to the screen. <b>Eye Diagram</b> adds a TIE measurement badge to the Results bar and adds the eye diagram to the screen.
Add	Adds the selected plot to the screen. You can also double tap on a plot type to add it to the screen.

### Configuring plots

Each plot has a menu that lets you configure that plot's settings. See [Plot configuration menus](#) on page 507.

## Closing a plot view

To close (delete) a Plot view, tap the **X** in the upper right corner of the view.

Deleting the Measurement badge that enabled the plot also closes the plot.

## Add Results Table configuration menu

Use this configuration menu to add a table of all active measurements, searches, or bus decode values. Results tables show values in a spreadsheet-like format.

To open the **Add Results Table** configuration menu, tap the **Add New... Results Table** button.

To add a result table to the screen:

1. Tap **Add New... Results Table**.
2. Select a table type.
3. Tap **Add**. You can also double-tap a table type to add it to the screen.

### Add Results Table menu fields and controls

Field or control	Description
<b>Measurements</b>	Display a table of all the measurements in the Results bar.
<b>Search</b>	Display a table of all defined searches with each search shown on its own tab.
<b>Bus Decode</b>	Display a table of the bus decode results.
<b>Harmonics/Custom</b>	Displays a table of the Harmonics measurement results. Custom displays a table of the Frequency Response Analysis measurement results. Custom is available only for Inrush Current, Input Capacitance, Turn-on Time, Turn-off time, Control loop response, PSRR, and Impedance measurements.
<b>Peak Markers</b>	Displays a table of peak markers for the Spectrum View with all active spectrum sources.
<b>Add</b>	Displays the selected table type. You can add as many tables as you want to the screen.

## Results Tables operations overview

Results tables list summaries of all active measurements, bus decode activity, and search results in a spreadsheet format. Use Results tables to quickly compare values or save the results to a report.

### Results Table - general operations

- Double-tap anywhere on a results table to open its configuration menu.
- To scroll up and down in a results table, tap the table and use Multipurpose knob **A** to scroll and select table rows.
- To move a column, touch and drag the column title to a new position in the table.
- To add or remove a column from the table, double-tap the results table to open the table configuration menu and select from available columns to add or remove.
- To resize a column width, use the mouse to position the cursor on the column name border to change, then click and drag the column border to resize that column.
- To configure or delete a single measurement in a Measurement Results table, touch and hold on a table row to open a right-click menu that lets you configure or delete that measurement.
- You cannot sort the contents of a column.

## See also

[Measurement Table configuration menu](#) on page 338

[Bus Decode Results table configuration menu](#) on page 341

[Search Results table menu](#) on page 340

[Harmonics/Frequency Response Analysis \(FRA\) Results table configuration menu](#) on page 343

## Measurement Table configuration menu

Use this menu to select which statistics to show in the **Measurement Results** table, select the number of digits to show in each column, save a table, and so on.

To open the Measurement Table configuration menu, double-tap anywhere in a Measurement Results table.

### Measurement Table menu

Field or control	Description
<b>Table Settings panel</b>	
<b>Statistics</b>	<p>Sets the amount of statistical information you want to display for each measurement.</p> <p><b>Both</b> shows both the accumulated results and the current acquisition results.</p> <p><b>All Acquisitions</b> shows statistics for all acquisitions from the last action that cleared acquisition memory.</p> <p><b>Current Acquisition</b> shows the statistics for just the current acquisition.</p>
<b>Show Cycle-to-Cycle Variation</b>	<p>For measurements where this applies, this function allows you to see the mean or average variation between measurements performed on each available cycle in the waveform.</p>
<b>Show tabs with all measurement occurrences</b>	<p>The measurement results table becomes tabbed, with a tab for each measurement.</p> <p>The contents of the current measurement results table are shown on the first tab "Statistics". This tab is always shown first.</p> <p>A tab for each defined measurement is shown to the right of the statistics tab. The left-to-right order of the measurement tabs is the same as the top-to-bottom order of the measurement badges in the Results Bar.</p> <p>Power measurements, Jitter Summary and any other measurement that display more than one value in their Results badge are not shown on their own tabs in the Results Bar.</p> <p>The contents of a measurement tab are calculated when the tab is selected (so the user can see it) and when the contents of the table are saved.</p> <p>If the user rearranges the order of the measurement badges, the order of the tabs in the Results table also update.</p> <p>When a row is selected, the zoom window moves to that occurrence in the record. When the zoom window is moved, the nearest result is highlighted.</p> <p>When the table contents are saved, the content of all tabs come from the same acquisition. Each results table measurement tab content is saved to a separate file, with the measurement badge name used in the file name. If a user-provided file name is specified, that name is appended to the front of the measurement file name (Example: Data_Meas1.csv).</p>

Table continued...

Field or control	Description
<b>Save Table</b>	Opens a menu with which to save the results table data to a file. See <a href="#">Save As configuration menu (Measurement Results Table)</a> on page 339.
<b>Column Visibility panel</b>	
<b>Label</b>	Adds a Label column to show the user-defined label for all measurements. If no user-defined label exists, the column shows the default measurement name.
<b>Peak-to-Peak</b>	Adds a Peak-to-Peak column and shows a Pk-Pk readout for all relevant measurements.
Check boxes to select columns to display	Select or clear individual statistic check boxes to add or remove that column from the table.
<b>Column Resolution panel</b>	
<b>Measurement column resolution</b>	Sets the resolution (number of digits to display) in each measurement column.
<b>Set to Defaults</b>	Sets all columns to show 5 digit readout resolution.

## Measurements Results Table operations

- Double-tap anywhere on a results table to open its configuration menu.
- To configure or delete a single measurement in a Measurement Results table, touch and hold on a table row to open a right-click menu that lets you configure or delete that measurement.
- If you add or delete a measurement to the Results bar, that measurement is automatically added to or deleted from an existing Measurement Results table.
- To scroll up and down in a results table, tap the table and use Multipurpose knob **A** to scroll and select table rows.
- To move a column, touch and drag the column title to a new position in the table.
- To add or remove a column from the table, double-tap the results table to open the table configuration menu and select from available columns to add or remove.
- To resize a column width, use the mouse to position the cursor on the column name border to change, then click and drag the column border to resize that column.
- You cannot sort the contents of a column.

## Save As configuration menu (Measurement Results Table)

Use the Save As configuration menu to set the location and file name to which to save the contents of a results table, as a comma-separated value (csv) format file.

To open the Save As configuration menu to save a results table to a file:

1. Double-tap anywhere in the Measurement Results table to open the Measurement Table configuration menu.
2. Tap the **Other** panel.
3. Tap **Save Table**.

### Save As menu, Measurement Results table fields and controls

Field or control	Description
<b>Save Location</b>	<p>Sets the location to which to save the file. The default value is the last location to which a file was saved.</p> <p>Tap on the file path and use a keyboard to enter a new save location. Or double-tap on the file name to open the on-screen keyboard and enter a path.</p> <p>Tap the down arrow icon on the right end of the field to open a list of recent file save locations, for the current save type, up to a maximum of 20 locations.</p>
<b>Browse</b>	<p>Tap to open the Browse Save As Location dialog, to navigate to and select the location to which to save the file. See <a href="#">Browse Save As Location configuration menu</a> on page 477.</p>
<b>File Name</b>	<p>The file name assigned to the file. The default file name is Tek000. The file name increments on the next save (Tek001, Tek002, and so on).</p> <p>Tap on the file name and use a keyboard to enter a new file name. Or double-tap on the file name to open the on-screen keyboard and enter a file name.</p>
<b>Save as Type</b>	<p>You can save only table results as comma separated values (.csv) files.</p>

### Search Results table menu

Use this menu to configure the content of the Search results table.

To open the Search Results Table configuration menu, double-tap anywhere in the Search Results table. If there are multiple search results tables, tap the tab of the search table to configure and then double-tap anywhere in that table.

### Search Results Table menu



Field or control	Description
<b>Table Settings</b>	
<b>Location Timestamp Resolution</b>	<p>Sets the search mark timestamp resolution to display. The timestamp shows the time of each mark relative to the first acquired search mark.</p> <p><b>Short</b> shows a rounded version of the timestamp data.</p> <p> <b>Note:</b> The actual timestamp data is not truncated by the Short setting, and is retained in the acquisition data.</p> <p><b>Precise</b> displays the full timestamp value by individual time units (seconds, milliseconds, microseconds, and so on).</p>
<b>Delta resolution</b>	<p>Sets the timestamp resolution to display for mark deltas. Delta shows the time difference between each search mark.</p> <p><b>Short</b> shows the delta time between marks as a rounded version of the timestamp data.</p> <p> <b>Note:</b> The actual timestamp data is not truncated by the Short setting, and is retained in the acquisition data.</p> <p><b>Precise</b> displays the full delta timestamp value by individual time units (seconds, milliseconds, microseconds, and so on).</p>

Table continued...



Field or control	Description
<b>Save Table</b>	Opens a menu with which to save the results table data to a file. See <a href="#">Save As configuration menu (Measurement Results Table)</a> on page 339.
<b>Column Visibility panel</b>	
Check boxes to select columns to display	Select or clear individual check boxes to add or remove that column from the table.

## Search Results Table operations

- If there are multiple searches, each search has a tab in the table. Tap the tab of the search to display and/or configure, and then double-tap anywhere in that table to open the configuration menu for that table.
- Double-tap anywhere on a results table to open its configuration menu.
- If you add or delete a search to the Results bar, that search is automatically added to or deleted from an existing Search Results table.
- To scroll up and down in a results table, tap the table and use Multipurpose knob **A** to scroll and select table rows.
- To move a column, touch and drag the column title to a new position in the table.
- To add or remove a column from the table, double-tap the results table to open the table configuration menu and select from available columns to add or remove.
- To resize a column width, use the mouse to position the cursor on the column name border to change, then click and drag the column border to resize that column. If the column width change forces the truncation of data, hovering over a cell displays the full information content of that cell (subject to significant digits limitations on numeric entries).
- You cannot sort the contents of a column.
- You cannot change the order of rows.
- After the search events are displayed in the table, select any row and the waveform zoom points to the respective event in the display. Vice versa, when you move the zoom window, the corresponding row will be selected in the table.

## Bus Decode Results table configuration menu

Use this configuration menu to select which information to show in each Bus Decode Results table, or save a Bus Decode Results table to a file.

To open the Bus Decode Table configuration menu, double-tap anywhere in the Bus Decode Results table.

If there are multiple bus decode results tables, each bus has a tab in the table. Tap the tab of the bus to display and/or configure, and then double-tap anywhere in that table to open the configuration menu for that table.

## Bus Decode Results table menu

Field or control	Description
<b>Column Visibility panel</b>	
Check boxes for columns in table to display	Select or clear individual check boxes to add or remove that column from the table. The listed columns depend on the selected bus table in the Bus Decode Results table. Select the tab of the bus, at the top of the table, to which you want to make changes, then double-tap the table to open the configuration menu for that table.
<b>Other panel</b>	
<b>Save Table</b>	Opens the Save As dialog to let you save the table data to a comma-separated values (.csv) file. See <a href="#">Save As configuration menu (Bus Decode Results table)</a> on page 342.

## Bus Decode Results Table operations

- Each bus in a Bus Decode Results table has its own tab. Tap a tab to show the results for that bus.
- Selecting a Bus in the Bus Decode Table configuration menu does not select and display the tab for that bus. Select a tab before configuring the table for that tab.
- Double-tap anywhere on a results table to open the configuration menu for that tab.
- If you add or delete a bus to the Settings bar, that bus is automatically added to or deleted from an existing Bus Decode Results table.
- To scroll up and down in a results table, tap the table and use Multipurpose knob **A** to scroll and select table rows.
- To move a column, touch and drag the column title to a new position in the table.
- To add or remove a column from the table, double-tap the results table to open the table configuration menu and select from available columns to add or remove.
- To resize a column width, use the mouse to position the cursor on the column name border to change, then click and drag the column border to resize that column.
- You cannot sort the contents of a column.
- When both Fast Frame and one or more buses are in use, the Bus Decode Results table will display the decoded data for the selected frame. You can switch through frames and see the decoded data by using the previous/next buttons in the Fast Frame badge. The table does not show the decoded data for all the frames at the same time.



**Note: To view decoded data for all the frames:** After acquiring multiple frames of data and decoding, right click on the bus decode results table and click on **Save As** to export the decoded data of all the frames into a .csv file (you can view the .csv file for offline data analysis). You can access the decoded packet data of all the frames at the same time in the exported file. In the exported file, the frame number column will uniquely identify the frames with the decoded data packets.

- After the decoded packets are displayed in the table, select any row and the waveform zoom points to the respective packet in the bus display. Vice versa, when you move the zoom window, the corresponding packet in the table will be selected.

## Save As configuration menu (Bus Decode Results table)

Use this configuration menu to set the location and file name to which to save the contents of a results table, as a comma-separated value (csv) format file.

To open the Save As configuration menu:

1. Double-tap anywhere in the Bus Decode Results table to open the Bus Decode Results configuration menu.
2. Tap the **Other** panel.
3. Tap **Save Table**.

## Save As menu (Bus Decode Results table) fields and controls

Field or control	Description
<b>Save Location</b>	<p>Sets the location to which to save the file. The default value is the last location to which a file of this type was saved.</p> <p>Tap on the file path and use a keyboard to enter a new save location. Or double-tap on the file name to open the on-screen keyboard and enter a path.</p> <p>Tap the down arrow icon on the right end of the field to open a list of recent file save locations, for the current save type, up to a maximum of 20 locations.</p>
<b>Browse</b>	<p>Tap to open the Browse Save As Location configuration menu, to navigate to and select the location to which to save the file. See <a href="#">Browse Save As Location configuration menu</a> on page 477.</p>

Table continued...

Field or control	Description
File Name	The file name assigned to the file. The default value is either the user-entered name used to last save this file type, or a default name created by the instrument if this file type has not previously been saved with a custom file name. The default file name uses the format Tek000.  Tap on the file name and use a keyboard to enter a new file name. Or double-tap on the file name to open the virtual keyboard and enter a file name.
Save as Type	You can only save table results as comma separated values (.csv) files.

## Harmonics/Frequency Response Analysis (FRA) Results table configuration menu

Use this configuration menu to select the information to be displayed in the Harmonics/FRA Results Table, or save a Custom table to a file.

To open a Harmonics/Frequency Response Analysis (FRA) Results Table configuration menu, double-tap anywhere in the Harmonics/FRA Results table.

### Note:



- If multiple harmonics results tables are displayed, each result is in a separate tab. Tap the harmonics tab of interest to open that table, and then double-tap in the Harmonics results table area to open that table's configuration menu.
- Harmonics/FRA is displayed only for Harmonics, Control Loop Response, Power Supply Rejection Ratio, and Impedance measurements.

## Custom Results Table configuration menu

Field or control	Description
<b>Table Settings panel</b>	
Column Visibility	Select or clear individual check boxes to add or remove that column from the table.
<b>Units panel:</b> Available only for Harmonics measurement.	
Units	Sets the vertical scale used to display measurement data. Select Log or Linear.
Harmonics	Select <b>All</b> to show all harmonics, <b>Odd</b> to show just odd harmonics, or <b>Even</b> to show just even harmonics in the table.   <b>Note:</b> Changing this field also changes the harmonics bars shown in the Harmonics bar plot.
<b>Save panel</b>	
Save Table	Opens a menu to save the Custom Results Table data to a comma-separated value (CSV) file. See <a href="#">Save As configuration menu, Custom Results Table</a> on page 343.

## Save As configuration menu, Custom Results Table

Use this configuration menu to set the location and file name to save the Custom Results Table content as a comma-separated value (CSV) file.

To open the Save As configuration menu to save a Custom Results Table

1. Double-tap anywhere in the Custom Results Table to open the Custom Results Table configuration menu.
2. Tap the **Save** panel.
3. Tap the **Save Table** button.

## Save As configuration menu, Custom Results Table

Field or control	Description
<b>Save Location</b>	<p>Sets the location to save the file. The default value is the previous save location.</p> <p>Tap on the file path and enter the location. Use an external keyboard or double-tap on the file name to open the virtual keyboard and enter the path details.</p> <p>You can also use the <b>Browse</b> button to open a menu to navigate to and select the save location.</p> <p>Tap the down arrow icon on the right end of the field to open the list of recently saved file locations for the current save type. Up to 20 recently saved file locations are stored.</p>
<b>Browse</b>	<p>Tap to open the Browse Save As Location dialog, to navigate to and select the location to save the file. See <a href="#">Browse Save As Location configuration menu</a> on page 477.</p>
<b>File Name</b>	<p>Enter the file name. The default file name is Tek000. The file name increments on the next save (Tek001, Tek002, and so on).</p> <p>Double-tap on the file name to open the virtual keyboard or use an external keyboard to enter the name.</p>
<b>Save as Type</b>	<p>You can only save a Custom Results Table to a comma-separated value (CSV) file.</p>

## Annotation and navigation on waveform plots/data and results table

Annotation and Navigation are applicable for all the cycle based measurements such as Switching Loss, di/dt, dv/dt, Timing Analysis, and Amplitude Analysis.

To navigate on the results table follow the steps:

1. Tap **Add New... Measurement**.
2. Select the appropriate signals source or sources.
3. Select a supported power measurement (Switching Loss, di/dt, dv/dt,  $R_{DS(on)}$ , Timing Analysis, or Amplitude Analysis) and tap **Add**.
4. Double-tap the added power measurement badge to open that measurement's configuration menu.
5. Tap **Power Autoset** button for live signals.
6. Select the **Time Trend Plot** if the measurement includes it.
7. Push the **Single/Seq** button on the front panel.
8. Single-tap the measurement badge to display the navigation buttons on the badge.
9. Tap the **Next** or **Previous** buttons to navigate to the next or previous measurement region of the waveform view. The values for each measurement region are displayed above the navigation buttons on the badge. The selected measurement regions are also highlighted in the Zoom view on the Waveform view.
10. Tap the **Min** or **Max** buttons to navigate to the measurement region containing the minimum and maximum measurement values.

**Note:**



- $R_{DS(on)}$  supports an annotation feature that marks the minimum value of  $R_{DS(on)}$  with a line in each switching cycle.
- When  $R_{DS(on)}$  is added, a Math waveform is created. Math (resistance curve) equation can be a  $V/I$  or  $\Delta V/ \Delta I$  based on the measurement configuration, where  $V/I$  is static and  $\Delta V/ \Delta I$  is dynamic in nature.
- You can use the Measurement badge **Previous** and **Next** buttons to navigate from switching cycle to switching cycle. You can also view the minimum  $R_{DS(on)}$  value marked in the respective switching cycle.

- By default,  $R_{DS(on)}$  places the annotation lines on the switching cycle where the minimum  $R_{DS(on)}$  value occurs. When you select the measurement results badge, the navigation function enables zoom mode and centers the minimum  $R_{DS(on)}$  value for the switching cycle in the display.

## Navigation on Bar Graph and Harmonics Results Table

1. Add **Harmonics** measurement and configure the parameters.
2. If the source is a live channel, tap **Power Autoset** button.
3. Add Harmonic **Bar Graph**.
4. Tap the Results table and add Harmonics table.
5. Press the **Single/Seq** button, on the front panel.
6. Tap **Harmonics** measurement badge, which expands to display the previous and next button.
7. Tap the navigation button to navigate on the next/previous bar on the Bar Graph and to the respective row in the Harmonic table. This navigation is also vice versa and can be navigated by a single tap on a column or row or using the navigation button.

### Note:



- When all the displays are synchronized, Results table row will be highlighted and the selected Bar will be displayed in White color.
- If more than one Bar Graph is added, then all the Bar Graphs will be associated with the Results Table at the same time.

## Peak Marker results table configuration menu

Use this menu to configure the content of the Peak Marker results table.

To open the Peak Marker results table configuration menu, double-tap anywhere in the table. If there are multiple Peak Marker results tables, tap the tab of the table to configure and then double-tap anywhere in that table.

### Peak Marker results table fields and control

Field or control	Description
Frequency Resolution	Toggles the frequency resolution <b>Auto</b> or <b>Precise</b> . The default is <b>Auto</b> . <b>Auto</b> : Shows the frequency with the same precision as shown in the Spectrum View display. <b>Precise</b> : Shows the frequency down to single Hz resolution.
Save Table	Opens the Save As dialog to let you save the table data to a comma-separated values (.csv) file. See <a href="#">Save As configuration menu (Peak Marker results table)</a> on page 346.

### Right click menu for Peak Marker results table

Field or control	Description
Configure Table	Configure Peak Marker table.
Save Table	Opens the Save As dialog to let you save the table data to a comma-separated values (.csv) file. See <a href="#">Save As configuration menu (Peak Marker results table)</a> on page 346.
Delete Table	Tap to delete the table.

## Save As configuration menu (Peak Marker results table)

Use this configuration menu to set the location and file name to save the Peak Marker results table content as a comma-separated value (.csv) format file.

To open the Save As configuration menu

1. Double-tap anywhere in the Peak Marker results table to open the Peak Marker table configuration menu.
2. Tap the **Save** panel.
3. Tap the **Save Table** button.

### Save As configuration menu (Peak Marker results table)

Field or control	Description
<b>Save Location</b>	<p>Sets the location to save the file. The default value is the last location to which a file was saved.</p> <p>Tap on the file path and use a keyboard to enter the location. Use an external keyboard or double-tap on the file name to open the on-screen keyboard and enter the path details.</p> <p>You can also use the Browse button to open a menu to navigate to and select the location to which to save the file.</p> <p>Tap the down arrow icon on the right end of the field to open the list of recently saved file locations, for the current save type, up to a maximum of 20 locations.</p>
<b>Browse</b>	<p>Tap to open the Browse Save As Location dialog, to navigate to and select the location to which to save the file. See <a href="#">Browse Save As Location configuration menu</a> on page 477.</p>
<b>File Name</b>	<p>The file name assigned to the file. The default file name is Tek000. The file name increments on the next save (Tek001, Tek002, and so on).</p> <p>Tap on the file name and use a keyboard to enter a new file name. Or double-tap on the file name to open the on-screen keyboard and enter a file name.</p>
<b>Save as Type</b>	<p>You can only save a Peak Marker results table to a comma-separated value (.csv) format file.</p>

## Search configuration menu overview

Use the Search configuration menu to define conditions that you want to mark on a channel or waveform signal.

To open the Search configuration menu, double-tap a Search badge in the results bar.

If there are no Search badges on the Results bar, tap the **Add New... Search** button. A Search badge is added to the Settings bar, and the Search configuration menu opens to search type of Edge (default).

The search types and settings are similar to their corresponding trigger types (Edge, Pulse Width, Runt, and so on).

You can create multiple searches for the same waveform. Each occurrence of the search condition is marked with a triangle along the top of the waveform. Marks for each search are shown in a different color.

Use the following links to access information on specific Search settings.

### Other search types

[Bus Search configuration menus](#) on page 347

[Edge Search configuration menu](#) on page 419

[Logic search configuration menu](#) on page 420

[Pulse Width Search configuration menu](#) on page 422

[Rise/Fall Time Search configuration menu](#) on page 424

[Runt Search configuration menu](#) on page 425

[Setup and Hold Search configuration menu](#) on page 426

[Timeout Search configuration menu](#) on page 428

[Window Search configuration menu](#) on page 429

[DDR Read Search configuration menu](#) on page 431

[DDR Write Search configuration menu](#) on page 432

[DDR Read & Write Search configuration menu](#) on page 434

## Bus Search configuration menus

Use a Bus search to search for and mark bus-related events (Start, Stop, Missing Acq, Address, Data, and so on) on a bus waveform.

To create a new Bus search:

1. Tap **Add New... Search**.
2. Set the **Search Type** to **Bus**.
3. Select the bus **Source**.
4. Use the search menu fields to set the search parameters.

To change the settings of an existing search, double-tap the search badge to open its configuration menu and make necessary changes.

Select a link to view the configuration menu settings for a specific bus.

[8b10b serial bus search configuration menu](#) on page 350

[ARINC 429 serial bus search configuration menu](#) on page 351

[Audio serial bus search configuration menu](#) on page 353

[Auto Ethernet serial bus search configuration menu](#) on page 354

[CAN serial bus search configuration menu \(when not using a .dbc symbol definition file\)](#) on page 356

[EtherCAT serial bus search configuration menu](#) on page 371

[Ethernet serial bus search configuration menu](#) on page 369

[eUSB serial bus search configuration menu](#) on page 376

[FlexRay serial bus search configuration menu](#) on page 379

[I2C serial bus search configuration menu](#) on page 381

[I3C serial bus Search configuration menu](#) on page 382

[LIN serial bus search configuration menu](#) on page 391

[MDIO serial bus search configuration menu](#) on page 394

[MIL-STD-1553 serial bus search configuration menu](#) on page 396

[NFC serial bus search configuration menu](#) on page 398

[NRZ serial bus search configuration menu](#) on page 399

[Parallel bus search configuration menu](#) on page 400

[PSI5 serial bus configuration menu](#) on page 324

- [RS-232 serial bus search configuration menu](#) on page 404
- [SDLC serial bus search configuration menu](#) on page 405
- [SENT serial bus search configuration menu](#) on page 408
- [SMBus serial bus search configuration menu](#) on page 410
- [SpaceWire serial bus search configuration menu](#) on page 414
- [SPI serial bus search configuration menu](#) on page 411
- [SPMI serial bus search configuration menu](#) on page 412
- [SVID serial bus search configuration menu](#) on page 415
- [USB serial bus search configuration menu](#) on page 416

**Other search types**

- [Edge Search configuration menu](#) on page 419
- [Logic search configuration menu](#) on page 420
- [Pulse Width Search configuration menu](#) on page 422
- [Rise/Fall Time Search configuration menu](#) on page 424
- [Runt Search configuration menu](#) on page 425
- [Setup and Hold Search configuration menu](#) on page 426
- [Timeout Search configuration menu](#) on page 428
- [Window Search configuration menu](#) on page 429
- [DDR Read Search configuration menu](#) on page 431
- [DDR Write Search configuration menu](#) on page 432
- [DDR Read & Write Search configuration menu](#) on page 434

**1-Wire serial bus search configuration menu**

Use the 1-Wire Search configuration menu to define the conditions to search for and mark on a 1-Wire bus.

**Table 4: 1-Wire search menu, fields, and controls**

Field or control	Description
<b>Display</b>	Enables or disables displaying search marks for this search.
<b>Act on Event</b>	Tap the <b>Act on Event</b> button to configure the actions the instrument must take when a search event occurs. See <a href="#">Act On Event configuration menu</a> on page 178 for the available fields and controls.
<b>Search Type</b>	Set to <b>Bus</b> .
<b>Source</b>	Select the 1-Wire bus that you want to search.
<b>Mark On</b>	Sets the type of information for which to search. If the selected search type requires more input, the menu updates will show additional fields.  See the following <b>Mark On</b> tables for the menu fields associated with specific <b>Mark On</b> settings.
<b>Reset</b>	Searches and marks on the Reset event in the decode.

Table continued...



Field or control	Description
<b>Presence</b>	Select to notify the bus master that the device is on the bus and is ready to operate, and searches the same.
<b>Command</b>	Marks on the Memory Function Commands that are device-specific and are of 1 byte each (8 bits).
<b>Data</b>	Searches for user-defined data pattern in payload data.
<b>Data Bytes</b>	Sets the number of data bytes for which to search (one to five bytes). Tap the field and use the A knob to change the value.  Available only when <b>Mark On</b> is <b>Data</b> .
<b>Read ROM</b>	Allows to search for the family code and serial number of Read ROM packet.  Available only when <b>Mode</b> is <b>Standard (15.4 Kbps)</b> .
<b>Match ROM</b>	Allows to search for the family code and serial number of Match ROM packet.  Available only when <b>Mode</b> is <b>Standard (15.4 Kbps)</b> .
<b>Skip ROM</b>	Allows to search for the Skip ROM packet in the decode.  Available only when <b>Mode</b> is <b>Standard (15.4 Kbps)</b> .
<b>Search ROM</b>	Allows to search the ROM numbers of the multiple devices.  Available only when <b>Mode</b> is <b>Standard (15.4 Kbps)</b> .
<b>ROM Code</b>	Searches for the 64-bit ROM number in the search ROM packet.  Available only when <b>Mode</b> is <b>Standard (15.4 Kbps)</b> and when <b>Mark On</b> is <b>Search ROM</b> .
<b>Alarm Search</b>	Allows to search the Alarm condition if present in the decode.  Available only when <b>Mode</b> is <b>Standard (15.4 Kbps)</b>
<b>Overdrive Match ROM</b>	This command is same as the Match ROM command except that the device is only searched in overdrive mode.  Available only when <b>Mode</b> is <b>Overdrive (125 Kbps)</b> .
<b>Family Code</b>	The least significant 8 bits of the address gives the family code of the device. Search can be performed on the same bits.  Available only when <b>Mode</b> is <b>Standard (15.4 Kbps)</b> and when <b>Mark On</b> is <b>Read ROM, Match ROM</b> .  Available only when <b>Mode</b> is <b>Overdrive (125 Kbps)</b> and when <b>Mark On</b> is <b>Overdrive Match ROM</b> .
<b>Serial Number</b>	The (next) least significant 48 bits give the serial number of the device and same can be searched.  Available only when <b>Mode</b> is <b>Standard (15.4 Kbps)</b> .  Available only when <b>Mark On</b> is <b>Read ROM, Match ROM</b> .  Available only when <b>Mode</b> is <b>Overdrive (125 Kbps)</b> and when <b>Mark On</b> is <b>Overdrive Match ROM</b> .
<b>Overdrive Skip ROM</b>	This command is the same as the Skip ROM command except that only devices that can run in overdrive are searched.  Available only when <b>Mode</b> is <b>Overdrive (125 Kbps)</b> .
<b>CRC Error</b>	Allows to search if any CRC error is present in the decode.

Table continued...

Field or control	Description
<b>Copy Trigger Settings to Search</b>	Sets the search criteria to match the current oscilloscope trigger settings. 1-Wire is currently not supported as a bus trigger source.
<b>Copy Search Settings to Trigger</b>	Sets the current oscilloscope trigger settings to match the search criteria. 1-Wire is currently not supported as a bus trigger source.

**See also**

[Bus Trigger configuration](#) on page 561

[Bus Search configuration menus](#) on page 347

[1-Wire serial bus configuration menu](#) on page 297

**8b10b serial bus search configuration menu**

Use the 8b10b Search configuration menu to define conditions to search for and mark on a 8b10b bus waveform. You can have multiple searches on the same bus.

Field or control	Description
<b>Display</b>	Enables or disables displaying search marks on this search.
<b>Act on Event</b>	Tap the <b>Act on Event</b> button to configure the actions the instrument must take when a search event occurs. See <a href="#">Act On Event configuration menu</a> on page 178 for the available fields and controls.
<b>Search Type</b>	Set to <b>Bus</b> .
<b>Source</b>	Select the 8b10b bus that you want to search.
<b>Mark On</b>	Select the type of information for which to search.
<b>Format</b>	Sets the number of data bytes for which to search (one to five bytes). Use the <b>A</b> knob to change the value. Available only when <b>Mark On</b> is <b>Symbols</b> .
<b>Type</b>	Sets the type to search ( <b>Data</b> or <b>Control</b> ). Available only when <b>Mark On</b> is <b>Symbols</b> and <b>Format</b> is <b>8-Bit</b> .
<b>Disparity</b>	Sets the disparity type as <b>Positive</b> or <b>Negative</b> or <b>Either</b> . Available only when <b>Mark On</b> is <b>Symbols</b> and <b>Format</b> is <b>8-Bit</b> , <b>10-Bit</b> , and <b>Symbol</b> .  <b>Note:</b> Set the disparity value and then query the 10 bit data value.
<b>Value</b>	Sets the value for the format. <ul style="list-style-type: none"> <li>When <b>Format</b> is <b>8-Bit</b>, you can set 8-Bit value in Binary or Hex format.</li> <li>When <b>Format</b> is <b>10-Bit</b>, you can set 10-Bit value in Binary or Hex format.</li> <li>When <b>Format</b> is <b>Symbol</b>, you can set values in decimal format.</li> </ul> Available only when <b>Mark On</b> is <b>Symbols</b> .

Table continued...

Field or control	Description
<b>10Bit RD+</b>	Sets the RDpositive 10 bit value. It displays the corresponding 10 bit value for 8 bit or symbol. Set the Binary and Hex values Available when Format is 10 Bit
<b>10Bit RD-</b>	Sets the RDnegative 10 bit value. It displays the corresponding 10 bit value for 8 bit or symbol. Set the Binary and Hex values Available when Format is 10 Bit
<b>Error Type</b>	Sets the error type ( <b>Symbol or Disparity</b> ) for which to search and mark on the waveform. Available only when <b>Mark On</b> is <b>Errors</b> .
<b>Copy Trigger Settings to Search</b>	Sets the search criteria to match the current oscilloscope trigger settings. 8b10b is currently not supported as a bus trigger source.
<b>Copy Search Settings to Trigger</b>	Sets the current oscilloscope trigger settings to match the search criteria. 8b10b is currently not supported as a bus trigger source.

## See also

[Bus Trigger configuration](#) on page 561

[Bus Search configuration menus](#) on page 347

[8b10b serial bus configuration menu](#) on page 298

## ARINC 429 serial bus search configuration menu

Use the ARINC 429 Search configuration menu to define conditions to search for and mark on an ARINC 429 bus waveform. You can have multiple searches on the same bus.

Field or control	Description
<b>Display</b>	Enables or disables displaying search marks on this search.
<b>Act on Event</b>	Tap the <b>Act on Event</b> button to configure the actions the instrument must take when a search event occurs. See <a href="#">Act On Event configuration menu</a> on page 178 for the available fields and controls.
<b>Search Type</b>	Set to <b>Bus</b> .
<b>Source</b>	Select the <b>ARINC 429</b> bus to search.
<b>Mark When</b>	Sets the type of information for which to search.
<b>Trigger When Label</b>	Sets the label condition for which to search.
<b>Label</b>	Sets the label pattern for which to search.  Tap the <b>Binary</b> , <b>Hex</b> , or <b>Octal</b> field and use the <b>A</b> and <b>B</b> knobs to select and change the values. Or double-tap on the field and use the virtual keypad to enter values.  Available when <b>Mark When</b> is <b>Label</b> or <b>Label &amp; Data</b> .

Table continued...

Field or control	Description
<b>Label Low</b>	<p>Sets the low value of the label pattern range for which to search.</p> <p>Tap the <b>Binary</b>, <b>Hex</b>, or <b>Octal</b> field and use the <b>A</b> and <b>B</b> knobs to select and change the values. Or double-tap on the field and use the virtual keypad to enter values.</p> <p>Available when <b>Mark When</b> is <b>Label</b> and <b>Mark When Label</b> is <b>Inside Range</b> or <b>Outside Range</b>.</p>
<b>Label High</b>	<p>Sets the high value of the label pattern range for which to search.</p> <p>Tap the <b>Binary</b>, <b>Hex</b>, or <b>Octal</b> field and use the <b>A</b> and <b>B</b> knobs to select and change the values. Or double-tap on the field and use the virtual keypad to enter values.</p> <p>Available when <b>Mark When</b> is <b>Label</b> and <b>Mark When Label</b> is <b>Inside Range</b> or <b>Outside Range</b>.</p>
<b>Trigger When Data</b>	<p>Sets the data condition for which to search.</p>
<b>Data</b>	<p>Sets the data pattern for which to search.</p> <p>Tap the <b>Binary</b>, <b>Hex</b>, or <b>Octal</b> field and use the <b>A</b> and <b>B</b> knobs to select and change the values. Or double-tap on the field and use the virtual keypad to enter values.</p> <p>Available when <b>Mark When</b> is <b>Data</b> or <b>Label &amp; Data</b>.</p>
<b>Data Low</b>	<p>Sets the low value of the data pattern range for which to search.</p> <p>Tap the <b>Binary</b>, <b>Hex</b>, or <b>Octal</b> field and use the <b>A</b> and <b>B</b> knobs to select and change the values. Or double-tap on the field and use the virtual keypad to enter values.</p> <p>Available when <b>Mark When</b> is <b>Data</b> and <b>Mark When Data</b> is <b>Inside Range</b> or <b>Outside Range</b>.</p>
<b>Data High</b>	<p>Sets the high value of the data pattern range for which to search.</p> <p>Tap the <b>Binary</b>, <b>Hex</b>, or <b>Octal</b> field and use the <b>A</b> and <b>B</b> knobs to select and change the values. Or double-tap on the field and use the virtual keypad to enter values.</p> <p>Available when <b>Mark When</b> is <b>Data</b> and <b>Mark When Data</b> is <b>Inside Range</b> or <b>Outside Range</b>.</p>
<b>SSM</b>	<p>Sets the Sign/Status Matrix (SSM) bit condition for which to search.</p> <p>Tap the <b>Binary</b> or <b>Hex</b> field and use the <b>A</b> and <b>B</b> knobs to select and change the values. Or double-tap on the field and use the virtual keypad to enter values.</p> <p>Available when <b>Mark When</b> is <b>Data</b> or <b>Label &amp; Data</b>.</p>
<b>SDI</b>	<p>Sets the Source/Destination Identifier (SDI) bit condition for which to search.</p> <p>Tap the <b>Binary</b> or <b>Hex</b> field and use the <b>A</b> and <b>B</b> knobs to select and change the values. Or double-tap on the field and use the virtual keypad to enter values.</p> <p>Available when <b>Mark When</b> is <b>Data</b> or <b>Label &amp; Data</b>.</p>
<b>Error Type</b>	<p>Sets the error condition for which to search.</p> <p>Available when <b>Mark When</b> is <b>Error</b>.</p>
<b>Copy Trigger Settings to Search</b>	<p>Sets the search criteria to match the current oscilloscope trigger settings.</p>
<b>Copy Search Settings to Trigger</b>	<p>Sets the current oscilloscope trigger settings to match the search criteria.</p>

## See also

[Bus Trigger configuration](#) on page 561

[Bus Search configuration menus](#) on page 347

[ARINC 429 serial bus menu](#)

## Audio serial bus search configuration menu

Use the Audio Search configuration menu to define conditions to search for and mark on an Audio bus waveform. You can have multiple searches on the same bus.

Field or control	Description
<b>Display</b>	Enables or disables displaying search marks on this search.
<b>Act on Event</b>	Tap the <b>Act on Event</b> button to configure the actions the instrument must take when a search event occurs. See <a href="#">Act On Event configuration menu</a> on page 178 for the available fields and controls.
<b>Search Type</b>	Set to <b>Bus</b> .
<b>Source</b>	Select the <b>Audio</b> bus to search.
<b>Mark On</b>	Select the type of information for which to search.
<b>Data</b>	<p>Sets the data pattern for which to search. Use in conjunction with the Mark When field to specify the exact search condition.</p> <p>Tap the <b>Binary</b>, <b>Hex</b>, or <b>Decimal</b> field and use the <b>A</b> and <b>B</b> knobs to select and change the values. Or double-tap on the field and use the virtual keypad to enter values.</p> <p>Available only when <b>Mark On</b> is <b>Data</b>.</p>
<b>Word</b>	<p>Sets the audio word channel for which to search.</p> <p>Available only when <b>Mark On</b> is <b>Data</b>.</p>
<b>Mark When</b>	<p>Sets the mark when condition for the specified data pattern.</p> <p>When set to <b>Inside Range</b> or <b>Outside Range</b>, fields are displayed to set a high and low boundary pattern for the specified search range.</p> <p>Tap the <b>Binary</b>, <b>Hex</b>, or <b>Decimal</b> field and use the <b>A</b> and <b>B</b> knobs to select and change the values. Or double-tap on the field and use the virtual keypad to enter values.</p> <p>Available only when <b>Mark On</b> is <b>Data</b>.</p>
<b>A, B knob controls</b>	<p>Use the <b>A</b> knob to select (highlight) the digit(s) to change.</p> <p>Use the <b>B</b> knob to change the value of the digit(s).</p>
<b>Copy Trigger Settings to Search</b>	Sets the search criteria to match the current oscilloscope trigger settings.
<b>Copy Search Settings to Trigger</b>	Sets the current oscilloscope trigger settings to match the search criteria.

## See also

[Bus Trigger configuration](#) on page 561

[Bus Search configuration menus](#) on page 347

[Audio serial bus configuration menu](#) on page 300

## Auto Ethernet serial bus search configuration menu

Use the Auto Ethernet Search configuration menu to define conditions to search for and mark on an Auto Ethernet bus waveform. You can have multiple searches on the same bus.

Field or control	Description
<b>Display</b>	Enables or disables displaying search marks on this search.
<b>Act on Event</b>	Tap the <b>Act on Event</b> button to configure the actions the instrument must take when a search event occurs. See <a href="#">Act On Event configuration menu</a> on page 178 for the available fields and controls.
<b>Search Type</b>	Set to <b>Bus</b> .
<b>Source</b>	Select the Auto Ethernet bus that you want to search.
<b>Mark On</b>	Select the type of information for which to search.
<b>MAC Address Destination, MAC Address Source</b>	<p>Sets the MAC destination and/or source address pattern for which to search.</p> <p>Tap a <b>Binary</b> or <b>Hex</b> field and use the <b>A</b> and <b>B</b> knobs to select and change the values. Or double-tap on the field and use the virtual keypad to enter values.</p> <p>Available only when <b>Mark On</b> is <b>Mac Address</b>.</p>
<b>Q-Tag</b>	<p>Sets the Q-tag pattern for which to search.</p> <p>Tap a <b>Binary</b> or <b>Hex</b> field and use the <b>A</b> and <b>B</b> knobs to select and change the values. Or double-tap on the field and use the virtual keypad to enter values.</p> <p>Available only when <b>Mark On</b> is <b>Q-Tag Control Information</b>.</p>
<b>MAC Length/Type</b>	<p>Enter the MAC length or type pattern for which to search. Use in conjunction with the <b>Mark When</b> field to specify the exact search condition.</p> <p>Tap the <b>Binary</b> or <b>Hex</b> field and use the <b>A</b> and <b>B</b> knobs to select and change the values. Or double-tap on the field and use the virtual keypad to enter values.</p> <p>Available only when <b>Mark On</b> is <b>MAC Length/Type</b>.</p>
<b>IP Protocol</b>	<p>Sets the IP protocol pattern for which to search.</p> <p>Tap a <b>Binary</b> or <b>Hex</b> field and use the <b>A</b> and <b>B</b> knobs to select and change the values. Or double-tap on the field and use the virtual keypad to enter values.</p> <p>Available only when <b>Mark On</b> is <b>IP Header</b>.</p>
<b>Source, Destination Address</b>	<p>Sets the source and/or destination IP address pattern for which to search.</p> <p>Tap a <b>Hex</b> or <b>Decimal</b> field and use the <b>A</b> and <b>B</b> knobs to select and change the values. Or double-tap on the field and use the virtual keypad to enter values.</p> <p>Available only when <b>Mark On</b> is <b>IP Header</b>.</p>
<b>Source Port, Destination Port</b>	<p>Sets the source and/or destination TCP header port pattern for which to search.</p> <p>Tap a <b>Binary</b>, <b>Hex</b> or <b>Decimal</b> field and use the <b>A</b> and <b>B</b> knobs to select and change the values. Or double-tap on the field and use the virtual keypad to enter values.</p> <p>Available only when <b>Mark On</b> is <b>TCP Header</b>.</p>

Table continued...

Field or control	Description
<b>Sequence Number</b>	<p>Sets the TCP header sequence number pattern for which to search.</p> <p>Tap a <b>Binary</b>, <b>Hex</b> or <b>Decimal</b> field and use the <b>A</b> and <b>B</b> knobs to select and change the values. Or double-tap on the field and use the virtual keypad to enter values.</p> <p>Available only when <b>Mark On</b> is <b>TCP Header</b>.</p>
<b>Ack Number</b>	<p>Sets the TCP header ack number pattern for which to search.</p> <p>Tap a <b>Binary</b>, <b>Hex</b> or <b>Decimal</b> field and use the <b>A</b> and <b>B</b> knobs to select and change the values. Or double-tap on the field and use the virtual keypad to enter values.</p> <p>Available only when <b>Mark On</b> is <b>TCP Header</b>.</p>
<b>Data Bytes</b>	<p>Sets the number of client data bytes for which to search (one to sixteen bytes). Use the <b>A</b> knob to change the value.</p> <p>Available only when <b>Mark On</b> is <b>Client Data</b>.</p>
<b>Byte Offset</b>	<p>Sets the client data byte offset (<b>Don't Care</b> or the number of bytes). Tap the field and use the <b>A</b> knob to change the value.</p> <p>Available only when <b>Mark On</b> is <b>Client Data</b>.</p>
<b>Client Data</b>	<p>Sets the data pattern for which to search. The number of bits shown depends on the <b>Data Bytes</b> setting. Use in conjunction with the <b>Mark When</b> field to specify the exact search condition.</p> <p>Tap the <b>Binary</b>, <b>Hex</b> or <b>ASCII</b> field and use the <b>A</b> and <b>B</b> knobs to select and change the values. Or double-tap on the field and use the virtual keypad to enter values.</p> <p>Available only when <b>Mark On</b> is <b>Client Data</b>.</p>
<b>Mark When</b>	<p>Sets the mark when condition.</p> <p>When set to <b>Inside Range</b> or <b>Outside Range</b>, fields are displayed to set a high and low boundary pattern for the specified search range.</p> <p>Tap the <b>Binary</b> or <b>Hex</b> field and use the <b>A</b> and <b>B</b> knobs to select and change the values. Or double-tap on the field and use the virtual keypad to enter values.</p> <p>Available only when <b>Mark On</b> is <b>MAC Length/Type</b> or <b>Client Data</b>.</p>
<b>A, B knob controls</b>	<p>Use the <b>A</b> knob to select (highlight) the digit(s) to change.</p> <p>Use the <b>B</b> knob to change the value of the digit(s).</p>
<b>Copy Trigger Settings to Search</b>	<p>Sets the search criteria to match the current oscilloscope trigger settings.</p> <p>Auto Ethernet is currently not supported as a bus trigger source.</p>
<b>Copy Search Settings to Trigger</b>	<p>Sets the current oscilloscope trigger settings to match the search criteria.</p> <p>Auto Ethernet is currently not supported as a bus trigger source.</p>

## See also

[Bus Trigger configuration](#) on page 561

[Bus Search configuration menus](#) on page 347

[Auto Ethernet serial bus configuration menu](#) on page 301

## CAN serial bus search configuration menu (when not using a .dbc symbol definition file)

Use the CAN Search configuration menu to define conditions to search for and mark on an CAN bus waveform. This menu supports searches for CAN bus events when a .dbc symbol definition file is not loaded.



**Note:** See [CAN serial bus search configuration menu \(when using a .dbc symbol definition file\)](#) on page 357 for CAN serial bus searches that use a loaded .dbc symbol definition file.

Field or control	Description
<b>Display</b>	Enables or disables displaying waveform search marks on this search.
<b>Act on Event</b>	Tap the <b>Act on Event</b> button to configure the actions the instrument must take when a search event occurs. See <a href="#">Act On Event configuration menu</a> on page 178 for the available fields and controls.
<b>Search Type</b>	Set to <b>Bus</b> .
<b>Source</b>	Select the <b>CAN</b> bus that you want to search.
<b>Mark On</b>	<p>Sets the type of information for which to search and mark on the bus waveform acquisition.</p> <p><b>Start of Frame</b> puts a search mark at each occurrence of a CAN frame start.</p> <p><b>Type of Frame</b> puts a search mark at each occurrence of the frame type as set in the Frame Type field.</p> <p><b>Identifier</b> puts a search mark at each occurrence of a CAN identifier frame as set in the <b>Direction</b>, <b>Identifier Format</b>, and <b>Identifier</b> fields. Not available when the bus badge <b>Decode Format</b> is set to <b>Symbolic</b>.</p> <p><b>Data</b> puts a search mark at the occurrence of the specified data fields (<b>Data Bytes</b>, <b>Data Offset</b>, <b>Mark When</b>, and <b>Data</b>). Not available when the bus badge <b>Decode Format</b> is set to <b>Symbolic</b>.</p> <p><b>Id &amp; Data</b> puts a search mark at each occurrence of the specified Id and data fields. Not available when the bus badge <b>Decode Format</b> is set to <b>Symbolic</b>.</p> <p><b>End of Frame</b> puts a search mark at each occurrence of a CAN frame end.</p> <p><b>Error</b> puts a search mark at each occurrence of the specified error condition (<b>Missing Ack</b>, <b>Bit Stuffing</b>, <b>FD Form Error</b>, or <b>Any Error</b>).</p>
<b>Frame Type</b>	<p>Sets the frame type for which to search and mark on the bus waveform (<b>Data Frame</b>, <b>Remote Frame</b>, <b>Error Frame</b>, <b>Overload Frame</b>).</p> <p>Available only when <b>Mark On</b> is <b>Type of Frame</b>.</p>
<b>Direction</b>	<p>Sets the Identifier's transfer direction (<b>Read</b>, <b>Write</b>, or <b>Either</b>) for which to search.</p> <p>Available only when <b>Mark On</b> is <b>Identifier</b>.</p>
<b>Identifier Format</b>	<p>Sets the CAN identifier format bit length for which to search (<b>Standard</b> 11-bit, or <b>Extended</b> 29-bit for CAN 2.0B).</p> <p>Available only when <b>Mark On</b> is <b>Identifier</b> or <b>ID &amp; Data</b>.</p>
<b>Identifier</b>	<p>Sets the identifier pattern for which to search. The number of bits shown depends on the <b>Identifier Format</b> setting.</p> <p>Tap the <b>Binary</b> or <b>Hex</b> field and use the <b>A</b> and <b>B</b> knobs to select and change the values. Or double-tap on the field and use the virtual keypad to enter values.</p> <p>Available only when <b>Mark On</b> is <b>Identifier</b> or <b>ID &amp; Data</b>.</p>

Table continued...



Field or control	Description
<b>Data Bytes</b>	Sets the number of data bytes for which to search (one to eight bytes). Use the <b>A</b> knob to change the value.  Available only when <b>Mark On</b> is <b>Data</b> or <b>ID &amp; Data</b> .
<b>Data Offset</b>	Sets the data offset value. Use the <b>A</b> knob to change the value.  Available only when <b>Mark On</b> is <b>Data</b> or <b>ID &amp; Data</b> .
<b>Mark When</b>	Sets the mark when condition (mark the waveform when the waveform is is, $\neq$ , $<$ , $>$ , $\leq$ , or $\geq$ the data conditions).  Available only when <b>Mark On</b> is <b>Data</b> or <b>ID &amp; Data</b> .
<b>Data</b>	Sets the data pattern for which to search. The number of bits shown depends on the <b>Data Bytes</b> setting.  Tap the <b>Binary</b> or <b>Hex</b> field and use the <b>A</b> and <b>B</b> knobs to select and change the values. Or double-tap on the field and use the virtual keypad to enter values.  Available only when <b>Mark On</b> is <b>Data</b> or <b>ID &amp; Data</b> .
<b>Error Type</b>	Sets the error type for which to search and mark on the bus waveform. ( <b>Missing Ack</b> , <b>Bit Stuffing</b> , or <b>Any Error</b> ).  Available only when <b>Mark On</b> is <b>Error</b> .
<b>A, B knob controls</b>	Use the <b>A</b> knob to select (highlight) the digit to change.  Use the <b>B</b> knob to change the value of the digit.
<b>Copy Trigger Settings to Search</b>	Sets the search criteria to match the current oscilloscope trigger settings.
<b>Copy Search Settings to Trigger</b>	Sets the current oscilloscope trigger settings to match the search criteria.

## See also

[Bus Trigger configuration](#) on page 561

[Bus Search configuration menus](#) on page 347

[CAN serial bus configuration menu](#) on page 303

## CAN serial bus search configuration menu (when using a .dbc symbol definition file)

Use the CAN Search configuration menu to define conditions to search for and mark on an CAN bus waveform. This menu supports searches for CAN bus events based on labels derived from a loaded .dbc symbol definition file.

Field or control	Description
<b>Display</b>	Enables or disables displaying waveform search marks for this search.
<b>Act on Event</b>	Tap the <b>Act on Event</b> button to configure the actions the instrument must take when a search event occurs. See <a href="#">Act On Event configuration menu</a> on page 178 for the available fields and controls.
<b>Search Type</b>	Set to <b>Bus</b> .

Table continued...

Field or control	Description
<b>Source</b>	Select the <b>CAN</b> bus that you want to search and mark.
<b>Mark On</b>	<p>Sets the type of information for which to search and mark on the bus waveform acquisition.</p> <p><b>Start of Frame</b> puts a search mark at each occurrence of a CAN frame start.</p> <p><b>FD Bits</b> puts a search mark at each occurrence of the specified <b>BRS Bit</b> (Bit Rate Switch) and <b>ESI Bit</b> (Error State Indicator) states. Not available when the bus badge <b>Decode Format</b> is set to <b>Symbolic</b>.</p> <p><b>End of Frame</b> puts a search mark at each occurrence of a CAN frame end.</p> <p><b>Error</b> puts a search mark at each occurrence of the specified error condition (<b>Missing Ack, Bit Stuffing, FD Form Error, or Any Error</b>).</p> <p><b>Symbolic</b> puts a search mark at each occurrence of a specified message or signal condition as defined by an installed .dbc symbol definition file. Available only when the bus badge <b>Decode Format</b> is set to <b>Symbolic</b>.</p>
<b>Configure</b>	Opens the <b>CAN DBC Symbolic Configuration</b> menu, which sets the CAN bus search parameters based on the message and signal labeling derived from an installed .dbc symbol definition file. See <a href="#">CAN serial bus search configuration menu (when using a .dbc symbol definition file)</a> on page 357.
<b>Message, Signal, and Value fields</b>	These fields display the actual search data values for the <b>Message, Signal, and Value</b> fields as set in the <b>CAN DBC Symbolic Configuration</b> menu. These fields are shown for reference and are not editable.
<b>BRS Bits</b>	<p>Sets the <b>BRS</b> (Bit Rate Switch) bit state for which to search and mark at each occurrence on the bus waveform.</p> <p>Available only when <b>Mark On</b> is <b>FD Bits</b>.</p>
<b>ESI Bits</b>	<p>Sets the <b>ESI</b> (Error State Indicator) bit state for which to search and mark at each occurrence on the bus waveform.</p> <p>Available only when <b>Mark On</b> is <b>FD Bits</b>.</p>
<b>Error Type</b>	<p>Sets the error type for which to search and mark on the bus waveform. (<b>Missing Ack, Bit Stuffing, or Any Error</b>).</p> <p>Available only when <b>Mark On</b> is <b>Error</b>.</p>
<b>A, B knob controls</b>	<p>Use the <b>A</b> knob to select (highlight) the digit to change.</p> <p>Use the <b>B</b> knob to change the value of the digit.</p>
<b>Copy Trigger Settings to Search</b>	Sets the search criteria to match the current oscilloscope trigger settings.
<b>Copy Search Settings to Trigger</b>	Sets the current oscilloscope trigger settings to match the search criteria.

**See also**

[Bus Trigger configuration](#) on page 561

[Bus Search configuration menus](#) on page 347

[CAN serial bus configuration menu](#) on page 303

## CAN DBC Symbolic Configuration menu

Use this menu to set the CAN .dbc symbol definitions for which to search. This menu is accessed from a CAN Bus Search menu when a .dbc symbol definition file is loaded on the instrument. Load the .dbc file when you first add and configure the CAN bus.

Field or control	Description
<b>Symbolic Type</b>	Sets whether to search for <b>Message</b> CAN or search on both <b>Message and Signal</b> code.
<b>Message</b>	Sets the CAN message label for which to search. Use the drop-down list to select from message labels derived from the installed .dbc file.
<b>Signal</b>	Sets the CAN signal label for which to search. Use the drop-down list to select from signal labels derived from the installed .dbc file.
<b>Signal Encoded</b>	Enables searching for encoded signal values (when selected) or specific values (when not selected). Use the drop-down list to select from encoded signal types derived from the installed .dbc file.  Value searching is always available for a signal. Signals, however, are not necessarily encoded, so searches on signal encoding are not always available.
<b>Value</b>	Sets a specific <b>Signal</b> value for which to search. Use knob A to set a value, or double-tap the field and enter a value using the virtual keyboard.

### See also

[CAN serial bus search configuration menu \(when using a .dbc symbol definition file\)](#) on page 357

[CAN serial bus configuration menu](#) on page 303

[CAN serial bus configuration menu](#) on page 303

## CPHY serial bus search configuration menu

Use the CPHY Search configuration menu to define the conditions to search for and mark on a CPHY bus.

**Table 5: CPHY search menu, fields, and controls**

Field or control	Description
<b>Display</b>	Enables or disables displaying search marks for this search.
<b>Act on Event</b>	Tap the <b>Act on Event</b> button to configure the actions the instrument must take when a search event occurs. See <a href="#">Act On Event configuration menu</a> on page 178 for the available fields and controls.
<b>Search Type</b>	Set to <b>Bus</b> .
<b>Source</b>	Select the CPHY bus that you want to search.
<b>Mark On</b>	Sets the type of information for which to search. If the selected search type requires more input, the menu updates will show additional fields.  See the following <b>Mark On</b> tables for the menu fields associated with specific <b>Mark On</b> settings.
<b>SoT</b>	Searches the Start of Transmission (SoT) for each transmission.  Available only when <b>SubType</b> is <b>CSI or DSI</b> .
<b>EoT</b>	Searches the End of Transmission (EoT) for each transmission.  Available only when <b>SubType</b> is <b>CSI or DSI</b> .

Table continued...

Field or control	Description
<b>Data</b>	<p>Sets the data packet pattern for which to search. The number of bits shown depends on the Data Bytes setting. Use in conjunction with the Mark, to specify the exact search condition.</p> <p>Tap the <b>Binary</b> or <b>Hex</b> field and use the <b>A</b> and <b>B</b> knobs to select and change the values. Or double-tap on the field and use the virtual keypad to enter values.</p> <p>Available only when <b>SubType</b> is <b>CSI</b> or <b>DSI</b>.</p>
<b>Data Bytes</b>	<p>Sets the number of data bytes for which to search (one to five bytes). Tap the field and use the A knob to change the value.</p> <p>Available only when <b>Mark On</b> is <b>Data</b>.</p> <p>Available only when <b>SubType</b> is <b>CSI</b> or <b>DSI</b>.</p>
<b>Mode</b>	<p>Sets the mode of operation to <b>HS</b> or <b>LP</b>.</p> <p>Available only when <b>Mark On</b> is <b>Data</b>, <b>Errors</b>.</p> <p>Available only when <b>SubType</b> is <b>CSI</b> or <b>DSI</b>.</p>
<b>Packet type</b>	<p>Sets the packet type for which to search.</p> <p>Available options are <b>Short</b> or <b>Long</b>. Default is <b>Short</b>.</p> <p>Available only when <b>Mark On</b> is <b>Packets</b>.</p> <p>Available only when <b>SubType</b> is <b>CSI</b> or <b>DSI</b>.</p>
<b>Packet Name</b>	<p>Sets the packet name for which to search.</p> <p>Available options are <b>Frame Start</b>, <b>Frame End</b>, <b>Line Start</b>, <b>Line End</b>, <b>Generic Short</b>.</p> <p>Available only when <b>Packet Type</b> is <b>Short</b> and <b>SubType</b> is <b>CSI</b>.</p> <p>Available options are <b>V Sync Start</b>, <b>V Sync End</b>, <b>H Sync Start</b>, <b>H Sync End</b>, <b>End Of Transmission</b>, <b>Color Mode Off</b>, <b>Color Mode On</b>, <b>Shutdown Peripheral</b>, <b>Turn On Peripheral</b>, <b>Generic Short Write</b>, <b>Generic Read</b>, <b>Compression</b>, <b>Scrambling</b>, <b>Execute Queue</b>, <b>DCS Short Write</b>, <b>DCS Read</b>, <b>DCS Long Write</b>.</p> <p>Available only when <b>Packet Type</b> is <b>Short</b> and <b>SubType</b> is <b>DSI</b>.</p> <p>Available options are <b>Null</b>, <b>Blanking</b>, <b>Embedded</b>, <b>User 8-Bit</b>, <b>RGB565</b>, <b>RGB555</b>, <b>RGB444</b>, <b>RGB666</b>, <b>RGB888</b>, <b>RAW6</b>, <b>RAW7</b>, <b>RAW8</b>, <b>RAW10</b>, <b>RAW12</b>, <b>RAW14</b>, <b>RAW16</b>, <b>RAW20</b>, <b>YUV420 8-bit (Legacy)</b>, <b>YUV 8-Bit</b>, <b>YUV422 10-bit</b>, <b>YUV420 10-bit</b>.</p> <p>Available only when <b>Packet Type</b> is <b>Short</b> and <b>SubType</b> is <b>CSI</b>.</p> <p>Available options are <b>DCS Long Write</b>, <b>Null</b>, <b>Blanking</b>, <b>Generic Long Write</b>, <b>Picture Parameter Set</b>, <b>Compressed Pixel Stream</b>, <b>Packed Pixel 30-bit RGB 10-10-10</b>, <b>Packed Pixel 36-bit RGB 12-12-12</b>, <b>Packed Pixel 16-bit RGB 5-6-5</b>, <b>Packed Pixel 18-bit RGB 6-6-6</b>, <b>Loosely Packed Pixel 18-bit RGB 6-6-6</b>, <b>Packed Pixel 24-bit RGB 8-8-8</b>, <b>Packed Pixel 24-bit YCbCr 4:2:2</b>, <b>Loosely Packed 24-Bit YCbCr 4:2:2</b>, <b>Packed Pixel 16-bit YCbCr 4:2:2</b>, <b>Packed Pixel 12-bit YCbCr 4:2:0</b>.</p> <p>Available only when <b>Packet Type</b> is <b>Short</b> and <b>SubType</b> is <b>DSI</b>.</p> <p>Available only when <b>Mark On</b> is <b>Packets</b>.</p>
<b>Escape Mode</b>	<p>Search for the escape mode.</p> <p>Available only when <b>Packet Type</b> is <b>Short</b> and <b>SubType</b> is <b>CSI</b> or <b>DSI</b>.</p>

Table continued...

Field or control	Description
<b>Command</b>	Available options are <b>Low-Power Data Transmission, Ultra-Power State, Reset Trigger, Any</b> . Available only when <b>Mark On</b> is <b>Escape Mode</b> . Available only when <b>SubType</b> is <b>CSI or DSI</b> .
<b>Stop</b>	Search for escape mode exit. Available only when <b>SubType</b> is <b>CSI or DSI</b> .
<b>Error Type</b>	Sets the error type for which to search. Available options are <b>Any, ECC, CRC</b> . Default is <b>Any</b> . Available only when <b>Mark On</b> is <b>Errors</b> . Available only when <b>SubType</b> is <b>CSI or DSI</b> .
<b>Optional parameter</b>	Search for an optional parameter. Available only when <b>SubType</b> is <b>DSI</b> .
<b>Scrambling</b>	Search the scrambling mode command.
<b>Compression</b>	Search for the compression mode command. Available only when <b>SubType</b> is <b>DSI</b> .
<b>BusTurnAround</b>	Searches the bus turn around.
<b>Word</b>	Sets the word packet pattern for which to search. The number of bits shown depends on the Data words setting. Use in conjunction with the Mark, to specify the exact search condition. Tap the <b>Binary</b> or <b>Hex</b> field and use the <b>A</b> and <b>B</b> knobs to select and change the values. Or double-tap on the field and use the virtual keypad to enter values. Available only when <b>SubType</b> is <b>Word</b> .
<b>Data Words</b>	Sets the number of data word for which to search (one to five bytes). Tap the field and use the A knob to change the value. Available only when <b>Mark On</b> is <b>Word</b> .
<b>Symbol</b>	Sets the symbol pattern for which to search. The number of bits shown depends on the No. of symbols setting. Use in conjunction with the Mark, to specify the exact search condition. Tap the <b>Binary</b> or <b>Oct</b> field and use the <b>A</b> and <b>B</b> knobs to select and change the values. Or double-tap on the field and use the virtual keypad to enter values. Available only when <b>SubType</b> is <b>Symbol</b> .
<b>No. of Symbols</b>	Sets the number of symbols for which to search (one to five bytes). Tap the field and use the A knob to change the value. Available only when <b>Mark On</b> is <b>Symbol</b> .
<b>Copy Trigger Settings to Search</b>	Sets the search criteria to match the current oscilloscope trigger settings. CPHY is currently not supported as a bus trigger source.
<b>Copy Search Settings to Trigger</b>	Sets the current oscilloscope trigger settings to match the search criteria. CPHY is currently not supported as a bus trigger source.

**See also**

[Bus Trigger configuration](#) on page 561

[Bus Search configuration menus](#) on page 347

[CPHY serial bus configuration menu](#) on page 305

**CXPI serial bus search configuration menu**

Use the CXPI Search configuration menu to define the conditions to search for and mark on a CXPI bus.

**Table 6: CXPI search search menu, fields, and controls**

Field or control	Description
<b>Display</b>	Enables or disables displaying search marks on this search.
<b>Act on Event</b>	Tap the <b>Act on Event</b> button to configure the actions the instrument must take when a search event occurs. See <a href="#">Act On Event configuration menu</a> on page 178 for the available fields and controls.
<b>Search Type</b>	Set to <b>Bus</b> .
<b>Source</b>	Select the CXPI bus that you want to search.
<b>Mark On</b>	Select the type of information for which to search.
<b>Start</b>	Select to search the start event of the packet decode.
<b>Frames</b>	Select to search on the different frames.
<b>Frame Type</b>	Sets the frame type.  Available options are <b>Normal, Sleep, Long, Polling Normal, Polling long</b> . Default is <b>Normal</b> .  Available when <b>Mark On</b> is <b>Frames</b>
<b>Frame ID</b>	Sets the frame id value.  Tap the <b>Binary</b> or <b>Hex</b> field and use the <b>A</b> and <b>B</b> knobs to select and change the values. Or double-tap on the field and use the virtual keypad to enter values.  Available when <b>Mark On</b> is <b>Frame ID</b> .
<b>PTYPE</b>	Select to search for PTYPE (Protected Type) field.
<b>DLC</b>	Sets the DLC value.  Tap the <b>Binary</b> or <b>Hex</b> field and use the <b>A</b> and <b>B</b> knobs to select and change the values. Or double-tap on the field and use the virtual keypad to enter values.  Available when <b>Mark On</b> is <b>DLC</b> .
<b>Ext DLC</b>	Sets the Ext DLC value.  Tap the <b>Binary</b> or <b>Hex</b> field and use the <b>A</b> and <b>B</b> knobs to select and change the values. Or double-tap on the field and use the virtual keypad to enter values.  Available when <b>Mark On</b> is <b>Ext DLC</b> .
<b>Network Management</b>	Select to search for wakeup and sleep function of the slave nodes used to save the electrical power consumption.
<b>Wakeup.Ind</b>	Sets the wakeup Ind type. Switches between <b>On, Off</b> , or <b>Either</b> . Default is <b>On</b> .
<b>Sleep.Ind</b>	Sets the Sleep Ind type. Switches between <b>On, Off</b> , or <b>Either</b> . Default is <b>On</b> .

Table continued...

Field or control	Description
<b>Counter</b>	<p>Sets the counter value.</p> <p>Tap the <b>Binary</b> or <b>Hex</b> field and use the <b>A</b> and <b>B</b> knobs to select and change the values. Or double-tap on the field and use the virtual keypad to enter values.</p> <p>Available when <b>Mark On</b> is <b>Counter</b>.</p>
<b>Data Bytes</b>	<p>Sets the number of data bytes for which to search (one to five bytes). Tap the field and use the A knob to change the value.</p> <p>Available only when <b>Mark On</b> is <b>Data</b>.</p>
<b>Data</b>	<p>Sets the data packet pattern for which to search. The number of bits shown depends on the Data Bytes setting. Use in conjunction with the Mark, to specify the exact search condition.</p> <p>Tap the <b>Binary</b> or <b>Hex</b> field and use the <b>A</b> and <b>B</b> knobs to select and change the values. Or double-tap on the field and use the virtual keypad to enter values.</p> <p>Available only when <b>Mark On</b> is <b>Data</b>.</p>
<b>Error Type</b>	<p>Sets the error type for which to search.</p> <p>Available options are <b>CRC, Parity, Frame, IBS, Any</b>. Default is <b>Parity</b>.</p> <p>Available only when <b>Mark On</b> is <b>Errors</b>.</p>

## See also

[Bus Trigger configuration](#) on page 561

[Bus Search configuration menus](#) on page 347

[CXPI serial bus configuration menu](#) on page 306

## DPHY serial bus search configuration menu

Use the DPHY Search configuration menu to define the conditions to search for and mark on an DPHY bus.

**Table 7: DPHY search menu, fields and controls**

Field or control	Description
<b>Display</b>	Enables or disables displaying search marks for this search.
<b>Act on Event</b>	Tap the <b>Act on Event</b> button to configure the actions the instrument must take when a search event occurs. See <a href="#">Act On Event configuration menu</a> on page 178 for the available fields and controls.
<b>Search Type</b>	Set to <b>Bus</b> .
<b>Source</b>	Select the DPHY bus that you want to search.
<b>Mark On</b>	<p>Sets the type of information for which to search. If the selected search type requires more input, the menu updates will show additional fields.</p> <p>See the following <b>Mark On</b> tables for the menu fields associated with specific <b>Mark On</b> settings.</p>
<b>SoT</b>	Select the Start of Transmission (SoT) for each transmission.
<b>EoT</b>	Select the End of Transmission (EoT) for each transmission.

Table continued...

Field or control	Description
<b>Mode</b>	Set the mode of operation to HS or LP. Available only when <b>Mark On</b> is <b>Data, Scrambling, Compression, Packets, and Errors</b> .
<b>Data Bytes</b>	Sets the number of data bytes for which to search (one to five bytes). Tap the field and use the A knob to change the value. Available only when <b>Mark On</b> is <b>Data</b> .
<b>Data</b>	Sets the data packet pattern for which to search. The number of bits shown depends on the Data Bytes setting. Use in conjunction with the Mark When field to specify the exact search condition. Tap the <b>Binary</b> or <b>Hex</b> field and use the <b>A</b> and <b>B</b> knobs to select and change the values. Or double-tap on the field and use the virtual keypad to enter values. Available only when <b>Mark On</b> is <b>Data</b> .
<b>Scrambling</b>	Search the scrambling mode command.
<b>Compression</b>	Search for the compression mode command.
<b>Packet Type</b>	Sets the packet type for which to search. Available options are <b>Short</b> or <b>Long</b> . Default is Short. Available only when <b>Mark On</b> is <b>Packets</b> .
<b>Packet Name</b>	Sets the packet name for which to search. Available only when <b>Mark On</b> is <b>Packets</b> .
<b>BusTurnAround</b>	Searches the bus turn around.
<b>Escape</b>	Search for the escape entry mode.
<b>Stop</b>	Search for escape mode exit.
<b>Error Type</b>	Sets the error type for which to search. Available when <b>Mark On</b> is <b>Error</b> . Available options are <b>Any</b> , <b>ECC</b> , or <b>CRC</b> . Default is Any.
<b>Copy Trigger Settings to Search</b>	Sets the search criteria to match the current oscilloscope trigger settings. DPHY is currently not supported as a bus trigger source.
<b>Copy Search Settings to Trigger</b>	Sets the current oscilloscope trigger settings to match the search criteria. DPHY is currently not supported as a bus trigger source.

**See also**

[Bus Trigger configuration](#) on page 561

[Bus Search configuration menus](#) on page 347

[DPHY serial bus configuration menu](#) on page 307



## eSPI serial bus search configuration menu

Use the eSPI Search configuration menu to define the conditions to search for and mark on a eSPI bus.

**Table 8: eSPI search menu, fields, and controls**

Field or control	Description
<b>Display</b>	Enables or disables displaying search marks for this search.
<b>Act on Event</b>	Tap the <b>Act on Event</b> button to configure the actions the instrument must take when a search event occurs. See <a href="#">Act On Event configuration menu</a> on page 178 for the available fields and controls.
<b>Search Type</b>	Set to <b>Bus</b> .
<b>Source</b>	Select the eSPI bus that you want to search.
<b>Mark On</b>	Sets the type of information for which to search. If the selected search type requires more input, the menu updates will show additional fields.  See the following <b>Mark On</b> tables for the menu fields associated with specific <b>Mark On</b> settings.
<b>Start</b>	Enables to search the start event of the packet decode.
<b>Channel Independent</b>	Enables search on Channel Independent command or response packets.
<b>Peripheral Channel</b>	Enables search on Peripheral Channel command or response packets.
<b>OOB Channel</b>	Enables search on OOB Channel command or response packets.
<b>Virtual Wire Channel</b>	Enables search on Virtual Wire Channel command or response packets.
<b>Flash Access Channel</b>	Enables search on Flash Access Channel command or response packets.
<b>Wait</b>	Enables to search on the wait state that appears after the TAR window.
<b>End</b>	Enables to search on the end events when the packet decode ends.
<b>Phase</b>	Select the type of phase between command and response packets.  When <b>Mark On</b> is <b>Channel Independent</b> or <b>OOB Channel</b> or <b>Data</b> or <b>Errors</b> .  Available options are <b>Command</b> and <b>Response</b> . Default is <b>Command</b> .  When <b>Mark On</b> is <b>Peripheral Channel</b> or <b>Virtual Wire Channel</b> or <b>Flash Access Channel</b> .  Available options are <b>Command</b> , <b>Response With Header</b> and <b>Response Without Header</b> . Default is <b>Command</b> .
<b>Command</b>	Enables search for the command packets.
<b>Response</b>	Enables search for the response packets.
<b>Response With Header</b>	Enables to search on the RSP opcode that consists of a Response Code, Reserved, and Response Modifier. The size is 8 bits. It includes the optional HDR/optional data appended after it.
<b>Response Without Header</b>	Enables to search on the RSP opcode that consists of a Response Code, Reserved, and Response Modifier. The size is 8 bits.

Table continued...

Field or control	Description
<p><b>Command Opcode</b></p>	<p>Enables search on the command opcode of different channels specified under the mark on. The size is 8 bits.</p> <p>When <b>Mark On</b> is <b>Channel Independent</b> and <b>Phase</b> is <b>Command</b>, available options are <b>Get Status</b>, <b>Get Configuration</b>, <b>Set Configuration</b>. Default is <b>Get Status</b>.</p> <p>When <b>Mark On</b> is <b>Peripheral Channel</b> and <b>Phase</b> is <b>Command</b>, available options are <b>GET_NP</b>, <b>GET_PC</b>, <b>PUT_NP</b>, <b>PUT_PC</b>, <b>PUT_IORD_SHORT</b>, <b>PUT_IOWR_SHORT</b>, <b>PUT_MEMRD32_SHORT</b>, <b>PUT_MEMWR32_SHORT</b>. Default is <b>GET_NP</b>.</p> <p>When <b>Mark On</b> is <b>OOB Channel</b> and <b>Phase</b> is <b>Command</b>, available options are <b>PUT_OOB</b>, <b>GET_OOB</b>. Default is <b>PUT_OOB</b>.</p> <p>When <b>Mark On</b> is <b>Virtual Wire Channel</b> and <b>Phase</b> is <b>Command</b>, available options are <b>PUT_VWIRE</b>, <b>GET_VWIRE</b>. Default is <b>PUT_VWIRE</b>.</p> <p>When <b>Mark On</b> is <b>Flash Access Channel</b> and <b>Phase</b> is <b>Command</b>, available options are <b>PUT_FLASH_C</b>, <b>GET_FLASH_NP</b>. Default is <b>PUT_FLASH_C</b>.</p>
<p><b>Cycle Type</b></p>	<p>Enables search under command and response with header based on different cycle types for different channels. The size is 8 bits.</p> <p>When <b>Mark On</b> is <b>Peripheral Channel</b>, <b>Phase</b> is <b>Command</b>, <b>Command Opcode</b> is <b>PUT_NP</b>, available options are <b>Memory Read 32</b>, <b>Memory Read 64</b>. Default is <b>Memory Read 32</b>.</p> <p>When <b>Mark On</b> is <b>Peripheral Channel</b>, <b>Phase</b> is <b>Command</b>, <b>Command Opcode</b> is <b>PUT_PC</b>, available options are <b>Memory Write 32</b>, <b>Memory Write 64</b>, <b>Message</b>, <b>Message With Data</b>, <b>Successful Completion With Data</b>, <b>Unsuccessful Completion With Data</b>. Default is <b>Memory Write 32</b>.</p> <p>When <b>Mark On</b> is <b>Peripheral Channel</b>, <b>Phase</b> is <b>Response With Header</b>, available options are <b>Memory Read/Write 32</b>, <b>Memory Read/Write 64</b>, <b>Message</b>, <b>Message With Data</b>, <b>Successful Completion Without Data</b>, <b>Successful Completion With Data</b>, <b>Unsuccessful Completion With Data</b>, <b>Message With LTR</b>. Default is <b>Memory Read /Write 32</b>.</p> <p>When <b>Mark On</b> is <b>OOB Channel</b>, <b>Phase</b> is <b>Command</b>, <b>Command Opcode</b> is <b>PUT_OOB</b>, available options are <b>OOB (Tunneled SMBus) Message</b>, <b>MTCP</b>. Default is <b>OOB (Tunneled SMBus) Message</b>.</p> <p>When <b>Mark On</b> is <b>Flash Access Channel</b>, <b>Phase</b> is <b>Command</b>, <b>Command Opcode</b> is <b>PUT_FLASH_C</b>, available options are <b>Successful Completion Without Data</b>, <b>Successful Completion With Data</b>, <b>Unsuccessful Completion With Data</b>. Default is <b>Unsuccessful Completion Without Data</b>.</p> <p>When <b>Mark On</b> is <b>Flash Access Channel</b>, <b>Phase</b> is <b>Response With Header</b>, available options are <b>Flash Read</b>, <b>Flash Write</b>, <b>Flash Erase</b>. Default is <b>Flash Read</b>.</p>

Table continued...

Field or control	Description
Address	<p>Enables search on the address field for different channels based on different commands and response with header classified based on cycle types. Address field can vary anywhere between 8bits/16bits/32bits or 64bits.</p> <p>Tap the <b>Binary</b> or <b>Hex</b> field and use the <b>A</b> and <b>B</b> knobs to select and change the values. Or double-tap on the field and use the virtual keypad to enter values.</p> <p>Available only when <b>Mark On</b> is <b>Channel Independent</b>, <b>Phase</b> is <b>Command</b>, <b>Command Opcode</b> is <b>Get Configuration</b>, <b>Set Configuration</b>.</p> <p>Available only when <b>Mark On</b> is <b>Peripheral Channel</b>, <b>Phase</b> is <b>Command</b>, <b>Command Opcode</b> is <b>PUT_NP</b>, <b>Cycle Type</b> is <b>Memory Read 32</b>, <b>Memory Read 64</b>.</p> <p>Available only when <b>Mark On</b> is <b>Peripheral Channel</b>, <b>Phase</b> is <b>Command</b>, <b>Command Opcode</b> is <b>PUT_PC</b>, <b>Cycle Type</b> is <b>Memory Write 32</b>, <b>Memory Write 64</b>.</p> <p>Available only when <b>Mark On</b> is <b>Peripheral Channel</b>, <b>Phase</b> is <b>Command</b>, <b>Command Opcode</b> is <b>PUT_IORT_SHORT</b>, <b>PUT_IOWR_SHORT</b>, <b>PUT_MEMRD32_SHORT</b>, <b>PUTMEMWR32_SHORT</b>.</p> <p>Available only when <b>Mark On</b> is <b>Peripheral Channel</b>, <b>Phase</b> is <b>Response With Header</b>, <b>Cycle Type</b> is <b>Memory Read/Write 32</b>, <b>Memory Read/Write 64</b>.</p> <p>Available only when <b>Mark On</b> is <b>OOB Channel</b>, <b>Phase</b> is <b>Command</b>, <b>Command Opcode</b> is <b>PUT_OOB</b>, <b>Cycle Type</b> is <b>OOB (Tunneled SMBus) Message</b>, <b>MTCP</b>.</p> <p>Available only when <b>Mark On</b> is <b>Flash Access Channel</b>, <b>Phase</b> is <b>Response With Header</b>, <b>Cycle Type</b> is <b>Flash Read</b>, <b>Flash Write</b>, <b>Flash Erase</b>.</p>
Tag	<p>Enables search on the tag field for different channels based on different commands and response with header classified based on cycle types. The size is 4 bits.</p> <p>Tap the <b>Binary</b> or <b>Hex</b> field and use the <b>A</b> and <b>B</b> knobs to select and change the values. Or double-tap on the field and use the virtual keypad to enter values.</p> <p>Available only when <b>Mark On</b> is <b>Peripheral Channel</b>, <b>Phase</b> is <b>Command</b>, <b>Command Opcode</b> is <b>PUT_NP</b>, <b>Cycle Type</b> is <b>Memory Read 32</b>, <b>Memory Read 64</b> .</p> <p>Available only when <b>Mark On</b> is <b>Peripheral Channel</b>, <b>Phase</b> is <b>Command</b>, <b>Command Opcode</b> is <b>PUT_PC</b>, <b>Cycle Type</b> is <b>Memory Write 32</b>, <b>Memory Write 64</b>, <b>Message</b>, <b>Message With Data</b>, <b>Successful Completion With Data</b>, <b>Unsuccessful Completion With Data</b>.</p> <p>Available only when <b>Mark On</b> is <b>Peripheral Channel</b>, <b>Phase</b> is <b>Response With Header</b>, <b>Cycle Type</b> is <b>Memory Read/Write 32</b>, <b>Memory Read/Write 64</b>, <b>Message</b>, <b>Message With Data</b>, <b>Successful Completion Without Data</b>, <b>Successful Completion With Data</b>, <b>Unsuccessful Completion With Data</b>, <b>Message With LTR</b>.</p> <p>Available only when <b>Mark On</b> is <b>OOB Channel</b>, <b>Phase</b> is <b>Command</b>, <b>Command Opcode</b> is <b>PUT_OOB</b>, <b>Cycle Type</b> is <b>OOB (Tunneled SMBus)</b>, <b>MCTP</b>.</p> <p>Available only when <b>Mark On</b> is <b>OOB Channel</b>, <b>Phase</b> is <b>Response</b>.</p> <p>Available only when <b>Mark On</b> is <b>Flash Access Channel</b>, <b>Phase</b> is <b>Command</b>, <b>Command Opcode</b> is <b>PUT_FLASH_C</b>, <b>Cycle Type</b> is <b>Successful Completion Without Data</b>, <b>Successful Completion With Data</b>, <b>Unsuccessful Completion With Data</b>.</p> <p>Available only when <b>Mark On</b> is <b>Flash Access Channel</b>, <b>Phase</b> is <b>Response With Header</b>, <b>Cycle Type</b> is <b>Flash Read</b>, <b>Flash Write</b>, <b>Flash Erase</b>.</p>

Table continued...

Field or control	Description
<p><b>Length</b></p>	<p>Enables search on the length field for different channels based on different commands and response with header classified based on cycle types. The size is 12 bits.</p> <p>Tap the <b>Binary</b> or <b>Hex</b> field and use the <b>A</b> and <b>B</b> knobs to select and change the values. Or double-tap on the field and use the virtual keypad to enter values.</p> <p>Available only when <b>Mark On</b> is <b>Channel</b>, <b>Phase</b> is <b>Command</b>, <b>Command Opcode</b> is <b>PUT_NP</b>, <b>Cycle Type</b> is <b>Memory Read 32</b>, <b>Memory Read 64</b>.</p> <p>Available only when <b>Mark On</b> is <b>Peripheral Channel</b>, <b>Phase</b> is <b>Command</b>, <b>Command Opcode</b> is <b>PUT_PC</b>, <b>Cycle Type</b> is <b>Memory Write 32</b>, <b>Memory Write 64</b>, <b>Message</b>, <b>Message With Data</b>, <b>Successful Completion With Data</b>, <b>Unsuccessful Completion With Data</b>.</p> <p>Available only when <b>Mark On</b> is <b>Peripheral Channel</b>, <b>Phase</b> is <b>Response With Header</b>, <b>Cycle Type</b> is <b>Memory Read/Write 32</b>, <b>Memory Read/Write 64</b>, <b>Message</b>, <b>Message With Data</b>, <b>Successful Completion Without Data</b>, <b>Successful Completion With Data</b>, <b>Unsuccessful Completion With Data</b>.</p> <p>Available only when <b>Mark On</b> is <b>OOB Channel</b>, <b>Phase</b> is <b>Command</b>, <b>Command Opcode</b> is <b>PUT_OOB</b>, <b>Cycle Type</b> is <b>OOB (Tunneled SMBus)</b>, <b>MCTP</b>.</p> <p>Available onlywhen <b>Mark On</b> is <b>OOB Channel</b>, <b>Phase</b> is <b>Response</b>.</p> <p>Available only when <b>Mark On</b> is <b>Flash Access Channel</b>, <b>Phase</b> is <b>Command</b>, <b>Command Opcode</b> is <b>PUT_FLASH_C</b>, <b>Cycle Type</b> is <b>Successful Completion Without Data</b>, <b>Successful Completion With Data</b>, <b>Unsuccessful Completion With Data</b>.</p> <p>Available only when <b>Mark On</b> is <b>Flash Access Channel</b>, <b>Phase</b> is <b>Response With Header</b>, <b>Cycle Type</b> is <b>Flash Read</b>, <b>Flash Write</b>, <b>Flash Erase</b>.</p>
<p><b>SMBus Slave Address</b></p>	<p>Enables search on SMBus Slave address under the OOB channel. The size is 8 bits.</p> <p>Tap the <b>Binary</b> or <b>Hex</b> field and use the <b>A</b> and <b>B</b> knobs to select and change the values. Or double-tap on the field and use the virtual keypad to enter values.</p> <p>Available only when <b>Mark On</b> is <b>OOB Channel</b>, <b>Phase</b> is <b>Response</b>.</p>
<p><b>Virtual Wire Count</b></p>	<p>Enables search on Virtual Wire Count for command and response with header under the virtual wire channel. The size is 8 bits.</p> <p>Tap the <b>Binary</b> or <b>Hex</b> field and use the <b>A</b> and <b>B</b> knobs to select and change the values. Or double-tap on the field and use the virtual keypad to enter values.</p> <p>Available only when <b>Mark On</b> is <b>Virtual Wire Channel</b>, <b>Phase</b> is <b>Command</b>, <b>Command Opcode</b> is <b>PUT_VWIRE</b>.</p> <p>Available only when <b>Mark On</b> is <b>Virtual Wire Channel</b>, <b>Phase</b> is <b>Response With Header</b>.</p>
<p><b>Virtual Wire Index</b></p>	<p>Enables search on Virtual Wire index for command and response with header under the virtual wire channel. The size is 8 bits.</p> <p>Tap the <b>Binary</b> or <b>Hex</b> field and use the <b>A</b> and <b>B</b> knobs to select and change the values. Or double-tap on the field and use the virtual keypad to enter values.</p> <p>Available only when <b>Mark On</b> is <b>Virtual Wire Channel</b>, <b>Phase</b> is <b>Command</b>, <b>Command Opcode</b> is <b>PUT_VWIRE</b>.</p> <p>Available only when <b>Mark On</b> is <b>Virtual Wire Channel</b>, <b>Phase</b> is <b>Response With Header</b>.</p>

Table continued...

Field or control	Description
<b>Virtual Wire Data</b>	<p>Enables search on Virtual Wire Data for command and response with header under the virtual wire channel. The size is 8 bits.</p> <p>Tap the <b>Binary</b> or <b>Hex</b> field and use the <b>A</b> and <b>B</b> knobs to select and change the values. Or double-tap on the field and use the virtual keypad to enter values.</p> <p>Available only when <b>Mark On</b> is <b>Virtual Wire Channel</b>, <b>Phase</b> is <b>Command</b>, <b>Command Opcode</b> is <b>PUT_VWIRE</b>.</p> <p>Available only when <b>Mark On</b> is <b>Virtual Wire Channel</b>, <b>Phase</b> is <b>Response With Header</b>.</p>
<b>Data Bytes</b>	<p>Sets the number of data bytes for which to search.</p> <p>Tap the field and use the <b>A</b> knob to change the value. Or double-tap on the field and use the virtual keypad to enter a value.</p> <p>Available only when <b>Mark On</b> is <b>Data</b>.</p>
<b>Data</b>	<p>Sets the data value for which to search. Searches based on command or response phase.</p> <p>Tap the <b>Binary</b> or <b>Hex</b> field and use the <b>A</b> and <b>B</b> knobs to select and change the values. Or double-tap on the field and use the virtual keypad to enter values.</p> <p>Available only when <b>Mark On</b> is <b>Data</b>.</p>
<b>Status</b>	<p>Enables search on the status field of the response packets. The size is 16 bits.</p> <p>Tap the <b>Binary</b> or <b>Hex</b> field and use the <b>A</b> and <b>B</b> knobs to select and change the values. Or double-tap on the field and use the virtual keypad to enter values.</p> <p>Available only when <b>Mark On</b> is <b>Status</b>.</p>
<b>Error Type</b>	<p>Sets the error type for which to search.</p> <p>When <b>Phase</b> is <b>Command</b>, available options are <b>CRC</b>, <b>Command Opcode</b>, <b>Cycle Type</b>.</p> <p>When <b>Phase</b> is <b>Response</b>, available options are <b>CRC</b>, <b>Defer</b>, <b>Fatal</b>, <b>Non-Fatal</b>, <b>No Response</b>.</p> <p>Available only when <b>Mark On</b> is <b>Errors</b>.</p>

## See also

[Bus Trigger configuration](#) on page 561

[Bus Search configuration menus](#) on page 347

[eSPI serial bus configuration menu](#) on page 308

## Ethernet serial bus search configuration menu

Use the Ethernet Search configuration menu to define conditions to search for and mark on an Ethernet bus waveform. You can have multiple searches on the same bus.

Field or control	Description
<b>Display</b>	Enables or disables displaying search marks on this search.
<b>Act on Event</b>	Tap the <b>Act on Event</b> button to configure the actions the instrument must take when a search event occurs. See <a href="#">Act On Event configuration menu</a> on page 178 for the available fields and controls.

Table continued...

Field or control	Description
<b>Search Type</b>	Set to <b>Bus</b> .
<b>Source</b>	Select the Ethernet bus that you want to search.
<b>Mark On</b>	Select the type of information for which to search.
<b>MAC Address Destination, MAC Address Source</b>	<p>Sets the MAC destination and/or source address pattern for which to search.</p> <p>Tap a <b>Binary</b> or <b>Hex</b> field and use the <b>A</b> and <b>B</b> knobs to select and change the values. Or double-tap on the field and use the virtual keypad to enter values.</p> <p>Only available when <b>Mark On</b> is <b>Mac Addresses</b>.</p>
<b>Q-Tag</b>	<p>Sets the Q-tag pattern for which to search.</p> <p>Tap a <b>Binary</b> or <b>Hex</b> field and use the <b>A</b> and <b>B</b> knobs to select and change the values. Or double-tap on the field and use the virtual keypad to enter values.</p> <p>Only available when <b>Mark On</b> is <b>Q-Tag Control Information</b>.</p>
<b>MAC Length/Type</b>	<p>Enter the MAC length or type pattern for which to search. Use in conjunction with the <b>Mark When</b> field to specify the exact search condition.</p> <p>Tap the <b>Binary</b> or <b>Hex</b> field and use the <b>A</b> and <b>B</b> knobs to select and change the values. Or double-tap on the field and use the virtual keypad to enter values.</p> <p>Only available when <b>Mark On</b> = <b>MAC Length/Type</b>.</p>
<b>IP Protocol</b>	<p>Sets the IP protocol pattern for which to search.</p> <p>Tap a <b>Binary</b> or <b>Hex</b> field and use the <b>A</b> and <b>B</b> knobs to select and change the values. Or double-tap on the field and use the virtual keypad to enter values.</p> <p>Only available when <b>Mark On</b> is <b>IP Header</b>.</p>
<b>Source, Destination Address</b>	<p>Sets the source and/or destination IP address pattern for which to search.</p> <p>Tap a <b>Hex</b> or <b>Decimal</b> field and use the <b>A</b> and <b>B</b> knobs to select and change the values. Or double-tap on the field and use the virtual keypad to enter values.</p> <p>Only available when <b>Mark On</b> is <b>IP Header</b>.</p>
<b>Source Port, Destination Port</b>	<p>Sets the source and/or destination TCP header port pattern for which to search.</p> <p>Tap a <b>Binary</b>, <b>Hex</b> or <b>Decimal</b> field and use the <b>A</b> and <b>B</b> knobs to select and change the values. Or double-tap on the field and use the virtual keypad to enter values.</p> <p>Only available when <b>Mark On</b> is <b>TCP Header</b>.</p>
<b>Sequence Number</b>	<p>Sets the TCP header sequence number pattern for which to search.</p> <p>Tap a <b>Binary</b>, <b>Hex</b> or <b>Decimal</b> field and use the <b>A</b> and <b>B</b> knobs to select and change the values. Or double-tap on the field and use the virtual keypad to enter values.</p> <p>Only available when <b>Mark On</b> is <b>TCP Header</b>.</p>
<b>Ack Number</b>	<p>Sets the TCP header ack number pattern for which to search.</p> <p>Tap a <b>Binary</b>, <b>Hex</b> or <b>Decimal</b> field and use the <b>A</b> and <b>B</b> knobs to select and change the values. Or double-tap on the field and use the virtual keypad to enter values.</p> <p>Only available when <b>Mark On</b> is <b>TCP Header</b>.</p>

Table continued...

Field or control	Description
<b>Data Bytes</b>	Sets the number of client data bytes for which to search (one to sixteen bytes). Use the <b>A</b> knob to change the value.  Only available when <b>Mark On</b> is <b>Client Data</b> .
<b>Byte Offset</b>	Sets the client data byte offset ( <b>Don't Care</b> or the number of bytes). Tap the field and use the <b>A</b> knob to change the value.  Only available when <b>Mark On</b> is <b>Client Data</b> .
<b>Client Data</b>	Sets the data pattern for which to search. The number of bits shown depends on the <b>Data Bytes</b> setting. Use in conjunction with the <b>Mark When</b> field to specify the exact search condition.  Tap the <b>Binary</b> , <b>Hex</b> or <b>ASCII</b> field and use the <b>A</b> and <b>B</b> knobs to select and change the values. Or double-tap on the field and use the virtual keypad to enter values.  Only available when <b>Mark On</b> is <b>Client Data</b> .
<b>Mark When</b>	Sets the mark when condition.  When set to <b>Inside Range</b> or <b>Outside Range</b> , fields are displayed to set a high and low boundary pattern for the specified search range.  Tap the <b>Binary</b> or <b>Hex</b> field and use the <b>A</b> and <b>B</b> knobs to select and change the values. Or double-tap on the field and use the virtual keypad to enter values.  Only available when <b>Mark On</b> is <b>MAC Length/Type</b> or <b>Client Data</b> .
<b>A, B knob controls</b>	Use the <b>A</b> knob to select (highlight) the digit(s) to change.  Use the <b>B</b> knob to change the value of the digit(s).
<b>Copy Trigger Settings to Search</b>	Sets the search criteria to match the current oscilloscope trigger settings.
<b>Copy Search Settings to Trigger</b>	Sets the current oscilloscope trigger settings to match the search criteria.

## See also

[Bus Trigger configuration](#) on page 561

[Bus Search configuration menus](#) on page 347

[Ethernet serial bus menu](#) on page 309

## EtherCAT serial bus search configuration menu

Use the EtherCAT Search configuration menu to define conditions to search for and mark on an EtherCAT bus waveform. You can have multiple searches on the same bus.

Field or control	Description
<b>Display</b>	Enables or disables displaying search marks on this search.
<b>Act on Event</b>	Tap the <b>Act on Event</b> button to configure the actions the instrument must take when a search event occurs. See <a href="#">Act On Event configuration menu</a> on page 178 for the available fields and controls.
<b>Search Type</b>	Set to <b>Bus</b> .

Table continued...

Field or control	Description
<b>Source</b>	Select the EtherCAT bus that you want to search.
<b>Mark On</b>	Select the type of information that you want to search.
<b>Start of Frame</b>	Set to <b>Start of Frame</b> .
<b>Type</b>	Select the type that you want to search. Available when <b>Mark On</b> is <b>Protocol</b> . Available when <b>Mark On</b> is <b>Datagram</b> , <b>Datagram</b> is <b>Datagram Header</b> , and <b>Datagram Header</b> is <b>Command</b> . Available when <b>Mark On</b> is <b>Mailbox</b> , <b>Mailbox</b> is <b>Mailbox Header</b> , and <b>Mailbox Header</b> is <b>Type</b> . Available when <b>Mark On</b> is <b>Mailbox</b> and <b>Mailbox</b> is <b>Error Reply Service Data</b> .
<b>Frame Type</b>	Set frame type as <b>Basic</b> or <b>UDP/IP</b> . Available when <b>Mark On</b> is <b>Protocol</b> .
<b>Identification</b>	Sets the IP Protocol pattern that you want to search. Tap a <b>Binary</b> or <b>Hex</b> field and use the <b>A</b> and <b>B</b> knobs to select and change the values. Or double-tap on the field and use the virtual keypad to enter values. Available when <b>Mark On</b> is <b>IP Header</b> .
<b>Source Address, Destination Address</b>	Sets the source and/or destination IP address pattern that you want to search. Tap a <b>Hex</b> or <b>Decimal</b> field and use the <b>A</b> and <b>B</b> knobs to select and change the values. Or double-tap on the field and use the virtual keypad to enter values. Available when <b>Mark On</b> is <b>IP Header</b> .
<b>Source Port</b>	Sets the UDP header pattern that you want to search. Tap a <b>Binary</b> or <b>Hex</b> field and use the <b>A</b> and <b>B</b> knobs to select and change the values. Or double-tap on the field and use the virtual keypad to enter values. Available when <b>Mark On</b> is <b>UDP Header</b> .
<b>Destination, Source</b>	Sets the MAC destination and/or source address pattern that you want to search. Tap a <b>Binary</b> or <b>Hex</b> field and use the <b>A</b> and <b>B</b> knobs to select and change the values. Or double-tap on the field and use the virtual keypad to enter values. Available when <b>Mark On</b> is <b>MAC Address</b> .
<b>Tag Control Information</b>	Sets the tag control information pattern that you want to search. Tap a <b>Binary</b> or <b>Hex</b> field and use the <b>A</b> and <b>B</b> knobs to select and change the values. Or double-tap on the field and use the virtual keypad to enter values. Available when <b>Mark On</b> is <b>Tag Control Information</b> .

Table continued...



Field or control	Description
<b>Length</b>	<p>Sets the length pattern that you want to search.</p> <p>Tap a <b>Binary</b> or <b>Hex</b> field and use the <b>A</b> and <b>B</b> knobs to select and change the values. Or double-tap on the field and use the virtual keypad to enter values.</p> <p>Available when <b>Mark On</b> is <b>EtherCAT Header Length</b>.</p> <p>Available when <b>Mark On</b> is <b>Datagram</b>, <b>Datagram</b> is <b>Datagram Header</b> and <b>Datagram Header</b> is <b>Length</b>.</p> <p>Tap a <b>Binary</b> or <b>Hex</b> field and use the <b>A</b> and <b>B</b> knobs to select and change the values. Or double-tap on the field and use the virtual keypad to enter values.</p> <p>Available when <b>Mark On</b> is <b>Network Variable</b>, <b>Network Variable</b> is <b>NV Header</b> and <b>NV Header</b> is <b>Length</b>.</p> <p>Available when <b>Mark On</b> is <b>Mailbox</b>, <b>Mailbox</b> is <b>Mailbox Header</b> and <b>Mailbox Header</b> is <b>Length</b>.</p>
<b>Datagram</b>	<p>Select the datagram that you want to search.</p> <p>Available when <b>Mark On</b> is <b>Datagram</b></p>
<b>Datagram Header</b>	<p>Select the datagram header that you want to search.</p> <p>Available when <b>Mark On</b> is <b>Datagram</b>, <b>Datagram</b> is <b>Datagram Header</b>.</p>
<b>Index</b>	<p>Sets the index that you want to search.</p> <p>Tap a <b>Binary</b> or <b>Hex</b> field and use the <b>A</b> and <b>B</b> knobs to select and change the values. Or double-tap on the field and use the virtual keypad to enter values.</p> <p>Available when <b>Mark On</b> is <b>Datagram</b>, <b>Datagram</b> is <b>Datagram Header</b>, and <b>Datagram Header</b> is <b>Index</b>.</p> <p>Available when <b>Mark On</b> is <b>Network Variable</b>, <b>Network Variable</b> is <b>NV Header</b> and <b>NV Header</b> is <b>Index</b>.</p>
<b>Address Type</b>	<p>Select the address type as <b>Device</b> or <b>Logical</b>.</p> <p>Available when <b>Mark On</b> is <b>Datagram</b>, <b>Datagram</b> is <b>Datagram Header</b>, and <b>Datagram Header</b> is <b>Address</b>.</p>
<b>Position</b>	<p>Sets the device position pattern that you want to search.</p> <p>Tap a <b>Binary</b> or <b>Hex</b> field and use the <b>A</b> and <b>B</b> knobs to select and change the values. Or double-tap on the field and use the virtual keypad to enter values.</p> <p>Available when <b>Mark On</b> is <b>Datagram</b>, <b>Datagram</b> is <b>Datagram Header</b>, <b>Datagram Header</b> is <b>Address</b>, <b>Address Type</b> is <b>Device</b> and <b>Device Address</b> is <b>Position</b>.</p>
<b>Offset</b>	<p>Sets the offset pattern that you want to search.</p> <p>Tap a <b>Binary</b> or <b>Hex</b> field and use the <b>A</b> and <b>B</b> knobs to select and change the values. Or double-tap on the field and use the virtual keypad to enter values.</p> <p>Available when <b>Mark On</b> is <b>Datagram</b>, <b>Datagram</b> is <b>Datagram Header</b>, <b>Datagram Header</b> is <b>Address</b>, <b>Address Type</b> is <b>Device</b>, and <b>Device Address</b> is <b>Offset</b>.</p>

Table continued...

Field or control	Description
<b>Address</b>	<p>Sets the address that you want to search.</p> <p>Tap a <b>Binary</b> or <b>Hex</b> field and use the <b>A</b> and <b>B</b> knobs to select and change the values. Or double-tap on the field and use the virtual keypad to enter values.</p> <p>Available when <b>Mark On</b> is <b>Datagram</b>, <b>Datagram</b> is <b>Datagram Header</b>, <b>Datagram Header</b> is <b>Address</b>, and <b>Address Type</b> is <b>Logical</b>.</p> <p>Available when <b>Mark On</b> is <b>Mailbox</b>, <b>Mailbox</b> is <b>Mailbox Header</b>, and <b>Mailbox Header</b> is <b>Address</b>.</p>
<b>Circulating Frame</b>	<p>Set the circulating frame that you want to search.</p> <p>Available when <b>Mark On</b> is <b>Datagram</b>, <b>Datagram</b> is <b>Datagram Header</b>, and <b>Datagram Header</b> is <b>Circulating Frame</b>.</p>
<b>IRQ</b>	<p>Sets the IRQ that you want to search.</p> <p>Tap a <b>Binary</b> or <b>Hex</b> field and use the <b>A</b> and <b>B</b> knobs to select and change the values. Or double-tap on the field and use the virtual keypad to enter values.</p> <p>Available when <b>Mark On</b> is <b>Datagram</b>, <b>Datagram</b> is <b>Datagram Header</b> and <b>Datagram Header</b> is <b>IRQ</b>.</p>
<b>Data Bytes</b>	<p>Sets the data bytes that you want to search.</p> <p>Available when <b>Mark On</b> is <b>Datagram</b>, <b>Datagram</b> is <b>Data</b>.</p> <p>Available when <b>Mark On</b> is <b>Network Variable</b> and <b>Network Variable</b> is <b>Data</b>.</p>
<b>Data</b>	<p>Sets the data that you want to search.</p> <p>Tap a <b>Binary</b> or <b>Hex</b> field and use the <b>A</b> and <b>B</b> knobs to select and change the values. Or double-tap on the field and use the virtual keypad to enter values.</p> <p>Available when <b>Mark On</b> is <b>Datagram</b>, <b>Datagram</b> is <b>Data</b>.</p> <p>Available when <b>Mark On</b> is <b>Network Variable</b> and <b>Network Variable</b> is <b>Data</b>.</p>
<b>Working Counter</b>	<p>Sets the working counter that you want to search.</p> <p>Tap a <b>Binary</b> or <b>Hex</b> field and use the <b>A</b> and <b>B</b> knobs to select and change the values. Or double-tap on the field and use the virtual keypad to enter values.</p> <p>Available when <b>Mark On</b> is <b>Datagram</b>, <b>Datagram</b> is <b>Working Counter</b>.</p>
<b>Network Variable</b>	<p>Select the network variable that you want to search.</p> <p>Available when <b>Mark On</b> is <b>Network Variable</b>.</p>
<b>Publisher ID, NV Count, Cycle Number</b>	<p>Sets the publisher ID, NV count, and cycle number that you want to search.</p> <p>Tap a <b>Binary</b> or <b>Hex</b> field and use the <b>A</b> and <b>B</b> knobs to select and change the values. Or double-tap on the field and use the virtual keypad to enter values.</p> <p>Available when <b>Mark On</b> is <b>Network Variable</b> and <b>Network Variable</b> is <b>Publisher Header</b>.</p>
<b>Hash</b>	<p>Sets the hash algorithm that you want to search.</p> <p>Tap a <b>Binary</b> or <b>Hex</b> field and use the <b>A</b> and <b>B</b> knobs to select and change the values. Or double-tap on the field and use the virtual keypad to enter values.</p> <p>Available when <b>Mark On</b> is <b>Network Variable</b>, <b>Network Variable</b> is <b>NV Header</b> and <b>NV Header</b> is <b>Hash Algorithm</b>.</p>

Table continued...

Field or control	Description
<b>Quality</b>	<p>Sets the quality of the NV header that you want to search.</p> <p>Tap a <b>Binary</b> or <b>Hex</b> field and use the <b>A</b> and <b>B</b> knobs to select and change the values. Or double-tap on the field and use the virtual keypad to enter values.</p> <p>Available when <b>Mark On</b> is <b>Network Variable</b>, <b>Network Variable</b> is <b>NV Header</b> and <b>NV Header</b> is <b>Quality</b>.</p>
<b>Mailbox</b>	<p>Sets the mailbox for which to search.</p> <p>Available when <b>Mark On</b> is <b>Mailbox</b>.</p>
<b>Channel</b>	<p>Select the channel that you want to search.</p> <p>Available when <b>Mark On</b> is <b>Mailbox</b>, <b>Mailbox</b> is <b>Mailbox Header</b>, and <b>Mailbox Header</b> is <b>Channel</b>.</p>
<b>Priority</b>	<p>Select the priority that you want to search.</p> <p>Available when <b>Mark On</b> is <b>Mailbox</b>, <b>Mailbox</b> is <b>Mailbox Header</b>, and <b>Mailbox Header</b> is <b>Priority</b>.</p>
<b>Mailbox Type</b>	<p>Select the mailbox type for which to search.</p> <p>Available when <b>Mark On</b> is <b>Mailbox</b>, <b>Mailbox</b> is <b>Mailbox Header</b>, and <b>Mailbox Header</b> is <b>Type</b>.</p>
<b>Counter</b>	<p>Sets the counter that you want to search.</p> <p>Tap a <b>Binary</b> or <b>Hex</b> field and use the <b>A</b> and <b>B</b> knobs to select and change the values. Or double-tap on the field and use the virtual keypad to enter values.</p> <p>Available when <b>Mark On</b> is <b>Mailbox</b>, <b>Mailbox</b> is <b>Mailbox Header</b> and <b>Mailbox Header</b> is <b>Counter</b>.</p>
<b>Service Data Bytes</b>	<p>Sets the service data bytes that you want to search.</p> <p>Available when <b>Mark On</b> is <b>Mailbox</b>, <b>Mailbox</b> is <b>Service Data</b>.</p>
<b>Service Data</b>	<p>Sets the service data that you want to search.</p> <p>Tap a <b>Binary</b> or <b>Hex</b> field and use the <b>A</b> and <b>B</b> knobs to select and change the values. Or double-tap on the field and use the virtual keypad to enter values.</p> <p>Available when <b>Mark On</b> is <b>Mailbox</b>, <b>Mailbox</b> is <b>Service Data</b>.</p>
<b>Detail</b>	<p>Sets the detail that you want to search.</p> <p>Available when <b>Mark On</b> is <b>Mailbox</b>, <b>Mailbox</b> is <b>Error Reply Service Data</b>, and <b>Type</b> is <b>Detail</b>.</p>
<b>Copy Trigger Settings to Search</b>	<p>Sets the search criteria to match the current oscilloscope trigger settings.</p> <p>EtherCAT is currently not supported as a bus trigger source.</p>
<b>Copy Search Settings to Trigger</b>	<p>Sets the current oscilloscope trigger settings to match the search criteria.</p> <p>EtherCAT is currently not supported as a bus trigger source.</p>

## See also

[Bus Trigger configuration](#) on page 561

[Bus Search configuration menus](#) on page 347

[EtherCAT serial bus configuration menu](#) on page 310

## eUSB serial bus search configuration menu

Use the eUSB Search configuration menu to define conditions to search for and mark on an eUSB bus waveform. You can have multiple searches on the same bus.



Field or control	Description
<b>Display</b>	Enables or disables displaying search marks on this search.
<b>Act on Event</b>	Tap the <b>Act on Event</b> button to configure the actions the instrument must take when a search event occurs. See <a href="#">Act On Event configuration menu</a> on page 178 for the available fields and controls.
<b>Search Type</b>	Set to <b>Bus</b> .
<b>Source</b>	Select the eUSB bus that you want to search.
<b>Mark On</b>	Select the type of information for which to search.
<b>Sync Bits Search</b>	Select to search for the number of sync bits. Available when <b>Mark On</b> is <b>Sync</b> .
<b>Sync Bits</b>	Set the number of sync bits. By default Sync Bits are OFF.  <b>Note:</b> Sync Bits will be On, only when Speed is High in the Bus configuration. Available when <b>Mark On</b> is <b>Sync</b> , <b>Sync Bits Search</b> is <b>ON</b> and <b>Mark When Sync Bits</b> is all except, <b>Inside Range</b> and <b>Outside Range</b> .
<b>Handshake Type</b>	Sets the handshake packet type for which to search. Available options are <b>Any (XX10)</b> , <b>ACK (0010)</b> , <b>NAK (1010)</b> , <b>STALL (1110)</b> , or <b>NYET (0110)</b> .  <b>Note:</b> NYET is applicable only in High Speed. Available only when <b>Mark On</b> is <b>Handshake Packet</b> .
<b>Packet Type</b>	Sets the special packet type for which to search. Available options are <b>Any (XX00)</b> , <b>PRE (1100)</b> , and <b>RESERVED (0000)</b> .  <b>Note:</b> <b>ERR (1100)</b> , <b>SPLIT (1000)</b> , <b>PING (0100)</b> are available only for High Speed. Available only when <b>Mark On</b> is <b>Special Packet</b> .
<b>Hub Address</b>	Sets the special packet address pattern for which to search. Tap the <b>Binary</b> or <b>Hex</b> and use the <b>A</b> and <b>B</b> knobs to select and change the values. Or double-tap on the field and use the virtual keypad to enter values. Available only when <b>Mark On</b> is <b>Special Packet</b> and <b>Packet Type</b> is <b>Any (XX00)</b> , <b>PRE (1100)</b> , or <b>RESERVED (0000)</b> . Available when high speed is selected and <b>Mark On</b> is <b>Special Packet</b> , <b>ERR (1100)</b> , <b>SPLIT (1000)</b> , <b>PING (0100)</b> are displayed.

Table continued...

Field or control	Description
<b>Port Address</b>	<p>Sets the special packet address pattern for which to search.</p> <p>Tap the <b>Binary</b> or <b>Hex</b> and use the <b>A</b> and <b>B</b> knobs to select and change the values. Or double-tap on the field and use the virtual keypad to enter values.</p> <p>Available only when <b>Mark On</b> is <b>Special Packet</b> and <b>Packet Type</b> is <b>Any (XX00)</b>, <b>PRE (1100)</b>, or <b>RESERVED (0000)</b>. Available when high speed is selected and <b>Mark On</b> is <b>Special Packet</b>, <b>ERR (1100)</b>, <b>SPLIT (1000)</b>, <b>PING (0100)</b> are displayed.</p>
<b>Error Type</b>	<p>Sets the error type for which to search.</p> <p>Available options are <b>PID Check Bits</b>, <b>Token CRC5</b>, <b>Data CRC16</b>, and <b>Bit Stuffing</b>. Bit Stuffing is not available when High Speed is selected in the configuration.</p> <p>Available only when <b>Mark On</b> is <b>Error</b>.</p>
<b>Token Type</b>	<p>Sets the token packet type for which to search.</p> <p>Available only when <b>Mark On</b> is <b>Token Packet</b>.</p>
<b>Mark When Address</b>	<p>Sets the token type pattern for which to search. Use in conjunction with the <b>Mark When</b> field to specify the exact search condition. Tap the <b>Binary</b>, <b>Hex</b>, or <b>Decimal</b> field and use the <b>A</b> and <b>B</b> knobs to select and change the values. Or double-tap on the field and use the virtual keypad to enter values.</p> <p>Available only when <b>Mark On</b> is <b>Token Packet</b>, <b>Token Type</b> is all except <b>SOF (0101)</b>, <b>Mark When Address = Inside Range</b>, and <b>Outside Range</b>.</p>
<b>Address</b>	<p>Sets the token packet address pattern for which to search. Use in conjunction with the <b>Mark When</b> field to specify the exact search condition.</p> <p>Tap the <b>Binary</b>, <b>Hex</b>, or <b>Decimal</b> field and use the <b>A</b> and <b>B</b> knobs to select and change the values. Or double-tap on the field and use the virtual keypad to enter values.</p> <p>Available only when <b>Mark On</b> is <b>Token Packet</b> and <b>Token Type</b> is all except <b>SOF (0101)</b>.</p> <p>When <b>Mark On</b> is <b>Register Access Protocol</b> and <b>Fields</b> is <b>Address</b>.</p>
<b>Endpoint</b>	<p>Sets the token packet endpoint pattern for which to search. Use in conjunction with the <b>Mark When</b> field to specify the exact search condition. Tap the <b>Binary</b>, <b>Hex</b>, or <b>Decimal</b> field and use the <b>A</b> and <b>B</b> knobs to select and change the values. Or double-tap on the field and use the virtual keypad to enter values.</p> <p>Available only when <b>Mark On</b> is <b>Token Packet</b> and <b>Token Type = all except SOF (0101)</b>.</p>
<b>Frame Number</b>	<p>Sets the frame number pattern for which to search.</p> <p>Tap the <b>Binary</b>, <b>Hex</b>, or <b>Decimal</b> field and use the <b>A</b> and <b>B</b> knobs to select and change the values. Or double-tap on the field and use the virtual keypad to enter values.</p> <p>Available only when <b>Mark On</b> is <b>Token Packet</b> and <b>Token Type</b> is <b>SOF (0101)</b>.</p>
<b>Data Packet Type</b>	<p>Sets the data packet type for which to search.</p> <p>Available only when <b>Mark On</b> is <b>Data Packet</b>.</p> <p>Available options are <b>ANY (1011)</b>, <b>DATA0 (1011)</b>, and <b>DATA1 (1011)</b>. Available options <b>DATA2 (0111)</b> and <b>MDATA (1111)</b> when High Speed is selected in the configuration.</p>

Table continued...

Field or control	Description
<b>Data Bytes</b>	<p>Sets the number of data bytes for which to search (one to sixteen bytes). Tap the field and use the <b>A</b> knob to change the value.</p> <p>Available only when <b>Mark On</b> is <b>Data Packet</b>.</p>
<b>Byte Offset</b>	<p>Sets the byte offset (Don't Care or the number of bytes). Tap the field and use the <b>A</b> knob to change the value.</p> <p>Available only when <b>Mark On</b> is <b>Data Packet</b>.</p>
<b>Data</b>	<p>Sets the data packet pattern for which to search. The number of bits shown depends on the Data Bytes setting. Use in conjunction with the Mark When field to specify the exact search condition.</p> <p>Tap the <b>Binary</b> or <b>Hex</b> or <b>ASCII</b> field and use the <b>A</b> and <b>B</b> knobs to select and change the values. Or double-tap on the field and use the virtual keypad to enter values.</p> <p>Available only when <b>Mark On</b> is <b>Data Packet</b> and <b>Mark On</b> is <b>Data Packet</b> is <b>Register Access Protocol</b>, <b>Fields</b> is <b>Data</b>.</p>
<b>Reset</b>	Select to search all the reset events. It indicates bus reset.
<b>Mark When</b>	<p>Sets the mark when condition.</p> <p>When set to <b>Inside Range</b> or <b>Outside Range</b>, fields are displayed to set a high and low boundary pattern for the specified search range.</p> <p>Tap the <b>Binary</b> or <b>Hex</b> or <b>ASCII</b> field and use the <b>A</b> and <b>B</b> knobs to select and change the values. Or double-tap on the field and use the virtual keypad to enter values.</p> <p>Available only when <b>Mark On</b> is <b>Token Packet</b> or <b>Data Packet</b>.</p>
<b>Resume/Wake</b>	Select to search for all the Resume/Wakeup events.
<b>Connect</b>	Select to search for all the connected events. This event is triggered when the device is connected after POR.
<b>Control Message</b>	Select to search for all the control messages.
<b>Suspend</b>	Select to search all the suspended events.
<b>Device Chirp</b>	Select to search for all the device chirp events.
<b>Host chirp</b>	Select to search for all the host chirp events.
<b>Port Reset</b>	Select to search for all the port reset events.
<b>Port Configuration</b>	Select to search for port configuration events.
<b>Fields</b>	<p>Select the fields. Available options are Command, Address, or Data.</p> <p>Available only when <b>Mark On</b> is <b>Register Access Protocol</b>.</p>
<b>RAP Command</b>	Available only when <b>Mark On</b> is <b>Register Access Protocol</b> and <b>Fields</b> is <b>Command</b> .
<b>Copy Trigger Settings to Search</b>	<p>Sets the search criteria to match the current oscilloscope trigger settings.</p> <p>eUSB is currently not supported as a bus trigger source.</p>
<b>Copy Search Settings to Trigger</b>	<p>Sets the current oscilloscope trigger settings to match the search criteria.</p> <p>eUSB is currently not supported as a bus trigger source.</p>

## See also

[Bus Trigger configuration](#) on page 561

[Bus Search configuration menus](#) on page 347

[eUSB serial bus configuration menu](#) on page 311

## FlexRay serial bus search configuration menu

Use the FlexRay Search configuration menu to define conditions to search for and mark on an FlexRay bus waveform. You can have multiple searches on the same bus.

Field or control	Description
<b>Display</b>	Enables or disables displaying search marks on this search.
<b>Act on Event</b>	Tap the <b>Act on Event</b> button to configure the actions the instrument must take when a search event occurs. See <a href="#">Act On Event configuration menu</a> on page 178 for the available fields and controls.
<b>Search Type</b>	Set to <b>Bus</b> .
<b>Source</b>	Select the FlexRay bus for which to search.
<b>Mark On</b>	Select the type of information for which to search.
<b>Indicator Bits</b>	Select the defined indicator bits type for which to search from the drop-down list. Available only when <b>Mark On</b> is <b>Indicator Bits</b> .
<b>Indicator Bits</b>	Enter the indicator bits for which to search. Tap the <b>Binary</b> , <b>Hex</b> , or <b>Decimal</b> field and use the <b>A</b> and <b>B</b> knobs to select and change the values. Or double-tap on the field and use the virtual keypad to enter values. Available only when <b>Mark On</b> is <b>Header Fields</b> .
<b>Identifier</b>	Enter the frame identifier pattern for which to search. Tap the <b>Binary</b> , <b>Hex</b> , or <b>Decimal</b> field and use the <b>A</b> and <b>B</b> knobs to select and change the values. Or double-tap on the field and use the virtual keypad to enter values. Available only when <b>Mark On</b> is <b>Frame ID</b> or <b>Header Fields</b> .
<b>Cycle Count</b>	Enter the cycle count pattern for which to search. Use in conjunction with the <b>Mark When</b> field to specify the exact search condition. Tap the <b>Binary</b> , <b>Hex</b> , or <b>Decimal</b> field and use the <b>A</b> and <b>B</b> knobs to select and change the values. Or double-tap on the field and use the virtual keypad to enter values. Available only when <b>Mark On</b> is <b>Cycle Count</b> or <b>Header Fields</b> .
<b>Payload Length</b>	Enter the payload length pattern for which to search. Use in conjunction with the <b>Mark When</b> field to specify the exact search condition. Tap the <b>Binary</b> , <b>Hex</b> , or <b>Decimal</b> field and use the <b>A</b> and <b>B</b> knobs to select and change the values. Or double-tap on the field and use the virtual keypad to enter values. Available only when <b>Mark On</b> is <b>Header Fields</b> .

Table continued...

Field or control	Description
<b>Header CRC</b>	<p>Enter the header CRC pattern for which to search. Use in conjunction with the <b>Mark When</b> field to specify the exact search condition.</p> <p>Tap the <b>Binary</b> or <b>Hex</b> field and use the <b>A</b> and <b>B</b> knobs to select and change the values. Or double-tap on the field and use the virtual keypad to enter values.</p> <p>Available only when <b>Mark On</b> is <b>Header Fields</b>.</p>
<b>Data Bytes</b>	<p>Enter the number of data bytes for which to search (one to sixteen bytes). Use the <b>A</b> knob to change the value.</p> <p>Available only when <b>Mark On</b> is <b>Data</b> or <b>Identifier &amp; Data</b>.</p>
<b>Data</b>	<p>Enter the data pattern for which to search. The number of bits shown depends on the <b>Data Bytes</b> setting. Use in conjunction with the <b>Mark When</b> field to specify the exact search condition.</p> <p>Tap the <b>Binary</b> or <b>Hex</b> field and use the <b>A</b> and <b>B</b> knobs to select and change the values. Or double-tap on the field and use the virtual keypad to enter values.</p> <p>Available only when <b>Mark On</b> is <b>Data</b> or <b>Identifier &amp; Data</b>.</p>
<b>Byte Offset</b>	<p>Sets the byte offset (Don't Care or the number of bytes). Tap the field and use the <b>A</b> knob to change the value.</p> <p>Available only when <b>Mark On</b> is <b>Data</b> or <b>Identifier &amp; Data</b>.</p>
<b>Mark When</b>	<p>Sets the mark when condition.</p> <p>When set to <b>Inside Range</b> or <b>Outside Range</b>, fields are displayed to set a high and low boundary pattern for the specified search range.</p> <p>Tap the <b>Binary</b> or <b>Hex</b> field and use the <b>A</b> and <b>B</b> knobs to select and change the values. Or double-tap on the field and use the virtual keypad to enter values.</p> <p>Available only when <b>Mark On</b> is <b>Frame ID</b>, <b>Cycle Count</b>, <b>Data</b>, or <b>Identifier &amp; Data</b>.</p>
<b>Frame Type</b>	<p>Sets the end of frame type for which to search.</p> <p>Available only when <b>Mark On</b> is <b>End of Frame</b>.</p>
<b>A, B knob controls</b>	<p>Use the <b>A</b> knob to select (highlight) the digit(s) to change.</p> <p>Use the <b>B</b> knob to change the value of the digit(s).</p>
<b>Copy Trigger Settings to Search</b>	<p>Sets the search criteria to match the current oscilloscope trigger settings.</p>
<b>Copy Search Settings to Trigger</b>	<p>Sets the current oscilloscope trigger settings to match the search criteria.</p>

**See also**

[Bus Trigger configuration](#) on page 561

[Bus Search configuration menus](#) on page 347

[FlexRay serial bus configuration menu](#) on page 313



## I2C serial bus search configuration menu

Use the I2C Search configuration menu to define conditions to search for and mark on an I2C bus waveform. You can have multiple searches on the same bus.

Field or control	Description
<b>Display</b>	Enables or disables displaying search marks on this search.
<b>Act on Event</b>	Tap the <b>Act on Event</b> button to configure the actions the instrument must take when a search event occurs. See <a href="#">Act On Event configuration menu</a> on page 178 for the available fields and controls.
<b>Search Type</b>	Set to <b>Bus</b> .
<b>Source</b>	Select the I <sup>2</sup> C bus that you want to search.
<b>Mark When</b>	Select the type of information for which to search.
<b>Direction</b>	Sets the transfer direction for which to search.  Available when <b>Mark When</b> is <b>Address</b> or <b>Address &amp; Data</b> .
<b>Addressing Mode</b>	Sets the slave device address length (7 bits or 10 bits long).  Available when <b>Mark When</b> is <b>Address</b> or <b>Address &amp; Data</b> .
<b>Address</b>	Sets the address pattern for which to search. The number of bits shown depends on the <b>Address Mode</b> setting.  Tap the <b>Binary</b> or <b>Hex</b> field and use the <b>A</b> and <b>B</b> knobs to select and change the values. Or double-tap on the field and use the virtual keypad to enter values.  Available when <b>Mark When</b> is <b>Address</b> or <b>Address &amp; Data</b> .
<b>Data Bytes</b>	Sets the number of data bytes for which to search (one to five bytes). Use the <b>A</b> knob to change the value.  Available when <b>Mark When</b> is <b>Data</b> or <b>Address &amp; Data</b> .
<b>Data</b>	Sets the data pattern for which to search. The number of bits shown depends on the <b>Data Bytes</b> setting.  Tap the <b>Binary</b> or <b>Hex</b> field and use the <b>A</b> and <b>B</b> knobs to select and change the values. Or double-tap on the field and use the virtual keypad to enter values.  Available when <b>Mark When</b> is <b>Data</b> or <b>Address &amp; Data</b> .
<b>A, B knob controls</b>	Use the <b>A</b> knob to select (highlight) the character to change.  Use the <b>B</b> knob to change the value of the character.
<b>Copy Trigger Settings to Search</b>	Sets the search criteria to match the current oscilloscope trigger settings.
<b>Copy Search Settings to Trigger</b>	Sets the current oscilloscope trigger settings to match the search criteria.

### See also

[Bus Trigger configuration](#) on page 561

[Bus Search configuration menus](#) on page 347

[I2C serial bus configuration menu](#) on page 314

## I3C serial bus Search configuration menu

Use the I3C Search configuration menu to define conditions to search for and mark on an I3C bus waveform. You can have multiple searches on the same bus.

To access an I3C serial bus Search menu, double-tap on a I3C Search badge in the Results bar. If there are no I3C Search badges, tap the **Search** button and add an I3C search.



**Note:** You must have an I3C serial bus waveform in the **Waveform View** before you can create a Search for the bus.

Table 9: I3C search menu, fields and controls

Field or control	Description
<b>Display</b>	Enables or disables displaying search marks for this search.
<b>Act on Event</b>	Tap the <b>Act on Event</b> button to configure the actions the instrument must take when a search event occurs. See <a href="#">Act On Event configuration menu</a> on page 178 for the available fields and controls.
<b>Source</b>	Select the I3C bus that you want to search.
<b>Mark On</b>	Sets the type of information for which to search. If the selected search type requires more input, the menu updates to show additional fields.  See the following <b>Mark On</b> tables for the menu fields associated with specific <b>Mark On</b> settings.
<b>Copy Trigger Settings to Search</b>	Sets the search criteria to match the current oscilloscope trigger settings.
<b>Copy Search Settings to Trigger</b>	Sets the current oscilloscope trigger settings to match the search criteria.

### Mark On = Start

This table lists the menu fields displayed when **Mark On** is set to **Start**.

Field or control	Description
<b>Start</b>	Sets the search to mark <b>Start</b> events. A <b>Start</b> event occurs when the SDA line transitions from a High to Low state while the SCL line remains High.  There are no menu fields or controls displayed when this item is selected.

### Mark On = Repeated Start

This table lists the menu fields displayed when **Mark On** is set to **Repeated Start**.

Field or control	Description
<b>Repeated Start</b>	Sets the search to mark <b>Repeated Start</b> events. A <b>Repeated Start</b> is when two or more instances of a <b>Start</b> in a row occur without an intervening Stop.  There are no menu fields or controls displayed when this item is selected.

### Mark On = Address

This table lists the menu fields displayed when **Mark On** is set to **Address**.

Field or control	Description
<b>Direction</b>	Sets the search to mark address events of the specified direction ( <b>Read</b> , <b>Write</b> , or <b>Either</b> ).
<b>Addressing Mode</b>	Sets the search to mark <b>7-Bit</b> or <b>10-Bit</b> address events.
<b>Address</b>	Sets the search to mark events that meet the specified address for a Device or register location. The <b>Addressing Mode</b> sets the number of bits in the field.  Tap the <b>Binary</b> or <b>Hex</b> field and use the <b>A</b> and <b>B</b> knobs to select and change the values. Or double-tap on the field and use the virtual keypad to enter values.

### Mark On = Data

This table lists the menu fields displayed when **Mark On** is set to **Data**.

Field or control	Description
<b>Data Bytes</b>	Sets the number of data bytes to show in the <b>Data</b> field. Valid range is 1-5.
<b>Data</b>	Sets the search to mark events that meet the specified data value.  Tap the <b>Binary</b> or <b>Hex</b> field and use the <b>A</b> and <b>B</b> knobs to select and change the values. Or double-tap on the field and use the virtual keypad to enter values.

### Mark On = I3C SDR Direct fields

This table lists the menu fields available in the **I3C SDR Direct** field when **Mark On** is set to **I3C SDR Direct**.

I3C SDR Direct field	Description and menu fields
<b>Enable Slave</b>	Sets the search to mark Enable events (ENEC). Events occur when the Master enables Slave-initiated interrupts on the I3C Bus, such as to indicate a Hot-Join event or request an interrupt.  There are no menu fields or controls displayed when this item is selected.
<b>Disable Slave</b>	Sets the search to mark Disable events (DISEC). Events occur when the Master disables Slave-initiated interrupts on the I3C Bus.  There are no menu fields or controls displayed when this item is selected.
<b>Enter Activity State</b>	Sets the search to mark <b>Enter Activity State</b> events (ENTAS0, ENTAS1, ENTAS2, ENTAS3). Events occur when the Master sets an activity mode state (0, 1, 2, or 3).  There are no menu fields or controls displayed when this item is selected.
<b>Reset Dynamic Address</b>	Sets the search to mark <b>Reset Dynamic Address</b> events (RSTDAA). Events occur when a Master device tells a Slave device to forget its current Dynamic address and wait for a new address assignment.  There are no menu fields or controls displayed when this item is selected.
<b>Set Max Write Length</b>	Sets the search to mark <b>Set Max Write Length</b> events (SETMWL). Events occur when the Master sets a maximum data write length for a Slave device.  There are no menu fields or controls displayed when this item is selected.
<b>Set Max Read Length</b>	Sets the search to mark <b>Set Max Read Length</b> events (SETMRL). Events occur when the Master sets a maximum data read length for a Slave device.  There are no menu fields or controls displayed when this item is selected.

Table continued...

I3C SDR Direct field	Description and menu fields
<b>Set Exchange Time</b>	<p>Sets the search to mark <b>Set Exchange Time</b> events (SETXTIME). Events occur when Master and Slave devices exchange event timing information to collect or reconstruct timestamps, synchronize controls, and do other related tasks.</p> <p>There are no menu fields or controls displayed when this item is selected.</p>
<b>Set Dynamic Address</b>	<p>Sets the search to mark <b>Set Dynamic Address</b> events (SETDASA). Events occur when the Master assigns a dynamic address to one Slave device using the Slave's static address.</p> <p>There are no menu fields or controls displayed when this item is selected.</p>
<b>Set New Dynamic Address</b>	<p>Sets the search to mark <b>Set New Dynamic Address</b> events (SETNEWDA). Events occur when the Master assigns a new dynamic address to an I3C Slave device.</p> <p>There are no menu fields or controls displayed when this item is selected.</p>
<b>Get Max Write Length</b>	<p>Sets the search to mark <b>Get Max Write Length</b> events (GETMWL). Events occur when the Master gets a maximum data write length in bytes for a slave device.</p> <p>There are no menu fields or controls displayed when this item is selected.</p>
<b>Get Max Read Length</b>	<p>Sets the search to mark <b>Get Max Read Length</b> events (GETMRL). Events occur when the Master gets a maximum data read length in bytes for a slave device.</p> <p>There are no menu fields or controls displayed when this item is selected.</p>
<b>Get Provisional ID</b>	<p>Sets the search to mark <b>Get Provisional ID</b> events (GETPID). Events occur when the Master sends a Get request to one I3C Slave device to return its 48-bit provisional ID to the Master device.</p> <p>There are no menu fields or controls displayed when this item is selected.</p>
<b>Get Bus Characteristics</b>	<p>Sets the search to mark <b>Get Bus Characteristics</b> events (GETBCR). Events occur when the Master sends a Get request to one I3C Slave device to return its Bus Characteristics Register (BCR) contents.</p> <p>There are no menu fields or controls displayed when this item is selected.</p>
<b>Get Dev Characteristics</b>	<p>Sets the search to mark <b>Get Dev Characteristics</b> events (GETDCR). Events occur when the Master sends a Get request to one I3C Slave device to return its Device Characteristics Register (DCR) contents.</p> <p>There are no menu fields or controls displayed when this item is selected.</p>
<b>Get Slave Current Status</b>	<p>Sets the search to mark get device status events (GETSTATUS).</p> <p>When the <b>Packet</b> button is set to <b>Direct</b>, all events are marked.</p> <p>When the <b>Packet</b> button is set to <b>Response</b>, the menu displays the following fields to refine the search:</p> <p><b>Slave Address</b> sets the Slave's original 7-bit static I<sup>2</sup>C address (or 00 if the slave does not have a static I<sup>2</sup>C address) for which to search.</p> <p><b>Get Status MSB</b> sets the most significant bits of the Slave's status register for which to search. These 8 bits contain vendor-specific information.</p> <p><b>Get Status LSB</b> sets the least significant bits of the Slave's status register for which to search. These 8 bits contain pending interrupt, protocol error, and activity mode bits.</p>

Table continued...

I3C SDR Direct field	Description and menu fields
<b>Get Accept Mastership</b>	<p>Sets the search to mark <b>Get Accept Mastership</b> events (GETACCMST). Events occur when a Master request occurs, and when the Current Master offers Mastership to an I3C Secondary Master.</p> <p>There are no menu fields or controls displayed when this item is selected.</p>
<b>Set Bridge Direct Target</b>	<p>Sets the search to mark <b>Set Bridge Direct Target</b> events (SETBRGTGT). A Bridge device is a device on the I3C Bus that allows conversion from the native I3C Bus protocol to another protocol such as UART, SPI, and others).</p> <p>When the <b>Packet</b> is set to <b>Direct</b>, all <b>Set Bridge Direct Target</b> events are marked.</p> <p>When the <b>Packet</b> is set to <b>Response</b>, the menu displays the following fields to refine the search:</p> <p><b>Slave Address</b> sets the Slave's original 7-bit static I2C address, or 00 if the slave does not have a static I2C address.</p> <p><b>Dynamic Address</b> sets the 7-bit slave device address for which to search.</p> <p><b>ID</b> sets the 16-bit unambiguous identifier for the Bridged device, for which to search.</p>
<b>Get Max Data Speed</b>	<p>Sets the search to mark <b>Get Max Data Speed</b> events (GETMXDS) for a specific Slave device. Events occur when the Master asks a Slave for its SDR Mode maximum Read and Write data speeds (&amp; optionally max. Read Turnaround time)</p> <p>When the <b>Packet</b> button is set to <b>Direct</b>, all <b>Get Max Data Speed</b> events are marked.</p> <p>When the <b>Packet</b> button is set to <b>Response</b>, the menu displays the following fields to refine the search:</p> <p><b>Slave Address</b> sets the 7-bit address of a specific Slave device for which to search.</p> <p><b>Max Write</b> is an 8-bit field that sets the maximum sustained data write speed (Master to Slave) for which to search.</p> <p><b>Max Read</b> is an 8-bit field specifying the maximum sustained data read speed (Slave to Master) and Clock to Data Turnaround Time for which to search.</p> <p><b>Max Read Turn</b> is a 24-bit field specifying the Maximum Read Turnaround Time for which to search.</p>
<b>Get HDR Capability</b>	<p>Sets the search to mark <b>Get HDR Capability</b> (GETHDRCAP) events. Events occur when the Master queries a Slave device to determine what HDR Mode(s) that device supports.</p> <p>There are no menu fields or controls displayed when this item is selected.</p> <p>This item is available when <b>Version</b> is <b>1.0</b> in the I3C bus configuration menu.</p>

Table continued...

I3C SDR Direct field	Description and menu fields
<p><b>Get Exchange Time</b></p>	<p>Sets the search to mark <b>Get Exchange Time</b> events (GETXTIME).</p> <p>Use the following fields to refine the search:</p> <p>When the <b>Packet</b> button is set to <b>Direct</b>, all <b>Get Exchange Time</b> events are marked.</p> <p>When the <b>Packet</b> button is set to <b>Response</b>, the menu displays the following fields to refine the search:</p> <p><b>Slave Address</b> sets the 7-bit address of a specific Slave device for which to search.</p> <p><b>Supported Modes Byte</b> is an 8-bit field that sets which Timing Control Mode(s) to search for on the specified Slave device.</p> <p><b>State Byte</b> is an 8-bit field that sets the current Timing Control Mode (if any) of the Slave device for which to search, and whether any counter overflows have occurred since the most recent previous check.</p> <p><b>Frequency Byte</b> is an 8-bit field that sets the Slave's internal oscillator frequency for which to search.</p> <p><b>Inaccuracy Byte</b> is an 8-bit field that sets the maximum variation of the Slave's internal oscillator for which to search.</p>
<p><b>Get Optional Feature Capabilities</b></p>	<p>Sets the search to mark <b>Get Optional Feature Capabilities</b> events.</p> <p>There are no menu fields or controls displayed when this item is selected.</p> <p>This item is available when <b>Version</b> is <b>1.1</b> in the I3C bus configuration menu.</p>
<p><b>Data Transfer Ending Procedure Control</b></p>	<p>Sets the search to mark <b>Data Transfer Ending Procedure Control</b> events.</p> <p>There are no menu fields or controls displayed when this item is selected.</p> <p>This item is available when <b>Version</b> is <b>1.1</b> in the I3C bus configuration menu.</p>
<p><b>Set Group Address</b></p>	<p>Sets the search to mark <b>Set Group Address</b> events.</p> <p>There are no menu fields or controls displayed when this item is selected.</p> <p>This item is available when <b>Version</b> is <b>1.1</b> in the I3C bus configuration menu.</p>
<p><b>Slave Reset Action</b></p>	<p>Sets the search to mark <b>Slave Reset Action</b> events.</p> <p>There are no menu fields or controls displayed when this item is selected.</p> <p>This item is available when <b>Version</b> is <b>1.1</b> in the I3C bus configuration menu.</p>
<p><b>Reset Group Address</b></p>	<p>Sets the search to mark <b>Reset Group Address</b> events.</p> <p>There are no menu fields or controls displayed when this item is selected.</p> <p>This item is available when <b>Version</b> is <b>1.1</b> in the I3C bus configuration menu.</p>
<p><b>Multi-Lane Data Transfer Control</b></p>	<p>Sets the search to mark <b>Multi-Lane Data Transfer Control</b> events.</p> <p>There are no menu fields or controls displayed when this item is selected.</p> <p>This item is available when <b>Version</b> is <b>1.1</b> in the I3C bus configuration menu.</p>

Table continued...

I3C SDR Direct field	Description and menu fields
<b>Set Route</b>	<p>Sets the search to mark <b>Set Route</b> events.</p> <p>There are no menu fields or controls displayed when this item is selected.</p> <p>This item is available when <b>Version</b> is <b>1.1</b> in the I3C bus configuration menu.</p>
<b>Device to Device(s) Tunneling Control</b>	<p>Sets the search to mark <b>Device to Device(s) Tunneling Control</b> events.</p> <p>There are no menu fields or controls displayed when this item is selected.</p> <p>This item is available when <b>Version</b> is <b>1.1</b> in the I3C bus configuration menu.</p>

### Mark On = I3C SDR Broadcast fields

The following table lists the fields available when **Mark On** is set to **I3C SDR Broadcast**.

I3C SDR Broadcast field	Description and menu fields
<b>Enable Slave</b>	<p>Sets the search to mark <b>Enable Slave</b> events (ENEC) by the Master device. Enable Slave controls when Slave-initiated traffic is enabled (allowed) by the Master on the I3C Bus. This function governs a Slave's attempts to request an Interrupt, to request Mastership, or to signify a Hot-Join event.</p> <p>Use the following field to refine the search:</p> <p><b>Event Byte</b> sets the Slave enable value for which to search.</p>
<b>Disable Slave</b>	<p>Sets the search to mark <b>Disable Slave</b> events (DISEC) by the Master device. Disable Slave controls when Slave-initiated traffic is disabled (not allowed) by the Master on the I3C Bus. This function governs a Slave's attempts to request an Interrupt, to request Mastership, or to signify a Hot-Join event.</p> <p>Use the following field to refine the search:</p> <p><b>Event Byte</b> sets the Slave disable value for which to search.</p>
<b>Enter Activity State</b>	<p>Sets the search to mark <b>Enter Activity State</b> events (ENTAS0, ENTAS1, ENTAS2, ENTAS3). Events occur when the Master sets an activity mode state (0, 1, 2, or 3).</p> <p>There are no menu fields or controls displayed when this item is selected.</p>
<b>Reset Dynamic Address</b>	<p>Sets the search to mark <b>Reset Dynamic Address</b> events (RSTDAA). Events occur when the Master clears/resets one or all Master-assigned Dynamic addresses from Slave devices.</p> <p>There are no menu fields or controls displayed when this item is selected.</p>
<b>Enter Dynamic Address</b>	<p>Sets the search to mark <b>Enter Dynamic Address</b> events (ENTDAA). Events occur when the Master requests Slave devices to enter the Dynamic Address Assignment process. When enter dynamic address is set <b>Packet</b> field gets enabled. Sets the Packet as <b>Response</b> or <b>Broadcast</b>.</p> <p>When the <b>Packet</b> is set to <b>Broadcast</b>, all <b>Enter Dynamic Address</b> events are marked.</p> <p>When the <b>Packet</b> is set to <b>Response</b>, the menu displays the following fields to refine the search:</p> <p><b>Slave Address</b> sets the 7-bit address of a Slave device for which to search.</p> <p><b>ID</b> sets the Slave ID for which to search.</p> <p><b>BCR</b> sets the Bus Control Register values for which to search.</p> <p><b>DCR</b> sets the Device Control Register values for which to search.</p>

Table continued...

I3C SDR Broadcast field	Description and menu fields
<b>Set Max Write Length</b>	<p>Sets the search to mark <b>Set Max Write Length</b> events (SETMWL). Events occur when the Master sets a maximum data write length in bytes for a slave device.</p> <p>There are no menu fields or controls displayed when this item is selected.</p>
<b>Set Max Read Length</b>	<p>Sets the search to mark <b>Set Max Read Length</b> events (SETMRL). Events occur when the Master sets a maximum data read length in bytes for a slave device.</p> <p>There are no menu fields or controls displayed when this item is selected.</p>
<b>Define List of Slaves</b>	<p>Sets the search to mark <b>Define List of Slaves</b> events (DEFSLVS). Events occur when Secondary Masters are told the address of the current Master and any Slaves that are present on the I3C Bus.</p> <p>Use the following fields to refine the search:</p> <p><b>Dynamic Address</b> sets the devices' dynamic 7-bit address for which to search.</p> <p><b>DCR Type</b> sets the Device Control Register values for which to search.</p> <p><b>BCR Type</b> sets the Bus Control Register values for which to search.</p> <p><b>Static Address</b> sets the devices' 7-bit static address for which to search.</p>
<b>Enter Test Mode</b>	<p>Sets the search to mark <b>Enter Test Mode</b> events (ENTTM). Events occur when all I3C devices are told that the Master is entering a specified Test Mode during manufacturing or Device test.</p> <p>Use the following field to refine the search:</p> <p><b>Test Mode</b> sets the text mode value for which to search.</p>
<b>Set Exchange Time</b>	<p>Sets the search to mark <b>Set Exchange Timing Information</b> events (SETXTIME). Events occur when Master(s) and Slave(s) are directed to exchange event timing information for purposes including synchronizing controls, collecting or reconstructing timestamps, and specifying the timing data procedure.</p> <p>There are no menu fields or controls displayed when this item is selected.</p>
<b>Set Static as Dynamic Address</b>	<p>Sets the search to mark events where the Master assigns a Dynamic address to a Slave with a known Static address.</p> <p>There are no menu fields or controls displayed when this item is selected.</p>
<b>Data Transfer Ending Procedure Control</b>	<p>Sets the search to mark <b>Data Transfer Ending Procedure Control</b> events.</p> <p>There are no menu fields or controls displayed when this item is selected.</p> <p>This item is available when <b>Version</b> is <b>1.1</b> in the I3C bus configuration menu.</p>
<b>Set Group Address</b>	<p>Sets the search to mark <b>Set Group Address</b> events.</p> <p>There are no menu fields or controls displayed when this item is selected.</p> <p>This item is available when <b>Version</b> is <b>1.1</b> in the I3C bus configuration menu.</p>
<b>Slave Reset Action</b>	<p>Sets the search to mark <b>Slave Reset Action</b> events.</p> <p>There are no menu fields or controls displayed when this item is selected.</p> <p>This item is available when <b>Version</b> is <b>1.1</b> in the I3C bus configuration menu.</p>

Table continued...



I3C SDR Broadcast field	Description and menu fields
<b>Define List of Group Addresses</b>	Sets the search to mark <b>Define List of Group Addresses</b> events. There are no menu fields or controls displayed when this item is selected. This item is available when <b>Version</b> is <b>1.1</b> in the I3C bus configuration menu.
<b>Reset Group Address</b>	Sets the search to mark <b>Reset Group Address</b> events. There are no menu fields or controls displayed when this item is selected. This item is available when <b>Version</b> is <b>1.1</b> in the I3C bus configuration menu.
<b>Multi-Lane Data Transfer Control</b>	Sets the search to mark <b>Multi-Lane Data Transfer Control</b> events. There are no menu fields or controls displayed when this item is selected. This item is available when <b>Version</b> is <b>1.1</b> in the I3C bus configuration menu.
<b>Set Bus Context</b>	Sets the search to mark <b>Set Bus Context</b> events. There are no menu fields or controls displayed when this item is selected. This item is available when <b>Version</b> is <b>1.1</b> in the I3C bus configuration menu.

### Mark On = I3C DDR

The following table lists the fields available when **Mark On** is set to **I3C DDR**.

I3C DDR field	Description and menu fields
<b>I3C DDR</b>	Sets the search to mark Double Data Rate (DDR) events. Use the following fields to refine the search: <b>Slave Address</b> sets the 7-bit address of a Slave device for which to search. <b>Command Code</b> sets the read/write values of a command word for which to search. <b>Data Words</b> sets the length of the data words for which to search, in the range of integer value 1 (16 bits) to 5 (80 bits). <b>Data</b> sets the data value for which to search.

### Mark On = Errors fields

The following table lists the fields available when **Mark On** is set to **Errors**.

Errors field	Description
<b>Missing Ack</b>	Sets the search to mark missing ACK error events. There are no menu fields or controls displayed when this item is selected.
<b>T-Bit</b>	Sets the search to mark <b>T-Bit</b> (transition bit) error events. T-bits are an alternative to the ACK/NACK mechanism. There are no menu fields or controls displayed when this item is selected.
<b>Parity</b>	Sets the search to mark <b>Parity</b> error events. There are no menu fields or controls displayed when this item is selected.

Table continued...

Errors field	Description
<b>Broadcast Address</b>	Sets the search to mark <b>Broadcast Address</b> error events (an error with Broadcast Address commands intended for multiple Slave devices).  There are no menu fields or controls displayed when this item is selected.
<b>Dynamic Address</b>	Sets the search to mark <b>Dynamic Address</b> events.  There are no menu fields or controls displayed when this item is selected.  This item is available when <b>Version</b> is <b>1.1</b> in the I3C bus configuration menu.
<b>Preamble</b>	Sets the search to mark <b>Preamble</b> error events. The Preamble is the set of bits preceding the data words in HDR-DDR.  There are no menu fields or controls displayed when this item is selected.
<b>CRC5</b>	Sets the search to mark <b>CRC5</b> (Cyclic Redundancy Check, with fifth-order polynomial length) error events.  There are no menu fields or controls displayed when this item is selected.

### Mark On = Hot-Join

The following table lists the fields available when **Mark On** is set to **Hot-Join**.

Hot-Join field	Description and menu fields
<b>Hot-Join</b>	Sets the search to mark <b>Hot-Join</b> events. Hot-Join events allow Slaves to join the I3C Bus after it is already configured.  There are no menu fields or controls displayed when this item is selected.

### Mark On = Direct Message End

The following table lists the fields available when **Mark On** is set to **Direct Message End**.

Direct Message End field	Description and menu fields
<b>Direct Message End</b>	Sets the search to mark <b>Direct Message End</b> events. These events are end of message notifiers for messages sent to specific Slave devices.  There are no menu fields or controls displayed when this item is selected.

### Mark On = Stop

The following table lists the fields available when **Mark On** is set to **Stop**.

Stop field	Description and menu fields
<b>Stop</b>	Sets the search to mark <b>Stop</b> events. A Stop event is the I3C Bus condition of a Low to High transition on the SDA line while the SCL line remains High.  There are no menu fields or controls displayed when this item is selected.

### Mark On = HDR Restart

The following table lists the fields available when **Mark On** is set to **HDR Restart**.

HDR Restart field	Description and menu fields
HDR Restart	Sets the search to mark <b>HDR Restart</b> events. An event occurs when an <b>HDR Restart</b> pattern is sent on the bus.  There are no menu fields or controls displayed when this item is selected.

### Mark On = HDR Exit

The following table lists the fields available when **Mark On** is set to **HDR Exit**.

HDR Exit field	Description and menu fields
HDR Exit	Sets the search to mark <b>HDR Exit</b> events. An event occurs when an <b>HDR Exit</b> pattern is sent on the bus.  There are no menu fields or controls displayed when this item is selected.

### Mark On = Slave Reset Pattern

The following table lists the fields available when **Mark On** is set to **Slave Reset Pattern**.

Slave Reset Pattern field	Description and menu fields
Slave Reset Pattern	Sets the search to mark <b>Slave Reset Pattern</b> events. An event occurs when an <b>Slave Reset Pattern</b> pattern is sent on the bus.  There are no menu fields or controls displayed when this item is selected.  This item is available when <b>Version</b> is <b>1.1</b> in the I3C bus configuration menu.

### See also

[Bus Trigger configuration](#) on page 561

[Bus Search configuration menus](#) on page 347

[I3C serial bus configuration menu](#) on page 315

## LIN serial bus search configuration menu

Use the LIN Search configuration menu to define conditions to search for and mark on an LIN bus waveform. You can have multiple searches on the same bus.

Field or control	Description
Display	Enables or disables displaying search marks on this search.
Act on Event	Tap the <b>Act on Event</b> button to configure the actions the instrument must take when a search event occurs. See <a href="#">Act On Event configuration menu</a> on page 178 for the available fields and controls.
Search Type	Set to <b>Bus</b> .
Source	Select the LIN bus that you want to search.
Mark On	Select the type of information for which to search.

Table continued...

Field or control	Description
<b>Identifier</b>	<p>Sets the identifier pattern for which to search.</p> <p>Tap the <b>Binary</b>, <b>Hex</b>, or <b>Decimal</b> field and use the <b>A</b> and <b>B</b> knobs to select and change the values. Or double-tap on the field and use the virtual keypad to enter values.</p> <p>Available only when <b>Mark On</b> is <b>Identifier</b> or <b>Identifier &amp; Data</b>.</p>
<b>Mark When</b>	<p>Sets the mark when condition.</p> <p>When set to <b>Inside Range</b> or <b>Outside Range</b>, fields are displayed to set a <b>Data Low</b> and <b>Data High</b> boundary pattern for the specified search range.</p> <p>Available only when <b>Mark On</b> is <b>Data</b> or <b>Identifier &amp; Data</b>.</p>
<b>Data</b>	<p>Sets the data pattern for which to search. The number of bits shown depends on the <b>Data Bytes</b> setting.</p> <p>Tap the <b>Binary</b> or <b>Hex</b> field and use the <b>A</b> and <b>B</b> knobs to select and change the values. Or double-tap on the field and use the virtual keypad to enter values.</p> <p>Available only when <b>Mark On</b> is <b>Data</b> or <b>Identifier &amp; Data</b>.</p>
<b>Data Bytes</b>	<p>Sets the number of data bytes for which to search (one to four bytes). Use the <b>A</b> knob to change the value.</p> <p>Available only when <b>Mark On</b> is <b>Data</b> or <b>Identifier &amp; Data</b>.</p>
<b>A, B knob controls</b>	<p>Use the <b>A</b> knob to select (highlight) the digit(s) to change.</p> <p>Use the <b>B</b> knob to change the value of the digit(s).</p>
<b>Copy Trigger Settings to Search</b>	<p>Sets the search criteria to match the current oscilloscope trigger settings.</p>
<b>Copy Search Settings to Trigger</b>	<p>Sets the current oscilloscope trigger settings to match the search criteria.</p>

**See also**

[Bus Trigger configuration](#) on page 561

[Bus Search configuration menus](#) on page 347

[LIN serial bus configuration menu](#) on page 316

**Manchester serial bus search configuration menu**

Use the Manchester Search configuration menu to define conditions to search for and mark on an manchester bus decode. You can have multiple searches on the same bus.

Field or control	Description
<b>Display</b>	<p>Enables or disables displaying search marks on this search.</p>
<b>Act on Event</b>	<p>Tap the <b>Act on Event</b> button to configure the actions the instrument must take when a search event occurs. See <a href="#">Act On Event configuration menu</a> on page 178 for the available fields and controls.</p>
<b>Search Type</b>	<p>Set to <b>Bus</b>.</p>
<b>Source</b>	<p>Select the Manchester bus that you want to search.</p>

Table continued...

Field or control	Description
<b>Mark On</b>	Select the type of information for which to search.
<b>Sync</b>	<p>Sets the synchronization type for which to search.</p> <p>Tap the <b>Binary</b> or <b>Hex</b> and use the <b>A</b> and <b>B</b> knobs to select and change the values. Or double-tap on the field and use the virtual keypad to enter values.</p> <p>Only available when <b>Mark On</b> is <b>Sync Bits</b>.</p>
<b>Header</b>	<p>Sets the header for which to search.</p> <p>Tap the <b>Binary</b> or <b>Hex</b> and use the <b>A</b> and <b>B</b> knobs to select and change the values. Or double-tap on the field and use the virtual keypad to enter values.</p> <p>Only available when <b>Mark On</b> is <b>Header</b>.</p>
<b>Data Words</b>	<p>Set the length of the data words for which to search, in the range of integer value</p> <p>Default value is 1, maximum value is 5.</p> <p>Only available when <b>Mark On</b> is <b>Data</b>.</p>
<b>Data</b>	<p>Sets the data type for which to search.</p> <p>Tap the <b>Binary</b> or <b>Hex</b> and use the <b>A</b> and <b>B</b> knobs to select and change the values. Or double-tap on the field and use the virtual keypad to enter values.</p> <p>Only available when <b>Mark On</b> = <b>Data</b>.</p>
<b>Trailer</b>	<p>Sets the trailer for which to search.</p> <p>Tap the <b>Binary</b> or <b>Hex</b> and use the <b>A</b> and <b>B</b> knobs to select and change the values. Or double-tap on the field and use the virtual keypad to enter values.</p> <p>Only available when <b>Mark On</b> is <b>Trailer</b>.</p>
<b>Error Type</b>	<p>Sets the error type for which to search.</p> <p>Available types are <b>Manchester</b> and <b>Parity</b>.</p> <p>Only available when <b>Mark On</b> is <b>Errors</b>.</p>
<b>Copy Trigger Settings to Search</b>	<p>Sets the search criteria to match the current oscilloscope trigger settings.</p> <p>Manchester is currently not supported as a bus trigger source.</p>
<b>Copy Search Settings to Trigger</b>	<p>Sets the current oscilloscope trigger settings to match the search criteria.</p> <p>Manchester is currently not supported as a bus trigger source.</p>

**Note:** In the bus configuration, when the packet view is



- **On**, the displayed Search options are **Sync Bits**, **Header**, **Data**, **Trailer**, and **Errors**.
- **Off**, the displayed Search options are **Data** and **Errors**.

## See also

[Bus Trigger configuration](#) on page 561

[Bus Search configuration menus](#) on page 347

[Manchester serial bus configuration menu](#) on page 317

## MDIO serial bus search configuration menu

Use the MDIO Search configuration menu to define the conditions to search for and mark on an MDIO bus waveform. You can have multiple searches on the same bus.

**Table 10: MDIO search menu, fields and controls**

Field or control	Description
<b>Display</b>	Enables or disables displaying search marks for this search.
<b>Act on Event</b>	Tap the <b>Act on Event</b> button to configure the actions the instrument must take when a search event occurs. See <a href="#">Act On Event configuration menu</a> on page 178 for the available fields and controls.
<b>Search Type</b>	Set to <b>Bus</b> .
<b>Source</b>	Select the MDIO bus that you want to search.
<b>Mark On</b>	Sets the type of information for which to search. If the selected search type requires more input, the menu updates to show additional fields.  See the following <b>Mark On</b> tables for the menu fields associated with specific <b>Mark On</b> settings.
<b>Copy Trigger Settings to Search</b>	Sets the search criteria to match the current oscilloscope trigger settings.  MDIO is currently not supported as a bus trigger source.
<b>Copy Search Settings to Trigger</b>	Sets the current oscilloscope trigger settings to match the search criteria.  MDIO is currently not supported as a bus trigger source.

### Mark On = Start Packet

This table lists the menu fields displayed when **Mark On** is set to **Start Packet**.

Field or control	Description
<b>Start Packet</b>	Sets the search to mark <b>Start</b> events. A <b>Start Packet</b> event occurs when the SDA line transitions from a High to Low state while the SCL line remains High.  There are no menu fields or controls displayed when this item is selected.

### Mark On = OpCode

This table lists the menu fields displayed when **Mark On** is set to **OpCode**.

Field or control	Description
<b>OpCode</b>	Sets to search two bit operation codes.  Tap the <b>Binary</b> or <b>Hex</b> field and use the <b>A</b> and <b>B</b> knobs to select and change the values. Or double-tap on the field and use the virtual keypad to enter values.  Only available when <b>Mark When</b> is <b>OpCode</b> .

### Mark On = Physical Address

This table lists the menu fields displayed when **Mark On** is set to **Physical Address**.

Field or control	Description
<b>Physical Address</b>	Set the 5 bit long field to search for the physical PHYs which are used to interface to the network.  Tap the <b>Binary</b> or <b>Hex</b> field and use the <b>A</b> and <b>B</b> knobs to select and change the values. Or double-tap on the field and use the virtual keypad to enter values.

### Mark On = Register Address

This table lists the menu fields displayed when **Mark On** is set to **Register Address**.

Field or control	Description
<b>Register Address</b>	Sets the 5 bit long field to search the register to be written to or read from.  Tap the <b>Binary</b> or <b>Hex</b> field and use the <b>A</b> and <b>B</b> knobs to select and change the values. Or double-tap on the field and use the virtual keypad to enter values.  Available when <b>Mark On</b> is <b>Register Address</b> .

### Mark On = Device Type

This table lists the menu fields displayed when **Mark On** is set to **Device Type**.

Field or control	Description
<b>Device Type</b>	Sets the 5 bit long field to search for the device type of clause 45.  Tap the <b>Binary</b> or <b>Hex</b> field and use the <b>A</b> and <b>B</b> knobs to select and change the values. Or double-tap on the field and use the virtual keypad to enter values.  Available when <b>Mark On</b> is <b>Device Type</b> .

### Mark On = Data

This table lists the menu fields displayed when **Mark On** is set to **Data**.

Field or control	Description
<b>Data</b>	Sets the search to mark events that meet the specified data value.  Tap the <b>Binary</b> or <b>Hex</b> field and use the <b>A</b> and <b>B</b> knobs to select and change the values. Or double-tap on the field and use the virtual keypad to enter values.  Available when <b>Mark On</b> is <b>Data</b> .

### Mark On = Address

This table lists the menu fields displayed when **Mark On** is set to **Address**.

Field or control	Description
<b>Address</b>	Sets the 16 bit long field search for the specified address.  Tap the <b>Binary</b> or <b>Hex</b> field and use the <b>A</b> and <b>B</b> knobs to select and change the values. Or double-tap on the field and use the virtual keypad to enter values.  Available when <b>Mark On</b> = <b>Address</b> .

## Mark On = Error

This table lists the menu fields displayed when **Mark On** is set to **Error**.

Field or control	Description
<b>Error</b>	Sets the error on which to search. Available when <b>Mark On</b> is <b>Error</b> .
<b>Error Type</b>	Sets the error type on which to search. Select the error type from the drop-down. Available error types are: <ul style="list-style-type: none"> <li>• OpCode</li> <li>• Device Type</li> <li>• Any</li> </ul> Available when <b>Mark On</b> is <b>Error</b> .

## See also

[Bus Trigger configuration](#) on page 561

[Bus Search configuration menus](#) on page 347

[MDIO serial bus configuration menu](#) on page 318

## MIL-STD-1553 serial bus search configuration menu

Use the MIL-STD-1553 Search configuration menu to define conditions to search for and mark on an MIL-STD-1553 bus waveform. You can have multiple searches on the same bus.

Field or control	Description
<b>Display</b>	Enables or disables displaying search marks on this search.
<b>Act on Event</b>	Tap the <b>Act on Event</b> button to configure the actions the instrument must take when a search event occurs. See <a href="#">Act On Event configuration menu</a> on page 178 for the available fields and controls.
<b>Search Type</b>	Set to <b>Bus</b> .
<b>Source</b>	Select the MIL-STD-1553 bus that you want to search.
<b>Mark On</b>	Select the type of information for which to search.
<b>Transmit/Receive Bit</b>	Sets the transmit or receive bit state for which to search. Only available when <b>Mark On</b> is <b>Command</b> .
<b>Mark when RT Address</b>	Sets the RT address condition for which to search. When set to <b>Inside Range</b> or <b>Outside Range</b> , fields are displayed to set a low and high address for the specified search range. Only available when <b>Mark On</b> is <b>Command</b> .
<b>Parity</b>	Sets the parity state for which to search. Only available when <b>Mark On</b> is <b>Command</b> .

Table continued...



Field or control	Description
<b>Address</b>	<p>Sets the address value for which to search.</p> <p>Tap the <b>Binary</b>, <b>Hex</b>, or <b>Decimal</b> field and use the <b>A</b> and <b>B</b> knobs to select and change the values. Or double-tap on the field and use the virtual keypad to enter values.</p> <p>Only available when <b>Mark On</b> is <b>Command</b>.</p>
<b>Low Address</b>	<p>Sets the low address value for which to search.</p> <p>Tap the <b>Binary</b>, <b>Hex</b>, or <b>Decimal</b> field and use the <b>A</b> and <b>B</b> knobs to select and change the values. Or double-tap on the field and use the virtual keypad to enter values.</p> <p>Only available when <b>Mark On</b> is <b>Command</b> and <b>Mark When RT Address</b> is <b>Inside Range</b> or <b>Outside Range</b>.</p>
<b>Subaddress/Mode</b>	<p>Sets the subaddress or mode value for which to search.</p> <p>Tap the <b>Binary</b>, <b>Hex</b>, or <b>Decimal</b> field and use the <b>A</b> and <b>B</b> knobs to select and change the values. Or double-tap on the field and use the virtual keypad to enter values.</p> <p>Only available when <b>Mark On</b> is <b>Command</b> and <b>Mark When RT Address</b> is <b>Inside Range</b> or <b>Outside Range</b>.</p>
<b>High Address</b>	<p>Sets the high address value for which to search.</p> <p>Tap the <b>Binary</b>, <b>Hex</b>, or <b>Decimal</b> field and use the <b>A</b> and <b>B</b> knobs to select and change the values. Or double-tap on the field and use the virtual keypad to enter values.</p> <p>Only available when <b>Mark On</b> is <b>Command</b> and <b>Mark When RT Address</b> is <b>Inside Range</b> or <b>Outside Range</b>.</p>
<b>Word Count/Mode Count</b>	<p>Sets the word count or mode count value for which to search.</p> <p>Tap the <b>Binary</b>, <b>Hex</b>, or <b>Decimal</b> field and use the <b>A</b> and <b>B</b> knobs to select and change the values. Or double-tap on the field and use the virtual keypad to enter values.</p> <p>Only available when <b>Mark On</b> is <b>Command</b> and <b>Mark When RT Address</b> is <b>Inside Range</b> or <b>Outside Range</b>.</p>
<b>Status Word Bits</b>	<p>Sets the status word pattern for which to search.</p> <p>Tap the field and use the <b>A</b> and <b>B</b> knobs to select and change the values. Selecting a bit shows a short description of that bit's function.</p> <p>Only available when <b>Mark On</b> is <b>Status</b> and <b>Mark When RT Address</b> is <b>Inside Range</b> or <b>Outside Range</b>.</p>
<b>Data</b>	<p>Sets the data pattern for which to search.</p> <p>Tap the <b>Binary</b>, <b>Hex</b>, or <b>Decimal</b> field and use the <b>A</b> and <b>B</b> knobs to select and change the values. Or double-tap on the field and use the virtual keypad to enter values.</p> <p>Available when <b>Mark On</b> is <b>Data</b>.</p>
<b>Error Type</b>	<p>Sets the error condition for which to search.</p> <p>Available when <b>Mark On</b> = <b>Error</b>.</p>
<b>Copy Trigger Settings to Search</b>	<p>Sets the search criteria to match the current oscilloscope trigger settings.</p>

Table continued...

Field or control	Description
Copy Search Settings to Trigger	Sets the current oscilloscope trigger settings to match the search criteria.

**See also**

[Bus Trigger configuration](#) on page 561

[Bus Search configuration menus](#) on page 347

[MIL-STD-1553 serial bus menu](#) on page 319

**NFC serial bus search configuration menu**

Use the NFC Search configuration menu to define conditions to search for and mark on an NFC bus waveform. You can have multiple searches on the same bus.

Field or control	Description
Display	Enables or disables displaying the search marks on this search.
Act on Event	Tap the <b>Act on Event</b> button to configure the actions the instrument must take when a search event occurs. See <a href="#">Act On Event configuration menu</a> on page 178 for the available fields and controls.
Search Type	Set to <b>Bus</b> .
Source	Select the <b>NFC</b> bus that you want to search.
Mark On	Select the type of information that you want to search. The mark on menu changes depending on the Standard selected in the NFC bus configuration menu.
Type	Set the type of packet to search on as <b>Command</b> or <b>Response</b> .
Data Bytes	Sets the number of data bytes to search (one to five bytes). Use the A knob to change the value.  The data bytes field is available for the Standard 15693 and 14443B in the NFC bus configuration menu.  Available when <b>Mark On</b> is <b>Data</b> in the NFC search configuration menu.
Data	Sets the data pattern to search. The number of bits shown depends on the Data Bytes setting. Tap the Binary or Hex field and use the A and B knobs to select the values. Or double-tap on the field and use the virtual keypad to enter the values.  The data field is available for the Standard 15693 and 14443B in the NFC bus configuration menu.  Available when <b>Mark On</b> is <b>Data</b> in the NFC search configuration menu.
UID	Sets the UID that you want to search. Tap a Binary or Hex field and use the A and B knobs to select the values. Or double-tap on the field and use the virtual keypad to enter the values.  The UID field is available for the Standard 15693 and 14443A in the NFC bus configuration menu.  Available when <b>Mark On</b> is <b>UID</b> .
Command Codes	Sets the command codes to search. The command codes menu changes depending on the Standard selected in the NFC bus configuration menu.  Available when <b>Mark On</b> is <b>Command code</b> and <b>Type</b> is <b>Command</b> .

Table continued...

Field or control	Description
<b>Response Codes</b>	Sets the response codes. The response codes field is available for the Standard 14443A, 14443B, and FeliCa in the NFC bus configuration menu. The response codes menu changes depending on the Standard selected in the NFC bus configuration menu.  Available when <b>Mark On</b> is <b>Response code</b> and <b>Type</b> is <b>Response</b> .
<b>Error Type</b>	Sets the error bytes that you want to search. The error type is CRC and cannot be edited for the Standards 15693, 14443B, and FeliCa. For Standard 14443A, set the type as Any, Parity, or CRC.  Available when <b>Mark On</b> is <b>Error</b> .
<b>Copy Trigger Settings to Search</b>	Sets the search criteria to match the current oscilloscope trigger settings.  NFC is currently not supported as a bus trigger source.
<b>Copy Search Settings to Trigger</b>	Sets the current oscilloscope trigger settings to match the search criteria.  NFC is currently not supported as a bus trigger source.

## See also

[Bus Trigger configuration](#) on page 561

[Bus Search configuration menus](#) on page 347

[NFC serial bus configuration menu](#) on page 320

## NRZ serial bus search configuration menu

Use the NRZ Search configuration menu to define conditions to search for and mark on a NRZ bus waveform. You can have multiple searches on the same bus.

Field or control	Description
<b>Display</b>	Enables or disables displaying search marks on this search.
<b>Act on Event</b>	Tap the <b>Act on Event</b> button to configure the actions the instrument must take when a search event occurs. See <a href="#">Act On Event configuration menu</a> on page 178 for the available fields and controls.
<b>Source</b>	Select the NRZ bus that you want to search.
<b>Mark On</b>	Select the type of information for which to search.
<b>Data Bytes</b>	Sets the number of data bytes for which to search (one to five bytes). Use the <b>A</b> knob to change the value.  Available only when <b>Mark On</b> is <b>Data</b> .
<b>Data</b>	Sets the data pattern for which to search. The number of bits shown depends on the <b>Data Bytes</b> setting.  Tap the <b>Binary</b> or <b>Hex</b> field and use the <b>A</b> and <b>B</b> knobs to select and change the values. Or double-tap on the field and use the virtual keypad to enter values.  Available only when <b>Mark On</b> is <b>Data</b> .
<b>Copy Trigger Settings to Search</b>	Sets the search criteria to match the current oscilloscope trigger settings.  NRZ is currently not supported as a bus trigger source.

Table continued...

Field or control	Description
Copy Search Settings to Trigger	Sets the current oscilloscope trigger settings to match the search criteria. NRZ is currently not supported as a bus trigger source.

**See also**

[Bus Trigger configuration](#) on page 561

[Bus Search configuration menus](#) on page 347

[NRZ serial bus configuration menu](#) on page 321

**Parallel bus search configuration menu**

Use the Parallel Search configuration menu to define conditions to search for and mark on an Parallel bus waveform. You can have multiple searches on the same bus.



**Note:** Parallel bus search is standard on all instruments.

Field or control	Description
Display	Enables or disables displaying search marks on this search.
Act on Event	Tap the <b>Act on Event</b> button to configure the actions the instrument must take when a search event occurs. See <a href="#">Act On Event configuration menu</a> on page 178 for the available fields and controls.
Search Type	Set to <b>Bus</b> .
Source	Select the parallel bus that you want to search.
Data	Sets the data pattern for which to search. The number of bits shown depends on how the parallel bus is defined.  Tap the <b>Binary</b> or <b>Hex</b> field and use the <b>A</b> and <b>B</b> knobs to select and change the values. Or double-tap on the field and use the virtual keypad to enter values.
A, B knob controls	Use the <b>A</b> knob to select (highlight) the digit(s) to change.  Use the <b>B</b> knob to change the value of the digit(s).
Copy Trigger Settings to Search	Sets the search criteria to match the current oscilloscope trigger settings.
Copy Search Settings to Trigger	Sets the current oscilloscope trigger settings to match the search criteria.

**See also**

[Bus Trigger configuration](#) on page 561

[Bus Search configuration menus](#) on page 347

[Parallel Bus configuration menu](#) on page 322

## PSI5 serial bus search configuration menu

Use the PSI5 Search configuration menu to define conditions to search for and mark on an PSI5 bus waveform. You can have multiple searches on the same bus.

**Table 11: PSI5 search menu, fields and controls**

Field or control	Description
<b>Display</b>	Enables or disables displaying search marks for this search.
<b>Act on Event</b>	Tap the <b>Act on Event</b> button to configure the actions the instrument must take when a search event occurs. See <a href="#">Act On Event configuration menu</a> on page 178 for the available fields and controls.
<b>Search Type</b>	Set to <b>Bus</b> .
<b>Source</b>	Select the PSI5 bus that you want to search.
<b>Mark On</b>	<p>Sets the type of information for which to search. If the selected search type requires more input, the menu updates to show additional fields.</p> <p>See the following <b>Mark On</b> tables for the menu fields associated with specific <b>Mark On</b> settings.</p> <p>When <b>Direction</b> is <b>ECU to Sensor</b>, the available settings are:</p> <ul style="list-style-type: none"> <li>• Start</li> <li>• Data</li> <li>• Function Code</li> <li>• Sensor Address</li> <li>• Register Address</li> <li>• CRC Error</li> </ul> <p>When <b>Direction</b> is <b>Sensor to ECU</b>, the available settings are:</p> <ul style="list-style-type: none"> <li>• Start</li> <li>• Status</li> </ul> <p>Available when the status bit is configured in bus configuration.</p> <ul style="list-style-type: none"> <li>• Data</li> <li>• Block ID</li> <li>• Sensor Status</li> <li>• Error</li> </ul>
<b>Copy Trigger Settings to Search</b>	<p>Sets the search criteria to match the current oscilloscope trigger settings.</p> <p>PSI5 is currently not supported as a bus trigger source.</p>
<b>Copy Search Settings to Trigger</b>	<p>Sets the current oscilloscope trigger settings to match the search criteria.</p> <p>PSI5 is currently not supported as a bus trigger source.</p>

### Mark On = Start

This table lists the menu fields displayed when **Mark On** is set to **Start**.

Field or control	Description
<b>Start</b>	<p>Sets the search to mark <b>Start</b> events. A <b>Start</b> event occurs with two zeros when direction is from sensor to ECU.</p> <p>When direction is from ECU to sensor, Start event occurs with 011111110 when sync mode is pulse width, and 010 when sync mode is tooth gap.</p> <p>When direction is from Sensor to ECU, Start event occurs with 00.</p> <p>There are no menu fields or controls displayed when this item is selected.</p> <p>When <b>Direction = ECU to Sensor</b> and <b>Direction = ECU to Sensor</b>.</p>

### Mark On = Data

This table lists the menu fields displayed when **Mark On** is set to **Data**.

Field or control	Description
<b>Data Bits</b>	When sync mode is tooth gap, data bits are 4 and 8 bits. When sync mode is pulse width data bits are 4 , 8 and 20
<b>Data</b>	<p>Sets the search to mark events that meet the specified data value.</p> <p>For Sensor to ECU, it displays Region A. If the Data B field is configured Bus configuration, displays Region B as data search option.</p> <p>For ECU to Sensor, data search displays Data Bits and Value. In configuration Sync mode is Tooth Gap, the number of data bits is 4 and 8. In configuration Sync Mode is Pulse Width, the data bits are 4, 8, and 20.</p> <p>Tap the <b>Binary</b> or <b>Hex</b> field and use the <b>A</b> and <b>B</b> knobs to select and change the values. Or double-tap on the field and use the virtual keypad to enter values.</p> <p>Only available when <b>Mark On = Data</b> and <b>Direction = ECU to Sensor</b>.</p>

### On = Function Code

This table lists the menu fields displayed when **Mark On** is set to **Function Code**.

Field or control	Description
<b>Function Code</b>	<p>Sets the search to mark events that meet the specified data value.</p> <p>Tap the <b>Binary</b> or <b>Hex</b> field and use the <b>A</b> and <b>B</b> knobs to select and change the values. Or double-tap on the field and use the virtual keypad to enter values.</p> <p>Only available when <b>Mark On = Function Code</b> and <b>Direction = ECU to Sensor</b>.</p>

### Mark On = Sensor Address

This table lists the menu fields displayed when **Mark On** is set to **Sensor Address**.

Field or control	Description
<b>Address</b>	<p>Sets the sensor address value for which to search.</p> <p>Tap the <b>Binary</b> or <b>Hex</b> field and use the <b>A</b> and <b>B</b> knobs to select and change the values. Or double-tap on the field and use the virtual keypad to enter values.</p> <p>Only available when <b>Mark On = Sensor Address</b> and <b>Direction = ECU to Sensor</b>.</p>

### Mark On = Register Address

This table lists the menu fields displayed when **Mark On** is set to **Register Address**.

Field or control	Description
<b>No. of Bits</b>	<ul style="list-style-type: none"> <li>• 2-Bit</li> <li>• 6-Bit</li> <li>• 8-Bit</li> </ul> <p>Only available when <b>Mark On = Register Address</b> and <b>Direction = ECU to Sensor</b>.</p>
<b>Register Address</b>	<p>Sets the register address value for which to search.</p> <p>Tap the <b>Binary</b> or <b>Hex</b> field and use the <b>A</b> and <b>B</b> knobs to select and change the values. Or double-tap on the field and use the virtual keypad to enter values.</p> <p>Only available when <b>Mark On = Register Address</b> and <b>Direction = ECU to Sensor</b>.</p>

### Mark On = CRC Error

This table lists the menu fields displayed when **Mark On** is set to **CRC Error**.

Field or control	Description
<b>CRC Error</b>	<p>Sets the search to mark <b>CRC Error</b> events.</p> <p>Tap the <b>Binary</b> or <b>Hex</b> field and use the <b>A</b> and <b>B</b> knobs to select and change the values. Or double-tap on the field and use the virtual keypad to enter values.</p> <p>Only available when <b>Mark On = CRC Error</b> and <b>Direction = ECU to Sensor</b>.</p>

### Mark On = Sensor Status

This table lists the menu fields displayed when **Mark On** is set to **Sensor Status**.

Field or control	Description
<b>Type</b>	<p>Sets the search to mark events that meet the specified type.</p> <p>Available options are <b>Sensor Ready</b>, <b>Sensor Busy</b>, <b>Sensor Defect</b>, <b>Sensor Unlocked</b>, and <b>Service Mode</b>.</p> <p>Only available when <b>Mark On = Sensor Status</b> and <b>Direction = Sensor to ECU</b>.</p>

### Mark On = Block ID

This table lists the menu fields displayed when **Mark On** is set to **Block ID**.

Field or control	Description
CRC Error	<p>Sets the search to mark <b>Block ID</b> events.</p> <p>Tap the <b>Binary</b> or <b>Hex</b> field and use the <b>A</b> and <b>B</b> knobs to select and change the values. Or double-tap on the field and use the virtual keypad to enter values.</p> <p>Only available when <b>Mark On = Block ID</b> and <b>Direction = Sensor to ECU</b>.</p>

### Mark On = Status

This table lists the menu fields displayed when **Mark On** is set to **Status**.

Field or control	Description
CRC Error	<p>Sets the search to mark <b>Status</b> events.</p> <p>Tap the <b>Binary</b> or <b>Hex</b> field and use the <b>A</b> and <b>B</b> knobs to select and change the values. Or double-tap on the field and use the virtual keypad to enter values.</p> <p>Only available when <b>Mark On = Status</b> and <b>Direction = Sensor to ECU</b>.</p>

### Mark On = Error

This table lists the menu fields displayed when **Mark On** is set to **Error**.

Field or control	Description
Error	<p>Sets the search to mark <b>Error</b> type.</p> <p>Available error types are <b>Any</b>, <b>Parity</b>, <b>CRC</b>, and <b>Response Code</b>.</p> <p>Only available when <b>Mark On = Error</b> and <b>Direction = Sensor to ECU</b>.</p>

### See also

[Bus Trigger configuration](#) on page 561

[Bus Search configuration menus](#) on page 347

[PSI5 serial bus configuration menu](#) on page 324

## RS-232 serial bus search configuration menu

Use the RS-232 Search configuration menu to define conditions to search for and mark on an RS-232 bus waveform. You can have multiple searches on the same bus.

Field or control	Description
Display	Enables or disables displaying search marks on this search.
Act on Event	Tap the <b>Act on Event</b> button to configure the actions the instrument must take when a search event occurs. See <a href="#">Act On Event configuration menu</a> on page 178 for the available fields and controls.
Search Type	Set to <b>Bus</b> .
Source	Select the RS232 bus that you want to search.
Mark When	Select the type of information for which to search.

Table continued...



Field or control	Description
<b>Data Bytes</b>	Sets the number of data bytes (1 byte = 8 bits) for which to search (one to ten bytes). Use the <b>A</b> knob to change the value.  Available when <b>Mark When</b> is <b>Data</b> .
<b>Data</b>	Sets the data pattern for which to search. The number of bits shown depends on the <b>Data Words</b> setting.  Tap the <b>Binary</b> or <b>Hex</b> field and use the <b>A</b> and <b>B</b> knobs to select and change the values. Or double-tap on the field and use the virtual keypad to enter values.  Available when <b>Mark When</b> is <b>Data</b> .
<b>A, B knob controls</b>	Use the <b>A</b> knob to select (highlight) the digit(s) to change.  Use the <b>B</b> knob to change the value of the digit(s).
<b>Copy Trigger Settings to Search</b>	Sets the search criteria to match the current oscilloscope trigger settings.
<b>Copy Search Settings to Trigger</b>	Sets the current oscilloscope trigger settings to match the search criteria.

### See also

[Bus Trigger configuration](#) on page 561

[Bus Search configuration menus](#) on page 347

[RS232 serial bus menu](#) on page 326

## SDLC serial bus search configuration menu

Use SDLC search bus configuration to operate on point-to-point, multipoint or loop facilities on switched/dedicated, two/four-wire circuits with full-duplex or half-duplex operation.

Field	Description
<b>Display</b>	Turns On or Off.  Displays the decode bus on the waveform view, when the <b>Display</b> is set to <b>On</b> .
<b>Act on Event</b>	Tap the <b>Act on Event</b> button to configure actions, the instrument must take when a search event occurs. See <a href="#">Act On Event configuration menu</a> on page 178 for the available fields and controls.
<b>Search Type</b>	Set to <b>Bus</b> .
<b>Source</b>	Select the Bus 1 (SDLC) from the drop-down.
<b>Copy Trigger Settings to Search</b>	Sets the search criteria to match the current oscilloscope trigger settings.
<b>Copy Search Settings to Trigger</b>	Sets the current oscilloscope trigger settings to match the search criteria.
<b>Mark On</b>	Sets the type of information to search and mark on the bus waveform acquisition.
<b>Start</b>	Start is a flag event, which starts the transmission frame.  Available when <b>Mark On</b> is <b>Start</b> .

Table continued...

Field	Description
<b>Data</b>	<p>Sets the data pattern.</p> <p>Tap the <b>Binary</b> and <b>Hex</b> field and use the <b>A</b> and <b>B</b> knobs to select and change the values. Or double-tap on the field and use the virtual keypad to enter values.</p> <p>Available when <b>Mark On</b> is <b>Data</b>.</p>
<b>Data Bytes</b>	<p>Sets the number of client data bytes (one to five bytes). Use the <b>A</b> knob to change the value.</p> <p>Available when <b>Mark On</b> is <b>Data</b>.</p>
<b>Address</b>	<p>Sets the address value.</p> <p>Tap the <b>Binary</b> and <b>Hex</b> field, use the <b>A</b> and <b>B</b> knobs to select and change the values. Or double-tap on the field and use the virtual keypad to enter the values.</p> <p>Available when <b>Mark On</b> is <b>Address</b>. Default selection is <b>Broadcast Address</b> .</p>
<b>Broadcast</b>	<p>Sets the broadcast address (also called as all-stations address). An address field of all 1's is reserved for the broadcast address only.</p> <p>Available when <b>Mark On</b> is <b>Address</b>.</p>
<b>No Station</b>	<p>Sets an all 0's address field and is reserved as a "no station's address".</p> <p>Available when <b>Mark On</b> is <b>Address</b>.</p>
<b>Station Address</b>	<p>Sets its own individual address; a station address.</p> <p>Available when <b>Mark On</b> is <b>Address</b>.</p>
<b>Type</b>	<p>Search for various frames.</p> <p>Additionally <b>Unnumbered</b> frame has <b>Type</b> to set <b>Command</b>, <b>Response</b>, and <b>Both</b>.</p> <p>Available when <b>Mark On</b> is <b>Unnumbered</b>.</p>
<b>Unnumbered Poll</b>	<p>Search an optional response poll is sent by the primary station to poll one station, a group of stations, or all the stations on the loop.</p> <p>Available when <b>Mark On</b> is <b>Unnumbered</b> and <b>Type</b> is <b>Command</b>.</p>
<b>Set Normal Response Mode</b>	<p>This command place the secondary station in Normal Response Mode (NRM) for information transfer.</p> <p>Available when <b>Mark On</b> is <b>Unnumbered</b> and <b>Type</b> is <b>Command</b>.</p>
<b>Set Normal Response Mode Extended</b>	<p>This command place the secondary station in Normal Response Mode (NRM) or Normal Response Mode Extended (NRME) for information transfer.</p> <p>Available when <b>Mark On</b> is <b>Unnumbered</b> and <b>Type</b> is <b>Command</b>.</p>
<b>Unnumbered Acknowledgement</b>	<p>This is the affirmative response to <b>Set Normal Response Mode</b>, <b>Disconnect Mode</b> or <b>Set Initialisation Mode</b> command.</p> <p>Available when <b>Mark On</b> is <b>Unnumbered</b> and <b>Type</b> is <b>Response</b>.</p>
<b>Disconnect Mode</b>	<p>Terminates other modes and place the receiving (secondary) station to disconnected mode.</p> <p>Available when <b>Mark On</b> is <b>Unnumbered</b> and <b>Type</b> is <b>Response</b>.</p>

Table continued...

Field	Description
<b>Frame Reject</b>	This response is transmitted by a secondary station in normal response mode, when it receives an invalid frame. Available when <b>Mark On</b> is <b>Unnumbered</b> and <b>Type</b> is <b>Response</b> .
<b>Beacon</b>	Beacon transmits the response, when the secondary station detects the loss of communication at its input. Available when <b>Mark On</b> is <b>Unnumbered</b> and <b>Type</b> is <b>Response</b> .
<b>Unnumbered information</b>	As a command or a response is used for transmitting unnumbered information. Available when <b>Mark On</b> is <b>Unnumbered</b> and <b>Type</b> is <b>Both</b> .
<b>Set or Request Initialisation Mode</b>	This command initiates system specified procedures for initialising link-level functions. Available when <b>Mark On</b> is <b>Unnumbered</b> and <b>Type</b> is <b>Both</b> .
<b>Disconnect or Request Disconnect</b>	This request is sent by a secondary station desired to be disconnected (by the disconnect command). Available when <b>Mark On</b> is <b>Unnumbered</b> and <b>Type</b> is <b>Both</b> .
<b>Disconnect Mode</b>	This response is transmitted by the secondary station to indicate that it is in the disconnected mode. Available when <b>Mark On</b> is <b>Unnumbered</b> and <b>Type</b> is <b>Both</b> .
<b>Test</b>	As a command, a test frame may sent to a secondary station in any mode to solicit a <b>Test</b> response. Available when <b>Mark On</b> is <b>Unnumbered</b> and <b>Type</b> is <b>Both</b> .
<b>Exchange station Identification</b>	As a command, <b>Exchange station Identification</b> solicits the identification of the receiving (secondary) station. An information field may be included in the frame to identify the transmitting (primary) station. Available when <b>Mark On</b> is <b>Unnumbered</b> and <b>Type</b> is <b>Both</b> .
<b>Configure</b>	The configure command contains a function descriptor (a subcommand) in a single-byte information field. Available when <b>Mark On</b> is <b>Unnumbered</b> and <b>Type</b> is <b>Both</b> .
<b>Receive Ready Frame</b>	Sent by either a primary or secondary station, <b>Receive Ready Frame</b> confirms numbered frames through Nr-1 and indicates that the originating station is ready to receive. Available when <b>Mark On</b> is <b>Supervisory</b> .
<b>Receive Not Ready Frame</b>	Sent by either a primary or secondary station, <b>Receive Not Ready Frame</b> indicates a temporarily busy condition due to buffering or other internal constraints. Available when <b>Mark On</b> is <b>Supervisory</b> .
<b>Reject Frame</b>	This command/response may transmitted either to request transmission or retransmission of numbered information frames. <b>Reject Frame</b> confirms frames through Nr-1 and requests the retransmission of numbered information frames starting at Nr contained in the <b>Reject Frame</b> . Available when <b>Mark On</b> is <b>Supervisory</b> .
<b>FCS</b>	FCS (Field Check sequence) used for Cyclic redundancy check. Available when <b>Mark On</b> is <b>Errors</b> .

Table continued...

Field	Description
Out of Numeric Order	Search <b>Reject Frame</b> status field for Z=1. Available when <b>Mark On</b> is <b>Errors</b> .
End	End is a flag event, which ends the transmission frame. Available when <b>Mark On</b> is <b>End</b> .

## SENT serial bus search configuration menu

Use the SENT Search configuration menu to define conditions to search for and mark on an SENT bus waveform. You can have multiple searches on the same bus.

Field or control	Description
Display	Enables or disables displaying search marks on this search.
Act on Event	Tap the <b>Act on Event</b> button to configure the actions the instrument must take when a search event occurs. See <a href="#">Act On Event configuration menu</a> on page 178 for the available fields and controls.
Search Type	Set to <b>Bus</b> .
Source	Select the <b>SENT</b> bus that you want to search.
Mark On	Select the type of information for which to search.
Channel	Sets the SENT channel type for which to search. Available when <b>Mark On</b> is <b>Start of Packet</b> .
Status / Communications	Sets the value of the status/communications nibble for which to search. Tap the <b>Binary</b> or <b>Hex</b> field and use the <b>A</b> and <b>B</b> knobs to select and change the values. Or double-tap on the field and use the virtual keypad to enter values. Available when <b>Mark On</b> is <b>Fast Channel</b> .
Fast Channel 1	Sets the condition and value of the fast channel 1 data for which to search. Tap the down arrow and select the condition for which to search (=, ≠, >, <, ≥, ≤). The default is =. Tap the <b>Binary</b> or <b>Hex</b> field and use the <b>A</b> and <b>B</b> knobs to select and change the values. Or double-tap on the field and use the virtual keypad to enter values. Available when <b>Mark On</b> is <b>Fast Channel</b> .
Fast Channel 2	Sets the condition and value of the fast channel 2 data for which to search. Tap the down arrow and select the condition for which to search (=, ≠, >, <, ≥, ≤). The default is =. Tap the <b>Binary</b> or <b>Hex</b> field and use the <b>A</b> and <b>B</b> knobs to select and change the values. Or double-tap on the field and use the virtual keypad to enter values. Available when <b>Mark On</b> is <b>Fast Channel</b> .

Table continued...

Field or control	Description
<b>Counter</b>	<p>Sets the condition and value of the counter data for which to search.</p> <p>Tap the down arrow and select the condition for which to search (<math>=</math>, <math>\neq</math>, <math>&gt;</math>, <math>&lt;</math>, <math>\geq</math>, <math>\leq</math>). The default is <math>=</math>.</p> <p>Tap the <b>Binary</b> or <b>Hex</b> field and use the <b>A</b> and <b>B</b> knobs to select and change the values. Or double-tap on the field and use the virtual keypad to enter values.</p> <p>Available when <b>Mark On</b> is <b>Fast Channel</b>.</p>
<b>Inverted Nibble</b>	<p>Sets the value of the inverted nibble data for which to search.</p> <p>Tap the <b>Binary</b> or <b>Hex</b> field and use the <b>A</b> and <b>B</b> knobs to select and change the values. Or double-tap on the field and use the virtual keypad to enter values.</p> <p>Available when <b>Mark On</b> is <b>Fast Channel</b>.</p>
<b>Message ID</b>	<p>Sets the value of the message ID data for which to search.</p> <p>Available when <b>Mark On</b> is <b>Slow Channel</b>.</p>
<b>Data</b>	<p>Sets the condition and value of the slow channel data for which to search.</p> <p>Tap the down arrow and select the condition for which to search (<math>=</math>, <math>\neq</math>, <math>&gt;</math>, <math>&lt;</math>, <math>\geq</math>, <math>\leq</math>). The default is <math>=</math>.</p> <p>Tap the <b>Binary</b> or <b>Hex</b> field and use the <b>A</b> and <b>B</b> knobs to select and change the values. Or double-tap on the field and use the virtual keypad to enter values.</p> <p>Available when <b>Mark On</b> is <b>Slow Channel</b>.</p>
<b>Mark When</b>	<p>Sets the mark when condition.</p> <p>Tap the down arrow and select the condition for which to search (<math>=</math>, <math>\neq</math>, <math>&gt;</math>, <math>&lt;</math>, <math>\geq</math>, <math>\leq</math>, <b>Inside Range</b>, <b>Outside Range</b>). The default is <math>=</math>.</p> <p>When set to <b>Inside Range</b> or <b>Outside Range</b>, fields are displayed to set high and low boundary values for the number of clock ticks for which to mark.</p> <p>Available when <b>Mark On</b> is <b>Pause Pulse</b>.</p>
<b>Number of Ticks</b>	<p>Sets the number of Pause Pulse ticks for which to search.</p> <p>Tap the <b>Ticks High</b> or <b>Tick Low</b> field and use the <b>A</b> and <b>B</b> knobs to set the values.</p> <p>Available when <b>Mark On</b> is <b>Pause Pulse</b> and <b>Mark When</b> is set to <math>=</math>, <math>\neq</math>, <math>&gt;</math>, <math>&lt;</math>, <math>\geq</math>, or <math>\leq</math>.</p>
<b>Ticks High, Ticks Low)</b>	<p>Sets the highest and lowest values for the range of Pause Pulse ticks for which to search.</p> <p>Tap the <b>Ticks High</b> or <b>Tick Low</b> field and use the <b>A</b> and <b>B</b> knobs to set the values.</p> <p>Available when <b>Mark On</b> is <b>Pause Pulse</b> and <b>Mark When</b> is <b>Inside Range</b> or <b>Outside Range</b>.</p>
<b>Error Type</b>	<p>Sets the error type for which to search. Tap the arrow and select the error condition.</p> <p>Available when <b>Mark On</b> is <b>Error</b>.</p>
<b>CRC Type</b>	<p>Sets the CRC error type for which to search.</p> <p>Available when <b>Mark On</b> is <b>Error</b> and <b>Error Type</b> is <b>CRC</b>.</p>
<b>Copy Trigger Settings to Search</b>	<p>Sets the search criteria to match the current oscilloscope trigger settings.</p>

Table continued...

Field or control	Description
Copy Search Settings to Trigger	Sets the current oscilloscope trigger settings to match the search criteria.

**See also**

[Bus Trigger configuration](#) on page 561

[Bus Search configuration menus](#) on page 347

[SENT serial bus configuration menu](#) on page 328

**SMBus serial bus search configuration menu**

Use the SMBus Search configuration menu to define conditions to search for and mark on an SMBus bus waveform. You can have multiple searches on the same bus.

Field or control	Description
Display	Enables or disables displaying the search marks on this search.
Act on Event	Tap the <b>Act on Event</b> button to configure the actions the instrument must take when a search event occurs. See <a href="#">Act On Event configuration menu</a> on page 178 for the available fields and controls.
Search Type	Set to <b>Bus</b> .
Source	Select the <b>SMBus</b> bus that you want to search.
Mark On	Select the type of information that you want to search.
Start	Select to search on the start events.
Repeated Start	Select to search on the repeated start events.
Address	Sets the 7-bit address pattern that you want to search.  Tap the <b>Binary</b> or <b>Hex</b> field and use the <b>A</b> and <b>B</b> knobs to select and change the values. Or double-tap on the field and use the virtual keypad to enter values.  Available only when <b>Mark On</b> is <b>Address</b>
Host Address	Select to search on the host address.  Available only when <b>Mark On</b> is <b>Host Address</b> .
Device Address	Set the 7-bit device address that you want to search.  Tap the <b>Binary</b> or <b>Hex</b> field and use the <b>A</b> and <b>B</b> knobs to select and change the values. Or double-tap on the field and use the virtual keypad to enter values.  Available only when <b>Mark On</b> is <b>Device Address</b>
Command Code	Sets the 8-bit command code that you want to search.  Tap the <b>Binary</b> or <b>Hex</b> field and use the <b>A</b> and <b>B</b> knobs to select and change the values. Or double-tap on the field and use the virtual keypad to enter values.  Available only when <b>Mark On</b> is <b>Command Code</b>

Table continued...

Field or control	Description
<b>Data</b>	<p>Sets the data pattern that you want to search.</p> <p>Tap the <b>Binary</b> or <b>Hex</b> field and use the <b>A</b> and <b>B</b> knobs to select and change the values. Or double-tap on the field and use the virtual keypad to enter values.</p> <p>Available only when <b>Mark On</b> is <b>Data</b>.</p>
<b>Data Bytes</b>	<p>Sets the number of data bytes that you want to search (one to eight bytes). Use the <b>A</b> knob to change the value.</p> <p>Available only when <b>Mark On</b> is <b>Data</b>.</p>
<b>Field Bytes</b>	<p>Sets the field bytes as 1, 2, or 4.</p> <p>Available only when <b>Mark On</b> is <b>UDID Data</b>.</p>
<b>UDID Data</b>	<p>Sets the UDID data that you want to search.</p> <p>Tap a <b>Binary</b> or <b>Hex</b> field and use the <b>A</b> and <b>B</b> knobs to select and change the values. Or double-tap on the field and use the virtual keypad to enter values.</p> <p>Available only when <b>Mark On</b> is <b>UDID Data</b>.</p>
<b>Error Type</b>	<p>Sets the error bytes that you want to search. You can search on ANY, ACK, NACK, and PEC errors.</p> <p>Available only when <b>Mark On</b> is <b>Error</b>.</p> <p>PEC error search is available only when the <b>PEC Byte</b> in SMBus bus configuration is set as True.</p>
<b>Stop</b>	Select to search on the stop events.
<b>Idle</b>	Select to search on the idle events.
<b>Copy Trigger Settings to Search</b>	<p>Sets the search criteria to match the current oscilloscope trigger settings.</p> <p>SMBus is currently not supported as a bus trigger source.</p>
<b>Copy Search Settings to Trigger</b>	<p>Sets the current oscilloscope trigger settings to match the search criteria.</p> <p>SMBus is currently not supported as a bus trigger source.</p>

## See also

[Bus Trigger configuration](#) on page 561

[Bus Search configuration menus](#) on page 347

[SMBus serial bus configuration menu](#) on page 329

## SPI serial bus search configuration menu

Use the SPI Search configuration menu to define conditions to search for and mark on an SPI bus waveform. You can have multiple searches on the same bus.

Field or control	Description
<b>Display</b>	Enables or disables displaying search marks on this search.
<b>Act on Event</b>	Tap the <b>Act on Event</b> button to configure the actions the instrument must take when a search event occurs. See <a href="#">Act On Event configuration menu</a> on page 178 for the available fields and controls.

Table continued...

Field or control	Description
<b>Search Type</b>	Set to <b>Bus</b> .
<b>Source</b>	Select the SPI bus that you want to search.
<b>Mark On</b>	Select the type of information for which to search.
<b>Search Source</b>	Set the search source. Set either MOSI or MISO. Available when <b>Mark On</b> is <b>SS Active</b> .
<b>Data Words</b>	Sets the number of data words defined based on the word size in bus configuration. If the word size in bus configuration is 4, then data words will go to 32. Maximum data words is word size $\leq 128$ . Available when <b>Mark On</b> is <b>Data</b> .
<b>Data</b>	Sets the data pattern for which to search. The number of bits shown depends on the <b>Data Words</b> setting. Tap the <b>Binary</b> or <b>Hex</b> field and use the <b>A</b> and <b>B</b> knobs to select and change the values. Or double-tap on the field and use the virtual keypad to enter values. Available when <b>Mark On</b> is <b>Data</b> .
<b>A, B knob controls</b>	Use the <b>A</b> knob to select (highlight) the digit(s) to change. Use the <b>B</b> knob to change the value of the digit(s).
<b>Copy Trigger Settings to Search</b>	Sets the search criteria to match the current oscilloscope trigger settings.
<b>Copy Search Settings to Trigger</b>	Sets the current oscilloscope trigger settings to match the search criteria.

**See also**

[Bus Trigger configuration](#) on page 561

[Bus Search configuration menus](#) on page 347

[SPI serial bus configuration menu](#) on page 331

**SPMI serial bus search configuration menu**

Use the SPMI Search configuration menu to define conditions for which you want to search and mark on an SPMI bus signal. You can have multiple searches on the same bus.

Field or control	Description
<b>Display</b>	Enables or disables displaying marks from this search on the bus waveform.
<b>Act on Event</b>	Tap the <b>Act on Event</b> button to configure the actions the instrument must take when a search event occurs. See <a href="#">Act On Event configuration menu</a> on page 178 for the available fields and controls.
<b>Search Type</b>	Set to <b>Bus</b> .
<b>Source</b>	Select the <b>SPMI</b> bus for which to search.
<b>Mark On</b>	Select the type of information for which to search.

Table continued...



Field or control	Description
<b>Slave Address</b>	<p>Sets the slave address value for which to search.</p> <p>Tap the <b>Binary</b> or <b>Hex</b> field and use the <b>A</b> and <b>B</b> knobs to select and change the values. Or double-tap on the field and use the virtual keypad to enter values.</p> <p>Available when <b>Mark On</b> is <b>Reset, Authenticate, Register Read, Register Write, Extended Register Read, Extended Register Write, Ext. Register Read Long, Ext. Register Write Long, DD Block Slave Read, or Register 0 Write.</b></p>
<b>Master Address</b>	<p>Sets the master address value for which to search.</p> <p>Tap the <b>Binary</b> or <b>Hex</b> field and use the <b>A</b> and <b>B</b> knobs to select and change the values. Or double-tap on the field and use the virtual keypad to enter values.</p> <p>Available when <b>Mark On</b> is <b>Master Read, Master Write, or DD Block Master Read.</b></p>
<b>Register Address</b>	<p>Sets the register address value for which to search.</p> <p>Tap the <b>Binary</b> or <b>Hex</b> field and use the <b>A</b> and <b>B</b> knobs to select and change the values. Or double-tap on the field and use the virtual keypad to enter values.</p> <p>Available when <b>Mark On</b> is <b>Master Read, Master Write, Register Read, Register Write, Extended Register Read, Extended Register Write, Ext. Register Read Long, or Ext. Register Write Long.</b></p>
<b>Data</b>	<p>Sets the data value for which to search.</p> <p>Tap the <b>Binary</b> or <b>Hex</b> field and use the <b>A</b> and <b>B</b> knobs to select and change the values. Or double-tap on the field and use the virtual keypad to enter values.</p> <p>Available when <b>Mark On</b> is <b>Master Read, Master Write, Register Read, Register Write, Extended Register Read, Extended Register Write, Ext. Register Read Long, Ext. Register Write Long, DD Block Master Read, DD Block Slave Read, or Register 0 Write.</b></p>
<b>Data Bytes</b>	<p>Sets the number of data bytes for which to search. Tap the field and use the <b>A</b> knob to change the value. Or double-tap on the field and use the virtual keypad to enter a value. Available when <b>Mark On</b> is <b>Extended Register Read, Extended Register Write, Ext. Register Read Long, or Ext. Register Write Long.</b></p>
<b>No Response</b>	<p>Sets to search on data that is all zeros (no response). All values in the Data field are set to zero and cannot be edited.</p> <p>Available when <b>Mark On</b> is <b>Master Read, Register Read, Extended Register Read, Ext. Register Read Long, DD Block Master Read, DD Block Slave Read, or Transfer Bus Ownership.</b></p>
<b>Copy Trigger Settings to Search</b>	<p>Sets the search criteria to match the current oscilloscope trigger settings.</p>
<b>Copy Search Settings to Trigger</b>	<p>Sets the current oscilloscope trigger settings to match the search criteria.</p>

## See also

[Bus Trigger configuration](#) on page 561

[Bus Search configuration menus](#) on page 347

[SPMI serial bus configuration menu](#) on page 333

## SpaceWire serial bus search configuration menu

Use the SpaceWire Search configuration menu to define conditions to search for and mark on a SpaceWire bus waveform. You can have multiple searches on the same bus.

Field or control	Description
<b>Display</b>	Enables or disables displaying search marks on this search.
<b>Act on Event</b>	Tap the <b>Act on Event</b> button to configure the actions the instrument must take when a search event occurs. See <a href="#">Act On Event configuration menu</a> on page 178 for the available fields and controls.
<b>Search Type</b>	Set to <b>Bus</b> .
<b>Source</b>	Select the SpaceWire bus that you want to search.
<b>Mark On</b>	Select the type of information for which to search.
<b>Control Code Type</b>	Sets the control code type ( <b>Null</b> or <b>Time Code</b> ) for which to search and mark on the waveform. Available only when <b>Mark On</b> is <b>Control Code</b> .
<b>Control Character Type</b>	Sets the control character type ( <b>Flow Control Token</b> , <b>Escape Code</b> , or <b>End Of Packet</b> ). Available only when <b>Mark On</b> is <b>Control Character</b> .
<b>Data Bytes</b>	Sets the number of data bytes for which to search (one to five bytes). Use the <b>A</b> knob to change the value. Available when <b>Mark On</b> is <b>Data</b> .
<b>Data</b>	Sets the data pattern for which to search. The number of bits shown depends on the <b>Data Bytes</b> setting. Tap the <b>Binary</b> or <b>Hex</b> field and use the <b>A</b> and <b>B</b> knobs to select and change the values. Or double-tap on the field and use the virtual keypad to enter values. Available when <b>Mark On</b> is <b>Data</b> .
<b>Errors</b>	Sets the error type ( <b>Error End of Packet</b> , <b>Escape</b> , or <b>Parity</b> ) for which to search and mark on the waveform. Available when <b>Mark On</b> is <b>Errors</b> .
<b>Time Code</b>	Sets the time code pattern for which to search. The number of bits searched is 6. Tap the <b>Binary</b> or <b>Hex</b> field and use the <b>A</b> and <b>B</b> knobs to select and change the values. Or double-tap on the field and use the virtual keypad to enter values. Available only when <b>Mark On</b> is <b>Control Code</b> and <b>Control Code Type</b> is <b>Time Code</b> .
<b>Copy Trigger Settings to Search</b>	Sets the search criteria to match the current oscilloscope trigger settings. SpaceWire is currently not supported as a bus trigger source.
<b>Copy Search Settings to Trigger</b>	Sets the current oscilloscope trigger settings to match the search criteria. SpaceWire is currently not supported as a bus trigger source.

### See also

[Bus Trigger configuration](#) on page 561

[Bus Search configuration menus](#) on page 347

[SpaceWire serial bus configuration menu](#) on page 330

## SVID serial bus search configuration menu

Use the SVID Search configuration menu to define the conditions to search for and mark on an SVID bus waveform. You can have multiple searches on the same bus.

**Table 12: SVID search menu, fields and controls**

Field or control	Description
<b>Display</b>	Enables or disables displaying search marks for this search.
<b>Act on Event</b>	Tap the <b>Act on Event</b> button to configure the actions the instrument must take when a search event occurs. See <a href="#">Act On Event configuration menu</a> on page 178 for the available fields and controls.
<b>Search Type</b>	Set to <b>Bus</b> .
<b>Source</b>	Select the SVID bus that you want to search.
<b>Mark On</b>	Sets the type of information for which to search. If the selected search type requires more input, the menu update shows additional fields.
<b>Start</b>	A <b>Start</b> event occurs when the SDA line transitions from a High to Low state while the SCL line remains High.
<b>Slave Address</b>	Sets the slave address value for which to search.  Tap the <b>Binary</b> or <b>Hex</b> field and use the <b>A</b> and <b>B</b> knobs to select and change the values. Or double-tap on the field and use the virtual keypad to enter values.  Available when <b>Mark On</b> is <b>Slave Address</b> .
<b>Command Type</b>	Sets the search to mark <b>Command</b> events.  Available Command Types are <b>Get</b> , <b>Set</b> , and <b>Optional</b> .  Available when <b>Mark On</b> is <b>Command</b> .
<b>Command Response</b>	Sets the command response. Available when <b>Mark On</b> is <b>Command</b> .  Following are the available command responses when <b>Version</b> is set to <b>Non VR14</b> in <a href="#">SVID serial bus configuration menu</a> . <ul style="list-style-type: none"> <li>For <b>Get</b>: GetReg.</li> <li>For <b>Set</b>: SetVID Fast, SetVID Slow, SetVID Decay, SetPS, SetRegAddr, and SetRegData.</li> <li>For <b>Optional</b>: Test Mode and SetWP.</li> </ul> Following are the available command responses when <b>Version</b> is set to <b>VR14</b> in <a href="#">SVID serial bus configuration menu</a> . <ul style="list-style-type: none"> <li>For <b>Get</b>: GetReg, GetRegVendor, GetRegTestCfg, GetRegPktRecent, GetRegPktAlert, GetRegPktBad, and GetRegVrEvent.</li> <li>For <b>Set</b>: SetVID Fast, SetVID Slow, SetVID Decay, SetPS, SetRegAddr, SetRegData, SetRegAddrVendor, SetRegDataVendor, SetRegAddrTestCfg, and SetRegDataTestCfg.</li> <li>For <b>Optional</b>: Test Mode and SetWP.</li> </ul>

Table continued...

Field or control	Description
<b>Mode</b>	Sets the mode of the payload for which to search. Available modes are <b>Master</b> , <b>Slave</b> , or <b>Either</b> . Available when <b>Mark On</b> is <b>Payload</b> .
<b>Data</b>	Sets the data for which to search for different modes.. Available when <b>Mark On</b> is <b>Payload</b> . Tap the <b>Binary</b> or <b>Hex</b> field and use the <b>A</b> and <b>B</b> knobs to select and change the values. Or double-tap on the field and use the virtual keypad to enter values.
<b>Errors</b>	Sets the search to mark events that meet the specified address for a Device or register location. The <b>Errors</b> sets the number of bits in the field. Tap the <b>Binary</b> field and use the <b>A</b> and <b>B</b> knobs to select and change the values. Or double-tap on the field and use the virtual keypad to enter values. Available when <b>Mark On</b> is <b>Errors</b> .
<b>Error Type</b>	Set the error type from the drop down. Available when <b>Mark On</b> is <b>Errors</b> . Available error types are Any, NACK, Reject, Mixed, and Parity.
<b>Copy Trigger Settings to Search</b>	Sets the search criteria to match the current oscilloscope trigger settings.
<b>Copy Search Settings to Trigger</b>	Sets the current oscilloscope trigger settings to match the search criteria.

**See also**

[Bus Trigger configuration](#) on page 561

[Bus Search configuration menus](#) on page 347

[SVID serial bus configuration menu](#) on page 334

**USB serial bus search configuration menu**

Use the USB Search configuration menu to define conditions to search for and mark on an USB bus waveform. You can have multiple searches on the same bus.

Field or control	Description
<b>Display</b>	Enables or disables displaying search marks on this search.
<b>Act on Event</b>	Tap the <b>Act on Event</b> button to configure the actions the instrument must take when a search event occurs. See <a href="#">Act On Event configuration menu</a> on page 178 for the available fields and controls.
<b>Search Type</b>	Set to <b>Bus</b> .
<b>Source</b>	Select the USB bus that you want to search.
<b>Mark On</b>	Select the type of information for which to search.
<b>Handshake Type</b>	Sets the handshake packet type for which to search. Available only when <b>Mark On</b> is <b>Handshake Packet</b> .

Table continued...

Field or control	Description
<b>Packet Type</b>	Sets the special packet type for which to search. Available only when <b>Mark On</b> is <b>Special Packet</b> .
<b>Error Type</b>	Sets the error type for which to search. Available only when <b>Mark On</b> is <b>Error</b> .
<b>Address</b>	Sets the token packet address pattern for which to search. Use in conjunction with the <b>Mark When</b> field to specify the exact search condition.  Tap the <b>Binary</b> , <b>Hex</b> , or <b>Decimal</b> field and use the <b>A</b> and <b>B</b> knobs to select and change the values. Or double-tap on the field and use the virtual keypad to enter values.  Available only when <b>Mark On</b> is <b>Token Packet</b> and <b>Token Type</b> is all except <b>SOF (0101)</b> .
<b>Token Type</b>	Sets the token packet type for which to search. Available only when <b>Mark On</b> is <b>Token Packet</b> .
<b>Endpoint</b>	Sets the token packet endpoint pattern for which to search. Use in conjunction with the <b>Mark When</b> field to specify the exact search condition. Tap the <b>Binary</b> , <b>Hex</b> , or <b>Decimal</b> field and use the <b>A</b> and <b>B</b> knobs to select and change the values. Or double-tap on the field and use the virtual keypad to enter values.  Available only when <b>Mark On</b> is <b>Token Packet</b> and <b>Token Type</b> is all except <b>SOF (0101)</b> .
<b>Frame Number</b>	Sets the frame number pattern for which to search. Use in conjunction with the <b>Mark When</b> field to specify the exact search condition.  Tap the <b>Binary</b> , <b>Hex</b> , or <b>Decimal</b> field and use the <b>A</b> and <b>B</b> knobs to select and change the values. Or double-tap on the field and use the virtual keypad to enter values.  Available only when <b>Mark On</b> is <b>Token Packet</b> and <b>Token Type</b> is <b>SOF (0101)</b> .
<b>Data Packet Type</b>	Sets the data packet type for which to search. Available only when <b>Mark On</b> is <b>Data Packet</b> .
<b>Data Bytes</b>	Sets the number of data bytes for which to search (one to sixteen bytes). Tap the field and use the <b>A</b> knob to change the value.  Available only when <b>Mark On</b> is <b>Data Packet</b> .
<b>Byte Offset</b>	Sets the byte offset (Don't Care or the number of bytes). Tap the field and use the <b>A</b> knob to change the value.  Available only when <b>Mark On</b> is <b>Data Packet</b> .
<b>Data</b>	Sets the data packet pattern for which to search. The number of bits shown depends on the Data Bytes setting. Use in conjunction with the <b>Mark When</b> field to specify the exact search condition.  Tap the <b>Binary</b> or <b>Hex</b> field and use the <b>A</b> and <b>B</b> knobs to select and change the values. Or double-tap on the field and use the virtual keypad to enter values.  Available only when <b>Mark On</b> is <b>Data Packet</b> .

Table continued...

Field or control	Description
<b>Mark When</b>	<p>Sets the mark when condition.</p> <p>When set to <b>Inside Range</b> or <b>Outside Range</b>, fields are displayed to set a high and low boundary pattern for the specified search range.</p> <p>Tap the <b>Binary</b> or <b>Hex</b> field and use the <b>A</b> and <b>B</b> knobs to select and change the values. Or double-tap on the field and use the virtual keypad to enter values.</p> <p>Available only when <b>Mark On</b> is <b>Token Packet</b> or <b>Data Packet</b>.</p>
<b>A, B knob controls</b>	<p>Use the <b>A</b> knob to select (highlight) the digit(s) to change.</p> <p>Use the <b>B</b> knob to change the value of the digit(s).</p>
<b>Copy Trigger Settings to Search</b>	Sets the search criteria to match the current oscilloscope trigger settings.
<b>Copy Search Settings to Trigger</b>	Sets the current oscilloscope trigger settings to match the search criteria.

**See also**

[Bus Trigger configuration](#) on page 561

[Bus Search configuration menus](#) on page 347

[USB serial bus configuration menu](#) on page 335

**Configure pattern editor**

Use the pattern editor keypad to configure the pattern for the data or custom. To open the pattern editor, double-tap inside a Data/Custom field that requires alphanumeric values.

**Data Pattern Editor**

**Table 13: Data Pattern Editor fields and controls**

Keys	Description
Entry field	Sets the Data and hex values (D-XX). D is the data and XX is the hex value which can be 0-9 and A-F.
0-9 and A-F	Sets the Hex value.
CLEAR	Clears all values from the input entry field.
Bksp	Deletes characters to the left of the insert text marker position.
Cancel	Cancel all the values from the input entry field.
Enter	Cancel all the values from the input entry field.

**Custom Pattern Editor**

**Table 14: Custom Pattern Editor fields and controls**

Keys	Description
NULL	Enters N in the input box.
FCT	Enters F in the input box.

Table continued...

Keys	Description
EOP	Enters EOP in the input box.
EEP	Enters EE in the input box.
T-XX	Sets the timecode and the hex values (T-XX). T is the Timecode and XX is the hex value which can be 0-9 and A-F.
D-XX	Sets the data and the hex values (T-XX). T is the data and XX is the hex value which can be 0-9 and A-F.
0-9 and A-F	Sets the Hex value.
CLEAR	Clears all values from the input entry field.
Bksp	Cancel all the values from the input entry field.
Cancel	Cancel all the values from the input entry field.
Enter	Cancel all the values from the input entry field.



**Note:** A minimum of two patterns and maximum of eight patterns can be added. Each pattern should be separated by a space.

## Edge Search configuration menu

Use the Edge search to mark when the specified edge condition occurs on an analog, digital, math, or reference waveform.

To create a new edge search:

1. Tap **Add New... Search**.
2. Set the **Search Type** to **Edge**.
3. Select the search **Source**.
4. Use the menu fields to set the search parameters.

To change the settings on an existing search, double-tap the search badge and make necessary changes.

## Edge Search configuration menu fields and controls

Field or control	Description
<b>Display</b>	Sets the display of the mark icons to either <b>On</b> or <b>Off</b> . If you have multiple searches defined, the control turns off just the marks for the selected search.
<b>Stop Acquisition if Event Found</b>	Stops input acquisition when the search event occurs. Default is not enabled.
<b>Search Type</b>	Set to <b>Edge</b> .
<b>Source</b>	Lists the source channel or waveform to use to trigger or search. Types that require multiple inputs will replace this control with a different source definition control.
<b>Level</b>	Sets the amplitude level that the signal must pass through to be considered a valid transition.
<b>Set to 50%</b>	Sets the threshold at 50% of the measured signal transition range. 50% is calculated as $(\text{Top} + \text{Bottom})/2$ .
<b>Slope</b>	Sets the signal transition direction to detect. (rising, falling, or either direction).
<b>Copy Trigger Settings to Search</b>	Sets the search criteria to match the current oscilloscope trigger settings.

Table continued...

Field or control	Description
<b>Copy Search Settings to Trigger</b>	Sets the current oscilloscope trigger settings to match the search criteria.

### Other search types

- [Bus Search configuration menus](#) on page 347
- [Logic search configuration menu](#) on page 420
- [Pulse Width Search configuration menu](#) on page 422
- [Rise/Fall Time Search configuration menu](#) on page 424
- [Runt Search configuration menu](#) on page 425
- [Setup and Hold Search configuration menu](#) on page 426
- [Timeout Search configuration menu](#) on page 428
- [Window Search configuration menu](#) on page 429
- [DDR Read Search configuration menu](#) on page 431
- [DDR Write Search configuration menu](#) on page 432
- [DDR Read & Write Search configuration menu](#) on page 434

### Logic search configuration menu

Use the Logic search to mark when specified logic conditions occur on an analog, digital, math, or reference waveform.

To create a new logic search:

1. Tap **Add New... Search**.
2. Set the **Search Type** to **Logic**.
3. Use the menu fields to set the search parameters.

To change the settings on an existing search, double-tap the search badge and make necessary changes.

### Logic Search configuration menu fields and controls

Field or control	Description
<b>Display</b>	Sets the display of the mark icons to either <b>On</b> or <b>Off</b> . If you have multiple searches defined, the control turns off just the marks for the selected search.
<b>Stop Acquisition if Event Found</b>	Stops input acquisition when the search event occurs. Default is not enabled.
<b>Search Type</b>	Set to <b>Logic</b> .
<b>Use Clock Edge?</b>	Enables or disables finding logic patterns that occur on the specified clock edge. Yes places marks on the clock waveform wherever the logic pattern occurs. No places marks on the input signal waveform(s) wherever the logic pattern occurs.
<b>Logic Pattern: Define Inputs</b>	Opens the Logic Search-Define Inputs configuration menu where you define the logic state (High, Low, or Don't Care), and the signal threshold level that defines the logic state for each analog or digital signal. See <a href="#">Define Inputs</a> .

Table continued...



Field or control	Description
<b>Mark When</b>	<p>Defines the waveform logic event to mark, when Use Clock Edge is set to No.</p> <ul style="list-style-type: none"> <li>• <b>Goes True:</b> All conditions change to a true state.</li> <li>• <b>Goes False:</b> All conditions change to a false state.</li> <li>• <b>Is True &gt; Limit:</b> Condition remains true longer than a specified time.</li> <li>• <b>Is True &lt; Limit:</b> Condition remains true for less than a specified time.</li> <li>• <b>Is True = Limit:</b> Condition remains true for a specified time (within <math>\pm 5\%</math>).</li> <li>• <b>Is True <math>\neq</math> Limit:</b> Condition does not remain true for a specified time (within <math>\pm 5\%</math>).</li> </ul>
<b>Clock Source</b>	Sets the signal to use as the clock. The clock source can be an analog, digital, math, or reference waveform. Available when <b>Use Clock Edge</b> is <b>Yes</b> .
<b>Clock Edge</b>	Sets the polarity of the clock edge (rising or falling) for evaluating the other menu conditions. The Logic menu also lets you set the clock edge to either edge. Available when <b>Use Clock Edge</b> is <b>Yes</b> .
<b>Clock Threshold</b>	Sets the threshold level that the clock signal must pass through to be considered a valid transition. The clock threshold value is independent of the input signal threshold(s). Available when <b>Use Clock Edge</b> is <b>Yes</b> .
<b>Define Logic</b>	<p>Sets the logic condition that must occur with all inputs.</p> <ul style="list-style-type: none"> <li>• <b>AND:</b> All conditions are true.</li> <li>• <b>OR:</b> Any condition is true.</li> <li>• <b>NAND:</b> One or more conditions are true.</li> <li>• <b>NOR:</b> No conditions are true.</li> </ul>
<b>Copy Trigger Settings to Search</b>	Sets the search criteria to match the current oscilloscope trigger settings.
<b>Copy Search Settings to Trigger</b>	Sets the current oscilloscope trigger settings to match the search criteria.

## Other search types

[Bus Search configuration menus](#) on page 347

[Edge Search configuration menu](#) on page 419

[Pulse Width Search configuration menu](#) on page 422

[Rise/Fall Time Search configuration menu](#) on page 424

[Runt Search configuration menu](#) on page 425

[Setup and Hold Search configuration menu](#) on page 426

[Timeout Search configuration menu](#) on page 428

[Window Search configuration menu](#) on page 429

[DDR Read Search configuration menu](#) on page 431

[DDR Write Search configuration menu](#) on page 432

[DDR Read & Write Search configuration menu](#) on page 434

## Logic Search - Define Inputs configuration menu

Use the Define Inputs menu to select the logic condition to search on, and the logic threshold value, for each channel.

To open the Logic Search-Define Inputs configuration menu:

1. Double-tap a **Logic Search** badge on the Settings bar.
2. Tap the **Logic Pattern > Define Inputs** invoker button.

### Logic Search - Define Inputs configuration menu fields and controls

Field or control	Description
<b>Ch(x) (analog channels) or D(x) (digital Channels)</b>	<p>Use to select the signal sources logic condition on which to perform the logic search (<b>High, Low, Don't Care</b>).</p> <p>If a channel is a digital channel, tap the <b>+</b> symbol to open the list of digital inputs (D0-D7) from which to select individual logic conditions for the digital signals.</p> <p>To set the threshold levels for digital channels, double-tap the digital Channel badge to open its configuration menu.</p> <p>Use the <b>Threshold</b> field to set the signal level that must be exceeded for that signal to be true (logical 1).</p>
<b>Set All</b>	Sets all signal sources to detect a logic <b>High, Low, or Don't Care</b> condition.

## Pulse Width Search configuration menu

Use the Pulse Width search to mark a waveform whenever the specified pulse width condition occurs.

To create a new pulse width search:

1. Tap **Add New... Search**.
2. Set the **Search Type** to **Pulse Width**.
3. Select the search **Source**.
4. Use the menu fields to set the search parameters.

To change the settings on an existing search, double-tap the search badge and make necessary changes.

### Pulse Width Search menu fields and controls

Field or control	Description
<b>Display</b>	Sets the display of the mark icons to either <b>On</b> or <b>Off</b> . If you have multiple searches defined, the control turns off just the marks for the selected search.
<b>Stop Acquisition if Event Found</b>	Stops input acquisition when the search event occurs. Default is not enabled.
<b>Search Type</b>	Set to <b>Pulse Width</b> .
<b>Source</b>	Lists the source channel or waveform to use to trigger or search. Types that require multiple inputs will replace this control with a different source definition control.

Table continued...

Field or control	Description
<b>Mark When</b>	<ul style="list-style-type: none"> <li>• <b>&lt; Limit:</b> A pulse width is less than the specified time limit.</li> <li>• <b>&gt; Limit:</b> A pulse width is greater than the specified time limit.</li> <li>• <b>= Limit:</b> A pulse width is equal to the specified time limit.</li> <li>• <b>≠ Limit:</b> A pulse width does not equal (is greater than or less than) the specified time limit.</li> <li>• <b>Inside Range:</b> A pulse width is in the specified time range.</li> <li>• <b>Outside Range:</b> A pulse width is outside of the specified time range.</li> </ul>
<b>Level</b>	Sets the amplitude level that the signal must pass through to be considered a valid transition.
<b>Set to 50%</b>	Sets the threshold at 50% of the measured signal transition range. 50% is calculated as (Top + Bottom)/2.
<b>Time Limit</b>	Sets the time period condition to be met.
<b>High Time Limit</b>	Sets the longest acceptable pulse width time period for the range condition. Available only when <b>Mark When</b> is <b>Inside Range</b> or <b>Outside Range</b> .
<b>Low Time Limit</b>	Sets the shortest acceptable pulse width time period for the range condition. Available only when <b>Mark When</b> is <b>Inside Range</b> or <b>Outside Range</b> .
<b>Polarity</b>	Sets the polarity of the pulse to detect (positive pulse only, negative pulse only, or a positive or negative pulse).
<b>Copy Trigger Settings to Search</b>	Sets the search criteria to match the current oscilloscope trigger settings.
<b>Copy Search Settings to Trigger</b>	Sets the current oscilloscope trigger settings to match the search criteria.

## Other search types

[Bus Search configuration menus](#) on page 347

[Edge Search configuration menu](#) on page 419

[Logic search configuration menu](#) on page 420

[Rise/Fall Time Search configuration menu](#) on page 424

[Runt Search configuration menu](#) on page 425

[Setup and Hold Search configuration menu](#) on page 426

[Timeout Search configuration menu](#) on page 428

[Window Search configuration menu](#) on page 429

[DDR Read Search configuration menu](#) on page 431

[DDR Write Search configuration menu](#) on page 432

[DDR Read & Write Search configuration menu](#) on page 434

## Rise/Fall Time Search configuration menu

Use the Rise/Fall Time search to mark occurrences where the rise or fall time is less than, greater than, equal to, or not equal to a specified time limit.

To create a new rise/fall time search:

1. Tap **Add New... Search**.
2. Set the **Search Type** to **Rise/Fall Time**.
3. Select the search **Source**.
4. Use the menu fields to set the search parameters.

To change the settings on an existing search, double-tap the search badge and make necessary changes.

### Rise/Fall Time Search configuration menu fields and controls

Field or control	Description
<b>Display</b>	Sets the display of the mark icons to either <b>On</b> or <b>Off</b> . If you have multiple searches defined, the control turns off just the marks for the selected search.
<b>Stop Acquisition if Event Found</b>	Stops input acquisition when the search event occurs. Default is not enabled.
<b>Search Type</b>	Set to <b>Rise/Fall Time</b> .
<b>Source</b>	Lists the source channel or waveform to use to trigger or search. Types that require multiple inputs will replace this control with a different source definition control.
<b>Mark When</b>	<ul style="list-style-type: none"> <li>• <b>&lt; Limit</b>: A signal has a rise/fall time less than the specified time limit.</li> <li>• <b>&gt; Limit</b>: A signal has a rise/fall time greater than the specified time limit.</li> <li>• <b>= Limit</b>: A signal has a rise/fall time that is equal to the specified time limit (<math>\pm 5\%</math>).</li> <li>• <b><math>\neq</math> Limit</b>: A signal has a rise/fall time that does not equal (is greater than or less than) the specified time limit (<math>\pm 5\%</math>).</li> </ul>
<b>Time Limit</b>	Sets the time period condition to be met.
<b>Slope</b>	Sets the signal transition direction to detect. (rising, falling, or either direction).
<b>Upper Threshold</b>	Sets the upper amplitude level through which the signal must pass to be considered a valid transition.
<b>Lower Threshold</b>	Sets the lower amplitude level through which the signal must pass to be considered a valid transition.
<b>Copy Trigger Settings to Search</b>	Sets the search criteria to match the current oscilloscope trigger settings.
<b>Copy Search Settings to Trigger</b>	Sets the current oscilloscope trigger settings to match the search criteria.

### Other search types

[Bus Search configuration menus](#) on page 347

[Edge Search configuration menu](#) on page 419

[Logic search configuration menu](#) on page 420

[Pulse Width Search configuration menu](#) on page 422

[Runt Search configuration menu](#) on page 425

[Setup and Hold Search configuration menu](#) on page 426

[Timeout Search configuration menu](#) on page 428

[Window Search configuration menu](#) on page 429

[DDR Read Search configuration menu](#) on page 431

[DDR Write Search configuration menu](#) on page 432

[DDR Read & Write Search configuration menu](#) on page 434

## Runt Search configuration menu

Use the Runt search to mark a waveform where a pulse crosses one threshold but fails to cross a second threshold before recrossing the first threshold.

To create a new runt search:

1. Tap **Add New... Search**.
2. Set the **Search Type** to **Runt**.
3. Select the search **Source**.
4. Use the menu fields to set the search parameters.

To change the settings on an existing search, double-tap the search badge and make necessary changes.

### Runt Search configuration menu fields and controls

Field or control	Description
<b>Display</b>	Sets the display of the mark icons to either <b>On</b> or <b>Off</b> . If you have multiple searches defined, the control turns off just the marks for the selected search.
<b>Stop Acquisition if Event Found</b>	Stops input acquisition when the search event occurs. Default is not enabled.
<b>Search Type</b>	Set to <b>Runt</b> .
<b>Source</b>	Lists the source channel or waveform to use to trigger or search. Types that require multiple inputs will replace this control with a different source definition control.
<b>Mark When</b>	<ul style="list-style-type: none"> <li>• <b>Occurs</b>: A runt signal event occurs.</li> <li>• <b>&lt; Limit</b>: A runt signal event occurs that has a pulse width less than the specified time limit.</li> <li>• <b>&gt; Limit</b>: A runt signal event occurs that has a pulse width greater than the specified time limit.</li> <li>• <b>= Limit</b>: A runt signal event occurs that has a pulse width that is equal to the specified time limit (<math>\pm 5\%</math>).</li> <li>• <b><math>\neq</math> Limit</b>: A runt signal event occurs that has a pulse width that does not equal (is greater than or less than) the specified time limit (<math>\pm 5\%</math>).</li> </ul>
<b>Polarity</b>	Sets the polarity of the pulse to detect (positive pulse only, negative pulse only, or a positive or negative pulse).
<b>Time Limit</b>	Sets the time period condition to be met. Available only when <b>Mark When</b> = <b>&lt; Limit</b> , <b>&gt; Limit</b> , <b>= Limit</b> , or <b>!= Limit</b> .
<b>Upper Threshold</b>	Sets the upper amplitude level through which the signal must pass to be considered a valid transition.

Table continued...

Field or control	Description
Lower Threshold	Sets the lower amplitude level through which the signal must pass to be considered a valid transition.
Copy Trigger Settings to Search	Sets the search criteria to match the current oscilloscope trigger settings.
Copy Search Settings to Trigger	Sets the current oscilloscope trigger settings to match the search criteria.

### Other search types

- [Bus Search configuration menus](#) on page 347
- [Edge Search configuration menu](#) on page 419
- [Logic search configuration menu](#) on page 420
- [Pulse Width Search configuration menu](#) on page 422
- [Rise/Fall Time Search configuration menu](#) on page 424
- [Setup and Hold Search configuration menu](#) on page 426
- [Timeout Search configuration menu](#) on page 428
- [Window Search configuration menu](#) on page 429
- [DDR Read Search configuration menu](#) on page 431
- [DDR Write Search configuration menu](#) on page 432
- [DDR Read & Write Search configuration menu](#) on page 434

### Setup and Hold Search configuration menu

Use the Setup and Hold search type to mark a waveform when a data signal changes state inside of a specified setup and hold time, relative to a specified clock signal.

To create a new setup and hold search:

1. Tap **Add New... Search**.
2. Set the **Search Type** to **Setup & Hold**.
3. Select the search **Clock Source**.
4. Use the menu fields to set the search parameters.

To change the settings on an existing search, double-tap the search badge and make necessary changes.

### Setup & Hold Search configuration menu fields and controls

Field or control	Description
Display	Sets the display of the mark icons to either <b>On</b> or <b>Off</b> . If you have multiple searches defined, the control turns off just the marks for the selected search.
Stop Acquisition if Event Found	Stops input acquisition when the search event occurs. Default is not enabled.
Search Type	Set to <b>Setup &amp; Hold</b> .

Table continued...

Field or control	Description
<b>Clock Source</b>	Sets the signal to use as the clock. The clock source can be an analog, digital, math, or reference waveform.
<b>Clock Level</b>	Sets the threshold level that the clock signal must pass through to be considered a valid transition. The clock threshold value is independent of the input signal threshold(s).
<b>Clock Edge</b>	Sets the polarity of the clock edge (rising or falling) for evaluating the other menu conditions. The Logic menu also lets you set the clock edge to either edge.
<b>Data Sources</b>	Sets the data signal source(s). All selected sources must meet the specified setup and hold times. See <a href="#">Setup and Hold Search - Define Inputs configuration menu</a> on page 427.
<b>Setup Time</b>	Sets the length of time that data signal should be stable and not change before a clock edge occurs.
<b>Hold Time</b>	Sets the length of time that data signal should be stable and not change after a clock edge occurs.
<b>Copy Trigger Settings to Search</b>	Sets the search criteria to match the current oscilloscope trigger settings.
<b>Copy Search Settings to Trigger</b>	Sets the current oscilloscope trigger settings to match the search criteria.

## Other search types

[Bus Search configuration menus](#) on page 347

[Edge Search configuration menu](#) on page 419

[Logic search configuration menu](#) on page 420

[Pulse Width Search configuration menu](#) on page 422

[Rise/Fall Time Search configuration menu](#) on page 424

[Runt Search configuration menu](#) on page 425

[Timeout Search configuration menu](#) on page 428

[Window Search configuration menu](#) on page 429

[DDR Read Search configuration menu](#) on page 431

[DDR Write Search configuration menu](#) on page 432

[DDR Read & Write Search configuration menu](#) on page 434

## Setup and Hold Search - Define Inputs configuration menu

Use the Define Inputs menu to select the data signal source(s) and set their threshold level(s).

To open the Setup & Hold Search - Define Inputs menu:

1. Double-tap a **Setup & Hold** Search badge on the Results bar.
2. Tap the **Data Sources > Define Inputs** button.

## Setup and Hold Search - Define Inputs configuration menu fields and controls

Field or control	Description
<b>Ch(x) (analog channels) or D(x) (digital Channels)</b>	<p>Use to add (<b>Include</b>) or exclude (<b>Don't Include</b>) the data signal(s) from available input channels and waveforms.</p> <p>If a channel is a digital channel, tap the <b>+</b> symbol to open the list of digital inputs (D0-D7) from which to select for that channel.</p> <p>To set the threshold levels for digital channels, double-tap the digital Channel badge to open its configuration menu.</p> <p>For analog channels, use the threshold field to set the data signal level that must be exceeded for the signal transition to be true.</p>
<b>Set All</b>	Use to <b>Include</b> or <b>Don't Include</b> all available channels and waveforms as data signals.

## Timeout Search configuration menu

Use the Timeout search to mark a waveform when it does not detect an expected pulse transition within a specified period of time, such as when a signal gets stuck either high or low.

To create a new timeout search:

1. Tap **Add New... Search**.
2. Set the **Search Type** to **Timeout**.
3. Select the search **Source**.
4. Use the menu fields to set the search parameters.

To change the settings on an existing search, double-tap the search badge and make necessary changes.

## Timeout Search menu fields and controls

Field or control	Description
<b>Display</b>	Sets the display of the mark icons to either <b>On</b> or <b>Off</b> . If you have multiple searches defined, the control turns off just the marks for the selected search.
<b>Stop Acquisition if Event Found</b>	Stops input acquisition when the search event occurs. Default is not enabled.
<b>Search Type</b>	Set to <b>Timeout</b> .
<b>Source</b>	Lists the source channel or waveform to use to trigger or search. Types that require multiple inputs will replace this control with a different source definition control.
<b>Mark When</b>	<ul style="list-style-type: none"> <li>• <b>Stays High</b>: The signal stays above the specified threshold level longer than the specified time.</li> <li>• <b>Stays Low</b>: The signal stays below the specified threshold level longer than the specified time.</li> <li>• <b>Either</b>: The signal stays above or below the specified threshold level longer than the specified time.</li> </ul>
<b>Threshold</b>	Sets the amplitude level that the signal must pass through to be considered a valid transition.
<b>Set to 50%</b>	Sets the threshold at 50% of the measured signal transition range. 50% is calculated as $(\text{Top} + \text{Bottom})/2$ .
<b>Time Limit</b>	Sets the time period condition to be met.

Table continued...



Field or control	Description
<b>Copy Trigger Settings to Search</b>	Sets the search criteria to match the current oscilloscope trigger settings.
<b>Copy Search Settings to Trigger</b>	Sets the current oscilloscope trigger settings to match the search criteria.

## Other search types

[Bus Search configuration menus](#) on page 347

[Edge Search configuration menu](#) on page 419

[Logic search configuration menu](#) on page 420

[Pulse Width Search configuration menu](#) on page 422

[Rise/Fall Time Search configuration menu](#) on page 424

[Runt Search configuration menu](#) on page 425

[Setup and Hold Search configuration menu](#) on page 426

[Window Search configuration menu](#) on page 429

[DDR Read Search configuration menu](#) on page 431

[DDR Write Search configuration menu](#) on page 432

[DDR Read & Write Search configuration menu](#) on page 434

## Window Search configuration menu

Use the Window search to mark a waveform when the signal rises above an upper threshold level or falls below a lower threshold level (the 'window'), with or without a time limit constraint.

To create a new window search:

1. Tap **Add New... Search**.
2. Set the **Search Type** to **Window**.
3. Select the search **Source**.
4. Use the menu fields to set the search parameters.

To change the settings on an existing search, double-tap the search badge and make necessary changes.

## Window Search menu fields and controls

Field or control	Description
<b>Display</b>	Sets the display of the mark icons to either <b>On</b> or <b>Off</b> . If you have multiple searches defined, the control turns off just the marks for the selected search.
<b>Stop Acquisition if Event Found</b>	Stops input acquisition when the search event occurs. Default is not enabled.
<b>Search Type</b>	Set to <b>Window</b> .

Table continued...

Field or control	Description
<b>Source</b>	Lists the source channel or waveform to use to trigger or search. Types that require multiple inputs will replace this control with a different source definition control.
<b>Mark When</b>	<ul style="list-style-type: none"> <li>• <b>Enters Window:</b> The signal outside a window enters the window defined by the upper and lower threshold settings.</li> <li>• <b>Exits Window:</b> The signal exits the window defined by the upper and lower threshold settings.</li> <li>• <b>Inside &gt; Limit:</b> The signal remains inside the window longer then the specified time limit.</li> <li>• <b>Outside &gt; Limit:</b> The signal remains outside the window longer then the specified time limit.</li> </ul>
<b>Upper Threshold</b>	Sets the amplitude threshold value for the upper edge of the window.
<b>Lower Threshold</b>	Sets the amplitude threshold value for the lower edge of the window.
<b>Time Limit</b>	<p>Sets the time period condition to be met.</p> <p>Available only when Mark When = Inside &gt; Limit or Outside &gt; Limit.</p>
<b>Threshold Crossing</b> (Trigger When = Outside > Limit)	<ul style="list-style-type: none"> <li>• <b>Upper:</b> A signal remains above the upper threshold level for longer than the specified time limit before crossing the upper threshold level to a lower level.</li> <li>• <b>Lower:</b> A signal remains below the lower threshold level for longer than the specified time limit before crossing the lower threshold level to a higher level.</li> <li>• <b>Either:</b> A signal remains outside (above or below) the two threshold levels for longer than the specified time limit before crossing either threshold level.</li> <li>• <b>None:</b> A signal remains outside the two specified threshold levels for longer than a specified time limit.</li> </ul>
<b>Threshold Crossing</b> (Trigger When = Inside > Limit)	<ul style="list-style-type: none"> <li>• <b>Upper:</b> A signal remains between two thresholds for longer than the specified time limit before crossing through the upper threshold.</li> <li>• <b>Lower:</b> A signal remains between two thresholds for longer than the specified time limit before crossing through the lower threshold.</li> <li>• <b>Either:</b> A signal remains between two thresholds for longer than the specified time limit before crossing through either the upper or lower threshold.</li> <li>• <b>None:</b> A signal remains between two threshold levels for longer than a specified time limit.</li> </ul>
<b>Copy Trigger Settings to Search</b>	Sets the search criteria to match the current oscilloscope trigger settings.
<b>Copy Search Settings to Trigger</b>	Sets the current oscilloscope trigger settings to match the search criteria.

### Other search types

[Bus Search configuration menus](#) on page 347

[Edge Search configuration menu](#) on page 419

[Logic search configuration menu](#) on page 420

[Pulse Width Search configuration menu](#) on page 422

[Rise/Fall Time Search configuration menu](#) on page 424

[Runt Search configuration menu](#) on page 425

[Setup and Hold Search configuration menu](#) on page 426

[Timeout Search configuration menu](#) on page 428

[DDR Read Search configuration menu](#) on page 431

[DDR Write Search configuration menu](#) on page 432

[DDR Read & Write Search configuration menu](#) on page 434

## DDR Read Search configuration menu

Use the DDR Read search to search read events on source waveforms.

To create a new DDR Read search:

1. Tap **Add New... Search**.
2. Set the **Search Type** to **DDR Read**.
3. Select the search **Sources**.
4. Use the menu fields to set the search parameters.

To change the settings on an existing search, double-tap the search badge and make necessary changes.

### DDR Read Search configuration menu fields and controls

Field or control	Description
<b>Display</b>	Sets the display of the mark icons to either <b>On</b> or <b>Off</b> . If you have multiple searches defined, the control turns off just the marks for the selected search.
<b>Stop Acquisition if Event Found</b>	Stops input acquisition when the search event occurs. Default is not enabled.
<b>Search Type</b>	Set to <b>DDR Read</b> .
<b>Source</b>	Lists the source channel or waveform to use to search.
<b>Standard</b>	Sets the DDR standard ( <b>DDR3</b> or <b>LPDDR3</b> ).
<b>Data Rate</b>	Sets the data rate options for the selected standard.  Data rate values for the <b>DDR3</b> standard are 800, 1066, 1333, 1600, 1866, 2133, Auto, and Custom. Default is 800.  Data rate values for the <b>LPDDR</b> standard are 333, 800, 1066, 1200, 1333, 1466, 1600, 1866, 2133, Auto, and Custom. Default is 333.
<b>Custom Data Rate</b>	Sets the custom data rate. Default is 800 MT/s.  Available only when <b>Data Rate</b> is <b>Custom</b> .
<b>Burst Detection Method</b>	Sets the burst detection method to use for the measurement. <ul style="list-style-type: none"> <li>• DQ/DQS Phase Alignment</li> <li>• Chip Select, Latency + DQ/DQS Phase Alignment</li> <li>• Logic State + Burst latency</li> </ul>
<b>Postamble Length (tCK)</b>	Sets the postamble length value. Default is 500 mtCK.
<b>Preamble Type</b>	Sets the preamble type ( <b>Static</b> or <b>Dynamic</b> ). Default is <b>Static</b> .
<b>DQ/DQS Levels</b>	Sets to <b>Auto</b> or <b>Manual</b> . Default is <b>Auto</b> .

Table continued...

Field or control	Description
<b>Configure</b>	Sets the DQ/DQS level values. See <a href="#">DQ/DQS Levels Configure menu</a> on page 436. Available only when <b>DQ/DQS Levels</b> is <b>Manual</b> .
<b>Source 3 (CS)</b>	Sets the CS (Chip Select) signal source. Default is Ch 4. Available only when <b>Burst Detection Method</b> is <b>Chip Select, Latency + DQ/DQS Phase Alignment</b> .
<b>CAS Min</b>	Sets the CAS (Column Access Strobe) minimum cycles value. Default value is 2.0 cycles. Available only when <b>Burst Detection Method</b> is <b>Chip Select, Latency + DQ/DQS Phase Alignment</b> .
<b>CAS Max</b>	Sets the CAS maximum cycles value. Default value is 3.0 cycles. Available only when <b>Burst Detection Method</b> is <b>Chip Select, Latency + DQ/DQS Phase Alignment</b> .  <b>Note:</b> The CAS maximum value should be greater than or equal to the CAS minimum value. If the min value is equal to the max value, the max value automatically increases.
<b>CS Mode</b>	Sets the CS (Chip Select) to Auto or Manual mode. Default is Auto. Available only when <b>Burst Detection Method</b> is <b>Chip Select, Latency + DQ/DQS Phase Alignment</b> .
<b>CS Level</b>	Sets the CS (Chip Select) level value. Default is 500 mV. Available only when <b>CS Mode</b> is <b>Manual</b> .
<b>CS Active</b>	Sets the CS signal active true state to Low or High. Default is Low. Available only when <b>Burst Detection Method</b> is <b>Chip Select, Latency + DQ/DQS Phase Alignment</b> .
<b>Logic Pattern</b>	Sets the Logic pattern values. See <a href="#">DDR Input Configure menu</a> on page 436. Available only when <b>Burst Detection Method</b> is <b>Logic State + Burst latency</b> .
<b>Burst Latency</b>	Sets the burst latency value. Default is 2.5 Cycles. Available only when <b>Burst Detection Method</b> is <b>Logic State + Burst latency</b> .
<b>Tolerance</b>	Sets the tolerance value. Default is 1 Cycle.
<b>Burst Length</b>	Sets the burst length. Default is 8 UI.

## DDR Write Search configuration menu

Use the DDR Write search to search the write events on source waveforms.

To create a new DDR Write search:

1. Tap **Add New... Search**.
2. Set the **Search Type** to **DDR Write**.
3. Select the search **Sources**.
4. Use the menu fields to set the search parameters.

To change the settings on an existing search, double-tap the search badge and make necessary changes.

## DDR Write Search configuration menu fields and controls

Field or control	Description
<b>Display</b>	Sets the display of the mark icons to either <b>On</b> or <b>Off</b> . If you have multiple searches defined, the control turns off just the marks for the selected search.
<b>Stop Acquisition if Event Found</b>	Stops input acquisition when the search event occurs. Default is not enabled.
<b>Search Type</b>	Set to <b>DDR Read</b> .
<b>Source</b>	Lists the source channel or waveform to use to search.
<b>Standard</b>	Sets the DDR standard ( <b>DDR3</b> or <b>LPDDR3</b> ).
<b>Data Rate</b>	Sets the data rate options for the selected standard.  Data rate values for the <b>DDR3</b> standard are 800, 1066, 1333, 1600, 1866, 2133, Auto, and Custom. Default is 800.  Data rate values for the <b>LPDDR</b> standard are 333, 800, 1066, 1200, 1333, 1466, 1600, 1866, 2133, Auto, and Custom. Default is 333.
<b>Custom Data Rate</b>	Sets the custom data rate. Default is 800 MT/s.  Available only when <b>Data Rate</b> is <b>Custom</b> .
<b>Burst Detection Method</b>	Sets the burst detection method to use for the measurement. <ul style="list-style-type: none"> <li>• DQ/DQS Phase Alignment</li> <li>• Chip Select, Latency + DQ/DQS Phase Alignment</li> <li>• Logic State + Burst latency</li> </ul>
<b>Postamble Length (tCK)</b>	Sets the postamble length value. Default is 500 mtCK.
<b>Preamble Type</b>	Sets the preamble type ( <b>Static</b> or <b>Dynamic</b> ). Default is <b>Static</b> .
<b>DQ/DQS Levels</b>	Sets to <b>Auto</b> or <b>Manual</b> . Default is <b>Auto</b> .
<b>Configure</b>	Sets the DQ/DQS level values.  See <a href="#">DQ/DQS Levels Configure menu</a> on page 436.  Only available when <b>DQ/DQS Levels</b> is <b>Manual</b> .
<b>Source 3 (CS)</b>	Sets the CS (Chip Select) signal source. Default is Ch 4.  Available only when <b>Burst Detection Method</b> is <b>Chip Select, Latency + DQ/DQS Phase Alignment</b> .
<b>CAS Min</b>	Sets the CAS (Column Access Strobe) minimum cycles value. Default value is 2.0 cycles.  Available only when <b>Burst Detection Method</b> is <b>Chip Select, Latency + DQ/DQS Phase Alignment</b> .
<b>CAS Max</b>	Sets the CAS maximum cycles value. Default value is 3.0 cycles.  Available only when <b>Burst Detection Method</b> is <b>Chip Select, Latency + DQ/DQS Phase Alignment</b> .   <b>Note:</b> The CAS maximum value should be greater than or equal to the CAS minimum value. If the min value is equal to the max value, the max value automatically increases.
<b>CS Mode</b>	Sets the CS (Chip Select) to Auto or Manual mode. Default is Auto.  Available only when <b>Burst Detection Method</b> is <b>Chip Select, Latency + DQ/DQS Phase Alignment</b> .

Table continued...

Field or control	Description
<b>CS Level</b>	Sets the CS (Chip Select) level value. Default is 500 mV. Available only when <b>CS Mode</b> is <b>Manual</b> .
<b>CS Active</b>	Sets the CS signal active true state to Low or High. Default is Low. Available only when <b>Burst Detection Method</b> is <b>Chip Select, Latency + DQ/DQS Phase Alignment</b> .
<b>Logic Pattern</b>	Sets the Logic pattern values. See <a href="#">DDR Input Configure menu</a> on page 436. Available only when <b>Burst Detection Method</b> is <b>Logic State + Burst latency</b> .
<b>Burst Latency</b>	Sets the burst latency value. Default is 2.5 Cycles. Available only when <b>Burst Detection Method</b> is <b>Logic State + Burst latency</b> .
<b>Tolerance</b>	Sets the tolerance value. Default is 1 Cycle.
<b>Burst Length</b>	Sets the burst length. Default is 8 UI.

## DDR Read & Write Search configuration menu

Use the DDR Read & Write search to search both read and write events on source waveforms.

To create a new DDR Read & Write search:

1. Tap **Add New... Search**.
2. Set the **Search Type** to **DDR Read & Write**.
3. Select the search **Sources**.
4. Use the menu fields to set the search parameters.

To change the settings on an existing search, double-tap the search badge and make necessary changes.

## DDR Read & Write Search configuration menu fields and controls

Field or control	Description
<b>Display</b>	Sets the display of the mark icons to either <b>On</b> or <b>Off</b> . If you have multiple searches defined, the control turns off just the marks for the selected search.
<b>Stop Acquisition if Event Found</b>	Stops input acquisition when the search event occurs. Default is not enabled.
<b>Search Type</b>	Set to <b>DDR Read</b> .
<b>Source</b>	Lists the source channel or waveform to use to search.
<b>Standard</b>	Sets the DDR standard ( <b>DDR3</b> or <b>LPDDR3</b> ).
<b>Data Rate</b>	Sets the data rate options for the selected standard.  Data rate values for the <b>DDR3</b> standard are 800, 1066, 1333, 1600, 1866, 2133, Auto, and Custom. Default is 800.  Data rate values for the <b>LPDDR</b> standard are 333, 800, 1066, 1200, 1333, 1466, 1600, 1866, 2133, Auto, and Custom. Default is 333.

Table continued...

Field or control	Description
<b>Custom Data Rate</b>	Sets the custom data rate. Default is 800 MT/s. Available only when <b>Data Rate</b> is <b>Custom</b> .
<b>Burst Detection Method</b>	Sets the burst detection method to use for the measurement. <ul style="list-style-type: none"> <li>• DQ/DQS Phase Alignment</li> <li>• Chip Select, Latency + DQ/DQS Phase Alignment</li> <li>• Logic State + Burst latency</li> </ul>
<b>Postamble Length (tCK)</b>	Sets the postamble length value. Default is 500 mtCK.
<b>Preamble Type</b>	Sets the preamble type ( <b>Static</b> or <b>Dynamic</b> ). Default is <b>Static</b> .
<b>DQ/DQS Levels</b>	Sets to <b>Auto</b> or <b>Manual</b> . Default is <b>Auto</b> .
<b>Configure</b>	Sets the DQ/DQS level values. See <a href="#">DQ/DQS Levels Configure menu</a> on page 436. Only available when <b>DQ/DQS Levels</b> is <b>Manual</b> .
<b>Source 3 (CS)</b>	Sets the CS (Chip Select) signal source. Default is Ch 4. Available only when <b>Burst Detection Method</b> is <b>Chip Select, Latency + DQ/DQS Phase Alignment</b> .
<b>CAS Min</b>	Sets the CAS (Column Access Strobe) minimum cycles value. Default value is 2.0 cycles. Available only when <b>Burst Detection Method</b> is <b>Chip Select, Latency + DQ/DQS Phase Alignment</b> .
<b>CAS Max</b>	Sets the CAS maximum cycles value. Default value is 3.0 cycles. Available only when <b>Burst Detection Method</b> is <b>Chip Select, Latency + DQ/DQS Phase Alignment</b> .  <b>Note:</b> The CAS maximum value should be greater than or equal to the CAS minimum value. If the min value is equal to the max value, the max value automatically increases.
<b>CS Mode</b>	Sets the CS (Chip Select) to Auto or Manual mode. Default is Auto. Available only when <b>Burst Detection Method</b> is <b>Chip Select, Latency + DQ/DQS Phase Alignment</b> .
<b>CS Level</b>	Sets the CS (Chip Select) level value. Default is 500 mV. Available only when <b>CS Mode</b> is <b>Manual</b> .
<b>CS Active</b>	Sets the CS signal active true state to Low or High. Default is Low. Available only when <b>Burst Detection Method</b> is <b>Chip Select, Latency + DQ/DQS Phase Alignment</b> .
<b>Logic Pattern</b>	Sets the Logic pattern values. See <a href="#">DDR Input Configure menu</a> on page 436. Available only when <b>Burst Detection Method</b> is <b>Logic State + Burst latency</b> .
<b>Burst Latency</b>	Sets the burst latency value. Default is 2.5 Cycles. Available only when <b>Burst Detection Method</b> is <b>Logic State + Burst latency</b> .
<b>Tolerance</b>	Sets the tolerance value. Default is 1 Cycle.
<b>Burst Length</b>	Sets the burst length. Default is 8 UI.

## DQ/DQS Levels Configure menu

Use the DQ/DQS Levels Configure menu to set strobe, data, hysteresis, and margin values.

### DQ/DQS Levels Configure menu

This menu is accessed from the **Configure** button in a **DDR Read**, **DDR Write**, or **DDR Read & Write** search menu, when **DQ/DQS Levels** is set to **Manual**.

Field or control	Description
High	Sets the high value for Strobe and Data. Default value is 0.
Mid	Sets the mid value for Strobe and Data. Default value is 0.
Low	Sets the low value for Strobe and Data. Default value is 0.
Hysteresis	Sets the hysteresis. Default value is 10%.
Margin	Sets the margin. Default value is 20%.

## DDR Input Configure menu

Use the Input configure menu to set the logic pattern input values for CS, RAS, CAS, and WE values.

### Logic Pattern Levels Input Configure menu

This menu is accessed from the **Define Inputs** button in **DDR Read**, **DDR Write**, or **DDR Read & Write** search menu, when **Logic State + Burst Latency** is selected as the **Burst Detection method**.

Field or control	Description
CS	Sets the chip select source, level, and the threshold value.
RAS	Sets the row access strobe source, level, and the threshold value.
CAS	Sets the column access strobe source, level, and the threshold value.
WE	Sets the write enable source, level, and the threshold value.

## Remote channel configuration menu

Use the Remote channel configuration menu to set up analog channel vertical settings, deskew settings, external attenuation, alternate units for analog channel inputs, and enable the Spectrum View for the channel.

To open remote analog channel configuration menu, double-tap remote Channel badge.

The following text describes remote channel settings.

### Vertical Settings panel, fields and controls (Remote Control On)

Field or control	Description
Display	Enables ( <b>On</b> ) or disables ( <b>Off</b> ) displaying the channel waveform in the Waveform View window.
Vertical Scale	Sets the vertical scale using the multipurpose knob, double-tap to bring up the virtual keypad, or tap the up and down arrows to change the scale.

Table continued...



Field or control	Description
Offset	Sets the channel signal vertical offset. When there is an offset, the remote channel handle displays it in the waveform view.
Set to 0	Sets the channel signal vertical offset to 0 units.
Position	Double-tap the field to set the vertical position using the virtual keypad.
Set to 0	Tap to set the waveform zero volt level to the center of the slice or waveform view.
Label	Double-tap the field to add a label to the channel display using the virtual keypad.

### Vertical Settings panel, fields and controls (Remote Control Off)

Field or control	Description
Display	Enables ( <b>On</b> ) or disables ( <b>Off</b> ) displaying the channel waveform in the Waveform View window.
Vertical Scale	Sets the vertical scale using the multipurpose knob, double-tap to bring up the virtual keypad, or tap the up and down arrows to change the scale.
Position	Double-tap the field to set the vertical position using the virtual keypad.
Set to 0	Tap to set the waveform zero volt level to the center of the slice or waveform view.
Label	Double-tap the field to add a label to the channel display using the virtual keypad.

### Spectrum View panel (Channel configuration menu)

Use the Spectrum View panel to enable showing the Spectrum View window, set up the spectrum trace vertical scale units, and select which spectrum traces to display.

To open the **Spectrum View** panel:

1. Double-tap an analog Channel badge on the Settings bar to open the **Channel** configuration menu.
2. Tap the **Spectrum View** panel.

**Table 15: Spectrum View panel, fields and controls**

Field or control	Description
Display	Enables ( <b>On</b> ) or disables ( <b>Off</b> ) displaying a spectrum waveform of the channel in a <b>Spectrum View</b> window.  If this is the first channel to display a <b>Spectrum View</b> , tapping <b>On</b> opens the <b>Spectrum View</b> window and displays a spectrum trace for the channel. Double-tap other Channel badges to turn on <b>Spectrum View</b> traces for those channels.  If this is the last channel to display a <b>Spectrum View</b> trace, tapping <b>Off</b> closes the <b>Spectrum View</b> window.  The <b>Spectrum View Display</b> On/Off controls are independent of the <b>Waveform View Display</b> On/Off controls in the <b>Vertical Settings</b> panel.
Units	Sets the measurement unit to use in the vertical scale of this channel in the <b>Spectrum View</b> window. The default value is <b>dBm (50 Ω)</b> .

Table continued...

Field or control	Description
<b>Frequency Domain Traces</b>	<p>Sets the spectrum trace type or types to display for this channel. You can select to show any combination of traces for each spectrum signal.</p> <p><b>Normal</b> displays the current acquisition, discarding the previous acquisition's data.</p> <p><b>Max Hold</b> displays the maximum data values accumulated over multiple acquisitions of the Normal trace.</p> <p><b>Min Hold</b> displays the minimum data values accumulated over multiple acquisitions of the Normal trace.</p> <p><b>Average</b> displays the average of the Normal trace data over the specified number of acquisitions. This is true power averaging, which occurs before the log conversion. Each power of 2 averaging reduces the displayed noise by 3 dB.</p>
<b>Number of Averages</b>	<p>Sets the number of spectrum acquisitions over which to average the spectrum trace. This control is only shown when <b>Average</b> is selected in the <b>Frequency Domain Traces</b> control.</p>
<b>Time Domain Traces</b>	<p>Selects the RF vs. Time trace(s) to display. Selecting a check box adds a corresponding waveform slice to the Waveform View and an RF vs. Time badge to the Settings bar.</p> <p><b>Magnitude</b> plots how the signal magnitude (amplitude) varies with time.</p> <p><b>Frequency</b> plots how the signal frequency varies with time.</p> <p><b>Phase</b> plots how the signal phase varies with time. The phase appears on the vertical axis while time is plotted along the horizontal axis.</p>
<b>Squelch</b>	<p>Sets a threshold for the Magnitude vs. Time waveform to indicate when the transmitter signal is on or off. <b>Squelch</b> blanks the Frequency Vs. Time and Phase Vs. Time traces when their amplitudes are below the specified threshold level.</p> <p>Selecting <b>Squelch</b> displays the squelch level field. Use the assigned multipurpose knob or double-tap in the field to set the level using the virtual keypad.</p> <p>When you adjust the squelch level, a horizontal bar similar to that used for trigger level is drawn on the magnitude vs. time waveform (if visible), as visual confirmation of the value setting.</p>

### Other panel (Channel configuration menu)

Use the Other panel to set the channel deskew, external attenuation, and alternate vertical scale units.

To open the analog Channel configuration menu Other panel:

1. Double-tap an analog Channel badge on the Settings bar to open the Channel configuration menu.
2. Tap the **Other** panel.

Not all items listed in the table are shown for all measurements; The panel only shows fields and controls relevant to the selected measurement.

**Table 16: Other panel fields and controls**

Field or control	Description
<b>Deskew</b>	Sets or displays the probe deskew value.
<b>Set to 0</b>	Sets the probe deskew value to zero (0) seconds.

## Analog Channel configuration menu

Use the Analog Channel configuration menu to set up analog channel vertical settings, probe settings, deskew settings, external attenuation, alternate units for analog channel inputs, and enable the Spectrum View for the channel.

To open an analog Channel configuration menu, double-tap an analog Channel badge. The following text describes analog channel settings. For digital channel settings, see [Digital channel configuration menu](#) on page 449.

### Vertical Settings panel, fields and controls

Field or control	Description
<b>Display</b>	Enables ( <b>On</b> ) or disables ( <b>Off</b> ) displaying the channel waveform in the Waveform View window.
<b>Invert</b>	Reverses the amplitude polarity of each sample point. When On, Invert adds a down arrow symbol to the channel badge.  See <a href="#">Invert channel guidelines</a> on page 440.
<b>Vertical Scale</b>	Sets the vertical scale using the multipurpose knob, double-tap to bring up the virtual keypad, or tap the up and down arrows to change the scale.
<b>Offset</b>	Sets the channel signal vertical offset.  When there is an offset, the channel handle displays it in the waveform view.
<b>Set to 0</b>	Sets the channel signal vertical offset to 0 units.
<b>Position</b>	Double-tap the field to set the vertical position using the virtual keypad.
<b>Set to 0</b>	Tap to set the waveform zero volt level to the center of the slice or waveform view.
<b>Label</b>	Double-tap the field to add a label to the channel display using the virtual keypad.
<b>Bandwidth Limit</b>	Tap to select the bandwidth limit from the drop-down list.
<b>Coupling</b>	Tap to set the input coupling to DC or AC.
<b>Termination</b>	Tap to set the input termination to 1 M $\Omega$ or 50 $\Omega$ . If you are using a supported TekVPI probe, this value is automatically set by the probe and these controls are not available.
<b>Bandwidth Filter Optimized For</b>	Tap to select a bandwidth filter that is optimized for flatness or step response. This selection is only available on 6 Series MSO instruments.  <b>Flatness</b> selects a brick-wall filter optimized for flatness within band with a sharp rolloff. Flatness filtering is not compatible with Peak Detect and Envelope acquisition modes.  <b>Step Response</b> selects a Bessel-Thompson filter that minimizes overshoot with a gradual rolloff.  <b>High Res</b> acquisition mode requires Flatness filtering.

Field or control	Description
<b>Other channel settings panels</b>	
<b>Probe Setup</b>	Use to see probe information, check the probe compensation status, compensate the probe, or restore the factory defaults.  See <a href="#">Probe Setup panel (Channel configuration menu)</a> on page 440.  See <a href="#">Probe Compensation configuration menu (analog channels Probe Setup panel)</a> on page 442.  See <a href="#">Unsupported Probe dialog</a> on page 441.

Table continued...

Field or control	Description
<b>Spectrum View</b>	Use to enable and configure the spectrum and RF vs. Time traces to display for the channel. See <a href="#">Spectrum View panel (Channel configuration menu)</a> on page 442.
<b>Other</b>	Use to adjust signal delay to align signal arrival at the oscilloscope between probes and/or cables. See <a href="#">Other panel (Channel configuration menu)</a> on page 444.

## Invert channel guidelines

This topic describes how the channel Invert function interacts with other instrument settings.

### Settings that change when Invert is set to On or Off:

- The instrument clears acquisitions and restarts triggering
- All persistence information resets/clears, including all waveform statistics, histograms, eye diagrams, etc
- All associated views and derived results change. For example, XY view, cursor readouts, measurement results, search results, math, bus decode, and so on, all change to reflect the current Invert setting

### Settings that change when Invert is set to On:

- The instrument adds a down arrow to the title row of the channel badge to indicate inverted mode
- The channel **Offset** value reverses polarity
- The trigger level value reverses polarity
- The trigger level indicator moves to the inverted value and the trigger level bar appears momentarily to show the new level
- The trigger **Slope** indicator on the Trigger badge and in its menu changes to the opposite edge (Rising to Falling, or Falling to Rising). If the Either edge mode is selected then slope mode does not change

### Settings that don't change when Invert is On:

- The channel **Vertical** scale does not change
- The channel **Vertical** position knob rotation direction does not change
- The channel Vertical **Position** value does not change
- The **Trigger** level knob rotation direction does not change

### Invert and Setup, Autoset, and Default functions

- The invert state is saved and recalled correctly as part of **Setup** and **Session** files
- **Autoset** does not affect **Invert**
- **Default** sets **Invert** to **Off**

## Probe Setup panel (Channel configuration menu)

Use the Channel configuration menu Probe Setup panel to see probe information, check the probe compensation status, compensate the probe, or restore the factory defaults.

To open the Probe Setup panel:

1. Double-tap an analog Channel badge on the Settings bar to open the Channel configuration menu.
2. Tap the **Probe Setup** panel.

## Probe Setup panel fields and controls

Available fields and controls vary with the type of probe that is attached. For more information, consult the probe documentation.

Field or control	Description
<b>Probe Information</b>	View probe information such as probe type, serial number, and its attenuation.
<b>Probe Compensation Status</b>	View the probe compensation status: Default, Pass, or Fail.
<b>Compensate Probe</b>	Tap to display the probe compensation dialog. This is only available for probes that support automatic compensation.
<b>Mode</b>	Select the probe operating mode from the drop down list (Differential, Common Mode, A, or B).
<b>Offset</b>	Enter the A or B offset value. This value is the same as the Offset in the Settings panel.
<b>Differential Offset Tracking</b>	When checked, the Differential Offset Tracking mode is Tracking. When unchecked, the Differential Offset Tracking is Manual.
<b>Differential Offset</b>	When in manual mode, enter the Differential Offset value.
<b>Common Mode Offset</b>	When in manual mode, enter the Common Mode Offset value.
<b>Common Mode Offset Tracking</b>	When checked, the Common Mode Offset Tracking mode is Tracking. When unchecked, the Common Mode Offset Tracking is Manual.
<b>VTerm Tracking</b>	When checked, the VTerm mode is Tracking. When unchecked, the VTerm is Manual.
<b>VTermA</b>	When in manual mode, enter the VTermA value.
<b>VTermB</b>	When in manual mode, enter the VTermB value.

Probe error messages are also displayed in this setup panel, see [Error Messages and Badges](#) on page 61.

### See also

[Unsupported Probe dialog](#) on page 441

[Probe Compensation configuration menu \(analog channels Probe Setup panel\)](#) on page 442

[Other panel \(Channel configuration menu\)](#) on page 444

[Deskew configuration menu \(Other panel, Channel configuration menu\)](#) on page 444

## Unsupported Probe dialog

This dialog tells you that you have attached an unsupported probe.

To open the Unsupported Probe dialog:

1. Double-tap a Channel badge to open the channel configuration menu.
2. Tap the **Probe Setup** panel.
3. Read the Probe Information.

If you have attached an unsupported probe, remove the unsupported probe and attach a supported probe to the input channel.

### See also

[Probe Compensation configuration menu \(analog channels Probe Setup panel\)](#) on page 442

[Other panel \(Channel configuration menu\)](#) on page 444

[Deskew configuration menu \(Other panel, Channel configuration menu\)](#) on page 444

## Probe Compensation configuration menu (analog channels Probe Setup panel)

Use this menu to compensate probes that support automatic frequency compensation. This menu is only available when a compensation-supported probe is installed on the channel.

To open the Probe Compensation dialog:

1. Double-tap the Channel badge on the Settings bar to open the channel configuration menu.
2. Tap the **Probe Setup** panel.
3. Tap **Compensate Probe**.

### Probe Compensation dialog

Available fields and controls vary with the type of probe that is attached. For more information, consult the probe documentation. Read the information on the menu before starting the probe compensation process.

Field or control	Description
<b>Compensate Probe</b>	Tap to compensate the attached probe. Before compensating the probe, read the instructions in the dialog.
<b>Restore Factory Defaults</b>	Tap to restore the probe compensation factory defaults and remove the previous compensation results.
<b>Probe Compensation Status</b>	Probe compensation status can be Running, Passed, Failed or Default.
<b>OK</b>	Tap to close the dialog.

### See also

[Unsupported Probe dialog](#) on page 441

[Other panel \(Channel configuration menu\)](#) on page 444

[Deskew configuration menu \(Other panel, Channel configuration menu\)](#) on page 444

## Spectrum View panel (Channel configuration menu)

Use the Spectrum View panel to enable showing the Spectrum View window, set up the spectrum trace vertical scale units, and select which spectrum traces to display.

To open the **Spectrum View** panel:

1. Double-tap an analog Channel badge on the Settings bar to open the **Channel** configuration menu.
2. Tap the **Spectrum View** panel.

## Spectrum View panel, fields and controls

Field or control	Description
<b>Display</b>	<p>Enables (<b>On</b>) or disables (<b>Off</b>) displaying a spectrum waveform of the channel in a <b>Spectrum View</b> window.</p> <p>If this is the first channel to display a <b>Spectrum View</b>, tapping <b>On</b> opens the <b>Spectrum View</b> window and displays a spectrum trace for the channel. Double-tap other Channel badges to turn on <b>Spectrum View</b> traces for those channels.</p> <p>If this is the last channel to display a <b>Spectrum View</b> trace, tapping <b>Off</b> closes the <b>Spectrum View</b> window.</p> <p>The <b>Spectrum View Display</b> On/Off controls are independent of the <b>Waveform View Display</b> On/Off controls in the <b>Vertical Settings</b> panel.</p>
<b>Units</b>	<p>Sets the measurement unit to use in the vertical scale of this channel in the <b>Spectrum View</b> window. The default value is <b>dBm</b>.</p>
<b>Frequency Domain Traces</b>	<p>Sets the spectrum trace type or types to display for this channel. You can select to show any combination of traces for each spectrum signal.</p> <p><b>Normal</b> displays the current acquisition, discarding the previous acquisition's data.</p> <p><b>Max Hold</b> displays the maximum data values accumulated over multiple acquisitions of the Normal trace.</p> <p><b>Min Hold</b> displays the minimum data values accumulated over multiple acquisitions of the Normal trace.</p> <p><b>Average</b> displays the average of the Normal trace data over the specified number of acquisitions. This is true power averaging, which occurs before the log conversion. Each power of 2 averaging reduces the displayed noise by 3 dB.</p>
<b>Number of Averages</b>	<p>Sets the number of spectrum acquisitions over which to average the spectrum trace. This control is only shown when <b>Average</b> is selected in the <b>Frequency Domain Traces</b> control.</p>
<b>Time Domain Traces</b>	<p>Selects the RF vs. Time trace(s) to display. Selecting a check box adds a corresponding waveform slice to the Waveform View and an RF vs. Time badge to the Settings bar.</p> <p><b>Magnitude</b> plots how the signal magnitude (amplitude) varies with time.</p> <p><b>Frequency</b> plots how the signal frequency varies with time.</p> <p><b>Phase</b> plots how the signal phase varies with time. The phase appears on the vertical axis while time is plotted along the horizontal axis.</p>
<b>Squelch</b>	<p>Sets a threshold for the Magnitude vs. Time waveform to indicate when the transmitter signal is on or off. <b>Squelch</b> blanks the Frequency Vs. Time and Phase Vs. Time traces when their amplitudes are below the specified threshold level.</p> <p>Selecting <b>Squelch</b> displays the squelch level field. Use the assigned multipurpose knob or double-tap in the field to set the level using the virtual keypad.</p> <p>When you adjust the squelch level, a horizontal bar similar to that used for trigger level is drawn on the magnitude vs. time waveform (if visible), as visual confirmation of the value setting.</p>
<b>Spectrogram</b>	<p>Enables the Spectrogram. By default it is unchecked. When checked, it displays the spectrogram in the spectrum view.</p>

## Other panel (Channel configuration menu)

Use the Other panel to set the channel deskew, external attenuation, and alternate vertical scale units.

To open the analog Channel configuration menu Other panel:

1. Double-tap an analog Channel badge on the Settings bar to open the Channel configuration menu.
2. Tap the **Other** panel.

### Other panel fields and controls

Not all items listed in the table are shown for all measurements; The panel only shows fields and controls relevant to the selected measurement.

Field or control	Description
<b>Deskew</b>	Sets or displays the probe deskew value.
<b>Set to 0</b>	Sets the probe deskew value to zero (0) seconds.
<b>Multi-Channel</b>	Opens a Deskew configuration menu that allows you to deskew multiple channels (two at a time).
<b>External Attenuation</b>	Double-tap the numeric fields to set the external attenuation using the virtual keypad.
<b>Set to Unity</b>	Sets the external attenuation to unity.
<b>Alternate Units</b>	Toggles Alternate Units On or Off. Use to set custom vertical measurement units. The vertical scale will show the entered measurement units.
<b>Units</b>	Double-tap to enter alternate units using the virtual keyboard. Only shown when <b>Alternate Units = On</b> .
<b>Ratio</b>	Double-tap the numeric fields to set the ratio using the virtual keypad. Only shown when <b>Alternate Units = On</b> .
<b>Set to Unity</b>	Sets the ratio to unity. Only shown when <b>Alternate Units = On</b> .

### See also

[Unsupported Probe dialog](#) on page 441

[Probe Compensation configuration menu \(analog channels Probe Setup panel\)](#) on page 442

[Deskew configuration menu \(Other panel, Channel configuration menu\)](#) on page 444

## Deskew configuration menu (Other panel, Channel configuration menu)

Use the Deskew configuration menu to make display and measurement adjustments for analog probes that have differing propagation delays. This is especially important when using a current probe in conjunction with a voltage probe.

To open the Deskew configuration menu:

1. Double-tap an analog Channel badge on the Settings bar to open the Channel configuration menu.
2. Tap the **Other** panel.
3. Tap the **Multi-Channel** button.

Use the controls in the Deskew menu to set the deskew parameters to recommended values, based on the nominal propagation delay of supported probes. The oscilloscope automatically loads the nominal propagation delay values of TekVPI and TekProbe II probes (TekProbe II probes require use of a TPA-BNC adaptor).



**Note:** This deskew menu does not actively test and adjust the probe delay between channels; it uses the delay values stored in supported probes, or a custom propagation delay value that you enter, to set the propagation delay to zero between the reference channel probe and one or more other probes.



To actively adjust probe delay using a signal, see [Deskew analog input channels - quick visual method](#) and [Deskew analog input channels](#) on page 82.

## Deskew menu fields and controls

Available fields and controls vary with the type of probe that is attached. For more information, consult the probe documentation.

Field or control	Description
<b>From Source</b>	Tap and select from the drop-down list the channel to deskew from (your reference channel for deskewing).
<b>To Source</b>	Tap and select from the drop-down list the channel to deskew to (the channel that you want to match the <b>From Source</b> reference channel).
<b>Probe</b>	<p>If the oscilloscope recognizes the probe attached to the channel, the <b>Probe</b> field shows the nomenclature of the attached probe.</p> <p>If the oscilloscope does not recognize the probe attached to the channel, the <b>Probe</b> field shows a drop-down list from which you can select the probe that is attached to the selected channel.</p> <p>If the attached probe is not in the list, select <b>Custom</b> (at the bottom of the list) and enter the probe propagation delay in the <b>Prop. Delay</b> field.</p>
<b>Prop. Delay</b>	<p>Field in which you can enter the probe delay for an unsupported probe. Double-tap in the field and use the keypad to enter the propagation delay value.</p> <p>This field is available when <b>Probe = Custom</b>.</p>
<b>Propagation Delay</b>	This field lists the default propagation delay of the attached probe. A positive value shifts a channel to the left.
<b>OK, deskew</b>	Sets the oscilloscope to add or subtract the delay values of the <b>To Source</b> channel such that the delay between the two channels is as close to 0 as possible.

## See also

[Probe Compensation configuration menu \(analog channels Probe Setup panel\)](#) on page 442

[Other panel \(Channel configuration menu\)](#) on page 444

[Deskew analog input channels](#) on page 82

[Deskew analog input channels - quick visual method](#)

## AFG configuration menu

Use the AFG configuration menu to set the output signal parameters for the optional arbitrary/function generator. Use the AFG to simulate signals within a design or add noise to signals to perform margin testing.

To open the AFG configuration menu:

1. Tap the **AFG** button on the Settings bar. The oscilloscope changes the AFG button to an AFG badge that shows the AFG settings. You can change the **AFG** settings while the output is **Off**.
2. Double-tap the AFG badge to open the AFG menu.

## Arbitrary/Function Generator overview

The function generator provides output of predefined waveforms up to 50 MHz. Choose between Sine, Square, Pulse, Ramp, DC, Noise, Sin(x)/x, Gaussian, Lorentz, Exponential Rise, Exponential Decay, Haversine, Cardiac, and Arbitrary signals.

You can also select a predefined waveform or load a saved .wfm- or .csv-format waveform from storage (USB drive, a network drive or TekDrive on instruments with Windows OS installed).

### Arbitrary/Function Generator menu fields and controls

Not all items listed in the table may be shown for all measurements. The configuration menu only shows fields and controls relevant to the selected Waveform Type.

The output connector is on the rear panel, labeled AFG Out.

Field or control	Description
<b>Output</b>	Tap to toggle between the output <b>Off</b> , <b>Continuous</b> , or <b>Burst</b> .
<b>Cycles</b>	Specify the number of cycles in the text field. Default cycle value is <b>1</b> .  Available when <b>Output</b> is <b>Burst</b>  When Output is selected as Burst, a Burst button is displayed on the AFG badge. Click the Burst button on the badge to generate the signal burst.
<b>Waveform Type</b>	Tap to select an available waveform from the list.
<b>Load</b>	Tap to open the Directory configuration menu. Navigate to and select a waveform file to load into the AFG memory. You can navigate to TekDrive to load saved waveform files.  Available when <b>Waveform Type</b> is <b>Arbitrary</b> .
<b>Waveform File</b>	Shows the loaded waveform file path and name. Tap to select a waveform file to load into the AFG waveform memory from the drop-down list of the last 20 waveforms that have been loaded using the <b>Load</b> button.
<b>Symmetry</b>	Sets the symmetry of the ramp using the keypad or multipurpose knob.  Available when the <b>Waveform Type</b> is <b>Ramp</b> .
<b>Width</b>	Sets the width of the pulse using the keypad or multipurpose knob.  Available when the <b>Waveform Type</b> is <b>Pulse</b> .
<b>Duty Cycle</b>	Sets the duty cycle of the square wave using the keypad or multipurpose knob.  Available when the <b>Waveform Type</b> is <b>Square</b> .
<b>Frequency</b>	Sets the frequency of the waveform using the keypad or multipurpose knob. The frequency range is 0.1 Hz to 50 MHz, in increments of 0.1 Hz.
<b>Period</b>	Sets the period of the waveform using the keypad or multipurpose knob.
<b>Amplitude</b>	Sets the amplitude of the waveform using the keypad or multipurpose knob
<b>Offset</b>	Sets the offset of the waveform using the keypad or multipurpose knob.
<b>High Level</b>	Sets the High signal amplitude of the waveform using the keypad or multipurpose knob
<b>Low Level</b>	Sets the low signal amplitude of the waveform using the keypad or multipurpose knob.
<b>Load Impedance</b>	Tap to select either <b>50 Ω</b> or <b>High Z</b> (1 MΩ) output load impedance.
<b>Add Noise</b>	Tap the check box to toggle noise on and off. Set the amount of noise to add to the output signal using the keypad or the multipurpose controls.

## AFG output amplitude ranges by impedance (peak to peak)

Waveform	50 $\Omega$	High Z
Sine	10 mV to 2.5 V	20 mV to 5 V
Square	10 mV to 2.5 V	20 mV to 5 V
Pulse	10 mV to 2.5 V	20 mV to 5 V
Ramp	10 mV to 2.5 V	20 mV to 5 V
DC	0 V to $\pm 1.25$ V	0 V to $\pm 2.5$ V
Noise	10 mV to 2.5 V	20 mV to 5 V
Sine(x)/x	10 mV to 1.5 V	20 mV to 3 V
Gaussian	10 mV to 1.25 V	20 mV to 2.5 V
Lorentz	10 mV to 1.2 V	20 mV to 2.4 V
Exponential Rise	10 mV to 1.25 V	20 mV to 2.5 V
Exponential Decay	10 mV to 1.25 V	20 mV to 2.5 V
Haversine	10 mV to 1.25 V	20 mV to 2.5 V
Cardiac	10 mV to 2.5 V	20 mV to 5 V
Arbitrary	10 mV to 2.5 V	20 mV to 5 V

## Cursor configuration menu

Cursors are on-screen lines (bars) that you position in a Waveform or Plot views to take manual measurements on signals. They appear as horizontal and/or as vertical lines.

To open the Cursors configuration menu:

1. Double-tap a cursor readout or cursor line, or
2. Touch and hold a cursor readout or cursor line and select **Configure Cursors** from the right-click menu.

To display cursors on the screen:

1. Tap the **Add New... Cursors** button of the display, or
2. Push the **Cursors** front-panel button to toggle cursors on or off.

### See also

[Display and configure cursors](#) on page 109

[Display and configure Multi-source cursor readouts](#) on page 111

### Cursor configuration menu fields and controls

Some fields or controls are available only when certain other controls are selected.

Field or control	Description
Display	Tap to toggle the cursor display <b>On</b> or <b>Off</b> .

Table continued...

Field or control	Description
<b>Readout Location</b>	<p>Tap to set where to display cursor readouts.</p> <p><b>Graticule</b> displays the cursor readouts on the screen cursor bars (default method). You can move the readouts on cursors by touching and dragging them along the cursor bar.</p> <p><b>Badge</b> removes the screen cursor readouts and displays the cursor information in a <b>Cursors</b> badge in the Results bar. The <b>Cursors</b> badge content changes as you change the cursor type.</p>
<b>Cursor Type</b>	<p>Tap to select the cursor type from the drop-down list.</p> <p><b>Waveform</b> cursors measure vertical amplitude and horizontal time parameters simultaneously at the point the cursor intersects a waveform. The cursor intersect point tracks waveform amplitude changes.</p> <p><b>V Bars</b> are vertical cursors that measure horizontal parameters (typically time). They are not associated with the waveform, but show the time position of the cursor in the waveform record.</p> <p><b>H Bars</b> are horizontal cursors that measure amplitude (typically in volts or amperes). They are not associated with the waveform, but show the amplitude position of the cursor.</p> <p><b>V&amp;H Bars</b> cursors measure vertical and horizontal parameters simultaneously. They are not associated with the waveform, but show the time and amplitude position of the cursors.</p>
<b>Source Waveform</b>	<p>Tap to select the source waveform (the waveform on which to display the cursors).</p> <p><b>Same</b> places both cursors on the same waveform.</p> <p><b>Split</b> allows each cursor to be on a different waveform.</p> <p>Available when <b>Cursor Type</b> is <b>Waveform</b>.</p> <p>If <b>Source</b> is set to <b>All</b> then the <b>Source Waveform</b> is unavailable.</p>
<b>Readout Type</b>	<p>Tap to select the type of readout to display for a XY or XYZ plot. This control is only available when the <b>Cursor Type</b> is set to <b>Waveform</b> or <b>V&amp;H Bars</b>.</p> <p><b>Rectangular</b> displays the position values and the difference (delta) between cursors.</p> <p><b>Polar</b> displays the polar information for each cursor. The top value is the magnitude of the vector drawn from the origin of the plot to the location of the cursor. The bottom value is the angle of the vector drawn from the origin of the plot to the location of the cursor.</p>
<b>Source</b>	<p>Tap to select the source waveform from the drop-down list. <b>Selected Waveform</b> automatically moves the waveform cursors to the selected source or select a specific source from the drop-down list.</p> <p>Available when <b>Source Waveform</b> is <b>Same</b>.</p> <p><b>All</b> is available in <b>Source</b> drop-down list only when the <b>Cursor Type</b> is set to <b>Waveform</b>.</p> <p><b>All</b> waveforms includes time domain based math waveforms, reference waveforms, trend waveforms, etc.</p>
<b>Cursor A Source, Cursor B Source</b>	<p>Tap to select the waveform sources for Cursor A and B.</p> <p>Available when <b>Source Waveform</b> is <b>Split</b>.</p>
<b>Cursor A X-Position</b>	<p>Tap to set a specific x-axis position for Cursor A using the multipurpose knob, or double-tap to set the position using the keypad.</p>
<b>Cursor B X-Position</b>	<p>Tap to set a specific x-axis position for Cursor B using the multipurpose knob, or double-tap to set the X-Position using the keypad.</p>

Table continued...

Field or control	Description
<b>Cursor A Y-Position</b>	Tap to set a specific Y-axis position for Cursor A using the multipurpose knob, or double-tap to set the position using the keypad.  Available when <b>Cursor Type</b> is <b>H Bars</b> or <b>V&amp;H Bars</b> .
<b>Cursor B Y-Position</b>	Tap to set a specific Y-axis position for Cursor B using the multipurpose knob, or double-tap to set the X-Position using the keypad.  Available when <b>Cursor Type</b> is <b>H Bars</b> or <b>V&amp;H Bars</b> .
<b>Cursor Mode</b>	Tap to select the cursor mode.  <b>Independent</b> mode sets multipurpose knobs A and B to move each cursor separately.  <b>Linked</b> mode sets multipurpose knob A to move both cursors at the same time. Knob B will still move cursor B independently of knob A.

## Date and Time configuration menu

Use this menu to set the date, time format, and time zone.

To open the Date and Time configuration menu, double-tap on the Date/Time badge in the lower-right corner of the oscilloscope display.

### Date and Time configuration menu fields and controls

Field or control	Description
<b>Display</b>	Tap to toggle display of the date and time On or Off.  When turned off, double-tap on the blank area below the Run/Stop button, in the lower-right corner of the oscilloscope display, to open the configuration menu and set display to On.
<b>Time Format</b>	Tap to select either 12 Hour or 24 Hour time format.
<b>Time Zone</b>	Tap and select the desired time zone from the drop-down list.
<b>Automatically adjust clock for Daylight Saving Time</b>	Sets the oscilloscope to automatically change the time to account for Daylight Saving Time changes.



**Note:** You cannot set a specific time; the time is preset at the factory.

## Digital channel configuration menu

Use the digital channel menu to enable individual digital channels, set their thresholds (individually or as a group), and add labels.

To open the digital channel configuration menu, double-tap a digital channel badge. You can also double-tap on the digital channel handles to open the menu.

### Digital channel settings fields and controls

Field or control	Description
<b>Display</b>	Tap to toggle display of the channel <b>On</b> and <b>Off</b> .

Table continued...

Field or control	Description
<b>Label</b>	Enter label text for the overall FlexChannel data channel.
<b>Height</b>	Sets the relative height of the digital waveform on the screen. Available when <b>Waveform View mode</b> is <b>Overlay Display Mode</b> .
<b>D7-D0 Bit</b>	Tap to toggle individual channels (bits) <b>On</b> or <b>Off</b> and remove them from the display.
<b>D7-D0 Threshold</b>	Sets threshold level values for individual data channels.
<b>D7-D0 Label</b>	Enter label text for individual data channels. The label is shown to the right of the corresponding digital channel.
<b>Turn All Off</b>	Turns off the digital channel and removes the Digital channel badge from the bar.
<b>Set All Thresholds</b>	Use to set all data channels to the same threshold value. Enter a value in the field and tap the button.

### Right-click menu differences

A right click (touch and hold) on the digital FlexChannel waveform handle opens a menu to turn off that instrument channel, configure the overall digital channel settings, or add a label to the digital FlexChannel.

A right click (touch and hold) on the handle of individual digital bits in a digital channel waveform opens a menu to turn off that digital bit, configure the overall digital channel settings, or add a label to the individual bit.

### See also

[Analog channel configuration menu](#)

## More (DRAW A BOX Menu)

Use this menu to toggle the Waveform view box draw mode between Zoom area mode, Visual Trigger area mode, and Mask segment mode.

To use the **More (DRAW A BOX)** menu:

1. Double-tap the **More** button (located at the top right of the Results Bar) to open the **DRAW A BOX** window.
2. Tap **Zoom** on the **DRAW A BOX** window to enable drawing a zoom box area on the screen. The mode stays in Zoom mode until changed.
3. Tap **Visual Trigger** on the draw a box window to enable drawing Visual Trigger areas on the screen. Draw a Box mode stays in **Visual Trigger** mode until changed.
4. Tap **Mask** on the **DRAW A BOX** window to enable drawing Mask Testing segments on the screen. The mode stays in **Mask** mode until changed.
5. Tap **Waveform Histogram** on the DRAW A BOX window to draw the waveform histogram on the waveform. Draw a Box mode stays in **Waveform Histogram** mode until changed.
6. Tap outside the menu. The **DRAW A BOX** icon changes to reflect the function available when you next select the **DRAW A BOX** icon.

### See also

[Turn on Zoom mode](#) on page 165

[Visual Trigger concepts](#) on page 636

[Create Visual Trigger areas](#) on page 130

[Edit visual trigger areas on the screen](#) on page 130

[Edit visual trigger areas using the Area menu](#) on page 132

[Mask testing waveforms](#)

## DVM configuration menu

Use this menu to set up the optional digital voltmeter (DVM) function to use probes to measure AC, DC, or AC+DC voltages.

To open the digital voltmeter menu:

1. If the DVM is Off, tap the **DVM** badge on the Settings bar. This adds a DVM badge to the top of the Results Bar, using the source that was selected the last time the DVM was added to the Results bar.
2. If the DMV is On, double-tap the **DVM** badge to open its configuration menu.



**Note:** Selecting a source in the DVM configuration menu does not automatically turn on (display) the source channel if the source channel is not already on.

### DVM configuration menu fields and controls

Field or control	Description
<b>Display</b>	Tap to toggle the DVM badge On and Off.
<b>Autorange</b>	Tap to toggle autoranging On and Off. Autorange is not available when the oscilloscope is triggering on the same channel that is being measured.
<b>Source</b>	Tap to select the channel to measure from the drop-down list. The DVM can only measure analog channels.
<b>Mode</b>	Tap to select measuring DC, AC RMS, or DC+AC RMS measurement modes.
<b>Show Basic Statistics in Badge</b>	Tap to toggle showing DVM measurement statistics in the DVM badge.

## Horizontal configuration menu

Use this menu to select the horizontal mode, set horizontal parameters, and enable trigger delay.

To open the **Horizontal** configuration menu, double-tap the **Horizontal** badge in the Settings bar.

### Horizontal configuration menu fields and controls

Field or control	Description
<b>Horizontal Mode</b>	Tap to select either Automatic or Manual horizontal mode.  In <b>Automatic</b> mode you can set the <b>Minimum Sample Rate</b> and <b>Horizontal Scale</b> .  In <b>Manual</b> mode you can set the Sample Rate and Record Length. Horizontal Scale is a dependent variable calculated from the sample rate and record length.

Table continued...

Field or control	Description
<b>FastAcq</b>	<p>Tap to toggle <b>FastAcq</b> mode <b>On</b> or <b>Off</b>.</p> <p><b>FastAcq</b> provides high-speed waveform capture. It is helpful in finding elusive signal anomalies. Fast Acq mode reduces the dead time between waveform acquisitions, enabling the capture and display of transient events such as glitches and runt pulses. Fast Acq mode can also display waveform phenomena at an intensity that reflects their rate of occurrence.</p> <p>During waveform save if FastAcq is on, the pixmap data is saved into the file (not sampled waveform data or vector) but the saved data cannot be recalled.</p> <p>The FastAcq supports only .csv file format.</p> <p> <b>Note:</b> If the waveforms are overlapping while saving the FastAcq data, use Stacked Display mode without turning on the zoom.</p>
<b>FastAcq Palette</b>	<p>Tap and select the desired FastAcq Palette from the drop-down list.</p> <p><b>Temperature</b> uses color-grading to indicate frequency of occurrence, with hot colors like red/yellow indicating frequently occurring waveform data points, and colder colors like blue/green indicating rarely occurring data points.</p> <p><b>Spectral</b> uses color-grading to indicate frequency of occurrence with, colder colors like blue indicating frequently occurring waveform data points, and hot colors like red indicating rarely occurring data points.</p> <p><b>Normal</b> uses the default channel color (like yellow for channel one) along with gray-scale to indicate frequency of occurrence where frequently occurring events are bright.</p> <p><b>Inverted</b> uses the default channel color (like yellow for channel one) along with gray-scale, but inverts color intensity such that events that occur less frequently are brighter.</p> <p>Available when <b>FastAcq</b> is <b>On</b>.</p>
<b>Minimum Sample Rate</b>	<p>Sets the minimum sample rate for acquisitions. Changing horizontal scale will not reduce the sample rate below this value. This can result in partial waveform records at lower frequencies, but at the same time would provide more sample points for a few cycles of the signal.</p> <p>Available when <b>Horizontal Mode</b> is <b>Automatic</b> and <b>FastAcq</b> is <b>Off</b>.</p> <p>This setting can be overridden if <b>Allow Horizontal Scale to Override Min Sample Rate</b> is selected.</p>
<b>Allow Horizontal Scale to Override Min Sample Rate</b>	<p>Select to set the oscilloscope to automatically change the sample rate to acquire a full waveform record. Changes to the sample rate are shown in the Horizontal badge readout, not in the Minimum Sample rate field of the menu.</p> <p>Available when <b>Horizontal Mode</b> is <b>Automatic</b> and <b>FastAcq</b> is <b>Off</b>.</p>
<b>Maximum Record Length</b>	<p>Tap and select the Maximum Record Length from the drop-down list.</p> <p>Record length is dependent on the Scale setting. If changing the scale causes the record length to exceed the maximum record length Limit, the sample rate is decreased to the next available setting to keep the record length below the set maximum.</p> <p>Available when <b>Horizontal Mode</b> is <b>Automatic</b> and <b>FastAcq</b> is <b>On</b>.</p>

Table continued...



Field or control	Description
<b>Allow Horizontal Scale to Override Max Record Length</b>	Select to set the oscilloscope to automatically change the record length to acquire a full waveform record. Changes to the sample rate are shown in the Horizontal badge readout, not in the Minimum Sample rate field of the menu.  Available when <b>Horizontal Mode</b> is <b>Automatic</b> and <b>FastAcq</b> is <b>On</b> .
<b>Horizontal Scale</b>	Tap to set the Horizontal Scale using the assigned multipurpose knob, double-tap to set the scale using the virtual keypad, or tap the up and down arrows. You can also use the front-panel Horizontal Scale knob to change this value.  The horizontal scale determines the size of the acquisition window relative to the waveform. You can scale the window to contain a single waveform edge, a single cycle, several cycles, or thousands of cycles.
<b>Delay</b>	Delay positions the trigger event to a specified time relative to the center of the waveform record. Use delay to focus on events that occur before (pre-trigger) or after the trigger point (post-trigger).
<b>Position</b>	Tap to set the trigger Position using the assigned multipurpose knob or double-tap to set the Position using the virtual keypad.  When horizontal Delay is on, the time from the trigger point to the horizontal reference (center of waveform record) is the horizontal delay. The horizontal position determines the number of pre-trigger and post-trigger samples in the waveform record.  When horizontal delay is off, the trigger point and the horizontal reference are at the same time in the middle of the waveform record.
<b>Set to 0 s</b>	Tap to set the delay position to 0 s (center of the waveform record).  Available only when <b>Delay</b> is <b>On</b> .
<b>Set to 10%</b>	Tap to set the trigger delay to 10% of the waveform record.  Available only when <b>Delay</b> is <b>Off</b> .
<b>Sample Rate Changes Affect</b>	Tap to allow changes to the Sample Rate to affect either the Horizontal Scale or the Record Length.  Available only when <b>Horizontal Mode</b> is <b>Manual</b> .
<b>Sample Rate</b>	Tap to set the Sample Rate using the assigned multipurpose knob, double-tap to set the rate using the virtual keypad, or tap the up and down arrows. This keeps the oscilloscope at the specified sample rate regardless of the horizontal or record length settings. This limits the available horizontal scale settings to those that can be used with the specified sample rate.  Available only when <b>Horizontal Mode</b> is <b>Manual</b> .
<b>Record Length</b>	Tap to set the Record Length using the assigned multipurpose knob, double-tap to set the length using the virtual keypad, or tap the up and down arrows.  Available only when <b>Horizontal Mode</b> is <b>Manual</b> .

## Mask Badge configuration menu

Use the Mask Badge configuration menu to set the total number of eye diagram mask hits needed to fail the mask test.

**Prerequisite:** An Eye Diagram plot with a mask enabled. See [Add Mask Testing to an Eye Diagram plot](#) on page 103.

To open the Mask Badge configuration menu, double-tap a **Mask** badge in the Results column.

## Mask Badge configuration menu fields and controls

Field or control	Description
Total	Sets the total number of hits needed to fail an eye mask test.

## Mask Definition configuration menu

Use the Mask Definition menu to edit mask segment parameters. Double tapping a mask segment opens the Mask Definition configuration menu.

To open the **Mask Definition** menu, double-tap on a mask segment.

To create a mask segment, see [Create a Mask](#) on page 157

## Mask Settings panel fields and controls

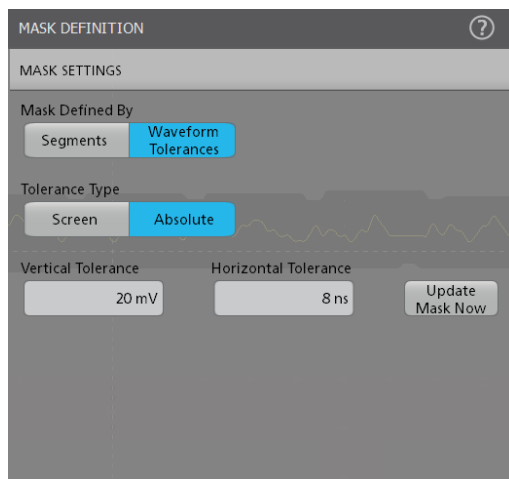
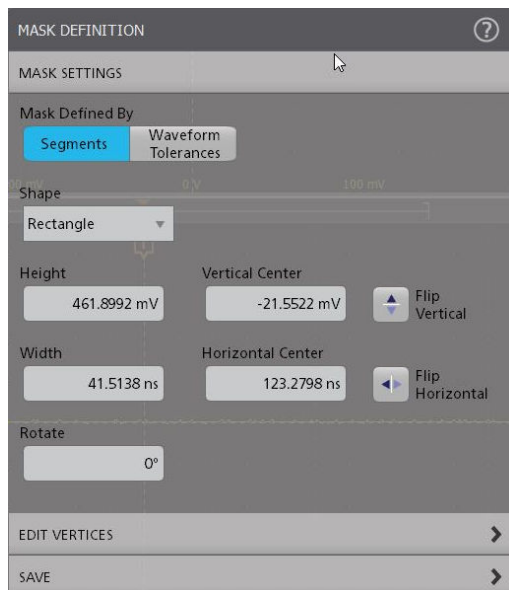

Field or control	Description
<b>Mask Defined By</b>	Define the way you edit the mask. The default option is <b>Segments</b> .
<b>Shape</b>	Lists the current shape type, and also lets you change the current shape to a specified shape. Changing a shape defines the minimum rectangle that includes all vertices of the current segment, and then does a best-fit approach to create the specified shape.  If you made changes to a default shaped segment that results in an segment that no longer meets the default shape definition, that segment is listed as a Custom shape in the menu.
<b>Height</b>	Sets the segment height, in amplitude units, between the topmost vertex and the bottommost vertex.
<b>Vertical Center</b>	Sets the segment vertical center, in amplitude units, as the point halfway between the topmost vertex and bottommost vertex.
<b>Flip Vertical</b>	Flips the segment vertically around its Vertical Center value.
<b>Width</b>	Sets the segment width, in time units, between the leftmost vertex and the rightmost vertex.
<b>Horizontal Center</b>	Sets the segment horizontal center, as time units, as the point halfway between the leftmost vertex and rightmost vertex.
<b>Flip Horizontal</b>	Flips the segment horizontally around its Horizontal Center value.
<b>Rotate</b>	Rotates the segment in units of degrees, from 0° to 360°.  The rotation is an absolute angle measurement referenced from 0°, where 0° is the position of the segment when it was first created. For example, if you rotate the segment 40°, and then rotate it again with 20°, the resulting segment rotation is 20°.  The segment height and width are relative to the current segment orientation, and automatically change places as needed when the segment is rotated.
<b>Tolerance Type</b>	Sets the tolerance type as <b>Screen</b> or <b>Absolute</b> . Default type is screen.
<b>Vertical Tolerance</b>	Tap the Vertical Tolerance field and enter the tolerance value as divisions of the current channel settings (volts, amps, and so on). Or double-tap on the field and use the A knob to change the value.
<b>Horizontal Tolerance</b>	Tap the Horizontal Tolerance field and enter the tolerance value as divisions of the current channel settings (volts, amps, and so on). Or double-tap on the field and use the A knob to change the value.
<b>Update Mask Now</b>	Updates the mask as per the configured tolerance values.

### Edit Vertices panel fields and controls

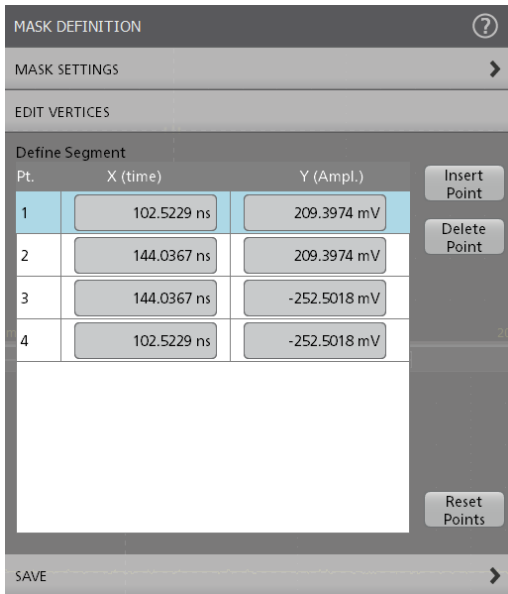

Field or control	Description
<b>Define Segment</b>	<p>A table that lists the X (time) and Y (amplitude) values for each vertex (point) of the segment. Use the scroll bar to show points if there are more than nine points in the segment.</p> <p>Selecting a row in the table highlights the associated vertex on the segment.</p> <p>Use the Multipurpose knobs to change the value of the X or Y settings, or double-tap a setting and enter the value directly.</p>
<b>Insert Point</b>	<p>Inserts a new row above the selected row and creates a new vertex on the segment shape. The new vertex is halfway between the vertices defined in the prior row and the following row in the table.</p>
<b>Delete Point</b>	<p>Deletes the currently selected point, keeps the row selected, and moves all rows below it up one row.</p> <p>The <b>Delete Point</b> button is not available when a triangular segment is selected.</p>
<b>Reset Points</b>	<p>Deletes all but three data points from the table. The remaining three data points are set to a default triangle, set to two divisions for height and width, and centered in the waveform area.</p>



**Note:** Redo and Undo are available for most Edit Vertices panel controls.

## Save panel fields and controls

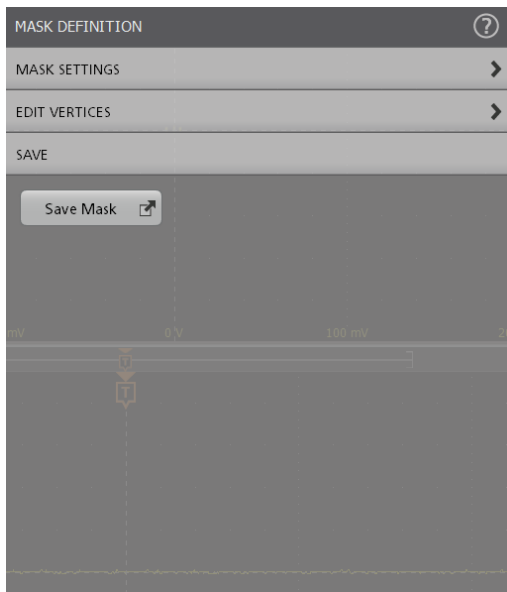

Field or control	Description
Save Mask	Saves the mask in the desired location with the given file name.

## Mask Definition right click menu

See [Right click menu functions associated with mask segments](#) on page 458.

## Save As configuration menu (Save Mask)

Use the Save As configuration menu to set the location and file name to which to save the contents of a mask, as a .xml format file.

To open the Save As configuration menu to save a mask to a file:

1. Double-tap anywhere on the mask to open the Mask Definition configuration menu.
2. Tap **Save Mask**.

## Save As menu, Mask Save fields and controls

Field or control	Description
Save Location	<p>Sets the location of the save file. The default value is the last location to which a file was saved.</p> <p>Tap on the file path and use a keyboard to enter a new save location. Or double-tap on the file name to open the virtual keyboard and enter a path.</p> <p>Tap the down arrow icon on the right end of the field to open a list of recent file save locations, for the current save type, up to a maximum of 20 locations.</p>
Browse	Tap to open the Browse Save As Location dialog, to navigate to and select the location to save the file to. See <a href="#">Browse Save As Location configuration menu</a> on page 477.

Table continued...

Field or control	Description
File Name	Sets the file name of the file. The default file name is Tek000. The file name increments on the next save (Tek001, Tek002, and so on).  Tap on the file name and use a keyboard to enter a new file name. Or double-tap on the file name to open the virtual keyboard and enter a file name.
Save as Type	You can save segment mask as .xml file and tolerance mask as .tol file.

## Right click menu functions associated with mask segments

The following mask definition functions are available when you right click on a mask segment.

### Mask Segments controls

Field or control	Description
Triangle	Sets the shape of the mask to a triangle.
Rectangle	Sets the shape of the mask to a rectangle
Trapezoid	Sets the shape of the mask to a trapezoid.
Hexagon	Sets the shape of the mask to a hexagon.
Custom	Sets the shape of your choice.
Create Duplicate	Creates a new segment with the same characteristics.
Configure Segment	Opens the Mask Definition configuration menu for the selected segment.
Delete Segment	Deletes the selected segment.
Delete All	Deletes all segments associated with the mask.

### Tolerance Mask controls

Field or control	Description
Configure Mask	Opens the Mask Definition configuration menu for the selected mask.
Delete Mask	Deletes the selected mask.

## Mask Test badge configuration menu

Use the Mask Test badge menu to edit the settings of a mask test and define the actions to be taken according to the results.

To open the **Mask Test** badge configuration menu, double-tap on the badge.

A Mask Test badge is created when the first segment of a mask is defined.

### Test Settings panel fields and controls

Field or control	Description
Mask Test	Turns the mask test <b>On</b> or <b>Off</b> .

Table continued...

Field or control	Description
<b>Mask Display</b>	Turns the mask display <b>On</b> (default) or <b>Off</b> .
<b>Label</b>	The text field to add a label to the mask test badge. By default, this field is blank. When you recall a mask from a file, the name of the file is automatically displayed in the label field.
<b>Source</b>	Lists the valid source signals for mask testing. Valid sources do not include other sources that are already being used in mask tests.
<b>Show segment hits in badge</b>	A checkbox to display the hits on each segment in the badge. By default, the setting is unchecked.
<b>Number of Waveforms</b>	The numeric field to define the number of waveforms to test against. This value is shared amongst all mask tests. Changing the value in one badge changes it in all mask test badges. This field can be used along with the <b>Single / Seq Stops After</b> control to run a mask test with 100 waveforms ten times.
<b>Total Failures</b>	The numeric field to set the failure threshold in number of acquisitions. The value must be greater than or equal to Consecutive Failures.
<b>Consecutive Failures</b>	The numeric field to set the failure threshold in number of consecutively failing acquisitions. The value must be less than or equal to Total Failures.
<b>Act on Event</b>	Tap the <b>Act on Event</b> button to configure the actions the instrument must take when a Mask event occurs (Pass, Fail, or Hits). See <a href="#">Act On Event configuration menu</a> on page 178 for the available fields and controls.

## Mask Test badge right click menu

See [Right click menu functions associated with the Mask Test badge](#) on page 459.

## Right click menu functions associated with the Mask Test badge

The following functions are available when you right click on a mask test badge.

Field or control	Description
Configure Mask Test	Opens the Mask Test badge configuration menu for the selected badge.
Delete Mask Test	Deletes the selected mask test badge.

## Math configuration menu overview

Math waveforms are created by combining and/or mathematically transforming source waveforms into a new waveform for analysis. Use this menu to create math waveforms (basic or advanced) or add an FFT (Fast Fourier Transform) waveform to the screen.

To access a Math configuration menu, double-tap a **Math** waveform badge on the Settings bar. If no Math badge is present, tap the **Add New Math** button to add a Math waveform and open the configuration menu.

Use the following links to access information on the Math waveform menus and settings.

[Math configuration menu](#) on page 460

[Equation Editor \(Math configuration menu\)](#) on page 464

[Add Filter menu \(math Equation Editor\)](#) on page 465

[Add Variable menu \(math Equation Editor\)](#) on page 466

## Math configuration menu

Use this menu to set math waveform parameters, create basic and advanced math waveforms, or add an FFT (Fast Fourier Transformation) plot to analyze frequency components of a waveform.

To access the Math menu, double-tap a **Math** waveform badge. If no Math badge is present, tap the **Add New Math** button to add a math waveform and open the menu.

### Math configuration menu fields and controls

Field or control	Description
<b>Display</b>	Turns the math waveform or FFT plot <b>On</b> or <b>Off</b> .
<b>Vertical Scale</b>	Sets the vertical graticule scale units. Tap the arrows to change the value, tap and use the assigned multipurpose knob to change values, or double-tap to open the virtual keypad to enter a specific value.  Available when <b>Auto Scale</b> is disabled (unchecked) and <b>Math Type</b> is <b>Basic</b> or <b>Advanced</b> .
<b>Auto Scale</b>	Toggles Auto Scale mode on or off. Auto Scale calculates the vertical scale and position to center and display the entire waveform.  Available when <b>Math Type</b> is <b>Basic</b> or <b>Advanced</b> .
<b>Label</b>	Enter a label for the math waveform.
<b>Position</b>	Sets the vertical position of the math waveform.  Available when <b>Math Type</b> is <b>Basic</b> or <b>Advanced</b> .
<b>Set to 0</b>	Sets the vertical position of the math waveform to zero (vertical center of a slice (Stacked mode) or the screen (Overlay mode).  Available when <b>Math Type</b> is <b>Basic</b> or <b>Advanced</b> .
<b>Alternate Units</b>	Sets user-specified units to display on vertical scale readouts and measurement badges.
<b>Average</b>	Toggles averaging the waveform <b>On</b> and <b>Off</b> . Use averaging to reduce noise on the waveform.
<b>Number of Averages</b>	Sets the number of waveform acquisitions to average. Tap and use the assigned multipurpose knob to set the value.  Available when <b>Average</b> is <b>On</b> .

Table continued...







Field or control	Description
<b>Math Type</b>	<p>Sets the type of math waveform to display.</p> <p><b>Basic</b> creates a math waveform by adding, subtracting, multiplying, or dividing two analog waveforms.</p> <p> <b>Note:</b> You cannot mix time and frequency sources for basic math waveforms. To create a spectrum basic math waveform, both sources must be spectrum waveforms. The spectrum math waveform is added in a new slice in the Spectrum View window.</p> <p><b>Filter</b> creates user defined IIR and FIR filters on analog waveform. Double-tap on the Create/Edit Filter to open its configuration menu. See <a href="#">Create/Edit filter configuration menu</a> on page 462 for the filter configuration menu.</p> <p><b>FFT</b> opens an FFT view of the specified signal to display the frequency components of that signal. Double-tap on the FFT view to open its configuration menu. See <a href="#">Math FFT plot configuration menu (Math waveform)</a> on page 525.</p> <p> <b>Note:</b> You cannot create an FFT math waveform from a spectrum trace waveform source.</p> <p><b>Advanced</b> displays a drop-down from which to select the 20 last-accessed equations created by the Equation Editor. This mode also provides access to the Equation Editor. See <a href="#">Equation Editor (Math configuration menu)</a> on page 464.</p> <p> <b>Note:</b> You cannot create an advanced math waveform using a spectrum trace waveform source.</p>
<b>Source, Source1, Source 2</b>	<p>Defines the signal source or sources for a <b>Basic</b>, <b>FFT</b> or <b>Filter</b> math waveform.</p> <p>Basic, FFT, and Filter math waveforms are created from analog channels only (Ch, Math, or Ref).</p> <p>Available when <b>Math Type</b> is <b>Basic</b>, <b>FFT</b>, or <b>Filter</b>.</p> <p> <b>Note:</b> You cannot mix time and frequency sources for basic math waveforms. To create a spectrum basic math waveform, both sources must be spectrum waveforms.</p>
Basic math operation list	<p>Located between the <b>Source 1</b> and <b>Source 2</b> fields. A drop-down list to select a basic math operation (add, subtract, multiply, divide) to apply to the two sources.</p> <p>Available when <b>Math Type</b> is <b>Basic</b>.</p>
<b>Interpolation</b>	<p>Select to display the record points between the sampled points. Default is unchecked. Available when <b>Math Type</b> is <b>Basic</b> and <b>Source 1</b> is <b>Bus</b>. Interpolation uses Sin(x)/x method.</p> <p>Sin(x)/x connects using a Sin(x)/x curve between the computed values. This makes the gain or phase curve smoother than linear interpolation.</p>
<b>Field</b>	<p>Select the field for the selected bus. Default is Data. Available when <b>Math Type</b> is <b>Basic</b> and <b>Source 1</b> is <b>Bus</b>.</p>
<b>Signed Data</b>	<p>Sets the data as signed decimal. Default is unchecked.</p>

Table continued...

Field or control	Description
<b>Math n =</b>	<p>Lists the last-accessed advanced equation. Tap the down arrow to display a list of the last-accessed equations (up to a maximum of 20) created by the <b>Equation Editor</b>. Select an equation to display that math waveform.</p> <p>Tap <b>Edit</b> to open the <b>Equation Editor</b> to edit the displayed equation. You can also double-tap on an equation in this field and directly edit the equation using the virtual keyboard. See <a href="#">Equation Editor (Math configuration menu)</a> on page 464.</p> <p>Available when <b>Math Type</b> is <b>Advanced</b>.</p>
<b>Edit</b>	<p>Opens the <b>Equation Editor</b> to create advanced math waveforms from analog channels, reference, math waveform, measurement, filter, and variable sources.</p> <p>Tap the <b>Edit</b> button to open the <b>Equation Editor</b>. See <a href="#">Equation Editor (Math configuration menu)</a> on page 464.</p> <p>Available when <b>Math Type</b> is <b>Advanced</b>.</p>
<b>Create/Edit Filter</b>	<p>Open the Filter Editor to create user defined IIR and FIR filters and their responses from analog source. Tap the Create/Edit Filter button to open the Filter Editor. See <a href="#">Create/Edit filter configuration menu</a> on page 462 for the filter configuration menu.</p>

### Math waveform guidelines

- Digital channels are not valid in math waveforms.
- You can take measurements on math waveforms in the same way as on channel waveforms.
- Math waveforms derive their horizontal scale and position from the sources in their math expressions. Adjusting these controls for the source waveforms also adjusts the math waveform.
- You cannot create an **FFT** math waveform from a spectrum trace waveform source.
- You cannot mix time and frequency sources for basic math waveforms. To create a spectrum basic math waveform, both sources must be spectrum waveforms.
- You cannot create an advanced math waveform using a spectrum trace waveform source.
- You can Zoom on math waveforms.

### Create/Edit filter configuration menu

Use the create/edit filter menu to design IIR or FIR filter for a given signal. This menu also allows you to save the configured filter into a file and recall in the future.

To access the Create/Edit Filter menu:

1. Double-tap a Math waveform badge on the Settings bar. If no Math badge is present, tap the **Add New Math** button to add a Math waveform and open the configuration menu.
2. Set Math Type to **Filter**.
3. Tap **Create/Edit Filter** to open the Create/Edit menu.



**Note:** If the filter is created successfully for the first time or any filter file is loaded previously, the control **Create Filter** is changed to **Edit Filter**.



Field or Control	Description
<b>Filter Type</b>	Select the required filter type from the drop-down. <b>Low-Pass, High-Pass, Band-Pass, Band-Stop, All-Pass, Hilbert, Differentiator, Raised Cosine, Root-Raised Cosine.</b>
<b>Filter Response</b>	Select the required filter response from the drop-down. <b>Butterworth, Chebyshev I, Chebyshev II, Elliptical, Gaussian, Bessel-Thompson, Custom.</b>
<b>Filter Order</b>	Enter the filter order value in the text field. Supported filter order value for IIR is 8 and below and for FIR is 5001 and below. Filter order is auto-computed for custom filter.
<b>Cutoff frequency</b>	Enter the cutoff frequency value in the text field. Available only when <b>Filter Type</b> is <b>Low Pass</b> or <b>High-Pass</b>
<b>Low Cutoff Frequency</b>	Enter the low cutoff frequency value in the text field. Available only when <b>Filter Type</b> is <b>Band-Pass</b> or <b>Band-Stop</b>
<b>High Cutoff Frequency</b>	Enter the high cutoff frequency value in the text field. Available only when <b>Filter Type</b> is <b>Band-Pass</b> or <b>Band-Stop</b>
<b>Pass Band Ripple</b>	Enter the Pass Band Ripple value in the text field. Available only when <b>Filter Response</b> is <b>Chebyshev I</b> or <b>Elliptical</b>
<b>Transition Width</b>	Enter the transition width value in the text field. Default value is 15 MHz. For low-pass filters the transition width cannot exceed $(0.45 \cdot SR) - \text{cutoff} - 1$ . For high-pass filters it cannot exceed the cutoff frequency. For band-pass and band-stop, the transition width is minimum of lower cutoff or $(0.5 \cdot SR - \text{high cutoff})$ . Available only when <b>Filter Response</b> is <b>Custom</b> .
<b>Stop Band Attenuation</b>	Enter the stop band attenuation value in the text field. Available only when <b>Filter Response</b> is <b>Chebyshev II</b> or <b>Elliptical</b>
<b>Delay</b>	Enter the delay value. The unit is in seconds. Delay in seconds introduces the appropriate time delay on the filtered output MATH waveform which is equivalent to the phase shift in the frequency domain.
<b>Standard Deviation</b>	The standard deviation defines the Gaussian filter window width.
<b>Symbols</b>	Enter the number of symbols in the text field by which the filter span. Symbols value is $>0$ . Default value is 1. Available only when <b>Filter Type</b> is <b>Raised Cosine</b> or <b>Root-Raised Cosine</b>
<b>Symbol Duration</b>	Enter the symbol duration value in the text field. Symbol duration is $>0$ . Default value is 10 ns.  <b>Note:</b> Enter input data signal period for proper filter response. Available only when <b>Filter Type</b> is <b>Raised Cosine</b> or <b>Root-Raised Cosine</b>
<b>Roll-off Factor</b>	Enter the roll-off factor value in the text field. Roll off factor is a floating number between 0 to 1. Default value is 1. Available only when <b>Filter Type</b> is <b>Raised Cosine</b> or <b>Root-Raised Cosine</b>

Table continued...

Field or Control	Description
<b>Filter response image</b>	Displays the selected filter responses. <ul style="list-style-type: none"> <li>• Magnitude and Phase Response</li> <li>• Impulse Response</li> <li>• Step Response</li> </ul>
<b>Apply Filter</b>	Tap to apply filter, generated on the input source and filtered waveform is shown in MATH. This button is disabled after you apply the filter by tapping <b>Apply Filter</b> , until a new filter is generated.  <b>Note:</b> If MATH waveform is empty then filter is not applied and error is shown. You may need to adjust the S/R or any filter design parameters accordingly.
<b>Load Filter File</b>	Tap to recall the previously saved filter file. In Load Filter window, you can select <b>View filter response image</b> to recall filter response along with the filter file. Supported filter file format is .flt.
<b>Save Filter To File</b>	Tap to save the created filter into a file for future use. In Save Filter window, user can select <b>Save filter response image</b> to save filter response along with the filter file. Supported filter file format is .flt.
<b>Generate Filter</b>	Tap to generate the filter and to update the filter response. This button is disabled after you generate the filter by tapping <b>Generate Filter</b> , until any changes are made to the configurations.
<b>Abort</b>	Tap to stop or cancel the filter design during filter designing flow.

**See also**

[User Defined Filter](#) on page 652

[User defined filter errors and warnings](#) on page 727

**Equation Editor (Math configuration menu)**

Use the Equation Editor to build your advanced math waveform expression using sources, operators, constants, measurements, variables, filters, and functions.

To access the math Equation Editor:

1. Double-tap a **Math** waveform badge. If no Math badge is present, tap the **Add New Math** on the Setting bar to add a Math waveform and open the configuration menu.
2. Set Math Type to **Advanced**.
3. Tap **Edit** to open the Equation Editor.

**Equation Editor menu fields and controls**

Field or control	Description
<b>Sources</b>	Lists all available sources that you can add to an equation. Tap a source icon to add it to the cursor position in the Math x = input box. Drag the sources field up or down to scroll through selections. If a source column is empty, there are no active or defined sources for that category.
<b>Add Filter</b>	Tap to open the <b>Add Filter</b> menu, to create a filter definition to add to the <b>Filters</b> source column in the <b>Equation Editor</b> menu. See <a href="#">Add Filter menu (math Equation Editor)</a> on page 465.

Table continued...

Field or control	Description
<b>Add Variable</b>	Tap to open the <b>Add Variable</b> menu, to add a defined variable to the <b>Variables</b> source column in the <b>Equation Editor</b> menu. See <a href="#">Add Variable menu (math Equation Editor)</a> on page 466.
<b>Functions</b>	Select the math functions to apply to your signal or signals. See <a href="#">Add Functions (math Equation Editor)</a> on page 467.
<b>Keypad</b>	Use to enter numeric, basic math operations, and logic conditions.
<b>Math &lt;x&gt; =</b>	The field that lists the equation components that you add with the equation controls for the numbered Math waveform. You can also directly edit this field.
<b>Clear</b>	Clears the math equation field.
<b>Arrows</b>	Use to move the cursor position in the <b>Math &lt;x&gt; =</b> equation field.
<b>Delete</b>	Deletes the selected part of the equation (recommend that you use a mouse to more easily select equation text).
<b>Backspace</b>	Deletes the character to the left of the cursor.
<b>Apply</b>	Tap to apply the math expression shown in the <b>Math &lt;x&gt; =</b> field and display the math waveform. The first ~ eight characters of the equation also appears in the Math badge on the Settings bar.  When the editor detects a logic or syntax error with the equation, the editor displays an error message, along with the character position in the equation where the editor considers the error to have occurred.
<b>Cancel</b>	Closes the editor menu, does not update the equation list if you made any changes from the last time you Applied or OK'd an equation.
<b>OK</b>	Applies the equation to the math waveform, closed the Advanced Editor window, and adds the equation to the available equation list.

### Equation editor guidelines

- Math definitions are not applied if the sources are not valid.
- Syntax or other equation or source errors display a short error message on the Math configuration menu.
- Use parentheses to group terms in the expression to control execution order, for example,  $5*(Ch1 + Ch2)$ .

### Add Filter menu (math Equation Editor)

Use the Add Filter menu to add a high pass, low pass, or arbitrary filter expression to the Filters column of the Equation Editor Sources table.

To access the Add Filter menu:

1. Double-tap a Math waveform badge on the Settings bar. If no Math badge is present, tap the **Add New Math** button to add a Math waveform and open the configuration menu.
2. Set Math Type to **Advanced**.
3. Tap **Edit** to open the Equation Editor.
4. Tap **Add Filter** to open the Add Filter menu.

### Add Filter menu fields and controls

Field or control	Description
<b>Filter Type</b>	Sets the filter type: <b>High Pass</b> , <b>Low Pass</b> , or <b>ArbFit</b> (arbitrary filter). ArbFit requires you to load a FLR-format filter file.  If loading a filter file, tap Load to navigate to and select the FLR file to load.
<b>Cutoff Frequency</b>	Sets the filter cutoff frequency as a predefined fraction of the sample rate (SR).  Default is $0.25 * SR$ .
<b>Label</b>	Shows the filter selections as A:B, where A is the filter type (HP or LP) and B is cutoff frequency setting.  Arbitrary filter files use the file name as the label.

### Add Variable menu (math Equation Editor)

Use the Add Variable menu to add a defined variable source to the Equation Editor Sources table, which you can then add to your math waveform expression.

To open the Add Variable menu:

1. Double-tap a Math waveform badge on the Settings bar. If no Math badge is present, tap the **Add New Math** button to add a Math waveform and open the configuration menu.
2. Set Math Type to **Advanced**.
3. Tap **Edit** to open the Equation Editor menu.
4. Tap **Add Variable** to open the Add Variable menu.

### Add Variable menu fields and controls

Field or control	Description
<b>Variable Type</b>	Selects a predefined variable to add to the Variables column of the Equation Editor.  <b>Sample Rate</b> creates a variable with the value of the current sample rate.  <b>Sample Interval</b> creates a variable with the value of the current sample interval (1/sample rate)  <b>Record Length</b> creates a variable with the value of the current record length.
<b>Cancel</b>	Closes the menu without adding a variable to the <b>Equation Editor</b> Variables column.
<b>OK</b>	Closes the menu and adds the current variable selection to the Variables column of the <b>Equation Editor's Sources</b> table.

## Add Functions (math Equation Editor)

Use the Add Functions controls to add predefined math operations to your math waveform equation.













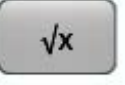



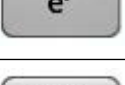
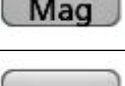



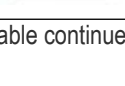

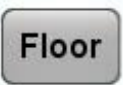
Button	Description
	Integral. Inserts the text <code>INTG(</code> into the math expression. Enter an argument to the function. The integral function produces the integral of the argument.
	Base 10 logarithm. Inserts the text <code>LOG(</code> into the math expression. Enter an argument to the function. The log function produces the base 10 logarithm of the argument.
	Square root. Inserts the text <code>SQRT(</code> into the math expression. Enter an argument to the function.
	Absolute. Inserts the text <code>FABS(</code> into the math expression. The FABS function takes the absolute value of the expression.
	Derivative. Inserts the text <code>DIFF(</code> into the math expression. Enter an argument to the function. The derivative function produces the derivative of the argument.
	Natural logarithm. Inserts the text <code>LN(</code> into the math expression. The natural logarithm function produces the natural logarithm of the argument.
	Natural antilog. Inserts the text <code>EXP(</code> into the math expression. The EXP function produces the natural antilog of the argument.
	FFT Magnitude. Inserts the text <code>FftMag(</code> into the math expression. Select one of the waveforms as an argument to the function. This function creates an FFT waveform that shows the magnitude components of the source signal.
	Inserts the text <code>MAX(</code> into the math expression. The MAX function accumulates, over time, the maximum value at each point in the vector.
	Ceiling function. Inserts the text <code>CEIL(</code> into the math expression. CEIL returns the smallest integer that is $\geq$ the expression within the parenthesis.
	Inserts the text <code>INV(</code> into the math expression. Enter an argument or channel to the function. The invert function inverts the argument within the parentheses.
	FFT Phase. Inserts the text <code>FftPhase(</code> into the math expression. Select one of the waveforms as an argument to the function. This function creates an FFT math waveform that shows the phase components of the source signal.

Table continued...

Button	Description
	Inserts the text MIN( into the math expression. The MIN function accumulates over time the minimum value at each point in the vector.
	Floor function. Inserts the text FLOOR( into the math expression. FLOOR returns the largest integer that is $\leq$ the expression within the parenthesis.
	FFT Real. Inserts the text FftReal( into the math expression. Select one of the waveforms as an argument to the function. This function creates an FFT math waveform that displays only the real part of the source signal.
	FFT Imaginary. Inserts the text FftImaginary( into the math expression. Select one of the waveforms as an argument to the function. This function creates an FFT math waveform that displays only the imaginary part of the source signal.
	Inserts the text SIN( into the math expression.
	Inserts the text COS( into the math expression.
	Inserts the text TAN( into the math expression.
	Arc sine. Inserts the text ASIN( into the math expression.
	Arc cosine. Inserts the text ACOS( into the math expression.
	Arc tangent. Inserts the text ATAN( into the math expression.
	Degrees. Inserts the text DEG( into the math expression. The function expresses the value of the expression in degrees.
	Radians. Inserts the text RAD( into the math expression. The function expresses the value of the expression in Radians.



## Menu bar overview

The Menu bar provides access to file, utility, and help functions.

### The Menu bar

Field or control	Description
<b>File</b>	<p>Provides typical system file management operations such as opening, saving, moving, and renaming files. See the links after this table for more information.</p> <p>See <a href="#">Recall configuration menu (File menu)</a> on page 470.</p> <p><b>Save</b> saves current waveform, session, or setup file.</p> <p>See <a href="#">Save As configuration menu (File menu)</a> on page 474.</p> <p>See <a href="#">File Utilities configuration (File menu)</a> on page 480.</p> <p><b>Autoset</b> executes an immediate Autoset operation. See <a href="#">Autoset to quickly display a waveform</a> on page 85 .</p> <p><b>Default Setup</b> immediately restores the oscilloscope to factory default settings. See <a href="#">Using Default Setup</a>.</p> <p><b>Restart</b> powers off the oscilloscope and restarts the oscilloscope.</p> <p><b>Shutdown</b> powers off the oscilloscope.</p>
<b>Edit</b>	<p>Provides a menu to Undo or Redo the last operation. See the links after this table for more information.</p> <p>See <a href="#">Undo, Redo (Edit menu)</a> on page 486.</p>
<b>Utility</b>	<p>Use to set user preferences, configure input, output, and network settings, run self tests, verify calibration status and run signal path compensation, and erase nonvolatile memory. See the links after this table for more information.</p> <p>See <a href="#">User Preferences (Utility menu)</a> on page 486.</p> <p>See <a href="#">I/O (Utility menu)</a> on page 493.</p> <p>See <a href="#">Self Test configuration menu (Utility menu)</a> on page 497.</p> <p>See <a href="#">Calibration configuration menu (Utility menu)</a> on page 497.</p> <p>See <a href="#">Security configuration menu for standard instruments (Utility menu)</a> on page 498.</p>
<b>Application</b>	<p>Use to access installed software applications. This menu only appears when testing applications are installed on the oscilloscope. Only valid for Windows OS installations. See the links after this table for more information.</p> <p>See <a href="#">Application (Menu bar)</a> on page 486.</p>
<b>Help</b>	<p>Opens the Help viewer, displays current instrument software, See the links below for more information.</p> <p>See <a href="#">Help... (Help menu)</a> on page 503.</p> <p>See <a href="#">About (Help menu)</a> on page 503.</p>

## Recall configuration menu (File menu)

Use this menu to recall (load) reference waveforms, instrument setups, mask settings, and sessions (setup plus waveforms). The supported file formats are .wfm, .trc, .isf, .tr0, .wfmx, .set, .tss, .msk, .xml, .bin, and .csv.

## File operations and Microsoft Windows 10 Operating System SSD

Instruments with Windows 10 SSD will display the standard Windows file tools to navigate to and select files and folders.

The Windows operating system assigns the first available drive letter (typically E:) to the first USB device attached to the oscilloscope, regardless of which port the USB device is plugged into. The next plugged-in USB device is assigned the next available drive letter (such as F:) and so on for other installed devices. This is different from standard instruments (without Windows 10 installed), which assign a non-changing drive letter to each USB port.

Use the following methods to recall a file:

- Double-tap the file you want to recall from file explorer. This will open the file in the ScopeApp. In case if the file does not open with ScopeApp then follow the below procedure.
  1. Right click the file you want to recall and select **Open with**.
  2. In the **How do you want to open this file?** window select **Always use this app to open <filetype> files** box and tap **More apps > Look for another app on this PC**.
  3. Navigate to path **C:\Program Files\Tektronix\TekScope\scopeapp.exe** and tap **Open**.
- Drag and drop the file from file explorer to the ScopeApp to open the file.

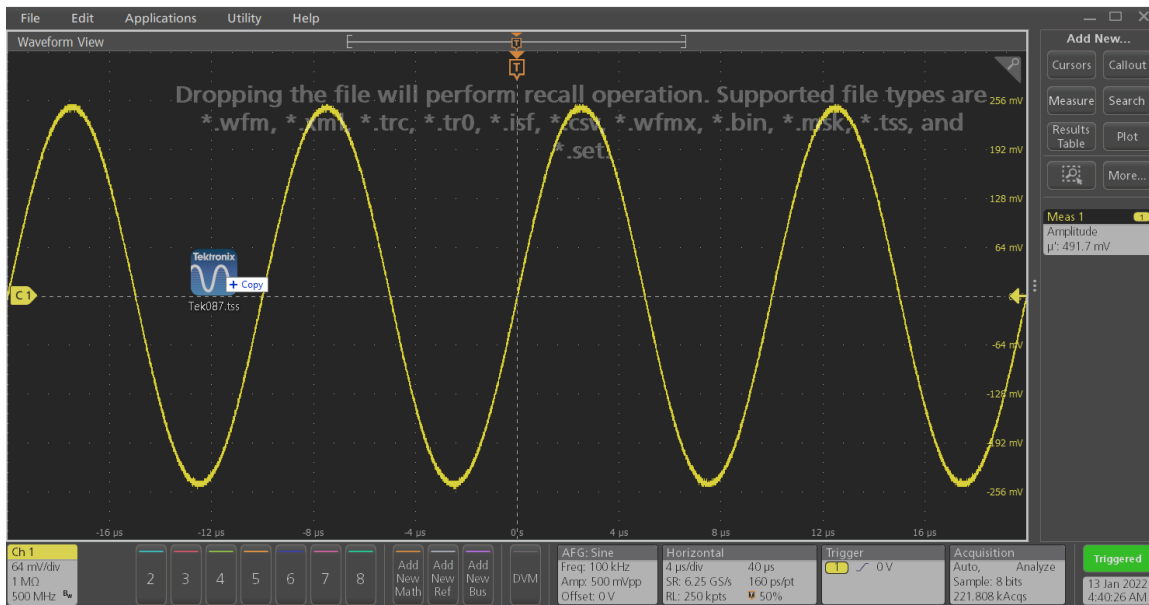

- Right-click the file to recall from file explorer.
- Use the Recall configuration menu.
  1. Tap **File** on the menu bar.
  2. Tap **Recall** to open the Recall configuration menu.

## Recall configuration menu fields and controls





Field or control	Description
Look in:	<p>Shows the current directory path to the location of a file.</p> <p>Tap on the file path and use a keyboard to enter a new save location. Or double-tap on the file name to open the virtual keyboard and enter a path.</p> <p>Tap the down arrow icon on the right end of the field to open a list of recent file save locations, up to a maximum of 20 locations.</p>
File type to open (tabs)	<p>Tabs on the left let you set which type of file to recall (Waveform, Setup, Mask, or Session).</p> <p>Selecting a file type sets the file extensions in the Files of Type field to the correct value.</p>
	<p>The Drive column lists the directory structure, opening at the root (/) level. Use to quickly navigate to a location.</p> <p>Tap to list the contents of the directory in the Name pane.</p> <p>Double-tap an item to display the directory and any subdirectories under it. Double-tap again to close that directory structure.</p> <p>Drag the list up and down to show more entries.</p>
File/Folders list view	<p>List all files or folder for currently selected directory. List view displays more details about file, folder such as Name, Size, Modified date and time, Type, etc.</p> <p>The image file formats supported for are .PNG, .JPG, and .BMP.</p>
Preview	<p>Displays the selected image in the directory on the preview pane. The image file formats supported for displaying are .PNG, .JPG, and .BMP.</p> <p>Displays the preview for the image file inside the selected session file in the directory on the preview pane. The session file format supported for displaying is .TSS only.</p> <p>Double click on the image file name in the directory or the previewed image to open and display the image widely. This feature is not supported for .TSS file format.</p> <p> <b>Note:</b> When multiple image files are selected in the directory, the last selected image will be displayed in the preview pane.</p>
	<p>Use the arrow buttons to navigate the file directory.</p> <p>The left arrow navigates back to the previously visited folder.</p> <p>The Right arrow navigates forward to the previously visited folder.</p> <p>The Up arrow navigates up one level from the current folder.</p>
	<p>Use to create a new directory (folder) at the current location. Opens the new directory after it is created.</p>

Table continued...

Field or control	Description
File name	Lists the selected file name.
Files of type	Use to select the file format you want to open. The drop-down list shows all file extension types that the instrument can read for the selected file type.
Cancel	Cancels the file open action and closes the configuration menu.
Recall	<p>Recalls the selected file.</p> <p>Recalling a waveform file adds a Reference waveform badge to the Settings bar and displays the waveform as it fits in the current Horizontal setting.</p> <p>Recalling a Setup or Session immediately sets the oscilloscope to the settings in the file and displays any waveforms that were part of the recalled session.</p>

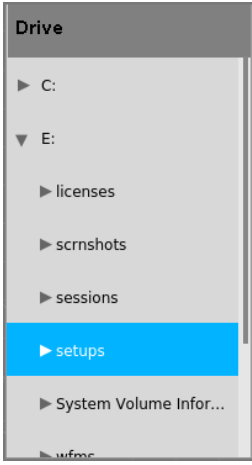
### USB port drive names and locations

Use the following table to determine which drive to select when navigating to and/or selecting a file on system memory or a connected USB memory device.

Drive name	Drive letter	Drive or physical USB port location
<b>MSO44B and MSO46B</b>		
Root drive	C	User-accessible memory on the oscilloscope.
Front panel	E	USB 2.0 (top)
	F	USB 2.0 (middle)
	G	USB 2.0 (bottom)
Rear panel	H	USB 3.0 (left)
	I	USB 3.0 (right)

Drive name	Drive letter	Drive or physical USB port location
<b>MSO44 and MSO46</b>		
Root drive	C	User-accessible memory on the oscilloscope.
Front panel	E	USB 2.0 (top)
	F	USB 2.0 (middle)
	G	USB 2.0 (bottom)
Rear panel	H	USB 2.0 (left)
	I	USB 2.0 (right)

Drive name	Drive letter	Drive or physical USB port location
<b>MSO54, MSO56, MSO58, MSO54B, MSO56B, MSO58B, MSO64, LPD64, MSO64B, MSO66B, and MSO68B without Windows OS</b>		
Root drive	C	User-accessible memory on the oscilloscope.
Front panel	E	USB 3.0 (left)
	F	USB 2.0 (center)
	G	USB 2.0 (right)

Table continued...

Drive name	Drive letter	Drive or physical USB port location
Rear panel	H	USB 2.0 (top)
	I	USB 2.0 (bottom)
	J	USB 3.0 (top)
	K	USB 3.0 (bottom)
<b>Instruments with Windows OS</b>		
Root drive	C	User-accessible memory on the oscilloscope.
USB ports	<b>Dynamic port letter assignment</b>	If Windows operating system is installed, the Windows operating system assigns the first available drive letter (typically E:) to the first USB device attached to the oscilloscope, regardless of which port the USB device is plugged into. The next plugged-in USB device is assigned the next available drive letter (such as F:) and so on for other installed devices.  Use standard Windows procedures to mount and access network drives.

Drive name	Drive letter	Drive or physical USB port location
<b>MSO58LP without Windows OS</b>		
Root drive	C	User-accessible memory on the oscilloscope.
Front panel	E	USB 3.0 (left)
	F	USB 2.0 (right)
Rear panel	G	USB 2.0 (top)
	H	USB 2.0 (bottom)
	I	USB 3.0 (top)
	J	USB 3.0 (bottom)
<b>Instruments with Windows OS</b>		
Root drive	C	User-accessible memory on the oscilloscope.
USB ports	<b>Dynamic port letter assignment</b>	If Windows operating system is installed, the Windows operating system assigns the first available drive letter (typically E:) to the first USB device attached to the oscilloscope, regardless of which port the USB device is plugged into. The next plugged-in USB device is assigned the next available drive letter (such as F:) and so on for other installed devices.  Use standard Windows procedures to mount and access network drives.

Drive name	Drive letter	Drive or physical USB port location
<b>LPD64 without Windows OS</b>		
Root drive	C	User-accessible memory on the oscilloscope.
Front panel	F	USB 3.0 (left)
	E	USB 2.0 (center)
	G	USB 2.0 (right)

Table continued...

Drive name	Drive letter	Drive or physical USB port location
Rear panel	H	USB 2.0 (top)
	I	USB 2.0 (bottom)
	J	USB 3.0 (top)
	K	USB 3.0 (bottom)

## Save As configuration menu (File menu)

Use this menu to configure saving screen captures, waveforms, oscilloscope setups, reports, and session files.

To access the **Save As** configuration menu, tap **File** on the menu bar and select **Save As...**

**Note:** Selecting **File > Save** the first time after powering up the oscilloscope opens the **Save As** configuration menu. This lets you set or verify the save locations for all types of information you can save.



Once the **Save As** configuration menu has been opened and closed, the next time you select **Save** causes the instrument to automatically save the file type last selected in the **Save As** configuration menu. This lets you quickly save files with a simple menu selection.

## File operations and Microsoft Windows 10 Operating System SSD

Instruments with Windows 10 SSD will display the standard Windows file tools to navigate to and select files and folders.

The Windows operating system assigns the first available drive letter (typically E:) to the first USB device attached to the oscilloscope, regardless of which port the USB device is plugged into. The next plugged-in USB device is assigned the next available drive letter (such as F:) and so on for other installed devices. This is different from standard instruments (without Windows 10 installed), which assign a non-changing drive letter to each USB port.

## Save As configuration menu fields and controls

The following fields and controls are common to all Save As actions.

Field or control	Description
<b>File save type</b>	Tabs on the left let you set which type of file to save ( <b>Screen Capture</b> , <b>Waveform</b> , <b>Setup</b> , <b>Report</b> , or <b>Session</b> ). Selecting a file type sets the file extensions in the Save As Type field to the correct value.
<b>Save Location</b>	Lists the location where the file will be saved. The default value is the last location to which a file was saved.  Tap on the file path and use a keyboard to enter a new save location. Or double-tap on the file name to open the virtual keyboard and enter a path.  Tap the down arrow icon on the right end of the field to open a list of recent file save locations for the current save type.
<b>Browse</b>	Tap to open the <b>Browse Save As Location</b> configuration menu, to navigate to and select the location to which to save the file. See <a href="#">Browse Save As Location configuration menu</a> on page 477 .

Table continued...

Field or control	Description
<b>File Name</b>	<p>The file name assigned to the file. The default value is either the user-entered name used to last save this file type, or a numeric value calculated by the instrument if this file type has not previously been saved with a custom file name. The default value is Tek000.</p> <p>Tap the down arrow on the right edge of the field to display and select from a list of recently-saved file names.</p> <p>Tap on the file name and use a keyboard to enter a new file name. Or double-tap on the file name to open the virtual keyboard and enter a file name.</p>
<b>Auto Increment File Name</b>	<p>Select to enable auto-incrementing of the file name. Auto increment adds a number count to the end of the file name, and increments it on each subsequent saving of the same file name.</p> <p>You can enable auto-incrementing of the file name for saving files to/from local/network/USB/TekDrive file storage locations.</p>
<b>Count</b>	Sets the increment count start number. Default is 000.
<b>Save As Type</b>	<p>Lists the available formats to which you can save files. The available save formats are set by the type of file being saved.</p> <p>Tap the field and select the save format.</p>
<b>Cancel</b>	Cancels the file save action and closes the configuration menu.
<b>OK</b>	Saves the file to the specified location, closes the Save As configuration menu, and displays a confirmation message.

### Screen Capture tab fields and controls

The following settings are specific for saving a screen capture

Field or control	Description
<b>File save type</b>	Tap the <b>Screen Capture</b> tab to save a screen image to a file. Selecting Screen Capture sets the file extensions in the Save As Type field to available graphic file formats.
<b>Save As Type</b>	<p>Lists the available formats to which you can save files. The available save formats are set by the type of file being saved.</p> <p>Tap the field and select the graphic save format.</p>

To save screen captures with waveforms on a white background, tap **Utility>User Preferences** and set **Screen Capture** Colors to **Inverted**. When you save the next screen capture, the display inverts colors for just a moment, saves the displayed image to the file, and returns the screen to normal colors. This capability is useful to save ink on printouts of screen captures. See the **Display** panel settings in [User Preferences \(Utility menu\)](#) on page 486.

### Waveform tab fields and controls

The following settings are specific for saving a waveform.

Field or control	Description
<b>File save type</b>	Tap the <b>Waveform</b> tab to save waveform(s) to a file. Selecting <b>Waveform</b> sets the file extensions in the <b>Save As Type</b> field to available waveform file formats.

Table continued...

Field or control	Description
<b>Save As Type</b>	Lists the available formats to which you can save files. The available save formats are set by the type of file being saved.  Tap the field and select the graphic save format.
<b>Source</b>	Sets the waveform source to save. You can save a single waveform, or save all active (displayed) waveforms.  Waveform file names include the source channel or waveform appended to the end of the file name.
<b>Display as next available Ref waveform</b>	Sets the waveform to be saved and automatically opened (displayed) as the next available reference waveform. It doesn't matter what type of file is saved, that waveform will be opened as a Ref waveform. If gating is in use, a smaller, gated waveform is saved and displayed.  This control is not present when source is set to <b>All</b> .
<b>Gating</b>	Sets the method to save a specified part of the waveform data.  <b>None</b> saves the full waveform data (default).  <b>Cursors</b> saves the waveform data located between the vertical cursors. If cursors aren't on when selecting cursor gating, the cursors are activated.  <b>Screen</b> saves the waveform data that is on the screen.  <b>Resample</b> saves the waveform data at a sample interval set by the user. The resulting saved waveform is a resampled version of the original waveform with fewer data points.  Gating notes: <ul style="list-style-type: none"> <li>• Default Setup restores Gated Save to its default setting (None).</li> <li>• The state of Gated Save gets saved in Setup and Session files.</li> <li>• Gated saves do not work on plot waveform data.</li> <li>• Gating cannot be used to save waveform data while in Fast Frame mode.</li> </ul>

### Setup tab fields and controls

The following settings are specific for saving an instrument setup.

Field or control	Description
<b>File save type</b>	Tap the <b>Setup</b> tab to save the instrument setup and measurement settings to a file. Selecting Setup sets the file extension in the Save As Type field to .set.
<b>Include Reference Waveforms</b>	Include the instrument waveforms.

### Report tab fields and controls

The following settings are specific for saving an instrument report.

A report can include information on instrument settings, measurement results, screen images, individual measurement configuration, source input settings, and error and warning information for measurements. Reports are either a PDF file or a single file Web page.

Field or control	Description
<b>File save type</b>	Tap the <b>Report</b> tab to save a report file. Selecting Report sets the file extensions in the Save as Type field to available report file formats.

Table continued...



Field or control	Description
<b>Save As Type</b>	Lists the available formats to which you can save files. The available save formats are set by the type of file being saved.  Tap the field and select the report save format (PDF or Single File Web Pages).
<b>Append Report</b>	Appends a report to an existing report file.
<b>Comments</b>	Add comments to clarify the contents or purpose of the report, or specifics of the signals being measured.
<b>Include Images and Annotations</b>	Add Waveform and Plot images to the report.
<b>Include Setup Configuration</b>	Add instrument and measurement configuration information to the report.

### Session tab fields and controls

The following settings are specific for saving an instrument session.

A session is a zipped file that contains an instrument setup file and all acquired waveform data. Use session file contents to move analysis activities to a PC and free up the instrument for others to use.

Field or control	Description
<b>File save type</b>	Tap the <b>Session</b> tab to enable saving a session file. Selecting Session sets the file extensions in the Save As Type field to .tss.
<b>Save As Type</b>	A session file can only be saved to format .tss.

### Browse Save As Location configuration menu

Use this menu to select a new file location to save files.

To access the Browse Save As Location configuration menu:





1. Select **File > Save As...**
2. In the Save As configuration menu, tap the **Browse** button.

### File operations and Microsoft Windows 10 Operating System SSD

Instruments with Windows 10 SSD will display the standard Windows file tools to navigate to and select files and folders.

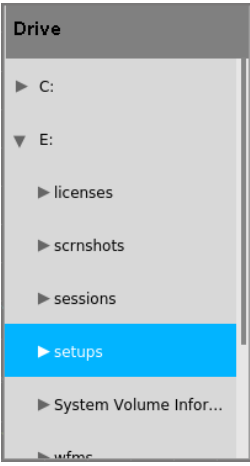
The Windows operating system assigns the first available drive letter (typically E:) to the first USB device attached to the oscilloscope, regardless of which port the USB device is plugged into. The next plugged-in USB device is assigned the next available drive letter (such as F:) and so on for other installed devices. This is different from standard instruments (without Windows 10 installed), which assign a non-changing drive letter to each USB port.

## Browse Save As Location configuration menu fields and controls

Field or control	Description
<p><b>File path field</b></p>	<p>Shows the current directory.</p> <p>Tap on the file path and use a keyboard to enter a new path. Or double-tap on the file name to open the virtual keyboard and enter a path.</p> <p>Tap the down arrow icon on the right end of the field to open a list of recently accessed file save paths, for the current save type, up to a maximum of 20 paths.</p>
	<p>The Drive column lists the directory structure, opening at the root level. Use to quickly navigate to a location.</p> <p>Tap to list the contents of the directory in the Name pane.</p> <p>Double-tap an item, or tap the small arrow to the left of the directory, to display the subdirectories under it. Double-tap again to close that directory structure.</p> <p>Drag the list up and down to show more entries.</p>
<p><b>Preview</b></p>	<p>Displays the selected image in the directory on the preview pane. The image file formats supported for displaying are .PNG, .JPG, and .BMP.</p> <p>Displays the preview for the image file inside the selected session file in the directory on the preview pane. The session file format supported for displaying is .TSS only.</p> <p>Double click on the image file name in the directory or the previewed image to open and display the image widely. This feature is not supported for .TSS file format.</p> <p> <b>Note:</b> When multiple image files are selected in the directory, the last selected image will be displayed in the preview pane.</p>
	<p>Use the arrow buttons to navigate the file directory.</p> <p>The left arrow navigates back to the previously visited folder.</p> <p>The Right arrow navigates forward to the previously visited folder.</p> <p>The Up arrow navigates up one level from the current folder.</p>
	<p>Use to create a new directory (folder) at the current location. Opens the new directory after it is created.</p>
<p><b>Cancel</b></p>	<p>Cancels the file path change, closes the configuration menu, and returns to the Save As configuration menu. No file path change occurs.</p>
<p><b>OK</b></p>	<p>Closes the configuration menu, returns to the Save As configuration menu, and updates the Save Location field with the path from the Browse configuration menu.</p>

## USB port drive names and locations

Use the following table to determine which drive to select when navigating to and/or selecting a file on system memory or a connected USB memory device.

Drive name	Drive letter	Drive or physical USB port location
<b>MSO44B and MSO46B</b>		
Root drive	C	User-accessible memory on the oscilloscope.
Front panel	E	USB 2.0 (top)
	F	USB 2.0 (middle)
	G	USB 2.0 (bottom)
Rear panel	H	USB 3.0 (left)
	I	USB 3.0 (right)

Drive name	Drive letter	Drive or physical USB port location
<b>MSO44 and MSO46</b>		
Root drive	C	User-accessible memory on the oscilloscope.
Front panel	E	USB 2.0 (top)
	F	USB 2.0 (middle)
	G	USB 2.0 (bottom)
Rear panel	H	USB 2.0 (left)
	I	USB 2.0 (right)

Drive name	Drive letter	Drive or physical USB port location
<b>MSO54, MSO56, MSO58, MSO54B, MSO56B, MSO58B, MSO64, LPD64, MSO64B, MSO66B, and MSO68B without Windows OS</b>		
Root drive	C	User-accessible memory on the oscilloscope.
Front panel	E	USB 3.0 (left)
	F	USB 2.0 (center)
	G	USB 2.0 (right)
Rear panel	H	USB 2.0 (top)
	I	USB 2.0 (bottom)
	J	USB 3.0 (top)
	K	USB 3.0 (bottom)
<b>Instruments with Windows OS</b>		
Root drive	C	User-accessible memory on the oscilloscope.
USB ports	<b>Dynamic port letter assignment</b>	If Windows operating system is installed, the Windows operating system assigns the first available drive letter (typically E:) to the first USB device attached to the oscilloscope, regardless of which port the USB device is plugged into. The next plugged-in USB device is assigned the next available drive letter (such as F:) and so on for other installed devices.  Use standard Windows procedures to mount and access network drives.

Drive name	Drive letter	Drive or physical USB port location
<b>M5058LP without Windows OS</b>		
Root drive	C	User-accessible memory on the oscilloscope.
Front panel	E	USB 3.0 (left)
	F	USB 2.0 (right)
Rear panel	G	USB 2.0 (top)
	H	USB 2.0 (bottom)
	I	USB 3.0 (top)
	J	USB 3.0 (bottom)
<b>Instruments with Windows OS</b>		
Root drive	C	User-accessible memory on the oscilloscope.
USB ports	<b>Dynamic port letter assignment</b>	If Windows operating system is installed, the Windows operating system assigns the first available drive letter (typically E:) to the first USB device attached to the oscilloscope, regardless of which port the USB device is plugged into. The next plugged-in USB device is assigned the next available drive letter (such as F:) and so on for other installed devices.  Use standard Windows procedures to mount and access network drives.

Drive name	Drive letter	Drive or physical USB port location
<b>LPD64 without Windows OS</b>		
Root drive	C	User-accessible memory on the oscilloscope.
Front panel	F	USB 3.0 (left)
	E	USB 2.0 (center)
	G	USB 2.0 (right)
Rear panel	H	USB 2.0 (top)
	I	USB 2.0 (bottom)
	J	USB 3.0 (top)
	K	USB 3.0 (bottom)

## File Utilities configuration (File menu)

Use this menu to copy, paste, delete, and rename files, and unmount memory devices from USB ports.

To access the **File Utilities** configuration menu, select **File > File Utilities** from the Menu bar.

## File operations and Microsoft Windows 10 Operating System SSD

Instruments with Windows 10 SSD will display the standard Windows file tools to navigate to and select files and folders.

The Windows operating system assigns the first available drive letter (typically E:) to the first USB device attached to the oscilloscope, regardless of which port the USB device is plugged into. The next plugged-in USB device is assigned the next available drive letter (such as F:) and so on for other installed devices. This is different from standard instruments (without Windows 10 installed), which assign a non-changing drive letter to each USB port.

## File Utilities configuration menu fields and controls





Field or control	Description
<p><b>File path field</b></p>	<p>Shows the current directory.</p> <p>Tap on the file path and use a keyboard to enter a new save location. Or double-tap on the file name to open the virtual keyboard and enter a path.</p> <p>Tap the down arrow icon on the right end of the field to open a list of recent file save locations, for the current save type, up to a maximum of 20 locations.</p>
	<p>The Drive column lists the directory structure, opening at the root level. Use to quickly navigate to a location.</p> <p>Tap to list the contents of the directory in the Name pane.</p> <p>Double-tap an item to display the directory and any subdirectories under it. Double-tap again to close that directory structure.</p> <p>Drag the list up and down to show more entries.</p>
<p><b>File/Folders list view</b></p>	<p>List all files or folder for currently selected directory. List view displays more details about file, folder such as Name, Size, Modified date and time, Type, etc.</p> <p>The image file formats supported for are .PNG, .JPG, and .BMP.</p> <p>Double-tap the report file to open in a separate window. The supported formats are .MHT and .PDF. Use left/right arrow to navigate to the previous/next report.</p> <p> <b>Note:</b> The opening report file in a separate window feature is supported only on 5 and 6 Series MSO.</p>
<p><b>Preview</b></p>	<p>Displays the selected image in the directory on the preview pane. The image file formats supported for displaying are .PNG, .JPG, and .BMP.</p> <p>Displays the preview for the image file inside the selected session file in the directory on the preview pane. The session file format supported for displaying is .TSS only.</p> <p>Double click on the image file name in the directory or the previewed image to open and display the image widely. This feature is not supported for .TSS file format.</p> <p> <b>Note:</b> When multiple image files are selected in the directory, the last selected image will be displayed in the preview pane.</p>
	<p>Use the arrow buttons to navigate the file directory.</p> <p>The left arrow navigates back to the previously visited folder.</p> <p>The Right arrow navigates forward to the previously visited folder.</p> <p>The Up arrow navigates up one level from the current folder.</p>

Table continued...

Field or control	Description
	Use to create a new directory (folder) at the current location. Opens the new directory after it is created.
<b>Copy</b>	Copies the selected file in the filename pane to memory. You can copy the Tek files or folders from local/network/USB drives or from TekDrive file storage location.
<b>Paste</b>	Pastes the file from the last Copy action in the current File Utilities session into the current location. You can paste the Tek files or folders to the chosen file target location. The target locations are local/network/USB drives or TekDrive file storage location as well.
<b>Delete</b>	Deletes the selected file or folder.
<b>Rename</b>	Renames the selected file or folder.
<b>Unmount</b>	<p>Unmount the selected drive. Select the drive letter and tap <b>Unmount</b>.</p> <p>For USB drives, <b>Unmount</b> closes the file writing session on the attached USB device to let you disconnect the device from the USB port. The device is also removed from the Drive column of menus that can access drives.</p> <p>For network drives, <b>Unmount</b> removes the network drive connection information from the instrument. The network drive is also removed from the Drive column of menus that can access drives.</p> <p>For TekDrive, <b>Unmount</b> removes the TekDrive connection information from the instrument. The TekDrive is also removed from the Drive column of menus that can access drives.</p>

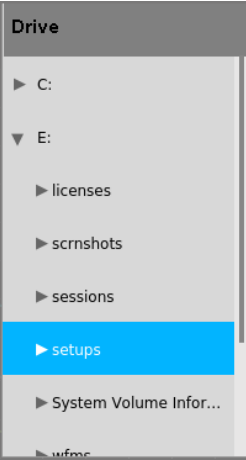
### USB port drive names and locations

Use the following table to determine which drive to select when navigating to and/or selecting a file on system memory or a connected USB memory device.

Drive name	Drive letter	Drive or physical USB port location
<b>MSO44B and MSO46B</b>		
Root drive	C	User-accessible memory on the oscilloscope.
Front panel	E	USB 2.0 (top)
	F	USB 2.0 (middle)
	G	USB 2.0 (bottom)
Rear panel	H	USB 3.0 (left)
	I	USB 3.0 (right)

Drive name	Drive letter	Drive or physical USB port location
<b>MSO44 and MSO46</b>		
Root drive	C	User-accessible memory on the oscilloscope.
Front panel	E	USB 2.0 (top)
	F	USB 2.0 (middle)
	G	USB 2.0 (bottom)
Rear panel	H	USB 2.0 (left)
	I	USB 2.0 (right)

Drive name	Drive letter	Drive or physical USB port location
<b>MSO54, MSO56, MSO58, MSO54B, MSO56B, MSO58B, MSO64, LPD64, MSO64B, MSO66B, and MSO68B without Windows OS</b>		
Root drive	C	User-accessible memory on the oscilloscope.
Front panel	E	USB 3.0 (left)
	F	USB 2.0 (center)
	G	USB 2.0 (right)
Rear panel	H	USB 2.0 (top)
	I	USB 2.0 (bottom)
	J	USB 3.0 (top)
	K	USB 3.0 (bottom)
<b>Instruments with Windows OS</b>		
Root drive	C	User-accessible memory on the oscilloscope.
USB ports	<b>Dynamic port letter assignment</b>	If Windows operating system is installed, the Windows operating system assigns the first available drive letter (typically E:) to the first USB device attached to the oscilloscope, regardless of which port the USB device is plugged into. The next plugged-in USB device is assigned the next available drive letter (such as F:) and so on for other installed devices.  Use standard Windows procedures to mount and access network drives.

Drive name	Drive letter	Drive or physical USB port location
<b>MSO58LP without Windows OS</b>		
Root drive	C	User-accessible memory on the oscilloscope.
Front panel	E	USB 3.0 (left)
	F	USB 2.0 (right)
Rear panel	G	USB 2.0 (top)
	H	USB 2.0 (bottom)
	I	USB 3.0 (top)
	J	USB 3.0 (bottom)
<b>Instruments with Windows OS</b>		
Root drive	C	User-accessible memory on the oscilloscope.
USB ports	<b>Dynamic port letter assignment</b>	If Windows operating system is installed, the Windows operating system assigns the first available drive letter (typically E:) to the first USB device attached to the oscilloscope, regardless of which port the USB device is plugged into. The next plugged-in USB device is assigned the next available drive letter (such as F:) and so on for other installed devices.  Use standard Windows procedures to mount and access network drives.

Drive name	Drive letter	Drive or physical USB port location
<b>LPD64 without Windows OS</b>		
Root drive	C	User-accessible memory on the oscilloscope.

Table continued...

Drive name	Drive letter	Drive or physical USB port location
Front panel	F	USB 3.0 (left)
	E	USB 2.0 (center)
	G	USB 2.0 (right)
Rear panel	H	USB 2.0 (top)
	I	USB 2.0 (bottom)
	J	USB 3.0 (top)
	K	USB 3.0 (bottom)

## Mount Drive configuration menu

Use this menu to connect to a network or TekDrive. The network menu applies to base instrument only (instrument that do not have the Windows 10 OS SSD option installed) and TekDrive menu applies to all the platforms.

To open the **Mount Drive** menu:

1. Select **File > File Utilities** from the Menu bar.
2. Tap **Mount** to open the **Mount Drive** menu.

### Mount Drive configuration menu fields and controls

Field or control	Description
<b>Drive Type</b>	Select the required drive to mount on your instrument. <ul style="list-style-type: none"> <li>• Network</li> <li>• TekDrive</li> </ul>
<b>Network</b>	
<b>Drive Letter</b>	Shows the current list of available (unassigned) drive letters. Tap on the list and select a drive letter to assign to the network drive.
<b>Specify Server</b>	Sets how you specify the server location; by server <b>Name</b> or <b>IP</b> address.
<b>Server Name</b>	The server name is associated with the remote drive. Double-tap the field and enter the server name.
<b>Server IP Address</b>	The IP address of the server. Tap the field and enter the network drive's IP address.
<b>Path</b>	The path to the network drive. Double-tap the field and enter the network drive path information.
<b>User Name</b>	If the drive you are mounting is password-protected, use this field to enter the user name associated with the drive. Double-tap the field and enter the user name.
<b>Password</b>	If the drive you are mounting is password-protected, use this field to enter the password associated with the drive. Double-tap the field and enter the password.
<b>Domain/Workgroup</b>	Sets the Domain/Workgroup of the intranet for the network drive.
<b>Verbose</b>	Tap the Verbose checkbox to get more information in the log file. Default is unchecked.
<b>Cancel</b>	Closes the menu without taking any action.

Table continued...



Field or control	Description
<b>OK</b>	Submits the drive access information to the network drive server. If successful, the menu is dismissed, a confirmation message is displayed, and the drive is added to the <b>Drive</b> column of file menus that access drives.  If not successful, the menu remains on screen and an error message is displayed. Use the error message to resolve the login problem.
<b>TekDrive</b>	
<b>Drive Name</b>	Enter the required drive name for mounting.
<b>Auto Disconnect</b>	Select to configure the duration for the TekDrive connection to be active for usage. <ul style="list-style-type: none"> <li>• <b>PowerCycle</b>: Select to unmount the TekDrive after power cycling the oscilloscope. There is no time restriction when this option is chosen.</li> <li>• <b>Never</b>: Select to mount the TekDrive connection permanently.</li> <li>• <b>Custom</b>: Select to disconnect the TekDrive after a chosen duration.</li> </ul> The default selected is <b>PowerCycle</b> .
<b>Time</b>	Enter the required time for the Auto Disconnect. The mounted TekDrives gets disconnected automatically from the instrument after the specified time.  Available only when <b>Auto Disconnect = Custom</b> .
<b>Restrict connection to current IP Address</b>	Select to enable the restriction of connection to the current IP address. This is performed for security purposes.  Enabled checkbox setting is recommended.  When the checkbox is disabled, the application displays the error: "This setting is recommended, because it restricts TekDrive access to the current public IP Address making your data secure and inaccessible if the device moves to a new network location."
<b>Connect to TekDrive</b>	Select to confirm all the configured settings and connect to the TekDrive.
<b>Code activation controls</b>	
<b>Cancel</b>	Select to close the menu without performing any action and does not connect to the new TekDrive.
<b>Back</b>	Select to take you to the previous menu giving an opportunity before connection, to reconfigure all the input control settings to connect to the TekDrive.
<b>OK, Mount TekDrive</b>	Select to confirm the configuration to complete the TekDrive mounting.  This will make sure all the file browsers in the application show the connected TekDrives in it for saving or recalling files to TekDrive.

## Undo, Redo (Edit menu)

The Edit menu lets you Undo or Redo recent actions. Tap Undo or Redo. Not all oscilloscope actions can be undone. If the Undo or Redo menu items are grayed out, then the last action cannot be undone or redone.

## Application (Menu bar)

Use this menu to access installed software applications. This menu only appears when testing applications are installed on an oscilloscope running the Microsoft Windows operating system (optional).

The Application menu bar item is located between the Edit and Utility menus. Use the drop-down list to select the application software to run. See the application software help for information on using the application.

## User Preferences (Utility menu)

Use this menu to set global display, Autoset, measurement, jitter and eye analysis settings, custom waveform colors, and other user preferences.

To open the **User Preferences** menu:

1. Tap **Utility** menu.
2. Tap **User Preferences** to open the configuration menu.
3. Tap a panel.

## Display panel fields and controls

Field or control	Description
<b>Default Waveform View Display Mode</b>	Sets the default waveform view display mode, either <b>Overlay</b> or <b>Stacked</b> .
<b>Waveform View Graticule</b>	Sets the graticules to be <b>Movable</b> or <b>Fixed</b> for both stacked and overlay modes.  <b>Movable</b> (default) sets graticules to move along with waveforms, and displays graticule units.  <b>Fixed</b> sets graticules so that they do not move when you change a waveform's vertical or horizontal position. <b>Fixed</b> graticule mode also does not display the Vertical and Horizontal graticule labels. Use <b>Cursors</b> to take on-screen measurements.
<b>Displayed Colors</b>	Tap and select either <b>Normal</b> or <b>Inverted</b> colors to set how the instrument displays waveforms and plots.  <b>Normal</b> shows waveforms and plots in color with a back background.  <b>Inverted</b> makes the waveform background white, with graticule markings in black. <b>Inverted</b> does not change the Menu bar, Results bar, or Settings bar colors. Use this setting to save ink on printed screen captures.
<b>Define Custom Colors</b>	Opens the <i>Define Custom Colors</i> menu. This menu lets you change channel, math, and reference waveform colors for both <b>Normal</b> and <b>Inverted</b> display modes.

Table continued...

Field or control	Description
Screen Capture Colors	<p>Sets how the instrument saves screen images (<b>Normal</b> or <b>Inverted</b> colors).</p> <p><b>Normal</b> saves waveforms and plots in the colors as shown on the screen.</p> <p><b>Inverted</b> makes the waveform background white, with graticule marking in black, just for screen saves. <b>Inverted</b> does not change the Menu bar, Results bar, or Settings bar colors. Also, if <b>Displayed Colors</b> is set to <b>Inverted</b>, selecting <b>Inverted</b> for screen saves does not invert the colors back to normal for the screen save; to save normal colors for a screen save, select <b>Normal</b>.</p>
Backlight	<p>Sets the intensity of the backlight.</p> <p> <b>Note:</b> Performing an Autoset resets the backlight value to High.</p>
Auto-Dim	Select <b>On</b> to automatically dim the screen backlight after a specified time.
Time	<p>Sets the amount of time to wait before the display is dimmed. Tap in the field and use the knob to change the time value, or double-tap to open the virtual keypad and set a time value.</p> <p>Available when <b>Auto-Dim</b> is <b>On</b>.</p>

### Autoset panel fields and controls

Field or control	Description
Autoset Adjusts	Selects which controls to change as part of the Autoset operation ( <b>Vertical Settings</b> , <b>Horizontal Settings</b> , <b>Trigger Settings</b> , and <b>Acquisition Settings</b> ). The default is for all adjustments to be enabled.
Autoset in Overlay Display Mode Optimizes	<p>Sets whether to optimize waveform resolution or visibility when doing an Autoset while in the Overlay display mode.</p> <p><b>Resolution</b> uses as much of the ADC's range as possible to provide the best vertical resolution and measurement accuracy, but waveforms will overlap each other.</p> <p><b>Visibility</b> scales and positions waveforms so they are visually separated from each other at the expense of vertical resolution and measurement accuracy.</p>

### Autoset guidelines

- Autoset uses the current trigger source as its reference for various operations such as setting horizontal scale.
- If the current trigger type is **Bus** or **Sequence**, or if trigger type is **Edge** and the trigger source is **AC Line**, Autoset uses the lowest-numbered active channel as its reference.
- Autoset changes the acquisition mode to **Sample**.
- Doing a **Default Setup** operation does not change Autoset panel settings.
- All analysis and measurements abort immediately when an Autoset is started, and then restart upon Autoset completion.

## Measurements panel fields and controls

Field or control	Description
<b>Shared Reference Levels</b>	<p>Tap to select either Global or Per Source reference levels.</p> <p><b>Global</b> applies the same reference levels to all measurement sources.</p> <p><b>Per Source</b> allows selection of a different reference levels for all measurement sources.</p>
<b>Calculate Reference Levels</b>	<p>Tap to select how often to calculate reference levels.</p> <p><b>First Acq</b> only calculates the reference levels on the first acquisition and re-uses them for all subsequent acquisitions. Pushing the Clear front-panel button, or making measurement changes (adding, deleting, or reconfiguring) also clears the reference levels which are then recalculated on the next acquisition.</p> <p><b>Every Acq</b> calculates the reference levels with every acquisition.</p>
<b>Measurement Interpolation</b>	<p>Interpolation defines how the waveform is drawn between waveform record data points. Tap and select the measurement interpolation method.</p> <p><b>Auto</b> selects the best interpolation method.</p> <p><b>Sin(x)/x</b> interpolation computes record points using a curve fit between the actual samples acquired.</p> <p><b>Linear</b> interpolation computes record points between actual acquired samples by using a straight line fit.</p>
<b>Measurement Annotations</b>	<p>Annotations show the exact segments of the waveform from where the chosen measurements are taken. It is a visual aid to debug the signals. There are various markers which denote the measurement annotations such as horizontal bars, vertical bars, triangles (or carets), or arrows.</p> <p><b>Auto</b> sets annotations to display if valid for the measurement. To view annotations for a measurement, select that measurement badge. If annotations are valid for that measurement, they are added to the waveform source for that measurement.</p> <p><b>Off</b> turns off display of measurement annotations.</p> <p>The measurement annotations feature is supported on 4B/5/5B/6/6B Series MSO but not supported on 4 Series MSO.</p>

## Measurement annotations reference

### Supported measurements

- The advanced measurement annotations are shown for all the Amplitude and Time based measurements shown in Standard tab (in the Measurement Selection panel).
- Typically, Amplitude based measurements show the annotations with Top and Base horizontal lines/bars and a caret, signifying where the measurement occurred. Whereas the Time based measurements show reference levels with vertical lines/bars on the waveform cycle.
- On navigation, the annotations move back or forward (on per cycle basis) based on whether you tap Prev/Next buttons.

### Visual elements

- An arrow annotation represents the value of the measurement reference level on the vertical bars.
- The caret type of annotation denotes the time position of the sample point at that location in a waveform record. It is also shown in conjunction with the dotted line pointing towards it, running across the waveform horizontally.
- The vertical lines denotes the start and end of the cycle and the waveform record.
- The horizontal dotted lines correspond to the voltage levels found by the base-top method.

### Miscellaneous

- The measurement annotations are associated with only analog source waveforms (Ch/Math/Ref).
- The setup/session is saved with active measurements and its annotations together. When the setup/session is recalled, it also recalls the user preference settings.
- The measurement annotations are also supported for measurements with History mode on.

### Measurement limits

- The annotations are displayed on the filtered result collection within the limits.
- The limit showing measurement annotations for the measurement result values to those that are within the specified Min - Max range.
- If there are no measurements in the specified range then annotations are disabled.
- If limits are off then the annotations are displayed for the entire measurement result collection.

### Measurement Pass/Fail Testing

- The annotations will be shown on the filtered result collection within the pass/fail test limits.
- If pass/fail testing is on, it limits showing the measurement annotations for the measurement result values that pass the pass/fail test criteria.
- If pass/fail testing is off, the measurement annotations are displayed for all the edges in the acquired waveform record.
- If pass/fail testing is on and badge navigation is set as failures, the annotations will be limited to only for the failed measurement result values.
- If there are no failures found in pass/fail testing, then annotations are disabled.
- If pass/fail is on and badge navigation is set for all occurrences, then the annotations are displayed for all measurement edges/values (irrespective whether it passes/fails).

### Measurement Gating

Annotations work as expected for all the gating types, except for Search and Logic gating.



### Jitter and Eye Analysis panel fields and controls

Field or control	Description
Calculate Reference Levels	Tap to select calculating the reference levels on the first acquisition or on every acquisition.
Horizontal Measurement Units	Tap to select horizontal measurement units of seconds or unit intervals.
Jitter Separation Model	Tap to select the jitter separation model ( <b>Spectral Only</b> or <b>Spectral + BUJ</b> ).
Lock RJ Value	<p>Selecting <b>Lock RJ Value</b> calculates the measurements at the specified random jitter value. The checkbox is unchecked by default.</p> <p>Selecting the checkbox displays a text box where you can enter the RJ value. The default value is 1 ps.</p> <p> <b>Note:</b> Lock RJ Value cannot be configured when Jitter Separation Model is Spectral + BUJ.</p>

## DDR Analysis panel fields and controls

Field or control	Description
Pass/Fail Limits	Turns <b>On</b> or <b>Off</b> the validation of the DDR measurements as Pass/Fail in the measurement results, based on the values in the limits file.  Tap a measurement row in the Results table to view the limit setting and the Pass/Fail status for that measurement.
Limit File Location	Shows the location of the currently-loaded pass/fail limits file. You can navigate to TekDrive to load limit file.
Browse	Tap <b>Browse</b> to open the <a href="#">Browse Save As Location</a> configuration menu to navigate to and select a location at which to save the file.

## Other panel fields and controls

Field or control	Description
Language	Enables displaying the user interface and Embedded Help files in an available language. Tap the field and select the language. The user interface changes immediately to the specified language.   <b>Note:</b> Not all UI terms or Help topics may be translated for new UI or menu items at the time of a firmware release. These items will be translated for a future firmware release.   <b>Note:</b> The Embedded Help files support English, Japanese, Simplified Chinese, and Russian. All other language selections will display the Help topics in English.
Font Size	Sets the font size for UI text elements. Font size range is 12 to 20.
Right Clicks via Touch	Turns <b>On</b> or <b>Off</b> the ability to use touch and hold method to open right-click menus on badges and other screen items.
Time	Sets the time it takes to respond to a touch and hold before opening a right-click menu.
Programmatic Interface Backward Compatibility	Allows you to choose an XML file that ensures backward compatibility of the commands defined in the XML file.  Toggle button turns <b>On</b> or <b>Off</b> the backward compatibility option. Default is Off.  For more information refer to <i>4/5/6 Series Mixed Signal Oscilloscopes Programmer Manual</i> .
Load	Tap to select the XML file. You can navigate to TekDrive to load XML file.  Appears when <b>Programmatic Interface Backward Compatibility</b> is <b>On</b> .
Connected Scope Preferences	Enables the connected oscilloscope with additional capabilities and improves the overall experience while using the oscilloscope.   <b>Note:</b> The oscilloscope should be connected to the Internet.
Oscilloscope tracks feature usage to help reproduce and fix software bugs. User identifiable information, waveform data, analysis results or screenshots are never saved	Enables oscilloscope tracks feature usage to help reproduce and fix software bugs. It will not save user-identifiable information, waveform data, analysis results or screen shots.

## Connected Oscilloscope preferences

Use the Connected Oscilloscope preferences to make you more efficient and improve the overall user experience while using the oscilloscope (4/5/6 Series MSO).

When enabled it provides additional capabilities which improves the overall experience while using the oscilloscope. Whenever the status of checkbox changes it is shared with Tektronix.



**Note:** Enabling this checkbox does not send any information that is used to identify a specific company or individual.

Tektronix will not send any information to the oscilloscope unless you enable **Oscilloscope tracks feature usage to help reproduce and fix software bugs. User identifiable information, waveform data, analysis results or screenshots are never saved.**

When this option is enabled, the oscilloscope will record information about the instrument and its usage. The information includes actions taken in the user or programming interfaces, the model number of the scope, its firmware version, and information about installed options or probe attachments. This information does not include anything that is used to identify a specific company or individual.

This information is stored in a text file on the instrument and is viewed with any text viewing program. Disabling this feature will delete the file. If the instrument is connected to a network while this feature is enabled, this information will be periodically sent to Tektronix.

By enabling this option you agree that the software records anonymous information about the usage of this instrument, and periodically send it to Tektronix.

Tap **Legalese** to view legal information within the legal framework.

Tap **Save Preferences** will save the selected preferences.

Tap **Cancel** to discard the changes.

## Legalese

Tap the Legalese button to view the legal information and details of the functionalities enabled when you check the boxes in the previous dialog (Connected Scope Preferences).

To open the Legalese dialog, select **Utility > User Preferences > Other > Connected Scope Preferences > Legalese**.

### Enabled Connected Scope

When the check box is enabled in **Connected Scope Preferences** dialog: You agree that the software may contact Tektronix servers periodically. You also agree that the instruments model and serial number and status of the enabled check boxes will be sent to Tektronix.

### Oscilloscope tracks feature usage to help reproduce and fix software bugs

When the check box is enabled in **Connected Scope Preferences** dialog: You agree that the software may record anonymous usage information about this instrument and send it to Tektronix. You also agree that the instruments model and serial number and status of the enabled check boxes will be sent to Tektronix.

## DDR Measurement limits file

The following content provides details about the limits file and a sample limit file for DDR.

A limits file contains the measurements and associated limits used to determine the Pass or Fail status for tests. Each limits file includes a list of one or more measurements, and the ranges of acceptable values for any or all statistics for each measurement. The measurement includes combinations of all measurements and statistical characteristics, and an appropriate range of values for each combination.

The application provides preconfigured limits files for many combinations of standards and speed grades. These preconfigured DDR limits files are located at `C:\Users\Public\Tektronix\TekScope\Applications\DDR\Limits`. You can create a limit file by specifying limits for any of the result parameters such as Mean, Std Dev, Max, Min, peak-to-peak, population, MaxPosDelta, and MinPosDelta. For each of these result parameters, you can specify the Upper Limit Equality (UL), and the Lower Limit Equality (LL).

To include pass/fail status in the result statistics, create a custom limits file in the following format using an XML editor or any other editor. If the file is created in any other editor such as Notepad, it should be saved in Unicode format.

The following is a sample limit file of `DDR3_800MHz_Limits.xml`.

```
<?xml version="1.0" encoding="utf-8"?>
<Main>
  <!-- DDR3 800 MHz Limits -->
  <Measurement>
    <NAME>tDH-Diff(base)</NAME>
    <STATS>
      <STATS_NAME>Min</STATS_NAME>
      <LIMIT>LL</LIMIT>
      <UL>0</UL>
      <LL>150e-12</LL>
    </STATS>
  </Measurement>
  <Measurement>
    <NAME>tDS-Diff(base)</NAME>
    <STATS>
      <STATS_NAME>Min</STATS_NAME>
      <LIMIT>LL</LIMIT>
      <UL>0</UL>
      <LL>75e-12</LL>
    </STATS>
  </Measurement>
</Main>
```

## Define Custom Colors menu

Use this menu to change the colors used to display channel, math, and reference waveforms in the Waveform view. You can set custom waveform colors for both Normal and Inverted display modes.

To open the **Define Custom Colors** menu:

1. Tap **Utility > User Preferences** to open the configuration menu.
2. Tap **Define Custom Colors** in the **Display** panel.

### Define Custom Colors menu fields and controls

Field or control	Description
<b>Normal Display Colors</b>	<p>Use this menu to change the waveform colors to use when the instrument is in Normal display mode.</p> <p><b>Channels</b> sets the colors used to display instrument channels.</p> <p><b>Maths</b> sets the colors used to display math waveforms.</p> <p><b>Refs</b> sets the colors used to display reference waveforms.</p> <p>To change a color, tap a channel, math, or reference color to open a color menu and select a new color. The waveform immediately changes to the selected color if the display is in <b>Normal</b> mode. The color menu stays open to let you experiment with different waveform colors. Tap outside the color menu to close it.</p>

Table continued...



Field or control	Description
<b>Inverted Display Colors</b>	<p>Use this menu to change the waveform colors to use when the instrument is in Inverted display mode.</p> <p><b>Channels</b> sets the colors used to display instrument channels.</p> <p><b>Maths</b> sets the colors used to display math waveforms.</p> <p><b>Refs</b> sets the colors used to display reference waveforms.</p> <p>To change a color, tap a channel, math, or reference color to open a color menu and select a new color. The waveform immediately changes to the selected color if the display is in <b>Inverted</b> mode. The color menu stays open to let you experiment with different waveform colors. Tap outside the color menu to close it.</p> <p>The colors for Math waveforms 1-8 are reused for Math waveforms 9-16, 17-24, and so on.</p> <p>The colors for Ref waveforms 1-8 are reused for Ref waveforms 9-16, 17-24, and so on.</p>
<b>Set All Normal Display Colors to Default</b>	Sets all <b>Normal</b> display mode waveform colors to their factory default settings.
<b>Set All Inverted Display Colors to Default</b>	Sets all <b>Inverted</b> display mode waveform colors to their factory default settings.

### Custom waveform color guidelines

- There are 48 colors from which to choose.
- There are no restrictions on assigning colors. You can assign different colors to different waveforms, or the same color to many waveforms.
- Changing a waveform color automatically changes all indicators that use that waveform's color (channel handles, vertical scale readout, signal badges, measurement badges, front-panel control LED colors, and so on).
- Waveform color settings are saved as part of waveform, setup, and session save actions.
- You cannot change Bus waveform colors.

### I/O (Utility menu)

Use this configuration menu to set up a LAN, USB Device Port, Socket Server, and AUX OUT signal parameters.

To open the I/O menu:

1. Tap the **Utility** menu.
2. Tap **I/O...**

### Entering and applying LAN network changes

When first opening the I/O menu LAN panel, the Network Address is set to **Auto** (default setting) and the **Apply Changes** button is grayed out (inactive) in the LAN panel.

When you select any editable input box and start entering data, the **Apply Changes** button becomes active, and the characters being entered are bolded and italicized. Bold italicized text means that the values have not been applied to the oscilloscope settings.

When you tap the **Apply Changes** button, all changes are saved (takes about 10 seconds), the text is changed to normal font (nonbold, nonitalic), and the **Apply Changes** button becomes inactive.

If you tap outside the I/O menu before you tap the Apply Changes button, the menu closes and none of your changes are saved.

## LAN panel fields and controls

Field or control	Description
LAN Status	A readout that indicates the status of the LAN connection, either a Green circle with the word Normal or a Red circle with an error message.
Host Name	The instrument host name is displayed. To change the name, double-tap and enter a name in the virtual keyboard.
Network Address	Tap to select <b>Manual</b> or <b>Automatic</b> mode. In Automatic mode, the current Instrument IP Address, Gateway IP Address, Subnet Mask, and DNS IP Address are displayed.
Domain Name	The instrument domain name is displayed. To change the name, double-tap and enter a name in the virtual keyboard.
Instrument IP Address	Tap and use the multipurpose knobs to enter the address. Use the A knob to select the digit, and the B knob to change the value.  Available to edit when <b>Network Address</b> is <b>Manual</b> .
Subnet Mask	Tap and use the multipurpose knobs to enter the mask. Use the A knob to select the digit, and the B knob to change the value.  Available to edit when <b>Network Address</b> is <b>Manual</b> .
Service Name	The instrument service name is displayed. To change the name, double-tap and enter a name in the virtual keyboard.
Gateway IP Address	Tap and use the multipurpose knobs to enter the address. Use the A knob to select the digit, and the B knob to change the value.  Available to edit when <b>Network Address</b> is <b>Manual</b> .
DNS IP Address	Tap and use the multipurpose knobs to enter the address. Use the A knob to select the digit, and the B knob to change the value.  Available to edit when <b>Network Address</b> is <b>Manual</b> .
MAC Address	A readout of the instrument MAC Address. This field is not editable.
e*Scope HTTP Port	A readout of the instrument e*Scope HTTP port number. This field is not editable.
Test Connection	Tap to test the connection. If the connection test is successful, then <b>OK</b> is displayed. If the test is unsuccessful, then <b>No Response</b> is displayed.
LAN Reset	Tap to display the <a href="#">LAN Reset configuration menu (Utility &gt; I/O menu)</a> on page 496.
Apply Changes	Apply changes made on this panel to the instrument.   <b>Note:</b> No changes are made to instrument settings until you tap the <b>Apply Changes</b> button.

## e\*scope Remote Access panel fields and controls

This panel is available for standard (non-Windows 10) instruments only. The e\*scope remote access feature is supported on 4B/5/5B/6/6B Series MSO but not supported on 4 Series MSO.

Field or control	Description
e*Scope Remote Access	Tap to toggle e*Scope remote access <b>On</b> or <b>Off</b> . Default is On.

Table continued...

Field or control	Description
<b>Require password for access via e*Scope</b>	Select the <b>Require password for access via e*Scope</b> check box to set the password for e*Scope. Default is unchecked. If you uncheck the box after setting the password, an <b>Enter Password</b> window appears. You must enter the password to remove the password restriction.
<b>New Password</b>	Set the new password. The maximum character length limit for the password is 64 characters.
<b>Confirm New Password</b>	Re-enter the new password to confirm.
<b>Cancel</b>	Tap to close the menu without taking any action.
<b>OK</b>	Tap to set the new password. If password is set successfully, the menu is dismissed.  This button remains grayed out until the you enter a password that meets the requirements in both the New Password and Confirm New Password fields.

### USB Device Port fields and controls

Use the USB Device Port panel to enable or disable USB ports and set the GPIB Talk/Listen address. Use USB ports to connect a USB memory device, keyboard, or for direct PC control of the oscilloscope using USBTMC protocol.

Field or control	Description
<b>USB Device Port</b>	Tap to toggle all USB device ports <b>On</b> or <b>Off</b> .
<b>USBTMC Configuration</b>	Displays the USBTMC configuration information.
<b>GPIB Talk/Listen Address</b>	Double-tap and enter the address using the virtual keypad.

### Socket Server panel fields or controls

Use the following socket server settings to set up and use a socket server between your oscilloscope and a remote terminal or computer.

Field or control	Description
<b>Socket Server</b>	Tap to toggle the socket server <b>On</b> or <b>Off</b> .
<b>Protocol</b>	Tap to select a protocol, either <b>None</b> or <b>Terminal</b> .  A communication session run by a user at a keyboard typically uses a terminal protocol. An automated session might handle its own communications without such protocol from the oscilloscope.
<b>Port</b>	Enter the port number using the multipurpose knob or virtual keypad.

### AUX Out panel fields and controls

Use the following settings to select the signal that is output on the rear-panel AUX Out signal connector.

Field or control	Description
<b>AUX Out Signal</b>	Tap to select the signal type to send to the AUX Out connector.  <b>Trigger</b> sends a pulse for each trigger occurrence.  <b>Reference Clock</b> outputs the instrument's reference signal, whether generated internally or supplied from the REF In connector.  <b>AFG Sync</b> sends a pulse that is synchronized to the AFG output signal.
<b>Polarity</b>	Tap to select the polarity of the trigger signal (positive or negative pulse per trigger event). The polarity control is present only for the Trigger output.

## Using Telnet to communicate with the oscilloscope

1. After you have set up the socket server parameters, the computer is now ready to communicate with the oscilloscope. If you are running an MS Windows PC, you could run its default client Telnet, which has a command interface. One way to do this is by typing `Telnet` in the Run window. The Telnet window will open on the PC.



**Note:** On MS Windows 10, you must first install Telnet.

2. Start a terminal session between your computer and your oscilloscope by typing in an open command with the oscilloscope's LAN address and port number.

You can obtain the LAN address by pushing the Ethernet & LXI lower menu button and the resulting LAN Settings side menu button to view the resulting Ethernet and LXI Settings screen. You can obtain the port # by pushing Socket Server on the lower menu and viewing Current Port on the side menu.

For example, if the oscilloscope IP address was 123.45.67.89 and the port # was the default of 4000, you could open a session by writing into the MS Windows Telnet screen: `o 123.45.67.89 4000`.

The oscilloscope will send a help screen to the computer when it has finished connecting.

3. You can now type in a standard query, such as, `*idn?`.

The Telnet session window will respond by displaying a character string describing your instrument.

You can type in more queries and view more results using this Telnet session window. You can find the syntax for relevant commands, queries and related status codes in the Programmer Manual that is available at the Tektronix website.



**Note:** Do not use the computer's backspace key during an MS Windows Telnet session with the oscilloscope.

## LAN Reset configuration menu (Utility > I/O menu)

Use this menu to reset the Local Area Network (LAN) settings to the listed default settings.

To open the LAN Reset dialog:

1. Tap **Utility** in the Menu bar.
2. Tap **I/O...**
3. Tap the **LAN Reset** button to open the LAN Reset configuration menu.
4. Tap **OK** to reset the LAN settings.
5. Tap **Cancel** to close the dialog without taking any action, and return to the I/O configuration menu.

### LAN Reset default settings

Function	Setting
Network address	Automatic
DHCP	Enabled
BOOTP	Enabled
mDNS & DNS-SD	Enabled
LXI Password Protection	Disabled
LXI Password	Empty string (default)

## See also

[I/O \(Utility menu\)](#) on page 493

## Self Test configuration menu (Utility menu)

Use this menu to view power-on diagnostic results, run extended self tests, and verify the 250 k $\Omega$  termination control works on input channels.

To open the **Self Test** configuration menu:

1. Tap **Utility** in the Menu bar.
2. Tap **Self Test...**

Tap anywhere outside of the menu to close the menu.



**Note:** Remove all input signals before running the extended self tests.

### Self Test configuration menu fields and controls

Field or control	Description
<b>250 k<math>\Omega</math> Verification</b>	Opens a menu to verify that 250 k $\Omega$ termination can be enabled or disabled for every channel. Closing the menu restores the normal termination setting of all connected probes.
<b>Export Log Files</b>	Opens a menu that lets you save instrument log files to a .zip-compressed file. The log file is a valuable information resource when working with Tektronix Customer Support to troubleshoot a problem or report an issue.  You can navigate to the TekDrive location to export log files.
<b>Power-on Self test Results</b>	Displays the power-on self test status ( <b>Passed</b> or <b>Failed</b> ).
<b>Extended Self Test Results</b>	Lists the status of each Extended self tests ( <b>Passed</b> or <b>Failed</b> ).  If one or more tests fail at power-on, tap on <b>Run Self Test</b> and see if the test or tests continue to fail. If tests continue to fail, contact your nearest Tektronix Service Center for help with resolving the problem.
<b>Run N Times</b>	Sets the number of times to run the extended self tests.
<b>Run Self Test / Abort Self Test</b>	Tap <b>Run Self Test</b> to run the extended self tests. While tests are running, the button changes to <b>Abort Self Test</b> . When self tests are stopped, the button reverts to <b>Run Self Test</b> .   <b>Note:</b> Remove all input signals before running the extended self tests.  Tap the <b>Abort Self Test</b> button anytime to stop testing.

## Calibration configuration menu (Utility menu)

Use this menu to perform a signal path compensation or view the factory calibration status.

To open the Calibration configuration menu:

1. Tap **Utility** in the Menu bar
2. Tap **Calibration...**

## Calibration configuration menu fields and controls

Field or control	Description
<b>Factory Adjustment Status</b>	<p>This area at the top of the menu lists the instrument calibration status. Factory Adjustment Status should be Calibrated.</p> <p>If an instrument becomes uncalibrated, this displays an Uncalibrated status and a red Warning message bar is shown at the top of the screen in the Menu bar area. Contact your nearest Tektronix Service Center for assistance.</p>
<b>SPC Status</b>	<p>Indicates the status of the last SPC run (Pass or Failed). Also indicates how long ago the last SPC was run.</p>
<b>Run SPC</b>	<p>Signal path Compensation (SPC) corrects for internal DC inaccuracies caused by temperature variations and/or long-term drift in circuits.</p> <p> <b>Note:</b> SPC takes five or more minutes per channel to run.</p> <p>Allow the instrument to warm up for 20 minutes before running SPC.</p> <p>Remove all probes, cables, and adapters from the input connectors before running SPC.</p> <p>Tap Run SPC to run signal path compensation. The compensation can take up to five or more minutes per channel.</p>

## Security configuration menu for standard instruments (Utility menu)

If you have acquired confidential data, use TekSecure® to erase the oscilloscope memory before you return the oscilloscope to general use. This menu applies to all standard instruments that were not configured with Enhanced Security when ordered.



**Note:** This menu applies to all standard instruments that were not ordered with optional Enhanced Security when purchased. For instruments with optional Enhanced Security installed, see [Security configuration menu](#) on page 499.

To run the Security process:



**Note:** Save any important waveform, screen capture, instrument setup, report, and session files to external memory before running TekSecure. All such files will be erased.

1. Tap **Utility** in the Menu bar.
2. Tap **Security...**
3. Tap **Run TekSecure** to erase nonvolatile memory. It will take approximately seven minutes to erase the memory.
4. Push the **Default Setup** front panel button to load memory with the instrument factory settings.



**Note:** You cannot stop the TekSecure process once it is started.



**Note:** TekSecure does not erase calibration constants or instrument firmware.

## TekSecure Erase Memory

Use this menu to use the TekSecure® function to erase the oscilloscope nonvolatile memory.

For instruments running on the embedded OS, TekSecure is a shortcut for overwriting the SSD from the recovery partition. For instruments running on the Windows 10 OS, TekSecure deletes files in the folder C:\Users\Public\Tektronix.

To open the Security menu and run TekSecure:

1. Tap **Utility** in the Menu bar.
2. Tap **Security...**
3. Tap **Run TekSecure** to run the TekSecure memory erase. It will take approximately seven minutes to erase the memory.
4. To exit the dialog without running TekSecure, tap outside of the configuration menu.

TekSecure runs for about five to seven minutes. You cannot stop the process once it is started. Do not power down the instrument while TekSecure is running.



**Note:** TekSecure does not erase calibration constants or instrument firmware. Save any important waveform, screen capture, instrument setup, report, and session files to external memory before running TekSecure.

## Security configuration menu

Use this menu to enable or disable USB ports, LAN port, Firmware updates, and securely erase the oscilloscope nonvolatile memory (TekSecure®). Access to the functions on this menu are password protected. This menu is only shown on instruments with optional Enhanced Security installed (4-SEC, 5-SEC, or 6-SEC).

To open the Security configuration menu:

1. Tap **Utility** in the Menu bar.
2. Tap **Security**.
3. Tap **On** or **Off** to enable or disable **USB Ports**, **LAN port**, or **Firmware Updates** functions. The default setting is On.



**Note:** Enabling/Disabling the LAN port is not available on the MSO58LP.

4. Tap **Set Password** to enter a password for the first time. If a password has already been set, tap **Change Password** to change the password.



**Note:** The switches cannot be toggled (off or on) unless a password has been set.

- If a switch is toggled without a password set, a message is shown asking you to set a password.
- If a switch is toggled with a password set, the instrument shows the *Enter Password* menu.

## Security configuration menu fields and controls

Field or control	Description
USB Ports	Tap to enable (On) or disable (Off) all USB ports (Device and Host).
LAN Port	Tap to enable (On) or disable (Off) the Ethernet port.
Firmware Updates	Tap to enable (On) or disable (Off) the ability to update the oscilloscope firmware.
Set Password	Opens the <i>Set Password</i> menu.
Change Password	Opens the <i>Change Password</i> menu.

Table continued...

Field or control	Description
<p><b>TekSecure Erase Memory</b></p> <p>For instruments running on the embedded OS, TekSecure is a shortcut for overwriting the SSD from the recovery partition. For instruments running on the Windows 10 OS, TekSecure deletes files in the folder C:\Users\Public\Tektronix.</p>	<p>Tap Run TekSecure to erase nonvolatile memory. It will take approximately seven minutes to erase the memory.</p> <p>TekSecure runs for about five to seven minutes. You cannot stop the process once it is started. Do not power down the instrument while TekSecure is running.</p> <p> <b>Note:</b> TekSecure does not erase calibration constants or instrument firmware. Save any important waveform, screen capture, instrument setup, report, and session files to external memory before running TekSecure.</p>

### Passwords and sending the instrument for service



**CAUTION:** If you need to send the instrument for service or repair, make sure to use the **Clear Password** function in the Change Password menu before sending to the Tektronix Service Center. Failure to do so may impede servicing the instrument.

### Enter Password configuration menu

Use this function to enter the password to access optional security functions. This menu is only shown on instruments with the optional security function installed (4-SEC, 5-SEC, or 6-SEC).

To enter the password to allow changing the selected security feature state (On or Off):

1. Tap **Utility** in the Menu bar.
2. Tap **Security**.
3. Tap the button of a function that you want to change, to open the Enter Password menu.
4. Enter the password and tap **OK**. The menu closes and toggles the selected function's button state.

### Enter Password configuration menu fields and controls

Field or control	Description
<p><b>Password</b></p>	<p>Enter the password. The valid range of characters for the password is from one to 32 characters. Entering no characters or more than 32 characters results in an error message.</p> <p> <b>Note:</b> If you cannot use a keyboard because the USB ports are disabled, double-tap on the password fields to open the virtual keyboard and enter the password.</p>
<p><b>OK</b></p>	<p>Closes the menu and toggles the selected function's button when the entered password is correct. Any other conditions result in an error message.</p>
<p><b>Cancel</b></p>	<p>Closes the menu without taking any action.</p>

### Passwords and sending the instrument for service



**CAUTION:** If you need to send the instrument for service or repair, make sure to use the **Delete Password** function in the Change Password menu before sending to the Tektronix Service Center. Failure to do so may impede servicing the instrument. See [Change Password configuration menu](#) on page 501.



## Set Password configuration menu

Use this function to set the password used to access the optional security functions. This menu is only shown on instruments with optional security functions installed (4-SEC, 5-SEC, or 6-SEC).

To access the Set Password configuration menu:

1. Tap **Utility** in the Menu bar.
2. Tap **Security**.
3. Tap **Set Password**.

### Set Password menu fields and controls <sup>4</sup>

Field or control	Description
<b>New Password</b>	Enter the new password in this field. The valid range of characters for the password is from one to 32 characters. Entering no characters or more than 32 characters results in an error message.   <b>Note:</b> If you cannot use a keyboard because the USB ports are disabled, double-tap on the password fields to open the virtual keyboard and enter the password.
<b>Repeat New Password</b>	Re-enter the new password in this field.
<b>Set New Password</b>	Sets the new password and closes the menu when the new password matches in both new password fields and the new password fields are not empty. Any other conditions result in an error message.
<b>Cancel</b>	Closes the menu without taking any action.

### Passwords and sending the instrument for service



**CAUTION:** If you need to send the instrument for service or repair, make sure to use the [Delete Password](#) function in the Change Password menu before sending to the Tektronix Service Center. Failure to do so may impede servicing the instrument.

## Change Password configuration menu

Use this function to change an existing password used to access the optional security functions. This menu is only shown on instruments with optional security functions installed (4-SEC, 5-SEC, or 6-SEC).

To access the Change Password configuration menu:

1. Tap **Utility** in the Menu bar.
2. Tap **Security**.
3. Tap **Change Password**.

### Change Password menu fields and controls <sup>5</sup>



Field or control	Description
<b>Current Password</b>	Enter the current password in this field. The valid range of characters for the password is from one to 32 characters. Entering no characters or more than 32 characters results in an error message.   <b>Note:</b> If you cannot use a keyboard because the USB ports are disabled, double-tap on the password fields to open the virtual keyboard and enter the password.

Table continued...

<sup>4</sup> If the instrument has a keyboard attached, and you have disabled the USB ports, double-tap on the password fields and use the virtual keyboard to enter the password.

Field or control	Description
<b>New Password</b>	Enter the new password in this field. See <a href="#">Enter Password configuration menu</a> on page 500 for password character information.
<b>Repeat New Password</b>	Re-enter the new password in this field.
<b>Delete Password</b>	<p>Delete the password from the security function. You must enter the correct password before you can clear it.</p> <p>If the password is correct, the password is deleted and the menu closes. The Security menu changes the name of the <b>Delete Password</b> button to <b>Set Password</b>.</p> <p>If the incorrect password is entered, the instrument shows an error message.</p> <p> <b>Note:</b> Once you delete the password, you must set a new password before you can change the security access functions.</p>
<b>Set New Password</b>	Sets the new password and closes the menu if the current password is correct, the new password matches in both new password fields, and the new password fields are not empty. Any other conditions result in an error message.
<b>Cancel</b>	Closes the menu without taking any action.

### Passwords and sending the instrument for service



**CAUTION:** If you need to send the instrument for service or repair, make sure to use the **Delete Password** function before sending to the Tektronix Service Center. Failure to do so may impede servicing the instrument.

### Demo (Utility menu)

Use this menu to access demonstrations of key oscilloscope features.

To open the Demo configuration menu, select **Utility > Demo...** in the Menu bar.

### Demo menu fields and controls

Field or control	Description
<b>Demo overview</b>	The upper half of the menu shows an overview of the demonstration available in the selected panel. This pane may also contain a screen shot showing the waveforms and capability being demonstrated.
<b>Connection Details</b>	Tap this button to open a dialog box that shows how to connect the oscilloscope to a signal source to perform the selected demonstration.
<b>Recall Demo Session</b>	Tap this button to load the session file for the selected demonstration.
Demo panels	<p>Each panel provides a demonstration of oscilloscope capabilities within a category. The categories are <b>Miscellaneous</b> and <b>Serial Bus</b>.</p> <p>Each panel will have two or more demonstration buttons in them. Selecting a button updates the upper half of the menu to show the relevant content (and image if available) for the selected demonstration.</p>

<sup>5</sup> If the instrument has a keyboard attached, and you have disabled the USB ports, double-tap on the password fields and use the virtual keyboard to enter the password.

## Help... (Help menu)

Tap this item to open the Help viewer. This Help viewer is similar in operation to a traditional Microsoft Windows help viewer.

## License Options...(Help menu)

Use the License Options menu to view the list of possible license options along with the description about the licenses that can be installed in the oscilloscope. This aids you to select the right software licenses before purchasing.

To access this option, select **License Options** from the Help menu. **License Options** dialog is displayed that contains the possible licenses information. Tap on any tab and select a license to know about the selected license.

Select an option to view the related information about the selected option on top, next to the illustration. The related nomenclature and the recommended firmware version required is also displayed.

A small green tick appears when an option is already installed/enabled in the instrument.

## About (Help menu)

Use the About configuration menu to show instrument information and installed options, and to install or uninstall analysis or feature options.

To open the About menu:

1. Tap **Help** on the menu bar.
2. Select **About** from the menu to open the About configuration menu.

## About configuration menu fields and controls

Field or control	Description
<b>System information</b>	Provides system-related information such as model, bandwidth, serial number, Host ID, and installed firmware version. Provide this information when communicating with Tektronix to purchase option licenses or communicate with Customer Support.
<b>Probes Detected</b>	Lists probes connected to the instrument. TekVPI probes will list the probe model, serial number, and installed probe firmware version.  Non-TekVPI probes may show their attenuation factor.   <b>Note:</b> Connecting or disconnecting probes while the About menu is open does not update the Probes Detected list. The Probes Detected list is not dynamic.
<b>Installed Options</b>	Lists installed options. Click on an item in the list to show details of the option in the Option Details area below the list.
<b>Option Details</b>	Lists details of the option selected in the list, including license type, when the license was checked out, when it was installed on the instrument, and the date the license expires.
<b>Remove License</b>	Opens the Location to Save the Exit Key dialog. Use this to uninstall a floating license option for use by others. You can use TekDrive to save removed license files. See <a href="#">Location to Save Exit Key configuration menu</a> on page 504.
<b>Install License</b>	Tap this button to open the Browse License Files dialog to navigate to and select an option license file to install. You can navigate to the TekDrive location to install saved license files. See <a href="#">Browse License Files menu (Help &gt; About)</a> on page 505.

## License expire notification

Select the **Option Details** to see the license expire date from **Help > About** menu.

- Licenses in red text will expire soon within 45 days.
- Licenses in gray text are already expired license.

## Location to Save Exit Key configuration menu

Use this menu to navigate to and set the location to save the option license key when you uninstall the license.

To access the Location to Save Exit Key menu:

1. Tap **Help** on the menu bar.
2. Select **About** from the menu.
3. Tap a license in the list that you want to uninstall (return the license).
4. Tap the **Remove License** button to open the Location to Save Exit Key configuration menu.

## Location to Save Exit Key configuration menu fields and controls



Field or control	Description
Look in	Shows the current directory path at which to save the exit key file.  Tap on the file path and use a keyboard to enter a new path. Or double-tap on the file name to open the on-screen keyboard and enter a path.  Tap the down arrow icon on the right end of the field to open a list of recently accessed paths, up to a maximum of 20.
	The Drive column lists the directory structure, opening at the root level. Installed USB memory devices are listed. Use to quickly navigate to a location.  Tap to list the contents of the directory in the Files pane.  Double-tap an item, or tap the small arrow to the left of the directory, to display the subdirectories under it. Double-tap again to close that directory structure.  Drag the list up and down to show more entries.  You can also use the files Name column to navigate to and select a folder in which to save the file.
	Use the arrow buttons to navigate the directory structure.  The left arrow navigates back to the previously visited folder.  The Right arrow navigates forward to the previously visited folder.  The Up arrow navigates up one level from the current folder.
	Use to create a new directory (folder) at the current location.  Opens the new directory after it is created.

Table continued...

Field or control	Description
<b>File Name</b>	Lists the selected license file name to return (uninstall). Tap the down arrow icon on the right end of the field to open a list of uninstalled license files, up to a maximum of 20.
<b>Files of Type</b>	Use to select the file format you want to open. Tap the field to show a list of all file extension types that the instrument can read for the selected file type. The Name field (where folder and files are listed) only lists files of the specified type.
<b>Cancel</b>	Cancels the license uninstall process, closes the configuration menu without saving any changes that were made, and returns to the About configuration menu.
<b>Create</b>	Closes the configuration menu and saves the license information to the specified location.

## Browse License Files menu (Help > About)

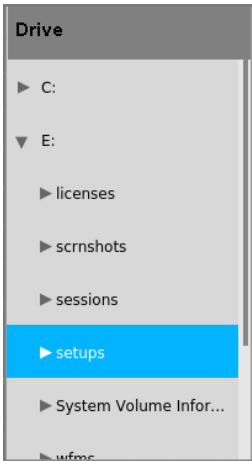
Use this menu to select and install an option license file to enable new functions.

To access the Browse License Files menu:

1. Tap **Help > About...** on the menu bar.
2. Tap **Install License** button to open the Browse License Files configuration menu.

## Browse License Files configuration menu fields and controls



Field or control	Description
<b>Look in</b>	Shows the current directory path and file name. Tap on the file path and use a keyboard to enter a new path. Or double-tap on the file name to open the on-screen keyboard and enter a path. Tap the down arrow icon on the right end of the field to open a list of recently accessed files, up to a maximum of 20.
	The Drive column lists the directory structure, opening at the root level. Installed USB memory devices are listed. Use to quickly navigate to a location. Tap to list the contents of the directory in the files listing. Double-tap an item, or tap the small arrow to the left of the directory, to display the subdirectories under it. Double-tap again to close that directory structure. Drag the list up and down to show more entries.

Table continued...

Field or control	Description
	Use the arrow buttons to navigate the directory structure. The left arrow navigates back to the previously visited folder. The Right arrow navigates forward to the previously visited folder.
	Use to create a new directory (folder) at the current location. Opens the new directory after it is created.
<b>File Name</b>	Lists the selected file name. Tap on the file name and use a keyboard to enter a new file name. Or double-tap on the file name to open the on-screen keyboard and enter the new name. Tap the down arrow icon on the right end of the field to open a list of recently accessed files, up to a maximum of 20.
<b>Files of Type</b>	Use to select the file format you want to open. Tap the field to show a list of all file extension types that the instrument can read for the selected file type. The files pane only lists files of the specified type.
<b>Cancel</b>	Cancels the configuration menu changes, closes the menu, and returns to the prior menu without making any changes.
<b>Open</b>	Closes the configuration menu, returns to the About configuration menu, and installs the license. Follow any instructions that may be shown during the installation.

## Font Color menu (Text Settings configuration)

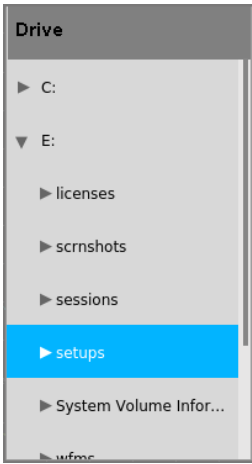
Use this menu to change the label color. Touch and hold on callout or label text, select **Format Text** in the right-click menu, and select **Color** to open this menu. Click on a color to change the text color.

## Text Settings configuration menu (Callout and Waveform labels text)

Use this menu to change and format existing Callout or Waveform labels (font type and size, color, bold, italic, and underline).

**Prerequisite:** There is callout or waveform label on the screen.

To open the **Text Settings** configuration menu, double-tap on the Callout or Waveform label. You can also touch and hold on the Callout/label text and select **Format Text** from the right-click menu.

To delete a Callout or label, touch and hold on the Callout/label and select **Delete** from the right-click menu.

### Text Settings configuration menu fields and controls

Field or control	Description
<b>Text</b>	Double-tap and enter the desired text using the virtual keyboard.
<b>Font</b>	Tap and select the desired font from the drop-down list.
<b>Size</b>	Tap and select the desired font size from the drop-down list.
<b>Color</b>	Tap and select the desired font color from the color palette.

Table continued...

Field or control	Description
B	Tap to toggle text bolding On or Off.
I	Tap to toggle text italics On or Off.
U	Tap to toggle text underlining On or Off.

## Plot configuration menus

Use plot configuration menus to change settings of a displayed plot. Double-tap a plot view to open its configuration menu.

Use the following links to access information on a specific Plot configuration menu.

[Eye Diagram plot configuration menu](#) on page 513

[Math FFT plot configuration menu \(Math waveform\)](#) on page 525

[Histogram plot configuration menu](#) on page 522

[Bathtub plot configuration menu](#) on page 509

[Spectrum plot configuration menu](#) on page 536

[Trend Plot configuration menu](#) on page 541

[Time Trend plot configuration menu](#) on page 538

[Overlapped Recovery plot configuration menu](#) on page 528

[Plot XY configuration menu](#) on page 542

[XYZ plot configuration menu](#) on page 543

[Harmonics Bar Graph plot configuration menu](#) on page 521

[SOA plot configuration menu](#) on page 535

[Trajectory plot configuration menu \(Switching Loss power measurement\)](#) on page 539

## Acq (Acquisition) Trend plot configuration menu

Use the Acq Trend configuration menu to set the acq trend plot waveform vertical scale and position, as well as add a label.

To open the Acq Trend configuration menu, double-tap the **Acq Trend** badge in the Measurement badge. You can also double-tap the Acq Trend Plot handle.



**Note:** Acq Trend plot is available for Power Quality, Efficiency, Speed, and Direction measurements.

Acq Trend represents plotting of a selected measurement for each acquisition on a separate plot.

**Note:**



- Measurements that can use the Acq trend plot as a source will list the plot in the Source menu list.
- Acq trend plot resets when scope acquisition resets because of change in scope settings and measurement sources.

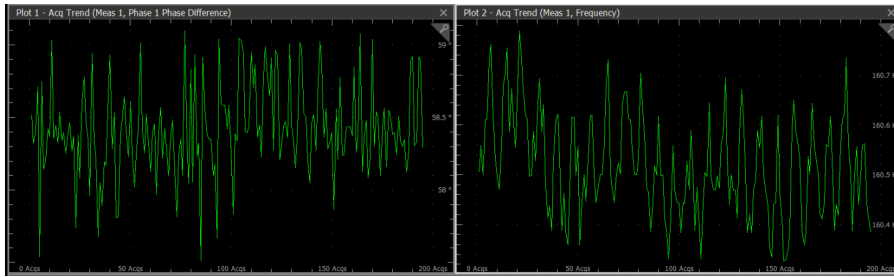

Figure 27: Phase Frequency

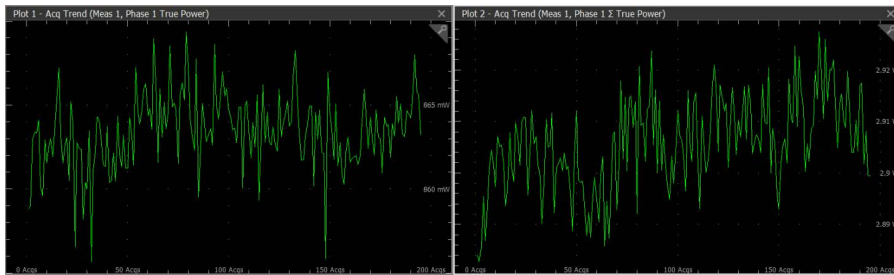

Figure 28: True Power

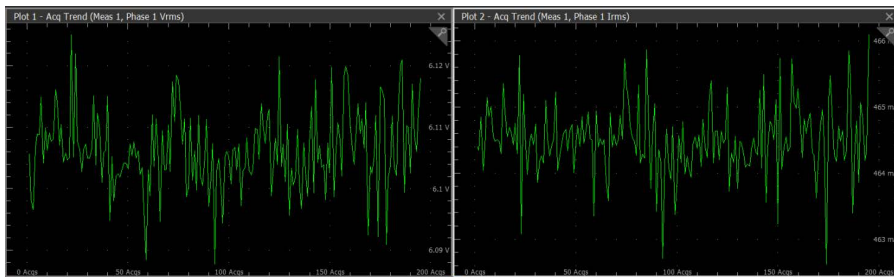

Figure 29: Vrms and Irms

### Acq Trend configuration menu fields and controls

Field or control	Description
Auto Scale	Enables or disables the Auto Scale mode. Auto Scale uses the signal data to dynamically set the vertical scale units.
Plot Display	Available values are <ul style="list-style-type: none"> <li>• Phase 1(V, I)</li> <li>• Phase 2(V, I)</li> <li>• Phase 3(V, I)</li> </ul>

Table continued...



Field or control	Description
<b>Measurements</b>	<p>Available measurements for Power Quality are:</p> <ul style="list-style-type: none"> <li>• Vrms</li> <li>• Irms</li> <li>• Phase Difference</li> <li>• Frequency</li> <li>• True Power</li> <li>• Apparent Power</li> <li>• Reactive Power</li> <li>• Sum of True Power</li> <li>• Sum of Apparent Power</li> <li>• Sum of Reactive Power</li> </ul> <p>Available measurements for Efficiency are:</p> <ul style="list-style-type: none"> <li>• Input Power</li> <li>• Output Power</li> <li>• Efficiency</li> <li>• Total Efficiency</li> <li>• Sum of Input Power</li> <li>• Sum of Output Power</li> </ul> <p>Available measurements for Speed are:</p> <ul style="list-style-type: none"> <li>• Speed</li> <li>• Acceleration</li> </ul> <p>Available measurements for Harmonics are:</p> <ul style="list-style-type: none"> <li>• THD-F</li> <li>• THD-R</li> </ul>
<b>Save</b>	Saves the plot data along with time stamp at the specified location.

## Deleting a trend plot

To delete a Acq Trend plot, touch and hold the **Acq Trend** badge to open the right-click menu, and select **Delete Acq Trend**. Deleting the Measurement badge that enabled the plot also closes the plot.

## Bathtub plot configuration menu

Use this menu to change settings of a displayed jitter versus BER (bathtub) plot.

To open the Bathtub plot configuration menu, double-tap anywhere in the **Bathtub** plot view.

To close a plot view, tap the X in the upper right corner of the view. Deleting the Measurement badge that opened the plot also closes the plot.

## Settings panel (Bathtub plot configuration menu) fields and controls

Field or control	Description
<b>Autoscale</b>	Toggles auto scaling of the plot on or off.  When AutoScale is off, a small Zoom window appears in the plot. Drag the blue zoom area box in the small Zoom window to view that area in the main Plot view. Use the Zoom and Pan front-panel knobs to change the zoom area and horizontal position.
<b>Gridlines</b>	Sets which gridlines to show in the plot. Available gridlines are Horizontal, Vertical, and Both.
<b>X-Axis Units</b>	Sets the X-axis units to be unit intervals or seconds.
<b>X-Axis From, To</b>	Sets the beginning and end scale range to display in the plot for the X-Axis scales, in unit intervals.  These values also define the horizontal area shown in the small Zoom window.  Available when AutoScale is off.
<b>Y-Axis From, To</b>	Sets the beginning and end scale range to display in the plot for the Y-Axis scales, in BER units.  These values also define the vertical area shown in the small Zoom window.  Available when AutoScale is off.
<b>Y-Axis scale</b>	Sets the Y axis scale to Linear (default) or Log.  A <b>Log</b> scale is useful when the component magnitudes cover a wide dynamic range, letting you show both lesser- and greater-magnitude components on the same display.  A <b>Linear</b> scale is useful when the component magnitudes are all close in value, allowing direct comparison of their magnitudes.

## Save panel fields and controls

Use the Save panel controls to save the plot image or data to a file for inclusion in reports or further analysis in other applications.

Field or control	Description
<b>Save Plot Image</b>	Tap to open the Save As menu. Navigate to the location where you want to save the plot image. Enter a file name in the File Name field. Select the image file format (PNG, BMP, or JPG).  Tap <b>OK</b> to save the plot image.
<b>Save Plot Data</b>	Tap to open the Save As menu. Navigate to the location where you want to save the plot data. Enter a file name in the File Name field.  Tap <b>OK</b> to save the plot data as a comma-separated values (.csv) file.

## Closing a plot view

To close (delete) a Plot view, tap the **X** in the upper right corner of the view.

Deleting the Measurement badge that enabled the plot also closes the plot.

## BH curve configuration menu (Magnetic Analysis power measurement)

Use this menu to change the settings of a displayed BH curve plot (Magnetic Property measurement).

To open the BH curve plot configuration menu, double-tap anywhere in a **BH curve** Plot view.

## Settings panel (BH curve configuration menu) fields and controls

Field or control	Description
<b>AutoScale</b>	Toggles <b>AutoScale On</b> or <b>Off</b> . Turn <b>AutoScale</b> off to manually set the X and Y-axis range to view an area of interest.  When <b>AutoScale</b> is Off, a small Zoom window appears in the plot. Drag the blue vertical bar in the Zoom window to view that area in the main Plot view. Use the <b>Zoom</b> and <b>Pan</b> front-panel knobs to change the zoom area and position.
<b>Gridlines</b>	Selects which gridlines to show in the plot. Select the grid style that meets your measurement needs.
<b>Display</b>	Vectors draws waveforms with lines between record points.  Dots draws waveform record points as dots on the screen.
<b>X-Axis</b>	Sets the beginning and end scale range to display in the plot for the X-Axis scales.  This is displayed only when <b>AutoScale</b> is Off (deselected).
<b>Y-Axis</b>	Sets the beginning and end scale range to display in the plot for the Y-Axis scales.  This is displayed only when <b>AutoScale</b> is Off (deselected).
<b>Displayed Cycles</b>	Select either <b>All</b> or <b>B<sub>Peak</sub></b> .

### Note:



- You can move the cursor symbols in the BH curve plot by placing waveform cursors at the correct positions in Waveform view. However, to place cursor symbols correctly at exact positions in Waveform view with precision, you need to enable zoom scale on the Waveform view and increase the zoom scale if you need higher resolution, and then move the waveform cursors using MPH knob in fine mode.
- When you configure a BH plot to B<sub>Peak</sub> from All cycles, the waveform cursors does not get placed automatically on the peak cycle in the time domain waveform. You have to manually move the waveform cursors until you view the cursor symbols value in the B<sub>Peak</sub> plot. This cycle relates to B<sub>Peak</sub>.

## Save panel fields and controls

Use the Save panel controls to save the plot image or data to a file, for inclusion in reports or further analysis in other applications.

Field or control	Description
<b>Save Plot Image</b>	Tap to open the <b>Save As</b> menu. Navigate to the location where you want to save the plot image.  Enter a file name in the <b>File Name</b> field. Select the image file format (PNG, BMP, or JPG).  Tap <b>OK</b> to save the plot image.
<b>Save Plot Data</b>	Tap to open the <b>Save As</b> menu. Navigate to the location where you want to save the plot data.  Enter a file name in the <b>File Name</b> field.  Tap <b>OK</b> to save the plot data as a comma-separated values (.csv) file. It saves the selected standard limits and computed Harmonic values.

## Closing a plot view

To close (delete) a Plot view, tap the **X** in the upper right corner of the view.

Deleting the Measurement badge that opened the plot also closes the plot.

## Control Loop Response (Bode) plot configuration menu

Use this menu to change the settings of a displayed Control Loop Response plot (Control Loop Response measurement).

To open the Control Loop Response plot configuration menu, double-tap anywhere in a **Control Loop Response** plot view.

### Settings panel (Control Loop Response plot configuration menu) fields and controls

Field or control	Description
<b>AutoScale</b>	Toggles <b>AutoScale On</b> or <b>Off</b> . Turn <b>AutoScale</b> off to manually set the X and Y-axis range and view an area of interest.  When <b>AutoScale</b> is off, a small Zoom window appears in the plot. Drag the blue vertical bar in the Zoom window to view that area in the main plot view. Use the <b>Zoom</b> and <b>Pan</b> front panel knobs to change the zoom area and position.
<b>Gridlines</b>	Selects which gridlines to show in the plot. Select the grid style that meets your measurement needs.
<b>Display</b>	<b>Vectors</b> draw waveforms with lines between record points. <b>Dots</b> draw waveform record points as dots on the screen.
<b>Interpolation</b>	Select the method to display the record points between sampled points. <b>Sin(x)/x</b> connects using a Sin(x)/x curve between the computed values. This makes the gain or phase curve smoother than linear interpolation. <b>Linear</b> connects between computed points (Gain or Phase value) using a straight-line fit. Measurement annotations are displayed for Linear mode interpolation only.
<b>X-Axis (Frequency) Scale</b>	Sets the beginning and end scale range to display in the plot for the X-Axis scales.  This is displayed only when <b>AutoScale</b> is off (deselected).
<b>Y-Axis (Gain) Scale</b>	Sets the beginning and end scale range to display in the plot for the Y-Axis scales.  This is displayed only when <b>AutoScale</b> is off (deselected).
<b>Y-Axis (Phase) Scale</b>	Sets the beginning and end scale range to display in the plot for the Y-Axis scales.  This is displayed only when <b>AutoScale</b> is off (deselected).

### Save panel fields and controls

Use the Save panel controls to save the plot image or date to a file for inclusion in reports or further analysis in other applications.

Field or control	Description
<b>Save Plot Image</b>	Tap to open the <b>Save As</b> menu. Navigate to the location where you want to save the plot image.  Enter a file name in the <b>File Name</b> field. Select the image file format (PNG, BMP, or JPG).  Tap <b>OK</b> to save the plot image.

Table continued...

Field or control	Description
<b>Save Plot Data</b>	<p>Tap to open the <b>Save As</b> menu. Navigate to the location where you want to save the plot data.</p> <p>Enter a file name in the <b>File Name</b> field.</p> <p>Tap <b>OK</b> to save the plot data as a comma-separated values (CSV) file. It saves the selected standard limits and computed Harmonic values.</p>

## Closing a plot view

To close (delete) a Plot view, tap the **X** in the upper right corner of the view.

Deleting the Measurement badge that opened the plot also closes the plot.

## Eye Diagram plot configuration menu

Use this menu to change settings of a displayed Eye Diagram plot.

To open the Eye Diagram plot menu, double-tap anywhere in the **Eye Diagram** plot view.

To display an eye diagram plot, see [Add Plot configuration menu](#) on page 336.

## Settings panel (Eye Diagram plot configuration menu) fields and controls

Field or control	Description
<b>AutoScale</b>	<p>Toggles <b>AutoScale</b> on or off. Turn AutoScale off to manually set the X and Y-axis range to view an area of interest.</p> <p>When <b>AutoScale</b> is <b>Off</b>, a small Zoom window appears in the plot. Drag the blue vertical bar in the <b>Zoom</b> window to view that area in the main Plot view. Use the <b>Zoom</b> and <b>Pan</b> front-panel knobs to change the zoom area and position.</p>
<b>X-Axis From, To</b>	<p>Sets the beginning and end scale range to display in the plot for the X-Axis scales.</p> <p>Only available when <b>AutoScale</b> is <b>Off</b> (unchecked).</p>
<b>Y-Axis From, To</b>	<p>Sets the beginning and end scale range to display in the plot for the Y-Axis scales.</p> <p>Only available when <b>AutoScale</b> is <b>Off</b> (unchecked).</p>
<b>Eye Interpolation</b>	<p>Toggles the interpolation for eye rendering to On or Off. When <b>Eye Interpolation</b> is <b>On</b>, it performs the interpolation between samples and gives a finer rendering appearance.</p> <p>When <b>Eye Interpolation</b> is <b>Off</b>, it renders all samples of the valid UIs (Unit Intervals) without performing any interpolation.</p>
<b>Gridlines</b>	<p>Selects which gridlines to show in the plot. Select the grid style that meets your measurement needs.</p>
<b>Eye Rendering</b>	<p><b>Fast</b> Eye Rendering shows the <b>UIs</b> (Unit Intervals) that define the boundaries of the eye along with a user specified number of surrounding UIs for added visual context.</p> <p><b>Complete</b> Eye Rendering shows all valid <b>UIs</b> (Unit Intervals).</p>

## Mask panel (Eye Diagram plot configuration menu) fields and controls

Field or control	Description
<b>Mask Test</b>	<p>Toggles mask display on or off.</p> <p>Setting <b>Mask Test</b> to <b>Off</b> clears and stops mask test calculations.</p> <p> <b>Note:</b> The TIE eye mask test requires the DJA option.</p>
<b>Autofit Mask to Minimize Hits</b>	<p><b>Autofit Mask</b> adjusts the horizontal position of the central mask segment automatically to minimize the mask hits in the central segment, within the mask movement range. By default the mask movement range is set from -50% to 50% of the unit interval.</p> <p>Autofit Mask needs a minimum of two segments in the mask.</p> <p><b>Autofit Mask</b> assumes that segment 2 (Seg2) is the central mask.</p> <p>When <b>Autofit Mask to Minimize Hits</b> box is checked, the mask violations are displayed in sample hits.</p>
<b>Mask File</b>	<p>Lists the path and file name of the mask file to load.</p> <p>You can directly enter the path of the mask file, or use the <b>Browse</b> button to navigate to a mask file. The field also has a drop-down list of recently selected files from which you can also select a mask file to load.</p> <p>The supported mask file types are:</p> <ul style="list-style-type: none"> <li>Legacy base firmware mask files (.msk): Legacy base firmware mask files contain commands that define mask segment geometry and other commands to configure the instrument controls. Only the commands that define the segment geometry are processed.</li> <li>DPOJET mask files (.msk): DPOJET mask files use the same format as legacy base firmware mask files but only contain commands that define the segment geometry.</li> <li>5/6 Series MSO mask files (.xml).</li> <li>Supported Eye Mask types are <b>Absolute Mask</b> and <b>Relative Mask</b>. Absolute Mask meaning that the points in the mask polygons are in the same coordinate units as the vector waveform or Eye-diagram being analyzed. Where in Relative Mask, the horizontal and vertical coordinates are normalized.</li> <li>If the selected mask file is not supported or corrupted, it displays below warning message.</li> </ul> <div data-bbox="516 1360 1058 1621" data-label="Image"> </div> <p>To fix the mask file, edit the mask file format and add a string “:MASK:AUTOSSET:USER:TYP Normalized” if it is not present already.</p>
<b>Browse</b>	<p>Opens the <b>Recall Mask File</b> menu that lets you navigate to and select a mask file to load. See <a href="#">Recall Mask File configuration menu</a> on page 517.</p> <p>You can navigate to the TekDrive location for recalling the saved mask files.</p>

Table continued...



Field or control	Description
<b>Bit Type</b>	<p>Sets which waveform bit types (<b>Transition</b>, <b>Non-Transition</b>, or <b>All</b>) to include for eye height analysis.</p> <p><b>All</b> does eye analysis using both transition and non-transition bits.</p> <p><b>Transition</b> does eye analysis only on transition bits. A transition bit is a bit that is changing from low to high or high to low.</p> <p><b>Non-Transition</b> does eye analysis only on nontransition bits. A nontransition bit is a bit that is not changing state.</p> <p> <b>Note:</b> This configuration is unavailable when plot is associated with Eye Width measurement.</p>

Table continued...

Field or control	Description
<p><b>Mask Hit Ratio</b></p>	<p>The Mask Hit Ratio is the ratio between total UI hits across all mask segments and total number of UI's rendered on an eye diagram. The Mask Hit Ratio is unit-less. When <b>Auto Fit Mask to Minimize Hits</b> box is checked, the Mask Hit Ratio is measured as the ratio between the total number of sample hits and the total number of rendered samples. The plot Mask badge displays Mask Hit Ratio result in an additional row as Hit Ratio.</p> <p>Mask Hit Ratio is applicable only when the Eye Rendering is set to Complete mode. When you selects Mask Hit Ratio with <b>Eye Rendering</b> mode in Settings panel as <b>Fast</b> a below information dialogue box appears. Tap <b>Yes, enable Mask Hit Ratio</b> to switch the <b>Eye Rendering</b> mode to Complete mode. If you select <b>No, maintain Fast Rendering</b>, the Mask Hit Ratio box is unchecked and no Hit Ratio result displayed on the mask badge.</p> <div data-bbox="480 604 1162 1024" style="border: 1px solid gray; padding: 10px; background-color: #f0f0f0;"> <p style="text-align: center;"><b>INFORMATION</b> <span style="float: right;">✕</span></p> <p> Mask Hit Ratio is not compatible with Fast Eye Rendering. Enabling Mask Hit Ratio will switch to Complete Eye Rendering. Would you like to proceed?</p> <p style="text-align: center;"> <span style="border: 1px solid gray; padding: 5px 15px; margin-right: 10px;">Yes, enable Mask Hit Ratio</span> <span style="border: 1px solid gray; padding: 5px 15px;">No, maintain Fast Eye Rendering</span> </p> </div> <p>If the Mask Hit Ratio in Mask tab is already checked and tries to switch the Eye Rendering mode from Complete to Fast, it displays below warning message.</p> <div data-bbox="480 1129 1162 1377" style="border: 1px solid gray; padding: 10px; background-color: #f0f0f0;"> <p style="text-align: center;"><b>WARNING</b> <span style="float: right;">✕</span></p> <p> Fast Eye Rendering is not compatible with Mask Hit Ratio. Turning Mask Hit Ratio off.</p> </div> <p>If this happens, the Mask Hit Ratio box in Mask tab remains unchecked and the Eye Rendering mode switches to Fast and no Hit Ratio results displayed on the mask badge.</p> <p>Double-tap the Mask badge to open the Mask badge menu. Select the <b>Pass/Fail Criteria</b> based on either <b>Total Hits</b> which allows to enter an integer value or <b>Hit Ratio</b> which allows you to enter double value. When no Hit Ratio is displayed on the Mask badge, the Pass/Fail Criteria is based on Total Hits.</p> <div data-bbox="480 1591 1032 1881" style="border: 1px solid gray; padding: 10px; background-color: #f0f0f0;"> <div style="display: flex; justify-content: space-between;"> <div style="width: 45%;"> <p><b>MASK 1</b> <span style="float: right;">?</span></p> <p>Pass/Fail Criteria</p> <p><span style="border: 1px solid gray; padding: 2px 5px; margin-right: 5px;">Total Hits</span> <span style="border: 1px solid gray; padding: 2px 5px;">Hit Ratio</span></p> <p>Fail if Greater Than</p> <p style="text-align: center;"><input style="width: 50px;" type="text" value="1"/></p> </div> <div style="width: 50%; border-left: 1px solid gray; padding-left: 5px;"> <p>Meas 1 <span style="float: right;">1</span></p> <p>TJ@BER</p> <p>μ: --</p> <p><b>Insufficient Edge...</b></p> <p><b>Mask (Plot 1)</b> <span style="float: right;">▼</span></p> <p>Total: 0 UI hits</p> <p>Hit Ratio: 0</p> <p>Status: None</p> </div> </div> </div>



## Save panel fields and controls

Use the Save panel controls to save the plot image or data to a file for inclusion in reports or further analysis in other applications.

Field or control	Description
<b>Save Plot Image</b>	Tap to open the Save As menu. Navigate to the location where you want to save the plot image. Enter a file name in the File Name field. Select the image file format (PNG, BMP, or JPG).  Tap <b>OK</b> to save the plot image.
<b>Save Plot Data</b>	Tap to open the Save As menu. Navigate to the location where you want to save the plot data. Enter a file name in the File Name field.  Tap <b>OK</b> to save the plot data as a comma-separated values (.csv) file.

## Closing a plot view

To close (delete) a Plot view, tap the **X** in the upper right corner of the view.

Deleting the Measurement badge that enabled the plot also closes the plot.

## Recall Mask File configuration menu

Use this menu to recall (load) an eye diagram mask definition file to apply to an eye diagram plot.

To open the **Recall Mask File** configuration menu:



1. Double-tap anywhere in the **Eye Diagram** plot view to open its configuration menu.
2. Tap the **Mask** panel.
3. Tap **Browse**.

To display an eye diagram plot, see [Add Plot configuration menu](#) on page 336.

## Browse Mask File Location configuration menu fields and controls

Field or control	Description
<b>Look in:</b>	Shows the current directory path to the location of a file.  Tap on the file path and use a keyboard to enter the location location. Or double-tap on the file name to open the virtual keyboard and enter a path.  Tap the down arrow icon on the right end of the field to open a list of recalled mask file locations, up to a maximum of 20 locations.

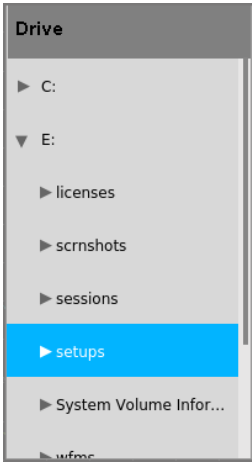
Table continued...

Field or control	Description
	<p>The <b>Drive</b> column lists the accessible directories, opening at the root (/) level. Use to quickly navigate to a location.</p> <p>Tap a name in the <b>Drive</b> list to show the contents of the directory in the Name pane.</p> <p>Double-tap an item to display the directory and any subdirectories under it. Double-tap again to close that directory structure.</p> <p>Drag the list up and down to show more entries.</p>
	<p>Navigation buttons. Use the arrow buttons to navigate the file directory.</p> <p>The left arrow navigates back to the previously visited folder.</p> <p>The Right arrow navigates forward to the previously visited folder.</p> <p>The Up arrow navigates up one level from the current folder.</p>
	<p>Create new Directory icon. Use to create a new directory (folder) at the current location. Opens the new directory after it is created.</p>
<b>File name</b>	Shows the selected file path and name.
<b>Files of type</b>	Use to select the file format you want to recall. The drop-down list shows all file extension types that the instrument can read for the selected file type.
<b>Cancel</b>	Cancels the file open action and closes the menu.
<b>Open</b>	<p>Opens (loads) the selected file.</p> <p>Recalling a mask file adds a Mask badge to the Settings bar and displays the masks in the eye diagram plot.</p>

## Fast Frame Timestamp Trend plot configuration menu

Use this menu to change settings of a displayed Fast Frame Timestamp plot.

To open the Fast Frame Timestamp plot configuration menu, double-tap anywhere in a **Fast Frame Timestamp Plot** view.

## Fast Frame Timestamp plot configuration menu fields and controls

Field or control	Description
<b>AutoScale</b>	<p>Toggles AutoScale On or Off (Default is On). Turn AutoScale off to set the X and Y-axis range to view an area of interest.</p> <p>When AutoScale is Off (unchecked), the Plot view zoom mode enables and a small Zoom window appears in the plot. Drag the blue zoom area box in the small Zoom window to view that area in the main Plot view. You can also use the Zoom and Pan front-panel knobs to change the zoom area and horizontal position.</p>
<b>Gridlines</b>	Selects which gridlines to show in the plot. Available gridlines are Horizontal, Vertical, and Both.
<b>X-Axis From, To</b>	<p>Sets the beginning and end scale range to display in the plot for the X-Axis scales.</p> <p>These values also define the horizontal area shown in the small Zoom window.</p> <p>Available when AutoScale is Off.</p>
<b>Y-Axis From, To</b>	<p>Sets the beginning and end scale range to display in the plot for the Y-Axis scales.</p> <p>These values also define the vertical area shown in the small Zoom window.</p> <p>Available when AutoScale is Off.</p>

## Save panel fields and controls

Use the Save panel controls to save the plot image or data to a file for inclusion in reports or further analysis in other applications.

Field or control	Description
<b>Save Plot Image</b>	<p>Tap to open the Save As menu. Navigate to the location where you want to save the plot image. Enter a file name in the File Name field. Select the image file format (PNG, BMP, or JPG).</p> <p>Tap <b>OK</b> to save the plot image.</p>
<b>Save Plot Data</b>	<p>Tap to open the Save As menu. Navigate to the location where you want to save the plot data. Enter a file name in the File Name field.</p> <p>Tap <b>OK</b> to save the plot data as a comma-separated values (.csv) file.</p>

## Closing a plot view

To close (delete) a Plot view, tap the **X** in the upper right corner of the view.

Deleting the Measurement badge that enabled the plot also closes the plot.

## Harmonics Bar Graph plot configuration menu (IMDA)

Use this menu to change settings of a displayed harmonics bar plot (IMDA Harmonics measurement).

### Settings panel (Harmonics Bar Graph configuration menu) fields and controls

Field or control	Description
<b>Wiring: 3 Phase-3 Wire (2V2I)</b>	<p>Set to measure 2V2I or 3V3I for 3P3W and 3P4W based on motor configuration. They can also use Line-to-Line and Line-to-Neutral for mathematical conversion.</p> <ul style="list-style-type: none"> <li>• 1 Phase-2 Wire (1V1I)</li> <li>• 1 Phase-3 Wire (2V2I)</li> <li>• 3 Phase-3 Wire (2V2I)</li> <li>• 3 Phase-3 Wire (3V3I)</li> <li>• 3 Phase-4 Wire (3V3I)</li> </ul> <p>Tap the field to show the list of available sources.</p> <p>Both ABC and XYZ combination.</p>
<b>Plot Display</b>	<p>Select the magnitude and the phase angle. The number of V and I depends on the wiring configuration.</p> <ul style="list-style-type: none"> <li>• All</li> <li>• One pair V and I</li> <li>• One pair V</li> <li>• One pair I</li> </ul>
<b>V and I Pair</b>	<p>Vac (Math 2), Ia (Ch 1)</p> <p>Vbc (Ch2), Ib (Ch 3)</p> <p>Available when <b>Plot Display = One pair V and I</b></p>
<b>Voltage Pair</b>	<p>Vac (Ch 1), Vbc (Ch 3)</p> <p>Available when <b>Plot Display = One pair V</b></p>
<b>Current Pair</b>	<p>Ia (Ch 2), Ib (Ch 4)</p> <p>Available when <b>Plot Display = One pair I</b></p>

### Save panel fields and controls

Use the Save panel controls to save the plot image or data to a file, for inclusion in reports or further analysis in other applications.

Field or control	Description
<b>Save Plot Image</b>	<p>Tap to open the <b>Save As</b> menu. Navigate to the location where you want to save the plot image.</p> <p>Enter a file name in the <b>File Name</b> field. Select the image file format (PNG, BMP, or JPG).</p> <p>Tap <b>OK</b> to save the plot image.</p>

### Closing a plot view

To close (delete) a Plot view, tap the **X** in the upper right corner of the view.

Deleting the Measurement badge that opened the plot also closes the plot.

## Harmonics Bar Graph plot configuration menu

Use this menu to change settings of a displayed harmonics bar plot (Power Harmonics measurement).

To open the Bar Graph plot configuration menu, double-tap anywhere in a **harmonics** Plot view.

### Settings panel (Harmonics Bar Graph configuration menu) fields and controls

Field or control	Description
<b>AutoScale</b>	Toggles <b>AutoScale On</b> or <b>Off</b> . Turn <b>AutoScale</b> off to manually set the X and Y-axis range to view an area of interest.  When <b>AutoScale</b> is <b>Off</b> , a small Zoom window appears in the plot. Drag the blue vertical bar in the Zoom window to view that area in the main Plot view. Use the <b>Zoom</b> and <b>Pan</b> front-panel knobs to change the zoom area and position.
<b>Gridlines</b>	Selects which gridlines to show in the plot. Select the grid style that meets your measurement needs.
<b>Unit panel</b>	Set the unit to Linear or Log.  A Log scale is useful when the component magnitudes cover a wide dynamic range, letting you show both lesser- and greater- magnitude components on the same display.  A Linear scale is useful when the component magnitudes are all close in value, allowing direct comparison of their magnitudes.
<b>Harmonics</b> (Inside the Unit panel)	Select All/Odd/Even.

### Save panel fields and controls

Use the Save panel controls to save the plot image or data to a file, for inclusion in reports or further analysis in other applications.

Field or control	Description
<b>Save Plot Image</b>	Tap to open the <b>Save As</b> menu. Navigate to the location where you want to save the plot image.  Enter a file name in the <b>File Name</b> field. Select the image file format (PNG, BMP, or JPG).  Tap <b>OK</b> to save the plot image.
<b>Save Plot Data</b>	Tap to open the <b>Save As</b> menu. Navigate to the location where you want to save the plot data.  Enter a file name in the <b>File Name</b> field.  Tap <b>OK</b> to save the plot data as a comma-separated values (.csv) file. It saves the selected standard limits and computed Harmonic values.

### Closing a plot view

To close (delete) a Plot view, tap the **X** in the upper right corner of the view.

Deleting the Measurement badge that opened the plot also closes the plot.

## Histogram plot configuration menu

Use this menu to change settings of a displayed Histogram plot.

To open the Histogram plot configuration menu, double-tap anywhere in a **Histogram** Plot view.

### Settings panel (Histogram plot configuration menu) fields and controls

Field or control	Description
<b>AutoScale</b>	Toggles AutoScale on or off. Turn AutoScale off to set the X and Y-axis range to view an area of interest.  When AutoScale is off, the Plot view zoom mode enables and a small Zoom window appears in the plot. Drag the blue zoom area box in the small Zoom window to view that area in the main Plot view. Use the Zoom and Pan front-panel knobs to change the zoom area and horizontal position.
<b>Gridlines</b>	Selects which gridlines to show in the plot.
<b>X-Axis Number of Bins</b>	Sets the resolution by the number of bins into which the X axis is divided.
<b>X-Axis From, To</b>	Sets the beginning and end scale range to display in the plot for the X-Axis scales.  These values also define the horizontal area shown in the small Zoom window.  Available when AutoScale is off.
<b>Y-Axis From, To</b>	Sets the beginning and end scale range to display in the plot for the Y-Axis scales.  These values also define the vertical area shown in the small Zoom window.  Available when AutoScale is off.
<b>Y-Axis Scale</b>	Sets the Y axis scale to Linear or Log.  A <b>Log</b> scale is useful when the component magnitudes cover a wide dynamic range, letting you show both lesser- and greater-magnitude components on the same display.  A <b>Linear</b> scale is useful when the component magnitudes are all close in value, allowing direct comparison of their magnitudes.

### Save panel fields and controls

Use the Save panel controls to save the plot image or data to a file for inclusion in reports or further analysis in other applications.

Field or control	Description
<b>Save Plot Image</b>	Tap to open the Save As menu. Navigate to the location where you want to save the plot image. Enter a file name in the File Name field. Select the image file format (PNG, BMP, or JPG).  Tap <b>OK</b> to save the plot image.
<b>Save Plot Data</b>	Tap to open the Save As menu. Navigate to the location where you want to save the plot data. Enter a file name in the File Name field.  Tap <b>OK</b> to save the plot data as a comma-separated values (.csv) file.

### Closing a plot view

To close (delete) a Plot view, tap the **X** in the upper right corner of the view.

Deleting the Measurement badge that enabled the plot also closes the plot.

## Inductance Curve configuration menu (Magnetic Analysis power measurement)

Use this menu to change settings of a displayed Inductance curve plot (Inductance measurement).

To open the Inductance Curve plot configuration menu, double-tap anywhere in an **Inductance Curve** Plot view.

### Settings panel (Inductance Curve configuration menu) fields and controls

Field or control	Description
<b>AutoScale</b>	Toggles <b>AutoScale On</b> or <b>Off</b> . Turn <b>AutoScale</b> off to manually set the X and Y-axis range to view an area of interest.  When <b>AutoScale</b> is <b>Off</b> , a small Zoom window appears in the plot. Drag the blue vertical bar in the Zoom window to view that area in the main Plot view. Use the <b>Zoom</b> and <b>Pan</b> front-panel knobs to change the zoom area and position.
<b>Gridlines</b>	Selects which gridlines to show in the plot. Select the grid style that meets your measurement needs.
<b>Display</b>	Vectors draws waveforms with lines between record points.  Dots draws waveform record points as dots on the screen.
<b>X-Axis</b>	Sets the beginning and end scale range to display in the plot for the X-Axis scales.  This is displayed when <b>AutoScale</b> is <b>Off</b> (deselected).
<b>Y-Axis</b>	Sets the beginning and end scale range to display in the plot for the Y-Axis scales. This is displayed when <b>AutoScale</b> is <b>Off</b> (deselected).

### Save panel fields and controls

Use the Save panel controls to save the plot image or data to a file, for inclusion in reports or further analysis in other applications.

Field or control	Description
<b>Save Plot Image</b>	Tap to open the <b>Save As</b> menu. Navigate to the location where you want to save the plot image.  Enter a file name in the <b>File Name</b> field. Select the image file format (PNG, BMP, or JPG).  Tap <b>OK</b> to save the plot image.
<b>Save Plot Data</b>	Tap to open the <b>Save As</b> menu. Navigate to the location where you want to save the plot data.  Enter a file name in the <b>File Name</b> field.  Tap <b>OK</b> to save the plot data as a comma-separated values (.csv) file. It saves the selected standard limits and computed Harmonic values.

### Closing a plot view

To close (delete) a Plot view, tap the **X** in the upper right corner of the view.

Deleting the Measurement badge that opened the plot also closes the plot.

## I vs (integral of) V plot configuration menu (Magnetic Analysis power measurement)

Use this menu to change settings of a displayed I vs. ∫V plot (I vs. ∫V measurement).

To open the I vs. ∫V plot configuration menu, double-tap anywhere in the **I vs. ∫V** Plot view.

### Settings panel (I vs. ∫V plot configuration menu) fields and controls

Field or control	Description
<b>AutoScale</b>	Toggles <b>AutoScale On</b> or <b>Off</b> . Turn <b>AutoScale</b> off to manually set the X and Y-axis range to view an area of interest.  When <b>AutoScale</b> is off, a small Zoom window appears in the plot. Drag the blue vertical bar in the Zoom window to view that area in the main Plot view. Use the <b>Zoom</b> and <b>Pan</b> front-panel knobs to change the zoom area and position.
<b>Gridlines</b>	Selects which gridlines to show in the plot. Select the grid style that meets your measurement needs.
<b>Display</b>	Vectors draws waveforms with lines between record points.  Dots draws waveform record points as dots on the screen.
<b>X-Axis</b>	Sets the beginning and end scale range to display in the plot for the X-Axis scales.  It is displayed only when <b>AutoScale</b> is off (deselected).
<b>Y-Axis</b>	Sets the beginning and end scale range to display in the plot for the Y-Axis scales.  It is displayed only when <b>AutoScale</b> is off (deselected).

### Save panel fields and controls

Use the Save panel controls to save the plot image or data to a file, for inclusion in reports or further analysis in other applications.

Field or control	Description
<b>Save Plot Image</b>	Tap to open the <b>Save As</b> menu. Navigate to the location where you want to save the plot image.  Enter a file name in the <b>File Name</b> field. Select the image file format (PNG, BMP, or JPG).  Tap <b>OK</b> to save the plot image.
<b>Save Plot Data</b>	Tap to open the <b>Save As</b> menu. Navigate to the location where you want to save the plot data.  Enter a file name in the <b>File Name</b> field.  Tap <b>OK</b> to save the plot data as a comma-separated values (.csv) file. It saves the selected standard limits and computed Harmonic values.

### Closing a plot view

To close (delete) a Plot view, tap the **X** in the upper right corner of the view.

Deleting the Measurement badge that opened the plot also closes the plot.

## Impedance plot configuration menu

Use this menu to change the settings of a displayed Impedance plot (Impedance measurement).

To open the Impedance configuration menu, double-tap anywhere in a **Impedance** Plot view.



## Settings panel (Impedance plot configuration menu) fields and controls

Field or control	Description
<b>AutoScale</b>	Toggles <b>AutoScale On</b> or <b>Off</b> . Turn <b>AutoScale</b> off to manually set the X and Y-axis range to view an area of interest.  When <b>AutoScale</b> is Off, a small Zoom window appears in the plot. Drag the blue vertical bar in the Zoom window to view that area in the main Plot view. Use the <b>Zoom</b> and <b>Pan</b> front-panel knobs to change the zoom area and position.
<b>Gridlines</b>	Selects which gridlines to show in the plot. Select the grid style that meets your measurement needs.
<b>Display</b>	<b>Vectors</b> draws waveforms with lines between record points. <b>Dots</b> draws waveform record points as dots on the screen.
<b>X-Axis</b>	Sets the beginning and end scale range to display in the plot for the X-Axis scales.  This is displayed only when <b>AutoScale</b> is Off (deselected).
<b>Y-Axis</b>	Sets the beginning and end scale range to display in the plot for the Y-Axis scales.  This is displayed only when <b>AutoScale</b> is Off (deselected).

## Save panel fields and controls

Use the Save panel controls to save the plot image or data to a file, for inclusion in reports or further analysis in other applications.

Field or control	Description
<b>Save Plot Image</b>	Tap to open the <b>Save As</b> menu. Navigate to the location where you want to save the plot image. Enter a file name in the <b>File Name</b> field. Select the image file format (PNG, BMP, or JPG). Tap <b>OK</b> to save the plot image.
<b>Save Plot Data</b>	Tap to open the <b>Save As</b> menu. Navigate to the location where you want to save the plot data. Enter a file name in the <b>File Name</b> field. Tap <b>OK</b> to save the plot data as a comma-separated values (.csv) file. It saves the selected standard limits and computed Harmonic values.

## Closing a plot view

To close (delete) a Plot view, tap the **X** in the upper right corner of the view.

Deleting the Measurement badge that opened the plot also closes the plot.

## Math FFT plot configuration menu (Math waveform)

Use the Math FFT plot menu to change settings of a displayed FFT plot, including source, FFT window type, plot type, and gating.

To open the FFT plot configuration menu, double-tap anywhere in the **Math FFT** Plot view.

**Plot Settings panel (Math FFT plot configuration menu) fields and controls**

Field or control	Description
<b>Auto Scale</b>	Toggles auto scaling of the plot on or off. When AutoScale is off, a small Zoom window appears in the plot. Drag the blue zoom area box in the small Zoom window to view that area in the main Plot view. Use the Zoom and Pan front-panel knobs to change the zoom area and horizontal position.
<b>Gridlines</b>	Sets which gridlines to show in the plot (Horizontal, Vertical, or Both).
<b>X-Axis Scale</b>	Sets the horizontal frequency scale to either Log or Linear. A <b>Log</b> scale is useful when the frequency component magnitudes cover a wide dynamic range, letting you show both lesser and greater- magnitude frequency components on the same display. A <b>Linear</b> scale is useful when the frequency component magnitudes are all close in value, allowing direct comparison of their magnitudes.
<b>Y-Axis Scale</b>	Sets the vertical amplitude scale to dBm or Vrms, when the FFT type is Magnitude. Sets the vertical amplitude scale to Linear, when the FFT type is Phase, Real or Imaginary. A <b>Log dB</b> scale is useful when the frequency component magnitudes cover a wide dynamic range, letting you show both lesser and greater magnitude frequency components on the same display. A <b>Linear</b> scale is useful when the frequency component magnitudes are all close in value, enabling direct comparison of their magnitudes.
<b>X-Axis From, To</b>	Sets the beginning and end scale range to display in the plot for the X-Axis scale. These values also define the horizontal zoom area shown in the small Zoom window. Available when AutoScale is off.
<b>Y-Axis From, To</b>	Sets the beginning and end scale range to display in the plot for the Y-Axis scale. These values also define the vertical zoom area shown in the small Zoom window. Available when AutoScale is off.

**FFT Settings panel (Math FFT plot configuration menu) fields and controls**

Field or control	Description
<b>FFT Type</b>	<b>Magnitude</b> plots the magnitude values of the frequency components. <b>Phase</b> plots the phase of the signal as a function of frequency.
<b>Window</b>	Sets the FFT window type to use for the waveform plot. See <a href="#">FFT windows</a> on page 527.
<b>Gating</b>	Sets the region of the waveform to analyze for the FFT plot. <b>None</b> uses the entire waveform record to create the FFT plot. <b>Screen</b> uses the part of the waveform record displayed on the screen (such as in Zoom mode) to create the FFT plot. <b>Cursors</b> uses the waveform data between the cursors to create the FFT plot.

Table continued...

Field or control	Description
<b>Vertical Units</b>	<p>Sets the vertical scale to Degrees, Radians, or Group Delay.</p> <p> <b>Note:</b> The Vertical Units set when FFT Type = Phase override the Y-Axis scale setting in the Plot Settings panel.</p> <p>Only available when FTT Type set to Phase.</p>
<b>Phase Wrap</b>	<p>When checked, the phase trace is unwrapped where the trace jumps more than the number of degrees set in the adjacent field.</p> <p>Only available when FTT Type set to Phase.</p>
<b>Squelch</b>	<p>When checked, the phase trace excludes points that have a voltage smaller than the specified voltage. The squelch voltage should be set to the expected noise voltage level. Minimum value is 100 mV, and increments in units of 100 mV.</p> <p>When unchecked, the phase trace includes all values.</p> <p>Only available when FTT Type set to Phase.</p>

### Save panel (Math FFT plot configuration menu) fields and controls

Field or control	Description
<b>Save Plot Image</b>	Opens the <a href="#">Save As</a> configuration menu to specify the location and name at which to save an image file of the Plot view.
<b>Save Plot Data</b>	Opens the <a href="#">Save As</a> configuration menu to specify the location and name at which to save the Plot view data to a CSV file.

### FFT windows

Each FFT window is a trade-off between frequency resolution and magnitude accuracy. What you want to measure and your source signal characteristics help determine which window to use. Use the following guidelines to select the best window.

FFT window	Characteristics	Best for measuring
<b>Hanning</b>	Better frequency, poorer magnitude accuracy than Rectangular. Hanning has slightly poorer frequency resolution than Hamming.	Sine, periodic, and narrow-band random noise. Transients or bursts where the signal levels before and after the event are significantly different.
<b>Rectangular</b>	Best frequency, worst magnitude resolution. This is essentially the same as no window.	Transients or bursts where the signal levels before and after the event are nearly equal. Equal-amplitude sine waves with frequencies that are very close.
<b>Hamming</b>	Better frequency, poorer magnitude accuracy than Rectangular. Hamming has slightly better frequency resolution than Hanning.	Sine, periodic, and narrow-band random noise. Transients or bursts where the signal levels before and after the event are significantly different.
<b>Blackman-Harris</b>	Best magnitude, worst frequency resolution.	Predominantly single frequency signals to look for higher order harmonics.
<b>Kaiser-Bessel</b>	Less spectral leakage than the Hanning, Hamming, or Rectangular windows.	Predominantly single frequency signals to look for higher order harmonics.
<b>Gaussian</b>	The time-domain shape of an exponential Gaussian function transforms into a Gaussian exponential shape in the frequency domain.	Optimal localization in both the time and frequency domain.

Table continued...

FFT window	Characteristics	Best for measuring
Flattop2	Wider resolution bandwidth but lower side lobe attenuation. Also, it is unique because the time domain shape has negative values.	Useful for high accuracy magnitude measurements for signals that do not require very narrow bandwidth.
TekExp	The Tek Exponential window was invented at Tektronix. In the time domain, it is not asymmetrical bell shape as is the case with the other windows. Instead, it is exponential with a peak at the 20% position of the time domain gate. The frequency domain shape is triangular. More of the acquired data record length is used to capture the impulse response.	Use this window for impulse-response testing where the 20% position is the zero phase reference point.

You can also determine the best window empirically by first selecting the Rectangular window, and then selecting (in the following order) the Hamming, Hanning, and Blackman-Harris windows until the frequency components merge. Use the window just prior to where the frequencies emerge for the best compromise between resolution and amplitude accuracy.

### Closing a plot view

To close (delete) a Plot view, tap the **X** in the upper right corner of the view.

Deleting the Measurement badge that enabled the plot also closes the plot.

### Overlapped Recovery plot configuration menu

Use this menu to change settings of a displayed Recovery plot.

You can add this plot from WBG-DPT Trr Measurement Name panel.

To open the Recovery plot configuration menu, double-tap anywhere in a **Recovery** Plot view.

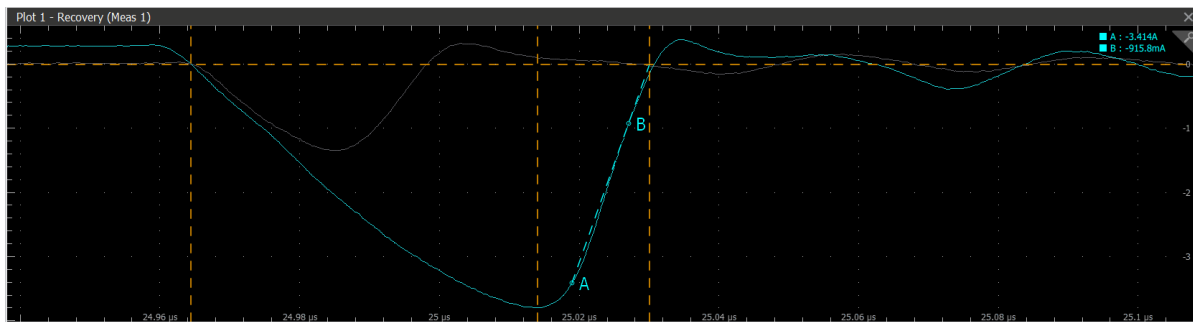

### Settings panel (Recovery plot configuration menu) fields and controls

Field or control	Description
Auto Scale	Sets the Auto Scale on or off. Turn Auto Scale off to set the X and Y-axis range to view an area of interest.  When Auto Scale box is checked, the Plot view zoom mode enables and a small Zoom window appears in the plot. Drag the blue zoom area box in the small Zoom window to view that area in the main Plot view. Use the Zoom and Pan front-panel knobs to change the zoom area and horizontal position.
Grid lines	Sets the grid lines as <b>Horizontal</b> , <b>Vertical</b> , or <b>Both</b> to show in the plot.

Table continued...

Field or control	Description
<b>Display</b>	Sets the <b>Display</b> as <b>Vectors</b> or <b>Dots</b> .
<b>X-Axis (Time) Scale From, To</b>	Sets the beginning and end scale range to display in the plot for the X-Axis scales. These values also define the horizontal area shown in the small Zoom window. Available when Auto Scale is unchecked.
<b>Y-Axis (Current) From, To</b>	Sets the beginning and end scale range to display in the plot for the Y-Axis scales. These values also define the vertical area shown in the small Zoom window. Available when Auto Scale is unchecked.
<b>Pulse Region</b>	Sets the <b>Pulse Region</b> as <b>Selected</b> or <b>All</b> . When <b>Pulse Region</b> is set to <b>Selected</b> , only the selected pulse is displayed on the plot window. To view overlay plot, set <b>Pulse Region</b> to <b>All</b> .

### Save panel fields and controls

Use the Save panel controls to save the plot image or data to a file for inclusion in reports or further analysis in other applications.

Field or control	Description
<b>Save Plot Image</b>	Tap to open the Save As menu. Navigate to the location where you want to save the plot image. Enter a file name in the File Name field. Select the image file format (PNG, BMP, or JPG). Tap <b>OK</b> to save the plot image.
<b>Save Plot Data</b>	Tap to open the Save As menu. Navigate to the location where you want to save the plot data. Enter a file name in the File Name field. Tap <b>OK</b> to save the plot data as a comma-separated values (.csv) file. Pulse number and the corresponding Trr value will be saved in the .csv file.

### Closing a plot view

To close (delete) a Plot view, tap the **X** in the upper right corner of the view.

Deleting the Measurement badge that enabled the plot also closes the plot.

### Phasor Diagram plot configuration menu (IMDA-DQ0)

Use this menu to change settings of a displayed phasor plot (IMDA-DQ0 measurement).

#### Settings panel (Phasor Diagram configuration menu) fields and controls

The Phasor diagram displays the magnitude and phase angle between the voltage or current. The number of V and I is always 3 phasor. The Phasor plot includes either voltage or current magnitudes with phase values.

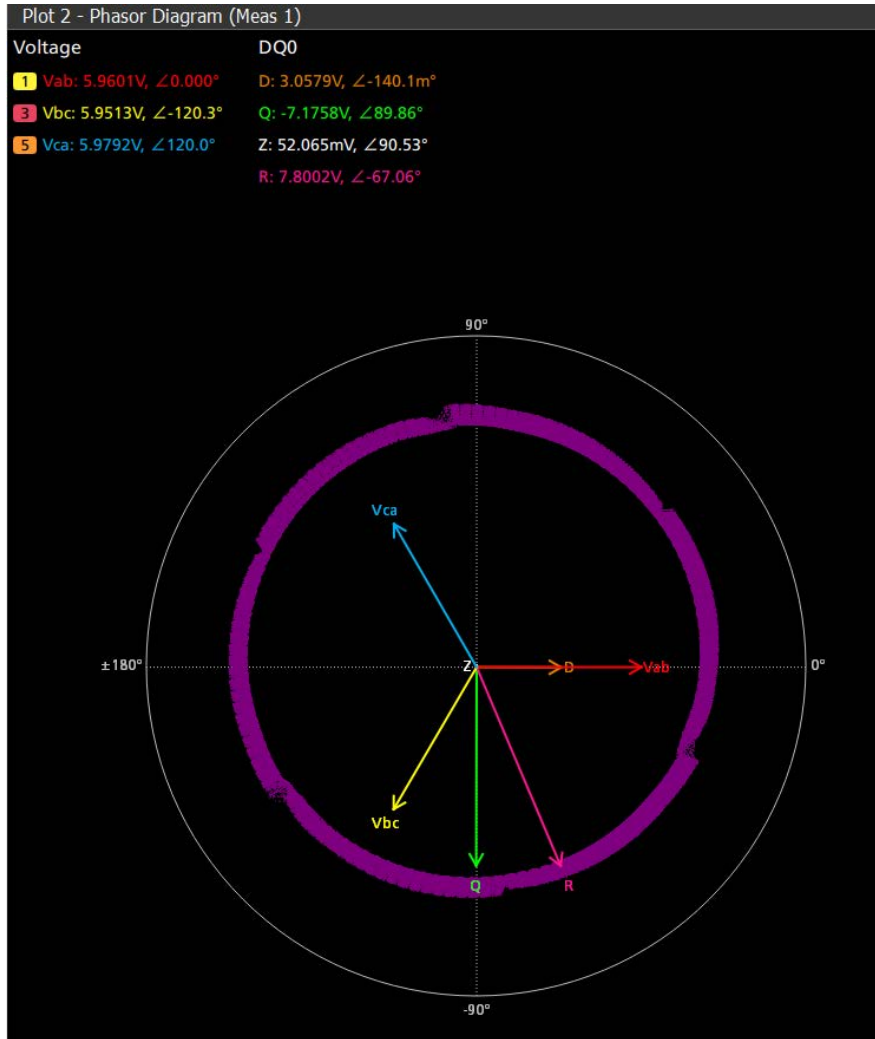

Field or control	Description
Wiring	Allows to measure selected input or output wiring.
Plot Display	Select the plot display. <ul style="list-style-type: none"> <li>• <b>All</b>: Displays both DQ0 and ABC components.</li> <li>• <b>ABC/XYZ</b>: Displays 3 phase voltage and current components.</li> <li>• <b>DQ0</b>: Displays DQ0 components.</li> </ul>
Phasor Type	Select RMS or Magnitude. Available when <b>Plot Display</b> = <b>All</b> or <b>ABC/XYZ</b> .

 **Note:** Change in vector naming is based on Line-to-Line and Line-to-Neutral selection in the source setup panel.

The plot configuration has phasor type to choose RMS or Magnitude. The voltage or current values are RMS vector results, while Phase uses DFT method.

### Save panel fields and controls

Use the Save panel controls to save the plot image or data to a file, for inclusion in reports or further analysis in other applications.

Field or control	Description
Save Plot Image	Tap to open the <b>Save As</b> menu. Navigate to the location where you want to save the plot image. Enter a file name in the <b>File Name</b> field. Select the image file format (PNG, BMP, or JPG). Tap <b>OK</b> to save the plot image.

### Closing a plot view

To close (delete) a Plot view, tap the **X** in the upper right corner of the view.

Deleting the Measurement badge that opened the plot also closes the plot.

### Phasor Diagram plot configuration menu (IMDA-Power Quality)

Use this menu to change settings of a displayed phasor plot (IMDA Power Quality measurement).

#### Settings panel (Phasor Diagram configuration menu) fields and controls

The Phasor diagram displays the magnitude and phase angle between the voltage and current. The number of V and I depends on the wiring configuration. The Phasor plot includes:

- All voltage magnitudes with phase values
- All current magnitudes with phase values
- Phase angle between the V and I pairs
- Power Factor for all voltages and currents

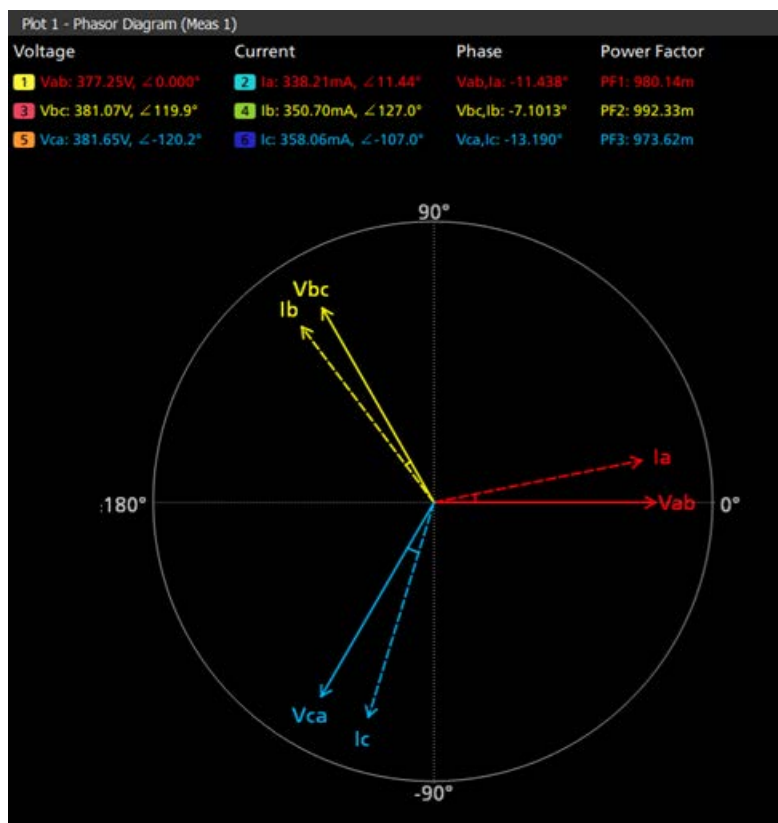

Field or control	Description
<b>Wiring</b>	<p>Allows to measure 2V2I or 3V3I for 3P3W and 3P4W based on motor configuration. They can also use Line-to-Line and Line-to-Neutral for mathematical conversion.</p> <ul style="list-style-type: none"> <li>• 1 Phase-2 Wire (1V1I)</li> <li>• 1 Phase-3 Wire (2V2I)</li> <li>• 3 Phase-3 Wire (2V2I)</li> <li>• 3 Phase-3 Wire (3V3I)</li> <li>• 3 Phase-4 Wire (3V3I)</li> </ul>
<b>Plot Display</b>	<p>Select the magnitude and the phase angle. The number of V and I depends on the wiring configuration.</p> <ul style="list-style-type: none"> <li>• All</li> <li>• One pair V and I</li> <li>• One pair V</li> <li>• One pair I</li> </ul>
<b>V and I Pair</b>	<p>Vac (Math 2), Ia (Ch 1) Vbc (Ch2), Ib (Ch 3)</p> <p>Available when <b>Plot Display = One pair V and I</b></p>
<b>Voltage Pair</b>	<p>Vac (Math 2), Vbc (Ch 2)</p> <p>Available when <b>Plot Display = One pair V</b></p>
<b>Current Pair</b>	<p>Ia (Ch 1), Ib (Ch 3)</p> <p>Available when <b>Plot Display = One pair I</b></p>
<b>Phasor Type</b>	<p>Allows to select amplitude computation method either RMS or Magnitude.</p> <p>RMS is computed on the time domain waveform. Magnitude values are computed at the fundamental or operating frequency of the signal.</p>



**Note:** Change in vector naming is based on Line-to-Line and Line-to-Neutral selection in the high level.

The Vector displays RMS values of Voltage and Current and not the magnitude. The voltage and current values are RMS vector results, while Phase uses DFT method.

### Save panel fields and controls

Use the Save panel controls to save the plot image or data to a file, for inclusion in reports or further analysis in other applications.

Field or control	Description
<b>Save Plot Image</b>	<p>Tap to open the <b>Save As</b> menu. Navigate to the location where you want to save the plot image.</p> <p>Enter a file name in the <b>File Name</b> field. Select the image file format (PNG, BMP, or JPG).</p> <p>Tap <b>OK</b> to save the plot image.</p>



## Closing a plot view

To close (delete) a Plot view, tap the **X** in the upper right corner of the view.

Deleting the Measurement badge that opened the plot also closes the plot.

## Phase Noise plot configuration menu

Use this menu to change settings of a phase noise plot.

To open the Phase Noise plot configuration menu, double-tap anywhere in the **Phase Noise** plot view.

To close a plot view, tap the X in the upper right corner of the view. Deleting the Measurement badge that opened the plot also closes the plot.

### Settings panel (Phase Noise plot configuration menu) fields and controls

Field or control	Description
<b>Autoscale</b>	Toggles auto scaling of the plot on or off.  When AutoScale is off, a small Zoom window appears in the plot. Drag the blue zoom area box in the small Zoom window to view that area in the main Plot view. Use the Zoom and Pan front-panel knobs to change the zoom area and horizontal position.
<b>Gridlines</b>	Sets the gridlines to show in the plot. Available gridlines are Horizontal, Vertical, and Both.
<b>X-Axis Scale From, To</b>	Sets the beginning and end scale range to display in the plot for the X-Axis scales, in unit intervals.  These values also define the horizontal area displayed in the small Zoom window.  Available when <b>AutoScale</b> is <b>Off</b> .
<b>Y-Axis Scale From, To</b>	Sets the beginning and end scale range to display in the plot for the Y-Axis scales, in unit intervals.  These values also define the vertical area displayed in the small Zoom window.  Available when <b>AutoScale</b> is <b>Off</b> .

### Save panel fields and controls

Use the Save panel controls to save the plot image or data to a file for inclusion in reports or further analysis in other applications.

Field or control	Description
<b>Save Plot Image</b>	Tap to open the Save As menu. Navigate to the location where you want to save the plot image. Enter a file name in the File Name field. Select the image file format (PNG, BMP, or JPG).  Tap <b>OK</b> to save the plot image.
<b>Save Plot Data</b>	Tap to open the Save As menu. Navigate to the location where you want to save the plot data. Enter a file name in the File Name field.  Tap <b>OK</b> to save the plot data as a comma-separated values (.csv) file.

## Closing a plot view

To close (delete) a Plot view, tap the **X** in the upper right corner of the view.

Deleting the Measurement badge that enabled the plot also closes the plot.

## Power Supply Rejection Ratio plot configuration menu

Use this menu to change the settings of a displayed Power Supply Rejection Ratio plot (Power Supply Rejection Ratio measurement).

To open the Power Supply Rejection Ratio plot configuration menu, double-tap anywhere in a **Power Supply Rejection Ratio** Plot view.

### Settings panel (Power Supply Rejection Ratio plot configuration menu) fields and controls

Field or control	Description
<b>AutoScale</b>	Toggles <b>AutoScale On</b> or <b>Off</b> . Turn <b>AutoScale</b> of to manually set the X and Y-axis range to view an area of interest.  When <b>AutoScale</b> is Off, a small Zoom window appears in the plot. Drag the blue vertical bar in the Zoom window to view that area in the main Plot view. Use the <b>Zoom</b> and <b>Pan</b> front-panel knobs to change the zoom area and position.
<b>Gridlines</b>	Selects which gridlines to show in the plot. Select the grid style that meets your measurement needs.
<b>Display</b>	<b>Vectors</b> draws waveforms with lines between record points. <b>Dots</b> draws waveform record points as dots on the screen.
<b>Interpolation</b>	Select the method to display the record points between sampled points. <b>Sin(x)/x</b> connects using a Sin(x)/x curve between the computed values. This makes the gain or phase curve smoother than linear interpolation. <b>Linear</b> connects between computed points (Gain or Phase value) using a straight-line fit. Measurement annotations are displayed for Linear mode interpolation only.
<b>X-Axis</b>	Sets the beginning and end scale range to display in the plot for the X-Axis scales.  This is displayed only when <b>AutoScale</b> is Off (deselected).
<b>Y-Axis</b>	Sets the beginning and end scale range to display in the plot for the Y-Axis scales.  This is displayed only when <b>AutoScale</b> is Off (deselected).

### Save panel fields and controls

Use the Save panel controls to save the plot image or data to a file, for inclusion in reports or further analysis in other applications.

Field or control	Description
<b>Save Plot Image</b>	Tap to open the <b>Save As</b> menu. Navigate to the location where you want to save the plot image.  Enter a file name in the <b>File Name</b> field. Select the image file format (PNG, BMP, or JPG).  Tap <b>OK</b> to save the plot image.
<b>Save Plot Data</b>	Tap to open the <b>Save As</b> menu. Navigate to the location where you want to save the plot data.  Enter a file name in the <b>File Name</b> field.  Tap <b>OK</b> to save the plot data as a comma-separated values (.csv) file. It saves the selected standard limits and computed Harmonic values.

### Closing a plot view

To close (delete) a Plot view, tap the **X** in the upper right corner of the view.

Deleting the Measurement badge that opened the plot also closes the plot.

## Power plots and cursors

Use cursors in I vs.  $\int V$  and B-H curve plots to take measurements at any point on these power measurement plot waveforms.

Cursor readouts display the voltage and current values at their position and the difference (delta) between the cursors. You can display cursors in I vs.  $\int V$  and B-H curve plots.

1. Select the plot to which you want to add cursors.
2. Tap the **Add New...Cursors** button, or push the front-panel **Cursors** button.

The cursors are displayed on the plot. By default, the Cursor read-out box is displayed on the left corner of the plot view.

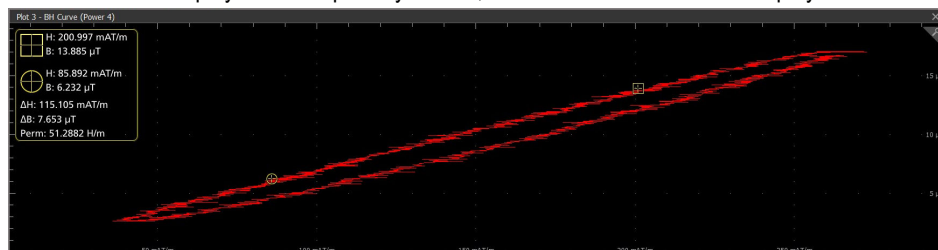

3. Use Multipurpose Knobs **A** and **B** to move the cursors on the waveform, or touch and drag a cursor.



**Note:** Moving the waveform cursor in the Waveform View moves the respective cursors in the plot view.

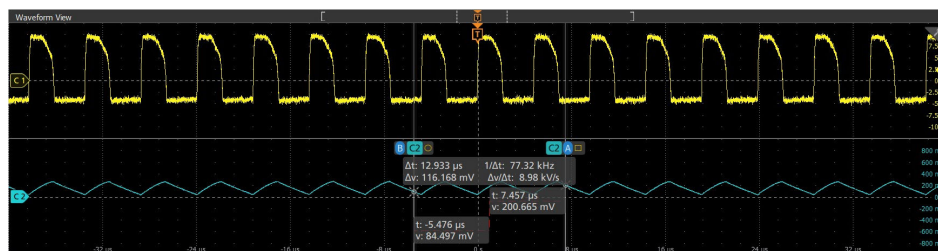

4. Cursors readouts show the position with B and H coordinates, the difference of B and H between the cursors, and the permeability value.
5. To further configure cursors, double-tap on either cursor line or the cursor readouts to open the **Cursors** configuration menu.
6. Tap the Help icon on the menu title for more information on the menu settings.
7. To stop showing cursors, push the front panel **Cursor** button, or press and hold on a cursor to open the right-click menu and turn cursors off, or open the Cursors configuration menu and set Display to **Off**.

## SOA plot configuration menu

Use this menu to change settings of a displayed SOA (XY) plot.

To open the SOA (XY) plot menu, double-tap anywhere in the **SOA** Plot view to open the configuration.

## Settings panel (SOA plot configuration menu) fields and controls

Field or control	Description
<b>AutoScale</b>	Toggles <b>AutoScale On</b> or <b>Off</b> . Turn <b>AutoScale</b> off to manually set the X and Y-axis range to view an area of interest.  When <b>AutoScale</b> is off, a small Zoom window appears in the plot. Drag the blue vertical bar in the Zoom window to view that area in the main Plot view. Use the Zoom and Pan front-panel knobs to change the zoom area and position.
<b>Gridlines</b>	Selects which gridlines to show in the plot. Select the grid style that meets your measurement needs.
<b>Display</b>	Vectors draws waveforms with lines between record points.  Dots draws waveform record points as dots on the screen.
<b>X-Axis (Voltage) Scale</b>	To change the scale from linear to log or vice versa, click on the button (linear or log).  This scale applies on the plot data as well as on the mask data.
<b>Y-Axis (Current) Scale</b>	To change the scale from linear to log or vice versa, click on the button (linear or log).  This scale applies on the plot data as well as on the mask data.

## Save panel fields and controls

Use the Save panel controls to save the plot image or date to a file, for inclusion in reports or further analysis in other applications.

Field or control	Description
<b>Save Plot Image</b>	Tap to open the <b>Save As</b> menu. Navigate to the location where you want to save the plot image.  Enter a file name in the <b>File Name</b> field. Select the image file format (PNG, BMP, or JPG).  Tap OK to save the plot image.
<b>Save Plot Data</b>	Tap to open the <b>Save As</b> menu. Navigate to the location where you want to save the plot data.  Enter a file name in the <b>File Name</b> field.  Tap OK to save the plot data as a comma-separated values (.csv) file. It saves the selected standard limits and computed values.

## Closing a plot view

To close (delete) a Plot view, tap the **X** in the upper right corner of the view.

Deleting the Measurement badge that opened the plot also closes the plot.

## Spectrum plot configuration menu

Use this menu to change settings of a displayed Spectrum plot.

To open the Spectrum plot configuration menu, double-tap anywhere in the **Spectrum** plot view.

## Settings panel (Spectrum plot configuration menu) fields and controls

Field or control	Description
<b>AutoScale</b>	<p>Toggles Autoscale on or off. Turn AutoScale off to set the X and Y-axis range to view an area of interest.</p> <p>When AutoScale is off, a small Zoom window appears in the plot. Drag the blue zoom area box in the small Zoom window to view that area in the main Plot view. Use the Zoom and Pan front-panel knobs to change the zoom area and horizontal position.</p>
<b>Gridlines</b>	Sets which gridlines to show in the plot. Use the grid style best suited to your measurement needs.
<b>X-Axis Scale</b>	<p>Sets the X axis scale to Linear or Log.</p> <p>A <b>Log</b> scale is useful when the component magnitudes cover a wide dynamic range, letting you show both lesser- and greater-magnitude components on the same display.</p> <p>A <b>Linear</b> scale is useful when the component magnitudes are all close in value, allowing direct comparison of their magnitudes.</p>
<b>Y-Axis Scale</b>	<p>Sets the Y axis scale to Linear or Log.</p> <p>A <b>Log</b> scale is useful when the component magnitudes cover a wide dynamic range, letting you show both lesser- and greater-magnitude components on the same display.</p> <p>A <b>Linear</b> scale is useful when the component magnitudes are all close in value, allowing direct comparison of their magnitudes.</p>
<b>Dynamic Range</b>	<p>Sets the vertical scale dynamic range.</p> <p>Available when Y-Axis Scale is set to Log.</p>
<b>X-Axis From, To</b>	<p>Sets the beginning and end scale range to display in the plot for the X-Axis scales.</p> <p>These values also define the horizontal area shown in the small Zoom window.</p> <p>Available when AutoScale is off.</p>
<b>Y-Axis From, To</b>	<p>Sets the beginning and end scale range to display in the plot for the Y-Axis scales.</p> <p>These values also define the vertical area shown in the small Zoom window.</p> <p>Available when AutoScale is off.</p>

## Save panel fields and controls

Use the Save panel controls to save the plot image or data to a file for inclusion in reports or further analysis in other applications.

Field or control	Description
<b>Save Plot Image</b>	<p>Tap to open the Save As menu. Navigate to the location where you want to save the plot image. Enter a file name in the File Name field. Select the image file format (PNG, BMP, or JPG).</p> <p>Tap <b>OK</b> to save the plot image.</p>
<b>Save Plot Data</b>	<p>Tap to open the Save As menu. Navigate to the location where you want to save the plot data. Enter a file name in the File Name field.</p> <p>Tap <b>OK</b> to save the plot data as a comma-separated values (.csv) file.</p>

## Closing a plot view

To close (delete) a Plot view, tap the **X** in the upper right corner of the view.

Deleting the Measurement badge that enabled the plot also closes the plot.

## Time Trend plot configuration menu

Use the Time Trend configuration menu to set the time trend plot waveform vertical scale and position, as well as add a label.

To open the Time Trend configuration menu, double-tap the **Time Trend** badge in the Settings bar. You can also double-tap the Time Trend Plot handle.



**Note:** Measurements that can use the trend plot as a source will list the plot in the Source menu list.

### Time Trend configuration menu fields and controls

Field or control	Description
<b>Display</b>	Toggles displaying the <b>On</b> or <b>Off</b> .
<b>Vertical Scale</b>	Shows the vertical scale setting (when Auto Scale is on), or sets the vertical scale (when Auto Scale is off).  Use the up and own arrow buttons to set the vertical scale value when Auto Scale is turned off. You can also use the multipurpose knob or screen keypad to change the value.
<b>Auto Scale</b>	Enables or disables the Auto Scale mode. Auto Scale uses the signal data to dynamically set the vertical scale units.
<b>Label</b>	Adds a label to the Time Trend waveform (appears next to the Time Trend plot handle).
<b>Position</b>	Shows the vertical position setting (when Auto Scale is on), or sets the vertical position (when Auto Scale is off).
<b>Set to Center</b>	Sets the time trend plot to the center (zero) of the graticule (zero).
<b>Phase Display</b>	Available values are <ul style="list-style-type: none"> <li>• Phase 1(V<sub>xy</sub>, I<sub>x</sub>)</li> <li>• Phase 2(V<sub>yz</sub>, I<sub>y</sub>)</li> <li>• Phase 3(V<sub>zx</sub>, I<sub>z</sub>)</li> </ul>

Table continued...

Field or control	Description
<b>Measurements</b>	<p>Available measurements for Power Quality are</p> <ul style="list-style-type: none"> <li>• Vrms</li> <li>• Irms</li> <li>• Frequency</li> <li>• True Power</li> <li>• Apparent Power</li> <li>• Reactive Power</li> <li>• <math>\sum</math> True Power</li> <li>• <math>\sum</math> Reactive Power</li> <li>• <math>\sum</math> Apparent Power</li> </ul> <p>Available measurements for Efficiency are:</p> <ul style="list-style-type: none"> <li>• Input Power</li> <li>• Output Power</li> <li>• Efficiency</li> <li>• Total Efficiency</li> <li>• Sum of Input Power</li> <li>• Sum of Output Power</li> </ul> <p>Available measurements for Speed are:</p> <ul style="list-style-type: none"> <li>• Speed</li> <li>• Acceleration</li> </ul>
<b>Save Plot Data</b>	Saves the plot data to the specified location.



**Note:** In IMDA, Time Trend is displayed only for Power Quality measurements.

### Deleting a time trend plot

To delete a Time Trend plot, touch and hold the **Time Trend** badge to open the right-click menu, and select **Delete Time Trend**. Deleting the Measurement badge that enabled the plot also closes the plot.

### Trajectory plot configuration menu (Switching Loss power measurement)

Use this menu to change settings of a displayed SWL (Switching Loss) Trajectory plot.

To open the Trajectory plot menu, double-tap anywhere in the Plot view.

### Settings panel (Trajectory plot configuration menu) fields and controls

Field or control	Description
<b>AutoScale</b>	Toggles <b>AutoScale On</b> or <b>Off</b> . Turn <b>AutoScale</b> off to manually set the X and Y-axis range to view an area of interest.  When <b>AutoScale</b> is off, a small Zoom window appears in the plot. Drag the blue vertical bar in the Zoom window to view that area in the main Plot view. Use the Zoom and Pan front-panel knobs to change the zoom area and position.
<b>Gridlines</b>	Selects which gridlines to show in the plot. Select the grid style that meets your measurement needs.
<b>Display</b>	Vectors draws waveforms with lines between record points.  Dots draws waveform record points as dots on the screen.
<b>X-Axis (Voltage) From, To</b>	Sets the beginning and end scale range to display in the plot for the X-Axis scales.  It is displayed only when AutoScale is off (unchecked).
<b>Y-Axis (Voltage) From, To</b>	Sets the beginning and end scale range to display in the plot for the Y-Axis scales.  It is displayed only when AutoScale is off (unchecked).

### Save panel fields and controls

Use the Save panel controls to save the plot image or data to a file, for inclusion in reports or further analysis in other applications.

Field or control	Description
<b>Save Plot Image</b>	Tap to open the <b>Save As</b> menu. Navigate to the location where you want to save the plot image.  Enter a file name in the <b>File Name</b> field. Select the image file format (PNG, BMP, or JPG).  Tap <b>OK</b> to save the plot image.
<b>Save Plot Data</b>	Tap to open the <b>Save As</b> menu. Navigate to the location where you want to save the plot data.  Enter a file name in the <b>File Name</b> field.  Tap <b>OK</b> to save the plot data as a comma-separated values (.csv) file. It saves the selected standard limits and computed values.

### Closing a plot view

To close (delete) a Plot view, tap the **X** in the upper right corner of the view.

Deleting the Measurement badge that opened the plot also closes the plot.

### Transient Response plot configuration menu

Use this menu to change settings of a displayed Transient Response plot. This plot is available for impedance measurement.

To open the Transient Response plot configuration menu, double-tap anywhere in the **Phase Response** view.



## Settings panel (Transient Response plot configuration menu) fields and controls

Field or control	Description
<b>AutoScale</b>	Toggles <b>Autoscale On</b> or <b>Off</b> . Turn off to set the X and Y-axis range to view an area of interest. When AutoScale is off, a small Zoom window appears in the plot. Drag the blue zoom area box in the small Zoom window to view that area in the main Plot view. Use the Zoom and Pan front-panel knobs to change the zoom area and horizontal position.
<b>Grid Lines</b>	Sets grid lines in the plot. Use the grid style to adjust how the grid lines are displayed.
<b>Display</b>	<b>Vectors</b> draw waveforms with lines between record points. <b>Dots</b> draw waveform record points as dots on the screen.
<b>Response Type</b>	Sets the response type as <b>Phase</b> , <b>Tg</b> , or <b>Q(Tg)</b> .
<b>X-Axis (Frequency) From, To</b>	Sets the beginning and end scale range to display in the plot for the X-Axis scales, in unit intervals. These values also define the horizontal area displayed in the small Zoom window. Available when <b>AutoScale</b> is <b>Off</b> .
<b>Y-Axis (Phase/Tg/Q(Tg)) From, To</b>	Sets the beginning and end scale range to display in the plot for the Y-Axis scales, in unit intervals. These values also define the vertical area displayed in the small Zoom window. Available when <b>AutoScale</b> is <b>Off</b> .

## Save panel fields and controls

Use the Save panel controls to save the plot image or data to a file for inclusion in reports or further analysis in other applications.

Field or control	Description
<b>Save Plot Image</b>	Tap to open the Save As menu. Navigate to the location where you want to save the plot image. Enter a file name in the File Name field. Select the image file format (PNG, BMP, or JPG). Tap <b>OK</b> to save the plot image.
<b>Save Plot Data</b>	Tap to open the Save As menu. Navigate to the location where you want to save the plot data. Enter a file name in the File Name field. Tap <b>OK</b> to save the plot data as a comma-separated values (.csv) file.

## Closing a plot view

To close (delete) a Plot view, tap the **X** in the upper right corner of the view.

Deleting the Measurement badge that enabled the plot also closes the plot.

## Trend Plot configuration menu

Use the Trend configuration menu to set the trend plot waveform vertical scale and position, as well as add a label.

To open the Trend configuration menu, double-tap the **Trend** badge in the Settings bar. You can also double-tap the Trend Plot handle.



**Note:** Measurements that can use the trend plot as a source will list the plot in the Source menu list.

### Trend configuration menu fields and controls

Field or control	Description
<b>Display</b>	Toggles displaying the Trend plot <b>On</b> or <b>Off</b> .
<b>Vertical Scale</b>	Shows the vertical scale setting (when Auto Scale is on), or sets the vertical scale (when Auto Scale is off).  Use the up and own arrow buttons to set the vertical scale value when Auto Scale is turned off. You can also use the multipurpose knob or screen keypad to change the value.
<b>Auto Scale</b>	Enables or disables the AutoScale mode. Auto Scale uses the signal data to dynamically set the vertical scale units.
<b>Label</b>	Adds a label to the Trend waveform (appears next to the Trend plot handle).
<b>Position</b>	Shows the vertical position setting (when Auto Scale is on), or sets the vertical position (when Auto Scale is off).
<b>Set to 0</b>	Sets the trend plot to the center (zero) of the graticule (zero).
<b>Save Plot Data</b>	Saves the plot data to the specified location.

### Deleting a trend plot

To delete a Trend plot, touch and hold the **Trend** badge to open the right-click menu, and select **Delete Trend**. Deleting the Measurement badge that enabled the plot also closes the plot.

### Plot XY configuration menu

Use this menu to change settings of a displayed XY plot.

To open the XY plot menu, double-tap anywhere in the **XY** Plot view.

### Settings panel (Plot XY configuration menu) fields and controls

Field or control	Description
<b>X-Axis</b>	Sets the source for the X-axis signal.
<b>Y-Axis</b>	Sets the source for the Y-axis signal.

- Use the vertical scale and position controls of the waveform connected to the X- and Y-axis sources to set horizontal scale and position of the XY waveform.
- XY format is particularly useful for studying phase relationships between two similar signals, creating Lissajous Patterns.
- XY format is a dot-only display, although it can have persistence. The Vector style selection has no effect when you select XY format.

### Save panel fields and controls

Use the Save panel controls to save the plot image or date to a file for inclusion in reports or further analysis in other applications.

Field or control	Description
<b>Save Plot Image</b>	Tap to open the Save As menu. Navigate to the location where you want to save the plot image. Enter a file name in the File Name field. Select the image file format (PNG, BMP, or JPG).  Tap <b>OK</b> to save the plot image.

Table continued...

Field or control	Description
Save Plot Data	Tap to open the Save As menu. Navigate to the location where you want to save the plot data. Enter a file name in the File Name field.  Tap <b>OK</b> to save the plot data as a comma-separated values (.csv) file.

### Closing a plot view

To close (delete) a Plot view, tap the **X** in the upper right corner of the view.

Deleting the Measurement badge that enabled the plot also closes the plot.

## XYZ plot configuration menu

Use this menu to change settings of a displayed XYZ plot.

To open the XYZ plot menu, double-tap anywhere in the **XYZ** plot view.

### Settings panel (Plot XYZ configuration menu) fields and controls

Field or control	Description
X-Axis	Sets the source for the X-axis signal.
Y-Axis	Sets the source for the Y-axis signal.
Z-Axis	Sets the source for the Z-axis signal.

- XYZ format compares the voltage levels of the X and Y channel waveform records point-by-point, as in XY format. The displayed waveform intensity is modulated by the Z channel waveform amplitude.
- XYZ format is a dot-only display, although it can have persistence. The Vector style selection has no effect when you select XYZ format.

### Save panel fields and controls

Use the Save panel controls to save the plot image or data to a file for inclusion in reports or further analysis in other applications.

Field or control	Description
Save Plot Image	Tap to open the Save As menu. Navigate to the location where you want to save the plot image. Enter a file name in the File Name field. Select the image file format (PNG, BMP, or JPG).  Tap <b>OK</b> to save the plot image.
Save Plot Data	Tap to open the Save As menu. Navigate to the location where you want to save the plot data. Enter a file name in the File Name field.  Tap <b>OK</b> to save the plot data as a comma-separated values (.csv) file.

### Closing a plot view

To close (delete) a Plot view, tap the **X** in the upper right corner of the view.

Deleting the Measurement badge that enabled the plot also closes the plot.

## Save As configuration menu (plot Save panel, Save Plot Image button)

Use this menu to specify the name and location at which to save an image file for the selected plot.

To access the **Save As** configuration menu to save an image of a plot to a file:

1. Double-tap anywhere in a Plot view top open the plot configuration menu.
2. Tap the **Save** panel.
3. Tap the **Save Plot Image** button.

### Save As configuration menu (plot Save panel, Save Plot Image button) fields and controls

Field or control	Description
<b>Save Location</b>	<p>Lists the location where the file will be saved. The default value is the last location to which a file was saved.</p> <p>Tap on the file path and use a keyboard to enter a new save location. Or double-tap on the file name to open the virtual keyboard and enter a path.</p> <p>Tap the down arrow icon on the right end of the field to open a list of recent file save locations for the current save type.</p>
<b>Browse</b>	<p>Opens the <a href="#">Browse Save As Location</a> configuration menu to navigate to and select a location at which to save the file.</p>
<b>File name</b>	<p>The file name assigned to the file. The default value is either the user-entered name used to last save this file type, or a numeric value calculated by the instrument if this file type has not previously been saved with a custom file name. The default value is Tek000.</p> <p>Tap the down arrow on the right edge of the field to display and select from a list of recently-saved file names.</p> <p>Tap on the file name and use a keyboard to enter a new file name. Or double-tap on the file name to open the virtual keyboard and enter a file name.</p>
<b>Save As Type</b>	<p>Lists the available graphic formats to which you can save files.</p> <p>Tap the field and select the graphic save format.</p>
<b>Cancel</b>	<p>Cancels the file save action and closes the configuration menu.</p>
<b>OK</b>	<p>Saves the file to the specified location, closes the Save As menu, and displays a confirmation message.</p>

## Save As configuration menu (plot Save panel, Save Plot Data button)

Use this menu to specify the name and location at which to save a comma separated value (csv) file of the data for a specific plot.

To access the Save As configuration menu for plots:

1. Double-tap anywhere in a Plot view top open the plot configuration menu.
2. Tap the **Save** panel.
3. Tap the **Save Plot Data** button.

## Save As configuration menu (plot Save panel, Save Plot Data button) fields and controls

Field or control	Description
<b>Save Location</b>	<p>Lists the location where the file will be saved. The default value is the last location to which a file was saved.</p> <p>Tap on the file path and use a keyboard to enter a new save location. Or double-tap on the file name to open the virtual keyboard and enter a path.</p> <p>Tap the down arrow icon on the right end of the field to open a list of recent file save locations for the current save type.</p>
<b>Browse</b>	Opens the <i>Browse Save As Location</i> configuration menu to navigate to and select a location at which to save the file.
<b>File name</b>	<p>The file name assigned to the file. The default value is either the user-entered name used to last save this file type, or a numeric value calculated by the instrument if this file type has not previously been saved with a custom file name. The default value is Tek000.</p> <p>Tap the down arrow on the right edge of the field to display and select from a list of recently-saved file names.</p> <p>Tap on the file name and use a keyboard to enter a new file name. Or double-tap on the file name to open the virtual keyboard and enter a file name.</p>
<b>Cancel</b>	Cancels the file save action and closes the configuration menu.
<b>OK</b>	Saves the file to the specified location, closes the Save As menu, and displays a confirmation message.

## Reference waveform configuration menu

Use this menu to configure display settings for a reference waveform.

To open a reference waveform configuration menu, double-tap a **Ref** badge on the Settings bar.

### Reference waveform configuration menu fields and controls

Field or control	Description
<b>Display</b>	Turns <b>On</b> or <b>Off</b> displaying the waveform.
<b>Vertical Scale</b>	Set the vertical scale by using the assigned multipurpose knob, a virtual keypad, or tap the up or down arrows.
<b>Label</b>	<p>Adds a label to the waveform. Tap and enter text using a keyboard, or double-tap to open the virtual keyboard. The label text is the same color as the waveform.</p> <p>Once you have entered the label, close the menu and double-tap the label text to open the Text Settings menu to change the font color, size, and other characteristics.</p>
<b>Units</b>	Set the units label that you want to display on the vertical scale.
<b>Position</b>	Set the vertical position of the waveform using the assigned multipurpose knob or the virtual keypad.
<b>Set to 0</b>	Tap to set the vertical position to 0 (vertical center of the graticule).

Table continued...

Field or control	Description
<b>Reference File</b>	Shows the path and file name of the current Reference waveform.  Double-tap the field to open the on-screen keyboard to enter or edit the path to open a different waveform file.  Tap the down arrow icon to list the 20 most recently accessed reference waveform files.
<b>Browse</b>	Opens the Browse Waveform File dialog. Use this dialog to navigate to and select a waveform file to load. See <a href="#">Recall configuration menu (Ref waveform configuration menu)</a> on page 546.
<b>Sample Rate, Record Length</b>	Readout-only text that show the sample rate and record length values of the reference waveform.  These fields are replaced with <b>Center Frequency</b> , <b>Span</b> , and <b>RBW</b> readouts for spectrum reference waveforms.
<b>Deskew</b>	Changes the horizontal position of the reference waveform. Use this function to align the reference waveform to meet your measurement needs.  This field is not displayed for spectrum reference waveforms.
<b>Set to 0</b>	Sets the reference waveform deskew value to zero.  This field is not displayed for spectrum reference waveforms.
<b>Selected Frame</b>	Sets the frame to view of a recalled Fast Frame waveform file. This control is only available if the recalled waveform includes Fast Frame acquisitions.   <b>Note:</b> This control has nothing to do with the selected frame of current acquired data. Adjusting this field does not change the selected frame in acquisition data. Conversely, adjusting the selected frame in the acquisition data does not change the selected frame of the reference waveform.  Navigating through the frames of a reference waveform does not require the Fast Frame feature to be active.  If more than one fast frame reference waveform is active, the Selected Frame in each waveform's configuration menu is independent of the others.

## Recall configuration menu (Ref waveform configuration menu)



Use this menu to locate and load a reference waveform file.

Prerequisite: a Ref badge must be present on the Settings bar. See [Add a math, reference, or bus waveform](#) on page 93.

To open the Recall configuration menu:

1. Double-tap a **Ref** badge on the Settings bar.
2. Tap **Browse** to open the Recall configuration menu.

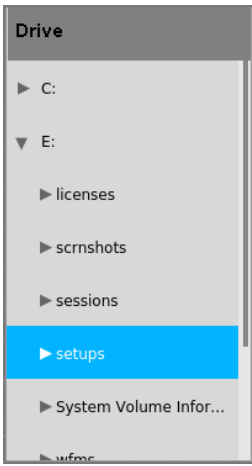
## Recall configuration menu (Ref configuration menu) fields and controls

Field or control	Description
Look in	<p>Shows the current directory path and file name.</p> <p>Tap on the file path and use a keyboard to enter a new path. Or double-tap on the file name to open the virtual keyboard and enter a path.</p> <p>Tap the down arrow icon on the right end of the field to open a list of recently accessed files, up to a maximum of 20.</p>
	<p>The Drive column lists the directory structure, including any network-connected drives. Use to quickly navigate to a location.</p> <p>Tap to list the contents of the directory in the file list area.</p> <p>Double-tap an item, or tap the small arrow to the left of the directory, to display the subdirectories under it. Double-tap again to close that directory structure.</p> <p>If there is a scroll bar, drag the list up and down to show more entries.</p>
	<p>Use the arrow buttons to navigate the directory structure.</p> <p>The left arrow navigates back to the previously visited folder.</p> <p>The Right arrow navigates forward to the previously visited folder.</p> <p>The Up arrow navigates up one level from the current folder.</p>
	<p>Use to create a new directory (folder) at the current location.</p> <p>Opens the new directory after it is created.</p>
File Name	<p>Lists the selected file name.</p> <p>Tap on the file path and use a keyboard to enter a new path. Or double-tap on the file name to open the on-screen keyboard and enter a path.</p> <p>Tap the down arrow icon on the right end of the field to open a list of recently accessed files, up to a maximum of 20.</p>
Files of Type	Use to select the file format you want to open. Tap the field to show a list of all file extension types that the instrument can read for the selected file type. The files column only lists files of the specified type.
Cancel	Cancel any changes, closes the menu, and returns to the prior menu without loading a file.
OK	Closes the dialog, returns to the prior menu, and loads and displays the specified file.

## Search configuration menu

Use the Search configuration menu to define conditions that you want to search for on a channel or waveform signal. Each occurrence of the search condition is marked on the signal with a triangle along the top of the waveform slice or view.

To open the Search menu, double-tap on a **Search** badge in the Results bar.

See the following links for information on the search type menus.

[Bus Search configuration menus](#) on page 347

[Edge Search configuration menu](#) on page 419

[Logic search configuration menu](#) on page 420

[Pulse Width Search configuration menu](#) on page 422

[Rise/Fall Time Search configuration menu](#) on page 424

[Runt Search configuration menu](#) on page 425

[Setup and Hold Search configuration menu](#) on page 426

[Timeout Search configuration menu](#) on page 428

[Window Search configuration menu](#) on page 429

[DDR Read Search configuration menu](#) on page 431

[DDR Write Search configuration menu](#) on page 432

[DDR Read & Write Search configuration menu](#) on page 434

## Spectrum View menus

Use the Spectrum View menus to activate and configure frequency-domain spectrum traces for analog channel time-domain signals.

### Spectrum View window configuration menu

Use the Spectrum View window configuration menu to change waveform intensity, graticule style and intensity, and peak marker settings that apply to all spectrum waveforms in the Spectrum View.

To open the Spectrum View window configuration menu, double-tap anywhere on the **Spectrum View** window other than on a waveform readout, or trace handle.

### View Settings panel, fields and controls

Field or control	Description
<b>Display Mode</b>	Sets the spectrum View window mode to <b>Overlay</b> (all waveforms overlaid on a single graticule) or <b>Stacked</b> (all waveforms in their own row or slice of the Spectrum View window).
<b>Waveform Intensity</b>	Sets the brightness level of all waveforms.

Table continued...



Field or control	Description
<b>Graticule Style</b>	<p>Sets the graticule style to display.</p> <p><b>Grid</b> displays a grid, cross hairs, and frame.</p> <p><b>Time</b> displays a vertical grid of time marks, cross hairs, and a frame.</p> <p><b>Full</b> displays a frame and a grid. This style is useful for making quick, full-screen measurements with cursors and automatic readouts when cross hairs are not needed.</p> <p><b>None</b> displays a frame without a grid and cross hairs.</p> <p>When you display a grid in the <b>Spectrum View</b>, the horizontal zero line is the Reference level, and the vertical zero line is the center frequency.</p>
<b>Graticule Intensity</b>	<p>Sets the brightness of all graticules.</p> <p>Changing the graticule intensity also changes the intensity of vertical and horizontal scales and readouts. Graticule intensity does not change the intensity of callout text on the screen.</p>
<b>X-Axis</b>	Sets the X-Axis scale to Linear (default) or Logarithmic.

### Markers panel, fields and controls

Field or control	Description
<b>Peak Markers</b>	<p>Enables (<b>On</b>) or disables (<b>Off</b>) showing triangular marker icons on the top edge of each spectrum trace for a specified quantity of waveform peaks. Default is <b>On</b>.</p> <p>The highest peak on the currently selected trace is the reference marker, and is marked with a red triangle.</p> <p>Other peaks are shown in the color of the selected spectrum trace.</p>
<b>Quantity</b>	<p>Sets the maximum number of highest peak markers to show for each trace in the Spectrum View window. The default value is 5.</p> <p>When the display mode is <b>Stacked</b>, this control sets the maximum number of peaks that can be marked in each waveform slice.</p> <p>When the display mode is <b>Overlay</b>, this control set the maximum number of peaks that can be marked on the currently selected spectrum waveform trace.</p> <p>If there are fewer peaks in the Spectrum View window than this control is set for, only the displayed peaks will be marked.</p>
<b>Threshold</b>	<p>Sets the minimum amplitude that a signal must exceed to be a valid peak. The default value is -50.0 dBm.</p> <p>The instrument shows a temporary horizontal line on the spectrum traces (like the Trigger Level indicator) when changing this value, to show the peak threshold level in relationship to the spectrum trace.</p>
<b>Excursion</b>	<p>Sets the minimum magnitude (<math> Pk_{MAX}  -  Peak_{MIN} </math>) a peak must exceed to be marked. The default value is 30.0 dB.</p> <p><b>Threshold</b> and <b>Excursion</b> are AND functions; both must be true for a marker to be placed on a peak (including the Reference marker).</p>

Table continued...

Field or control	Description
Readout	<p>Sets the marker readouts to show <b>Absolute</b> or <b>Delta</b> values.</p> <p>The default value is <b>Absolute</b>.</p> <p><b>Absolute</b> readouts show the actual frequency and peak value.</p> <p><b>Delta</b> readouts show the frequency and amplitude values of the markers relative to the Reference Marker values.</p>

### Spectrogram panel, fields and controls

See [Enable the spectrogram](#) on page 143 to display the spectrogram in the spectrum view.

Field or control	Description
Cursor A	<p>Sets a <b>Cursor A</b> to display spectrum associated with waveform view cursor. Default is unchecked.</p> <p>When checked, it displays the spectrum associated with waveform view cursor position A.</p>
Cursor B	<p>Sets a <b>Cursor B</b> to display spectrum associated with waveform view cursor. Default is unchecked.</p> <p>When checked, it displays the spectrum associated with waveform view cursor position B.</p>
<b>Spectrogram Color Scale</b>	
Maximum	<p>Sets a maximum spectrogram color scale. The default value is 0.0 dBm. The range is from -169 dBm to +100 dBm.</p>
Minimum	<p>Sets a minimum spectrogram color scale. The default value is -100.0 dBm. The range is from -170 dBm to +99 dBm.</p>

### Spectrogram guidelines

- Spectrogram is saved or recalled as part of setup and session files.
- Spectrogram data can be saved as .csv or .mat files through the Save Waveform menu. These files cannot be recalled in the oscilloscope application.
- If the spectrum's are overlapped to draw the spectrogram, the overlap % can be seen in the upper right corner of the spectrogram.
- **Zooming on spectrogram**
  - When zoom is turned on in the waveform view, the spectrogram is redrawn for the portion contained in the zoomed view.
  - Each time the zoom horizontal parameters (scale and position) are adjusted, the spectrogram is recalculated and redrawn.

- **Cursors on spectrogram**

When cursors are on in the Waveform View, their location is highlighted in the corresponding Spectrogram with multipurpose knobs **A** and **B** bubbles. The arrows that each point to the specific Spectrogram Slice whose center point of Spectrum Time is closest to the cursor's position in the Waveform View.

## Selected Trace configuration menu (Spectrum View)

Use this menu to display any combination of normal, average, minimum, and maximum spectrum trace data to show.

To open the **Spectrum View Selected** Trace configuration menu, double-tap the spectrum trace handle.

### Selected Trace menu, fields and controls

Field or control	Description
<b>Normal</b>	Sets the spectrum trace of the selected channel to show the first sample point data in each sample interval.
<b>Max Hold</b>	Sets the spectrum trace of the selected channel to show the highest amplitude points in each sample interval over several acquisitions.
<b>Min Hold</b>	Sets the spectrum trace of the selected channel to show the lowest amplitude points in each sample interval over several acquisitions.  Sets the trace mode to show all available sample point data in the spectrum trace.
<b>Average</b>	Sets the spectrum trace of the selected channel to show the average of the normal points in each sample interval over several acquisitions.  The number of averages is set in the Spectrum View panel of the Channel configuration menu. See <a href="#">Spectrum View panel (Channel configuration menu)</a> on page 442.

## Spectrum View Cursors menu

Use the Spectrum View cursors to take manual measurements on spectrum signals.

To open the **Spectrum View Cursors** menu, double-tap on a cursor or its readout in the **Spectrum View** window.

### Cursors menu (Spectrum View), fields and controls

Field or control	Description
<b>Display</b>	Tap to toggle the spectrum cursor display <b>On</b> or <b>Off</b> .
<b>Source Waveform</b>	Sets the cursor trace mode (the trace(s) on which to display the cursors).  <b>Same</b> places both cursors on the same trace.  <b>Split</b> allows each cursor to be on a different trace.
<b>Source</b>	Moves the spectrum trace cursors and readouts to the selected source (default) or a specific selected from the list.  <b>Selected Waveform</b> lets you tap the screen or use a mouse to quickly move the cursors to a selected trace ( <b>Overlay</b> mode) or slice ( <b>Stacked</b> mode).  Available only when <b>Source Waveform = Same</b> .
<b>Cursor A Source, Cursor B Source</b>	Sets the waveform sources for Cursor A and B when in split cursor mode. Available only when <b>Source Waveform = Split</b> .
<b>Cursor A X-Position</b>	Sets a specific x-axis (frequency) position for Cursor A using the multipurpose knob or the virtual keypad.
<b>Cursor B X-Position</b>	Sets a specific x-axis (frequency) position for Cursor B using the multipurpose knob or the virtual keypad.

Table continued...

Field or control	Description
Readout	Sets the cursor readouts to show <b>Absolute</b> or <b>Delta</b> values. The default value is <b>Absolute</b> .  <b>Delta</b> readouts are relative to the Reference Marker.

### Spectrum cursors guidelines

- **Spectrum View** only supports waveform cursors.
- Cursor readouts only appear in the selected spectrum slice. The cursor bar extends through all slices (similar to waveform cursors in **Stacked Waveform View** slices).
- Cursors maintain their screen position if you change the center frequency or span.
- Cursor measurements are taken on the currently selected trace (**Normal**, **Average**, **Max Hold** or **Min Hold**) which is indicated by the MANm trace handle. See [Spectrum trace handle and trace types](#) on page 149.
- Cursor A becomes the Reference marker. The cursor A readout shows Frequency, Amplitude and Noise Density values. The automatic peak markers still show the same number of peaks as before, but they use the cursor A reference marker for delta measurements.
- The cursor B readout depends on the Absolute/Delta mode:
  - When cursor readouts are set to **Absolute** mode, the cursor B readout shows Frequency, Amplitude, and Noise Density values.
  - When cursor readouts are set to **Delta** mode, the cursor B readout shows the delta Frequency from cursor A, the delta Amplitude from cursor A, and the Phase Noise of cursor B relative to cursor A (dBc/Hz).
  - Split cursors readouts only display frequency readouts when the cursor sources are using different vertical units.

### Magnitude Vs. Time badge menu

Use this menu to set the vertical scale, label, trace offset position, and the vertical scale format of the Spectrum View Magnitude Vs. Time trace.

To open the **Magnitude Vs. Time** badge menu, double-tap the badge.

#### Magnitude Vs. Time menu fields and controls

Field or control	Description
Display	Tap to toggle the trace display <b>On</b> or <b>Off</b> . Each Magnitude Vs. Time trace is drawn in its own slice (stacked mode).
Vertical Scale	Sets the vertical scale. Use the multipurpose knob, double-tap to bring up the virtual keypad, or tap the up and down arrows to change the scale.
Label	Adds a label to the channel display using the virtual keypad. Drag the label to move it.
Position	Sets the vertical position of the trace. Use the multipurpose knob, or double-tap to bring up the virtual keypad, to change the trace position.
Set to 0	Sets the channel signal vertical offset to 0 units (centers the 0 unit level vertically in the trace).
Format	Sets the vertical scale mode to <b>Amplitude (Vrms)</b> , <b>Power (linear)</b> , or <b>Power (log)</b> .

### Frequency Vs. Time badge menu

Use this menu to set the vertical scale, label, and the trace offset position of the Spectrum View Frequency vs Time trace.

To open the **Frequency Vs. Time** badge menu, double-tap the badge.

## Frequency Vs. Time menu fields and controls

Field or control	Description
<b>Display</b>	Tap to toggle the trace display <b>On</b> or <b>Off</b> . Each Frequency Vs. Time trace is drawn in its own slice (stacked mode).
<b>Vertical Scale</b>	Sets the vertical scale. Use the multipurpose knob, double-tap to bring up the virtual keypad, or tap the up and down arrows to change the scale.
<b>Label</b>	Adds a label to the trace. Double-tap the field to use the virtual keyboard. Drag the label to move it.
<b>Position</b>	Sets the vertical position of the trace. Use the multipurpose knob, or double-tap to bring up the virtual keypad, to change the trace position.

## Phase Vs. Time badge menu

Use this menu to set the vertical scale, label, trace offset position, and the vertical scale format of the Spectrum View Phase Vs. Time trace.

To open the **Phase Vs. Time** badge menu, double-tap the badge.

## Phase Vs. Time menu fields and controls

Field or control	Description
<b>Vertical Settings</b> panel	
<b>Display</b>	Tap to toggle the trace display <b>On</b> or <b>Off</b> . Each Phase Vs. Time trace is drawn in its own slice (stacked mode).
<b>Vertical Scale</b>	Sets the vertical scale. Use the multipurpose knob, double-tap to bring up the virtual keypad, or tap the up and down arrows to change the scale.
<b>Label</b>	Adds a label to the trace. Double-tap the field to use the virtual keyboard. Drag the label to move it.
<b>Position</b>	Sets the vertical position of the trace. Use the multipurpose knob, or double-tap to bring up the virtual keypad, to change the trace position.
<b>Phase Wrap</b>	<p>Enables the <b>Phase Wrap</b> mode and opens a field in which to set the Phase Wrap value in degrees (default value is 180°).</p> <p>Phase Wrap <b>On</b> constrains the phase values in the <b>Phase vs. Time</b> waveform to be within <math>\pm</math> the specified limit. Calculated phase values that are below (or above) the limit are <i>wrapped</i> by repeatedly adding (or subtracting) 360° until they are within range. This can create a discontinuity in the output waveform but all the phase values will be in the default display position and scaling range.</p> <p>Phase Wrap <b>Off</b> would be for applications where the discontinuity is undesirable.</p>
<b>Phase Reference</b> panel	
<b>Master Reference</b>	Sets the channel used for this trace as a master phase reference for all other Phase Vs. Time traces. This function is only available when all source spectrum channels use the same center frequency.
<b>Set Phase Reference Using</b>	<p>Sets the phase reference point to either the <b>Trigger Point</b> or the <b>Cursor A</b> position.</p> <p>When <b>Set Phase Reference Using</b> is set to <b>Trigger Point</b>, the reference source is based on the phase at the trigger point.</p> <p>When <b>Set Phase Reference Using</b> is set to <b>Cursor A</b>, use Cursor A to set the <b>Phase Reference</b> field value. This is intended for the user who can use a cursor to visually identify a phase reference in the waveform and set the reference relative to the cursor position.</p>

Table continued...

Field or control	Description
<b>Phase Reference</b>	<p>Sets or shows the reference phase angle to use to draw the Phase Vs. Time trace.</p> <p>When <b>Set Phase Reference Using</b> is set to <b>Trigger Point</b>, this field shows the phase angle at the signal trigger point.</p> <p>When <b>Set Phase Reference Using</b> is set to <b>Cursor A</b>, use Cursor A to set the <b>Phase Reference</b> field value, or directly enter a phase value in the field.</p>
<b>Set Now</b>	<p>Sets the <b>Phase Reference</b> to the specified value. You must tap this button to enter and set the phase value to update the trace with this setting.</p> <p>This control is only present when <b>Set Phase Reference Using</b> is set to <b>Cursor A</b>.</p>

## Spectrum badge menu

Use the Spectrum badge menu to set spectrum parameters including source, center frequency, span, RBW, FFT window type, and spectrum time.

To open the Spectrum badge menu, double-tap the badge.

### Spectrum badge menu, fields and controls



Field or control	Description
<b>Lock Center Frequency Across All Channels</b>	<p>Enables or disables locking all spectrum center frequencies to the currently selected channel's center frequency. The default value is enabled (selected).</p> <p>When selected, sets all spectrum traces to use the same center frequency as set in the <b>Center Frequency</b> field.</p> <p>When not selected, each spectrum trace can be set to a different center frequency.</p>
<b>Source</b>	<p>Sets the channel source to use for settings in the menu. Select a source from the drop-down list.</p> <p> <b>Note:</b> The Source field value is the last source channel set in the menu. The Source field does not update to reflect the active Spectrum trace channel when the menu is opened.</p> <p>Only available when <b>Lock Center Frequency Across All Channels</b> is disabled (not selected).</p>
<b>Center Frequency</b>	<p>Sets or shows the center frequency value of the selected trace.</p> <p>If <b>Lock Center Frequency Across All Channels</b> is unchecked, then this field updates as different channels are selected in the <b>Source</b> field.</p> <p>If <b>Lock Center Frequency Across All Channels</b> is checked, then this field sets all spectrum traces to use the frequency shown in the field.</p> <p>Use the field to enter a specific center frequency value for the current source or all channels, depending on the setting of the <b>Lock Center Frequency Across All Channels</b> control.</p>

Table continued...

Field or control	Description
<b>Span</b>	<p>Sets the range of frequencies to display, centered on the center frequency value. Use the arrow controls to increment or decrement the span value in a 1-2-5 sequence, or double-tap the field to enter a value.</p> <p> <b>Note:</b> The <b>Span</b> setting applies to all spectrum traces. Making a span change for one source changes the span for all signal sources.</p>
<b>Window</b>	<p>Sets the FFT window to apply to the signal. Windows are mathematical filters applied to provide more accurate frequency or magnitude traces. Each window offers a trade-off between frequency resolution and magnitude accuracy.</p> <p>The choice of which window to use depends upon what you want to measure and your source's signal characteristics. See <a href="#">FFT windows</a> on page 527 for more FFT window information.</p> <p> <b>Note:</b> The <b>Window</b> setting applies to all spectrum traces. Changing the FFT for one source changes the FFT for all signal sources.</p>
<b>RBW Mode</b>	<p>Sets either <b>Auto</b> or <b>Manual</b> resolution bandwidth mode.</p> <p><b>Auto</b> sets the resolution bandwidth to change automatically as you change the span. The default behavior is <math>RBW = \text{Span}/1000</math>.</p> <p><b>Manual</b> lets you enter a specific resolution bandwidth.</p>
<b>Span:(RBW)</b>	<p>Sets the resolution bandwidth as a ratio of the span. Use the arrow controls to increment or decrement the span ratio in a 1-2-5 sequence, or double-tap the field to enter a value.</p> <p>Only available when <b>RBW Mode</b> is set to <b>Auto</b>.</p>
<b>RBW</b>	<p>Sets a specific resolution bandwidth value. Use the arrow controls to increment or decrement the RBW in a 1-2-5 sequence, or double-tap the field to enter a value.</p> <p>Only available when <b>RBW Mode</b> is set to <b>Manual</b>.</p>
<b>Lock Spectrum Time Across All Channels</b>	<p>Enables or disables locking all spectrum times to the currently selected channel's spectrum time location, shown as a percent of the record length. The default value is enabled (selected).</p> <p>When enabled, this function sets all spectrum traces to use the spectrum time as set in the <b>Spectrum Time</b> field.</p> <p>When not selected, each spectrum trace can be set to a different spectrum time. See <a href="#">Spectrum View and Spectrum Time</a> on page 145.</p>
<b>Source</b> (Lock Spectrum Time)	<p>Sets the source to use for the spectrum time value. Select a source from the drop-down list.</p> <p>Only available when <b>Lock Spectrum Time Across All Channels</b> is enabled (selected).</p>
<b>Spectrum Time</b>	<p>Sets the channel's spectrum time location, shown as a percent of the record length. Double-tap the field to enter a value.</p> <p>If <b>Lock Spectrum Time Across All Channels</b> is unchecked, then this field updates as different channels are selected in the upper-menu <b>Source</b> field.</p> <p>If <b>Lock Spectrum Time Across All Channels</b> is checked, then this field sets all spectrum traces to use the spectrum time shown in the upper-menu <b>Source</b> field.</p>

## Trigger configuration menu overview

Use the Trigger menu to define the channel or waveform signal conditions on which to trigger the oscilloscope. The trigger event establishes the time-reference point in the waveform record. All waveform record data is located in time with respect to the trigger point.

To quickly change the trigger source from one channel to another when using a single source trigger type, single-tap on the **Trigger** badge. Select the new trigger source from the list. If you select a Digital channel, the list expands to show the individual digital channels. Single source trigger types include **Edge**, **Pulse Width**, **Timeout**, **Runt**, **Window** and **Rise/Fall Time**. When the trigger type is **Edge**, **Pulse Width** or **Timeout**, selecting a new source also initiates a **Set to 50%** operation on the new source.

To access the Trigger configuration menu, double-tap the **Trigger** badge on the Settings bar. The Trigger menu opens to show the settings for the current trigger type.

Use the following links to see more information on specific trigger types and their configuration menus.

- [Bus Trigger Menu](#)
- [Video Trigger configuration menu](#) on page 558
- [Edge Trigger menu](#)
- [Logic Trigger](#)
- [Pulse Width Trigger menu](#)
- [Rise/Fall Time Trigger menu](#)
- [Runt Trigger menu](#)
- [Sequence Trigger menu](#)
- [Setup & Hold Trigger menu](#)
- [Timeout Trigger menu](#)
- [Window Trigger menu](#)

## Edge Trigger configuration menu

Use the edge **Trigger** menu to trigger the instrument when a signal rises and/or falls through a specified level.

To open the Edge trigger menu:

1. Double-tap the **Trigger** badge on the Settings bar.
2. Set the **Trigger Type** to **Edge**.

### Settings panel (Edge Trigger configuration menu) fields and controls

Field or control	Description
Trigger Type	Set to <b>Edge</b> .
Table continued...	



Field or control	Description
<b>Source</b>	<p>Lists the source channel or waveform to use to trigger or search. Types that require multiple inputs will replace this control with a different source definition control.</p> <p><b>AC Line source (Edge trigger):</b> The instrument uses the AC line to generate a trigger based on the power line frequency. The trigger level is fixed at zero volts. This source is often used to look at signals related to the power line frequency (for example, signals from devices such as lighting equipment and power supplies). Because the instrument generates the trigger from the power line, you do not have to use a channel input.</p> <p>Lists the source channel.</p> <p><b>AUX In:</b> The MSO58LP and 6 Series MSO also have an <b>AUX In</b> (auxiliary) edge trigger source. <b>AUX In</b> provides an extra trigger signal source when you need to use the input channels for other signals. For example, you might want to trigger on a clock while displaying related logic signals. The <b>AUX In</b> input connector is not compatible with most probes, and you cannot display the auxiliary trigger signal in the Waveform view.</p>
<b>Coupling</b>	<p>Set the conditioning to apply to the source signal trigger circuit from the source signal.</p> <p><b>DC</b> coupling passes all input signals directly to the trigger circuitry.</p> <p><b>HF Reject</b> coupling attenuates signals above 50 kHz before passing the signal to the trigger circuitry.</p> <p><b>LF Reject</b> coupling attenuates signals below 50 kHz before passing the signal to the trigger circuitry.</p> <p><b>Noise Reject</b> coupling provides stable triggering by increasing the trigger hysteresis. Increased hysteresis reduces the trigger sensitivity to noise so may require greater signal amplitude.</p>
<b>Level</b>	Sets the amplitude level that the signal must pass through to be considered a valid transition.
<b>Set to 50%</b>	Sets the threshold at 50% of the measured signal transition range. 50% is calculated as (Top + Bottom)/2.
<b>Slope</b>	Sets the signal transition direction to detect. (rising, falling, or either direction).

### Mode & Holdoff panel (Edge Trigger configuration menu) fields and controls

Field or control	Description
<b>Trigger Mode</b>	<p>The trigger mode determines how the instrument behaves in the absence or presence of a trigger event:</p> <p><b>Auto</b> trigger mode enables the instrument to acquire and display a waveform even if a trigger does not occur. Auto mode uses a timer that starts when the acquisition is started, and the pretrigger information is obtained. If a trigger event is not detected before the timer times out, the instrument forces a trigger. The length of time it waits for a trigger event depends on the time base setting.</p> <p>When forcing triggers in the absence of valid triggering events, Auto mode does not synchronize the waveform on the display. The waveform will appear to jump across the screen.</p> <p>If valid triggers occur, the display will become stable.</p> <p><b>Normal</b> trigger mode enables the instrument to acquire a waveform only when it is triggered. If no trigger occurs, the last waveform record acquired remains on the display. If no last waveform exists, no waveform is displayed.</p>
<b>Force Trigger</b>	Forces a trigger event regardless of whether the waveform meets any trigger conditions.

Table continued...

Field or control	Description
<b>Holdoff</b>	<p>Trigger holdoff sets the amount of time the oscilloscope waits after a trigger event before detecting and triggering on the next trigger event.</p> <p><b>Random</b> sets the instrument to wait for a random amount of time before recognizing another trigger event. This means that successive acquisitions are unrelated to the previous trigger signal.</p> <p><b>Time</b> sets the instrument to wait the specified time before recognizing another trigger event. Use this option when the signal that you want to trigger on has several possible trigger points or is a burst signal.</p>
<b>Holdoff Time</b>	Tap the <b>Holdoff Time</b> field and use the multipurpose knob to adjust the holdoff time value. Or double-tap the field and use the virtual keypad to enter a time holdoff period.
<b>Act on Trigger</b>	<p>Tap the <b>Act on Trigger</b> button to configure the actions the instrument must take when a trigger event occurs.</p> <p>See <a href="#">Act On Event configuration menu</a> on page 178 for the available fields and controls.</p>
<b>Trigger Frequency Counter</b>	<p>Turn <b>On</b> to display the trigger event frequency in the <b>Trigger</b> badge.</p> <p>The trigger frequency can help you troubleshoot signal problems where the frequency of the trigger event may be related to a clock, switching power supply, or other recurrent frequency that occurs on your DUT.</p> <p>Only available if you have installed the DVM option, which is available when you register your instrument with Tektronix.</p>

### Other trigger types

- [Bus Trigger Menu](#)
- [Logic Trigger menu](#)
- [Pulse Width Trigger menu](#)
- [Rise Fall Time Trigger menu](#)
- [Runt Trigger menu](#)
- [Sequence Trigger menu](#)
- [Setup and Hold Trigger menu](#)
- [Timeout Trigger menu](#)
- [Window Trigger menu](#)

### Video Trigger configuration menu

Use the Video Trigger menu to trigger on specified fields or lines of a composite video signal, such as NTSC, PAL, or SECAM.

To open the Video trigger menu:

1. Double-tap the **Trigger** badge on the Settings bar.
2. Set the **Trigger Type** to **Video**.

### Settings panel (Video Trigger configuration menu) fields and controls

Field or control	Description
<b>Trigger Type</b>	Set to <b>Video</b> .

Table continued...

Field or control	Description
<b>Source</b>	Lists the source channel or waveform to use to trigger or search. Video trigger only operates on a single source.
<b>Standard</b>	Select the video format apply to source signal. Available formats are: <ul style="list-style-type: none"> <li>• 525i/NTSC</li> <li>• 625i/PAL</li> <li>• SECAM</li> </ul>
<b>Trigger On</b>	Select the type of information on which to trigger. Available trigger on types: <ul style="list-style-type: none"> <li>• All Lines</li> <li>• Line Number</li> <li>• Odd Fields</li> <li>• Even Fields</li> <li>• All Fields</li> </ul>
<b>Line Number</b>	Enter the line number. Available when <b>Trigger On = Line Number</b>
<b>Line Number Information box</b>	Displays the odd or even number. Available when <b>Line Number = Interlaced</b> .
<b>Polarity</b>	Sets the polarity of the video. Allows you to toggle between Normal or Inverted.

**Other requirements:**

- For all the displayed waveforms, a special vertical scale setting of 114 mV/div is inserted into both the coarse and fine vertical 1-2-5 sequence.
- When a waveform is set to the special vertical scale, the graticule shown for that waveform is IRE for NTSC and mV for all other video types.
- If one or more waveforms are overlaid, the correct graticule is used for the waveform which is 'on top' within the slice/view. For example:
  - Channel 1 is the trigger source, is set to NTSC and its vertical scale is set to 114 mV/div.
  - Channel 2 is set to 2 V/div.
  - User overlays channel 1 and 2 (either in a slice or in overlay display mode).
  - When channel 1 is selected (on top), the IRE graticule is displayed.
  - When channel 2 is selected (on top), the regular graticule is displayed.

## Mode & Holdoff panel (Edge Trigger configuration menu) fields and controls

Field or control	Description
<b>Trigger Mode</b>	<p>The trigger mode determines how the instrument behaves in the absence or presence of a trigger event:</p> <p><b>Auto</b> trigger mode enables the instrument to acquire and display a waveform even if a trigger does not occur. Auto mode uses a timer that starts when the acquisition is started, and the pretrigger information is obtained. If a trigger event is not detected before the timer times out, the instrument forces a trigger. The length of time it waits for a trigger event depends on the time base setting.</p> <p>When forcing triggers in the absence of valid triggering events, Auto mode does not synchronize the waveform on the display. The waveform will appear to jump across the screen.</p> <p>If valid triggers occur, the display will become stable.</p> <p><b>Normal</b> trigger mode enables the instrument to acquire a waveform only when it is triggered. If no trigger occurs, the last waveform record acquired remains on the display. If no last waveform exists, no waveform is displayed.</p>
<b>Force Trigger</b>	Forces a trigger event regardless of whether the waveform meets any trigger conditions.
<b>Holdoff</b>	<p>Trigger holdoff sets the amount of time the oscilloscope waits after a trigger event before detecting and triggering on the next trigger event.</p> <p><b>Random</b> sets the instrument to wait for a random amount of time before recognizing another trigger event. This means that successive acquisitions are unrelated to the previous trigger signal.</p> <p><b>Time</b> sets the instrument to wait the specified time before recognizing another trigger event. Use this option when the signal that you want to trigger on has several possible trigger points or is a burst signal.</p>
<b>Holdoff Time</b>	Tap the <b>Holdoff Time</b> field and use the multipurpose knob to adjust the holdoff time value. Or double-tap the field and use the virtual keypad to enter a time holdoff period.
<b>Act on Trigger</b>	<p>Tap the <b>Act on Trigger</b> button to configure the actions the instrument must take when a trigger event occurs.</p> <p>See <a href="#">Act On Event configuration menu</a> on page 178 for the available fields and controls.</p>
<b>Trigger Frequency Counter</b>	<p>Turn <b>On</b> to display the trigger event frequency in the <b>Trigger</b> badge.</p> <p>The trigger frequency can help you troubleshoot signal problems where the frequency of the trigger event may be related to a clock, switching power supply, or other recurrent frequency that occurs on your DUT.</p> <p>Only available if you have installed the DVM option, which is available when you register your instrument with Tektronix.</p>

### Other trigger types

- [Bus Trigger Menu](#)
- [Logic Trigger menu](#)
- [Pulse Width Trigger menu](#)
- [Rise Fall Time Trigger menu](#)
- [Runt Trigger menu](#)
- [Sequence Trigger menu](#)
- [Setup and Hold Trigger menu](#)

- [Timeout Trigger menu](#)
- [Window Trigger menu](#)

## Bus Trigger configuration

Use the Bus trigger menus to trigger on bus-related events (Start, Stop, Missing Ack, Address, Data, and so on).



**Note:** You must add a bus to the Waveform view before you can trigger on it. [Add a math, reference, or bus waveform](#) on page 93.

To open the Bus trigger menu:

1. Double-tap the **Trigger** badge on the Settings bar.
2. Set the **Trigger Type** to **Bus**.
3. Select the bus on which to trigger in the **Source** field.

Use the following links to access trigger setting information for specific serial buses.

[ARINC 429 serial bus trigger settings panel](#) on page 562

[Audio serial bus trigger settings panel](#) on page 564

[CAN serial bus trigger settings panel](#) on page 565

[Ethernet serial bus trigger settings panel](#) on page 567

[FlexRay serial bus trigger settings panel](#) on page 570

[I2C serial bus trigger settings panel](#) on page 572

[I3C serial bus trigger settings panel](#) on page 574

[LIN serial bus trigger settings panel](#) on page 578

[MIL-STD-1553 serial bus trigger settings panel](#) on page 580

[Parallel serial bus trigger settings panel](#) on page 582

[RS-232 serial bus trigger settings panel](#) on page 584

[SENT serial bus trigger settings panel](#) on page 585

[SPI serial bus trigger settings panel](#) on page 588

[SPMI serial bus trigger settings panel](#) on page 589

[SVID serial bus trigger settings panel](#) on page 591

[USB serial bus trigger settings panel](#) on page 593

## Other trigger types

- [Edge Trigger menu](#)
- [Logic Trigger](#)
- [Pulse Width Trigger menu](#)
- [Rise/Fall Time Trigger menu](#)
- [Runt Trigger menu](#)
- [Sequence Trigger menu](#)
- [Setup & Hold Trigger menu](#)
- [Timeout Trigger menu](#)

- [Window Trigger menu](#)

### ARINC 429 serial bus trigger settings panel

Field or control	Description
<b>Source</b>	Select the <b>ARINC429</b> bus on which you want to trigger.
<b>Trigger On</b>	Select the type of information on which to trigger.
<b>Trigger When Label</b>	Trigger when the label data meets the specified condition Available when <b>Trigger On = Label</b> .
<b>Label</b>	Sets the label pattern on which to trigger. Tap the <b>Binary</b> , <b>Hex</b> , or <b>Octal</b> field and use the <b>A</b> and <b>B</b> knobs to select and change the values. Or double-tap on the field and use the virtual keypad to enter values. Available when <b>Trigger On = Label</b> or <b>Label &amp; Data</b> .
<b>Label Low</b>	Sets the low value of the label pattern range on which to trigger. Tap the <b>Binary</b> , <b>Hex</b> , or <b>Octal</b> field and use the <b>A</b> and <b>B</b> knobs to select and change the values. Or double-tap on the field and use the virtual keypad to enter values. Available when <b>Trigger On = Label</b> and <b>Trigger When Label = Inside Range</b> or <b>Outside Range</b> .
<b>Label High</b>	Sets the high value of the label pattern range on which to trigger. Tap the <b>Binary</b> , <b>Hex</b> , or <b>Octal</b> field and use the <b>A</b> and <b>B</b> knobs to select and change the values. Or double-tap on the field and use the virtual keypad to enter values. Available when <b>Trigger On = Label</b> and <b>Trigger When Label = Inside Range</b> or <b>Outside Range</b> .
<b>Data</b>	Sets to trigger when the specified data bits condition occurs. Tap the <b>Binary</b> or <b>Hex</b> field and use the <b>A</b> and <b>B</b> knobs to select and change the values. Or double-tap on the field and use the virtual keypad to enter values. Available when <b>Trigger On = Data</b> or <b>Label &amp; Data</b> .
<b>Data Low</b>	Sets the low value of the data pattern range on which to trigger. Tap the <b>Binary</b> , <b>Hex</b> , or <b>Octal</b> field and use the <b>A</b> and <b>B</b> knobs to select and change the values. Or double-tap on the field and use the virtual keypad to enter values. Available when <b>Trigger On = Data</b> and <b>Trigger When Data = Inside Range</b> or <b>Outside Range</b> .
<b>Data High</b>	Sets the high value of the data pattern range on which to trigger. Tap the <b>Binary</b> , <b>Hex</b> , or <b>Octal</b> field and use the <b>A</b> and <b>B</b> knobs to select and change the values. Or double-tap on the field and use the virtual keypad to enter values. Available when <b>Trigger On = Data</b> and <b>Trigger When Data = Inside Range</b> or <b>Outside Range</b> .
<b>SSM</b>	Sets to trigger when the specified Sign/Status Matrix (SSM) bit condition occurs. Tap the <b>Binary</b> or <b>Hex</b> field and use the <b>A</b> and <b>B</b> knobs to select and change the values. Or double-tap on the field and use the virtual keypad to enter values. Available when <b>Trigger On = Data</b> .

Table continued...

Field or control	Description
<b>SDI</b>	<p>Sets to trigger when the specified Source/Destination Identifier (SDI) bit condition occurs.</p> <p>Tap the <b>Binary</b> or <b>Hex</b> field and use the <b>A</b> and <b>B</b> knobs to select and change the values. Or double-tap on the field and use the virtual keypad to enter values.</p> <p>Available when <b>Trigger On = Data</b>.</p>
<b>Error Type</b>	<p>Sets the error condition on which to trigger.</p> <p>Available when <b>Trigger On = Error</b>.</p>
<b>A, B knob controls</b>	<p>Use the <b>A</b> knob to select (highlight) the digit(s) to change in data or bit fields.</p> <p>Use the <b>B</b> knob to change the value of the digit(s) in the selected field.</p>

### Mode & Holdoff panel (Bus Trigger configuration panel) fields and controls

Field or control	Description
<b>Trigger Mode</b>	<p>The trigger mode determines how the instrument behaves in the absence or presence of a trigger event:</p> <p><b>Auto</b> trigger mode enables the instrument to acquire and display a waveform even if a trigger does not occur. Auto mode uses a timer that starts when the acquisition is started, and the pretrigger information is obtained. If a trigger event is not detected before the timer times out, the instrument forces a trigger. The length of time it waits for a trigger event depends on the time base setting.</p> <p>When forcing triggers in the absence of valid triggering events, Auto mode does not synchronize the waveform on the display. The waveform will appear to jump across the screen.</p> <p>If valid triggers occur, the display will become stable.</p> <p><b>Normal</b> trigger mode enables the instrument to acquire a waveform only when it is triggered. If no trigger occurs, the last waveform record acquired remains on the display. If no last waveform exists, no waveform is displayed.</p>
<b>Force Trigger</b>	<p>Forces a trigger event regardless of whether the waveform meets any trigger conditions.</p>
<b>Holdoff</b>	<p>Trigger holdoff sets the amount of time the oscilloscope waits after a trigger event before detecting and triggering on the next trigger event.</p> <p><b>Random</b> sets the instrument to wait for a random amount of time before recognizing another trigger event. This means that successive acquisitions are unrelated to the previous trigger signal.</p> <p><b>Time</b> sets the instrument to wait the specified time before recognizing another trigger event. Use this option when the signal that you want to trigger on has several possible trigger points or is a burst signal.</p>
<b>Holdoff Time</b>	<p>Tap the <b>Holdoff Time</b> field and use the multipurpose knob to adjust the holdoff time value. Or double-tap the field and use the virtual keypad to enter a time holdoff period.</p>
<b>Act on Trigger</b>	<p>Tap the <b>Act on Trigger</b> button to configure the actions the instrument must take when a trigger event occurs.</p> <p>See <a href="#">Act On Event configuration menu</a> on page 178 for the available fields and controls.</p>

Table continued...

Field or control	Description
<b>Trigger Frequency Counter</b>	<p>Turn <b>On</b> to display the trigger event frequency in the <b>Trigger</b> badge.</p> <p>The trigger frequency can help you troubleshoot signal problems where the frequency of the trigger event may be related to a clock, switching power supply, or other recurrent frequency that occurs on your DUT.</p> <p>Only available if you have installed the DVM option, which is available when you register your instrument with Tektronix.</p>

### Audio serial bus trigger settings panel

Field or control	Description
<b>Source</b>	Select the <b>Audio</b> bus on which to trigger.
<b>Trigger On</b>	Select the type of information on which to trigger.
<b>Data</b>	<p>Sets the data pattern on which to trigger. Use in conjunction with the <b>Trigger When</b> field to specify the exact trigger condition.</p> <p>Tap the <b>Binary</b>, <b>Hex</b>, or <b>Decimal</b> field and use the <b>A</b> and <b>B</b> knobs to select and change the values. Or double-tap on the field and use the virtual keypad to enter values.</p> <p>Available when <b>Trigger On = Data</b>.</p>
<b>Word</b>	<p>Sets the audio word channel on which to trigger (<b>Either</b>, <b>Left</b>, <b>Right</b>).</p> <p>Available when <b>Trigger On = Data</b>.</p>
<b>Trigger When</b>	<p>Sets the trigger when condition for the specified data pattern.</p> <p>When set to <b>Inside Range</b> or <b>Outside Range</b>, fields are displayed to set a high and low boundary pattern for the specified trigger type.</p> <p>Tap the <b>Binary</b>, <b>Hex</b>, or <b>Decimal</b> field and use the <b>A</b> and <b>B</b> knobs to select and change the values. Or double-tap on the field and use the virtual keypad to enter values.</p> <p>Available when <b>Trigger On = Data</b>.</p>
<b>A, B knob controls</b>	<p>Use the <b>A</b> knob to select (highlight) the digit(s) to change.</p> <p>Use the <b>B</b> knob to change the value of the digit(s).</p>



## Mode & Holdoff panel (Bus Trigger configuration panel) fields and controls

Field or control	Description
<b>Trigger Mode</b>	<p>The trigger mode determines how the instrument behaves in the absence or presence of a trigger event:</p> <p><b>Auto</b> trigger mode enables the instrument to acquire and display a waveform even if a trigger does not occur. Auto mode uses a timer that starts when the acquisition is started, and the pretrigger information is obtained. If a trigger event is not detected before the timer times out, the instrument forces a trigger. The length of time it waits for a trigger event depends on the time base setting.</p> <p>When forcing triggers in the absence of valid triggering events, Auto mode does not synchronize the waveform on the display. The waveform will appear to jump across the screen.</p> <p>If valid triggers occur, the display will become stable.</p> <p><b>Normal</b> trigger mode enables the instrument to acquire a waveform only when it is triggered. If no trigger occurs, the last waveform record acquired remains on the display. If no last waveform exists, no waveform is displayed.</p>
<b>Force Trigger</b>	Forces a trigger event regardless of whether the waveform meets any trigger conditions.
<b>Holdoff</b>	<p>Trigger holdoff sets the amount of time the oscilloscope waits after a trigger event before detecting and triggering on the next trigger event.</p> <p><b>Random</b> sets the instrument to wait for a random amount of time before recognizing another trigger event. This means that successive acquisitions are unrelated to the previous trigger signal.</p> <p><b>Time</b> sets the instrument to wait the specified time before recognizing another trigger event. Use this option when the signal that you want to trigger on has several possible trigger points or is a burst signal.</p>
<b>Holdoff Time</b>	Tap the <b>Holdoff Time</b> field and use the multipurpose knob to adjust the holdoff time value. Or double-tap the field and use the virtual keypad to enter a time holdoff period.
<b>Act on Trigger</b>	<p>Tap the <b>Act on Trigger</b> button to configure the actions the instrument must take when a trigger event occurs.</p> <p>See <a href="#">Act On Event configuration menu</a> on page 178 for the available fields and controls.</p>
<b>Trigger Frequency Counter</b>	<p>Turn <b>On</b> to display the trigger event frequency in the <b>Trigger</b> badge.</p> <p>The trigger frequency can help you troubleshoot signal problems where the frequency of the trigger event may be related to a clock, switching power supply, or other recurrent frequency that occurs on your DUT.</p> <p>Only available if you have installed the DVM option, which is available when you register your instrument with Tektronix.</p>

## CAN serial bus trigger settings panel

Field or control	Description
<b>Source</b>	Select the <b>CAN</b> bus on which you want to trigger.
<b>Trigger On</b>	Select the type of information on which to trigger.

Table continued...

Field or control	Description
<b>Frame Type</b>	Sets the frame type on which to trigger. Available when <b>Trigger On = Type of Frame</b> .
<b>Direction</b>	Sets the transfer direction on which to trigger (Read, Write, Either). Available when <b>Trigger On = Identifier</b> .
<b>Identifier Format</b>	Sets the identifier for standard (11-bit) or extended (29-bit for CAN 2.0B) length. Available when <b>Trigger On = Identifier</b> or <b>ID &amp; Data</b> .
<b>Identifier</b>	Sets the identifier pattern on which to trigger. The number of bits shown depends on the <b>Identifier Format</b> setting. Tap the <b>Binary</b> or <b>Hex</b> field and use the <b>A</b> and <b>B</b> knobs to select and change the values. Or double-tap on the field and use the virtual keypad to enter values. Available when <b>Trigger On = Identifier</b> or <b>ID &amp; Data</b> .
<b>Data Bytes</b>	Sets the number of data bytes on which to trigger (one to eight bytes). Use the A knob to change the value. Available when <b>Trigger On = Data</b> or <b>ID &amp; Data</b> .
<b>Data</b>	Sets the data pattern on which to trigger. The number of bits shown depends on the <b>Data Bytes</b> setting. Tap the <b>Binary</b> or <b>Hex</b> field and use the <b>A</b> and <b>B</b> knobs to select and change the values. Or double-tap on the field and use the virtual keypad to enter values. Available when <b>Trigger On = Data</b> or <b>ID &amp; Data</b> .
<b>Data Offset</b>	Sets the byte offset value. Available when <b>Trigger On = Data</b> or <b>ID &amp; Data</b> .
<b>Trigger When</b>	Sets the trigger when condition. Available when <b>Trigger On = Data</b> or <b>ID &amp; Data</b> .
<b>Bit Rate Switch (BRS) Bit</b>	Sets the BRS bit state on which to trigger. Available when <b>Source</b> is a <b>CAN FD</b> bus and <b>Trigger On = FD Bits</b> .
<b>Error Status Indicator (ESI) Bit</b>	Sets the ESI bit state on which to trigger. Available when <b>Source</b> is a <b>CAN FD</b> bus and <b>Trigger On = FD Bits</b> .
<b>Error Type</b>	Sets the error type on which to trigger. Available when <b>Trigger On = Error</b> .
<b>A, B knob controls</b>	Use the <b>A</b> knob to select (highlight) the digit(s) to change. Use the <b>B</b> knob to change the value of the digit(s).

## Mode & Holdoff panel (Bus Trigger configuration panel) fields and controls

Field or control	Description
<b>Trigger Mode</b>	<p>The trigger mode determines how the instrument behaves in the absence or presence of a trigger event:</p> <p><b>Auto</b> trigger mode enables the instrument to acquire and display a waveform even if a trigger does not occur. Auto mode uses a timer that starts when the acquisition is started, and the pretrigger information is obtained. If a trigger event is not detected before the timer times out, the instrument forces a trigger. The length of time it waits for a trigger event depends on the time base setting.</p> <p>When forcing triggers in the absence of valid triggering events, Auto mode does not synchronize the waveform on the display. The waveform will appear to jump across the screen.</p> <p>If valid triggers occur, the display will become stable.</p> <p><b>Normal</b> trigger mode enables the instrument to acquire a waveform only when it is triggered. If no trigger occurs, the last waveform record acquired remains on the display. If no last waveform exists, no waveform is displayed.</p>
<b>Force Trigger</b>	Forces a trigger event regardless of whether the waveform meets any trigger conditions.
<b>Holdoff</b>	<p>Trigger holdoff sets the amount of time the oscilloscope waits after a trigger event before detecting and triggering on the next trigger event.</p> <p><b>Random</b> sets the instrument to wait for a random amount of time before recognizing another trigger event. This means that successive acquisitions are unrelated to the previous trigger signal.</p> <p><b>Time</b> sets the instrument to wait the specified time before recognizing another trigger event. Use this option when the signal that you want to trigger on has several possible trigger points or is a burst signal.</p>
<b>Holdoff Time</b>	Tap the <b>Holdoff Time</b> field and use the multipurpose knob to adjust the holdoff time value. Or double-tap the field and use the virtual keypad to enter a time holdoff period.
<b>Act on Trigger</b>	<p>Tap the <b>Act on Trigger</b> button to configure the actions the instrument must take when a trigger event occurs.</p> <p>See <a href="#">Act On Event configuration menu</a> on page 178 for the available fields and controls.</p>
<b>Trigger Frequency Counter</b>	<p>Turn <b>On</b> to display the trigger event frequency in the <b>Trigger</b> badge.</p> <p>The trigger frequency can help you troubleshoot signal problems where the frequency of the trigger event may be related to a clock, switching power supply, or other recurrent frequency that occurs on your DUT.</p> <p>Only available if you have installed the DVM option, which is available when you register your instrument with Tektronix.</p>

## Ethernet serial bus trigger settings panel

Field or control	Description
<b>Source</b>	Select the <b>Ethernet</b> bus on which to trigger.
<b>Trigger On</b>	Select the type of information on which to trigger.

Table continued...

Field or control	Description
<b>MAC Address Destination, Source</b>	<p>Sets the MAC destination and/or source address pattern on which to trigger.</p> <p>Tap a <b>Binary</b> or <b>Hex</b> field and use the <b>A</b> and <b>B</b> knobs to select and change the values. Or double-tap on the field and use the virtual keypad to enter values.</p> <p>Available when <b>Trigger On</b> is <b>MAC Addresses</b>.</p>
<b>MAC Length/Type</b>	<p>Sets the MAC length/type pattern on which to trigger.</p> <p>Tap a <b>Binary</b> or <b>Hex</b> field and use the <b>A</b> and <b>B</b> knobs to select and change the values. Or double-tap on the field and use the virtual keypad to enter values.</p> <p>Available when <b>Trigger On</b> is <b>MAC Length / Type</b>.</p>
<b>MAC Length/Type Low, MAC Length/Type High</b>	<p>Sets the boundary MAC length type conditions when testing for in-range or out of range conditions.</p> <p>Available when <b>Trigger On</b> is <b>MAC Length / Type</b> and <b>Trigger When</b> is <b>Inside Range</b> or <b>Outside Range</b>.</p>
<b>IP Protocol</b>	<p>Sets the IP protocol pattern on which to trigger.</p> <p>Tap a <b>Binary</b> or <b>Hex</b> field and use the <b>A</b> and <b>B</b> knobs to select and change the values. Or double-tap on the field and use the virtual keypad to enter values.</p> <p>Available when <b>Trigger On</b> is <b>IP Header</b>.</p>
<b>Source, Destination Address</b>	<p>Sets the source and/or destination IP address pattern on which to trigger.</p> <p>Tap a <b>Hex</b> or <b>Decimal</b> field and use the <b>A</b> and <b>B</b> knobs to select and change the values. Or double-tap on the field and use the virtual keypad to enter values.</p> <p>Available when <b>Trigger On</b> is <b>IP Header</b>.</p>
<b>Source Port, Destination Port</b>	<p>Sets the source and/or destination TCP header port pattern on which to trigger.</p> <p>Tap a <b>Binary</b>, <b>Hex</b> or <b>Decimal</b> field and use the <b>A</b> and <b>B</b> knobs to select and change the values. Or double-tap on the field and use the virtual keypad to enter values.</p> <p>Available when <b>Trigger On</b> is <b>TCP Header</b>.</p>
<b>Sequence Number</b>	<p>Sets the TCP header sequence number pattern on which to trigger.</p> <p>Tap a <b>Binary</b>, <b>Hex</b> or <b>Decimal</b> field and use the <b>A</b> and <b>B</b> knobs to select and change the values. Or double-tap on the field and use the virtual keypad to enter values.</p> <p>Available when <b>Trigger On</b> is <b>TCP Header</b>.</p>
<b>Ack Number</b>	<p>Sets the TCP header ack number pattern on which to trigger.</p> <p>Tap a <b>Binary</b>, <b>Hex</b> or <b>Decimal</b> field and use the <b>A</b> and <b>B</b> knobs to select and change the values. Or double-tap on the field and use the virtual keypad to enter values.</p> <p>Available when <b>Trigger On</b> is <b>TCP Header</b>.</p>
<b>Data Bytes</b>	<p>Sets the number of client data bytes on which to trigger (one to sixteen bytes).</p> <p>Tap the field and use the <b>A</b> knob to change the value. Or double-tap on the field and use the virtual keypad to enter values.</p> <p>Available when <b>Trigger On</b> is <b>Client Data</b>.</p>

Table continued...

Field or control	Description
<b>Byte Offset</b>	<p>Sets the client data byte offset (Don't Care or the number of bytes).</p> <p>Tap the field and use the <b>A</b> knob to change the value. Or double-tap on the field and use the virtual keypad to enter values.</p> <p>Available when <b>Trigger On</b> is <b>Client Data</b>.</p>
<b>Client Data</b>	<p>Sets the data pattern on which to trigger. The number of bits shown depends on the <b>Data Bytes</b> setting. Use in conjunction with the <b>Trigger When</b> field to specify the exact trigger condition.</p> <p>Tap the <b>Binary</b>, <b>Hex</b> or <b>ASCII</b> field and use the <b>A</b> and <b>B</b> knobs to select and change the values. Or double-tap on the field and use the virtual keypad to enter values.</p> <p>Available when <b>Trigger On</b> is <b>Client Data</b>.</p>
<b>Client Data Low, Client Data High</b>	<p>Sets the boundary data values when testing for in-range or out of range conditions. The number of bits shown depends on the <b>Data Bytes</b> setting. Use in conjunction with the <b>Trigger When</b> field to specify the exact trigger condition.</p> <p>Tap the <b>Binary</b>, <b>Hex</b> or <b>ASCII</b> field and use the <b>A</b> and <b>B</b> knobs to select and change the values. Or double-tap on the field and use the virtual keypad to enter values.</p> <p>Available when <b>Trigger On</b> is <b>Client Data</b> and <b>Trigger When</b> is <b>Inside Range</b> or <b>Outside Range</b>.</p>
<b>Trigger When</b>	<p>Sets the trigger when condition.</p> <p>When set to <b>Inside Range</b> or <b>Outside Range</b>, fields are displayed to set a high and low boundary pattern for the specified trigger type.</p> <p>Tap the <b>Binary</b> or <b>Hex</b> field and use the <b>A</b> and <b>B</b> knobs to select and change the values. Or double-tap on the field and use the virtual keypad to enter values.</p> <p>Available when <b>Trigger On</b> is <b>MAC Length/Type</b> or <b>Client Data</b>.</p>
<b>A, B knob controls</b>	<p>Use the <b>A</b> knob to select (highlight) the digit(s) to change.</p> <p>Use the <b>B</b> knob to change the value of the digit(s).</p>

### Mode & Holdoff panel (Bus Trigger configuration panel) fields and controls

Field or control	Description
<b>Trigger Mode</b>	<p>The trigger mode determines how the instrument behaves in the absence or presence of a trigger event:</p> <p><b>Auto</b> trigger mode enables the instrument to acquire and display a waveform even if a trigger does not occur. Auto mode uses a timer that starts when the acquisition is started, and the pretrigger information is obtained. If a trigger event is not detected before the timer times out, the instrument forces a trigger. The length of time it waits for a trigger event depends on the time base setting.</p> <p>When forcing triggers in the absence of valid triggering events, Auto mode does not synchronize the waveform on the display. The waveform will appear to jump across the screen.</p> <p>If valid triggers occur, the display will become stable.</p> <p><b>Normal</b> trigger mode enables the instrument to acquire a waveform only when it is triggered. If no trigger occurs, the last waveform record acquired remains on the display. If no last waveform exists, no waveform is displayed.</p>

Table continued...

Field or control	Description
<b>Force Trigger</b>	Forces a trigger event regardless of whether the waveform meets any trigger conditions.
<b>Holdoff</b>	<p>Trigger holdoff sets the amount of time the oscilloscope waits after a trigger event before detecting and triggering on the next trigger event.</p> <p><b>Random</b> sets the instrument to wait for a random amount of time before recognizing another trigger event. This means that successive acquisitions are unrelated to the previous trigger signal.</p> <p><b>Time</b> sets the instrument to wait the specified time before recognizing another trigger event. Use this option when the signal that you want to trigger on has several possible trigger points or is a burst signal.</p>
<b>Holdoff Time</b>	Tap the <b>Holdoff Time</b> field and use the multipurpose knob to adjust the holdoff time value. Or double-tap the field and use the virtual keypad to enter a time holdoff period.
<b>Act on Trigger</b>	<p>Tap the <b>Act on Trigger</b> button to configure the actions the instrument must take when a trigger event occurs.</p> <p>See <a href="#">Act On Event configuration menu</a> on page 178 for the available fields and controls.</p>
<b>Trigger Frequency Counter</b>	<p>Turn <b>On</b> to display the trigger event frequency in the <b>Trigger</b> badge.</p> <p>The trigger frequency can help you troubleshoot signal problems where the frequency of the trigger event may be related to a clock, switching power supply, or other recurrent frequency that occurs on your DUT.</p> <p>Only available if you have installed the DVM option, which is available when you register your instrument with Tektronix.</p>

### FlexRay serial bus trigger settings panel

Field or control	Description
<b>Source</b>	Select the <b>FlexRay</b> bus on which to trigger.
<b>Trigger On</b>	Select the type of information on which to trigger.
<b>Indicator Bits</b>	<p>Select the indicator bits type on which to trigger.</p> <p>Tap the <b>Binary</b> or <b>Hex</b> field and use the A and B knobs to select and change the values. Or double-tap on the field and use the virtual keypad to enter values.</p> <p>Available when <b>Trigger On = Indicator Bits</b> or <b>Header Fields</b>.</p>
<b>Identifier</b>	<p>Sets the frame identifier pattern on which to trigger.</p> <p>Tap the <b>Binary</b>, <b>Hex</b>, or <b>Decimal</b> field and use the A and B knobs to select and change the values. Or double-tap on the field and use the virtual keypad to enter values.</p> <p>Available when <b>Trigger On = Frame ID</b>, <b>Header Fields</b>, or <b>Identifier &amp; Data</b>.</p>
<b>Cycle Count</b>	<p>Sets the cycle count pattern on which to trigger. Use in conjunction with the Trigger When field to specify the exact trigger condition.</p> <p>Tap the <b>Binary</b>, <b>Hex</b>, or <b>Decimal</b> field and use the A and B knobs to select and change the values. Or double-tap on the field and use the virtual keypad to enter values.</p> <p>Available when <b>Trigger On = Cycle Count</b> or <b>Header Fields</b>.</p>

Table continued...

Field or control	Description
<b>Payload Length</b>	<p>Tap the <b>Binary</b>, <b>Hex</b>, or <b>Decimal</b> field and use the A and B knobs to select and change the values. Or double-tap on the field and use the virtual keypad to enter values.</p> <p>Available when <b>Trigger On = Header Fields</b>.</p>
<b>Header CRC</b>	<p>Tap the <b>Binary</b> or <b>Hex</b> field and use the A and B knobs to select and change the values. Or double-tap on the field and use the virtual keypad to enter values.</p> <p>Available when <b>Trigger On = Header Fields</b>.</p>
<b>Data Bytes</b>	<p>Sets the number of data bytes on which to trigger (one to sixteen bytes). Use the A knob to change the value. Or double-tap on the field and use the virtual keypad to enter values.</p> <p>Available when <b>Trigger On = Data</b> or <b>Identifier &amp; Data</b>.</p>
<b>Data</b>	<p>Sets the data pattern on which to trigger. The number of bits shown depends on the <b>Data Bytes</b> setting. Use in conjunction with the <b>Trigger When</b> field to specify the exact trigger condition.</p> <p>Tap the <b>Binary</b> or <b>Hex</b> field and use the A and B knobs to select and change the values. Or double-tap on the field and use the virtual keypad to enter values.</p> <p>Available when <b>Trigger On = Data</b> or <b>Identifier &amp; Data</b>.</p>
<b>Byte Offset</b>	<p>Sets the byte offset (<b>Don't Care</b> or the number of bytes). Tap the input box and use the A knob to change the value.</p> <p>Available when <b>Trigger On = Data</b> or <b>Identifier &amp; Data</b>.</p>
<b>Trigger When</b>	<p>Sets the trigger when condition.</p> <p>When set to <b>Inside Range</b> or <b>Outside Range</b>, fields are displayed to set a high and low boundary pattern for the specified trigger type.</p> <p>Tap the <b>Binary</b> or <b>Hex</b> field and use the A and B knobs to select and change the values. Or double-tap on the field and use the virtual keypad to enter values.</p> <p>Available when <b>Trigger On = Frame ID, Cycle Count, Data, or Identifier &amp; Data</b>.</p>
<b>Frame Type</b>	<p>Sets the end of frame type on which to trigger (Static, Dynamic (DTS), ALL).</p> <p>Available when <b>Trigger On = End of Frame</b>.</p>
<b>A, B knob controls</b>	<p>Use the A knob to select (highlight) the digit(s) to change.</p> <p>Use the B knob to change the value of the digit(s).</p>

### Mode & Holdoff panel (Bus Trigger configuration panel) fields and controls

Field or control	Description
<b>Trigger Mode</b>	<p>The trigger mode determines how the instrument behaves in the absence or presence of a trigger event:</p> <p><b>Auto</b> trigger mode enables the instrument to acquire and display a waveform even if a trigger does not occur. Auto mode uses a timer that starts when the acquisition is started, and the pretrigger information is obtained. If a trigger event is not detected before the timer times out, the instrument forces a trigger. The length of time it waits for a trigger event depends on the time base setting.</p> <p>When forcing triggers in the absence of valid triggering events, Auto mode does not synchronize the waveform on the display. The waveform will appear to jump across the screen.</p> <p>If valid triggers occur, the display will become stable.</p> <p><b>Normal</b> trigger mode enables the instrument to acquire a waveform only when it is triggered. If no trigger occurs, the last waveform record acquired remains on the display. If no last waveform exists, no waveform is displayed.</p>
<b>Force Trigger</b>	Forces a trigger event regardless of whether the waveform meets any trigger conditions.
<b>Holdoff</b>	<p>Trigger holdoff sets the amount of time the oscilloscope waits after a trigger event before detecting and triggering on the next trigger event.</p> <p><b>Random</b> sets the instrument to wait for a random amount of time before recognizing another trigger event. This means that successive acquisitions are unrelated to the previous trigger signal.</p> <p><b>Time</b> sets the instrument to wait the specified time before recognizing another trigger event. Use this option when the signal that you want to trigger on has several possible trigger points or is a burst signal.</p>
<b>Holdoff Time</b>	Tap the <b>Holdoff Time</b> field and use the multipurpose knob to adjust the holdoff time value. Or double-tap the field and use the virtual keypad to enter a time holdoff period.
<b>Act on Trigger</b>	<p>Tap the <b>Act on Trigger</b> button to configure the actions the instrument must take when a trigger event occurs.</p> <p>See <a href="#">Act On Event configuration menu</a> on page 178 for the available fields and controls.</p>
<b>Trigger Frequency Counter</b>	<p>Turn <b>On</b> to display the trigger event frequency in the <b>Trigger</b> badge.</p> <p>The trigger frequency can help you troubleshoot signal problems where the frequency of the trigger event may be related to a clock, switching power supply, or other recurrent frequency that occurs on your DUT.</p> <p>Only available if you have installed the DVM option, which is available when you register your instrument with Tektronix.</p>

### I2C serial bus trigger settings panel

Field or control	Description
<b>Source</b>	Select the <b>I2C</b> bus on which to trigger.
<b>Trigger On</b>	Select the type of information on which to trigger.

Table continued...



Field or control	Description
<b>Direction</b>	Sets the transfer direction on which to trigger (Read, Write, Either). Available when <b>Trigger On</b> is <b>Address</b> .
<b>Addressing Mode</b>	Sets the slave device address length (7 bits or 10 bits long). Available when <b>Trigger On</b> is <b>Address</b> or <b>Address &amp; Data</b> .
<b>Address</b>	Sets the address pattern on which to trigger. The number of bits shown depends on the <b>Address Mode</b> setting. Tap the <b>Binary</b> or <b>Hex</b> field and use the <b>A</b> and <b>B</b> knobs to select and change the values. Or double-tap on the field and use the virtual keypad to enter values. Available when <b>Trigger On</b> is <b>Address</b> or <b>Address &amp; Data</b> .
<b>Data Bytes</b>	Sets the number of data bytes on which to trigger (one to five bytes). Use the <b>A</b> knob to change the value. Available when <b>Trigger On</b> is <b>Data</b> or <b>Address &amp; Data</b> .
<b>Data</b>	Sets the data pattern on which to trigger. The number of bits shown depends on the <b>Data Bytes</b> setting. Tap the <b>Binary</b> or <b>Hex</b> field and use the <b>A</b> and <b>B</b> knobs to select and change the values. Or double-tap on the field and use the virtual keypad to enter values. Available when <b>Trigger On</b> is <b>Data</b> or <b>Address &amp; Data</b> .
<b>A, B knob controls</b>	Use the <b>A</b> knob to select (highlight) the digit(s) to change. Use the <b>B</b> knob to change the value of the digit(s). Or double-tap on the field and use the virtual keypad to enter values.

### Mode & Holdoff panel (Bus Trigger configuration panel) fields and controls

Field or control	Description
<b>Trigger Mode</b>	The trigger mode determines how the instrument behaves in the absence or presence of a trigger event:  <b>Auto</b> trigger mode enables the instrument to acquire and display a waveform even if a trigger does not occur. Auto mode uses a timer that starts when the acquisition is started, and the pretrigger information is obtained. If a trigger event is not detected before the timer times out, the instrument forces a trigger. The length of time it waits for a trigger event depends on the time base setting.  When forcing triggers in the absence of valid triggering events, Auto mode does not synchronize the waveform on the display. The waveform will appear to jump across the screen.  If valid triggers occur, the display will become stable.  <b>Normal</b> trigger mode enables the instrument to acquire a waveform only when it is triggered. If no trigger occurs, the last waveform record acquired remains on the display. If no last waveform exists, no waveform is displayed.
<b>Force Trigger</b>	Forces a trigger event regardless of whether the waveform meets any trigger conditions.

Table continued...

Field or control	Description
<b>Holdoff</b>	<p>Trigger holdoff sets the amount of time the oscilloscope waits after a trigger event before detecting and triggering on the next trigger event.</p> <p><b>Random</b> sets the instrument to wait for a random amount of time before recognizing another trigger event. This means that successive acquisitions are unrelated to the previous trigger signal.</p> <p><b>Time</b> sets the instrument to wait the specified time before recognizing another trigger event. Use this option when the signal that you want to trigger on has several possible trigger points or is a burst signal.</p>
<b>Holdoff Time</b>	Tap the <b>Holdoff Time</b> field and use the multipurpose knob to adjust the holdoff time value. Or double-tap the field and use the virtual keypad to enter a time holdoff period.
<b>Act on Trigger</b>	<p>Tap the <b>Act on Trigger</b> button to configure the actions the instrument must take when a trigger event occurs.</p> <p>See <a href="#">Act On Event configuration menu</a> on page 178 for the available fields and controls.</p>
<b>Trigger Frequency Counter</b>	<p>Turn <b>On</b> to display the trigger event frequency in the <b>Trigger</b> badge.</p> <p>The trigger frequency can help you troubleshoot signal problems where the frequency of the trigger event may be related to a clock, switching power supply, or other recurrent frequency that occurs on your DUT.</p> <p>Only available if you have installed the DVM option, which is available when you register your instrument with Tektronix.</p>

### I3C serial bus trigger settings panel

Field or control	Description
<b>Source</b>	Select the <b>I3C</b> bus on which to trigger.
<b>Trigger On</b>	Select the type of information on which to trigger.
<b>Start</b>	Sets the trigger on start.
<b>Repeated Start</b>	Sets the trigger on repeated start.
<b>Addressing Mode</b>	Sets the address length as <b>7-Bit</b> or <b>10-Bit</b> .
<b>Direction</b>	<p>Sets the transfer direction <b>Read</b>, <b>Write</b>, or <b>Either</b>.</p> <p>Available when <b>Trigger On</b> is <b>Address</b> and <b>Addressing Mode</b> is <b>7-Bit</b>.</p>
<b>Address</b>	<p>Sets the address pattern on which to trigger based on the selected addressing mode and direction.</p> <p>Available when <b>Trigger On</b> is <b>Address</b>.</p> <p>Tap the <b>Binary</b> or <b>Hex</b> field and use the <b>A</b> and <b>B</b> knobs to select and change the values. Or double-tap on the field and use the virtual keypad to enter values.</p>
<b>Data Bytes</b>	Sets the number of <b>Data Bytes</b> to show in the data field. Varies from 1 byte to 5 bytes.
<b>Data</b>	<p>Sets the data pattern on which to trigger.</p> <p>Tap the <b>Binary</b> or <b>Hex</b> field and use the <b>A</b> and <b>B</b> knobs to select and change the values. Or double-tap on the field and use the virtual keypad to enter values.</p>

Table continued...

Field or control	Description
<b>Enable Slave</b>	Enables the trigger on <b>Enable Slave</b> (ENEC) device. Available when <b>Trigger On</b> is <b>I3C SDR Direct</b> or <b>I3C SDR Broadcast</b> .
<b>Disable Slave</b>	Enables the trigger on <b>Disable Slave</b> (DISEC) device. Available when <b>Trigger On</b> is <b>I3C SDR Direct</b> or <b>I3C SDR Broadcast</b> .
<b>Enter Activity State</b>	Enables the trigger on <b>Enter Activity State</b> (ENTAS0, ENTAS1, ENTAS2, ENTAS3). Available when <b>Trigger On</b> is <b>I3C SDR Direct</b> or <b>I3C SDR Broadcast</b> .
<b>Reset Dynamic Address</b>	Enables the trigger on <b>Reset Dynamic Address</b> (RSTDAA). Available when <b>Trigger On</b> is <b>I3C SDR Direct</b> or <b>I3C SDR Broadcast</b> .
<b>Enter Dynamic Address</b>	Enables the trigger on <b>Enter Dynamic Address Assignment</b> (ENTDAA). Available when <b>Trigger On</b> is <b>I3C SDR Broadcast</b> .
<b>Set Max Write Length</b>	Enables the trigger on <b>Set Max Write Length</b> (SETMWL). Available when <b>Trigger On</b> is <b>I3C SDR Direct</b> or <b>I3C SDR Broadcast</b> .
<b>Set Max Read Length</b>	Enables the trigger on <b>Set Max Read Length</b> (SETMRL). Available when <b>Trigger On</b> is <b>I3C SDR Direct</b> or <b>I3C SDR Broadcast</b> .
<b>Define List of Slaves</b>	Enables the trigger on <b>Define List of Slaves</b> . Available when <b>Trigger On</b> is <b>I3C SDR Broadcast</b> in I3C Trigger configuration menu and <b>Version</b> is <b>1.1</b> from the I3C Bus configuration menu.
<b>Enter Test Mode</b>	Enables the trigger on <b>Enter Test Mode</b> . Available when <b>Trigger On</b> is <b>I3C SDR Broadcast</b> in I3C Trigger configuration menu and <b>Version</b> is <b>1.1</b> from the I3C Bus configuration menu.
<b>Set Exchange Time</b>	Enables the trigger on <b>Set Exchange Time</b> (SETXTIME). Available when <b>Trigger On</b> is <b>I3C SDR Direct</b> or <b>I3C SDR Broadcast</b> .
<b>Set Static as Dynamic Address</b>	Enables the trigger on <b>Set Static as Dynamic Address</b> . Available when <b>Trigger On</b> is <b>I3C SDR Broadcast</b> in I3C Trigger configuration menu and <b>Version</b> is <b>1.1</b> from the I3C Bus configuration menu.
<b>Set Dynamic Address</b>	Enables the trigger on <b>Set Dynamic Address</b> (SETDASA). Available when <b>Trigger On</b> is <b>I3C SDR Direct</b> .
<b>Set New Dynamic Address</b>	Enables the trigger on <b>Set New Dynamic Address</b> (SETNEWDA). Available when <b>Trigger On</b> is <b>I3C SDR Direct</b> .
<b>Get Max Write Length</b>	Enables the trigger on <b>Get Max Write Length</b> (GETMWL). Available when <b>Trigger On</b> is <b>I3C SDR Direct</b> .
<b>Get Max Read Length</b>	Enables the trigger on <b>Get Max Read Length</b> (GETMRL). Available when <b>Trigger On</b> is <b>I3C SDR Direct</b> .

Table continued...

Field or control	Description
<b>Get Provisional ID</b>	Enables the trigger on <b>Get Provisional ID</b> (GETPID). Available when <b>Trigger On</b> is <b>I3C SDR Direct</b> .
<b>Get Bus Characteristics</b>	Enables the trigger on <b>Get Bus Characteristics</b> (GETBCR). Available when <b>Trigger On</b> is <b>I3C SDR Direct</b> .
<b>Get Dev Characteristics</b>	Enables the trigger on <b>Get Dev Characteristics</b> (GETDCR). Available when <b>Trigger On</b> is <b>I3C SDR Direct</b> .
<b>Get Slave Current Status</b>	Enables the trigger on <b>Get Slave Current Status</b> (GETSTATUS). Available when <b>Trigger On</b> is <b>I3C SDR Direct</b> .
<b>Get Accept Mastership</b>	Enables the trigger on <b>Get Accept Mastership</b> (GETACCMST). Available when <b>Trigger On</b> is <b>I3C SDR Direct</b> .
<b>Set Bridge Direct Target</b>	Enables the trigger on <b>Set Bridge Direct Target</b> (SETBRGTGT). Available when <b>Trigger On</b> is <b>I3C SDR Direct</b> .
<b>Get Max Data Speed</b>	Enables the trigger on <b>Get Max Data Speed</b> (GETMXDS) for a specific Slave device. Available when <b>Trigger On</b> is <b>I3C SDR Direct</b> .
<b>Get Optional Feature Capabilities</b>	Enables the trigger on <b>Get Optional Feature Capabilities</b> for a specific Slave device. Available when <b>Trigger On</b> is <b>I3C SDR Direct</b> in I3C Trigger configuration menu and <b>Version</b> is <b>1.1</b> from the I3C Bus configuration menu.
<b>Data Transfer Ending Procedure Control</b>	Enables the trigger on <b>Data Transfer Ending Procedure Control</b> for a specific Slave device. Available when <b>Trigger On</b> is <b>I3C SDR Direct</b> or <b>I3C SDR Broadcast</b> in I3C Trigger configuration menu and <b>Version</b> is <b>1.1</b> from the I3C Bus configuration menu.
<b>Set Group Address</b>	Enables the trigger on <b>Set Group Address</b> for a specific Slave device. Available when <b>Trigger On</b> is <b>I3C SDR Direct</b> or <b>I3C SDR Broadcast</b> in I3C Trigger configuration menu and <b>Version</b> is <b>1.1</b> from the I3C Bus configuration menu.
<b>Slave Reset Action</b>	Enables the trigger on <b>Slave Reset Action</b> for a specific Slave device. Available when <b>Trigger On</b> is <b>I3C SDR Direct</b> or <b>I3C SDR Broadcast</b> in I3C Trigger configuration menu and <b>Version</b> is <b>1.1</b> from the I3C Bus configuration menu.
<b>Define List of Group Addresses</b>	Enables the trigger on <b>Define List of Group Addresses</b> for a specific Slave device. Available when <b>Trigger On</b> is <b>I3C SDR Direct</b> or <b>I3C SDR Broadcast</b> in I3C Trigger configuration menu and <b>Version</b> is <b>1.1</b> from the I3C Bus configuration menu.
<b>Reset Group Address</b>	Enables the trigger on <b>Set Group Address</b> for a specific Slave device. Available when <b>Trigger On</b> is <b>I3C SDR Direct</b> or <b>I3C SDR Broadcast</b> in I3C Trigger configuration menu and <b>Version</b> is <b>1.1</b> from the I3C Bus configuration menu.

Table continued...

Field or control	Description
<b>Multi-Lane Data Transfer Control</b>	Enables the trigger on <b>Multi-Lane Data Transfer Control</b> for a specific Slave device. Available when <b>Trigger On</b> is <b>I3C SDR Direct</b> or <b>I3C SDR Broadcast</b> in I3C Trigger configuration menu and <b>Version</b> is <b>1.1</b> from the I3C Bus configuration menu.
<b>Set Route</b>	Enables the trigger on <b>Set Route</b> for a specific Slave device. Available when <b>Trigger On</b> is <b>I3C SDR Direct</b> in I3C Trigger configuration menu and <b>Version</b> is <b>1.1</b> from the I3C Bus configuration menu.
<b>Device to Device(s) Tunneling Control</b>	Enables the trigger on <b>Device to Device(s) Tunneling Control</b> for a specific Slave device. Available when <b>Trigger On</b> is <b>I3C SDR Direct</b> in I3C Trigger configuration menu and <b>Version</b> is <b>1.1</b> from the I3C Bus configuration menu.
<b>Set Bus Context</b>	Enables the trigger on <b>Set Bus Context</b> for a specific Slave device. Available when <b>Trigger On</b> is <b>I3C SDR Broadcast</b> in I3C Trigger configuration menu and <b>Version</b> is <b>1.1</b> from the I3C Bus configuration menu.
<b>Get HDR Capability</b>	Enables the trigger on <b>Get HDR Capability</b> (GETHDRCAP). Available when <b>Trigger On</b> is <b>I3C SDR Direct</b> from I3C Trigger configuration menu and <b>Version</b> is <b>1.0</b> from the I3C Bus configuration menu.
<b>Get Exchange Time</b>	Enables the trigger on <b>Get Exchange Time</b> (GETXTIME). Available when <b>Trigger On</b> is <b>I3C SDR Direct</b> .
<b>Enter Test Mode</b>	Enables the trigger on <b>Enter Test Mode</b> (ENTTM). Available when <b>Trigger On</b> is <b>I3C SDR Broadcast</b> .
<b>Missing Ack</b>	Enables trigger on missing ACK error. Available when <b>Trigger On</b> is <b>Errors</b> .
<b>T-Bit</b>	Sets the error type to T-Bit (Transition Bit) error. Available when <b>Trigger On</b> is <b>Errors</b> .
<b>Direction</b>	Enables trigger on T-Bit error for <b>Read</b> or <b>Write</b> direction. Available when <b>Trigger On</b> is <b>Errors</b> and <b>Error Type</b> is <b>T-Bit</b> .
<b>Broadcast Address</b>	Enables the trigger on broadcast address error. Available when <b>Trigger On</b> is <b>Errors</b> .
<b>Hot-Join</b>	Enables trigger on hot join.
<b>Stop</b>	Enables trigger on stop.
<b>HDR Restart</b>	Enables trigger on HDR restart.
<b>HDR Exit</b>	Enables trigger on HDR exit.
<b>Slave Reset Pattern</b>	Enables the trigger on broadcast address error. Available when <b>Version</b> is <b>1.1</b> in I3C bus configuration menu.

## Mode & Holdoff panel (Bus Trigger configuration panel) fields and controls

Field or control	Description
<b>Trigger Mode</b>	<p>The trigger mode determines how the instrument behaves in the absence or presence of a trigger event:</p> <p><b>Auto</b> trigger mode enables the instrument to acquire and display a waveform even if a trigger does not occur. Auto mode uses a timer that starts when the acquisition is started, and the pretrigger information is obtained. If a trigger event is not detected before the timer times out, the instrument forces a trigger. The length of time it waits for a trigger event depends on the time base setting.</p> <p>When forcing triggers in the absence of valid triggering events, Auto mode does not synchronize the waveform on the display. The waveform will appear to jump across the screen.</p> <p>If valid triggers occur, the display will become stable.</p> <p><b>Normal</b> trigger mode enables the instrument to acquire a waveform only when it is triggered. If no trigger occurs, the last waveform record acquired remains on the display. If no last waveform exists, no waveform is displayed.</p>
<b>Force Trigger</b>	Forces a trigger event regardless of whether the waveform meets any trigger conditions.
<b>Holdoff</b>	<p>Trigger holdoff sets the amount of time the oscilloscope waits after a trigger event before detecting and triggering on the next trigger event.</p> <p><b>Random</b> sets the instrument to wait for a random amount of time before recognizing another trigger event. This means that successive acquisitions are unrelated to the previous trigger signal.</p> <p><b>Time</b> sets the instrument to wait the specified time before recognizing another trigger event. Use this option when the signal that you want to trigger on has several possible trigger points or is a burst signal.</p>
<b>Holdoff Time</b>	Tap the <b>Holdoff Time</b> field and use the multipurpose knob to adjust the holdoff time value. Or double-tap the field and use the virtual keypad to enter a time holdoff period.
<b>Act on Trigger</b>	<p>Tap the <b>Act on Trigger</b> button to configure the actions the instrument must take when a trigger event occurs.</p> <p>See <a href="#">Act On Event configuration menu</a> on page 178 for the available fields and controls.</p>
<b>Trigger Frequency Counter</b>	<p>Turn <b>On</b> to display the trigger event frequency in the <b>Trigger</b> badge.</p> <p>The trigger frequency can help you troubleshoot signal problems where the frequency of the trigger event may be related to a clock, switching power supply, or other recurrent frequency that occurs on your DUT.</p> <p>Only available if you have installed the DVM option, which is available when you register your instrument with Tektronix.</p>

## LIN serial bus trigger settings panel

Field or control	Description
<b>Source</b>	Select the <b>LIN</b> bus on which to trigger.
<b>Trigger On</b>	Select the type of information on which to trigger.

Table continued...

Field or control	Description
<b>Identifier</b>	<p>Sets the identifier pattern on which to trigger.</p> <p>Tap the <b>Binary</b>, <b>Hex</b>, or <b>Decimal</b> field and use the <b>A</b> and <b>B</b> knobs to select and change the values. Or double-tap on the field and use the virtual keypad to enter values.</p> <p>Available when <b>Trigger On = Identifier</b> or <b>Identifier &amp; Data</b>.</p>
<b>Data</b>	<p>Sets the data pattern on which to trigger. The number of bits shown depends on the <b>Data Bytes</b> setting.</p> <p>Tap the <b>Binary</b> or <b>Hex</b> field and use the <b>A</b> and <b>B</b> knobs to select and change the values. Or double-tap on the field and use the virtual keypad to enter values.</p> <p>Available when <b>Trigger On = Data</b> or <b>Identifier &amp; Data</b>.</p>
<b>Trigger When</b>	<p>Sets the trigger when condition.</p> <p>When set to <b>Inside Range</b> or <b>Outside Range</b>, fields are displayed to set a high and low boundary pattern for the specified trigger type.</p> <p>Available when <b>Trigger On = Data</b> or <b>Identifier &amp; Data</b>.</p>
<b>Data Bytes</b>	<p>Sets the number of data bytes on which to trigger (one to eight bytes). Use the <b>A</b> knob to change the value.</p> <p>Available when <b>Trigger On = Data</b> or <b>Identifier &amp; Data</b>.</p>
<b>A, B knob controls</b>	<p>Use the <b>A</b> knob to select (highlight) the digit(s) to change.</p> <p>Use the <b>B</b> knob to change the value of the digit(s). Or double-tap on the field and use the virtual keypad to enter values.</p>
<b>Error Type</b>	<p>Sets the LIN error type on which to trigger.</p> <p>Available when <b>Trigger On = Error</b>.</p>

### Mode & Holdoff panel (Bus Trigger configuration panel) fields and controls

Field or control	Description
<b>Trigger Mode</b>	<p>The trigger mode determines how the instrument behaves in the absence or presence of a trigger event:</p> <p><b>Auto</b> trigger mode enables the instrument to acquire and display a waveform even if a trigger does not occur. Auto mode uses a timer that starts when the acquisition is started, and the pretrigger information is obtained. If a trigger event is not detected before the timer times out, the instrument forces a trigger. The length of time it waits for a trigger event depends on the time base setting.</p> <p>When forcing triggers in the absence of valid triggering events, Auto mode does not synchronize the waveform on the display. The waveform will appear to jump across the screen.</p> <p>If valid triggers occur, the display will become stable.</p> <p><b>Normal</b> trigger mode enables the instrument to acquire a waveform only when it is triggered. If no trigger occurs, the last waveform record acquired remains on the display. If no last waveform exists, no waveform is displayed.</p>
<b>Force Trigger</b>	<p>Forces a trigger event regardless of whether the waveform meets any trigger conditions.</p>

Table continued...

Field or control	Description
<b>Holdoff</b>	<p>Trigger holdoff sets the amount of time the oscilloscope waits after a trigger event before detecting and triggering on the next trigger event.</p> <p><b>Random</b> sets the instrument to wait for a random amount of time before recognizing another trigger event. This means that successive acquisitions are unrelated to the previous trigger signal.</p> <p><b>Time</b> sets the instrument to wait the specified time before recognizing another trigger event. Use this option when the signal that you want to trigger on has several possible trigger points or is a burst signal.</p>
<b>Holdoff Time</b>	<p>Tap the <b>Holdoff Time</b> field and use the multipurpose knob to adjust the holdoff time value. Or double-tap the field and use the virtual keypad to enter a time holdoff period.</p>
<b>Act on Trigger</b>	<p>Tap the <b>Act on Trigger</b> button to configure the actions the instrument must take when a trigger event occurs.</p> <p>See <a href="#">Act On Event configuration menu</a> on page 178 for the available fields and controls.</p>
<b>Trigger Frequency Counter</b>	<p>Turn <b>On</b> to display the trigger event frequency in the <b>Trigger</b> badge.</p> <p>The trigger frequency can help you troubleshoot signal problems where the frequency of the trigger event may be related to a clock, switching power supply, or other recurrent frequency that occurs on your DUT.</p> <p>Only available if you have installed the DVM option, which is available when you register your instrument with Tektronix.</p>

### MIL-STD-1553 serial bus trigger settings panel

Field or control	Description
<b>Source</b>	Select the <b>MIL-STD-1553</b> bus on which you want to trigger.
<b>Trigger On</b>	Select the type of information on which to trigger.
<b>Sync</b>	<p>Sets to trigger on a Sync condition.</p> <p>Available when <b>Trigger On = Sync</b>.</p>
<b>Transmit/Receive Bit</b>	<p>Sets the transmit or receive bit on which to trigger.</p> <p>Available when <b>Trigger On = Command</b>.</p>
<b>Trigger When RT Address</b>	<p>Sets to trigger when the specified RT address condition occurs.</p> <p>Available when <b>Trigger On = Command</b> or <b>Status</b>.</p>
<b>Parity</b>	<p>Sets to trigger on the selected parity bit logic state.</p> <p>Available when <b>Trigger On = Command, Status, or Data</b>.</p>
<b>Address</b>	<p>Sets the address pattern on which to trigger.</p> <p>Tap the <b>Binary, Hex, or Decimal</b> field and use the <b>A</b> and <b>B</b> knobs to select and change the values. Or double-tap on the field and use the virtual keypad to enter values.</p> <p>Available when <b>Trigger On = Command</b> or <b>Status</b>.</p>

Table continued...



Field or control	Description
<b>Low Address</b>	<p>Sets the low value of the address pattern range on which to trigger.</p> <p>Tap the <b>Binary</b>, <b>Hex</b>, or <b>Decimal</b> field and use the <b>A</b> and <b>B</b> knobs to select and change the values. Or double-tap on the field and use the virtual keypad to enter values.</p> <p>Available when <b>Trigger When RT Address = Inside Range</b> or <b>Outside Range</b>.</p>
<b>High Address</b>	<p>Sets the high address of the address pattern range on which to trigger.</p> <p>Tap the <b>Binary</b>, <b>Hex</b>, or <b>Decimal</b> field and use the <b>A</b> and <b>B</b> knobs to select and change the values. Or double-tap on the field and use the virtual keypad to enter values.</p> <p>Available when <b>Trigger When RT Address = Inside Range</b> or <b>Outside Range</b>.</p>
<b>Subaddress/Mode</b>	<p>Sets the subaddress or mode pattern on which to trigger.</p> <p>Tap the <b>Binary</b>, <b>Hex</b>, or <b>Decimal</b> field and use the <b>A</b> and <b>B</b> knobs to select and change the values. Or double-tap on the field and use the virtual keypad to enter values.</p> <p>Available when <b>Trigger On = Command</b>.</p>
<b>Status Word Bits</b>	<p>Sets the status word pattern on which to trigger.</p> <p>Tap the <b>Binary</b>, <b>Hex</b>, or <b>Decimal</b> field and use the <b>A</b> and <b>B</b> knobs to select and change the values. Selecting a bit shows a short description of that bit's function. Or double-tap on the field and use the virtual keypad to enter values.</p> <p>Available when <b>Trigger On = Status</b>.</p>
<b>Data</b>	<p>Sets the data pattern on which to trigger.</p> <p>Available when <b>Trigger On = Data</b>.</p>
<b>Trigger When</b>	<p>Sets to trigger when the specified RT/IMG signal time condition occurs.</p> <p>Available when <b>Trigger On = Time (RT/IMG)</b>.</p>
<b>Minimum Time</b>	<p>Sets the minimum time for a valid RT/IMG signal.</p> <p>Available when <b>Trigger On = Time (RT/IMG)</b>.</p>
<b>Maximum Time</b>	<p>Sets the maximum time for a valid RT/IMG signal.</p> <p>Available when <b>Trigger On = Time (RT/IMG)</b>.</p>
<b>Error Type</b>	<p>Sets the error condition on which to trigger.</p> <p>Available when <b>Trigger On = Error</b>.</p>
<b>A, B knob controls</b>	<p>Use the <b>A</b> knob to select (highlight) the digit(s) to change in data or bit fields.</p> <p>Use the <b>B</b> knob to change the value of the digit(s). Or double-tap on the field and use the virtual keypad to enter values.</p>

### Mode & Holdoff panel (Bus Trigger configuration panel) fields and controls

Field or control	Description
<b>Trigger Mode</b>	<p>The trigger mode determines how the instrument behaves in the absence or presence of a trigger event:</p> <p><b>Auto</b> trigger mode enables the instrument to acquire and display a waveform even if a trigger does not occur. Auto mode uses a timer that starts when the acquisition is started, and the pretrigger information is obtained. If a trigger event is not detected before the timer times out, the instrument forces a trigger. The length of time it waits for a trigger event depends on the time base setting.</p> <p>When forcing triggers in the absence of valid triggering events, Auto mode does not synchronize the waveform on the display. The waveform will appear to jump across the screen.</p> <p>If valid triggers occur, the display will become stable.</p> <p><b>Normal</b> trigger mode enables the instrument to acquire a waveform only when it is triggered. If no trigger occurs, the last waveform record acquired remains on the display. If no last waveform exists, no waveform is displayed.</p>
<b>Force Trigger</b>	Forces a trigger event regardless of whether the waveform meets any trigger conditions.
<b>Holdoff</b>	<p>Trigger holdoff sets the amount of time the oscilloscope waits after a trigger event before detecting and triggering on the next trigger event.</p> <p><b>Random</b> sets the instrument to wait for a random amount of time before recognizing another trigger event. This means that successive acquisitions are unrelated to the previous trigger signal.</p> <p><b>Time</b> sets the instrument to wait the specified time before recognizing another trigger event. Use this option when the signal that you want to trigger on has several possible trigger points or is a burst signal.</p>
<b>Holdoff Time</b>	Tap the <b>Holdoff Time</b> field and use the multipurpose knob to adjust the holdoff time value. Or double-tap the field and use the virtual keypad to enter a time holdoff period.
<b>Act on Trigger</b>	<p>Tap the <b>Act on Trigger</b> button to configure the actions the instrument must take when a trigger event occurs.</p> <p>See <a href="#">Act On Event configuration menu</a> on page 178 for the available fields and controls.</p>
<b>Trigger Frequency Counter</b>	<p>Turn <b>On</b> to display the trigger event frequency in the <b>Trigger</b> badge.</p> <p>The trigger frequency can help you troubleshoot signal problems where the frequency of the trigger event may be related to a clock, switching power supply, or other recurrent frequency that occurs on your DUT.</p> <p>Only available if you have installed the DVM option, which is available when you register your instrument with Tektronix.</p>

### Parallel serial bus trigger settings panel



**Note:** Parallel bus triggering is standard on all instruments.

Field or control	Description
<b>Source</b>	Select the type of information on which to trigger.
Table continued...	

Field or control	Description
<b>Data</b>	<p>Sets the data pattern on which to trigger. The number of bits shown depends on how the parallel bus is defined.</p> <p>Tap the <b>Binary</b> or <b>Hex</b> field and use the <b>A</b> and <b>B</b> knobs to select and change the values. Or double-tap on the field and use the virtual keypad to enter values.</p>
<b>A, B knob controls</b>	<p>Use the <b>A</b> knob to select (highlight) the digit(s) to change.</p> <p>Use the <b>B</b> knob to change the value of the digit(s).</p>

### Mode & Holdoff panel (Bus Trigger configuration panel) fields and controls

Field or control	Description
<b>Trigger Mode</b>	<p>The trigger mode determines how the instrument behaves in the absence or presence of a trigger event:</p> <p><b>Auto</b> trigger mode enables the instrument to acquire and display a waveform even if a trigger does not occur. Auto mode uses a timer that starts when the acquisition is started, and the pretrigger information is obtained. If a trigger event is not detected before the timer times out, the instrument forces a trigger. The length of time it waits for a trigger event depends on the time base setting.</p> <p>When forcing triggers in the absence of valid triggering events, Auto mode does not synchronize the waveform on the display. The waveform will appear to jump across the screen.</p> <p>If valid triggers occur, the display will become stable.</p> <p><b>Normal</b> trigger mode enables the instrument to acquire a waveform only when it is triggered. If no trigger occurs, the last waveform record acquired remains on the display. If no last waveform exists, no waveform is displayed.</p>
<b>Force Trigger</b>	Forces a trigger event regardless of whether the waveform meets any trigger conditions.
<b>Holdoff</b>	<p>Trigger holdoff sets the amount of time the oscilloscope waits after a trigger event before detecting and triggering on the next trigger event.</p> <p><b>Random</b> sets the instrument to wait for a random amount of time before recognizing another trigger event. This means that successive acquisitions are unrelated to the previous trigger signal.</p> <p><b>Time</b> sets the instrument to wait the specified time before recognizing another trigger event. Use this option when the signal that you want to trigger on has several possible trigger points or is a burst signal.</p>
<b>Holdoff Time</b>	Tap the <b>Holdoff Time</b> field and use the multipurpose knob to adjust the holdoff time value. Or double-tap the field and use the virtual keypad to enter a time holdoff period.
<b>Act on Trigger</b>	<p>Tap the <b>Act on Trigger</b> button to configure the actions the instrument must take when a trigger event occurs.</p> <p>See <a href="#">Act On Event configuration menu</a> on page 178 for the available fields and controls.</p>

Table continued...

Field or control	Description
Trigger Frequency Counter	<p>Turn <b>On</b> to display the trigger event frequency in the <b>Trigger</b> badge.</p> <p>The trigger frequency can help you troubleshoot signal problems where the frequency of the trigger event may be related to a clock, switching power supply, or other recurrent frequency that occurs on your DUT.</p> <p>Only available if you have installed the DVM option, which is available when you register your instrument with Tektronix.</p>

### RS-232 serial bus trigger settings panel

Field or control	Description
Source	Select the <b>RS232</b> bus on which to trigger.
Trigger On	Select the type of information on which to trigger.
Data Bytes	<p>Sets the number of data bytes (1 byte = 8 bits) on which to trigger (one to ten bytes). Use the <b>A</b> knob to change the value.</p> <p>Available when <b>Trigger On = Data</b>.</p>
Data	<p>Sets the data pattern on which to trigger. The number of bits shown depends on the <b>Data Words</b> setting.</p> <p>Tap the <b>Binary</b>, <b>Hex</b>, or <b>ASCII</b> field and use the <b>A</b> and <b>B</b> knobs to select and change the values. Or double-tap on the field and use the virtual keypad to enter values.</p> <p>Available when <b>Trigger On = Data</b>.</p>
A, B knob controls	<p>Use the <b>A</b> knob to select (highlight) the digit(s) to change.</p> <p>Use the <b>B</b> knob to change the value of the digit(s).</p>

### Mode & Holdoff panel (Bus Trigger configuration panel) fields and controls

Field or control	Description
Trigger Mode	<p>The trigger mode determines how the instrument behaves in the absence or presence of a trigger event:</p> <p><b>Auto</b> trigger mode enables the instrument to acquire and display a waveform even if a trigger does not occur. Auto mode uses a timer that starts when the acquisition is started, and the pretrigger information is obtained. If a trigger event is not detected before the timer times out, the instrument forces a trigger. The length of time it waits for a trigger event depends on the time base setting.</p> <p>When forcing triggers in the absence of valid triggering events, Auto mode does not synchronize the waveform on the display. The waveform will appear to jump across the screen.</p> <p>If valid triggers occur, the display will become stable.</p> <p><b>Normal</b> trigger mode enables the instrument to acquire a waveform only when it is triggered. If no trigger occurs, the last waveform record acquired remains on the display. If no last waveform exists, no waveform is displayed.</p>
Force Trigger	Forces a trigger event regardless of whether the waveform meets any trigger conditions.

Table continued...

Field or control	Description
<b>Holdoff</b>	<p>Trigger holdoff sets the amount of time the oscilloscope waits after a trigger event before detecting and triggering on the next trigger event.</p> <p><b>Random</b> sets the instrument to wait for a random amount of time before recognizing another trigger event. This means that successive acquisitions are unrelated to the previous trigger signal.</p> <p><b>Time</b> sets the instrument to wait the specified time before recognizing another trigger event. Use this option when the signal that you want to trigger on has several possible trigger points or is a burst signal.</p>
<b>Holdoff Time</b>	Tap the <b>Holdoff Time</b> field and use the multipurpose knob to adjust the holdoff time value. Or double-tap the field and use the virtual keypad to enter a time holdoff period.
<b>Act on Trigger</b>	<p>Tap the <b>Act on Trigger</b> button to configure the actions the instrument must take when a trigger event occurs.</p> <p>See <a href="#">Act On Event configuration menu</a> on page 178 for the available fields and controls.</p>
<b>Trigger Frequency Counter</b>	<p>Turn <b>On</b> to display the trigger event frequency in the <b>Trigger</b> badge.</p> <p>The trigger frequency can help you troubleshoot signal problems where the frequency of the trigger event may be related to a clock, switching power supply, or other recurrent frequency that occurs on your DUT.</p> <p>Only available if you have installed the DVM option, which is available when you register your instrument with Tektronix.</p>

### SENT serial bus trigger settings panel

Field or control	Description
<b>Source</b>	Select the <b>SENT</b> bus on which to trigger.
<b>Trigger On</b>	Select the type of information on which to trigger.
<b>Channel</b>	<p>Sets the SENT channel type on which to trigger.</p> <p>Available when <b>Trigger On = Start of Packet</b>.</p>
<b>Status / Communications</b>	<p>Sets the value of the status/communications nibble on which to trigger.</p> <p>Tap the <b>Binary</b> or <b>Hex</b> field and use the <b>A</b> and <b>B</b> knobs to select and change the values. Or double-tap on the field and use the virtual keypad to enter values.</p> <p>Available when <b>Trigger On = Fast Channel</b>.</p>
<b>Fast Channel 1</b>	<p>Sets the condition and value of the fast channel 1 data on which to trigger.</p> <p>Tap the down arrow and select the condition on which to trigger (=, ≠, &gt;, &lt;, ≥, ≤). The default is =.</p> <p>Tap the <b>Binary</b> or <b>Hex</b> field and use the <b>A</b> and <b>B</b> knobs to select and change the values. Or double-tap on the field and use the virtual keypad to enter values.</p> <p>Available when <b>Trigger On = Fast Channel</b>.</p>

Table continued...

Field or control	Description
<b>Fast Channel 2</b>	<p>Sets the condition and value of the fast channel 2 data on which to trigger.</p> <p>Tap the down arrow and select the condition on which to trigger (=, ≠, &gt;, &lt;, ≥, ≤). The default is =.</p> <p>Tap the <b>Binary</b> or <b>Hex</b> field and use the <b>A</b> and <b>B</b> knobs to select and change the values. Or double-tap on the field and use the virtual keypad to enter values.</p> <p>Available when <b>Trigger On = Fast Channel</b>.</p>
<b>Counter</b>	<p>Sets the condition and value of the counter data on which to trigger.</p> <p>Tap the down arrow and select the condition on which to trigger (=, ≠, &gt;, &lt;, ≥, ≤). The default is =.</p> <p>Tap the <b>Binary</b> or <b>Hex</b> field and use the <b>A</b> and <b>B</b> knobs to select and change the values. Or double-tap on the field and use the virtual keypad to enter values.</p> <p>Available when <b>Trigger On = Fast Channel</b>.</p>
<b>Inverted Nibble</b>	<p>Sets the value of the inverted nibble data on which to trigger.</p> <p>Tap the <b>Binary</b> or <b>Hex</b> field and use the <b>A</b> and <b>B</b> knobs to select and change the values. Or double-tap on the field and use the virtual keypad to enter values.</p> <p>Available when <b>Trigger On = Fast Channel</b> and the bus is set up for <b>1</b> fast data channel and Data Nibbles is set to <b>6 Secure</b>.</p>
<b>Message ID</b>	<p>Sets the value of the message ID data on which to trigger.</p> <p>Available when <b>Trigger On = Slow Channel</b>.</p>
<b>Data</b>	<p>Sets the condition and value of the slow channel data on which to trigger.</p> <p>Tap the down arrow and select the condition on which to trigger (=, ≠, &gt;, &lt;, ≥, ≤). The default is =.</p> <p>Tap the <b>Binary</b> or <b>Hex</b> field and use the <b>A</b> and <b>B</b> knobs to select and change the values. Or double-tap on the field and use the virtual keypad to enter values.</p> <p>Available when <b>Trigger On = Slow Channel</b>.</p>
<b>Trigger When</b>	<p>Sets the trigger when condition.</p> <p>Tap the down arrow and select the condition on which to trigger (=, ≠, &gt;, &lt;, ≥, ≤, <b>Inside Range</b>, <b>Outside Range</b>). The default is =.</p> <p>When set to <b>Inside Range</b> or <b>Outside Range</b>, fields are displayed to set high and low boundary values for the number of clock ticks on which to trigger.</p> <p>Available when <b>Trigger On = Pause Pulse</b>.</p>
<b>Number of Ticks</b>	<p>Sets the number of Pause Pulse ticks on which to trigger.</p> <p>Tap the <b>Ticks High</b> or <b>Tick Low</b> field and use the <b>A</b> and <b>B</b> knobs to set the values.</p> <p>Available when <b>Trigger On = Pause Pulse</b> and <b>Trigger When</b> is set to =, ≠, &gt;, &lt;, ≥, or ≤.</p>
<b>Ticks High, Ticks Low)</b>	<p>Sets the highest and lowest range of the number of Pause Pulse ticks on which to trigger.</p> <p>Tap the <b>Ticks High</b> or <b>Tick Low</b> field and use the <b>A</b> and <b>B</b> knobs to set the values.</p> <p>Available when <b>Trigger On = Pause Pulse</b> and <b>Trigger When = Inside Range</b> or <b>Outside Range</b>.</p>

Table continued...

Field or control	Description
<b>Error Type</b>	Sets the error type on which to trigger. Tap the arrow and select the error condition. Available when <b>Trigger On = Error</b> .
<b>CRC Type</b>	Sets the CRC error type on which to trigger ( <b>Fast Channel</b> or <b>Slow Channel</b> ). Available when <b>Trigger On = Error</b> and <b>Error Type = CRC</b> .

### Mode & Holdoff panel (Bus Trigger configuration panel) fields and controls

Field or control	Description
<b>Trigger Mode</b>	The trigger mode determines how the instrument behaves in the absence or presence of a trigger event:  <b>Auto</b> trigger mode enables the instrument to acquire and display a waveform even if a trigger does not occur. Auto mode uses a timer that starts when the acquisition is started, and the pretrigger information is obtained. If a trigger event is not detected before the timer times out, the instrument forces a trigger. The length of time it waits for a trigger event depends on the time base setting.  When forcing triggers in the absence of valid triggering events, Auto mode does not synchronize the waveform on the display. The waveform will appear to jump across the screen.  If valid triggers occur, the display will become stable.  <b>Normal</b> trigger mode enables the instrument to acquire a waveform only when it is triggered. If no trigger occurs, the last waveform record acquired remains on the display. If no last waveform exists, no waveform is displayed.
<b>Force Trigger</b>	Forces a trigger event regardless of whether the waveform meets any trigger conditions.
<b>Holdoff</b>	Trigger holdoff sets the amount of time the oscilloscope waits after a trigger event before detecting and triggering on the next trigger event.  <b>Random</b> sets the instrument to wait for a random amount of time before recognizing another trigger event. This means that successive acquisitions are unrelated to the previous trigger signal.  <b>Time</b> sets the instrument to wait the specified time before recognizing another trigger event. Use this option when the signal that you want to trigger on has several possible trigger points or is a burst signal.
<b>Holdoff Time</b>	Tap the <b>Holdoff Time</b> field and use the multipurpose knob to adjust the holdoff time value. Or double-tap the field and use the virtual keypad to enter a time holdoff period.
<b>Act on Trigger</b>	Tap the <b>Act on Trigger</b> button to configure the actions the instrument must take when a trigger event occurs.  See <a href="#">Act On Event configuration menu</a> on page 178 for the available fields and controls.
<b>Trigger Frequency Counter</b>	Turn <b>On</b> to display the trigger event frequency in the <b>Trigger</b> badge.  The trigger frequency can help you troubleshoot signal problems where the frequency of the trigger event may be related to a clock, switching power supply, or other recurrent frequency that occurs on your DUT.  Only available if you have installed the DVM option, which is available when you register your instrument with Tektronix.

### SPI serial bus trigger settings panel

Field or control	Description
<b>Source</b>	Select the <b>SPI</b> bus on which you want to trigger.
<b>Trigger On</b>	Select the type of information on which to trigger.
<b>Data Words</b>	<p>Sets the number of data words (1 word = 8 bits) on which to trigger (one to sixteen bytes). Use the <b>A</b> knob to change the value.</p> <p>Available when <b>Trigger On = Data</b>.</p>
<b>Data</b>	<p>Sets the data pattern on which to trigger. The number of bits shown depends on the <b>Data Words</b> setting.</p> <p>Tap the <b>Binary</b> or <b>Hex</b> field and use the <b>A</b> and <b>B</b> knobs to select and change the values. Or double-tap on the field and use the virtual keypad to enter values.</p> <p>Available when <b>Trigger On = Data</b>.</p>
<b>A, B knob controls</b>	<p>Use the <b>A</b> knob to select (highlight) the digit(s) to change.</p> <p>Use the <b>B</b> knob to change the value of the digit(s).</p>

### Mode & Holdoff panel (Bus Trigger configuration panel) fields and controls

Field or control	Description
<b>Trigger Mode</b>	<p>The trigger mode determines how the instrument behaves in the absence or presence of a trigger event:</p> <p><b>Auto</b> trigger mode enables the instrument to acquire and display a waveform even if a trigger does not occur. Auto mode uses a timer that starts when the acquisition is started, and the pretrigger information is obtained. If a trigger event is not detected before the timer times out, the instrument forces a trigger. The length of time it waits for a trigger event depends on the time base setting.</p> <p>When forcing triggers in the absence of valid triggering events, Auto mode does not synchronize the waveform on the display. The waveform will appear to jump across the screen.</p> <p>If valid triggers occur, the display will become stable.</p> <p><b>Normal</b> trigger mode enables the instrument to acquire a waveform only when it is triggered. If no trigger occurs, the last waveform record acquired remains on the display. If no last waveform exists, no waveform is displayed.</p>
<b>Force Trigger</b>	Forces a trigger event regardless of whether the waveform meets any trigger conditions.
<b>Holdoff</b>	<p>Trigger holdoff sets the amount of time the oscilloscope waits after a trigger event before detecting and triggering on the next trigger event.</p> <p><b>Random</b> sets the instrument to wait for a random amount of time before recognizing another trigger event. This means that successive acquisitions are unrelated to the previous trigger signal.</p> <p><b>Time</b> sets the instrument to wait the specified time before recognizing another trigger event. Use this option when the signal that you want to trigger on has several possible trigger points or is a burst signal.</p>
<b>Holdoff Time</b>	Tap the <b>Holdoff Time</b> field and use the multipurpose knob to adjust the holdoff time value. Or double-tap the field and use the virtual keypad to enter a time holdoff period.

Table continued...



Field or control	Description
<b>Act on Trigger</b>	<p>Tap the <b>Act on Trigger</b> button to configure the actions the instrument must take when a trigger event occurs.</p> <p>See <a href="#">Act On Event configuration menu</a> on page 178 for the available fields and controls.</p>
<b>Trigger Frequency Counter</b>	<p>Turn <b>On</b> to display the trigger event frequency in the <b>Trigger</b> badge.</p> <p>The trigger frequency can help you troubleshoot signal problems where the frequency of the trigger event may be related to a clock, switching power supply, or other recurrent frequency that occurs on your DUT.</p> <p>Only available if you have installed the DVM option, which is available when you register your instrument with Tektronix.</p>

### SPMI serial bus trigger settings panel

Field or control	Description
<b>Source</b>	Select the <b>SPMI</b> bus on which to trigger.
<b>Trigger On</b>	Select the type of information on which to trigger.
<b>Slave Address</b>	<p>Sets the slave address value on which to trigger.</p> <p>Tap the <b>Binary</b> or <b>Hex</b> field and use the <b>A</b> and <b>B</b> knobs to select and change the values. Or double-tap on the field and use the virtual keypad to enter values.</p> <p>Available when <b>Trigger On</b> = <b>Reset, Authenticate, Register Read, Register Write, Extended Register Read, Extended Register Write, Ext. Register Read Long, Ext. Register Write Long, DD Block Slave Read, or Register 0 Write.</b></p>
<b>Authenticate</b>	<p>Sets the authentication condition on which to trigger.</p> <p>Available when <b>Trigger On</b> = <b>Authenticate.</b></p>
<b>Master Address</b>	<p>Sets the master address value on which to trigger.</p> <p>Tap the <b>Binary</b> or <b>Hex</b> field and use the <b>A</b> and <b>B</b> knobs to select and change the values. Or double-tap on the field and use the virtual keypad to enter values.</p> <p>Available when <b>Trigger On</b> = <b>Master Read, Master Write, or DD Block Master Read.</b></p>
<b>Register Address</b>	<p>Sets the register address value on which to trigger.</p> <p>Tap the <b>Binary</b> or <b>Hex</b> field and use the <b>A</b> and <b>B</b> knobs to select and change the values. Or double-tap on the field and use the virtual keypad to enter values.</p> <p>Available when <b>Trigger On</b> = <b>Master Read, Master Write, Register Read, Register Write, Extended Register Read, Extended Register Write, Ext. Register Read Long, or Ext. Register Write Long.</b></p>
<b>Data</b>	<p>Sets the data value on which to trigger.</p> <p>Tap the <b>Binary</b> or <b>Hex</b> field and use the <b>A</b> and <b>B</b> knobs to select and change the values. Or double-tap on the field and use the virtual keypad to enter values.</p> <p>Available when <b>Trigger On</b> = <b>Master Read, Master Write, Register Read, Register Write, Extended Register Read, Extended Register Write, Ext. Register Read Long, Ext. Register Write Long, DD Block Master Read, DD Block Slave Read, or Register 0 Write.</b></p>

Table continued...

Field or control	Description
<b>Data Bytes</b>	<p>Sets the number of data bytes on which to trigger. Tap the field and use the <b>A</b> knob to change the value. Or double-tap on the field and use the virtual keypad to enter a value.</p> <p>Available when <b>Trigger On = Extended Register Read, Extended Register Write, Ext. Register Read Long, or Ext. Register Write Long.</b></p>
<b>No Response</b>	<p>Sets to trigger on data that is all zeros (no response). All values in the Data field are set to zero and cannot be edited.</p> <p>Available when <b>Trigger On = Master Read, Register Read, Extended Register Read, Ext. Register Read Long, DD Block Master Read, DD Block Slave Read, or Transfer Bus Ownership.</b></p>

### Mode & Holdoff panel (Bus Trigger configuration panel) fields and controls

Field or control	Description
<b>Trigger Mode</b>	<p>The trigger mode determines how the instrument behaves in the absence or presence of a trigger event:</p> <p><b>Auto</b> trigger mode enables the instrument to acquire and display a waveform even if a trigger does not occur. Auto mode uses a timer that starts when the acquisition is started, and the pretrigger information is obtained. If a trigger event is not detected before the timer times out, the instrument forces a trigger. The length of time it waits for a trigger event depends on the time base setting.</p> <p>When forcing triggers in the absence of valid triggering events, Auto mode does not synchronize the waveform on the display. The waveform will appear to jump across the screen.</p> <p>If valid triggers occur, the display will become stable.</p> <p><b>Normal</b> trigger mode enables the instrument to acquire a waveform only when it is triggered. If no trigger occurs, the last waveform record acquired remains on the display. If no last waveform exists, no waveform is displayed.</p>
<b>Force Trigger</b>	<p>Forces a trigger event regardless of whether the waveform meets any trigger conditions.</p>
<b>Holdoff</b>	<p>Trigger holdoff sets the amount of time the oscilloscope waits after a trigger event before detecting and triggering on the next trigger event.</p> <p><b>Random</b> sets the instrument to wait for a random amount of time before recognizing another trigger event. This means that successive acquisitions are unrelated to the previous trigger signal.</p> <p><b>Time</b> sets the instrument to wait the specified time before recognizing another trigger event. Use this option when the signal that you want to trigger on has several possible trigger points or is a burst signal.</p>
<b>Holdoff Time</b>	<p>Tap the <b>Holdoff Time</b> field and use the multipurpose knob to adjust the holdoff time value. Or double-tap the field and use the virtual keypad to enter a time holdoff period.</p>
<b>Act on Trigger</b>	<p>Tap the <b>Act on Trigger</b> button to configure the actions the instrument must take when a trigger event occurs.</p> <p>See <a href="#">Act On Event configuration menu</a> on page 178 for the available fields and controls.</p>

Table continued...

Field or control	Description
Trigger Frequency Counter	<p>Turn <b>On</b> to display the trigger event frequency in the <b>Trigger</b> badge.</p> <p>The trigger frequency can help you troubleshoot signal problems where the frequency of the trigger event may be related to a clock, switching power supply, or other recurrent frequency that occurs on your DUT.</p> <p>Only available if you have installed the DVM option, which is available when you register your instrument with Tektronix.</p>

### SVID serial bus trigger settings panel

Field or control	Description
Source	Select the SVID bus on which to trigger.
Trigger On	Select the type of information on which to trigger.
Start	Sets the trigger on start.
Slave Address	<p>Sets the slave address value on which to trigger.</p> <p>Tap the <b>Binary</b> or <b>Hex</b> field and use the <b>A</b> and <b>B</b> knobs to select and change the values. Or double-tap on the field and use the virtual keypad to enter values.</p> <p>Available when <b>Trigger On</b> is <b>Slave Address</b>.</p>
Command Type	<p>Sets the <b>Command</b> events on which to trigger. Default command type is <b>Get</b>.</p> <p>Available Command Types are <b>Get</b>, <b>Set</b>, and <b>Optional</b>.</p> <p>Available when <b>Trigger On</b> is <b>Command</b>.</p>
Command Response	<p>Sets the command response on which to trigger.</p> <p>Available when <b>Trigger On</b> is <b>Command</b>.</p> <p>Following are the available command responses when <b>Version</b> is set to <b>Non VR14</b> in <a href="#">SVID serial bus configuration menu</a>.</p> <ul style="list-style-type: none"> <li>For <b>Get</b>: GetReg.</li> <li>For <b>Set</b>: SetVID Fast, SetVID Slow, SetVID Decay, SetPS, SetRegAddr, and SetRegData. Default value is SetVID Fast.</li> <li>For <b>Optional</b>: Test Mode and SetWP. Default value is Test Mode.</li> </ul> <p>Following are the available command responses when <b>Version</b> is set to <b>VR14</b> in <a href="#">SVID serial bus configuration menu</a>.</p> <ul style="list-style-type: none"> <li>For <b>Get</b>: GetReg, GetRegVendor, GetRegTestCfg, GetRegPktRecent, GetRegPktAlert, GetRegPktBad, and GetRegVrEvent. Default value is GetReg.</li> <li>For <b>Set</b>: SetVID Fast, SetVID Slow, SetVID Decay, SetPS, SetRegAddr, SetRegData, SetRegAddrVendor, SetRegDataVendor, SetRegAddrTestCfg, and SetRegDataTestCfg. Default value is SetVID Fast.</li> <li>For <b>Optional</b>: Test Mode and SetWP. Default value is Test Mode.</li> </ul>
Mode	<p>Sets the mode on which to trigger. Available modes are <b>Master</b> and <b>Slave</b>. Default mode is <b>Master</b>.</p> <p>Available when <b>Trigger On</b> is <b>Payload</b>.</p>

Table continued...

Field or control	Description
<b>Data</b>	<p>Sets the data on which to trigger for different modes.</p> <p>Tap the <b>Binary</b> or <b>Hex</b> field and use the <b>A</b> and <b>B</b> knobs to select and change the values. Or double-tap on the field and use the virtual keypad to enter values.</p> <p>Available when <b>Trigger On</b> is <b>Payload</b>.</p>
<b>Error Type</b>	<p>Set the error type from the drop down. Available error types are NACK, Reject, Mixed, and Parity. Default error type is NACK.</p> <p>Available when <b>Trigger On</b> is <b>Errors</b>.</p>
<b>Direction</b>	<p>Sets the direction as <b>Master</b> or <b>Slave</b> on which to trigger. Default direction is Master. Available when <b>Trigger On</b> is <b>Errors</b> and <b>Error Type</b> is <b>Parity</b></p>

**Mode & Holdoff panel (Bus Trigger configuration panel) fields and controls**

Field or control	Description
<b>Trigger Mode</b>	<p>The trigger mode determines how the instrument behaves in the absence or presence of a trigger event:</p> <p><b>Auto</b> trigger mode enables the instrument to acquire and display a waveform even if a trigger does not occur. Auto mode uses a timer that starts when the acquisition is started, and the pretrigger information is obtained. If a trigger event is not detected before the timer times out, the instrument forces a trigger. The length of time it waits for a trigger event depends on the time base setting.</p> <p>When forcing triggers in the absence of valid triggering events, Auto mode does not synchronize the waveform on the display. The waveform will appear to jump across the screen.</p> <p>If valid triggers occur, the display will become stable.</p> <p><b>Normal</b> trigger mode enables the instrument to acquire a waveform only when it is triggered. If no trigger occurs, the last waveform record acquired remains on the display. If no last waveform exists, no waveform is displayed.</p>
<b>Force Trigger</b>	<p>Forces a trigger event regardless of whether the waveform meets any trigger conditions.</p>
<b>Holdoff</b>	<p>Trigger holdoff sets the amount of time the oscilloscope waits after a trigger event before detecting and triggering on the next trigger event.</p> <p><b>Random</b> sets the instrument to wait for a random amount of time before recognizing another trigger event. This means that successive acquisitions are unrelated to the previous trigger signal.</p> <p><b>Time</b> sets the instrument to wait the specified time before recognizing another trigger event. Use this option when the signal that you want to trigger on has several possible trigger points or is a burst signal.</p>
<b>Holdoff Time</b>	<p>Tap the <b>Holdoff Time</b> field and use the multipurpose knob to adjust the holdoff time value. Or double-tap the field and use the virtual keypad to enter a time holdoff period.</p>
<b>Act on Trigger</b>	<p>Tap the <b>Act on Trigger</b> button to configure the actions the instrument must take when a trigger event occurs.</p> <p>See <a href="#">Act On Event configuration menu</a> on page 178 for the available fields and controls.</p>

Table continued...

Field or control	Description
Trigger Frequency Counter	<p>Turn <b>On</b> to display the trigger event frequency in the <b>Trigger</b> badge.</p> <p>The trigger frequency can help you troubleshoot signal problems where the frequency of the trigger event may be related to a clock, switching power supply, or other recurrent frequency that occurs on your DUT.</p> <p>Only available if you have installed the DVM option, which is available when you register your instrument with Tektronix.</p>

### USB serial bus trigger settings panel

Field or control	Description
Source	Select the <b>USB</b> bus on which to trigger.
Trigger On	Select the type of information on which to trigger.
Handshake Type	<p>Sets the handshake packet type on which to trigger.</p> <p>Available when <b>Trigger On = Handshake Packet</b>.</p>
Packet Type	<p>Sets the special packet type on which to trigger.</p> <p>Available when <b>Trigger On = Special Packet</b>.</p>
Error Type	<p>Sets the error type on which to trigger.</p> <p>Available when <b>Trigger On = Error</b>.</p>
Address	<p>Sets the token packet address pattern on which to trigger. Use in conjunction with the <b>Trigger When</b> field to specify the exact trigger condition.</p> <p>Tap the <b>Binary</b>, <b>Hex</b>, or <b>Decimal</b> field and use the A and B knobs to select and change the values. Or double-tap on the field and use the virtual keypad to enter values.</p> <p>Available when <b>Trigger On = Token Packet</b> and <b>Token Type = all except SOF (0101)</b>.</p>
Address Low, Address High	<p>Sets the boundary address conditions when testing for in-range or out of range conditions.</p> <p>Available when <b>Trigger On = Token Packet</b> and <b>Trigger When = Inside Range</b> or <b>Outside Range</b>.</p>
Data Low, Data High	<p>Sets the boundary data conditions when testing for in-range or out of range conditions.</p> <p>Available when <b>Trigger On = Data Packet</b> and <b>Trigger When = Inside Range</b> or <b>Outside Range</b>.</p>
Token Type	<p>Sets the token packet type on which to trigger.</p> <p>Available when <b>Trigger On = Token Packet</b>.</p>
Endpoint	<p>Sets the token packet endpoint pattern on which to trigger. Use in conjunction with the <b>Trigger When</b> field to specify the exact trigger condition.</p> <p>Tap the <b>Binary</b>, <b>Hex</b>, or <b>Decimal</b> field and use the <b>A</b> and <b>B</b> knobs to select and change the values. Or double-tap on the field and use the virtual keypad to enter values.</p> <p>Available when <b>Trigger On = Token Packet</b> and <b>Token Type = all except SOF (0101)</b>.</p>

Table continued...

Field or control	Description
<b>Frame Number</b>	<p>Sets the frame number pattern on which to trigger. Use in conjunction with the <b>Trigger When</b> field to specify the exact trigger condition.</p> <p>Tap the <b>Binary</b>, <b>Hex</b>, or <b>Decimal</b> field and use the <b>A</b> and <b>B</b> knobs to select and change the values. Or double-tap on the field and use the virtual keypad to enter values.</p> <p>Available when <b>Trigger On = Token Packet</b> and <b>Token Type = SOF (0101)</b>.</p>
<b>Data Packet Type</b>	<p>Sets the data packet type on which to trigger.</p> <p>Available when <b>Trigger On = Data Packet</b>.</p>
<b>Data Bytes</b>	<p>Sets the number of data bytes on which to trigger (one to two bytes). Tap the field and use the <b>A</b> knob to change the value.</p> <p>Available when <b>Trigger On = Data Packet</b>.</p>
<b>Byte Offset</b>	<p>Sets the byte offset (<b>Don't Care</b> or the number of bytes). Tap the field and use the <b>A</b> knob to change the value.</p> <p>Available when <b>Trigger On = Data Packet</b>.</p>
<b>Data</b>	<p>Sets the data packet pattern on which to trigger. The number of bits shown depends on the <b>Data Bytes</b> setting. Use in conjunction with the <b>Trigger When</b> field to specify the exact trigger condition.</p> <p>Tap the <b>Binary</b>, <b>Hex</b>, or <b>ASCII</b> field and use the <b>A</b> and <b>B</b> knobs to select and change the values. Or double-tap on the field and use the virtual keypad to enter values.</p> <p>Available when <b>Trigger On = Data Packet</b> and <b>Trigger When = anything but Inside Range or Outside Range</b>.</p>
<b>Trigger When</b>	<p>Sets the trigger when condition.</p> <p>When set to <b>Inside Range</b> or <b>Outside Range</b>, fields are displayed to set a high and low boundary pattern for the specified trigger type.</p> <p>Tap the <b>Binary</b> or <b>Hex</b> field and use the <b>A</b> and <b>B</b> knobs to select and change the values. Or double-tap on the field and use the virtual keypad to enter values.</p> <p>Available when <b>Trigger On = Token Packet</b> or <b>Data Packet</b>.</p>
<b>A, B knob controls</b>	<p>Use the <b>A</b> knob to select (highlight) the digit(s) to change.</p> <p>Use the <b>B</b> knob to change the value of the digit(s).</p>

## Mode & Holdoff panel (Bus Trigger configuration panel) fields and controls

Field or control	Description
<b>Trigger Mode</b>	<p>The trigger mode determines how the instrument behaves in the absence or presence of a trigger event:</p> <p><b>Auto</b> trigger mode enables the instrument to acquire and display a waveform even if a trigger does not occur. Auto mode uses a timer that starts when the acquisition is started, and the pretrigger information is obtained. If a trigger event is not detected before the timer times out, the instrument forces a trigger. The length of time it waits for a trigger event depends on the time base setting.</p> <p>When forcing triggers in the absence of valid triggering events, Auto mode does not synchronize the waveform on the display. The waveform will appear to jump across the screen.</p> <p>If valid triggers occur, the display will become stable.</p> <p><b>Normal</b> trigger mode enables the instrument to acquire a waveform only when it is triggered. If no trigger occurs, the last waveform record acquired remains on the display. If no last waveform exists, no waveform is displayed.</p>
<b>Force Trigger</b>	Forces a trigger event regardless of whether the waveform meets any trigger conditions.
<b>Holdoff</b>	<p>Trigger holdoff sets the amount of time the oscilloscope waits after a trigger event before detecting and triggering on the next trigger event.</p> <p><b>Random</b> sets the instrument to wait for a random amount of time before recognizing another trigger event. This means that successive acquisitions are unrelated to the previous trigger signal.</p> <p><b>Time</b> sets the instrument to wait the specified time before recognizing another trigger event. Use this option when the signal that you want to trigger on has several possible trigger points or is a burst signal.</p>
<b>Holdoff Time</b>	Tap the <b>Holdoff Time</b> field and use the multipurpose knob to adjust the holdoff time value. Or double-tap the field and use the virtual keypad to enter a time holdoff period.
<b>Act on Trigger</b>	<p>Tap the <b>Act on Trigger</b> button to configure the actions the instrument must take when a trigger event occurs.</p> <p>See <a href="#">Act On Event configuration menu</a> on page 178 for the available fields and controls.</p>
<b>Trigger Frequency Counter</b>	<p>Turn <b>On</b> to display the trigger event frequency in the <b>Trigger</b> badge.</p> <p>The trigger frequency can help you troubleshoot signal problems where the frequency of the trigger event may be related to a clock, switching power supply, or other recurrent frequency that occurs on your DUT.</p> <p>Only available if you have installed the DVM option, which is available when you register your instrument with Tektronix.</p>

## Logic Trigger configuration menu

Use the Logic trigger to trigger the oscilloscope when the specified logic conditions occur on any combination of analog and digital inputs. The logic conditions include the state of each input, the condition to test (inputs go true, false, or are within a time limit), and the Boolean function of the inputs.

To open the Logic Trigger menu:

1. Double-tap the **Trigger** badge on the Settings bar.

2. Set the **Trigger Type** to **Logic**.

**Settings panel (Logic Trigger configuration menu) - fields and controls**

Field or control	Description
<b>Use Clock Edge?</b>	Enables or disables finding logic patterns that occur on the specified clock edge.
<b>Logic Pattern Define Inputs</b>	Opens the <b>Logic Trigger - Define Inputs</b> menu where you define the logic state ( <b>High</b> , <b>Low</b> , or <b>Don't Care</b> ), and the signal threshold level that defines the logic state (high or low), for each analog or digital signal. See <a href="#">Logic Trigger - Define Inputs configuration menu</a> on page 598.
<b>Trigger When</b> (Use Clock Edge = No)	<p>Defines the waveform condition on which to trigger.</p> <ul style="list-style-type: none"> <li>• <b>Goes True</b>: All conditions change to a true state.</li> <li>• <b>Goes False</b>: All conditions change to a false state.</li> <li>• <b>Is True &gt; Limit</b>: Condition remains true longer than a specified time.</li> <li>• <b>Is True &lt; Limit</b>: Condition remains true for less than a specified time.</li> <li>• <b>Is True = Limit</b>: Condition remains true for a specified time (within <math>\pm 5\%</math>).</li> <li>• <b>Is True <math>\neq</math> Limit</b>: Condition does not remain true for a specified time (within <math>\pm 5\%</math>).</li> </ul>
<b>Clock Source</b> (Use Clock Edge = Yes)	Sets the signal to use as the clock. The clock signal can be a digital, analog, or math waveform.
<b>Clock Edge</b> (Use Clock Edge = Yes)	Sets the signal transition edge (rising, falling, or either) for evaluating the logic condition at that clock transition.
<b>Clock Threshold</b> (Use Clock Edge = Yes)	Sets the threshold level that the clock signal must pass through to be considered a valid transition. The clock threshold value is independent of the input signal threshold(s).
<b>Define Logic</b>	<p>Sets the logic condition that must occur with all inputs to cause a trigger event.</p> <p>Sets the logic condition that must occur with all inputs.</p> <ul style="list-style-type: none"> <li>• <b>AND</b>: All conditions are true.</li> <li>• <b>OR</b>: Any condition is true.</li> <li>• <b>NAND</b>: One or more conditions are true.</li> <li>• <b>NOR</b>: No conditions are true.</li> </ul>



## Mode & Holdoff panel (Logic Trigger configuration menu) - fields and controls

Field or control	Description
<b>Trigger Mode</b>	<p>The trigger mode determines how the instrument behaves in the absence or presence of a trigger event:</p> <p><b>Auto</b> trigger mode enables the instrument to acquire and display a waveform even if a trigger does not occur. Auto mode uses a timer that starts when the acquisition is started, and the pretrigger information is obtained. If a trigger event is not detected before the timer times out, the instrument forces a trigger. The length of time it waits for a trigger event depends on the time base setting.</p> <p>When forcing triggers in the absence of valid triggering events, Auto mode does not synchronize the waveform on the display. The waveform will appear to jump across the screen.</p> <p>If valid triggers occur, the display will become stable.</p> <p><b>Normal</b> trigger mode enables the instrument to acquire a waveform only when it is triggered. If no trigger occurs, the last waveform record acquired remains on the display. If no last waveform exists, no waveform is displayed.</p>
<b>Force Trigger</b>	Forces a trigger event regardless of whether the waveform meets any trigger conditions.
<b>Holdoff</b>	<p>Trigger holdoff sets the amount of time the oscilloscope waits after a trigger event before detecting and triggering on the next trigger event.</p> <p><b>Random</b> sets the instrument to wait for a random amount of time before recognizing another trigger event. This means that successive acquisitions are unrelated to the previous trigger signal.</p> <p><b>Time</b> sets the instrument to wait the specified time before recognizing another trigger event. Use this option when the signal that you want to trigger on has several possible trigger points or is a burst signal.</p>
<b>Holdoff Time</b>	Tap the <b>Holdoff Time</b> field and use the multipurpose knob to adjust the holdoff time value. Or double-tap the field and use the virtual keypad to enter a time holdoff period.
<b>Act on Trigger</b>	<p>Tap the <b>Act on Trigger</b> button to configure the actions the instrument must take when a trigger event occurs.</p> <p>See <a href="#">Act On Event configuration menu</a> on page 178 for the available fields and controls.</p>
<b>Trigger Frequency Counter</b>	<p>Turn <b>On</b> to display the trigger event frequency in the <b>Trigger</b> badge.</p> <p>The trigger frequency can help you troubleshoot signal problems where the frequency of the trigger event may be related to a clock, switching power supply, or other recurrent frequency that occurs on your DUT.</p> <p>Only available if you have installed the DVM option, which is available when you register your instrument with Tektronix.</p>

### Other trigger types

- [Bus Trigger Menu](#)
- [Edge Trigger menu](#)
- [Pulse Width Trigger menu](#)
- [Rise Fall Time Trigger menu](#)
- [Runt Trigger menu](#)
- [Sequence Trigger menu](#)
- [Setup and Hold Trigger menu](#)

- [Timeout Trigger menu](#)
- [Window Trigger menu](#)

## Logic Trigger - Define Inputs configuration menu

Use this menu to set the signal sources, logic states, and threshold levels to use for the Logic trigger.

To open the Logic Trigger - Define Inputs configuration menu:

1. Double-tap the **Trigger** badge on the Settings bar.
2. Set **Trigger Type** to **Logic** (if it is not already set to this).
3. Tap the **Logic Pattern Define Inputs** button.

### Logic Trigger - Define Inputs configuration menu fields and controls

Field or control	Description
<b>Ch(x) (analog channels) or D(x) (digital Channels)</b>	Use to select the signal sources logic condition on which to perform the logic search ( <b>High, Low, Don't Care</b> ). Tap to select.  If a channel is a digital channel, tap the + symbol to open the list of digital inputs (D0-D7) from which to select individual logic conditions for the digital signals.  Use the <b>Threshold</b> field to set the signal level that must be exceeded for that signal to be true (logical 1).
<b>Set All</b>	Sets all signal sources to detect a logic <b>High, Low, or Don't Care</b> condition.

## Pulse Width Trigger configuration menu

Use the Pulse Width Trigger to trigger on specific pulse width conditions, including when a pulse width is within or outside a range of specified times. Pulse Width triggers are often used to troubleshoot digital signals.

To open the Pulse Width trigger configuration menu:

1. Double-tap the **Trigger** badge on the Settings bar.
2. Set the **Trigger Type** to **Pulse Width**.

### Settings panel (Pulse Width Trigger configuration menu) fields and controls

Field or control	Description
<b>Source</b>	Lists the source channel. Lists the source channel or waveform to use to trigger or search. Types that require multiple inputs will replace this control with a different source definition control.
<b>Trigger When</b>	<ul style="list-style-type: none"> <li>• <b>&lt; Limit:</b> A pulse width is less than the specified time limit.</li> <li>• <b>&gt; Limit:</b> A pulse width is greater than the specified time limit.</li> <li>• <b>= Limit:</b> A pulse width is equal to the specified time limit.</li> <li>• <b>≠ Limit:</b> A pulse width does not equal (is greater than or less than) the specified time limit.</li> <li>• <b>Inside Range:</b> A pulse width is in the specified time range.</li> <li>• <b>Outside Range:</b> A pulse width is outside of the specified time range.</li> </ul>
<b>Level</b>	Sets the amplitude level that the signal must pass through to be considered a valid transition.

Table continued...

Field or control	Description
<b>Set to 50%</b>	Sets the threshold at 50% of the measured signal transition range. 50% is calculated as (Top + Bottom)/2.
<b>Time Limit</b>	Sets the time period condition to be met.
<b>High Time Limit</b> (Trigger When = Inside Range or Outside Range)	Sets the longest acceptable pulse width time period for the range condition.
<b>Low Time Limit</b> (Trigger When = Inside Range or Outside Range)	Sets the shortest acceptable pulse width time period for the range condition.
<b>Polarity</b>	Sets the polarity of the pulse to detect (positive pulse only, negative pulse only, or a positive or negative pulse).
<b>Logic Qualification</b>	Set to On to enable logic qualification to further refine the trigger condition by setting the required logic conditions on the source signals to generate a trigger event.
<b>Define Inputs</b>	Opens the Logic Qualification - Define Inputs dialog. Use this dialog to set the logic state, threshold levels, and logic operation of the input signals. See <a href="#">Logic Qualification - Define Inputs configuration menu</a> on page 612.  Available when Logic Qualification = On.

### Mode & Holdoff panel (Pulse Width Trigger configuration menu) fields and controls

Field or control	Description
<b>Trigger Mode</b>	<p>The trigger mode determines how the instrument behaves in the absence or presence of a trigger event:</p> <p><b>Auto</b> trigger mode enables the instrument to acquire and display a waveform even if a trigger does not occur. Auto mode uses a timer that starts when the acquisition is started, and the pretrigger information is obtained. If a trigger event is not detected before the timer times out, the instrument forces a trigger. The length of time it waits for a trigger event depends on the time base setting.</p> <p>When forcing triggers in the absence of valid triggering events, Auto mode does not synchronize the waveform on the display. The waveform will appear to jump across the screen.</p> <p>If valid triggers occur, the display will become stable.</p> <p><b>Normal</b> trigger mode enables the instrument to acquire a waveform only when it is triggered. If no trigger occurs, the last waveform record acquired remains on the display. If no last waveform exists, no waveform is displayed.</p>
<b>Force Trigger</b>	Forces a trigger event regardless of whether the waveform meets any trigger conditions.

Table continued...

Field or control	Description
<b>Holdoff</b>	<p>Trigger holdoff sets the amount of time the oscilloscope waits after a trigger event before detecting and triggering on the next trigger event.</p> <p><b>Random</b> sets the instrument to wait for a random amount of time before recognizing another trigger event. This means that successive acquisitions are unrelated to the previous trigger signal.</p> <p><b>Time</b> sets the instrument to wait the specified time before recognizing another trigger event. Use this option when the signal that you want to trigger on has several possible trigger points or is a burst signal.</p>
<b>Holdoff Time</b>	<p>Tap the <b>Holdoff Time</b> field and use the multipurpose knob to adjust the holdoff time value. Or double-tap the field and use the virtual keypad to enter a time holdoff period.</p>
<b>Act on Trigger</b>	<p>Tap the <b>Act on Trigger</b> button to configure the actions the instrument must take when a trigger event occurs.</p> <p>See <a href="#">Act On Event configuration menu</a> on page 178 for the available fields and controls.</p>
<b>Trigger Frequency Counter</b>	<p>Turn <b>On</b> to display the trigger event frequency in the <b>Trigger</b> badge.</p> <p>The trigger frequency can help you troubleshoot signal problems where the frequency of the trigger event may be related to a clock, switching power supply, or other recurrent frequency that occurs on your DUT.</p> <p>Only available if you have installed the DVM option, which is available when you register your instrument with Tektronix.</p>

### Other trigger types

- [Bus Trigger Menu](#)
- [Edge Trigger menu](#)
- [Logic Trigger menu](#)
- [Rise Fall Time Trigger menu](#)
- [Runt Trigger menu](#)
- [Sequence Trigger menu](#)
- [Setup and Hold Trigger menu](#)
- [Timeout Trigger menu](#)
- [Window Trigger menu](#)

### Rise/Fall Time Trigger configuration menu

Use the Rise/Fall Time trigger to trigger when the rise or fall time of a signal is less than, greater than, equal to, or not equal to a specified time limit.

To open the Rise/Fall Time trigger configuration menu:

1. Double-tap the **Trigger** badge on the Settings bar.
2. Set the **Trigger Type** to **Rise/Fall Time**.

## Settings panel (Rise/Fall Time Trigger configuration menu) fields and controls

Field or control	Description
Source	Lists the source channel or waveform to use to trigger or search. Types that require multiple inputs will replace this control with a different source definition control.
Trigger When	<ul style="list-style-type: none"> <li>• <b>&lt; Limit:</b> A signal has a rise/fall time less than the specified time limit.</li> <li>• <b>&gt; Limit:</b> A signal has a rise/fall time greater than the specified time limit.</li> <li>• <b>= Limit:</b> A signal has a rise/fall time that is equal to the specified time limit (<math>\pm 5\%</math>).</li> <li>• <b><math>\neq</math> Limit:</b> A signal has a rise/fall time that does not equal (is greater than or less than) the specified time limit (<math>\pm 5\%</math>).</li> </ul>
Time Limit	Sets the time period condition to be met.
Slope	Sets the signal transition direction to detect. (rising, falling, or either direction).
Upper Threshold	Sets the upper amplitude level through which the signal must pass to be considered a valid transition.
Lower Threshold	Sets the lower amplitude level through which the signal must pass to be considered a valid transition.
Logic Qualification	When set to On enables logic qualification to further refine the trigger condition by setting the required logic conditions on the source signals to generate a trigger event.
Define Inputs	<p>Opens the <b>Logic Qualification - Define Inputs</b> configuration menu. Use this menu to set the logic state, threshold levels, and logic operation of the input signals. See <a href="#">Logic Qualification - Define Inputs configuration menu</a> on page 612.</p> <p>Available when <b>Logic Qualification</b> is On.</p>

## Mode & Holdoff panel (Rise/Fall Time Trigger configuration menu) fields and controls

Field or control	Description
Trigger Mode	<p>The trigger mode determines how the instrument behaves in the absence or presence of a trigger event:</p> <p><b>Auto</b> trigger mode enables the instrument to acquire and display a waveform even if a trigger does not occur. Auto mode uses a timer that starts when the acquisition is started, and the pretrigger information is obtained. If a trigger event is not detected before the timer times out, the instrument forces a trigger. The length of time it waits for a trigger event depends on the time base setting.</p> <p>When forcing triggers in the absence of valid triggering events, Auto mode does not synchronize the waveform on the display. The waveform will appear to jump across the screen.</p> <p>If valid triggers occur, the display will become stable.</p> <p><b>Normal</b> trigger mode enables the instrument to acquire a waveform only when it is triggered. If no trigger occurs, the last waveform record acquired remains on the display. If no last waveform exists, no waveform is displayed.</p>
Force Trigger	Forces a trigger event regardless of whether the waveform meets any trigger conditions.

Table continued...

Field or control	Description
<b>Holdoff</b>	<p>Trigger holdoff sets the amount of time the oscilloscope waits after a trigger event before detecting and triggering on the next trigger event.</p> <p><b>Random</b> sets the instrument to wait for a random amount of time before recognizing another trigger event. This means that successive acquisitions are unrelated to the previous trigger signal.</p> <p><b>Time</b> sets the instrument to wait the specified time before recognizing another trigger event. Use this option when the signal that you want to trigger on has several possible trigger points or is a burst signal.</p>
<b>Holdoff Time</b>	<p>Tap the <b>Holdoff Time</b> field and use the multipurpose knob to adjust the holdoff time value. Or double-tap the field and use the virtual keypad to enter a time holdoff period.</p>
<b>Act on Trigger</b>	<p>Tap the <b>Act on Trigger</b> button to configure the actions the instrument must take when a trigger event occurs.</p> <p>See <a href="#">Act On Event configuration menu</a> on page 178 for the available fields and controls.</p>
<b>Trigger Frequency Counter</b>	<p>Turn <b>On</b> to display the trigger event frequency in the <b>Trigger</b> badge.</p> <p>The trigger frequency can help you troubleshoot signal problems where the frequency of the trigger event may be related to a clock, switching power supply, or other recurrent frequency that occurs on your DUT.</p> <p>Only available if you have installed the DVM option, which is available when you register your instrument with Tektronix.</p>

## Other trigger types

- [Bus Trigger Menu](#)
- [Edge Trigger menu](#)
- [Logic Trigger menu](#)
- [Pulse Width Trigger menu](#)
- [Runt Trigger menu](#)
- [Sequence Trigger menu](#)
- [Setup and Hold Trigger menu](#)
- [Timeout Trigger menu](#)
- [Window Trigger menu](#)

## Runt Trigger configuration menu

Use the Runt trigger to trigger on waveforms where a short pulse crosses one threshold but fails to cross a second threshold before recrossing the first.

To open the Runt trigger configuration menu:

1. Double-tap the **Trigger** badge on the Settings bar.
2. Set the **Trigger Type** to **Runt**.

## Settings panel (Runt Trigger configuration menu) fields and controls

Field or control	Description
Source	Lists the source channel. Lists the source channel or waveform to use to trigger or search. Types that require multiple inputs will replace this control with a different source definition control.
Trigger When	<ul style="list-style-type: none"> <li>• <b>Occurs:</b> A runt signal event occurs.</li> <li>• <b>&lt; Limit:</b> A runt signal event occurs that has a pulse width less than the specified time limit.</li> <li>• <b>&gt; Limit:</b> A runt signal event occurs that has a pulse width greater than the specified time limit.</li> <li>• <b>= Limit:</b> A runt signal event occurs that has a pulse width that is equal to the specified time limit (<math>\pm 5\%</math>).</li> <li>• <b><math>\neq</math> Limit:</b> A runt signal event occurs that has a pulse width that does not equal (is greater than or less than) the specified time limit (<math>\pm 5\%</math>).</li> </ul>
Polarity	Sets the polarity of the pulse to detect (positive pulse only, negative pulse only, or a positive or negative pulse).
Time Limit	Sets the time period condition to be met.
Upper Threshold	Sets the upper amplitude level through which the signal must pass to be considered a valid transition.
Lower Threshold	Sets the lower amplitude level through which the signal must pass to be considered a valid transition.
Logic Qualification	Set to On to enable logic qualification to further refine the trigger condition by setting the required logic conditions on the source signals to generate a trigger event.
Define Inputs	<p>Opens the <b>Logic Qualification - Define Inputs</b> configuration menu. Use this menu to set the logic state, threshold levels, and logic operation of the input signals. See <a href="#">Logic Qualification - Define Inputs configuration menu</a> on page 612.</p> <p>Available when Logic Qualification = On.</p>

## Mode & Holdoff panel (Runt Trigger configuration menu) fields and controls

Field or control	Description
Trigger Mode	<p>The trigger mode determines how the instrument behaves in the absence or presence of a trigger event:</p> <p><b>Auto</b> trigger mode enables the instrument to acquire and display a waveform even if a trigger does not occur. Auto mode uses a timer that starts when the acquisition is started, and the pretrigger information is obtained. If a trigger event is not detected before the timer times out, the instrument forces a trigger. The length of time it waits for a trigger event depends on the time base setting.</p> <p>When forcing triggers in the absence of valid triggering events, Auto mode does not synchronize the waveform on the display. The waveform will appear to jump across the screen.</p> <p>If valid triggers occur, the display will become stable.</p> <p><b>Normal</b> trigger mode enables the instrument to acquire a waveform only when it is triggered. If no trigger occurs, the last waveform record acquired remains on the display. If no last waveform exists, no waveform is displayed.</p>
Force Trigger	Forces a trigger event regardless of whether the waveform meets any trigger conditions.

Table continued...

Field or control	Description
<b>Holdoff</b>	<p>Trigger holdoff sets the amount of time the oscilloscope waits after a trigger event before detecting and triggering on the next trigger event.</p> <p><b>Random</b> sets the instrument to wait for a random amount of time before recognizing another trigger event. This means that successive acquisitions are unrelated to the previous trigger signal.</p> <p><b>Time</b> sets the instrument to wait the specified time before recognizing another trigger event. Use this option when the signal that you want to trigger on has several possible trigger points or is a burst signal.</p>
<b>Holdoff Time</b>	<p>Tap the <b>Holdoff Time</b> field and use the multipurpose knob to adjust the holdoff time value. Or double-tap the field and use the virtual keypad to enter a time holdoff period.</p>
<b>Act on Trigger</b>	<p>Tap the <b>Act on Trigger</b> button to configure the actions the instrument must take when a trigger event occurs.</p> <p>See <a href="#">Act On Event configuration menu</a> on page 178 for the available fields and controls.</p>
<b>Trigger Frequency Counter</b>	<p>Turn <b>On</b> to display the trigger event frequency in the <b>Trigger</b> badge.</p> <p>The trigger frequency can help you troubleshoot signal problems where the frequency of the trigger event may be related to a clock, switching power supply, or other recurrent frequency that occurs on your DUT.</p> <p>Only available if you have installed the DVM option, which is available when you register your instrument with Tektronix.</p>

## Other trigger types

- [Bus Trigger Menu](#)
- [Edge Trigger menu](#)
- [Logic Trigger menu](#)
- [Pulse Width Trigger menu](#)
- [Rise Fall Time Trigger menu](#)
- [Sequence Trigger menu](#)
- [Setup and Hold Trigger menu](#)
- [Timeout Trigger menu](#)
- [Window Trigger menu](#)

## Sequence Trigger configuration menu

Use Sequence triggers to trigger on a second (B) event after a first (A) event occurs. You can specify to trigger on the first occurrence of event B (with or without a time delay), or trigger after a specified number of B events occur.

To open the Sequence trigger configuration menu:

1. Double-tap the **Trigger** badge on the Settings bar.
2. Set the **Trigger Type** to **Sequence**.



## Settings panel (Sequence Trigger configuration menu) fields and controls

Field or control	Description
<b>A Trigger Event</b>	<p>Tap to open the <b>A Trigger Event</b> menu to select the first (A) event trigger condition. See <a href="#">A Trigger Event configuration menu</a> on page 606.</p> <p>If the A event does not occur, no trigger event is generated.</p> <p>The <b>Sequence</b> trigger type is not available in the A Trigger Event menu.</p>
<b>B Trigger Event</b>	<p>Tap to open the <b>B Trigger Event</b> menu to select the second (B) event trigger condition. See <a href="#">B Trigger Event configuration menu</a> on page 607.</p> <p>If the A event occurs but the B event does not occur, no trigger event is generated.</p> <p>The <b>Sequence</b> trigger type is not available in the B Trigger Event menu.</p>
<b>After the A Trigger Event is found: Trigger on the 1st B event</b>	Sets the oscilloscope to trigger on the first occurrence of the B event trigger conditions.
<b>After a Delay of:</b>	<p>Sets a time delay condition for the Trigger on 1st B event condition. The oscilloscope waits the specified time period after the A event before detecting and triggering on the B event condition.</p> <p>Available when After the A Trigger Event is found = Trigger on the 1st B event.</p>
<b>After the A Trigger Event is found: Trigger on the Nth B event</b>	Sets the B trigger event to wait for a specified number of trigger events before generating a trigger.
<b>Where N is:</b>	<p>Sets the number of B trigger events that must occur before triggering the oscilloscope.</p> <p>Available when After the A Trigger Event is found = Trigger on the Nth B event.</p>

## Mode & Holdoff panel (Sequence Trigger configuration menu) fields and controls

Field or control	Description
<b>Trigger Mode</b>	<p>The trigger mode determines how the instrument behaves in the absence or presence of a trigger event:</p> <p><b>Auto</b> trigger mode enables the instrument to acquire and display a waveform even if a trigger does not occur. Auto mode uses a timer that starts when the acquisition is started, and the pretrigger information is obtained. If a trigger event is not detected before the timer times out, the instrument forces a trigger. The length of time it waits for a trigger event depends on the time base setting.</p> <p>When forcing triggers in the absence of valid triggering events, Auto mode does not synchronize the waveform on the display. The waveform will appear to jump across the screen.</p> <p>If valid triggers occur, the display will become stable.</p> <p><b>Normal</b> trigger mode enables the instrument to acquire a waveform only when it is triggered. If no trigger occurs, the last waveform record acquired remains on the display. If no last waveform exists, no waveform is displayed.</p>
<b>Force Trigger</b>	Forces a trigger event regardless of whether the waveform meets any trigger conditions.
<b>Holdoff</b>	Holdoff is not compatible with Sequence triggering.

Table continued...

Field or control	Description
<b>Trigger Frequency Counter</b>	<p>Turn <b>On</b> to display the trigger event frequency in the <b>Trigger</b> badge.</p> <p>The trigger frequency can help you troubleshoot signal problems where the frequency of the trigger event may be related to a clock, switching power supply, or other recurrent frequency that occurs on your DUT.</p> <p>Only available if you have installed the DVM option, which is available when you register your instrument with Tektronix.</p>

### Other trigger types

- [Bus Trigger Menu](#)
- [Edge Trigger menu](#)
- [Logic Trigger menu](#)
- [Pulse Width Trigger menu](#)
- [Rise Fall Time Trigger menu](#)
- [Runt Trigger menu](#)
- [Setup and Hold Trigger menu](#)
- [Timeout Trigger menu](#)
- [Window Trigger menu](#)

### A Trigger Event configuration menu

Use this menu to set the trigger conditions for the A trigger event of a Sequence trigger.

To open the A Trigger Event menu:

1. Double-tap the **Trigger** badge on the Settings bar.
2. Set the **Trigger Type** to **Sequence**.
3. Tap the **A Trigger Event** button.

### A Trigger Event menu (Sequence Trigger configuration menu) fields and controls

Field or control	Description
<b>Trigger Type</b>	Select the A event trigger type.

Table continued...

Field or control	Description
Other fields and controls	<p>The fields and controls shown depend on the selected Trigger Type. Use the following links to access setting information on a specific trigger.</p> <ul style="list-style-type: none"> <li>• <a href="#">Bus Trigger Menu</a></li> <li>• <a href="#">Edge Trigger menu</a></li> <li>• <a href="#">Logic Trigger</a></li> <li>• <a href="#">Pulse Width Trigger menu</a></li> <li>• <a href="#">Rise/Fall Time Trigger menu</a></li> <li>• <a href="#">Runt Trigger menu</a></li> <li>• <a href="#">Sequence Trigger menu</a></li> <li>• <a href="#">Setup &amp; Hold Trigger menu</a></li> <li>• <a href="#">Timeout Trigger menu</a></li> <li>• <a href="#">Window Trigger menu</a></li> </ul> <p> <b>Note:</b> The Sequence Trigger type is not available in the A Trigger Event menu.</p>

## B Trigger Event configuration menu

Use this menu to set the trigger conditions for the B trigger event of a Sequence trigger.

To open the B-Trigger Event configuration menu:

1. Double-tap the **Trigger** badge on the Settings bar.
2. Set the **Trigger Type** to **Sequence**.
3. Tap the **B Trigger Event** button.

### B Trigger Event menu (Sequence Trigger configuration menu) fields and controls

Field or control	Description
Trigger Type	Select the B event trigger type.

Table continued...

Field or control	Description
<b>Other fields and controls</b>	<p>The fields and controls shown depend on the selected Trigger Type. Use the following links to access setting information on a specific trigger.</p> <ul style="list-style-type: none"> <li>• <a href="#">Bus Trigger Menu</a></li> <li>• <a href="#">Edge Trigger menu</a></li> <li>• <a href="#">Logic Trigger</a></li> <li>• <a href="#">Pulse Width Trigger menu</a></li> <li>• <a href="#">Rise/Fall Time Trigger menu</a></li> <li>• <a href="#">Runt Trigger menu</a></li> <li>• <a href="#">Sequence Trigger menu</a></li> <li>• <a href="#">Setup &amp; Hold Trigger menu</a></li> <li>• <a href="#">Timeout Trigger menu</a></li> <li>• <a href="#">Window Trigger menu</a></li> </ul> <p> <b>Note:</b> The Sequence Trigger type is not available in the A Trigger Event menu.</p>

## Setup and Hold Trigger configuration menu

Use the Setup & Hold trigger to trigger on a waveform when a data signal changes state inside of a specified setup and hold time, relative to a clock edge.

To open the Setup & Hold trigger configuration menu:

1. Double-tap the **Trigger** badge on the Settings bar.
2. Set the **Trigger Type** to **Setup & Hold**.

### Settings panel (Setup & Hold Trigger configuration menu) fields and controls

Field or control	Description
<b>Clock Source</b>	Sets the signal to use as the clock. The clock source can be an analog, digital, math, or reference waveform.
<b>Clock Level</b>	Sets the threshold level that the clock signal must pass through to be considered a valid transition. The clock threshold value is independent of the input signal threshold(s).
<b>Clock Edge</b>	Sets the polarity of the clock edge (rising or falling) for evaluating the other menu conditions. The Logic menu also lets you set the clock edge to either edge.
<b>Data Sources: Define Inputs</b>	Opens the Setup & Hold Trigger - Define Inputs menu. Use this menu to select the input signals and their thresholds. See <a href="#">Setup and Hold Trigger - Define Inputs configuration menu</a> on page 610.
<b>Setup Time</b>	Sets the length of time that data signal should be stable and not change before a clock edge occurs.
<b>Hold Time</b>	Sets the length of time that data signal should be stable and not change after a clock edge occurs.

## Mode & Holdoff panel (Setup & Hold Trigger configuration menu) fields and controls

Field or control	Description
<b>Trigger Mode</b>	<p>The trigger mode determines how the instrument behaves in the absence or presence of a trigger event:</p> <p><b>Auto</b> trigger mode enables the instrument to acquire and display a waveform even if a trigger does not occur. Auto mode uses a timer that starts when the acquisition is started, and the pretrigger information is obtained. If a trigger event is not detected before the timer times out, the instrument forces a trigger. The length of time it waits for a trigger event depends on the time base setting.</p> <p>When forcing triggers in the absence of valid triggering events, Auto mode does not synchronize the waveform on the display. The waveform will appear to jump across the screen.</p> <p>If valid triggers occur, the display will become stable.</p> <p><b>Normal</b> trigger mode enables the instrument to acquire a waveform only when it is triggered. If no trigger occurs, the last waveform record acquired remains on the display. If no last waveform exists, no waveform is displayed.</p>
<b>Force Trigger</b>	Forces a trigger event regardless of whether the waveform meets any trigger conditions.
<b>Holdoff</b>	<p>Trigger holdoff sets the amount of time the oscilloscope waits after a trigger event before detecting and triggering on the next trigger event.</p> <p><b>Random</b> sets the instrument to wait for a random amount of time before recognizing another trigger event. This means that successive acquisitions are unrelated to the previous trigger signal.</p> <p><b>Time</b> sets the instrument to wait the specified time before recognizing another trigger event. Use this option when the signal that you want to trigger on has several possible trigger points or is a burst signal.</p>
<b>Holdoff Time</b>	Tap the <b>Holdoff Time</b> field and use the multipurpose knob to adjust the holdoff time value. Or double-tap the field and use the virtual keypad to enter a time holdoff period.
<b>Act on Trigger</b>	<p>Tap the <b>Act on Trigger</b> button to configure the actions the instrument must take when a trigger event occurs.</p> <p>See <a href="#">Act On Event configuration menu</a> on page 178 for the available fields and controls.</p>
<b>Trigger Frequency Counter</b>	<p>Turn <b>On</b> to display the trigger event frequency in the <b>Trigger</b> badge.</p> <p>The trigger frequency can help you troubleshoot signal problems where the frequency of the trigger event may be related to a clock, switching power supply, or other recurrent frequency that occurs on your DUT.</p> <p>Only available if you have installed the DVM option, which is available when you register your instrument with Tektronix.</p>

### Other trigger types

- [Bus Trigger Menu](#)
- [Edge Trigger menu](#)
- [Logic Trigger menu](#)
- [Pulse Width Trigger menu](#)
- [Rise Fall Time Trigger menu](#)
- [Runt Trigger menu](#)
- [Sequence Trigger menu](#)

- [Timeout Trigger menu](#)
- [Window Trigger menu](#)

## Setup and Hold Trigger - Define Inputs configuration menu

Use this menu to set the input signals and their threshold levels for the Setup & Hold trigger.

To open the Setup & Hold Trigger - Define Inputs dialog:

1. Double-tap the **Trigger** Badge.
2. Set the **Trigger Type** to **Setup & Hold**.
3. Tap the **Data Sources Define Inputs** button.

### Setup & Hold Trigger - Define Inputs configuration menu fields and controls

Field or control	Description
<b>Ch(x) (analog channels) or D(x) (digital Channels)</b>	Use to select the signal sources to test for the setup and hold condition. Tap to select for each input source.  If a channel is a digital channel, tap the + symbol to open the list of digital inputs (D0-D7) from which to select individual digital signals.  Use the Threshold field to set the signal level that must be exceeded for that signal to be true.
<b>Set All</b>	Sets all signal sources to be included or not included.

## Timeout Trigger configuration menu

Use the Timeout Trigger to trigger on a waveform when an expected signal does not transition within a specified period of time, such as when a signal gets stuck either high or low.

To open the Timeout trigger menu:

1. Double-tap the **Trigger** badge on the Settings bar.
2. Set the **Trigger Type** to **Timeout**.

### Settings panel (Timeout Trigger configuration menu) fields and controls

Field or control	Description
<b>Source</b>	Lists the source channel. Lists the source channel or waveform to use to trigger or search. Types that require multiple inputs will replace this control with a different source definition control.
<b>Trigger When</b>	<ul style="list-style-type: none"> <li>• <b>Stays High:</b> The signal stays above the specified threshold level longer than the specified time.</li> <li>• <b>Stays Low:</b> The signal stays below the specified threshold level longer than the specified time.</li> <li>• <b>Either:</b> The signal stays above or below the specified threshold level longer than the specified time.</li> </ul>
<b>Threshold</b>	Sets the amplitude level that the signal must pass through to be considered a valid transition.
<b>Set to 50%</b>	Sets the threshold at 50% of the measured signal transition range. 50% is calculated as (Top + Bottom)/2.
<b>Time Limit</b>	Sets the time period condition to be met.

Table continued...

Field or control	Description
<b>Logic Qualification</b>	When set to On, enables logic qualification to further refine the trigger condition by setting the required logic conditions on the source signals to generate a trigger event.
<b>Define Inputs</b>	Opens the <b>Logic Qualification - Define Inputs</b> configuration menu. Use this menu to set the logic state, threshold levels, and logic operation of the input signals. See <a href="#">Logic Qualification - Define Inputs configuration menu</a> on page 612.  Available when Logic Qualification = On.

### Mode & Holdoff panel (Timeout Trigger configuration menu) fields and controls

Field or control	Description
<b>Trigger Mode</b>	The trigger mode determines how the instrument behaves in the absence or presence of a trigger event:  <b>Auto</b> trigger mode enables the instrument to acquire and display a waveform even if a trigger does not occur. Auto mode uses a timer that starts when the acquisition is started, and the pretrigger information is obtained. If a trigger event is not detected before the timer times out, the instrument forces a trigger. The length of time it waits for a trigger event depends on the time base setting.  When forcing triggers in the absence of valid triggering events, Auto mode does not synchronize the waveform on the display. The waveform will appear to jump across the screen.  If valid triggers occur, the display will become stable.  <b>Normal</b> trigger mode enables the instrument to acquire a waveform only when it is triggered. If no trigger occurs, the last waveform record acquired remains on the display. If no last waveform exists, no waveform is displayed.
<b>Force Trigger</b>	Forces a trigger event regardless of whether the waveform meets any trigger conditions.
<b>Holdoff</b>	Trigger holdoff sets the amount of time the oscilloscope waits after a trigger event before detecting and triggering on the next trigger event.  <b>Random</b> sets the instrument to wait for a random amount of time before recognizing another trigger event. This means that successive acquisitions are unrelated to the previous trigger signal.  <b>Time</b> sets the instrument to wait the specified time before recognizing another trigger event. Use this option when the signal that you want to trigger on has several possible trigger points or is a burst signal.
<b>Holdoff Time</b>	Tap the <b>Holdoff Time</b> field and use the multipurpose knob to adjust the holdoff time value. Or double-tap the field and use the virtual keypad to enter a time holdoff period.
<b>Act on Trigger</b>	Tap the <b>Act on Trigger</b> button to configure the actions the instrument must take when a trigger event occurs.  See <a href="#">Act On Event configuration menu</a> on page 178 for the available fields and controls.
<b>Trigger Frequency Counter</b>	Turn <b>On</b> to display the trigger event frequency in the <b>Trigger</b> badge.  The trigger frequency can help you troubleshoot signal problems where the frequency of the trigger event may be related to a clock, switching power supply, or other recurrent frequency that occurs on your DUT.  Only available if you have installed the DVM option, which is available when you register your instrument with Tektronix.

## Other trigger types

- [Bus Trigger Menu](#)
- [Edge Trigger menu](#)
- [Logic Trigger menu](#)
- [Pulse Width Trigger menu](#)
- [Rise Fall Time Trigger menu](#)
- [Runt Trigger menu](#)
- [Sequence Trigger menu](#)
- [Setup and Hold Trigger menu](#)
- [Window Trigger menu](#)

## Logic Qualification - Define Inputs configuration menu

Use this menu to set the logic state, and threshold levels to use for the trigger.

This menu is available when the trigger type is set to Pulse Width, Timeout, Runt, Window or Rise / Fall Time.

To open the Logic Qualification - Define Inputs menu:

1. Double-tap the **Trigger** badge on the Settings bar.
2. Set the **Trigger Type** to **Pulse Width, Timeout, Runt, Window** or **Rise / Fall Time**.
3. Tap Logic Qualification to **On**.
4. Tap the **Define Inputs** button.

## Logic Qualification - Define Inputs (Trigger configuration menu) fields and controls

Field or control	Description
<b>Chx (analog channels) or Dx (digital channels)</b>	Use to select the signal source logic condition on which to perform the logic trigger (High, Low, Don't Care). Tap to select for each input source. If a channel is a digital channel, tap the + symbol to open the list of digital inputs (D0-D7) from which to select logic conditions for the individual digital signals.  Use the Threshold field to set the signal level that must be exceeded for that signal to be true (logical 1).
<b>Set All</b>	Sets all signal sources to detect a logic <b>High, Low, or Don't Care</b> condition.
<b>Define Logic</b>	Sets the logic condition that must occur with all inputs. <ul style="list-style-type: none"> <li>• <b>AND:</b> All conditions are true.</li> <li>• <b>OR:</b> Any condition is true.</li> <li>• <b>NAND:</b> One or more conditions are true.</li> <li>• <b>NOR:</b> No conditions are true.</li> </ul>

## Window Trigger configuration menu

Use the Window Trigger to trigger when a signal rises above an upper threshold level or falls below a lower threshold level (the 'window'), with or without a time limit constraint.

To open the Window trigger menu:



1. Double-tap the **Trigger** badge on the Settings bar.
2. Set the **Trigger Type** to **Window**.

### Settings panel (Window Trigger configuration menu) fields and controls

Field or control	Description
<b>Source</b>	Lists the source channel or waveform to use to trigger or search. Types that require multiple inputs will replace this control with a different source definition control.
<b>Trigger When</b>	<ul style="list-style-type: none"> <li>• <b>Enters Window:</b> The signal outside a window enters the window defined by the upper and lower threshold settings.</li> <li>• <b>Exits Window:</b> The signal exits the window defined by the upper and lower threshold settings.</li> <li>• <b>Inside &gt; Limit:</b> The signal remains inside the window longer than the specified time limit.</li> <li>• <b>Outside &gt; Limit:</b> The signal remains outside the window longer than the specified time limit.</li> </ul>
<b>Upper Threshold</b>	Sets the amplitude threshold value for the upper edge of the window.
<b>Lower Threshold</b>	Sets the amplitude threshold value for the lower edge of the window.
<b>Time Limit</b>	Sets the time period condition to be met. Available when Trigger When = Inside > Limit or Outside > Limit.
<b>Threshold Crossing</b> (Trigger When = Outside > Limit)	<ul style="list-style-type: none"> <li>• <b>Upper:</b> A signal remains above the upper threshold level for longer than the specified time limit before crossing the upper threshold level to a lower level.</li> <li>• <b>Lower:</b> A signal remains below the lower threshold level for longer than the specified time limit before crossing the lower threshold level to a higher level.</li> <li>• <b>Either:</b> A signal remains outside (above or below) the two threshold levels for longer than the specified time limit before crossing either threshold level.</li> <li>• <b>None:</b> A signal remains outside the two specified threshold levels for longer than a specified time limit.</li> </ul>
<b>Threshold Crossing</b> (Trigger When = Inside > Limit)	<ul style="list-style-type: none"> <li>• <b>Upper:</b> A signal remains between two thresholds for longer than the specified time limit before crossing through the upper threshold.</li> <li>• <b>Lower:</b> A signal remains between two thresholds for longer than the specified time limit before crossing through the lower threshold.</li> <li>• <b>Either:</b> A signal remains between two thresholds for longer than the specified time limit before crossing through either the upper or lower threshold.</li> <li>• <b>None:</b> A signal remains between two threshold levels for longer than a specified time limit.</li> </ul>
<b>Logic Qualification</b>	When set to On, enables logic qualification to further refine the trigger condition by setting the required logic conditions on the source signals to generate a trigger event.
<b>Define Inputs</b>	Opens the <b>Logic Qualification - Define Inputs</b> configuration menu. Use this menu to set the logic state, threshold levels, and logic operation of the input signals. See <a href="#">Logic Qualification - Define Inputs configuration menu</a> on page 612. Available when Logic Qualification = On.

## Mode & Holdoff panel (Window Trigger configuration menu) fields and controls

Field or control	Description
<b>Trigger Mode</b>	<p>The trigger mode determines how the instrument behaves in the absence or presence of a trigger event:</p> <p><b>Auto</b> trigger mode enables the instrument to acquire and display a waveform even if a trigger does not occur. Auto mode uses a timer that starts when the acquisition is started, and the pretrigger information is obtained. If a trigger event is not detected before the timer times out, the instrument forces a trigger. The length of time it waits for a trigger event depends on the time base setting.</p> <p>When forcing triggers in the absence of valid triggering events, Auto mode does not synchronize the waveform on the display. The waveform will appear to jump across the screen.</p> <p>If valid triggers occur, the display will become stable.</p> <p><b>Normal</b> trigger mode enables the instrument to acquire a waveform only when it is triggered. If no trigger occurs, the last waveform record acquired remains on the display. If no last waveform exists, no waveform is displayed.</p>
<b>Force Trigger</b>	Forces a trigger event regardless of whether the waveform meets any trigger conditions.
<b>Holdoff</b>	<p>Trigger holdoff sets the amount of time the oscilloscope waits after a trigger event before detecting and triggering on the next trigger event.</p> <p><b>Random</b> sets the instrument to wait for a random amount of time before recognizing another trigger event. This means that successive acquisitions are unrelated to the previous trigger signal.</p> <p><b>Time</b> sets the instrument to wait the specified time before recognizing another trigger event. Use this option when the signal that you want to trigger on has several possible trigger points or is a burst signal.</p>
<b>Holdoff Time</b>	Tap the <b>Holdoff Time</b> field and use the multipurpose knob to adjust the holdoff time value. Or double-tap the field and use the virtual keypad to enter a time holdoff period.
<b>Act on Trigger</b>	<p>Tap the <b>Act on Trigger</b> button to configure the actions the instrument must take when a trigger event occurs.</p> <p>See <a href="#">Act On Event configuration menu</a> on page 178 for the available fields and controls.</p>
<b>Trigger Frequency Counter</b>	<p>Turn <b>On</b> to display the trigger event frequency in the <b>Trigger</b> badge.</p> <p>The trigger frequency can help you troubleshoot signal problems where the frequency of the trigger event may be related to a clock, switching power supply, or other recurrent frequency that occurs on your DUT.</p> <p>Only available if you have installed the DVM option, which is available when you register your instrument with Tektronix.</p>

### Other trigger types

- [Bus Trigger Menu](#)
- [Edge Trigger menu](#)
- [Logic Trigger menu](#)
- [Pulse Width Trigger menu](#)
- [Rise Fall Time Trigger menu](#)
- [Runt Trigger menu](#)
- [Sequence Trigger menu](#)

- [Setup and Hold Trigger menu](#)
- [Timeout Trigger menu](#)

## Visual Trigger panel

Use the Visual Trigger panel in the Trigger badge to enable Visual Trigger mode and set area combinatorial logic.

To access the **Visual Trigger** panel:

1. Double-tap the **Trigger** badge on the Settings bar.
2. Tap the **Visual Trigger** panel.

### Visual Trigger panel (Trigger configuration menu) fields and controls

Field or control	Description
<b>Visual Trigger</b>	Enables or disables Visual Trigger mode
<b>Display</b>	<p><b>Areas:</b> When this is checked, draws the visual trigger areas in the Waveform View.</p> <p><b>Criteria:</b> When this is checked, the text associated with areas is displayed (for example, the area name (A1), the criteria symbol (in, out, don't care), and the source (in overlay)).</p> <p><b>Logic Equation:</b> When this is checked, the Area Combinatorial Logic equation is displayed in white text in the upper left of the Waveform View. You can move the equation by dragging it to a new position.</p> <p>When zoom is on, the equation is in the upper left of the Zoom Overview area.</p> <p>To create or edit the area combinatorial logic equation, double tap on the equation to open the <b>Area Combinatorial Logic</b> keypad. Note that you can only open the keypad if more than one visual trigger area is defined. See <a href="#">Visual Trigger Area Combinatorial Logic menu</a> on page 618</p>

## Bus trigger radix-specific virtual keypads

Use the virtual Logic keypad to edit bus logic values for trigger settings. Using a logic keypad is faster to set larger logic trigger values than using the multipurpose knobs in the trigger menu.

To open the virtual Logic keypad, double-tap inside a bus trigger field that requires logic values. Which field you select (Binary, Hex, and so on) sets which Logic keypad is displayed.

### Virtual Keypad fields and controls

Field or control	Description
<b>Clear</b>	Sets all digits to X (don't care) for binary, hex, octal and ASCII formats. Decimal gets set to 0.
<	Moves the insertion point left and highlights the character that can be edited.
>	Moves the insertion point right and highlights the character that can be edited.
Radix keypad	<p>Provides a keypad associated with the logic entry radix field that was double-tapped in the Trigger menu. Tapping a key sets the selected digit to the specified value and moves the selected digit indicator to the next (right) digit.</p> <p>You can also use an attached keyboard to enter values in the keypad character field.</p>

Table continued...

Field or control	Description
<b>Enter</b>	Closes the number pad and assigns the entered value to the field. Also updates all other formats in the trigger menu so that all formats are indicating the same value.
<b>Cancel</b>	Closes the logic keypad without saving entered values.

## Virtual Keyboard

Use the onscreen virtual keyboard to enter textual information such as a file path, file name, label text, or on-screen callout.

To access the virtual keyboard, double-tap in a menu or dialog text input box. Enter your text and tap **Enter** to close the keyboard and add your text to the menu or dialog field.

Tap **ESC**, **Cancel**, or anywhere outside the keyboard, to dismiss it without adding text to the input box.

Single-tap in the keyboard text field to position the insertion cursor at that location. Double-tap to select individual words. Triple-tap to select all text in the field.

Touch and drag the title bar to move the keyboard on the screen.

Other than the standard English language, the virtual keyboard also supports German, French, and Italian languages for interacting with the oscilloscope.

## Virtual Keypad

Use the virtual Keypad to enter numeric values and units for settings.

To open the virtual keypad, double-tap inside a field that requires numeric values.

### Virtual Keypad fields and controls

Field or control	Description
<b>Clear</b>	Clears all values from the input entry field.
<b>Exp</b>	Lets you enter exponential notation entries.
<b>Max</b>	Enters the maximum value allowed for this setting.
<b>Min</b>	Enters the minimum value allowed for this setting.
<b>Bksp ←</b>	Deletes characters to the left of the insert text marker position.
<b>Enter</b>	Closes the number pad and assigns the entered value to the field.
<b>±</b>	Tap the button to set a numeric value to a positive (default) or negative value.
Unit buttons	Use to set the units of the entered value.

## Visual Trigger Area configuration menu

Use the Visual Trigger Area menu to edit visual trigger area parameters. Double tapping a Visual Trigger area opens the Area configuration menu and makes the related source the selected source.

To open the Visual Trigger **Area** menu, double-tap on a visual trigger area.

To create a visual trigger area, see [Create Visual Trigger areas](#) on page 130

## Area Settings panel fields and controls

Field or control	Description
<b>Source</b>	Lists the available source signals for which to create an area. The default value is the signal source of the selected area.
<b>Shape</b>	Lists the current shape type, and also lets you change the current shape to a specified shape. Changing a shape defines the minimum rectangle that includes all vertices of the current area, and then does a best-fit approach to create the specified shape.  If you made changes to a default shaped area that results in an area that no longer meets the default shape definition, that area is listed as a Custom shape in the menu.
<b>Waveform Must Be</b>	Sets the logic condition for how the area logic equation interprets when a waveform intersects an area.  <b>In (✓)</b> : A waveform must intersect this area for the area logic to be true.  <b>Out (X)</b> : A waveform must not intersect this area for the area logic to be true.  <b>Don't Care (?)</b> : Don't care if a waveform intersects the area. This setting lets you ignore an area during visual trigger development, instead of having to delete and recreate areas.
<b>Height</b>	Sets the area height, in amplitude units, between the topmost vertex and the bottommost vertex.
<b>Vertical Center</b>	Sets the area vertical center, in amplitude units, as the point halfway between the topmost vertex and bottommost vertex.
<b>Flip Vertical</b>	Flips the area vertically around its Vertical Center value.
<b>Width</b>	Sets the area width, in time units, between the leftmost vertex and the rightmost vertex.
<b>Horizontal Center</b>	Sets the area horizontal center, as time units, as the point halfway between the leftmost vertex and rightmost vertex.
<b>Flip Horizontal</b>	Flips the area horizontally around its Horizontal Center value.
<b>Rotate</b>	Rotates the area in units of degrees, from 0° to 360°.  The rotation is an absolute angle measurement referenced from 0°, where 0° is the position of the area when it was first created. For example, if you rotate the area 40°, and then rotate it again with 20°, the resulting area rotation is 20°.  The area height and width are relative to the current area orientation, and automatically change places as needed when the area is rotated.

## Edit Vertices panel fields and controls

Field or control	Description
<b>Define Area</b>	A table that lists the X (time) and Y (amplitude) values for each vertex (point) of the area. Use the scroll bar to show points if there are more than nine points in the area.  Selecting a row in the table highlights the associated vertex on the area.  Use the Multipurpose knobs to change the value of the X or Y settings, or double-tap a setting and enter the value directly.
<b>Insert Point</b>	Inserts a new row above the selected row and creates a new vertex on the area shape. The new vertex is halfway between the vertices defined in the prior row and the following row in the table.
<b>Delete Point</b>	Deletes the currently selected point, keeps the row selected, and moves all rows below it up one row.  The <b>Delete Point</b> button is not available when a triangular area is selected.

Table continued...

Field or control	Description
Reset Points	Deletes all but three data points from the table. The remaining three data points are set to a default triangle, set to two divisions for height and width, and centered in the waveform area.



**Note:** Redo and Undo are available for most Edit Vertices panel controls.

### Visual trigger right click menu

See [Right click menu functions associated with visual trigger areas](#) on page 618.

### Right click menu functions associated with visual trigger areas

The following functions are available when you right click on a visual trigger area.

Field or control	Description
In	Sets the area's Waveform Must Be control to <b>In</b> .
Out	Sets the area's Waveform Must Be control to <b>Out</b> .
Don't Care	Sets the area's Waveform Must Be control to <b>Don't Care</b> .
Rectangle	Sets the area's shape to a rectangle
Triangle	Sets the area's shape to a triangle.
Trapezoid	Sets the area's shape to a trapezoid.
Hexagon	Sets the area's shape to a hexagon.
Create Duplicate	Creates a new area with the same characteristics as the current area, but offset from the original area by X+50 and Y+50.
Configure Area	Opens the Area configuration menu for the selected area.
Delete Area	Deletes the selected area.

### Visual Trigger Area Combinatorial Logic menu

Use the Area Combinatorial Logic menu to describe the logic conditions required for a true condition of all associated areas.

To open the Visual Trigger **Area Combinatorial Logic** menu:

1. Double-tap the **Trigger** badge.
2. Tap the **Visual Trigger** panel.
3. Double-tap the **Area Combinatorial Logic** field to open the **Area Combinatorial Logic** menu.



**Note:** There must be at least two areas before you can open the **Area Combinatorial Logic** menu.

## Area Combinatorial Logic menu fields and controls

Field or control	Description
<b>Logic expression field</b>	<p>Displays the area combination logic for all areas associated with the same signal source. All areas are ANDed by default, including areas set as Don't Care.</p> <p>Use the buttons in the menu to edit or define the area combination logic, or double-tap the field and enter the logic expression directly.</p> <p>You must tap the <b>Enter</b> button to check and save the logic expression to make it valid.</p>
<b>Clear</b>	Deletes all text in the logic expression field.
<b>Move insertion point</b>	Moves the insertion point left or right in the logic expression field.
<b>Logic action buttons</b>	Inserts the selected logic function or grouping parenthesis at the insertion point in the logic expression field.
<b>Bksp</b>	Deletes the character to the left of the insertion point.
<b>Insert Area buttons</b>	<p>Inserts the selected area text into the logic expression. Only available areas are listed.</p> <p>If more than nine areas are defined, use the scroll bar to view area buttons greater than A9.</p>
<b>Cancel</b>	Closes the menu without saving any changes.
<b>Enter</b>	<p>Checks the syntax of the logic expression. If it is valid, the changes are saved and the menu is closed.</p> <p>If the logic expression syntax is not valid, or the logic expression field is empty, the instrument displays an error message, the menu remains open, and no changes are saved.</p>

## Waveform Histogram configuration menu

Use the Waveform Histogram menu to edit waveform histogram parameters. Double tapping a histogram opens the Waveform Histogram configuration menu. The waveform histogram feature is supported on 4B/5/5B/6/6B Series MSO but not supported on 4 Series MSO.

To open the Waveform Histogram configuration menu, double-tap on a histogram.

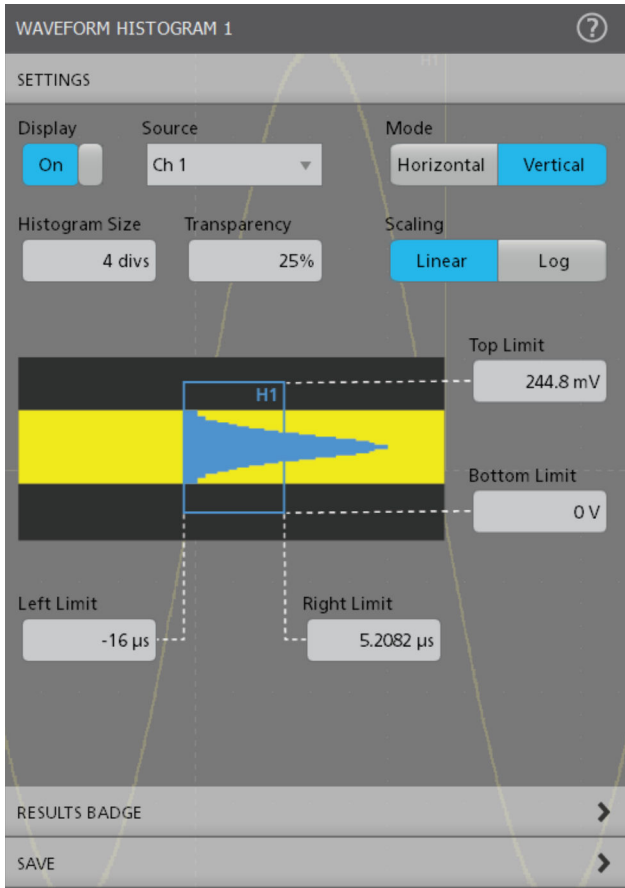

To create a histogram, see [Create a waveform histogram](#) on page 163.

Field or control	Description
<b>Display</b>	Enables or disables displaying the waveform histogram bins.
<b>Source</b>	Lists the source channel or waveform for the waveform histogram.
<b>Mode</b>	Set the mode of the histogram as <b>Vertical</b> or <b>Horizontal</b> .
<b>Histogram Size</b>	Set the size of the histogram in tenths of divisions.
<b>Transparency</b>	Set the transparency of the histogram.
<b>Scaling</b>	Set the scaling of histogram as <b>Linear</b> or <b>Log</b> . Default is linear.
Histogram box limits <b>Top Limit</b> , <b>Bottom Limit</b> , <b>Left Limit</b> , <b>Right Limit</b>	Tap the field and use Multipurpose knob A and B to set a histogram box limits. To enter a specific value, double-tap on the field and use the virtual keypad to enter a limit.

## Waveform Histogram Result Badge menu

The following are the histogram statistics you can add to the waveform histogram badge.

Field or control	Description
<b>Display</b>	Toggles the display to <b>On</b> or <b>Off</b> . Default is on. When it is on, the histogram badge displays in the Results bar.
<b>Waveform Count</b>	Waveform Count is the number of waveforms that contributed to the histogram.

Table continued...



Field or control	Description
<b>Hits in Box</b>	Hits in box is the number of samples within the histogram box or on its boundaries.
<b>Peak Hits</b>	Peak Hits is the number of samples in the bin that contains the most hits.
<b>Maximum</b>	Maximum is the amplitude of the highest non-zero bin in vertical histograms or the time of the rightmost non-zero bin in horizontal histograms.
<b>Minimum</b>	Minimum is the amplitude of the lowest non-zero bin in vertical histograms or the time of the leftmost non-zero bin in horizontal histograms.
<b>Mean</b>	Mean is the average of all histogram data points within or on the histogram box.
<b>Peak-to-Peak</b>	For vertical histograms, Peak-to-Peak is the amplitude of the highest non-zero bin minus the amplitude of the lowest non-zero bin. For horizontal histograms, it is the time of the rightmost non-zero bin minus the time of the leftmost non-zero bin.
<b>Median</b>	Median is the middle histogram data value, where half of all histogram data points are less than this value and half are greater than this value.
<b>Mode</b>	Mode is the histogram data value that occurs most frequently.
<b>Standard Deviation</b>	Standard Deviation is the standard deviation (Root Mean Square deviation) of all histogram data points within or on the histogram box.
<b><math>\mu \pm 1\sigma</math></b>	$\mu \pm 1\sigma$ is the percentage of hits in the histogram that are within one standard deviation of the histogram mean.
<b><math>\mu \pm 2\sigma</math></b>	$\mu \pm 2\sigma$ is the percentage of hits in the histogram that are within two standard deviations of the histogram mean.
<b><math>\mu \pm 3\sigma</math></b>	$\mu \pm 3\sigma$ is the percentage of hits in the histogram that are within three standard deviations of the histogram mean.

## Save As configuration menu (Save Waveform Histogram)

Use the Save As configuration menu to set the location and file name to which to save the contents of a histogram, as a .csv format file.

To open the Save As configuration menu to save a histogram

1. Double-tap anywhere on the histogram to open the Waveform Histogram configuration menu.
2. Tap **Save > Save Histogram Data**.

## Save As menu, Histogram Save fields and controls

Field or control	Description
<b>Save Location</b>	<p>Sets the location of the save file. The default value is the last location to which a file was saved.</p> <p>Tap on the file path and use a keyboard to enter a new save location. Or double-tap on the file name to open the virtual keyboard and enter a path.</p> <p>Tap the down arrow icon on the right end of the field to open a list of recent file save locations, for the current save type, up to a maximum of 20 locations.</p>
<b>Browse</b>	Tap to open the Browse Save As Location dialog, to navigate to and select the location to save the file to. See <a href="#">Browse Save As Location configuration menu</a> on page 477.

Table continued...

Field or control	Description
File Name	Sets the file name of the file. The default file name is Tek000. The file name increments on the next save (Tek001, Tek002, and so on).  Tap on the file name and use a keyboard to enter a new file name. Or double-tap on the file name to open the virtual keyboard and enter a file name.
Save as Type	Save the histogram as a .csv file.

## Right click menu functions associated with the Waveform Histogram

The following functions are available when you right click on a waveform histogram.

Field or control	Description
Configure Histogram	Opens the histogram configuration menu for the selected histogram.
Delete Histogram	Deletes the selected histogram.
Delete All Histograms	Deletes all the histograms.

## Waveform View configuration menu

Use this menu to configure the Waveform View to set display mode (Stacked or Overlay), waveform interpolation method, persistence, and other parameters.

To open the Waveform View menu, double-tap anywhere in the Waveform View screen.

### Waveform View menu fields and controls

Fields or controls	Description
Display Mode	<p>Sets how waveforms are shown on the screen.</p> <p><b>Overlay</b> mode displays all waveforms on the screen, overlaid on each other. This is the traditional way that oscilloscopes displayed waveforms, and lets you overlay waveforms to do direct comparisons of waveform shape. The grid vertical position and scale values change for each selected waveform.</p> <p><b>Stacked</b> mode draws each waveform in an individual section, or slice, of the screen, stacked one on top of the other. This lets you view each waveform uncluttered by overlaying waveforms. Each waveform slice displays its own vertical scale units. A trigger level indicator in a slice indicates that that waveform is the trigger source.</p> <p> <b>Note:</b> Grouping badges requires the display mode be set to <b>Stacked</b> to display the grouped waveforms in slices. When grouping badges, the display mode is a combination of Overlay and Stacked modes, where each group of signals is overlaid in a slice for that group. See <a href="#">Group signal badges in the Settings bar</a> on page 65.</p> <p>See the <i>Group badges</i> topic in the Help.</p>

Table continued...

Fields or controls	Description
<b>Interpolation</b>	<p>Selects the method used to display record points between sampled points.</p> <p><b>Sin(x)/x</b> computes record points along a curve between the actual acquired samples. This form of interpolation is useful when acquiring rounded waveforms such as sine waves. It is good for general-purpose uses but may introduce overshoot or undershoot in signals with fast rise times. This interpolation is also useful for looking at high-frequency signals, especially where the frequency components are just below the Nyquist frequency.</p> <p><b>Linear</b> computes record points between actual acquired samples using a straight-line fit. This interpolation is useful for measuring waveforms with fast rise times, such as pulse trains.</p>
<b>Persistence</b>	<p>Sets the length of time data points are displayed on screen before being erased.</p> <p><b>Off</b> sets the record points to appear for the current acquisition only.</p> <p><b>Infinite</b> continuously accumulates record points on the waveform until you change one of the acquisition display settings or clear the acquisition memory. Use infinite persistence for displaying record points that may occur outside the normal acquisition envelope.</p> <p><b>Variable</b> lets you specify a time length to retain data points on screen. Each record point decays independently according to the time interval.</p> <p><b>Auto</b> sets the <b>Waveform Intensity</b> field to control the persistence time.</p>
<b>Variable Persistence Time</b> (Persistence = Variable)	<p>Sets the length of time data points remain displayed. Tap the field and use the A knob to adjust, or double-tap and use the keypad to set a time.</p>
<b>Waveform Style</b>	<p>Sets how waveforms are drawn on the screen.</p> <p><b>Vectors</b> draws waveforms with lines between record points.</p> <p><b>Dots</b> draws waveform record points as dots on the screen, and adds crosshair markers to real sampled points.</p>
<b>Waveform Intensity</b>	<p>Sets the brightness of the waveform. Tap the field and use the A knob to set the waveform intensity.</p>
<b>Graticule Style</b>	<p>Sets the type of graticule to display.</p> <p><b>Grid</b> shows a traditional grid on the instrument display. This is the default grid mode.</p> <p><b>Time</b> displays vertical graticules for just the horizontal (time) scale units.</p> <p><b>Full</b> displays the same style graticule lines for both horizontal and vertical scale units</p> <p><b>None</b> turns off the graticule, including the vertical scale readouts.</p>
<b>Graticule Intensity</b>	<p>Sets the brightness of the graticule. Tap the field and use the A knob to set the graticule intensity.</p>

# Waveform acquisition

## Acquisition concepts

The Acquisition system sets which data points are used to acquire waveforms.

## Acquisition hardware

Before a signal is displayed, it must pass through the input channel where it is scaled and digitized. Each channel has a dedicated input amplifier and digitizer. Each channel produces a stream of digital data from which the instrument extracts waveform records.

## Sampling process

Acquisition is the process of sampling an analog signal, converting it into digital data, and assembling it into a waveform record, which is then stored in acquisition memory.

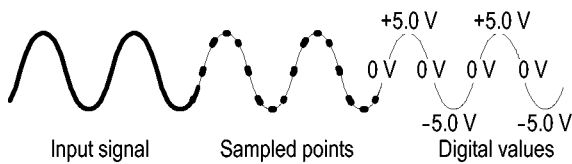

## Real-Time sampling

In real-time sampling, the instrument digitizes all of the points it acquires using one trigger event. Use real-time sampling to capture single-shot or transient events.

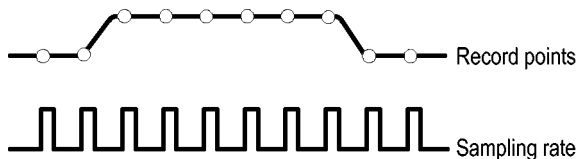

## Interpolated Real-Time sampling

In interpolated real-time sampling, the instrument digitizes all of the points it acquires using one trigger event. If the instrument cannot acquire enough samples for a complete waveform at the maximum real-time sample rate, it interpolates. Use interpolated real-time sampling to capture single-shot or transient events.

## Waveform record

The instrument builds the waveform record through use of the following parameters:

- Sample interval: The time between sample points.
- Record length: The number of samples required to fill a waveform record.
- Trigger point: The zero time reference in a waveform record.
- Horizontal position: When horizontal delay is off, the horizontal position is a percentage of the waveform record between 0 and 99.9 percent. The trigger point and the horizontal reference are at the same time in the waveform record. For example, if the horizontal

position is 50 percent, then the trigger point is in the middle of the waveform record. When horizontal delay is on, the time from the trigger point to the horizontal reference is the horizontal delay.

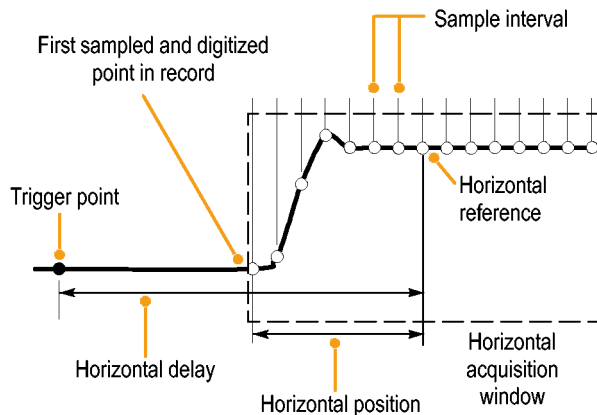

## Interpolation

Your instrument can interpolate between the samples it acquires when it does not have all of the actual samples it needs to fill the waveform record. Linear interpolation computes record points between actual acquired samples by using a straight line fit.

Sin(x)/x interpolation computes record points using a curve fit between the actual values acquired. Sin(x)/x interpolation is the default interpolation mode because it requires fewer actual sample points than linear interpolation to accurately represent the waveform.



## Acquisition modes

Acquisition is the process of sampling an analog signal, converting it into digital data, and assembling it into a waveform record, which is then stored in acquisition memory. The acquisition mode determines how the waveform record points are calculated from the sampled waveform data.

How the acquisition modes work:

Acquisition mode	
<p><b>Sample mode</b> retains the first sampled point from each acquisition interval. Sample is the default mode. The instrument does no post processing of the acquired samples in this mode.</p>	<p>1733-210</p>
<p><b>Peak Detect</b> mode retains the highest and lowest values of all the samples in each acquisition interval. This mode only works with real-time, noninterpolated sampling and is useful for catching high frequency glitches.</p>	<p>1733-207</p>
<p><b>High Res</b> mode applies unique FIR filtering based on the current sample rate. This FIR filter maintains maximum bandwidth possible for that sample rate while rejecting aliasing. The filter removes noise from the oscilloscope amplifiers and ADC above the usable bandwidth for the selected sample rate. Implementation of the filter in hardware, ahead of the trigger and storage, reduces trigger jitter and enables Fast Acq while in High Res mode.</p>	<p>1733-208</p>

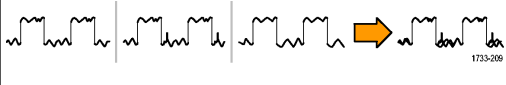
Table continued...

Acquisition mode	
<b>Envelope</b> mode finds the highest and lowest record points over many acquisitions. Envelope uses Peak Detect for each individual acquisition.	
<b>Average</b> mode calculates the average value for each record point over many acquisitions. Average uses Sample mode for each individual acquisition. Use Average mode to reduce random noise.	
<b>FastAcq™</b> mode is helpful in finding elusive signal anomalies. Fast acquisition mode reduces the dead time between waveform acquisitions, enabling the capture and display of transient events such as glitches and runt pulses. Fast acquisition mode can also display waveform phenomena at an intensity that reflects their rate of occurrence.	
<b>FastFrame™</b> segmented memory acquisition uses multiple trigger events to capture widely spaced events of interest at high sample rates while conserving acquisition memory. Capturing thousands of frames is possible, allowing analysis of long-term trends and changes in the bursting signal.	
<b>Roll Mode</b> scrolls sequential waveform points across the display in a right-to-left rolling motion. Roll Mode starts automatically when the timebase is set to $\geq 40$ ms/div. Roll Mode works at sample rates up to 10 MS/s.	

## Fast Frame concepts

FastFrame™ lets you to capture only the waveform, or waveform segment of interest, eliminating the dead space between conditions of interest. Each captured event is stored in its own numbered memory segment. Multiple memory segments, or frames, can then be viewed individually in the order they were captured, or layered to show their similarity and contrast.

Advantages of using Fast Frame include:

- The high waveform capture rate increases the probability of capturing infrequent events
- The waveform detail is preserved by using high sample rates
- The events are captured while ignoring the dead time between them, ensuring efficient use of the record length memory
- The segments can be quickly and visually compared to determine if an anomaly “sticks out” of the overlaid stack

Each frame can be viewed individually and you can scroll through them by selecting frame numbers with a mouse, virtual keypad or the multi-purpose knob on the instrument’s main console. When a particular frame of interest is identified, you can use the instrument’s features to characterize, measure, zoom and analyze the waveform in detail.

To quickly see anomalies that stand out from the common shape of the waveform, multiple frames can be overlaid to show common and outlying points. Enabling Overlay Frames in the Fast Frame configuration menu overlays all frames in the current acquisition using color to highlight how frequently the points are overlaid on each other.

You can also view multiple signal input frames simultaneously by using stacked waveform display mode. When you scroll through the frames, the oscilloscope displays the acquisition frame for all waveforms captured.

## Debugging signal errors with time stamps

Fast Frame mode provides a different type of functionality for digital designers. For example, if your processor system is being infrequently interrupted, it can be difficult to gather timing information with an oscilloscope. If you don’t know when or how frequently the event occurs, you can’t set up the instrument in normal acquisition mode and be assured of capturing the information you need.

Fast Frame mode can do this easily by providing information on the interval between frames. For example, the active high interrupt strobe on a microprocessor system is measured to be roughly 100 nanoseconds wide, so we set up the oscilloscope to capture 100 frames of 1250 points. In this example, the shape of the pulse is not of particular interest. We are, however, interested in the time of the pulses’ rising edges.

After turning Fast Frame on and selecting “Single Acquisition” to capture 100 frames, you use the readouts in the Fast Frame results badge to compare the time stamp data at the trigger point. The “Reference Frame” was chosen to be the first interrupt pulse and the “Selected Frame” is the fourth pulse. The time difference between these pulses is shown in the Delta readout on the badge.

The time stamps of all the frames can be output in tabular form for in-depth analysis using Excel or a wide variety of other popular software tools that read comma-delimited files (.CSV).



**Note:** Enabling Fast Frame mode disables FastAcq mode (if it was enabled). Likewise, enabling FastAcq mode disables Fast Frame mode (if it was enabled).

## Waveform sample interpolation

When the sample density falls to less than one sample per display column, the instrument must calculate intermediate points to display a waveform. This process is called interpolation.

There are three options for interpolation:

- Sin(x)/x interpolation. Computes record points using a curve fit between the actual values acquired. It assumes that all the interpolated points fall along that curve.
- Linear interpolation. Computes record points between actual acquired samples by using a straight line fit. It assumes that all the interpolated points fall in their appropriate point in time on that straight line.
- Auto interpolation. Select the best interpolation method.

## Coupling

All instruments and probes specify a maximum signal level. Do not exceed the limit, even momentarily, as the input channel or probe may be damaged. Use external attenuators if necessary to prevent exceeding the limits.

Coupling determines whether an input signal is directly connected to the input channel (DC coupling), connected through a DC blocking capacitor (AC coupling), or not connected at all (GND coupling).

The input resistance of each input channel can be  $1\text{ M}\Omega$ <sup>6</sup> or  $50\ \Omega$ . To properly terminate signals when using coaxial cables, or to support active probes with different termination requirements, select the termination in the Channel menu Vertical Settings panel.

All probes expect a specific coupling and input termination. Both coupling and input termination are displayed on the screen. If the instrument determines the coupling and termination required by the probe, either implicitly because of the TekProbe/TekVPI interface or through performing a probe compensation, the instrument sets the required coupling and input termination.

Consider the following when you use  $50\ \Omega$  termination with any channel:

- The instrument does not accurately display frequencies under 200 kHz if AC coupling is selected.
- The instrument reduces the maximum volts per division setting for the channel, since input amplitudes appropriate for the higher settings would overload the  $50\ \Omega$  input.

## Scaling and positioning

The scaling and positioning controls determine the portion of the input signal received by the acquisition system. Set the vertical scaling, positioning, and DC offsets to display the features of interest on your waveform and to avoid clipping.

Each waveform Slice or Graticule contains ten major divisions. This represents the maximum digitizing range of the instrument for any given vertical scale. Vertical waveform data that is outside (above and/or below) of the waveform Slice or Graticule is clipped; that

<sup>6</sup> The LPD64 does not have a  $1\text{ M}\Omega$  input impedance setting.

is, the data values exceed the digitizing capability of the ADC at the current settings. This causes inaccuracies in amplitude-related measurements. For more information see [Vertical acquisition considerations](#) on page 628.

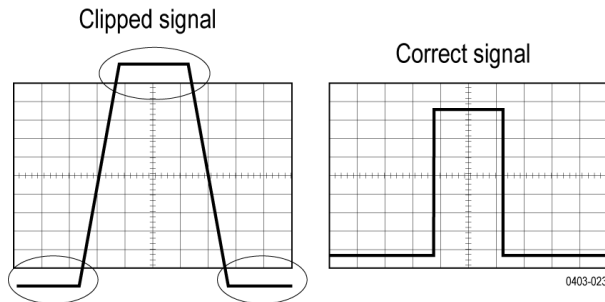

Set the horizontal scale, position, and resolution (record length) to include the acquired waveform record waveform attributes of interest with good sampling density on the waveform. These settings define the horizontal acquisition window, described in [Horizontal acquisition considerations](#) on page 629.



**Note:** The terms vertical acquisition window and horizontal acquisition window refer to the vertical and horizontal range of the segment of the input signal that the acquisition system acquires. The terms do not refer to any display windows on screen.

## Vertical acquisition considerations

You can set the vertical scale, position, and offset of each channel independently of other channels. Vertical scale and offset specify the vertical parameters of the waveform display for each channel. The oscilloscope only acquires signals that fall within these parameters.

The offset control subtracts a constant DC level from the input signal before the vertical scale factor is applied, and the vertical position control adds a constant number of divisions of signal after the scale factor is applied to the resulting difference.

The vertical scale and position controls have the following effects on the waveform display and the displayed waveform:

The vertical volts per division you set determines the vertical size of the waveform display, allowing you to scale it to contain all of a waveform amplitude or only part.



**Note:** Amplitude-related automatic measurements (for example, peak-to-peak and RMS) will be accurate for vertical windows if the waveform is not clipped (that is, the waveforms are acquired). But if signal amplitude were to extend outside the vertical acquisition window, the data acquired is clipped. Clipped data causes inaccurate results if used in amplitude-related automatic measurements. Clipping also causes inaccurate amplitude values in waveforms that are stored or exported for use in other programs.

If the scale of a math waveform is changed so that the math waveform is clipped, it will affect the amplitude measurements on that math waveform as follows:

- The vertical position adjusts the display of the graticule relative to the waveform display (position is a display control). That is all position does; it does not determine what data is acquired as do vertical scale and offset.
- As you vary vertical offset, the middle voltage level moves relative to zero. This moves the waveform display up or down relative to the acquired waveform. With input signals that are smaller than the window, it appears the waveform moves in the waveform view. Actually, the offset moves the middle of the waveform display up and down on the input signal. Offset moves the waveform display to control the portion of the waveform amplitude the display captures.
- Applying a negative offset moves the vertical range down relative to the DC level of the input signal. Likewise, applying a positive offset moves the vertical range up.



## Horizontal acquisition considerations

The instrument lets you define the horizontal waveform display parameters that determine which segment of an incoming signal becomes the waveform record, following acquisition.

These common parameters specify a horizontal scale and position that is applied to all channels simultaneously.

These parameters are shown in the next figure (horizontal window with delay on):

- The trigger position determines where the trigger event will be located in the waveform record. To see more pretrigger data move your trigger position to the right on the graticule.
- The horizontal position determines the number of pretrigger and posttrigger samples. Samples before the trigger point are pretrigger samples and those after the trigger point are posttrigger samples. When Delay is off, the horizontal position is the same as the trigger position.
- The horizontal delay determines the time from the trigger point to the Horizontal Reference.
- The horizontal scale determines the horizontal size of the display relative to any waveform, allowing you to scale it to contain a waveform edge, a cycle, or several cycles.

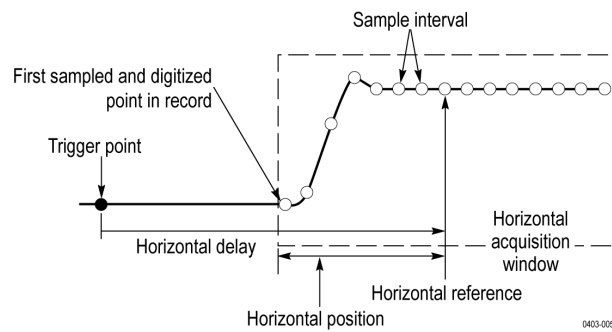

# Triggering concepts

User selected trigger conditions are used to capture waveforms for measurement and analysis.

The next figure shows how triggers fit into the overall instrument operation.

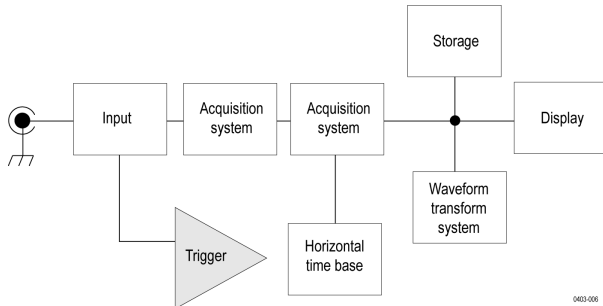

Trigger helps you to capture meaningful waveforms to display on screen. This instrument has simple edge triggers as well as a variety of advanced triggers.

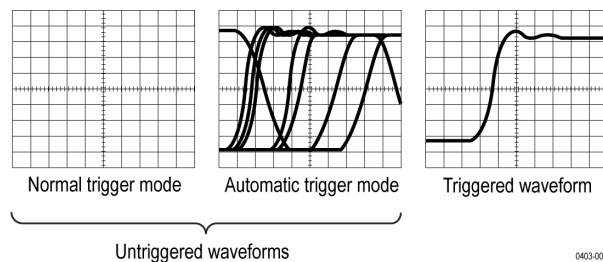

## The trigger event

The trigger event establishes the time-zero point in the waveform record. All waveform record data are located in time with respect to that point. The instrument continuously acquires and retains enough sample points to fill the pretrigger portion of the waveform record (that part of the waveform that is displayed before or to the left of the triggering event on screen).

When a trigger event occurs, the instrument starts acquiring samples to build the post-trigger portion of the waveform record (displayed after or to the right of the trigger event). Once a trigger is recognized, the instrument will not accept another trigger until the acquisition is complete and the holdoff time has expired.

## Trigger sources

The trigger source provides the signal that triggers acquisition. Use a trigger source that is synchronized with the signal that you are acquiring and displaying. You can derive your trigger from the following sources:

- **Input channels:** Analog input channels are the most commonly used trigger sources. You can select any of the input channels. The channel that you select as a trigger source will function whether it is displayed or not.
- **Digital channels:** These sources are available if you have a digital probe connected to a FlexChannel. You can select any combination of digital channels.
- **Bus:** This source is used to trigger a parallel bus or a serial bus. You can include any combination of analog or digital channels to build a parallel bus, or use any channel as a component in a serial bus.

## Trigger types

The available trigger types include:

**Edge:** This is the simplest and most commonly used trigger type, used with both analog and digital signals. An edge trigger event occurs when the trigger source passes through a specified voltage level in the specified direction (rising or falling signal voltage). When the edge trigger source is set to **AC Line**, the instrument uses the instrument's AC power line signal to generate a trigger based on the power line frequency. The 6 Series MSO and MSO58LP instruments also have an **AUX In** connector that is available as another source for the Edge trigger.

**Video Trigger:** Trigger on specified fields or lines of a composite video signal, such as NTSC, PAL, or SECAM.

**Pulse Width:** Trigger on pulses that are inside or outside a specified time range. Can trigger on positive or negative pulses.

**Timeout:** Trigger when no edge transition is detected within a specified time.

**Runt:** Use Runt trigger to trigger on a pulse amplitude that crosses one threshold but fails to cross a second threshold before recrossing the first. It can detect any positive or negative runts, or those that are inside or outside a specified time range. These pulses can also be qualified by the logical state of other channels.

**Window:** Use the Window trigger to trigger when the input signal enters or leaves a window set by two threshold levels. You can further qualify the trigger event in terms of time by using the **Trigger When** controls, or by using the logical state of other channels by using the **Logic Qualification** control.

**Logic:** These are special-purpose triggers that are primarily used with digital logic signals. Logic triggers are available on the main (A) and B event triggers.

**Setup & Hold:** Trigger when a logic input changes state inside the setup and hold times relative to the clock. This type triggers on a setup and hold violation.

**Rise/Fall Time:** Trigger on pulse edges that traverse between two thresholds at faster or slower rates than the specified time. The pulse edges can be positive or negative.

**Sequence:** Use the A Trigger Event with the B Trigger Event to capture complex data.

**Bus:** This trigger is used with both analog and digital signals to set up parallel and serial buses. A bus trigger event occurs when the instrument detects a bus pattern that you set in a bus trigger configuration menu. You must add a bus to the Waveform view before you can set the trigger parameters for that bus.

## Trigger modes

The trigger mode determines how the instrument behaves in the absence of a trigger event:

- **Normal** trigger mode enables the instrument to acquire a waveform only when it is triggered. If no trigger occurs, the instrument does not acquire a waveform, and the last waveform record acquired remains "frozen" on the display. If no last waveform exists, no waveform is displayed.
- **Auto** trigger mode enables the instrument to acquire a waveform even if a trigger does not occur. Auto mode uses a timer that starts after a trigger event occurs. If another trigger event is not detected before the time out, the instrument forces a trigger. The length of time it waits for a trigger event depends on the time base setting.

Auto mode, when forcing triggers in the absence of valid triggering events, does not synchronize the waveform on the display. In other words, successive acquisitions are not triggered at the same point on the waveform; therefore, the waveform will appear to roll across the screen. If valid triggers occur, the display becomes stable.

## Trigger holdoff

Trigger holdoff can help stabilize triggering. When the instrument recognizes a trigger event, it disables the trigger system until acquisition is complete. In addition, the trigger system remains disabled during the holdoff period that follows each acquisition. Adjust holdoff to obtain stable triggering when the instrument is triggering on undesired trigger events.

A digital pulse train is a good example of a complex waveform. Each pulse looks like any other, so many possible trigger points exist. Not all of these will result in the same display. The holdoff period allows the instrument to trigger on the correct edge, resulting in a stable display.

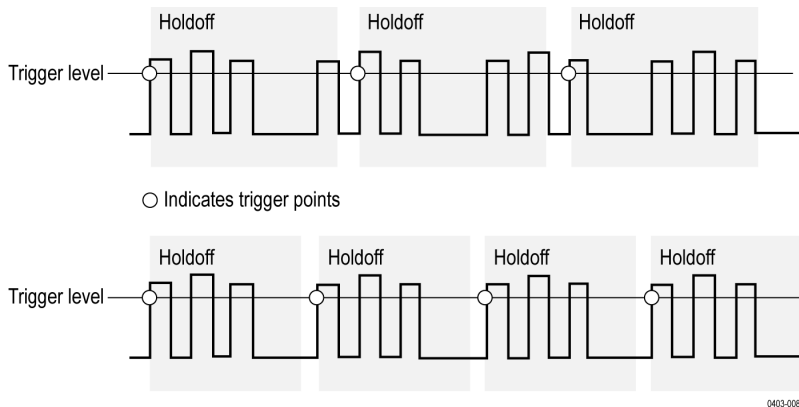

At the longer holdoff time for the top waveform, unstable triggering occurs. With a shorter holdoff set for the bottom waveform, triggers all occur on the first pulse in the burst to remedy the unstable trigger.

The Holdoff setting range is 0 s (minimum holdoff available) to 10 s (maximum holdoff available). For more information on how to set holdoff, see [Set Trigger Holdoff](#) on page 129.

If you select Auto holdoff, the instrument selects a holdoff value for you. When Trigger Holdoff is set to Random, the instrument delays the trigger a random amount of time between triggers. This means that successive acquisitions are unrelated to the previous trigger signal.

[Learn about Trigger coupling](#)

[Learn about Trigger modes](#)

## Trigger coupling

Trigger coupling determines what part of the signal is passed to the trigger circuit. Edge triggering can use all available coupling types: DC, Low Frequency Rejection, High Frequency Rejection, and Noise Rejection. All of the advanced trigger types use DC coupling only.

- **DC.** This coupling passes all input signals to the trigger circuitry.
- **HF Reject.** This coupling attenuates signals above 50 kHz before passing the signal to the trigger circuitry.
- **LF Reject.** This coupling attenuates signals below 50 kHz before passing the signal to the trigger circuitry.
- **Noise Reject.** This coupling provides stable triggering by increasing the trigger hysteresis. Increased hysteresis reduces the trigger sensitivity to noise but may require greater signal amplitude.

## Trigger slope and level

The slope control determines whether the instrument finds the trigger point on the rising or the falling edge of a signal. The level control determines where on that edge the trigger point occurs. See the next figure.

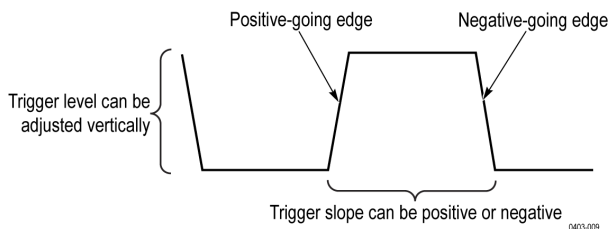

[Learn about trigger position](#)

## Trigger position in waveform record

Trigger position is an adjustable feature that defines where the trigger occurs on the waveform record. It lets you choose how much the instrument acquires before and after the trigger event. The part of the record that occurs before the trigger is the pretrigger portion. The part that occurs after the trigger is the posttrigger portion. A longer posttrigger period may be useful when you want to see the effects an event has on your system under test.

Pretrigger data can be valuable when troubleshooting. For example, if you are trying to find the cause of an unwanted glitch in your test circuit, you can trigger on the glitch and make the pretrigger period large enough to capture data before the glitch. By analyzing what happens before the glitch, you may uncover information that helps you find the source of the glitch.

## Trigger delay

Use the Trigger Delay to trigger the instrument a specified period of time after the A trigger. After the A trigger arms the trigger system, the instrument triggers on the next B trigger event that occurs after the time that you specify.

You can trigger with the A trigger system alone or you can combine the A trigger with the B (Delayed) trigger to trigger on sequential events. When using sequential triggering, the A trigger event arms the trigger system, and the B trigger event triggers the instrument when the B trigger conditions are met.

A and B triggers can (and typically do) have separate sources. The B trigger condition can be based on a time delay or a specified number of counted events.

## Advanced triggering

You can check the advanced trigger status in the settings bar. The readout indicates the trigger type and then shows sources, levels, or any other parameters that are important for the particular trigger type.

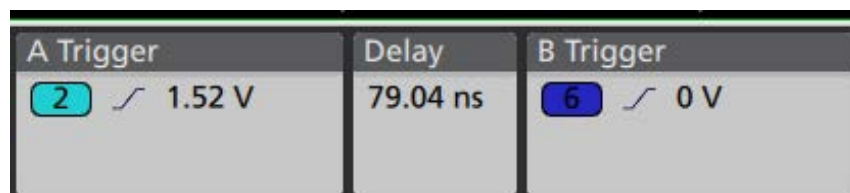

## Bus triggering concepts

A bus trigger occurs when a supported instrument detects a bus pattern that you specify for a parallel bus, or a bus cycle you select for a serial bus.

You can set the instrument to trigger on a parallel bus when the instrument detects a match to the bus pattern, or when the instrument detects that the value on the bus is < or > the value of the bus pattern. The pattern can be in Binary or Hex format.

You can set the instrument to trigger on an SPI bus when the instrument detects an SS Active bus cycle or Data.

You can set the instrument to trigger on an I2C bus when the instrument detects a Start, Stop, Repeated Start, Missing Ack, Address, Data, or Addr + Data bus cycle or activity.

You can set the instrument to trigger on an I3C bus when the instrument detects a Start, Repeated Start, Data, Address, I3C SDR Direct, I3C SDR Broadcast, Errors, Hot-Join, Stop, HDR Restart, or HDR Exit activity.

You can set the instrument to trigger on a USB bus when the instrument detects a Sync, Reset, Suspend, Resume, End of Packet, Token (Address) Packet, Data Packet, Handshake Packet, Special Packet, or Error bus cycle or activity.

You can set the instrument to trigger on an RS232 bus when the instrument detects a Start, End of Packet, Data, or Parity Error bus cycle or activity.

You can set the instrument to trigger on an CAN bus when the instrument detects a Start of Frame, Type of Frame, Identifier, Data, Id and Data, End of Frame, Missing Acq, or Bit Stuffing Error bus cycle or activity.

You can set the instrument to trigger on an LIN bus when the instrument detects a Sync, Identifier, Data, Identifier & Data, Wakeup Frame, Sleep Frame, or Error bus cycle or activity.

You can set the instrument to trigger on an FlexRay bus when the instrument detects a Start of Frame, Indicator Bits, Frame Id, Cycle Count, Header Fields, Data, Identifier & Data, End of Frame, or Error bus cycle or activity.

You can set the instrument to trigger on an Ethernet bus when the instrument detects a Start of Frame, MAC Address, MAC Length/Type, IP Header, TCP Header, Client Data, End of Packet, Idle, or FCS (CRC) Error bus cycle or activity.

You can set the instrument to trigger on an AUDIO bus when the instrument detects a Word Select, or Data bus cycle or activity.

You can set the instrument to trigger on a SVID bus when the instrument detects a Start, Slave address, Command, Payload, and Error bus cycle or activity.

For all the serial standard buses, you can also set the component threshold levels through the Bus Setup menu.

## Pulse width trigger concepts

A pulse width trigger occurs when the instrument detects a pulse that is inside or outside some specified time range. The instrument can trigger on positive or negative width pulses. Pulse width triggers can also be qualified by the logical state of other channels.

## Timeout trigger concepts

A timeout trigger occurs when the instrument does not detect an expected pulse transition within a user specified period of time, such as when a signal gets stuck either high or low. If the pulse transition occurs prior to a specified timeout time (the expected case), then no trigger results.

## Runt trigger concepts

A runt trigger occurs when the instrument detects a short pulse that crosses one threshold but fails to cross a second threshold before recrossing the first.

- You can set the instrument to detect any positive or negative runt pulse, or only those wider than a specified minimum width.
- Runt pulses can also be qualified by the logical state of other channels.

## Window trigger

Use the Window trigger to trigger the instrument when the input signal rises above an upper threshold level or falls below a lower threshold level.

After setting these levels, you can specify whether you want to trigger the instrument as the signal is entering or leaving the threshold window. You can further qualify the trigger event in terms of time, or by the logical state of other channels.

## Logic trigger concepts

For various trigger types, touch Logic Qualification to toggle logic qualification On to trigger the instrument when the logic patterns are true. You can set each bit to be active High, Low, or Don't Care. You can also set the logic thresholds and define the logic (AND, OR, NOR, or NAND).

## Setup and Hold trigger concepts

A setup/hold trigger occurs when a data signal changes state inside of the user specified setup and hold times relative to the clock. When you use setup/hold triggering, you define:

- The channel containing the logic input (the data source) and the channel containing the clock (the clock source)
- The direction of the clock edge to use
- The clocking level and data threshold that the instrument uses to determine if a clock or data transition has occurred
- The setup and hold times that together define a time range relative to the clock

Data that changes state within the setup/hold violation zone triggers the instrument. The next figure shows how the setup and hold times that you choose position the violation zone relative to the clock.

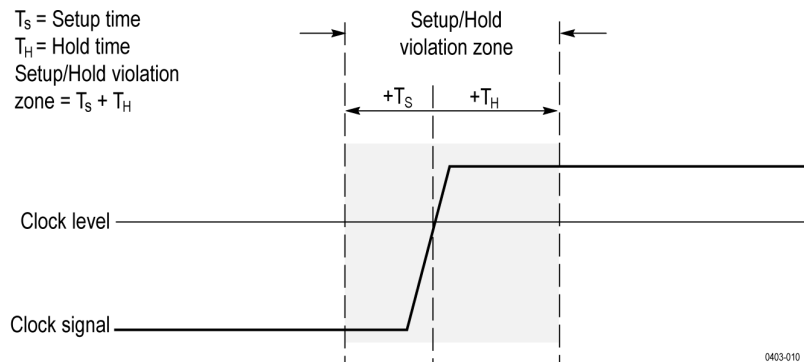

Setup/hold triggering uses the setup/hold violation zone to detect when data is unstable too near the time it is clocked. Each time trigger holdoff ends, the instrument monitors the data and clock sources. When a clock edge occurs, the instrument checks the data stream it is processing (from the data source) for transitions occurring within the setup/hold violation zone. If any occur, the instrument triggers with the trigger point located at the clock edge.

The setup/hold violation zone spans the clocking edge as shown above. The instrument detects and triggers on data that does not become stable long enough before the clock (setup time violation) or that does not stay stable long enough after the clock (hold time violation).

## Rise/Fall time trigger concepts

Rise/Fall time triggering is based on the slope (change in voltage/change in time) of a pulse edge.

Use the Rise/Fall trigger to trigger the instrument on pulse edges that traverse between two thresholds at faster or slower rates than the specified time. You can set up the instrument to trigger on positive or negative edges. The trigger can be logic qualified.

## Sequential (A B) trigger concepts

In applications that involve two or more signals, you may be able to use sequential triggering to capture more complex events. Sequential triggering uses the A (Main) trigger to arm the trigger system, and then uses the B (Delayed) trigger to trigger the instrument if a specific condition is met.

You can choose one of two trigger conditions:

- Trigger after a Delay. After the A trigger arms the trigger system, the instrument triggers on the next B-trigger event that occurs after the trigger delay time. You can set the trigger delay time with the keypad or a multipurpose knob.
- Trigger on the Nth event. After the A trigger arms the trigger system, the instrument triggers on the Nth B event. You can set the number of B events with the keypad or a multipurpose knob.



**Note:** The traditional delayed trigger mode called "Runs After" is controlled by the Horizontal Delay feature. You can use horizontal delay to delay acquisition from any trigger event, whether from the A trigger alone or from a sequential trigger that uses both the A and B triggers.

## Visual Trigger concepts

Visual Trigger makes the identification of the desired waveform events quick and easy by scanning through all acquired analog waveforms and graphically comparing them to geometric shapes on the display. By discarding acquired waveforms that do not meet the graphical definition, Visual Triggering extends the oscilloscope's trigger capabilities beyond the traditional hardware trigger system.

Although Visual Trigger is similar in appearance to mask testing, where acquired waveforms are graphically compared to mask regions on the display, there is an important difference. Visual Trigger only displays waveforms that conform to the specified shape, so only conforming waveforms are measured.

Creating a visual trigger always begins with setting up the oscilloscope's hardware trigger system to acquire the waveforms in a standard trigger mode. The trigger can be as simple as an edge trigger or as complex as a pulse width, runt, logic multi-state trigger.

Once a standard trigger is set up, create visual trigger areas to refine the trigger condition. Each visual trigger area is associated with a specific analog input channel, and you can define areas for multiple channels. See [Create Visual Trigger areas](#) on page 130. By default, newly-created areas are rectangular, are associated with the selected channel, and are assigned the logic condition In when created.

Once areas are created on the oscilloscope's display, they can be re-positioned, re-sized, and/or edited interactively on the screen to create the required shape to define the visual trigger condition. See [Edit visual trigger areas using the Area menu](#) on page 132.

The visual trigger **Area** menu enables more precise editing of each Visual Trigger area. You can set exact coordinates for the vertices of each area in amplitude and time values, and assign the area to a specified signal source (channel). The menu also lets you set the logic condition for each shape (the waveform must be inside the area, outside the area, or don't care). Double-tap on an area to open the Area menu. See [Edit visual trigger areas using the Area menu](#) on page 132.

Finally, a logical equation is automatically generated when two or more areas are added to the display. This equation describes how Visual Trigger uses the areas to determine which acquired waveforms are displayed and which are discarded. For example, the equation A1 & A2 & A3 specifies that the waveform must meet the area logic condition for all three areas to display a waveform.

## Visual trigger areas

How an area is shown depends on the instrument display mode. In Stacked mode, areas are outlined in cyan and have a semi-transparent cyan fill. The areas display the area number and the logic condition setting icon. Areas in Stacked mode do not include a channel label.

In Overlay mode, areas are outlined in the source channel's color and have a semi-transparent fill in the same color. The areas display the area number, the logic condition setting icon, and the channel with which the area is associated.

When zoom is active, areas are drawn in both the overview and zoomed view.

Area vertices all have specific time and amplitude values associated with them. These values are maintained as you change other controls. This means that the size of the areas change to when you change horizontal or vertical scale settings. The areas will also move up or down with vertical position changes. Any text that is displayed as part of the area is still displayed in the standard size, so you can still easily identify the location visual trigger areas.

If a visual trigger area is off the display, the instrument displays a directional arrow that points to the location of the visual trigger area. If zoom is on, the directional arrows are drawn in both the zoom overview and the zoomed view as needed.

## Moving visual trigger areas

To move a visual trigger area, just touch and drag the area to a new position.



When dragging a visual trigger area while in Stacked or Overlay display mode, the area source remains the same.

When dragging a visual trigger area while in Stacked display mode, you cannot drag a visual trigger area from one waveform slice to another.

### Visual trigger caveats

- Visual triggering is not compatible with Fast Acq or Fast Frame modes. If visual triggering is active and you turn on one of these modes, then visual triggering is turned off and vice versa.
- You cannot save or recall visual trigger definitions as individual items. However, you can save visual trigger definitions as part of **Session** and **Setup** files.

# Waveform display concepts

This instrument includes a flexible, customizable display that lets you control how waveforms appear. The figure shows how the display features fit into the overall instrument operation.

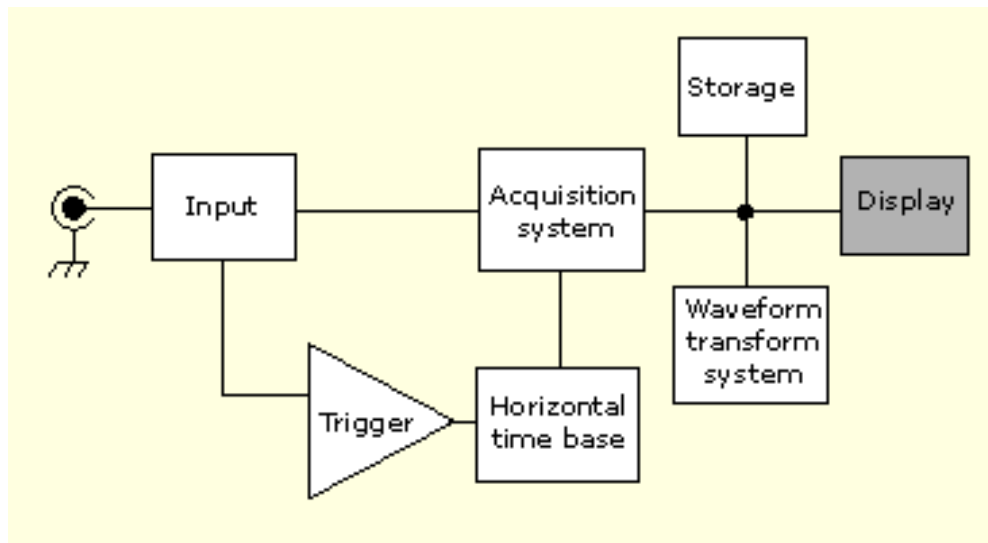

The display shows analog, digital, math, reference, and bus waveforms. The waveforms include channel markers, individual waveform graticule readings, and trigger source and level indicators. You can set the display to stack each waveform vertically in separate graticules, called 'slices' (the default mode), or overlay all the waveforms on the screen (traditional waveform view).

You can also add histogram, spectral, eye, and measurement results views (plots) for individual measurements. These plot views are contained within their own view window and can be moved within the overall view area.

## Waveform preview mode

The waveform preview attempts to show what the next acquisition will look like when the acquisition is delayed due to slow triggers or long acquisition duration, or when the acquisitions have stopped. Waveform preview recalculates math waveforms, but does not represent changes in trigger levels, trigger modes, or different acquisition modes.

## Horizontal position and the horizontal reference point

The time value you set for horizontal position is measured from the trigger point to the horizontal reference point. This is not the same as the time value from the trigger point to the start of the waveform record, unless you set the horizontal reference to 0%. See the next figure.

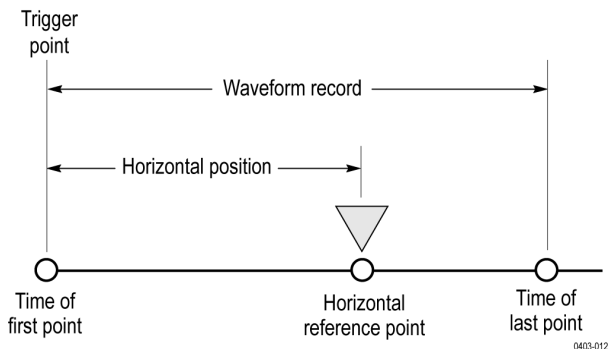

# Measurement concepts

## Measurement variables

By knowing how the instrument makes calculations, you may better understand how to use your instrument and how to interpret your results. The instrument uses a variety of variables in its calculations. These include:

### Definition of Base and Top

**Base** is the value used as the 0% level in measurements such as fall time and rise time.

**Top** is the value used as the 100% level in measurements such as fall time and rise time. For example, if you set the 10% to 90% rise time, then the instrument calculates 10% and 90% as percentages of Top and Base, with Top representing 100%.

The exact value of Base and Top depends on which Base Top Method you select in the Reference Levels panel of a Measurement configuration menu. It also depends on if you set the reference level to be Global (applies to all measurements set as Global in the Reference Levels panel), or Local (just applies to the measurement that is set to Local).

### Base, Top calculation methods

The Base Top calculation method is set in the Reference Levels panel of a Measurement configuration menu.

**Auto** is the default method, and automatically determines the best Base Top method to use. Most commonly sets the Base Top method to Histogram Mode.

**MinMax** defines the 0% and the 100% waveform levels as the lowest value and the highest value samples of the waveform record. This setting is best for examining waveforms that have no large, flat portions at a common value, such as sine waves and triangle waves - almost any waveform except for pulses.

The MinMax method calculates the Top and Base values as follows:

Top = Max

and

Base = Min

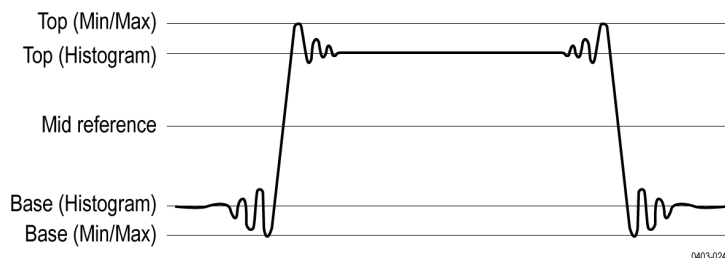

**Histogram Mean** uses histogram analysis to calculate the mean or average value using all values above and below the waveform midpoint. Top is set to the mean high value, and Base is set to the mean low value. This setting is best for examining eye patterns and optical signals.

**Histogram Mode** uses histogram analysis to select the most common values either above or below the midpoint. Since this statistical approach ignores short-term aberrations (overshoot, ringing, and so on), Mode is the best setting for examining pulses.

The oscilloscope calculates the histogram-based *Top* and *Base* values as follows:

1. It makes a histogram of the record with one bin for each digitizing level.
2. It splits the histogram into two sections at the halfway point between *Min* and *Max* (also called *Mid*).

3. The level with the most points in the upper histogram is the *Top* value, and the level with the most points in the lower histogram is the *Base* value.

If *Mid* gives the largest peak value within the histogram, the oscilloscope returns the *Mid* value for both *Top* and *Base* (this is probably a very low amplitude waveform).

If more than one histogram level (bin) has the maximum value, the oscilloscope chooses the bin farthest from *Mid*.

This algorithm does not work well for two-level waveforms with greater than about 100% overshoot.

**Histogram Eye Center** uses histogram analysis of the amplitudes in the center of each bit (unit interval) while ignoring the waveform during bit transitions. The histogram sets the *Top* at the nominal high level and *Base* at the nominal low level. This is similar to the Histogram Mode, except it is less influenced by the shape of the waveform during transitions between bits.

## HighRef, MidRef, LowRef

You set the various reference levels, through the Reference Levels tab of the Measure menu. They include:

**High** is the waveform high reference level (also HighRef). Used in all measurements. Typically set to 90%. You can set it from 0% to 100% or to a voltage level.

**Mid** is the waveform middle reference level (also MidRef). Mid reference levels are used in all measurements that need to find edges. Typically set to 50%. You can set it from 0% to 100% or to a voltage level.

**Low** is the waveform low reference level (also LowRef). Used in all measurements. Typically set to 10%. You can set it from 0% to 100% or to a voltage level.

High, mid and low reference levels can be set uniquely for each measurement source. Reference levels can also be set differently for rising edge detection and falling edge detection.

## Other variables

The instrument also measures several values itself that it uses to help calculate measurements.

**Record Length** is the number of data points in the time base. You set it with the Horizontal menu Record Length item.

**Start** is the location of the start of the measurement zone (X-value). It is 0.0 samples unless you are making a gated measurement. When you use cursor gated measurements, it is the location of the left vertical cursor.

**End** is the location of the end of the measurement zone (X-value). It is (*RecordLength* – 1.0) samples unless you are making a gated measurement. When you use cursor gated measurements, it is the location of the right vertical cursor.

**Hysteresis** Is the hysteresis band of the waveform amplitude.

For example, once a crossing has been measured in a negative direction, the waveform data must fall below the hysteresis value of the amplitude from the *Mid* reference point before the measurement system is armed and ready for a positive crossing. Similarly, after a positive *Mid* reference crossing, waveform data must go above the hysteresis value of the amplitude before a negative crossing can be measured. Hysteresis is useful when you are measuring noisy signals, because it allows the oscilloscope to ignore minor fluctuations in the signal.

## Edge calculations

**Edge1, Edge2, and Edge3** refer to the first, second, and third *Mid* reference edge times, respectively.

An edge can be detected when the waveform is either rising or falling past Midref. The direction of the edges alternates, that is, if Edge1 is rising, Edge2 will be falling.

A rising edge has positive polarity. A falling edge has negative polarity.

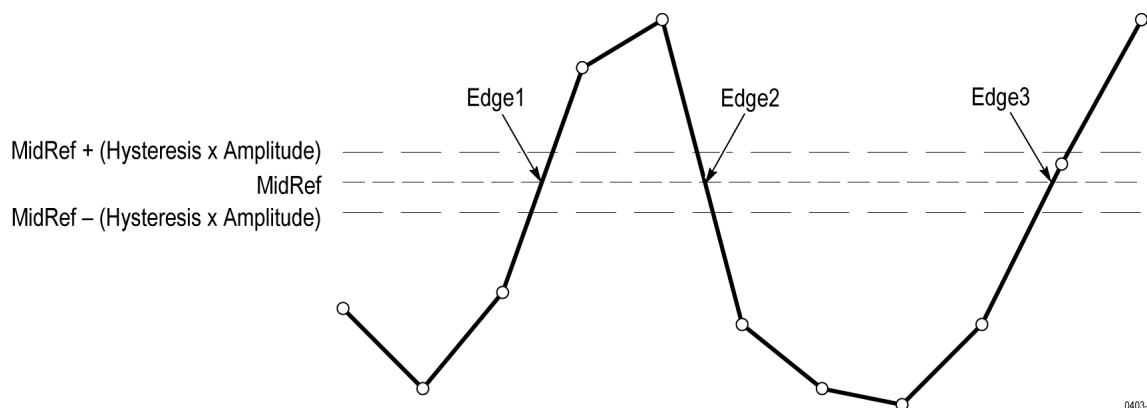

The instrument calculates these values as follows:

1. Find the first *Mid* reference edge in the waveform record or the gated region. This is *Edge1*.
2. Continuing from *Edge1*, find the next *Mid* reference edge in the waveform record (or the gated region) of the opposite direction of *Edge1*. This is *Edge2*.
3. Continuing from *Edge2*, find the next *Mid* reference edge in the waveform record (or the gated region) of the same direction as *Edge1*. This is *Edge3*.

Cycle-cycle measurements are made on each cycle of the waveform. In the diagram above a cycle starts at *Edge1* and ends at *Edge3*.

**TPOS** is the location of the sample just before the trigger point (the time reference zero sample). In other terms, it contains the domain reference location. This location is where time = 0.

**TSOFF** is the offset between **TPOS** and the actual trigger point. In other words, it is the trigger sample offset. Values range between 0.0 and 1.0 samples. This value is determined by the instrument when it receives a trigger. The actual zero reference (trigger) location in the measurement record is at (**TPOS** + **TSOFF**).

## Missing or out-of-range samples

If some samples in the waveform are missing or off-scale, the measurements will interpolate between known samples to make an appropriate guess as to the sample value. Missing samples at the ends of the measurement record will be assumed to have the value of the nearest known sample. The interpolation method can be changed in User Preferences.

When samples are out of range, the measurement will give a warning to that effect (for example, CLIPPING) if the measurement could change by extending the measurement range slightly. The algorithms assume the samples recover from an overdrive condition instantaneously.

For example, if the *Mid* reference level is set directly, then *Mid* would not change even if samples were out of range. However, if *Mid* was chosen using the % choice from the **Set Levels in %** selection of the Measure menu Reference Levels tab, then *Mid* could give a CLIPPING warning.

## Math waveforms

Once you have acquired waveforms or taken measurements on waveforms, the instrument can mathematically combine them to create a waveform that supports your data-analysis task. For example, you might have a waveform clouded by background noise. You can obtain a cleaner waveform by subtracting the background noise from your original waveform. Or, you can integrate a single waveform into an integral math waveform as shown below.

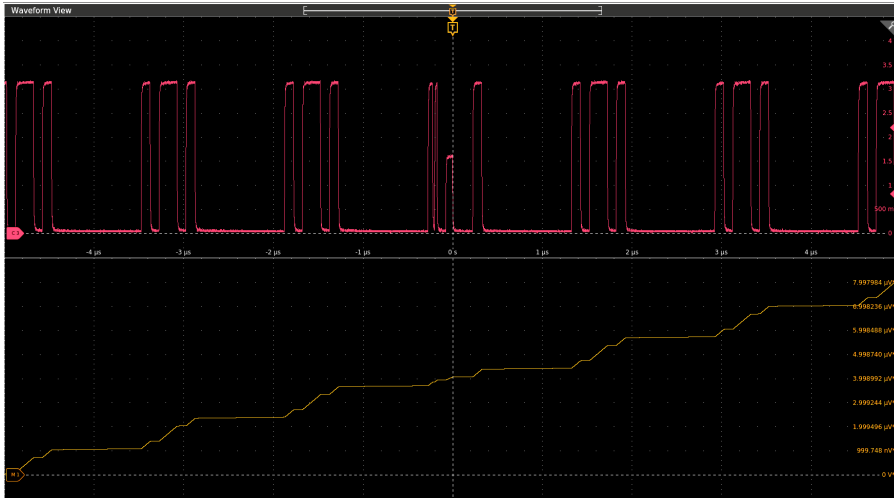

With spectral analysis you can analyze waveforms in the frequency domain. See the next figure.

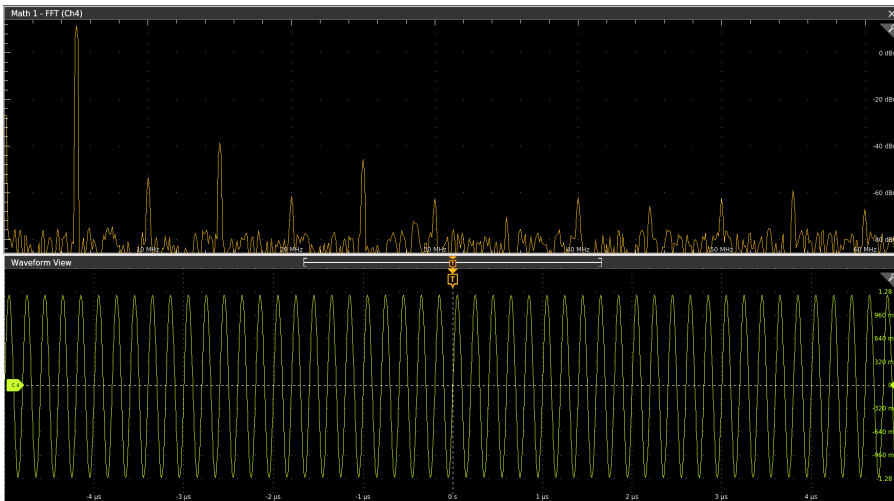

This instrument supports mathematical combination and functional transformations of waveforms it acquires. The next figure shows this concept:

You create math waveforms to support the analysis of your channel and reference waveforms. By combining and transforming source waveforms and other data into math waveforms, you can derive the data view that your application requires. Create math waveforms that result from:

- Mathematical operations on one or several waveforms: add, subtract, multiply, and divide.
- Functional transformations of waveforms, such as integration, differentiation, and so on.
- Spectral analysis of waveforms, such as testing impulse response.

Measurement scalars can be used in math expressions. For example, you can measure the average of a waveform (using the measurement capabilities of the instrument) and subtract it from the original waveform to define a new math waveform. For example:  $\text{Ch1} - \text{mean}(\text{amplitude}(\text{Ch1}))$ .

## Math waveform elements

You can create Math waveforms from the following:

- Channel waveforms

- Reference waveforms
- Measurement scalars (automated measurements) that measure channel, reference, or math waveforms, or histograms.
- Other math waveforms
- Variables
- Filters

## Dependencies

In general, math waveforms that include sources as operands are affected by updates to those sources:

- Shifts in amplitude or DC level of input sources that cause the source to clip also clip the waveform data supplied to the math waveform.
- Changes to the vertical offset setting for a channel source that clips its data also clips the waveform data supplied to the math waveform.
- Changes to the acquisition mode globally affects all input channel sources, modifying any math waveforms using them. For example, with the acquisition mode set to Envelope, a Ch1 + Ch2 math waveform will receive enveloped channel 1 and channel 2 data, and will also be an envelope waveform.
- Clearing the data in a waveform source causes a baseline (ground) to be delivered to any math waveform that includes that source until the source receives new data.

## Math waveform sources

You can create Math waveforms from the following:

- Channel waveforms
- Reference waveforms
- Measurement scalars (automated measurements) that measure channel, reference, or math waveforms, or histograms.
- Other math waveforms
- Variables
- Filters

## Guidelines for working with math waveforms

Use the following guidelines when working with math waveforms:

- Keep math waveforms simple. If the math expression becomes too complex, try separating the expression into more than one math waveform and then combining the waveforms (for example,  $\text{Math1} = \text{Math2} + \text{Math4}$ ).
- Math calculations are not available on digital channels.
- You cannot use math waveforms with Fast Acquisition mode.
- Math waveforms cannot be turned on without a math expression.
- Math waveforms cannot be created from a reference waveform that was saved in Fast Acquisition mode.
- To avoid syntax errors in a math expression, verify the use of operators, parentheses, operands, and the spelling of functions.
- When working with reference waveforms, if one or more reference waveforms are used as part of a math waveform, the number of frames in the math waveform is the smallest of all source waveforms (reference, math, or channel waveforms).
- If one or more reference waveforms are used in a math waveform, the record length is equal to the smallest of all the source waveforms (reference, math, or channel waveforms). The math is calculated using the first point from each source, followed by the next point, and so forth. This is true even if the sources have different times between points in the record.

## Math waveform editor syntax

You can build math waveforms using the predefined expressions or the equation editor. To help you create valid math waveforms, the following tools will block most illegal entries by disabling any window element that would create an invalid entry in the math waveform expression.

Predefined expressions are accessible using the FFT or Basic Math Types.

The following syntax describes the valid math expressions you can use with the Equation Editor for the Advanced Math Type:

A math expression is composed of settings, functions, scalars and sources.

Settings have the syntax [settingName=settingValue] and are generally applied to measurements. The setting applies to everything to the right of the closing square brackets.

Example: [CoefFileName="highpass\_0.25bw.flit"]HighPass(Ch1)

CoefFileName is the setting and is used as the high pass filter on channel 1.

Example: [CoefFileName="highpass\_0.25bw.flit"] HighPass(Ch1) + [CoefFileName="lowpass\_0.05bw.flit"] LowPass(Ch2)

The high pass filter file is applied to channel 1 and lowpass\_0.05bw.flit is applied to channel 2.

Functions, except for basic and logic functions, have the syntax function(source).

In the previous examples the functions are HighPass and LowPass.

Basic and logic functions have the syntax

source1 function source2.

Examples: Ch1 \* Ch2

Ch1 AND Ch2

Ch1 >= Ch2

Logic functions, ==|<|>|!=|<=|>=|AND|OR|NAND|NOR|XOR|EQV result in a waveform consisting of binary 0 and 1 values.

Scalars can be integers, floating point values, PI or meas<x>.

Sources can be Ch<x>, Ref<x>, Math<x>

## Math waveform differentiation

The math capabilities of the instrument include waveform differentiation. This allows you to display a derivative math waveform that indicates the instantaneous rate of change of the waveform acquired.

Derivative waveforms are used in the measurement of slew rate of amplifiers and in educational applications. You can create a derivative math waveform and then use it as a source for another derivative waveform. The result is the second derivative of the waveform that was first differentiated.

The math waveform, derived from the sampled waveform, is computed based on the following equation:

$$Y_n = (X(n + 1) - X_n) * 1/T$$

Where: **X** is the source waveform, **Y** is the derivative math waveform, and **T** is the time between samples.

Since the resultant math waveform is a derivative waveform (see the next figure), its vertical scale is in volts/second (its horizontal scale is in seconds). The source signal is differentiated over its entire record length; therefore, the math waveform record length equals that of the source waveform.



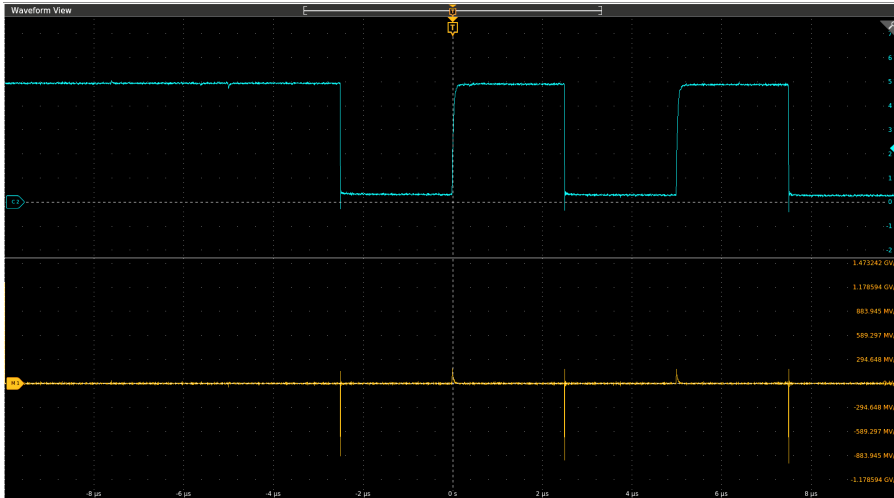

## Math waveform offset, position, and scale

The settings that you make for offset, scale, and position affect the math waveform you obtain. Here are some tips for obtaining a good display:

- Scale and position the source waveform so that it is contained on the screen. (Off-screen waveforms may be clipped, resulting in errors in the derivative waveform).
- Use vertical position and vertical offset to position your source waveform. The vertical position and offset will not affect your derivative waveform unless you position the source waveform off screen so that it is clipped.

## Waveform integration

The math capabilities of the instrument include waveform integration. This allows you to display an integral math waveform that is an integrated version of the acquired waveform.

Use integral waveforms in the following applications:

- Measuring power and energy, such as in switching power supplies.
- Characterizing mechanical transducers, as when integrating the output of an accelerometer to obtain velocity.

The integral math waveform, derived from the sampled waveform, is computed based on the following equation:

$$y(n) = scale \sum_{i=1}^n \frac{x(i) + x(i-1)}{2} T$$

Where:  $\mathbf{x(i)}$  is the source waveform,  $\mathbf{y(n)}$  is a point in the integral math waveform,  $\mathbf{scale}$  is the output scale factor, and  $\mathbf{T}$  is the time between samples.

Since the resultant math waveform is an integral waveform, its vertical scale is in volt-seconds (its horizontal scale is in seconds). The source signal is integrated over its entire record length; therefore, the math waveform record length equals that of the source waveform.

### Offset and position

When creating integrated math waveforms from live channel waveforms, consider the following:

- You should scale and position the source waveform so that it is contained on screen. (Off screen waveforms may be clipped, which will result in errors in the integral waveform.)
- You can use vertical position and vertical offset to position your source waveform. The vertical position and vertical offset will not affect your integral waveform unless you position the source waveform off screen so that it is clipped.

## DC offset

The source waveforms that you connect to the instrument often have a DC offset component. The instrument integrates this offset along with the time-varying portions of your waveform. Even a few divisions of offset in the source waveform may be enough to ensure that the integral waveform saturates (clips), especially with long record lengths.

## FFT process

The FFT process mathematically converts the standard time-domain signal (repetitive or single-shot acquisition) into its frequency components.

The FFT function processes the waveform record and displays the FFT frequency domain record, which contains the input signal frequency components from DC (0 Hz) to  $\frac{1}{2}$  the sample rate (also called the *Nyquist frequency*).

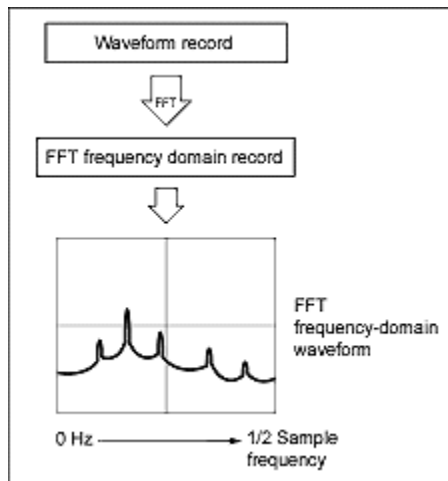

## Nyquist frequency

The highest frequency that any digital oscilloscope can measure without errors is one-half of the sample rate. This frequency is called the Nyquist frequency.

The FFT waveform displays the input signal frequency components from DC (0 Hz) to the Nyquist frequency.

## FFT and aliasing

Aliasing occurs when the input frequency of a signal is greater than one half of the sampling frequency (the sample rate).

Set the sample rate high enough so that the signals in the spectrum appear at their correct frequency as opposed to a lower aliased frequency value. Also, complex signal shapes that have many harmonics in them, such as a triangle or square wave, can appear to be OK in the time domain when in fact many of the harmonics in that signal are aliased.

One way to check for aliasing is to increase the sample rate and observe whether any of the harmonics unwrap to different frequency locations.

Another way to recognize aliasing is to realize that higher order harmonics usually have decreasing magnitudes compared to lower order harmonics. Thus, if you see a series of increasing harmonic magnitude values as frequency increases then you can suspect that they may be aliased. In the spectral math waveform, the actual higher frequency components are under sampled, and therefore they appear as lower frequency aliases that "fold back" around the Nyquist point. (See the next figure.) You may test by increasing the sample rate and observing if aliases unwrap to different frequency positions.

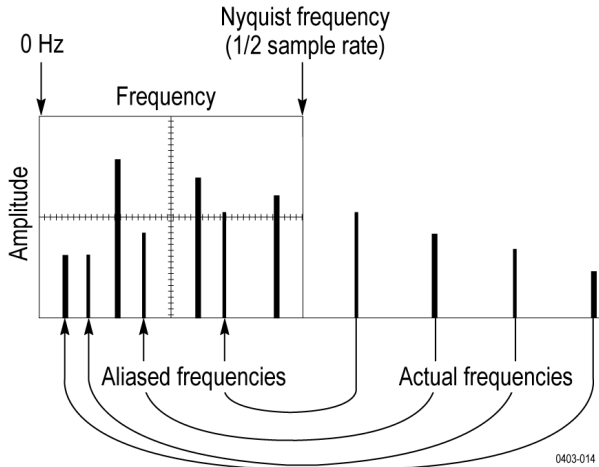

If you have a variable-frequency signal source, another way to observe aliasing is to adjust the frequency slowly while watching the spectral display. If some of the harmonics are aliased, you will see the harmonics decreasing in frequency when they should be increasing or vice versa.

## Blackman-Harris FFT window concepts

FFT windows have various resolution bandwidths and scallop losses (see the figure below). Choose the one that best allows you to view the signal characteristics you are interested in.

The Blackman-Harris window has a low amount of energy leakage compared to the other windows. Its best use is for single frequency signals to look for higher order harmonics.

### Blackman-Harris window

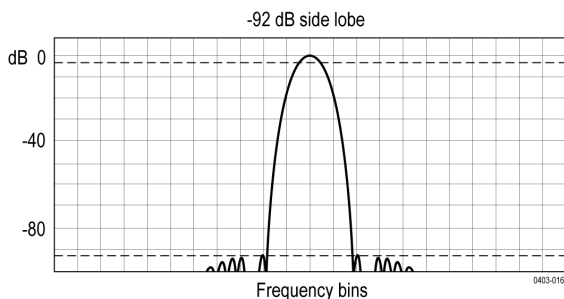
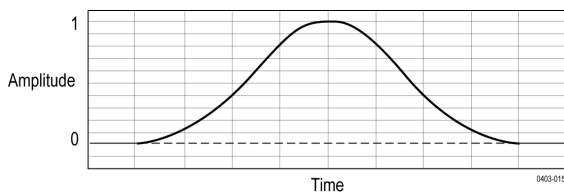

## Flattop2 window

This window has the lowest scallop loss of any of the windows. It also has a wider resolution bandwidth but lower side lobe attenuation. Also, it is unique because the time domain shape has negative values.



**Note:** The Flattop2 window is useful for high accuracy magnitude measurements for signals that do not require very narrow bandwidth.

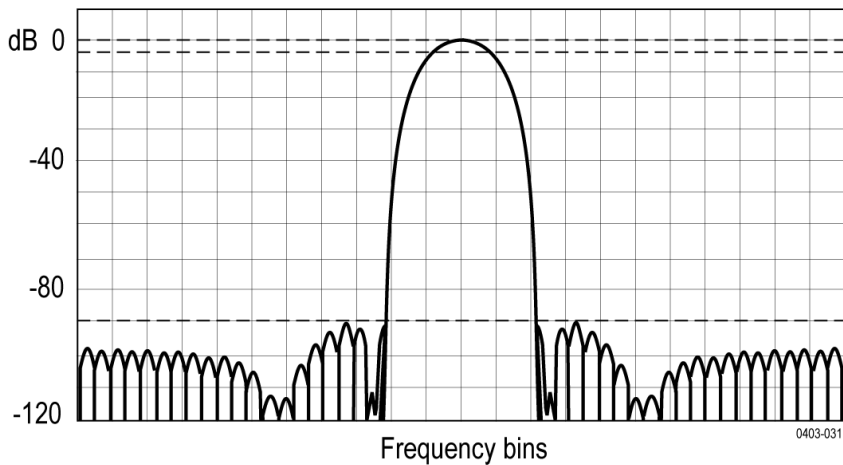
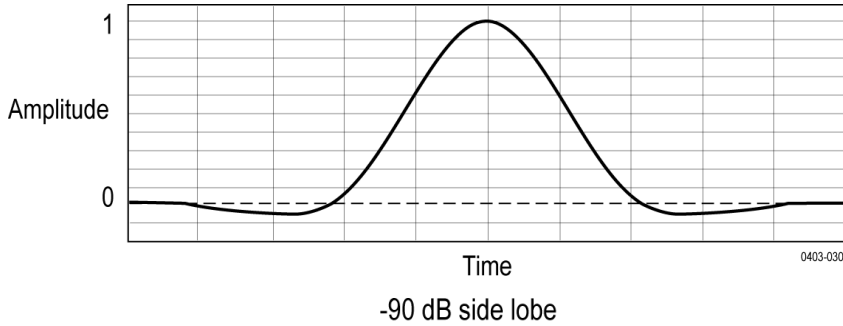

## Gaussian window

This is the default window function (see the next figure). It is unique in that the time-domain shape of an exponential Gaussian function transforms into a Gaussian exponential shape in the frequency domain.



**Note:** This window provides optimal localization in both the time and the frequency domain.

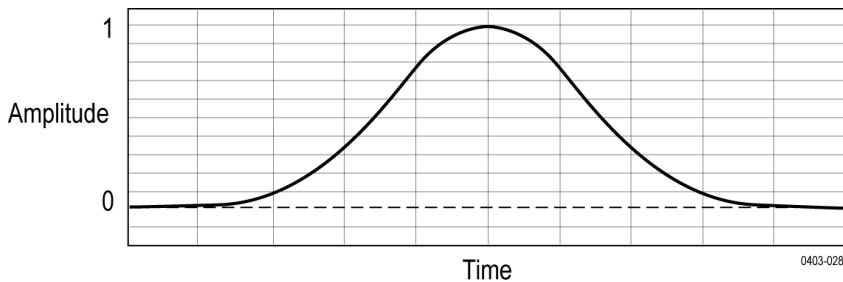

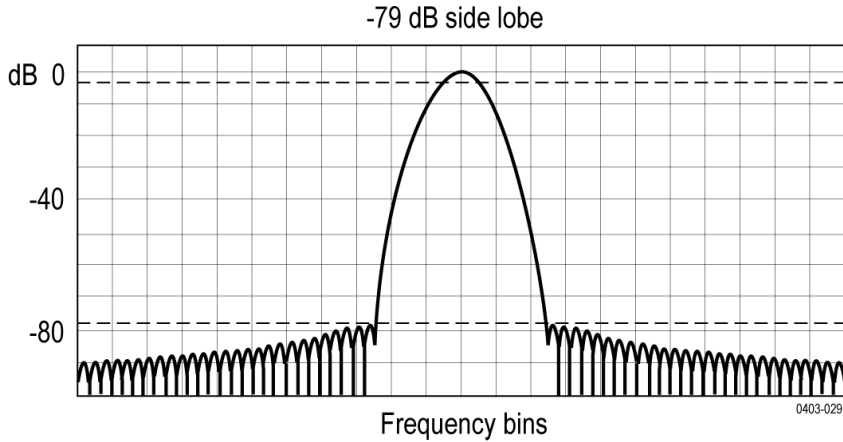

## Hanning FFT window

FFT windows have various resolution bandwidths and scallop losses (see the figure below). Choose the one that best allows you to view the signal characteristics you are interested in.

The Hanning window has the narrowest resolution bandwidth, but higher side lobes. Hanning has slightly poorer frequency resolution than Hamming. Hanning is best for measuring sine, periodic, and narrow-band random noise, and transients or bursts where the signal levels before and after the event are significantly different.

### Hanning window

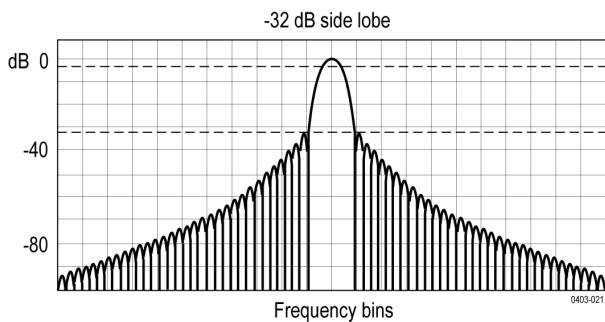
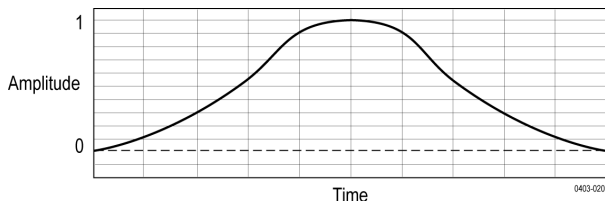

### Hamming window

This window is unique in that the time domain shape does not taper all the way to zero at the ends. This makes it a good choice if you wanted to process the real and imaginary parts of the spectrum off line and inverse transform it back to the time domain. Because the data does not taper to zero, you can remove the effect of the window function from the result.

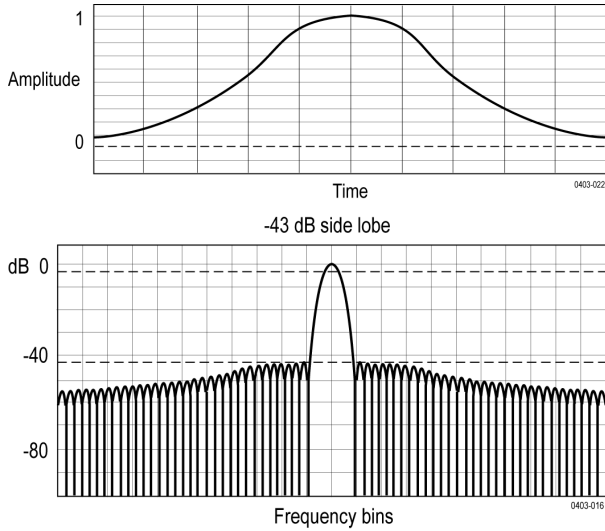

## Kaiser-Bessel FFT window

A Kaiser-Bessel window balances amplitude accuracy, side lobe distance, and side lobe height. Although similar to the Blackman-Harris window, the near side lobes in a Kaiser-Bessel window tend to be higher for the same main lobe width, while the further-out side lobes are lower. This window can reveal signals close to the noise floor, and analyze two tones with close frequencies but different amplitudes.

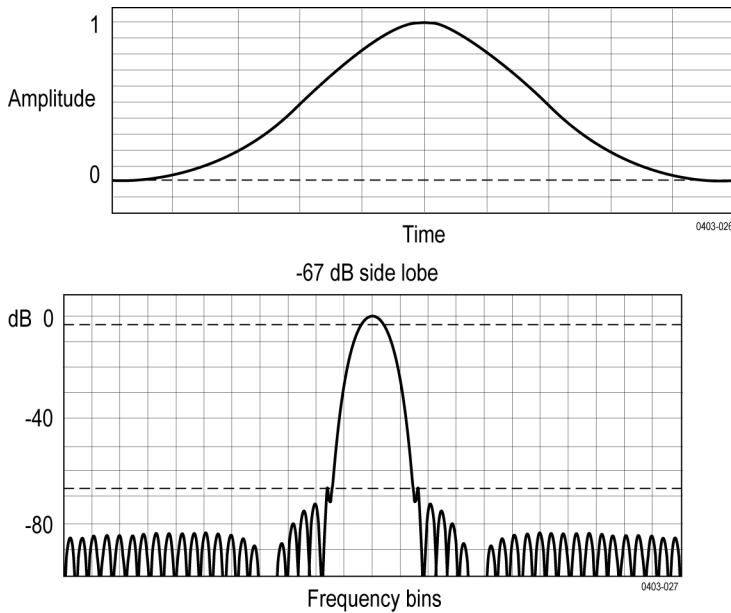

## Rectangular window

This window is equal to unity (see the next figure). This means the data samples in the gate are not modified before input to the spectral analyzer. Rectangular windows are best for measuring transients or bursts where the signal levels before and after the event are nearly equal.



**Note:** This window has the narrowest resolution bandwidth of any of the windows, but it also has the most spectral leakage and the highest side lobes.

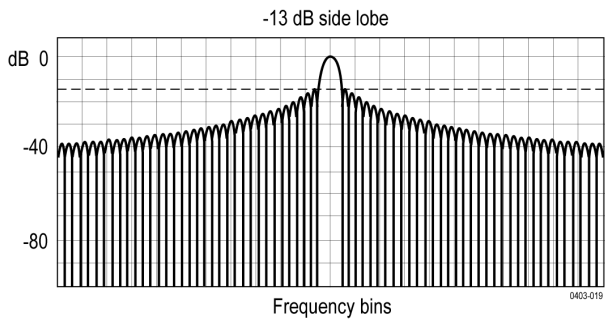
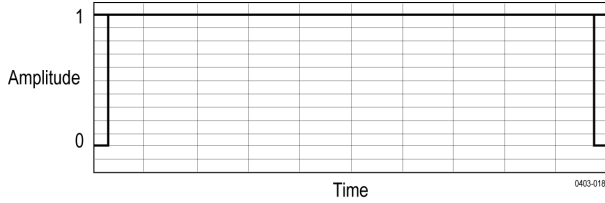

## Tek-Exponential window

In the time domain, it is not a symmetrical bell shape as is the case with the other windows. Instead, it is exponential with a peak at the 20% position of the time domain gate. The frequency domain shape is triangular.



**Note:** Use this window for impulse-response testing where the 20% position is the zero phase reference point. More of the acquired data record length is used to capture the impulse response.

Exact details of how to compute its values were published in the article; *Impulse-Response Testing Lets a Single Test Do the Work of Thousands*, by John Pickerd, EDN magazine, April 27, 1995.

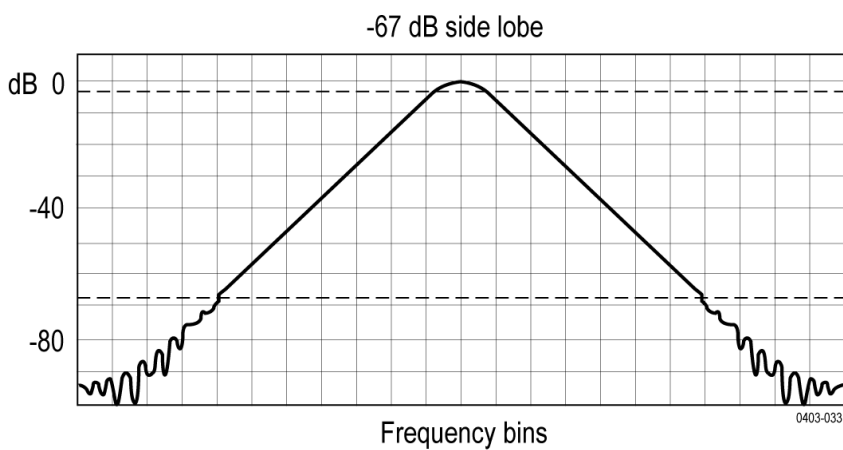
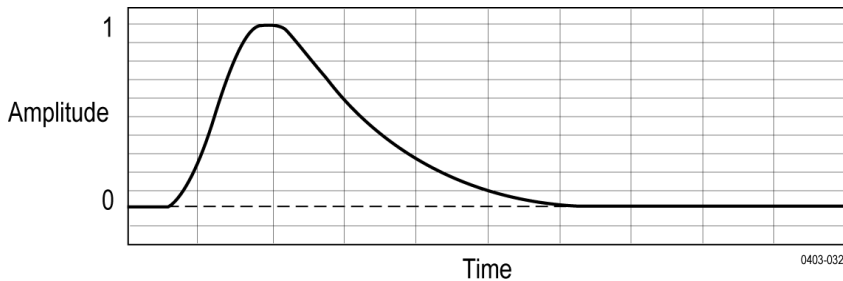

## User Defined Filter

User Defined Filter (UDF) can be implemented as Infinite Impulse Response (IIR) or Finite Impulse Response filters (FIR).

The choice of IIR or FIR filter is based on the design requirements and application. For example, when linearity of phase is important, a FIR filter is a better choice. Normally, IIR filters have asymmetric impulse responses and non-linear phases.

Following are the list of supported filter types:

- Low-Pass
- High-Pass
- Band-Pass
- Band-Stop
- All-Pass
- Hilbert
- Differentiator
- Raised Cosine
- Root-Raised Cosine

Following are the list of supported filter responses:

- Butterworth
- Chebyshev I
- Chebyshev II
- Elliptical
- Gaussian
- Bessel-Thompson
- Custom

The filters are designed up to  $[Sample\ Rate\ (Fs)]/2$ , hence the UDF magnitude plot shows the frequency axis from 0 Hz to  $F_s/2$  Hz, where  $F_s$  is the Sample Rate Frequency. At the cutoff frequency, the gain will be 0.707 (or -3dB). For example, if passband gain is 0 dB then the gain at cutoff frequency should be -3 dB.

### Low-Pass Filter (LPF)

A low-pass filter passes all the frequencies up to the specified cutoff frequency. It rejects all the frequencies above the cutoff.

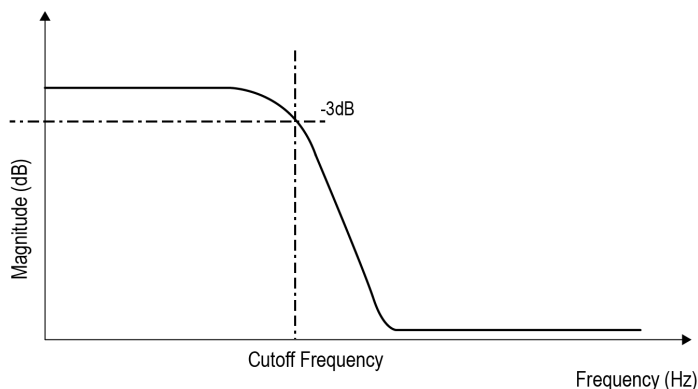

1303-001

LPF are used to remove background and high frequency noise.



## High-Pass Filter (HPF)

A high-pass filter passes all the frequencies above the specified cutoff frequency. It rejects all the frequencies below the cutoff.

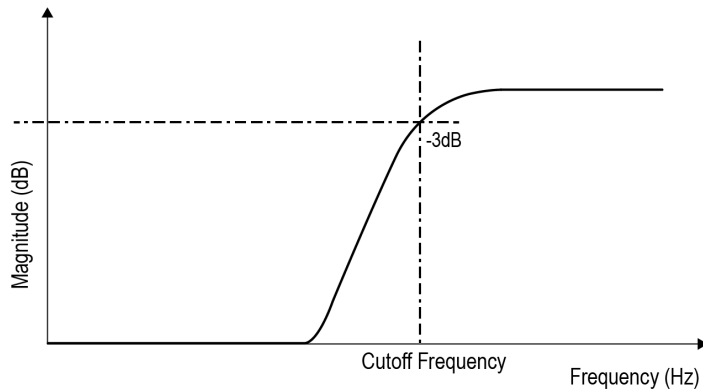

1303-002

HPF can be used to remove DC and low-frequency components. Both LPF and HPF are commonly used in HSS (High Speed Serial) and data communication applications.

## Band-Pass Filter (BPF)

A band-pass filter passes the band of frequencies between configured lower and upper cut off frequencies. Specify the upper and lower cut off frequencies for the filter.

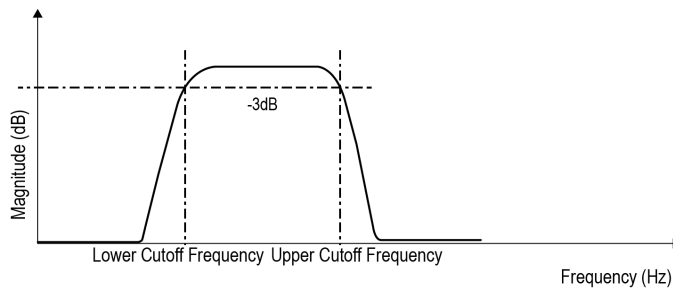

1303-003

BPF is used in HSS (High Speed Serial) analysis for doing jitter measurements over a frequency range of interest. BPF can be used in Pre-amplification, Equalization and Control in Audio Systems applications.

## Band-Stop Filter (BSF)

A band-stop filter passes all frequencies except a configured frequency band between lower and upper cut off frequencies.

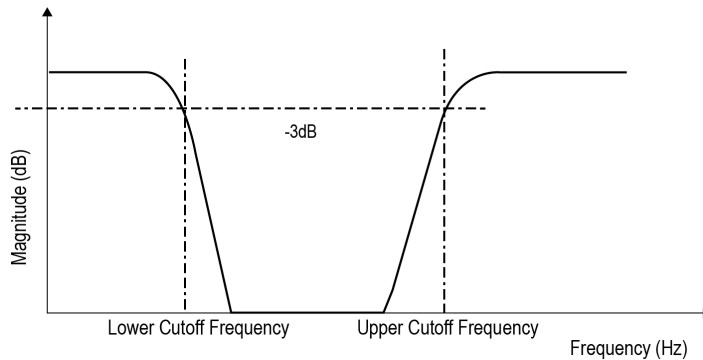

1303-004

BSF filters are extensively used in Medical electronic systems.

### All-Pass Filter

The All-pass filter is whose amplitude is constant and passes all frequencies between DC to  $F_s / 2$ . Enter the delay in seconds which introduces appropriate delay on the filtered output MATH waveform which is equivalent to phase shift in the frequency domain. The application computes and displays the plots of magnitude and phase responses.



**Note:** Displays magnitude and Phase response plot for all-pass filters.

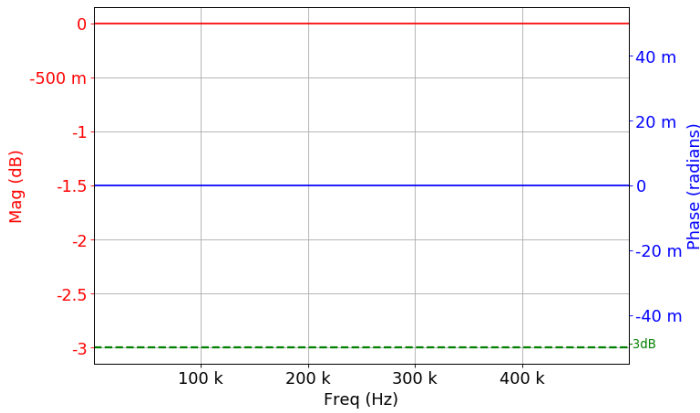

### Gaussian

This is an FIR filter designed using the Gaussian window method. This function computes the coefficients of a finite impulse response filter. The different types of filters which can be designed using the Gaussian window method are Low-pass, High-pass, Band-pass, and Band-stop.

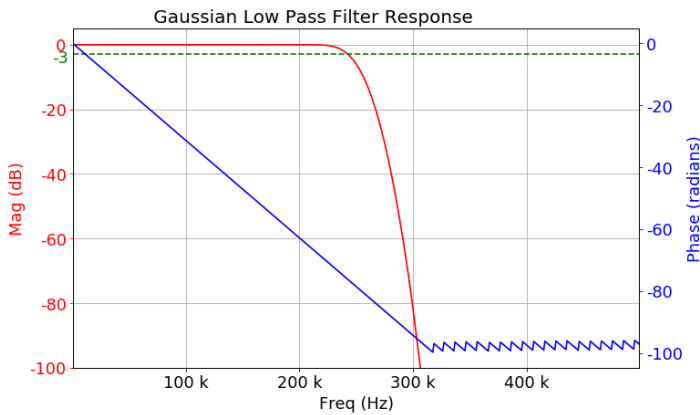

Gaussian Impulse Response

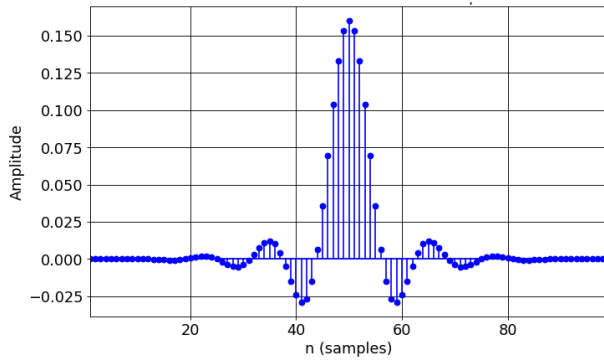

Gaussian Step Response

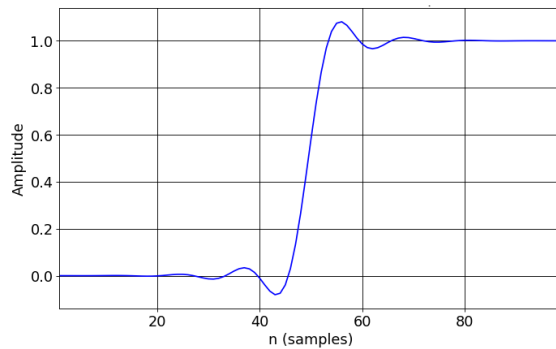

The standard deviation is a user input that defines the Gaussian window width.

## Hilbert

The ideal Hilbert transform filter has a gain of 1 dB at all frequencies and shifts the phase of all frequencies by 90 degrees. Hilbert filter can be used to create quadrature signals over a wide frequency range.



**Note:** Displays magnitude response plot for Hilbert filters.

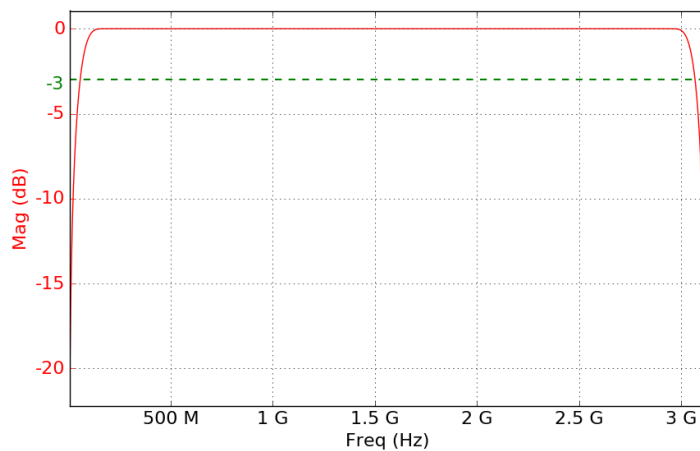

## Differentiator

The ideal differentiator is a high pass filter that shifts phase by 90 degrees. Its frequency response would be linear all the way from DC to  $F_s/2$ .



**Note:** Displays magnitude response plot for Differentiator filters.

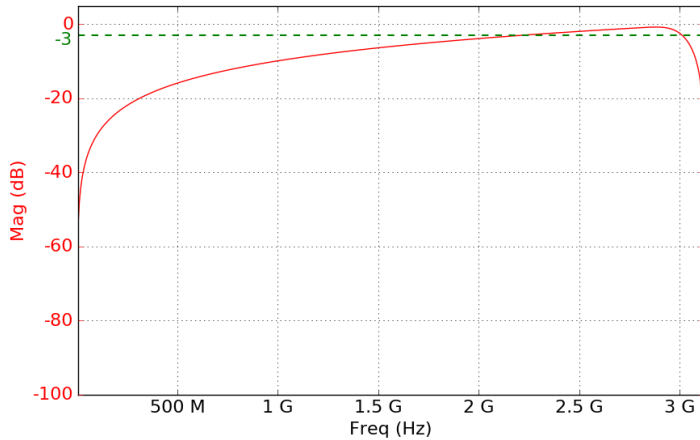

If the REF waveform sample rate does not match with Scope horizontal sample rate, then the user must change the oscilloscope sample rate to match with the REF sample rate. If REF is taken from other platforms like 5K/7K/70K oscilloscopes, the oscilloscope horizontal rate will mismatch, since compatible sample rates are not there in MSO 5/6 series oscilloscopes.

## Butterworth

Butterworth filters do not have passband and stop-band ripple, and commonly known as maximally flat magnitude filters. This has the flattest amplitude response of all the available filters.

The plot diagram is the example showing a low-pass filter. This filter also supports High-pass, Band-pass, and Band-stop filters. The application computes and displays plots of magnitude, phase, impulse, and step responses.

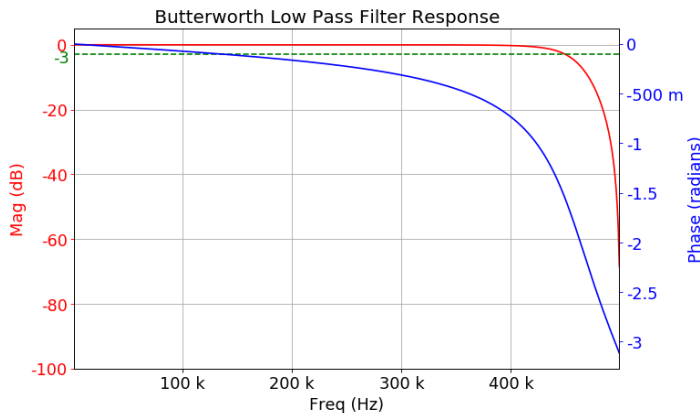

As the filter order is increased, the passband and stop-band performance improve, with the transition from passband to stop-band becoming sharper. The Butterworth method is best suited for design problems that focus on controlling passband and stop-band ripple.

This filter is used in electrophysiology and also a good choice for DC measurement applications.

## Chebyshev I

There are two types of Chebyshev filter namely Type-1 and Type-2. Generally, Type 1 is referred to as a regular filter, and this is the most common Chebyshev filter. The transition from passband to stop-band is more rapid than the Butterworth filter.

Type-1 filter has an equi-ripple in passband and no-ripple in the stop-band. The application provides control of passband ripple as part of this filter.

The plot diagram is the example showing for low pass filter, this is also applicable for High-pass, Band-pass, and Band reject filters.

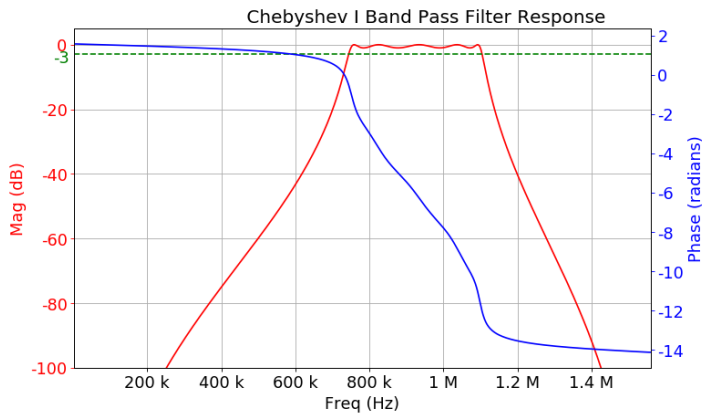

The application computes and displays plots of magnitude, phase, impulse, and step responses.

## Chebyshev II

Chebyshev II is also known as the inverse Chebyshev filter. The type-2 has equiripple in stop-band and no-ripples in the passband. These filters have a maximally flat passband response. The application provides control of Stop-band attenuation as part of this filter.

The plot diagram is the example showing for low-pass filter, this is also applicable for High-pass, Band-pass, and Band reject filters.

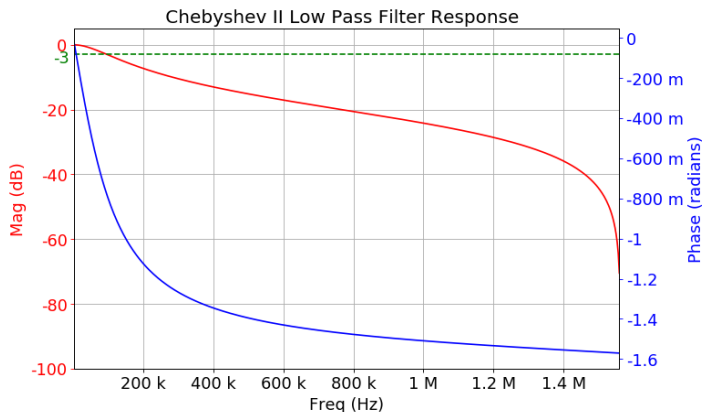

The application computes and displays plots of magnitude, phase, impulse, and step responses.



**Note:** Chebyshev II filter considers stop-band attenuation value to design the filter. The passband gain is measured above the stop-band attenuation.

## Elliptical

Elliptical filters have passband and stop-band ripple and the sharpest roll-off near the cutoff frequency. This type of filter contains ripple behavior in both the passband and stop-band.

The elliptical filter has fastest roll-off and lowest order filter than others. The application provides control of Passband ripple and Stop-band attenuation as part of this filter.

The plot diagram is the example showing high-pass filter. This filter also supports Low-pass, Band-pass and Band reject filters. The application computes and displays plots of magnitude, phase, impulse, and step responses.

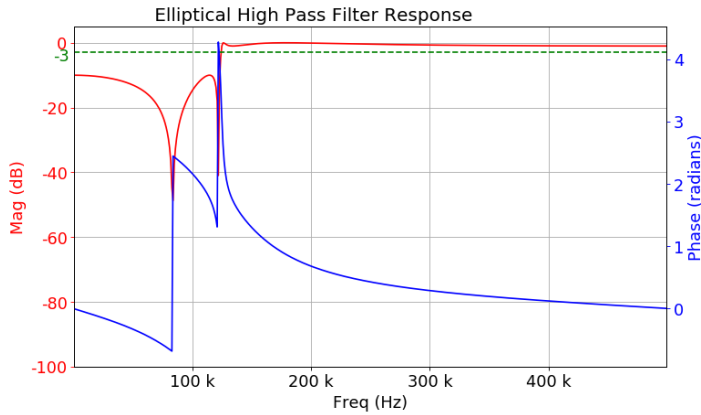

This filter is used in many RF and microwave applications where a very fast transition between the passband and stop-band frequencies is required.

### Bessel Thompson

The Bessel filter is optimized to obtain a better transient response due to a linear phase that is a constant delay in the passband.

The plot diagram is the example showing a low-pass filter. This filter supports High-pass, Band-pass and Band reject filters. The application computes and displays the plots of magnitude, phase, impulse, and step responses.

The Bessel Thompson class of filters are commonly used as the analog bandwidth limit filter in oscilloscope channels. It is also used as the filter response type for optical reference receiver mask testing applications. The reason for its popularity is that it is the closest one can get to realizing an ideal Gaussian filter response that is not physically realizable.

Bessel Thompson can be used in some RF and in particular audio applications where the preservation of the wave shape and phase of components within a signal are important.

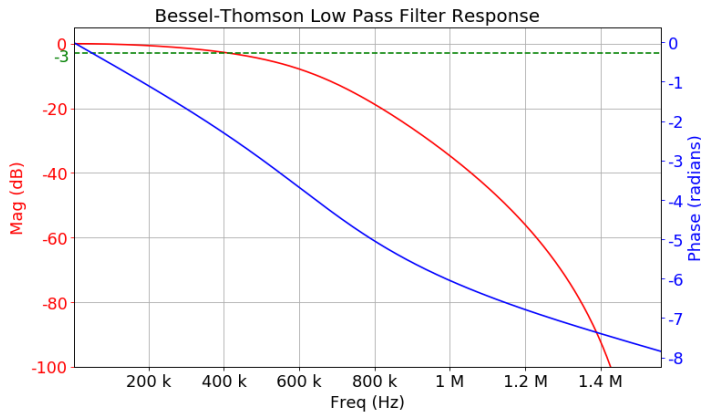

These filters are used in applications where a constant group delay is critical, such as in analog video signal processing.

### Raised Cosine (RC) and Root Raised Cosine (RRC) filters

Raised Cosine and RRC filters are low-pass filters.

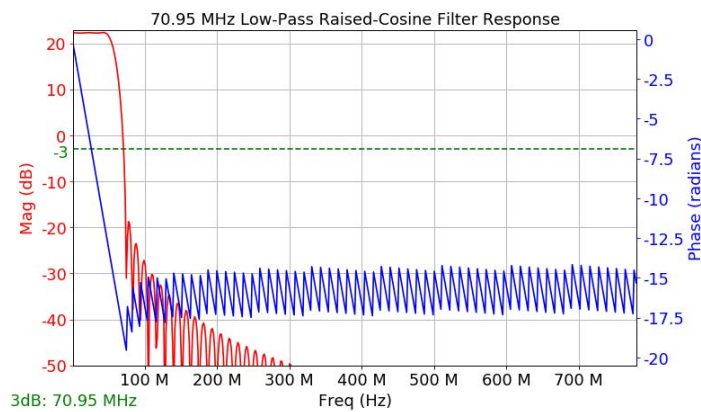
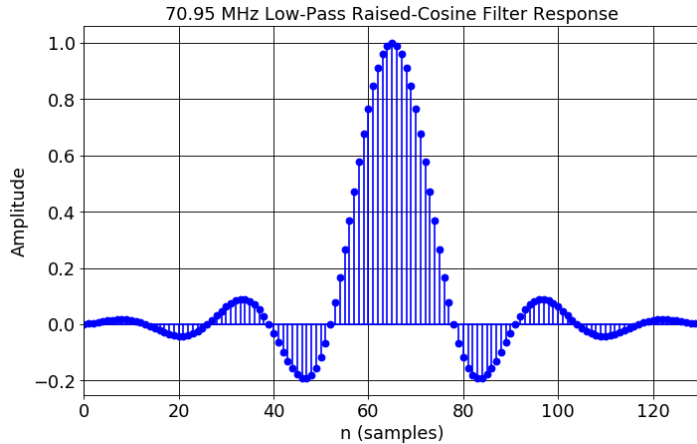

Ideal pulse shaping filters will have infinite number of taps. The UDF will window the filter span based on number of symbols. Symbols configuration helps in setting window width. RC and RRC need number of samples per symbol, hence Symbol Duration configuration is utilized. Samples per symbol is the product of current sample rate of oscilloscope and symbol duration. Since the sample rate is inherently a configuration of filter, the filter response changes for different sample rate. The UDF designs just for the current oscilloscope sample rate.

The filter order is computed as  $\text{Symbols} \times \text{Symbol Duration} \times \text{Sample Rate}$ .

Number of taps is an odd number, in order to maintain even symmetry in impulse response.

### Troubleshooting RC and RRC filters

For a fixed sample rate, rate of transition falls and side lobes gain can be varied by changing Symbols (filter span). Impulse response is a good indicator of transition.

Example: RC filter with Symbol Duration = 50 ns, Roll off factor = 0.5, and Sample rate = 1.5625 GS/s

**For Symbols = 1:**

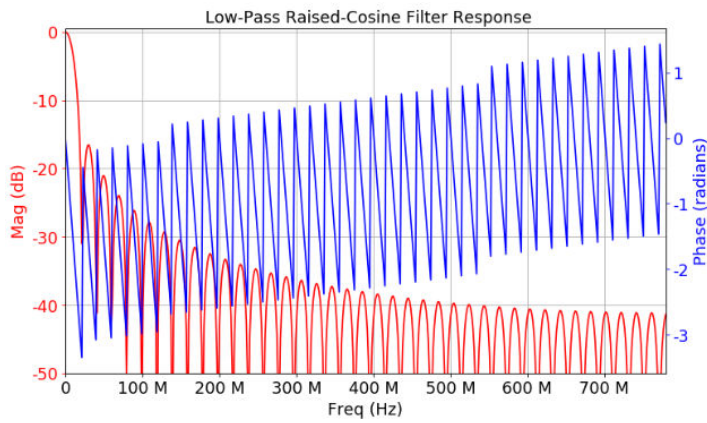
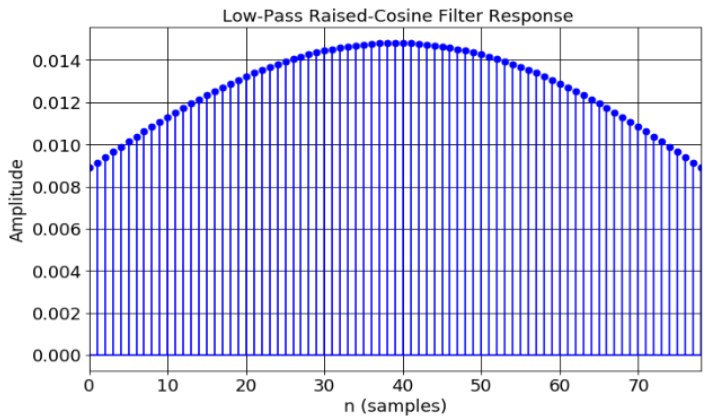

For Symbols = 4:



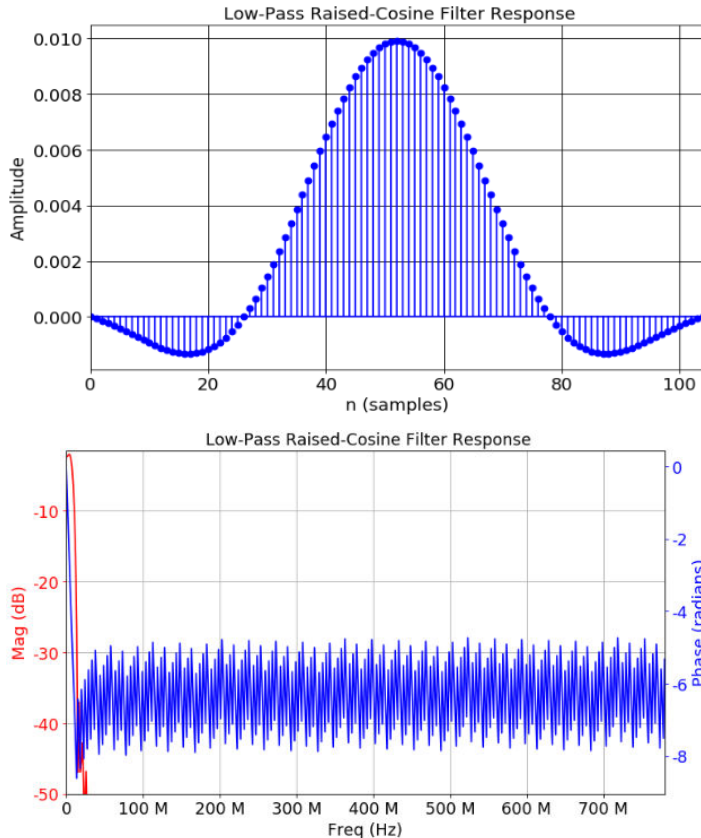

As impulse response starts, looking closer to a sinc response, the rate of magnitude transition increases rapidly to an extent where gain of output waveform start decreasing and also ripples in output waveform increases. It is advised to decrease the sample rate and symbols configuration in such situations. There will be a constant group delay in filtered output which can be removed by UDF "All Pass filter" if necessary.

## Custom filters

The custom filter order is calculated using the remez order formula. It depends on the transition width, pass band ripple, stop band attenuation, and the sample rate. The maximum supported filter order is 15k. So, the transition width and other parameters can be adjusted accordingly to get the filter order below 15k.

Constraints on transition width:

- In case of low-pass filter the maximum value of transition width allowed is  $(0.45 * \text{sample rate}) - \text{cutoff frequency}$ .
- In case of high-pass filter it cannot exceed the cutoff frequency.
- In case of band-pass or band-stop filters the maximum value of transition width can be the minimum of the low cutoff frequency and  $(0.5 * \text{sample rate} - \text{high cutoff frequency})$ .

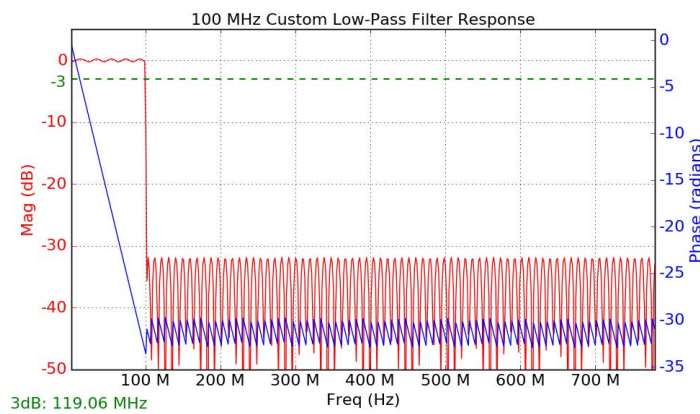
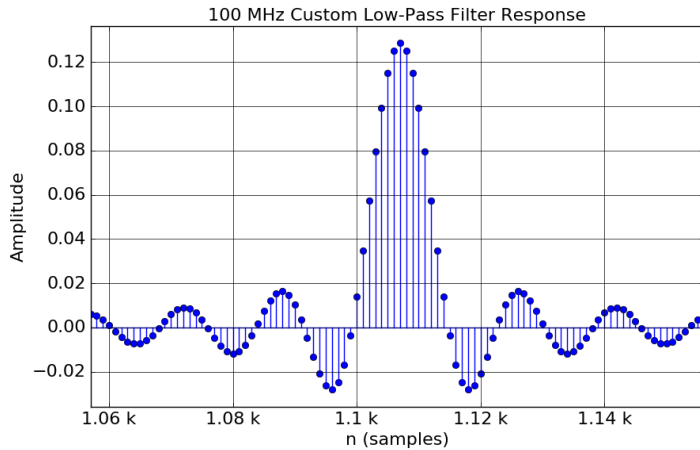

### Key filter parameters

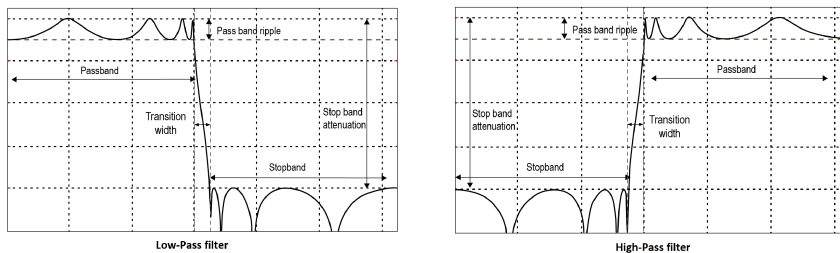

1303-022

- A filter's response to different frequencies is characterized as passband, transition band, or stop-band.
- Passband response is the filter's effect on frequency components that are passed through (mostly) unchanged.
- Stop-band response: Band of frequencies that are highly attenuated post filtering.
- Transition band (Transition width): It represents frequencies in the middle, which may receive some attenuation but are not removed completely from the output signal.
- Cut off Frequency: Used to specify the bandwidth of high-pass, low-pass, band-pass, and band-stop filters. The cutoff frequency is the point at which the magnitude is close to -3 dB from passband gain. This represents a 3 dB point.
- Filter Roll off rate: The slope of the transition band of a filter is referred to as its roll off rate. This is commonly specified in dB per octave or in dB per decade.
- Filter order: The order refers to the order of the filter's system function. The filter roll-off is a function of the filter order.

- The transition region: This region is between passband and stop-band enclosing the cutoff frequency and is defined as the transition band. Larger the filter roll off rate smaller the transition region.
- Impulse response: The impulse describes the transfer function of a filter in the time domain. The effect of a filter on the signal input resulting in a filtered output. Therefore, it is essential to understand the filter responses for a good filter design. This is the output from the filter when the input is unit impulse.
- Step response: This response represents the integral of the impulse response for the digital filter transfer function. This is the output from the filter when the input is a unit step function.
- Stop-band attenuation: Describes dB value of stop-band attenuation down from the peak passband value.
- passband Ripple: Describes dB of peak-to-peak passband ripple in the passband region.

**Note:**

- Filter Designer may not be able to achieve the desired response using different design methods, regardless of the filter order. So, you are expected to tune the filter based on the filter response and any warning messages.
- You can design a filter for the configured cutoff frequency and the corresponding filter response is shown. However, the filtered signal on math is shown when the cutoff frequency is between 0.05 to 0.45 times the sample rate. You need to adjust the oscilloscope sample rate to one of the valid sample rates for which the filter is designed to see the filtered signal.
- Filter Blanking time: Filter blanking time is the duration of the filter output that is suppressed. The blanked portion of the output is not included in the measurement statistics or in any plots. To overcome this, increase the input waveform to a higher record length if MATH does not show the filtered waveform. This happens due to filter blanking. If there is no output on the math waveform, it also could be due to this reason.
- The magnitude response shows the Cutoff frequency annotation at bottom left of the graph. This is obtained by finding intersection of magnitude curve with -3 dB horizontal line. This is applicable for all filters except All Pass filter.

**Known limitations of the user-defined filter**

Following are the limitations to design user defined filter:

- The delay range is (-5 \* configured horizontal scale) to (+ 5 \* configured horizontal scale). The MATH supports only positive values of delay. So user inputs are in the range of 0 to (5 \* configured horizontal scale).
- Response and output magnitude will mismatch in FIR Filters. This applies to All-Pass, Hilbert, and Differentiator.
- If REF is taken from other platforms like 5K/7K/70K oscilloscopes, scope horizontal rate will mismatch, since compatible sample rates are not there in MSO 5/6 series oscilloscopes. On recalling the user defined filter session or a setup file, user needs to click on apply filter button to see the responses.

**Filter file format**

Filter file is unique to Tektronix User Defined Filter software. When filter file is saved, it will be in the below format.

```
// Do not edit. Generated from Tektronix Filter Editor.
// FIR or IIR Filter
// Filter Header
// Sample Rate; Filter Coefficients
```



**Note:** Filter coefficients are saved for all the valid sample rates for which filter can be designed.

For Example:

1. Filter file created for 2nd order low pass butterworth filter.

```
// Do not edit. Generated from Tektronix Filter Editor.
// Tool converts IIR filter response to FIR filter response.
```

```
// {filter_type: lowPass, filter_name: butterworth, filter_order: 2, fs:
6250000000.0, fir_taps: 5001, cutoff_freqs: 1000000000.0}
6250000000.0;1.453238838770423980e-01,3.881643214198569058e-01, and so on
```

**2. Filter file created for Hilbert filter.**

```
// Do not edit. Generated from Tektronix Filter Editor.
// FIR filter.
// {filter_type: hilbert}
@6250000000.0;-7.0350765900000000241e-17,1.304761389999999890e-04, and so on
```



**Note:** If the recalled filter file is not in the above format, it is unable to restore the filter settings. However, filtered signal will display on math if the sample rate in the filter file matches with the oscilloscope sample rate.

# Measurement algorithms

## Amplitude measurement algorithms

### AC RMS measurement algorithm

AC RMS is the true Root Mean Square of the data points about the Mean ( $\mu$ ). This measurement can be made across the entire record or on each cycle in the record.

### Area measurement algorithm

Area is the arithmetic area for one waveform. The area measured above ground is positive. The area measured below ground is negative. Remember that one waveform is not necessarily equal to one cycle. For cyclical data you may prefer to use the cycle area rather than the arithmetic area.

$$Area = \int_{Start}^{End} Waveform(t) dt$$

Details of the integration algorithm are given later [Integration Algorithm](#).

### Amplitude measurement algorithm

Amplitude is the difference between the Top value and the Base value.

$$Amplitude = Top - Base$$

### Base measurement algorithm

Base is calculated using the selected Base Top method. Base is the most common data value below the midpoint of the waveform, when the default Base Top method Histogram Mode is selected. This measurement can be made across the entire record or on each cycle in the record.

### Integration algorithm

The integration algorithm used by the instrument is as follows:

$$\int_A^B W(t) dt \text{ is approximated by } \int_A^B \hat{W}(t) dt \text{ where:}$$

$W(t)$  is the sampled waveform

$\hat{W}(t)$  is the continuous function obtained by interpolation of  $W(t)$

$A$  and  $B$  are numbers between 0.0 and  $RecordLength - 1.0$

If  $A$  and  $B$  are integers, then:

$$\int_A^B \hat{W}(t) dt = s \times \sum_{i=A}^{B-1} \frac{W(i) + W(i + 1)}{2}$$

0020-026

where s is the sample interval.

Similarly,

$$\int_A^B (W(t))^2 dt \text{ is approximated by } \int_A^B (\hat{W}(t))^2 dt \text{ where:}$$

0020-027

$W(t)$  is the sampled waveform

$\hat{W}(t)$  is the continuous function obtained by interpolation of  $W(t)$

A and B are numbers between 0.0 and *RecordLength* – 1.0

If A and B are integers, then:

$$\int_A^B (\hat{W}(t))^2 dt = s \times \sum_{i=A}^{B-1} \frac{(W(i))^2 + W(i) \times W(i + 1) + (W(i + 1))^2}{3}$$

0020-028

where s is the sample interval.

## Maximum measurement algorithm

Maximum is the maximum data point. Typically the most positive peak voltage.

## Mean measurement algorithm

Mean is the arithmetic mean of the data points. Remember that one waveform is not necessarily equal to one cycle. For cyclical data you may prefer to use the cycle mean rather than the arithmetic mean.

$$Mean = \frac{\int_{Start}^{End} Waveform(t) dt}{(End - Start) \times SampleInterval}$$

0020-017

Details of the integration algorithm are given in [Integration algorithm](#) on page 665 .

## Minimum measurement algorithm

Minimum is the minimum data point. Typically the most negative peak voltage.

## Negative Overshoot measurement algorithm

Negative Overshoot is the difference between Minimum and Base, divided by the amplitude. It is the percent that the waveform goes below base.

$$Negative\ Overshoot = \frac{Base - Min}{Amplitude} \times 100 \%$$

Note that overshoot values should never be negative (unless *Top* or *Base* are set out-of-range).

## Positive Overshoot measurement algorithm

Positive Overshoot is the difference between Maximum and Top, divided by the amplitude. It is the percent that the waveform goes above top.

$$\text{Positive Overshoot} = \frac{\text{Max} - \text{Top}}{\text{Amplitude}} \times 100 \%$$

Note that this value should never be negative.

## Peak-To-Peak measurement algorithm

Peak to peak is the difference between Maximum and Minimum.

$$\text{PeaktoPeak} = \text{Max} - \text{Min}$$

## RMS measurement algorithm

RMS is the true root mean square of the data points.

$$\text{RMS} = \sqrt{\frac{(\text{data1}^2 + \text{data2}^2 + \dots)}{(\text{end} - \text{start})}}$$

## Top measurement algorithm

Top is calculated using the selected Base Top method. Top is the most common data value above the midpoint of the waveform, when the default Base Top method Histogram Mode is selected. This measurement can be made across the entire record or on each cycle in the record.

## Timing measurement algorithms

### Burst Width measurement algorithm

Burst Width is the duration of a series of adjacent crossings of the mid reference level. The duration of a burst. Bursts are separated by a user-defined idle time.

### Data Rate measurement algorithm

Data Rate is the reciprocal of Unit Interval. This measurement is made on each bit in the record.

### Delay measurement algorithm

Delay is the time between a mid reference level edge on one source to a mid reference level edge on a second source. The direction of each edge can be configured by the user.

## Falling slew rate

Falling Slew Rate is the rate of change in value as an edge transitions from the high or mid reference level to the mid or low reference level. The levels are configurable.

In the diagram below, the Falling Slew Rate from mid ref to low ref is calculated using the following equation:

$$\text{Falling Slew Rate} = (V_{REF} - V_{REFLO}) / \Delta TF$$

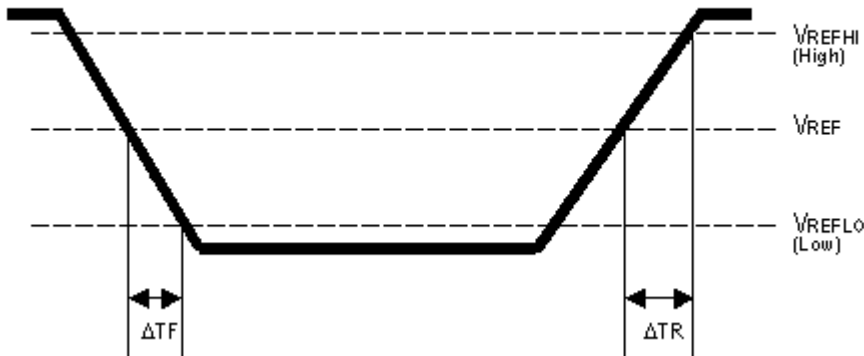

## Fall Time measurement algorithm

Fall Time is the time required for an edge to fall from the high reference level to the low reference level. By default the measurement is from reference level 90% amplitude to 10% amplitude.

The following figure shows a falling edge with the two edges necessary to calculate a Fall measurement. The figure shows the default high reference level which is 90% of Top and the default low reference level which is 10% of Base.

1. Searching from *Start* to *End*, find the first sample in the measurement zone greater than *HighRef*.
2. From this sample, continue the search to find the first (negative) crossing of edge of *HighRef*. The time of this edge is *THF*. (Use interpolation if necessary.)

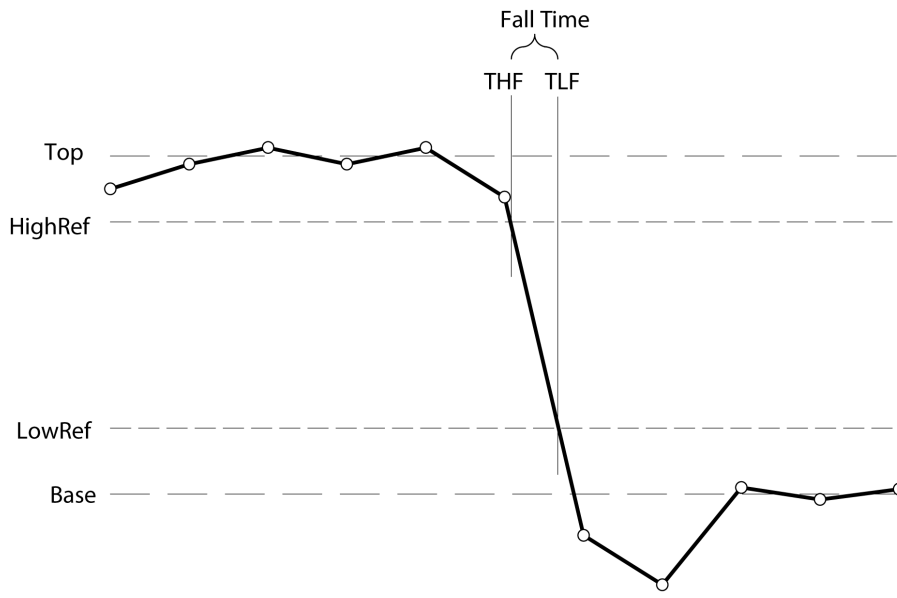

0403-004

Figure 30: Fall Time



3. From *THF*, continue the search, looking for a crossing of *LowRef*. Update *THF* if subsequent *HighRef* crossings are found. When a *LowRef* crossing is found, it becomes *TLF*. (Use interpolation if necessary.)
4.  $FallTime = TLF - THF$

## Frequency measurement algorithm

Frequency is the reciprocal of the period. Frequency is typically measured in Hertz (Hz) where 1 Hz = 1 cycle per second.

$$Frequency = 1 / Period$$

## High Time measurement algorithm

High Time is the amount of time that a waveform cycle is above the High reference voltage level.

The application calculates the measurement using the following equation:

$$T_{\text{High}} = T_{\text{Hi-}} - T_{\text{Hi+}}$$

Where:

$T_{\text{High}}$  is the high time.

$T_{\text{Hi-}}$  is the High reference crossing on the falling edge.

$T_{\text{Hi+}}$  is the High reference crossing on the rising edge.

## Hold Time measurement algorithm

Hold Time is the time between the mid reference level crossing of the clock source (Source1) and the next mid reference level crossing of the data source (Source2). The crossings (edges) may be configured to be rising, falling or either.

The application calculates this measurement using the following equation:

$$T_{\text{Hold}} = T_{\text{2nd}} - T_{\text{Main}}$$

Where:

$T_{\text{Hold}}$  is the hold time.

$T_{\text{Main}}$  is the source 1 (clock) Mid reference edge time in the configured direction.

$T_{\text{2nd}}$  is the source 2 (data) Mid2 reference edge time in the configured direction.

## Low Time measurement algorithm

Low Time is the amount of time that a waveform cycle is below the Low reference voltage level.

The application calculates this measurement using the following equation:

$$T_{\text{Low}} = T_{\text{Lo+}} - T_{\text{Lo-}}$$

Where:

$T_{Low}$  is the low time.

$T_{Lo+}$  is the Low reference crossing on the rising edge.

$T_{Lo-}$  is the Low reference crossing on the falling edge.

## N-Periods Duration measurement algorithm

Duration N-Periods is the time required to complete N cycles.

The source can be configured to be treated as either a clock or data waveform. Given a voltage waveform, the N-Period is calculated as follows:

### If the Signal Type is Clock

The N-Period measurement calculates the elapsed time for N consecutive crossings of the mid reference voltage level in the direction specified.

The application calculates this measurement using the following equation:

$$NP_n^{Clock} = T_{n+N}^{Clock} - T_n^{Clock}$$

Where:

$NP_{Clock}$  is the accumulated period for N clock cycles.

$T_{Clock}$  is the VRefMid crossing time for the configured edge direction.

### If the Signal Type is Data

The N-Period measurement calculates the elapsed time for N consecutive unit intervals.

The application calculates this measurement using the following equation:

$$NP_n^{Data} = T_{n+N}^{Data} - T_n^{Data}$$

Where:

$NP_{Data}$  is the duration for N unit intervals.

$T_{Data}$  is the VRefMid crossing time in either direction.

If  $T_{n+N Data}$  does not exist for a given n, no measurement is recorded for that position.

## Negative Duty Cycle measurement algorithm

Negative Duty Cycle is the ratio of the negative pulse width to the signal period expressed as a percentage.

*NegativeWidth* is defined in *Negative Pulse Width*, below.

If *Period* = 0 or undefined then return an error.

$$NegativeDutyCycle = \frac{NegativeWidth}{Period} \times 100\%$$

000-018

## Negative Pulse Width measurement algorithm

Negative Pulse Width is the time (or distance) the signal remains below the mid reference level. It is the distance from a falling edge to the next rising edge.

## Period measurement algorithm

The time between two adjacent crossings of the Mid reference level (one cycle) of the waveform. Period is measured in horizontal units, typically seconds.

$$\text{Period} = \text{Edge3} - \text{Edge1}$$

## Phase measurement algorithm

Phase is the ratio of the Skew between two sources to the Period of the first source. It is the amount of phase shift between edges of the two waveforms. The phase shift is expressed in degrees of the Source1 waveform cycle, where 360 degrees is one complete cycle (Period) of Source1. For best results, Source1 and Source2 should be of the same frequency or one waveform should be a harmonic of the other.

Phase is determined in the following manner for each cycle of the record:

1. The first two adjacent edges of the configured 'from' edge type are found in Source1.
2. The period of Source1 is calculated (see *Period* above). If the "from" edge is set to either, the half-period of Source1 is calculated.
3. The first edge in Source2 in the configured 'to' edge direction is found.
4. The Skew from the first Source1 edge to the next Source2 edge is calculated.

$$(\text{Skew}/\text{Period}) \times 360$$

5. When "from" edge is either, the calculation is  $(\text{Skew}/\text{half-Period}) \times 180$ .

## Positive Duty Cycle measurement algorithm

Positive Duty Cycle is the ratio of the positive pulse width to the signal period, expressed as a percentage.

*PositiveWidth* is defined in *Positive Pulse Width*, following.

$$\text{PositiveDutyCycle} = \frac{\text{PositiveWidth}}{\text{Period}} \times 100\%$$

## Positive Pulse Width measurement algorithm

Positive Pulse Width is the time the signal remains above the mid reference level. It is the distance from a rising edge to the next falling edge.

## Rising Slew Rate measurement algorithm

Rising Slew Rate is the rate of change in value as an edge transitions from the low or mid reference level to the mid or high reference level. The levels are configurable.

In the diagram below, the Rising Slew Rate from mid ref to high ref is calculated using the following equation:

$$(\text{VREFHI} - \text{VREF})/\Delta\text{TR}$$

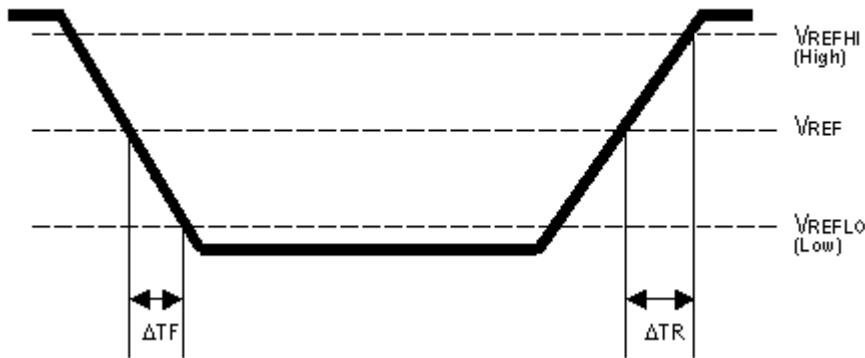

### Rise Time measurement algorithm

Rise Time is the time required for an edge to rise from the low reference level to the high reference level. By default the measurement is from reference level 10% amplitude to 90% amplitude.

The following figure shows a rising edge with the two crossings necessary to calculate a Rise Time measurement.

1. Searching from *Start* to *End*, find the first sample in the measurement zone less than *LowRef*.
2. From this sample, continue the search to find the first (positive) crossing of *LowRef*. The time of this crossing is the low rise time or *TLR*. (Use linear or sin interpolation if necessary.)
3. From *TLR*, continue the search, looking for a crossing of *HighRef*. Update *TLR* if subsequent *LowRef* crossings are found. If a *HighRef* crossing is found, it becomes the high rise time or *THR*. (Use linear or sin interpolation if necessary.)
4.  $RiseTime = THR - TLR$

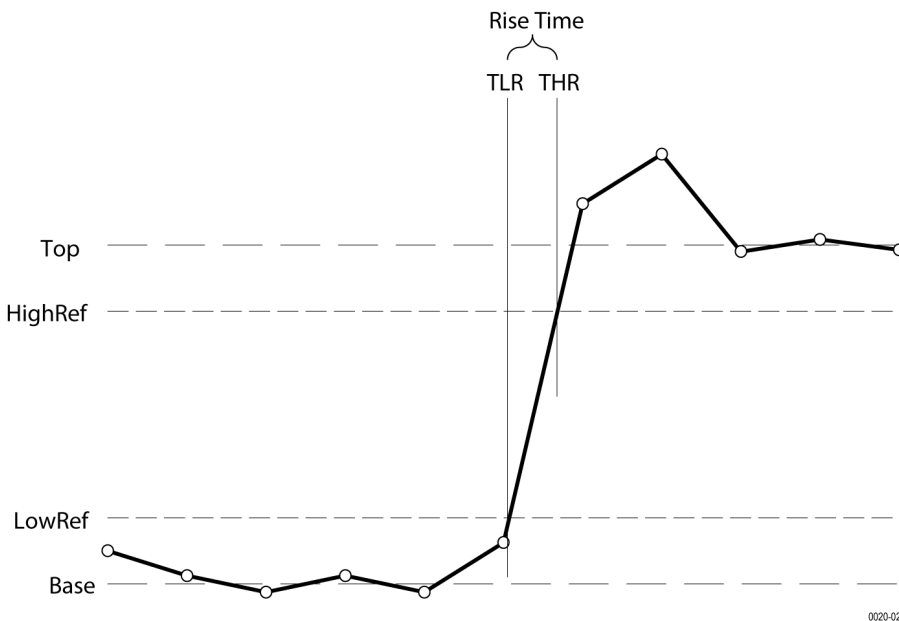

0020-023

## Setup

Setup Time is the time between the mid reference level crossing of the clock source (Source1) and the closest previous mid reference level crossing of the data source (Source2). The crossings (edges) may be configured to be rising, falling or either.

The application calculates this measurement using the following equation:

$$T_N^{Setup} = T_i^{Main} - T_N^{2nd}$$

Where:

$T_{Setup}$  is the setup time.

$T_{Main}$  is the Main input (clock) Mid reference crossing time in the specified direction.

$T_{2nd}$  is the 2nd input (data) Mid2 reference crossing time in the specified direction.

## Skew

Skew is the time between the mid reference level crossing on Source1 to the mid reference level crossing on Source2. The direction of the edge crossing is configurable.

The application calculates this measurement using the following equation:

$$T_N^{Skew} = T_N^{Main} - T_N^{2nd}$$

Where:

$T_{Skew}$  is the timing skew.

$T_{Main}$  is the Main input Mid reference crossing time in the configured direction.

$T_{2nd}$  is the 2nd input Mid2 reference crossing time in the configured direction.

## Time Outside Level measurement algorithm

Time Outside Level is the time the signal remains above the high reference level and/or below the low reference level.

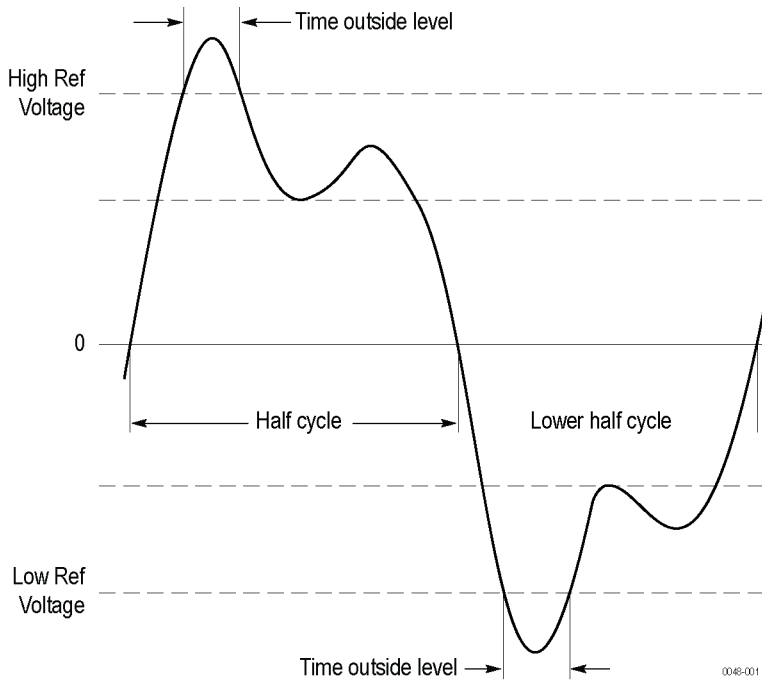

### Time to Max

Time to Max is the amount of time from the trigger point to the maximum data point. This measurement can be made across the entire record or on each cycle in the record.

### Time to Min

Time to Min is the amount of time from the trigger point to the minimum data point. This measurement can be made across the entire record or on each cycle in the record.

### Unit Interval measurement algorithm

Unit Interval is the time difference between two successive bits. This measurement is made on each bit in the record. The bits are calculated using clock recovery method constant mean.

### Spectrum measurements algorithm

#### Channel Power algorithm

Channel Power is the measurement of integrated power within a specified channel bandwidth for an RF signal. The resulting channel power is an absolute power measurement. The Channel Power measurement results are clear and accurate.

$$CP = 10 \log \left[ \left( \frac{CBW}{RBW} \right) \left( \frac{1}{N} \right) \left( \sum_{k=1}^N 10^{\frac{Pk}{10}} \right) \right]$$

Where,

CP = Channel Power

CBW = Channel Bandwidth (in Hz)

RBW = Resolution Bandwidth (in Hz)

N = Number of data points in the summation

$P_k$  = Power at the  $k^{\text{th}}$  data point (in dBm)

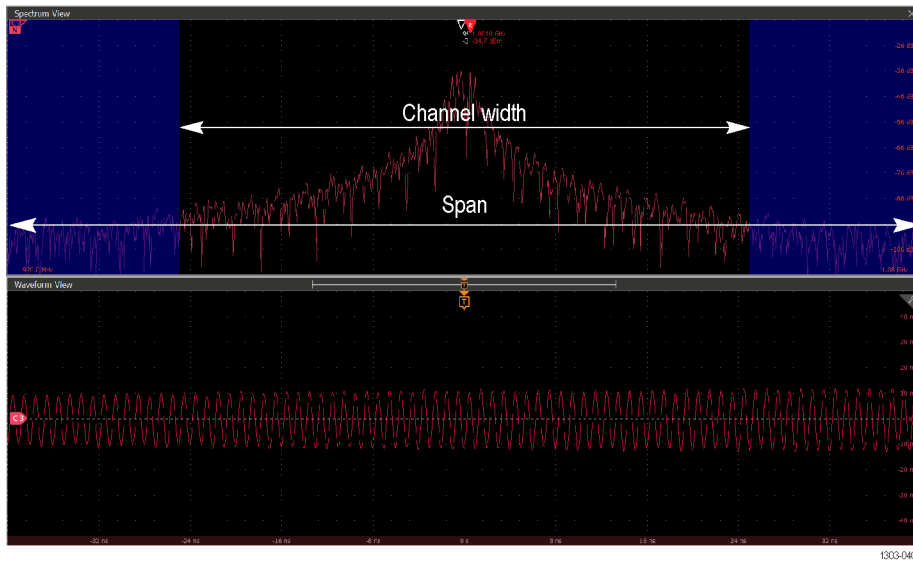

Figure 31: The image shows the channel width for a given Channel Power measurement.

## Adjacent Channel Power Ratio (ACPR) algorithm

Adjacent Channel Power is the amount of power that leaks into adjacent channels. This can be specified in terms of absolute power or a ratio of adjacent channel power to the main channel power, called adjacent channel power ratio (ACPR) or adjacent channel leakage ratio (ACLR).

$$\text{ACPR}_{\text{dB}} = 10 \log \left( \frac{P_{\text{adj}}}{P_{\text{ch}}} \right)$$

$P_{\text{adj}}$  = Adjacent channel power in watts.

$P_{\text{ch}}$  = Channel power in watts.

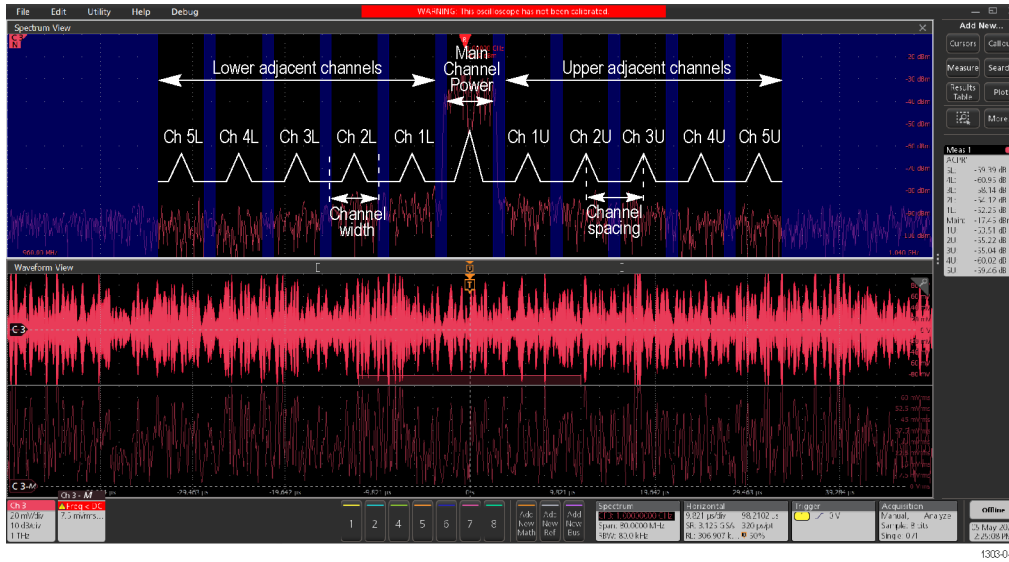

Figure 32: The image shows the channel width, channel spacing, and adjacent channels for a given ACPR measurement.

## Occupied Bandwidth algorithm

The occupied bandwidth refers to the bandwidth, including energy of a certain proportion of the total transmitted power, with the center frequency of the specified channel as the center.

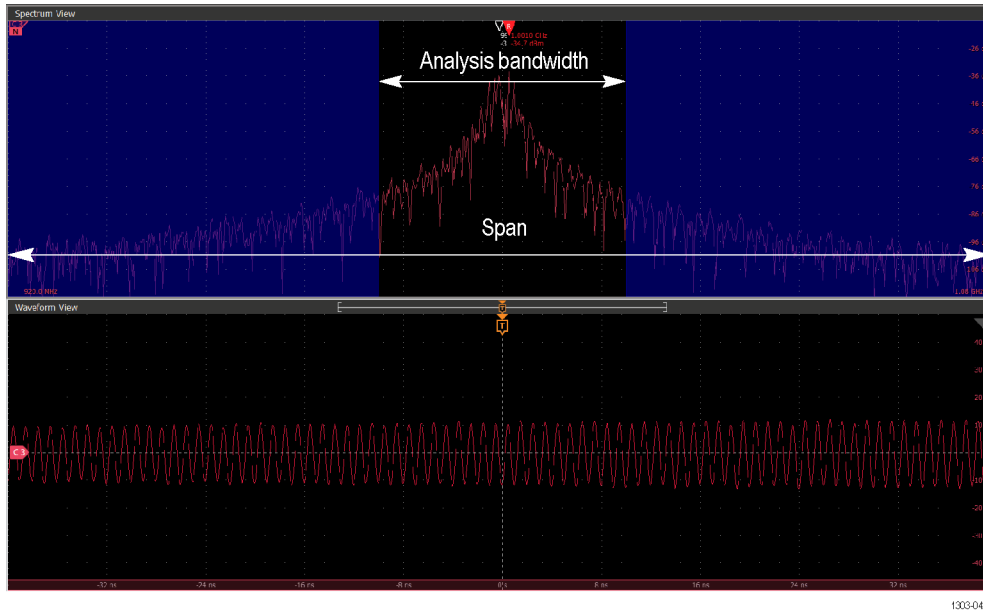

Figure 33: The image shows the analysis bandwidth for a given OBW measurement.

Depending on the modulation mode, two methods can be applied to calculate the Occupied Bandwidth.

### Percentage of power

Calculate the total power in the measured frequency range. The power of a signal is the sum of the absolute squares of its time-domain samples divided by the signal length or equivalently the square of its RMS level determines the lower frequency value.

1. Enter the PercOfPower % value.



2. Determine the lower frequency value. Starting at the lowest frequency in the range and moving upward, the power distributed in each frequency is summed until this result is  $(100 - \text{percOfPower } \%) / 2$  of the total power.
3. Determine the upper frequency value. Starting at the highest frequency in the range and moving downward, the power distributed in each frequency is summed until the result reaches  $(100 - \text{PercOfPower } \%) / 2$  of the total power.

The bandwidth between the lower and upper power frequency values is the Occupied Bandwidth. The frequency halfway between the lower and upper frequency values is the center frequency.

### Power drop XdB

The x dB level determines the x dB bandwidth. The instrument analyzes the spectrum trace to locate the frequencies at which the level is x dB down from the peak level calculated over the measurement bandwidth. The frequency difference between the upper and lower crossing thresholds is the x dB bandwidth.

## Spectrogram algorithm

A spectrogram is a visual representation of the spectrum of frequencies of a signal as it varies with time. It is usually depicted as a heat map, an image with the intensity shown by varying the colour or brightness.

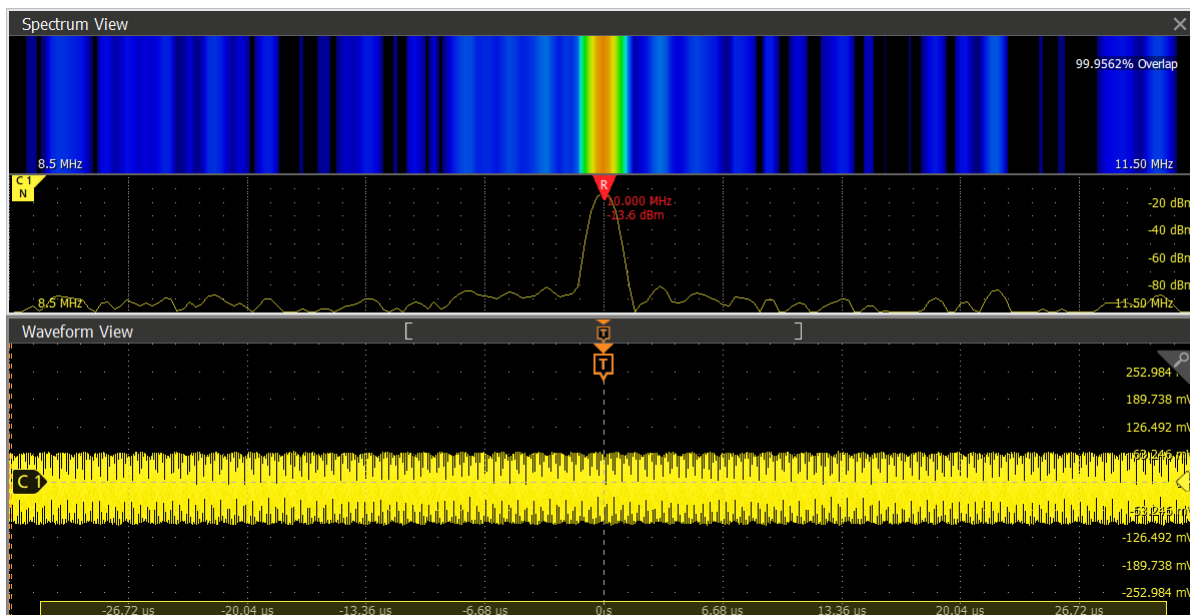

## Jitter measurement algorithms

### AC Common Mode

AC Common Mode (Pk-Pk) is the peak-to-peak amplitude of the common mode of the sources. Voltage sources are typically filtered to include only the frequency components above the cutoff frequency (30 kHz). The filter can be disabled in the measurement configuration. The measurement can be configured to take one or two sources, and the cutoff frequency may be enabled or disabled. The application calculates this measurement using the following equation:

Peak-to-Peak (High Pass Filter((Source1 + Source2)/2))

## Bit Amplitude measurement algorithm

Bit Amplitude is the difference between the levels of the "1" and "0" bits surrounding each transition, measured over a specified range at the center of the recovered unit interval. This measurement is made on each transition bit (Mean) or across the entire record (Mode).

## Bit High measurement algorithm

Bit High is the amplitude of a "1" bit. The amplitude is measured over a user-specified portion at the center of the recovered unit interval. This measurement is made on each high bit in the record (Mean) or across the entire record (Mode).

## Bit Low measurement algorithm

Bit Low is the amplitude of a "0" bit. The amplitude is measured over a user-specified portion at the center of the recovered unit interval. This measurement is made on each low bit in the record (Mean) or across the entire record (Mode).

## DC Common Mode measurement algorithm

DC Common Mode is the arithmetic mean of the common mode of two sources. This measurement is made across the entire record.

## Differential Crossover measurement algorithm

Differential Crossover is the voltage level of a differential signal pair at the crossover point(s). This measurement is made at each crossover point in the record.

## SSC Freq Dev measurement algorithm

SSC Freq Dev is the spread spectrum clock frequency deviation from the nominal frequency in ppm (parts per million).

Clock recovery is used on the measurement. The method is constant clock mean.

## SSC Modulation Rate measurement algorithm

SSC Modulating Rate is the modulating frequency of a spread spectrum clock. It is the rate that the clock frequency changes.

Clock recovery is used on the measurement. The method is constant clock mean.

## TIE

TIE (Time Interval Error) is the difference in time between an edge in the source waveform and the corresponding edge in a reference clock. The reference clock is usually determined by a clock recovery process performed on the source waveform. For Explicit-Clock clock recovery, the process is performed on an explicitly identified source.

### If the Signal Type is Clock

The application calculates Clock TIE measurement using the following equation:

$$TIE_n^{Clock} = T_n^{Clock} - T_n^{Clock}$$

Where:

*TIE Clock* is the clock time interval error.

$T_{Clock}$  is the Mid reference crossing time for the specified clock edge.

$T'_{Clock}$  is the corresponding edge time for the specified reference clock.

### If the Signal Type is Data

The application calculates Data TIE measurement using the following equation:

$$TIE_k^{Data} = T_k^{Data} - T'_k^{Data}$$

Where:

$TIE_{Data}$  is the data time interval error.

$T_{Data}$  is the Mid reference crossing time in either direction.

$T'_{Data}$  is the corresponding edge time for the specified reference clock.

The subscript k is used to indicate that there is one measurement per actual edge.

## T/nT Ratio measurement algorithm

T/nT Ratio is the ratio in dB of the midpoint level of the 1st bit after each transition to the midpoints of the 2nd and subsequent non-transition bit levels prior to the next transition. This measurement is made for each non-transition bit in the record.

## DCD

Duty Cycle Distortion (DCD) is the peak-to-peak amplitude for that portion of the deterministic jitter directly correlated with signal polarity, that is the difference between the mean positive edge displacement versus that on negative edges. A single DCD value is determined for each acquisition, by means of RJ-DJ separation analysis.

## DDJ

Data-Dependent Jitter (DDJ) is the peak-to-peak amplitude for that portion of the deterministic jitter directly correlated with the data pattern in the waveform. A single DDJ value is determined for each acquisition, by means of RJ-DJ separation analysis.

## DJ

Deterministic Jitter (DJ) is the peak-to-peak amplitude for all timing errors that follow deterministic behavior. A single DJ value is determined for each acquisition, by means of RJ-DJ separation analysis.

## Dual Dirac deterministic jitter

Dual Dirac Deterministic Jitter (DJ- $\delta\delta$ ) the peak-to-peak magnitude for all timing errors exhibiting deterministic behavior, calculated based on a simplifying assumption that the histogram of all deterministic jitter can be modeled as a pair of equal magnitude dirac functions (impulses). A single DJ- $\delta\delta$  value is determined for each acquisition, by means of RJ-DJ separation analysis.

## F/2 measurement algorithm

F/2 is the peak-to-peak amplitude of the periodic jitter occurring at a rate of Fb (data rate) divided by 2. This measurement is made across the entire record.

## F/4 measurement algorithm

F/4 is the peak-to-peak amplitude of the periodic jitter occurring at a rate of Fb (data rate) divided by 4. This measurement is made across the entire record.

## F/8 measurement algorithm

F/8 is the peak-to-peak amplitude of the periodic jitter occurring at a rate of Fb (data rate) divided by 8. This measurement is made across the entire record.

## J2

J2 is Total Jitter at a Bit Error Rate (BER) value of 2.5E-3. This statistical value predicts a peak-to-peak jitter that will only be exceeded with a probability equal to the BER.

## J9

J9 is Total Jitter at a Bit Error Rate (BER) value of 2.5E-10. This statistical value predicts a peak-to-peak jitter that will only be exceeded with a probability equal to the BER.

## CC-Jitter (Cycle to Cycle Jitter)

CC-Jitter measures the clock period change between any two adjacent cycles. Cycle-to-Cycle jitter is measured by applying a first order difference operation to the period jitter.

## Jitter Summary measurement

The Jitter Summary measurement is a predefined set of jitter measurements displayed in a single badge. The measurements include TIE, TJ@BER, Eye Width@BER, RJ-66, DJ-66, PJ, DDJ, and DCD. This measurement also adds Eye Diagram, TIE Histogram, Tie Spectrum, and Bathtub plots to the screen.

## NPJ

Non-Periodic Jitter (NPJ) is the dual-dirac magnitude of that portion of Bounded Uncorrelated Jitter (BUJ) that is not periodic. Since it is not periodic and is not correlated with the data pattern, NPJ is frequently difficult to distinguish from (Gaussian) RJ.

This component of jitter is not analyzed by default, but you can enable it by switching the jitter analysis mode to Spectral + BUJ. Since it typically requires high populations to distinguish, you may need to acquire multiple waveforms before jitter results are available when Spectral + BUJ mode is enabled.

## Phase noise

The Phase Noise measurement performs a jitter measurement, converts the result into the frequency domain, and reports the rms jitter integrated between two specific frequencies selected by the user.

A 10<sup>th</sup> decade averaging filter is applied on the phase noise spectrum to smooth the plot. Smoothing option is on by default. You can turn off the smoothing filter from the measurement configuration panel. For the phase noise calculation, smoothed Rj spectrum is used when **Smoothing** option is enabled, else original Rj spectrum is used.

The phase noise measurement is defined only for clock signals. If the source waveform appears to be a data signal, a warning message will be produced but the measurement will proceed.

## PJ

Periodic Jitter (PJ) is the peak-to-peak amplitude for that portion of the deterministic jitter which is periodic, but for which the period is not correlated with any data pattern in the waveform. A single PJ value is determined for each acquisition, by means of RJ-DJ separation analysis.

## RJ

Random Jitter (RJ) is the rms magnitude of all timing errors not exhibiting deterministic behavior. A single RJ value is determined for each acquisition, by means of RJ-DJ separation analysis.

## RJ $\delta\delta$ measurement algorithm

RJDIRAC (dual-dirac random jitter) is random jitter based on a simplifying assumption that the histogram of all deterministic jitter can be modeled as a pair of equal-magnitude Dirac functions. This measurement is made across the entire record.

## SRJ

Sub-Rate Jitter is periodic jitter at a rate that integrally divides the data rate. For example, if the data rate is F bits/second, sub-rate jitter components could occur at F/2 or F/4. It typically occurs when a serial data stream is formed by multiplexing (interleaving) an integral number of lower-rate bit streams together, although there can be other causes. Sub-rate jitter is a sub-component of PJ.

The SRJ measurement is the peak-to-peak amplitude for the sum of all F/N jitter components that are tracked by DPOJET. Since different F/N components are correlated with each other, the peak-to-peak SRJ depends on relative phases and is not simply the sum of the individual F/N components.

The SRJ measurement always tracks and accounts for N = 2, 4 and 8 regardless of whether the corresponding F/N measurements have been selected.

## TJ@BER

Total Jitter at a specified Bit Error Rate (BER). This extrapolated value predicts a peak-to-peak jitter that will only be exceeded with a probability equal to the BER. It is generally not equal to the total jitter actually observed in any given acquisition. A single TJ@BER value is determined for each acquisition, by means of RJ-DJ separation analysis.

## Eye measurement algorithms

### Eye Height measurement algorithm

If analysis method is Parametric, Eye Height is the minimum vertical eye opening at the mid of the unit interval. This measurement is made across the entire record.

If analysis method is Histogram, Eye Height is calculated non-parametrically based on the rendered eye diagram. The eye height measurement can be controlled by configuring the parameters.

**See also**

[Eye Height measurement: Configuration panel](#) on page 231

## Eye high

Eye High calculates the voltage at a selected horizontal position across the unit interval, for all High bits in the waveform. You specify the offset at which the measurement takes place from 0% to 100% of the unit interval. Configure the measurement to include all bits, only transition bits, or only non-transition bits. (Note that some of the waveform can be omitted from the measurement due to initialization of clock recovery or filtering.) A histogram of the Eye High measurement corresponds to a vertical slice through the upper half of a three-dimensional eye diagram.

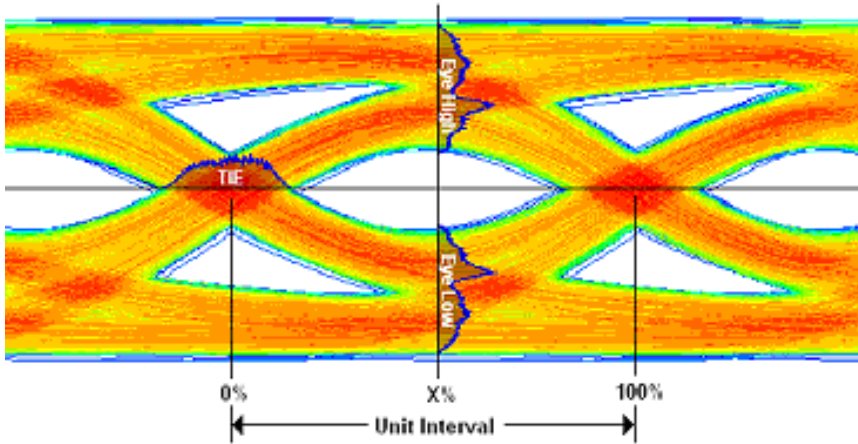

**Note:** This illustration shows how the measurement is made, and does not represent how the oscilloscope actually displays an eye diagram or histograms on an eye diagram plot.

## Eye low

Eye Low calculates the voltage at the selected horizontal position across the unit interval, for all Low bits in the waveform. A histogram of the Eye Low measurement corresponds to a vertical slice through the lower half of a three-dimensional eye diagram.

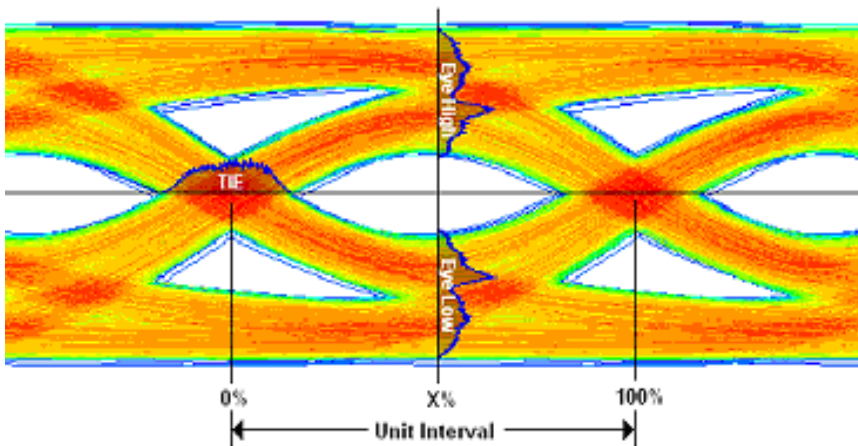

**Note:** This illustration shows how the measurement is made, and does not represent how the oscilloscope actually displays an eye diagram or histograms on an eye diagram plot.

## Eye Width measurement algorithm

If analysis method is Parametric, Eye Width is the minimum horizontal eye opening at the user-specified reference level. This measurement is made across the entire record.

If analysis method is Histogram, Eye Width is calculated non-parametrically based on the rendered eye diagram. The eye width measurement can be controlled by parameters.

### See also

[Eye Width measurement: Configuration panel](#) on page 232

## Height@BER

Height@BER is the Eye Height at a specified Bit Error Rate (BER). This extrapolated value predicts a vertical eye opening that will be violated with a probability equal to the BER. It is generally not equal to the eye height actually observed in any given acquisition. A single Height@BER value, in the given interval, is determined for each acquisition by means of Q-scale extrapolation.

## Q-factor

Quality Factor is the ratio of eye size to noise.

The final measurement value would be computed according to the equation below:

$$Q\text{-factor} = [\text{mean}(\text{EyeHigh}) - \text{mean}(\text{EyeLow})] / [\text{stddev}(\text{EyeHigh}) + \text{stddev}(\text{EyeLow})]$$

Where:

Eye High: the sample values of positive UI at x%.

Eye Low: the sample values of negative UI at x%.

For more details refer Eye Height

## Width@BER

Width@BER is the Eye Width at a specified Bit Error Rate (BER). This extrapolated value predicts a horizontal eye opening that will be violated with a probability equal to the BER. It is generally not equal to the eye width actually observed in any given acquisition. A single Width@BER value is determined for each acquisition, by means of RJ-DJ separation analysis.

## Power measurements: Input Analysis algorithms

### Power Quality measurement algorithm

The Power Quality measurement calculates the Frequency and RMS values of the voltage and current, Crest Factors of the voltage and current, True Power (TrPwr), Reactive Power (RePwr), Apparent Power (ApPwr), Power Factor (PF), and Phase Angle ( $\theta$ ) of the AC signal.

- **RMS Voltage:** The application calculates the RMS voltage using the following equation:

$$V_{RMS} = \sqrt{\frac{1}{N} \sum_{n=0}^{N-1} v^2(n)}$$

Where:

$V_{RMS}$  is the RMS voltage in Volts.

$N$  is the number of samples.

$n$  is the data point.

$v(n)$  is the absolute value of the voltage at the particular data point.



**Note:** The voltage RMS is for all the time domain cycles in the acquisition.

- **RMS Current:** The application calculates the RMS current using the following equation:

$$I_{RMS} = \sqrt{\frac{1}{N} \sum_{n=0}^{N-1} i^2(n)}$$

Where:

$I_{RMS}$  is the RMS current in Amps.

$N$  is the number of samples.

$n$  is the data point.

$i(n)$  is the absolute value of the current at the particular data point.

- **Apparent Power (ApPwr):** It is the product of the RMS voltage and current (mathematically, the absolute value of the vector sum of the true and reactive power), measured in Volt-Amperes or VA. The application calculates the **Apparent Power** (ApPwr) using the following equation:

$$ApPwr = V_{RMS} \times I_{RMS}$$

Where:

$ApPwr$  is the Apparent Power, Volt-Amperes (VA).

$V_{RMS}$  is the root mean square of the voltage.

$I_{RMS}$  is the root mean square of the current.

- **Reactive Power (RePwr):** The reactive power or the imaginary power delivered to and temporarily stored in the reactive (inductive or capacitive) elements of the load, measured in units of Volt-Amperes-Reactive or VAR. The application calculates the Reactive power using the following equation:

$$RePwr = \sqrt{ApPwr^2 - TrPwr^2}$$

Where,

$RePwr$  is the Reactive Power, Volt-Amperes-Reactive or VAR.

- **Power Factor (PF):** It is calculated using the following equation:

$$PF = \frac{TrPwr}{ApPwr}$$

Where,  $PF$  is the Power Factor.

In PQ measurement True, Apparent and Reactive Power's and Power Factor will be computed only when connection type is Line-to-Neutral.



- **Crest Factor (CF):** It is the ratio of the peak voltage value of the signal to the RMS value of the signal. Use the following equation to calculate the crest factor for the voltage and current:

$$VCF = \frac{V_{pk}}{V_{RMS}}$$

Where:

VCF is the Voltage Crest Factor.

$V_{PK}$  is the peak value of the voltage.

$V_{RMS}$  is the Root Mean Square of the voltage.

$$ICF = \frac{I_{pk}}{I_{RMS}}$$

Where:

ICF is the Current Crest Factor.

$I_{RMS}$  is the Root Mean Square of the current.

- **Phase Angle ( $\sigma$ ):** It is the angle (-90 to +90) whose cosine is the true power factor. Unit of Phase Angle is degrees. The angle is positive if the Ch1 waveform (typically voltage) leads the Ch2 waveform (typically current). The angle is negative if the Ch1 waveform lags behind the Ch2 waveform. The application calculates the phase angle using the following equation:

$$\phi = \cos^{-1} \frac{TrPwr}{ApPwr}$$

Where,  $\sigma$  is the Phase Angle, Degree.



**Note:** A warning will be shown if the edges are not available for both Voltage and Current sources. Results will be shown with valid edges only.

## Harmonics algorithm

Harmonics are the sinusoidal voltages or currents having frequencies that are integer multiples of the frequency at which the supply system is designed to operate (termed the fundamental frequency). Distorted waveforms can be decomposed into sum of the fundamental frequency and its harmonics.

- The measurement uses the Discrete Fourier Transform (DFT) to calculate the Real component (Re(k)) and Imaginary component Im(k). The Real component (Re(k)) and Imaginary component Im(k) are calculated using the following equation:

$$Re[k] = \sum_{i=0}^{N-1} x[i] \cos(2\pi ki/N)$$

$$Im[k] = -\sum_{i=0}^{N-1} x[i] \sin(2\pi ki/N)$$

Where:

Re[k] is the Real component of  $k^{\text{th}}$  harmonic.

$Im[k]$  is the Imaginary component of  $k^{th}$  harmonic.

$i$  is the Index of the input data value.

$k$  is the Index of the harmonics,  $k$  index is calculated using the harmonics number.

$x[i]$  is the discrete set of acquire time samples.

- **Harmonics  $F_k$**  is calculated using the following equation:

$$F[k] = \sqrt{2 \left\{ \left( \frac{Re(k)}{N} \right)^2 + \left( \frac{Im(k)}{N} \right)^2 \right\}}$$

Where:

$F[k]$  is the  $k^{th}$  harmonic, in Amp/Volt.

Unit of  $F[k]$  for voltage signal is Volt and for current signal is Ampere.

Harmonics is converted into dB using the following equation:

$$F[k]^{dB} = 20 \times \log_{10} (F[k]) + 120dB$$

$F[k]^{dB}$  is the  $k^{th}$  harmonic, dBA or dBV based on the harmonics input source configuration.



**Note:** In case of 'AM 14' standard, acquired signal is divided into 15 chunks and all harmonics are calculated for each chunk. For each individual harmonics maximum is taken out of 15 values.

- **RMS:** The RMS of harmonics is calculated in unit of volt or ampere using the following equation:

$$RMS = \sqrt{F1^2 + F2^2 + \dots + FOH^2}$$

$F1$  is the fundamental harmonics or line harmonics.

- **Total Harmonic distortion (THD-F):** It is measured as the ratio to the RMS value of the fundamental component of the source waveform. Reported as a percentage and calculated using the following equation:

$$THD - F = \sqrt{\frac{RMS^2 - F^2[k]}{F1}} \times 100\%$$

- **Total Harmonic Distortion (THD-R):** It is measured as a ratio to the RMS value of the source waveform. Reported as a percentage and calculated using the following equation:

$$THD - R = \sqrt{\frac{RMS^2 - F^2[k]}{RMS}} \times 100\%$$

- **Phase calculation:** The frequency domain can be expressed in polar form. In this notation, real ( $Re[ ]$ ) & imaginary ( $Im[ ]$ ) component in frequency domain are replaced with two other arrays, called the Magnitude is  $Mag[i]$ , and the Phase is written as:  $\sigma$ . The magnitude and phase are a pair-for-pair replacement for the real and imaginary parts.

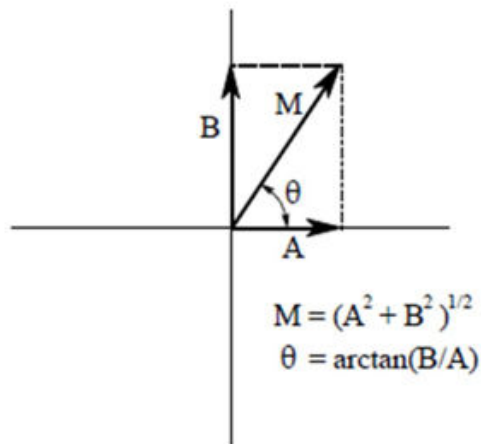

$$Mag[i] = \sqrt{Rel[i]^2 + Img[i]^2}$$

Where:

$i$  is the Index of harmonics.

$Rel[i]$  is the Real component of the harmonics (Cos frequency).

$Img[i]$  is the Imaginary component of the harmonics (Sin frequency).

$$Phase[k] = \tan \frac{Img[k]}{Rel[k]}$$

If,  $Rel[k] < 0$  &  $Img[k] < 0$   $Phase[k] = Phase[k] - \pi$

If,  $Rel[k] < 0$  &  $Img[k] > 0$   $Phase[k] = Phase[k] + \pi$

- **Partial Odd Harmonics Current (POHC(M)):**

For the 21st standard higher odd order harmonics, the average values obtained for each individual odd harmonic over the full observation period, are calculated from the acquired waveform. The measured partial odd harmonic current does not exceed the partial odd harmonic current which can be calculated from the applicable limits.

$$POHC(M) = \sqrt{\sum_{k=21,23}^{OH} F[k]^2}$$

Where:

$M$  is the measured value.

$POHC(S)$  and  $POHC(L)$  is the (S) is pass and fail status based on (L) limits.

## Input Capacitance algorithm

Input capacitance measures the input capacitance of a DUT using the input voltage and current signals. Supports annotation where you can navigate between Previous and Next regions from the Results badge.

The equation for input capacitance is  $c = q/v$ .

where:

- c - capacitance in farads
- q - accumulated charge, which is the integration of the current waveform
- v - peak-peak voltage

## Inrush Current algorithm

Inrush Current measures the peak value of the inrush current of the DUT. It is a single source current measurement. Supports annotation where you can navigate between Previous and Next regions from the Results badge.

## Power measurements: Amplitude Analysis algorithms

### Cycle Base measurement algorithm

Cycle Base is calculated using the selected Base Top method. Cycle Base is the most common data value below the midpoint of the waveform, when the default Base Top method Histogram Mode is selected. This measurement is made across each cycle in the record.

### Cycle Maximum measurement algorithm

Cycle Maximum is the maximum data point. Typically the most positive peak voltage.

Measurements are calculated on each cycle within the record.

### Cycle Minimum measurement algorithm

Cycle Minimum is the minimum data point. Typically the most negative peak voltage.

Measurements are calculated on each cycle within the record.

### Cycle Peak-to-Peak measurement algorithm

Cycle Peak to peak is the difference between Cycle Maximum and Cycle Minimum calculated for each cycle.

$$PeaktoPeak = Max - Min$$

Measurements are calculated on each cycle within the record.

### Cycle Top measurement algorithm

Cycle Top is calculated using the selected Base Top method. Cycle Top is the most common data value above the midpoint of the waveform, when the default Base Top method Histogram Mode is selected. This measurement is made across each cycle in the record.

### Cycle Amplitude measurement algorithm

Cycle Amplitude is the difference between the Top value and the Base value. This is applicable for each cycle.

$$Cycle Amplitude = Top - Base$$

## Power measurements: Timing Analysis algorithms

### Frequency measurement algorithm

Frequency is the reciprocal of the period. Frequency is typically measured in Hertz (Hz) where 1 Hz = 1 cycle per second.

$$\text{Frequency} = 1 / \text{Period}$$

### Negative Duty Cycle measurement algorithm

Negative Duty Cycle is the ratio of the negative pulse width to the signal period, expressed as a percentage.

$$\text{NegativeDutyCycle} = \frac{\text{NegativeWidth}}{\text{Period}} \times 100\%$$

*NegativeWidth* is defined in [Negative Pulse Width measurement algorithm](#).

If *Period* = 0 or undefined then return an error.

### Negative Pulse Width measurement algorithm

Negative Pulse Width is the time the signal remains below the mid reference level. This measurement is made on each cycle in the record.

### Period measurement algorithm

Period is the time required to complete a cycle. This measurement is made on each cycle in the record.

### Positive Duty Cycle measurement algorithm

Positive Duty Cycle is the ratio of the positive pulse width to the signal period, expressed as a percentage.

$$\text{PositiveDutyCycle} = \frac{\text{PositiveWidth}}{\text{Period}} \times 100\%$$

*PositiveWidth* is defined in [Positive Pulse Width algorithm](#).

### Positive Pulse Width measurement algorithm

Positive Pulse Width is the time the signal remains above the mid reference level. It is the distance from a rising edge to the next falling edge.

## Power measurements: Switching Analysis algorithms

### Switching Loss algorithm

Switch-Mode Power Supply (SMPS) design has three types of losses, they are Turn-On ( $T_{on}$ ), Turn-off ( $T_{off}$ ), and Conduction loss (Cond). To achieve the maximum efficiency, losses should be reduced. This section details about the basics of Switching Loss Analysis. A simplified SMPS schematic is shown below:

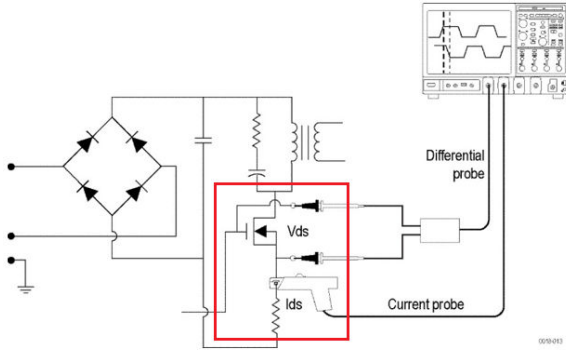

SMPS circuit diagram shows the points where switching loss can be measured. After full wave rectification, the current signal should pass through the harmonic standard and enters for DC conversation. MOSFIT plays an important role to meet the design of SMPS.

Regions of  $T_{on}$ ,  $T_{off}$ , and Conduction loss (Cond) with voltage source ( $V_{ds}$ ) and current source ( $I_{ds}$ ) are shown in Switching Loss  $T_{on}$ ,  $T_{off}$ , and Conduction loss regions.

All the switching losses are measured on Power signal, based on  $V_{ds}$  and  $I_{ds}$  transition.

$T_{on}$  Loss region: When  $V_{ds}$  starts rolling towards zero, the  $I_{ds}$  starts to roll upward.

$T_{off}$  Loss region: When  $V_{ds}$  starts rolling upwards, the  $I_{ds}$  start to roll towards zero.

Conduction Loss region: The region when the  $I_{ds}$  is high and  $V_{ds}$  is low.

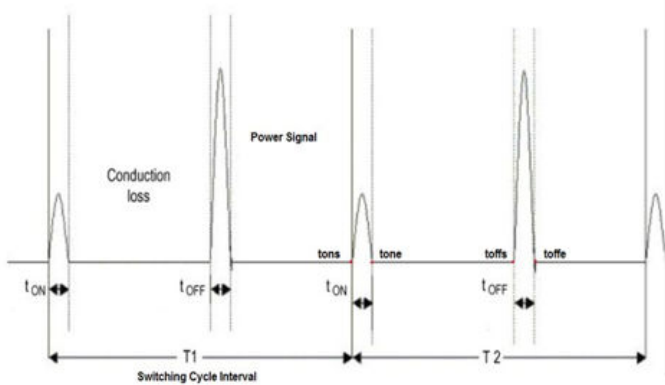

T1 is the First switching cycle.

T2 is the Second switching cycle.

•  **$T_{on}$  and  $T_{off}$  losses**

$T_{on}$  and  $T_{off}$  losses per switching cycle are computed as in the following equations:

$$T_{oni} = f_{swi} \times \int_{T_{on-Start_i}}^{T_{on-Stop_i}} (V_{ds} \times I_{ds}) dt \text{ Watt}$$

$$T_{offi} = f_{swi} \times \int_{T_{off-Start_i}}^{T_{off-Stop_i}} (V_{ds} \times I_{ds}) dt \text{ Watt}$$

Where,

$T_{oni}$  is the Turn on loss of the  $i^{th}$  switching cycle, in watt.

$T_{OFFi}$  is the Turn off loss of the  $i^{th}$  switching cycle, in watt.

$f_{swi}$  is the Switching frequency of the  $i$ th switching cycle, in Hz.

$(T_{off-Stop}_i)$  is the stop point of  $T_{off}$  region of the  $i$ th switching cycle, in time unit.

$(T_{on-Stop}_i)$  is the stop point of  $T_{on}$  region of the  $i$ th switching cycle, in time unit.

$(T_{on-Start}_i)$  is the start point of a power  $T_{on}$  region of the  $i$ th switching cycle.

$(T_{off-Start}_i)$  is the start point of  $T_{off}$  region, in time unit  $V_{ds}$  - Voltage drain current, in Volts.

$I_{ds}$  is the drain current, in Amps.

- **Energy Loss Computation**

Energy loss computation for  $T_{on}$  and  $T_{off}$  are calculated using the following equation:

$$T_{Eoni} = \int_{T_{on-Start}_i}^{T_{on-Stop}_i} (V_{ds} \times I_{ds}) dt \text{ Watt}$$

$$T_{Eoffi} = \int_{T_{off-Start}_i}^{T_{off-Stop}_i} (V_{ds} \times I_{ds}) dt \text{ Watt}$$

Where:

$T_{Eoni}$  is the  $i$ th switching cycle turn on energy loss in joule.

$T_{Eoffi}$  is the  $i$ th switching cycle turn off energy loss in joule.

- **Computation of Conduction**

Conduction is computed as  $R_{DS(on)}$  value for the MOSFET is used to calculate total loss in the application. To measure conduction loss and energy in a MOSFET, using the following equation:

$$Cond_i = f_{swi} \times \int_{T_{on-Start}_i}^{T_{off-Start}_i} (R_{ds}(on) \times I_{ds}^2) dt \text{ Watt}$$

$$Cond_{Ei} = \int_{T_{on-Start}_i}^{T_{off-Start}_i} (R_{ds}(on) \times I_{ds}^2) dt \text{ Joule}$$

Where:

$R_{DS(on)}$  is the Dynamic resistance, in  $\Omega$ .

$Cond_i$  is the Conduction Loss in Watt,  $Cond_{Ei}$  is the Conduction Energy Loss in Joule.

$Cond_i$  is the  $i$ th switching cycle conduction loss in watt.  $Cond_{Ei}$  is the  $i$ th switching cycle conduction energy in joules.

$f_{swi}$  is the  $i$ th switching cycle frequency, in Hz.

$I$  is the Cycle number.

$Nc$  is the Number of conduction cycles.

To measure conduction loss in a BJT/IGBT, using the following equation:

$$Cond_i = f_{swi} \times \int_{T_{on-Start}_i}^{T_{off-Start}_i} (V_{ce}(SAT) \times I_{ds}) dt \text{ watt}$$

$$Cond_{Ei} = \int_{T_{on-Start}_i}^{T_{off-Start}_i} (V_{ce}(SAT) \times I_{ds}) dt \text{ joule}$$

Where,  $V_{CE}(sat)$  is the voltage in volt, which should be configure in application.

- **Computation of Average Loss and Total Loss**

Average and Total loss are calculated using the following equation:

$$T_{onAvg} = \frac{1}{Nc} \sum_{i=1}^{Nc} T_{on_i}$$

$$T_{offAvg} = \frac{1}{Nc} \sum_{i=1}^{Nc} T_{off_i}$$

$$Cond_{Avg} = \frac{1}{Nc} \sum_{i=1}^{Nc} Cond_i$$

$$TotalLoss = T_{onAvg} + T_{offAvg} + Cond_{Avg}$$

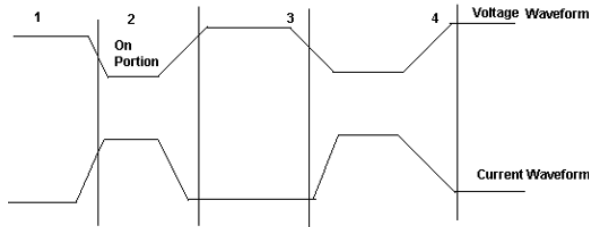

Total Switching Loss=Ton Loss+Toff Loss+Conduction Loss

Concept to identify Ton and Toff using gate voltage for edge analysis:

Use gate voltage for edge analysis with default 50% edge level and hysteresis 10%.

- To find the start of Ton: The start of the Ton is 5% or 1.5 V whichever is lower on the rise slope of the gate voltage.
- To find the stop of Ton: The start index on the switch voltage is 5% or 1.5 V of the rise slope gate voltage. Move forward on the switch voltage from the start index until 5% or the configured level is met.
- To find the start of Toff: The start index is 80% of the gate voltage. From the Stop index, search for 5% of the switch voltage (on rise slope).
- To find the stop of Toff: The 80% of the gate voltage is start index. From this start index on switch current (fall slope) move forward until 5% of the max (switch current) is met.

## dv/dt algorithm

dv/dt represents the rate at which the voltage changes during switching. The application uses the math feature to provide a differentiation waveform of the voltage input.

When you run the measurement, the application calculates dv/dt for the first edge by taking the default levels as 10% and 90% and displays the results.

Select a specific section of the waveform on the live signal by providing inputs for high and low levels in terms of percentage and absolute value of voltage and current. Select the edge of interest by viewing it visually on the oscilloscope. You can also enter the edge number on the results panel. The application displays the results for the selected edge and levels on the results panel.

The application calculates dv/dt using the following equation:

$$\frac{dv}{dt} = \frac{v(R_t) - v(R_B)}{R_T - R_A}$$

Where:

X is the timing values.

Y is the vertical (voltage) values of the waveform data between the cursors.



## di/dt algorithm

di/dt measurement represents the rate at which the current changes during switching. The application uses the oscilloscope's built in math feature to provide a differentiation waveform of the current input.

When you run the measurement, the application calculates di/dt for the first edge by considering the default levels as 10% and 90% and displays the results.

Select a specific section of the waveform on the live signal by providing inputs for high and low levels in terms of percentage and absolute value of voltage and current. Select the edge of interest by viewing it visually on the oscilloscope. You can also enter the edge number on the results panel. The application displays the results for the selected edge and levels on the results panel.

The application calculates di/dt using the following equation:

$$\frac{di}{dt} = \frac{i(R_t) - i(R_B)}{R_T - R_A}$$

Where:

I is the timing value.

t is the vertical values of the waveform data.

## SOA algorithm

SOA plots the graph of the voltage and current waveform. You can configure SOA mask by creating voltage and current co-ordinates in the mask table. You can save and recall mask files. The extension of the mask file name is .pwrmsk.

SOA has two outputs:

1. SOA X-Y plot with mask showing hits on the mask.
2. SOA summary on the measurement badge displays the number of hits with Pass/Fail status.

## R<sub>DS(on)</sub> algorithm

Dynamic resistance (R<sub>DS(on)</sub>) is the resistance offered by a switching device when it is in the ON condition. Power helps to monitor the dynamic resistance using a Time Trend plot. You can calculate R<sub>DS(on)</sub> by using the below formula:

$$R_{DS(on)} = v/i = v(t)/i(t)$$

where, v/i is the ratio of voltage to current sample points. It is applicable for switching semiconductors.

## Power measurements: Magnetic Analysis algorithms

The Magnetic measurements include I vs. ∫V, Inductance, Magnetic Property, and Magnetic Loss. When using I vs. ∫V measurement, take care to check that the voltage 'V' does not have any DC components.

Use AC coupling on the input signal to avoid any DC shifts on the integral of the voltage waveform.

Magnetic Analysis is supported for 4\*/5/6 series.

\* For 4 Series Oscilloscopes the record length is limited to 5 M.

## Inductance algorithm

It measures the inductance (the integral of the voltage divided by the current) of a magnetic component during in-circuit operation. The application creates a single cycle by averaging multiple cycles of current and integrated voltage.

An electric circuit has electromotive force created by a change of current in the same circuit known as self-inductance or in a neighboring circuit as mutual-inductance. Inductance displays the Inductance plot. The unit of Inductance is Henry.

The Inductance provides a view of the core behavior while it is under operation.

## I vs (integral of) V algorithm

The XY plot of integral of voltage against current. The integral of the voltage is proportional to B. The integral of current is proportional to H.

## Magnetic Loss algorithm

The average value of the product of the voltage times current through the inductor. This represents the total loss of the magnetic device and consists of resistive and eddy current losses during circuit operation.

## Magnetic Property algorithm

The following diagram shows a plot of Hysteresis in a typical magnetic material (magnetic field strength (H) versus saturation flux density (B)).

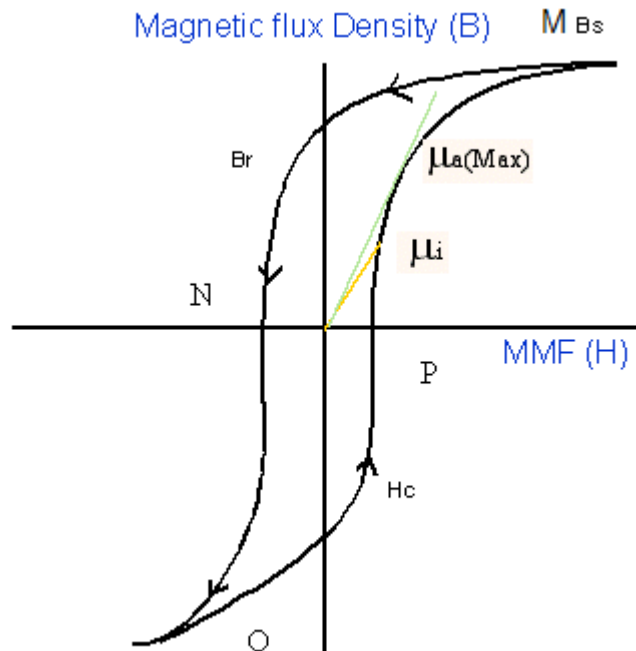

Figure 34: B-H curve

$B_s$  is the Saturation Flux Density

$B_r$  is the Remanence Flux Density

$H_c$  is the Coercive Force ( $H_c$ )

$U_i$  is the Initial Permeability

$U_a$  is the Max Amplitude permeability

H is the magnetic field used to induce Magnetic Flux in the magnetic material

MMF is Magneto Motive Force, it is also known as Magnetic Field Strength



**Note:** The data waveform starts from the Max value of H, decreases, and then increases again (M-N-O-P).

### Magnetic Field Strength (H)

The previous figure shows the hysteresis in a typical magnetic material. The magnetic field induces a magnetic flux in the DUT. The units of measurement are Ampere per meter in SI unit, and Oersted in CGS unit.

### Saturation Flux Density ( $B_s$ )

The Saturation Flux Density represents maximum magnetic flux density that can be induced in the magnetic material regardless of the magnitude of the externally applied field H. This is represented in the B-H curve where B value is considered, when H is maximum.

$$B_s = \text{Max}(B_k)$$

The Magnetic Field Intensity H is also calculated on the maximum flux density cycle  $B_k$ .

$$B_s = \text{Max}(B)$$

Index I where H is maximum

$$I = \text{Index of}(\text{Max}(H))$$

$$B_s = B(I) (2)$$

### Remanence ( $B_r$ ):

Remanence is the Induced magnetic flux density that remains in the material after the externally applied magnetic field (H) is returned to zero during the generation of the hysteresis loop. This represents max value of B for all values of zero value of H in the B waveform.

Find the index at zero value of H on the H waveform and calculate the maximum value of B from these indices.

Let 'q' be the index at zero value of H on H waveform. Let the q1 and q2 be the indices of the waveform. Calculate the value of B at the Indices q1 and q2 on the  $K^{\text{th}}$  cycle. The maximum magnitude value of B is the remanence Flux density.

### Coercive Force( $H_c$ )

Coercivity is the value of H found at the intersection of the H-axis with the hysteresis loop. This represents the external field required to cause the induced flux density (B) to reach zero during the measurement cycle of a hysteresis loop.  $H_c$  is symmetrical with the positive and negative axis.

Coercivity  $H_c$  is calculated on the cycle where the maximum flux density occurs in the entire acquired waveform.

Finding the index at zero B value on the B waveform: Let 'q' be the index at zero value of B on B waveform. Let q1 and q2 be the indices on the B waveform where B is zero.

Coercivity is the maximum magnitude of the H data at the indices of q1 and q2 is the coercivity.

### Permeability

The ratio of B and H calculated on the  $B_k$  cycle. Select the points on the B-H plot using the cursor and calculate the slope of the B-H curve using the data selected between the cursor. You can choose the portion of the plot using the cursor to obtain the results.

In the B-H curve plot there is a provision to select the points using the waveform cursors 1 and 2. This is used to calculate the slope of B-H curve using the data between the cursors 1 and 2. The computed slope as explained below displays the scalar value of the permeability ( $\mu$ ) in the results badge and table.

In slope calculation, there are N points between the cursors:

Find

$$H_{av} = (H1+H2+...Hn)/N$$

$$B_{av} = (B1+B2+...Bn)/N$$

$$H_{normi} = Hi-Hav, i=1..N$$

$$B_{normi} = Bi-Bav, i=1..N$$

$$B/H = \text{SUM}(H_{normi}^1 * B_{normi}^1 + H_{normi}^2 * B_{normi}^2 + \dots + H_{normi}^N * B_{normi}^N) / \text{SUM}(H_{normi}^1 * H_{normi}^1 + H_{normi}^2 * H_{normi}^2 + \dots + H_{normi}^N * H_{normi}^N)$$

Where,

B/H is the Permeability ( $\mu$ )

### Magnetic Loss

Magnetic property computes total magnetic loss and reports hysteresis loss (Hys)

The total magnetic loss and its components account for multiple secondary current windings along with primary windings for the computation.

## Power measurements: Output Analysis algorithms

### Line Ripple algorithm

Line Ripple measures the voltage of a power supply which has been derived from an alternating current (AC) source, displaying the results as a peak-to-peak value and RMS value. In Line Ripple measurements, the time base is set to display three cycles of 50 Hz or 60 Hz in the input waveform.

Depending upon the coupling type you select, the application sets the required offset and adjusts the vertical scale to the appropriate sensitivity.

### Switching Ripple algorithm

Switching Ripple measures the voltage ripple at operating the specified power supply switching frequency, up to 1 MHz.

### Efficiency algorithm

Efficiency measures the ratio of output power to input power for a power conversion circuit. The measurement supports three outputs, the maximum and efficiency is computed at each output. If there are more than one output, then the total efficiency value will be computed. You can configure AC/DC type at input and output sides.



**Note:** This measurement uses a minimum of four sources and a maximum of eight sources. Two sources are used to measure the input voltage and current to the power supply. Two to six sources are used to measure the power supply output voltage and current.

Math is used to compute Input Power waveform using  $V * I$  equation. Computation happens over an exact integer number of cycles to get an accurate result, that is, from the first zero crossing to the last zero crossing.

Math calculates the Input Power, using

$$Math1 = V(t)_{in} * I(t)_{in}$$

Similarly another math calculates the Output Power using  $V * I$  at the output side

$$\text{Math2} = V(t)_{o1} * I(t)_{o1}$$

Power Efficiency = Output Power / Input Power

$$\text{Efficiency in \%} = \frac{\sum(\text{Math1})}{\sum(\text{Math2})} * 100$$



**Note:** If more cycles are captured, then the power solution will automatically consider all the integral cycles, starting from first (mid) crossing to the last valid (mid) crossing.



**Note:** For multiple outputs, the total efficiency is computed as the ratio of input power to the sum of output(s) power. The total efficiency is expected to be within 100%, since all the outputs are from a same input power. If the efficiency is greater than 100 %, then the application displays a warning message.

## Turn On Time

**Turn On Time** is the time taken to get the steady state output voltage of the power supply after the input voltage is applied.

- The **Maximum Voltage** value should be greater than the **Input Trigger** level.
- The **Maximum Voltage** level value sets the waveform vertical settings to approximately one-fourth of the specified level.
- The **Maximum Time** field sets the horizontal units so as to display the entire time in which the output is supposed to reach zero.
- The **Input Trigger** level is set based on the 50 % level of the input channel.
- The **Turn Off Time** sets the trigger slope to rising edge.

## Turn Off Time

**Turn Off Time** is the time taken to get the output voltage to low level (close to zero) after the input voltage is removed.

- The **Maximum Voltage** value should be greater than the **Input Trigger** level.
- The **Maximum Voltage** level value sets the waveform vertical settings to approximately one-fourth of the specified level.
- The **Maximum Time** field sets the horizontal units so as to display the entire time in which the output is supposed to reach zero.
- The **Input Trigger** level is set based on the 50 % level of the input channel.
- The **Turn Off Time** sets the trigger slope to rising edge.

## Power measurements: Frequency Response Analysis algorithms

### Control Loop Response (Bode) measurement algorithm

Control Loop Response (Bode) computes and plots gain as  $20 \log (V_{out}/V_{in})$  and phase difference between  $V_{in}$  and  $V_{out}$  at each frequency within the swept band. The resulting plot is commonly referred to as a Bode Plot.

Points per decade is 10 by default, maximum is 100.

Start frequency is 100 Hz.

Stop frequency is 10 MHz.

$$\text{Number of frequency points} = \text{ppd} * (6 - 2)$$

where:

- 6 is  $10^6 = 10 \text{ MHz}$
- 2 is  $10^2 = 100 \text{ Hz}$

The gain and phase margin are two metrics to tell the stability of the system.

$$\text{Bode} = 20 * \text{LOG}_{10}\left(\frac{V_{out}}{V_{in}}\right)$$

Gain for

where:

- $V_{out}$  is the amplitude of the input signal.
- $V_{in}$  is the input signal.

Phase for Bode is the time shift between the input and output signals.

## Power supply rejection ratio measurement algorithm

Power Supply Rejection Ratio (PSRR) measures both the modulated input and output AC voltage levels and then computes the rejection ratio as  $20 \log (V_{in}/V_{out})$  at each frequency within the swept band.

## Impedance measurement algorithm

Impedance is computed as the channel ratio of  $V_{out}/V_{in}$  for each frequency.

The Phase is computed similar to Control Loop Response measurement.

The Group Delay(Tg) response plot is calculated using below equation.

$$Tg(i) = \frac{(\text{Phase}(i) - \text{Phase}(i - 1))}{(\text{Frequency}(i) - \text{Frequency}(i - 1))}$$

The Q(Tg) response plot is calculated using below equation.

$$Q(Tg) = \frac{\text{PI} * Tg * \text{Average Frequency}}{360}$$

where,

Average frequency is  $(\text{Frequency}(i) + \text{Frequency}(i-1)) / 2$

## IMDA measurements: Electrical Analysis algorithms

### Power Quality measurement algorithm

Refer to [Power Quality measurement algorithm](#) on page 683.

Power Quality is available under Input Analysis. This computes sub-measurements for all phases (3 phases) based on the wiring configuration. Phase of each voltage and current is found using DFT at operation frequency. Phase angle is calculated as difference between current phase and voltage phase. Voltage is always considered as reference. Power Factor is computed based on  $\cos$  (Phase difference). Reactive power is computed based on formula.

$$RePwr = \sqrt{ApPwr^2 - TpPwr^2}$$

The sign of the RePwr is derived from sign of V and I Phase difference.

The results for all the configured phases are displayed.

$V_{MAG}$  and  $I_{MAG}$  are the sub measurements of IMDA Power Quality measurement.

$V_{MAG}$  (V) and  $I_{MAG}$  (A) computes the RMS value at fundamental frequency of the 3 Phase signal using FFT method. This represents RMS value calculated from the frequency domain.

### Reactive power and apparent power values in IMDA PQ, with 2 wattmeter method

**Requirements:** Follow the equations for PQ 2V2I wiring.

Input is Vab, Vcb, Ia, and Ic

W1 = instantaneous power is Vab \* Ia

W2 = instantaneous power is Vcb \* Ic

True Power = W1 + W2

Apparent Power = Va \* Ia + Vb \* Ib + Vc \* Ic

Compute Line to Neutral Voltages from Line to Line Vab and Vcb.

$V_b = (-V_{ab} - V_{cb}) / 3$

$V_a = V_{ab} + V_b = 2(V_{ab} - V_{cb}) / 3$

$V_c = V_{cb} + V_b = 2(V_{cb} - V_{ab}) / 3$

$I_b = -I_a - I_c$

### Harmonics measurement algorithm

Refer to [Harmonics algorithm](#) on page 685 Harmonics is available under Input Analysis. This computes sub-measurements for all phases (3 phases) based on the wiring configuration. The algorithm is same as in 5-PWR Harmonics measurement where as in 5-PWR computation happens for one pair of Voltage and Current.

Total Demand Distortion (TDD): It is measured as the ratio of current harmonics to the maximum load current. This measurement is best utilized with multiple acquisition. Reported as percentage and calculated using following equation.

$TDD = \min (THDR_i), i = 1 \text{ to } N, \text{ in } N \text{ acquisitions.}$

Where THDR<sub>i</sub> is the value of THDR for ith acquisition.

### Ripple Analysis algorithms

The Ripple Analysis measures RMS at configured Ripple frequency and peak to peak of time domain waveform for the configured phases.

### Efficiency measurement algorithm

Refer to [Efficiency algorithm](#) on page 696

Efficiency measures the ratio of output power to input power for a Motor and Drive per phase. Efficiency displays results for each phase and total system efficiency.



**Note:** Efficiency may not report proper results with zero input signals.

**Table 17: Invalid Input and Output Wiring for Efficiency measurement**

Input	Output
DCIn	3V3I (3P3W) No LL-LN
1V1I (1P2W)	3V3I (3P3W) No LL-LN
3V3I (3P3W) No LL-LN	DCOut
3V3I (3P3W) No LL-LN	1V1I (1P2W)
3V3I (3P3W)	2V2I (3P3W)
3V3I (3P3W)	3V3I (3P3W)
3V3I (3P3W)	3V3I (3P4W)
2V2I (1P3W)	3V3I (3P3W)
2V2I (3P3W)	3V3I (3P3W)

**Table 18: Not supported Input and Output Wiring for Efficiency measurement**

Input	Output
3V3I (3P4W)	2V2I (3P3W)
3V3I (3P4W)	3V3I (3P3W)
3V3I (3P4W)	3V3I (3P4W)
2V2I (1P3W)	3V3I (3P4W)
2V2I (3P3W)	3V3I (3P4W)

Line-to-Line and Line-to-Neutral: When selected converts mathematically from Line-to-Line results to Line-to-Neutral. This is available only for 3V3I wiring.

## DQ0 measurement algorithm

Direct Quadrature Zero Transformation (DQ0) represents the mathematical transformation of balanced three-phase circuits (ABC/XYZ) and reduces the three AC quantities to two equivalent DC quantities. It is often used to simplify the analysis of three phase synchronous machines for the control of three phase inverters. The two axis are called as D-axis (direct), and the Q-axis (quadrature).

Generally, the Q-axis is at an angle of 90 degrees from the direct axis. The DQ0 transform helps designers to view the virtual representation of ABC three phase signals and tune their controller design. Display computed normalized D, Q, Zero, and Resultant magnitude and phase drive vectors in time-domain wave view as auto-created Math.

You can configure mechanical sensors and their output. The default sensor is Hall Sensor. The QE1 encoder output basically gives the rotor magnet position at zero degree. This angle is used as theta in the Clarke-Park matrix transformation while computing DQ0 components.



$$\begin{bmatrix} D \\ Q \\ Z \end{bmatrix} = \frac{2}{3} \begin{bmatrix} \cos \theta & \cos \left( \theta - \frac{2\pi}{3} \right) & \cos \left( \theta + \frac{2\pi}{3} \right) \\ -\sin \theta & -\sin \left( \theta - \frac{2\pi}{3} \right) & -\sin \left( \theta + \frac{2\pi}{3} \right) \\ \frac{1}{2} & \frac{1}{2} & \frac{1}{2} \end{bmatrix} \begin{bmatrix} A \\ B \\ C \end{bmatrix}$$

Where A, B, and C can be taken as  $I_{A, B, C}$  or  $V_{(AN, BN, CN)}$ . The ABC signals are three phase outputs from the Drive.

Where  $\theta$  is Encoder mechanical output.

When sensor output unchecked, the theta is  $\theta$  is  $2\pi ft$ . The 'f' is the frequency of the three phase signals.

The transform matrix converts time-varying AC signals into time-invariant DC components.



**Note:** In DQ0 algorithm, the convention used is that D-axis is aligned to A-axis. To align Q-axis to A-axis, add 90 degrees to offset angle in the measurement configuration.

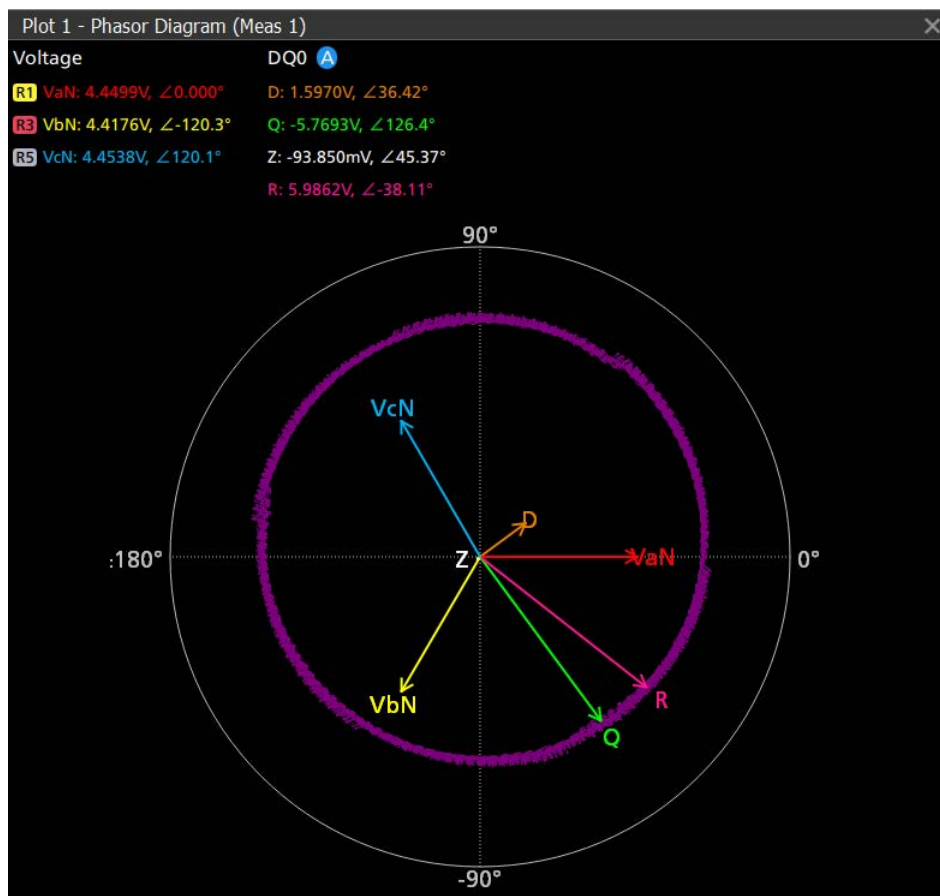

There are two angles, initial angle and incremental angle. The initial angle is where QEI Z index pulse starts and D-axis gets aligned at this position. This is not applicable in case of no Z index pulse.

DQ0 with Resultant vector (R) updates at the rate of encoder output resolution. QEI Index pulse (Z) gets zero degree phase of the rotor magnet and D-axis gets aligned to Resultant vector (R).

The Resultant Drive vector (R) is computed as

$$R = \sqrt{D(n)^2 + Q(n)^2}$$



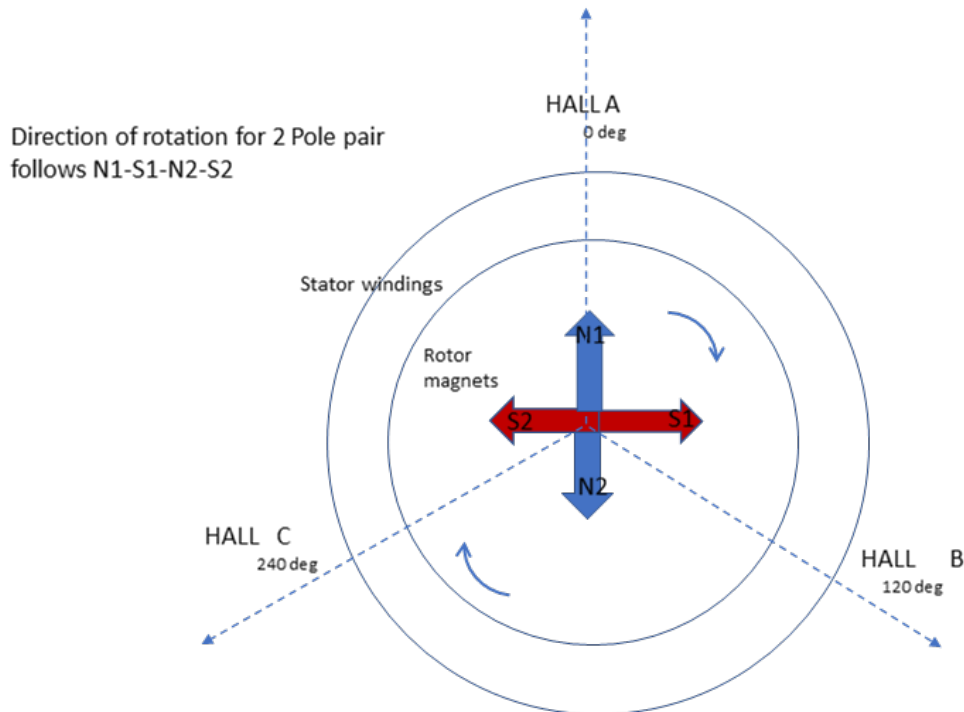

## Speed

$$\text{Speed in RPM} = \left( \left( \frac{1}{t_{sp} - t_{st}} \right) * 60 \right) * G$$

Where difference between  $t_{sp}$  and  $t_{st}$  is defined by the number of pole pairs.

60 is the RPM that is revolutions per minute.

G is Gear ratio.

## Direction

$$f_{\text{ORDER}}(\text{"ORDER"}) = (R1_A - R1_B - R1_C)$$

$$f_{\text{ORDER}}(\text{"ORDER"}) = (R1_A - R1_C - R1_B)$$

Where Order function checks for the sequence of rising edges on all three HALL Sensor signals.

## Acceleration

Acceleration is rate of change of speed per unit time.

$$\text{Acclr} = \frac{\text{Speed}(t_{n+1}) - \text{Speed}(t_n)}{((t_{n+1}) - t_n)}$$

## Angle

Increment angle (in deg) = 360 / Edges per Mechanical cycle

Edges per Mechanical cycle = Steps \* Pole pair

Where Steps is 6 slots in 1 electrical cycle.

Angle is computed at every edge. For  $i^{th}$  edge, you will get the transition from zero degree and multiply for increment angle (resolution of angle).

### IMDA measurements: Using QEI

The Quadrature Encoder Interface (QEI) consists of a disc, mounted on the rotating shaft, light sources (LEDs), and light receivers (phototransistors).

The light of LEDs passing through the slits on the disc is transmitted to phototransistors, and in turn, is converted to square wave-shaped electric signals. The number of these pulses per one rotation is called Pulses per rotation (PPR).

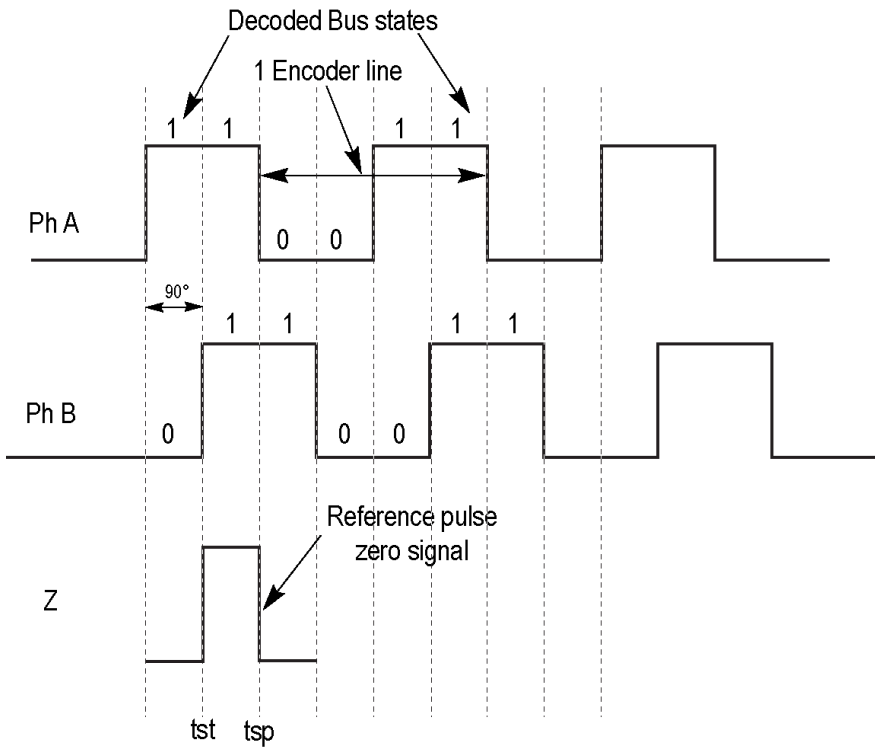

1303-023

The  $t_{st}$  start time of the Rise edge of the Phase A or B signal comes immediately after index Pulse Z rise edge. The  $t_{sp}$  is stop time on next rise edge corresponding Phase. The Rise edge is taken after the index Pulse Z rise edge.

### Speed

Speed defines the number of rotations per minute of the motor. The configurable units are RPM and Hz.

$$\text{Speed (in RPM)} = \frac{(G * 60)}{(4 * \text{Time Difference} * \text{PPR})}$$

G is Gear ratio, helps to get motor rotation speed from shaft speed.

60 represents seconds per minute.

4 represents A and B edges. For example, One A (R-R) -B (R-R) cycle is divided into four sub-parts. So  $4 * \text{PPR}$  is the total number of divisions per electrical rotation. R-R is Rise to Rise slope.

Time Difference is difference between transition of Phase A and Phase B. It can be averaged over one mechanical rotation with measurement configuration.

PPR is Pulse per rotation.

Speed (in Hz) = Speed (in RPM) \* 60

## Direction

The direction of rotation is determined by the phase difference between the two signals. For example, If Phase A leads Phase B, then the direction of the motor is positive or forward. If Phase B leads, then the direction of the motor is deemed negative or reverse or CW.

## Angle

Angle is determined by the number of pulses per rotation.

Increment angle (in deg) =  $360 / \text{Edges per Mechanical cycle}$

Edges Per Mechanical cycle =  $4 * \text{PPR}$

PPR is Pulse per rotation

Angle is computed at every edge. For  $i^{\text{th}}$  edge, you will get the transition from zero degree in that particular mechanical cycle and multiply for increment angle (resolution of angle).

## IMDA measurements: Using Resolver

Resolver is a type of sensor mounted with a motor to determine angular position of the rotor. Due to its simple construction and reliability, it is widely used in rugged conditions with high temperature and vibrations.

It consists of an excitation coil which takes high frequency sinusoid input and two output orthogonal coils. From the output coil signals, rotary position is determined.

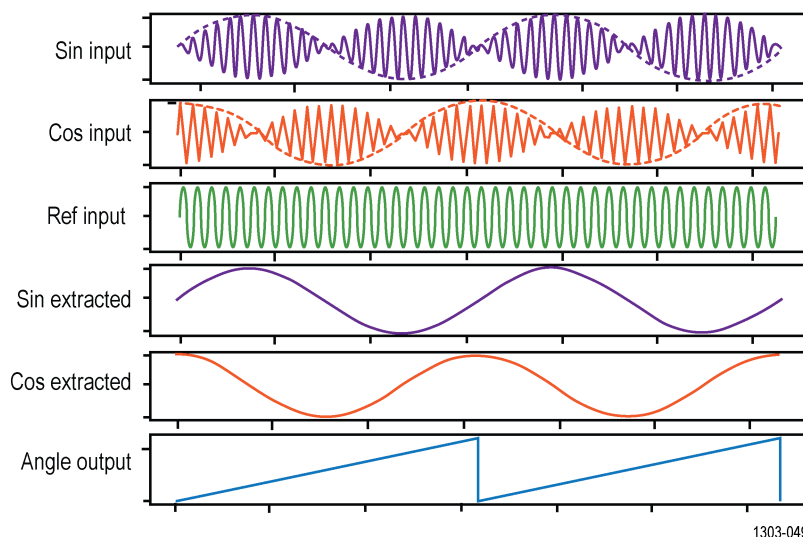

The mechanical measurements with Resolver takes three analog input waveforms, sin, cos, and ref. Ref is the excitation signal, where as sin and cos are output coil signals. Sin and cos signals are modulated with ref signal. Sin and cos envelopes have to be extracted before measuring various parameters with them. The envelope, which is the output of extraction, will be sin and cos signals, with an offset of 90 degrees in between them.

At any given point of time, angle is determined as,

Angle =  $\arctan(\text{sin value}/\text{cos value})$

Speed is determined by using sin envelope signal, by its frequency. For example, if there are two pole pairs, two cycles of envelope makes one rotation.

Speed = [Frequency(envelope signal)/pole pairs] Hz



**Note:** Resolver is supported on IMDA Mechanical measurements only.

## Torque measurement algorithm

The motor torque is a rotary force produced on its output shaft. It is a twisting force measured in Newton-meters (Nm), Foot-pounds (1 foot-lb = 1.3558 Nm), etc. IMDA supports two torque measurement methods.

### Sensor method

This is the most common torque measurement method using torque sensor or load cell output. Measuring torque generated by motors can be done by coupling a rotary torque sensor in line with the motor shaft. You can capture Torque waveform using the passive voltage probe. The voltage waveform will be proportional to a measured torque value.

Refer [Connection setup for Torque measurement using Sensor method](#). You must configure high and low values of the Torque sensor and corresponding high and low values of the output voltage. The measurement will rescale the acquired voltage waveform to Torque values.

The load cell basically provides the force. Torque is computed as product of force and arm length (distance) to convert the measured force to torque.

$$\text{Torque Output} = \text{Voltage Input} \times \frac{\text{High Torque} - \text{Low Torque}}{\text{High Voltage} - \text{Low Voltage}}$$

### Current method

Many motors have the data specification by which torque can be inferred as proportional to applied RMS current by using Torque constant. This is an estimation of the torque value.

Refer [Connection setup for Torque measurement using Current method](#).

Generally, the torque developed in any DC motor is proportional to torque constant times the armature current. In series motor, field current is proportional to the armature current.

The torque produced by the rotor is estimated to be directly proportional to the current in the armature current. You must configure the Torque constant of the motor.

$$\text{Torque} = \text{Torque constant} * I_{rms}$$

## Mechanical Power algorithm

IMDA supports different sensor types to measure torque, speed, and angular position of the motor. Mechanical power generated at the output of a motor is computed as the product of measured speed and torque values.

$$\text{Mechanical Power} = (\text{Torque} * \text{Multiplier}) * \text{Speed}$$

Where Multiplier can be

104.7252 nm, 0.739522 oz-inch, 141.9883 ft-lb, or 11.83235897 inch-lb

Multiplier is based on the torque unit.

Speed is in RPM.

Mechanical Power is in Watt.

---

## System Efficiency algorithm

System efficiency is the total efficiency of the motor drive system. It is also known as electro-mechanical efficiency. It shows how much electrical energy is converted to mechanical energy. System efficiency is measured as the ratio of mechanical power to three phase output electrical power.

System Efficiency = Mechanical Power / Electrical Power

## DDR Amplitude Measurement algorithms

### AOS (DDR)

AOS is the total area of the signal above specified reference level.

### AOS Per tCK (DDR)

AOS Per tCK is the total area of the signal that crosses the specified reference level, calculated over consecutive periods. It is applicable to clock and address/command waveforms.

### AOS Per UI (DDR)

AOS Per UI is the total area of the signal that crosses specified reference level, calculated over consecutive unit intervals. It is applicable to data and data strobe waveforms.

### AUS (DDR)

AUS is the total area of the signal below specified reference level.

### AUS Per tCK (DDR)

AUS Per tCK is the total area of the signal that crosses the specified reference level, calculated over consecutive periods. It is applicable to clock and address/command waveforms.

### AUS Per UI (DDR)

AUS Per UI is the total area of the signal that crosses specified reference level, calculated over consecutive unit intervals. It is applicable to data and data strobe waveforms.

### Vix(ac) (DDR)

Vix(ac) is the differential input cross-point voltage measured from the actual crossover voltage and its complement signal to a specified reference voltage. This is measured on the single ended signal.

## DDR Time Measurement algorithms

### tRPRE (DDR)

tRPRE is the width of the Read burst preamble. This is measured from the exit of tristate to the first driving edge of the differential strobe.

### tWPRE (DDR)

tWPRE is the width of Write burst preamble. It is measured from the exit of tristate to the first driving edge of the differential strobe.



## tPST (DDR)

tPST is the width of Read or Write burst postamble. It is measured from the last falling edge crossing mid reference level to the start of an undriven state (judged by a rising trend as per JEDEC specification).

## Hold Diff (DDR)

Hold Diff is the elapsed time between the designated edge of the single ended waveform and the designated edge of a differential waveform. The closest single-ended waveform edge to the differential waveform edge that falls within the range limits is used for the measurement.

## Setup Diff (DDR)

Setup Diff is the elapsed time between the designated edge of a single ended waveform and when the differential waveform crosses its own voltage reference level. The closest single ended waveform edge to the differential waveform edge that falls within the range limits is used for the measurement.

## tCK(avg) (DDR)

tCK(avg) is the average clock period across a sliding 200-cycle window.

$$tCK(avg) = \left[ \sum_{j=1}^N tCK_j \right] / N$$

Where,

N=200 (configurable)

## tCH(avg) (DDR)

tCH(avg) is the average high pulse width calculated across a sliding 200 cycle window of consecutive high pulses.

$$tCH(avg) = \left[ \sum_{j=1}^N tCH_j \right] / (N * tCK(avg))$$

Where,

N=200 (configurable)

## tCL(avg) (DDR)

tCL(avg) is the average low pulse width calculated across a sliding 200 cycle window of consecutive low pulses.

$$tCL(avg) = \left[ \sum_{j=1}^N tCL_j \right] / (N * tCK(avg))$$

Where,

N=200 (configurable)

### **tCH(abs) (DDR)**

tCH(abs) is the high pulse width of the differential clock signal. It is the time duration, the waveform remains above the mid reference voltage level.

$$tCH(abs) = tCH / tCK(avg)$$

### **tCL(abs) (DDR)**

tCL(abs) is the low pulse width of the differential clock signal. It is the amount of time the waveform remains below the mid reference voltage level.

$$tCL(abs) = tCL / tCK(avg)$$

### **tJIT(duty) (DDR)**

tJIT(duty) is the largest elapsed time between tCH from tCH(avg) or tCL from tCL(avg) for a 200-cycle window.

$$tJIT(duty) = \text{Min/max of } \{tJIT(CH), tJIT(CL)\}$$

Where,

$$tJIT(CH) = \{tCH_i - tCH(avg)\}$$

$$tJIT(CL) = \{tCL_i - tCL(avg)\}$$

i = 1 to N

N=200 (configurable)

### **tJIT(per) (DDR)**

tJIT(per) is the largest elapsed time between the tCK from tCK(avg) for a 200-cycle sliding window.

$$tJIT(per) = \text{Min/Max of } \{tCK_i - tCK_{(avg)}\}$$

Where,

$i = 1$  to  $N$

$N = 200$  (configurable)

### **tJIT(cc) (DDR)**

tJIT(cc) is the absolute difference in clock period between two consecutive clock cycles.

$$tJIT(cc) = \text{Max of } |tCK_{i+1} - tCK_i|$$

### **tERR(n) (DDR)**

tERR(n) is the cumulative error across multiple consecutive cycles from tCK(avg). It measures time difference between the sum of clock period for a 200-cycle window to n times tCK(avg).

$$tERR(nper) = \left( \sum_{j=1}^{i+n-1} tCK_j \right) - n * tCK(avg)$$

Where,

$n = 2$  for tERR(2 per)

$n = 3$  for tERR(3 per) and so on.

### **tERR(m-n) (DDR)**

tERR(m-n)

tERR(m-n) is the cumulative error across multiple consecutive predefined cycles from tCK(avg). This is measured similar to tERR(n per).

$$tERR(nper) = \left( \sum_{j=1}^{i+n-1} tCK_j \right) - n * tCK(avg)$$

Where,

$6 \leq n \leq 10$  for tERR (6-10 per)

$11 \leq n \leq 50$  for tERR (11-50 per)

### **tDQSCK (DDR)**

tDQSCK is the strobe output access time from differential clock. tDQSCK is measured between the rising edge of clock before or after the differential strobe Read preamble time. The edge locations are determined by the mid-reference voltage levels.

## **tCKSRE**

tCKSRE is the valid clock cycles required after Self Refresh Entry (SRE) command. Changing the input clock frequency or the supply voltage is permissible only after tCKSRE time when the SRE command is registered.

## **tCKSRX**

tCKSRX is the valid clock cycles required before the Self Refresh Exit (SRX) command. Changing the input clock frequency or the supply voltage is permissible provided the new clock frequency or supply voltage is stable for the tCKSRX time prior to SRX command.

## **tCMD-CMD**

tCMD-CMD is the elapsed time between two logic states.

# **DPM Power sequence analysis algorithm**

## **Overshoot**

Overshoot is the difference between signal Maximum and a user-configured Reference voltage. This measurement can be made across the entire record or on each cycle in the record. For a cycle measurement, the user can specify to use the CLK source as an edge qualifier.

## **Undershoot**

Undershoot is the difference between signal Minimum and a user-configured Reference voltage. This measurement can be made across the entire record or on each cycle in the record. For a cycle measurement, the user can specify to use the CLK source as an edge qualifier.

## **DC Rail Voltage**

DC Rail Voltage is the mean value of each rail output. This can be performed per cycle or for the entire record. In cycle mode, the user can specify Edge qualifier as the source to find edges. Annotation and navigation available in cycle mode. One can traverse in navigation mode using Prev and Next buttons.

## **Turn on Overshoot**

Turn on Overshoot computes the maximum amplitude value of the dc rail output voltage during turn ON of the DUT. This supports multiple rail outputs. User has to provide input signal level to trigger properly and measurement happens on output rail. Annotation of max value on the output is shown as cross hair per rail output.

# **DPM Ripple analysis measurement**

## **Ripple**

Ripple computes the DC rail output by setting up the horizontal and vertical parameters for the power rail probe. The power rail autoset sets the horizontal and vertical parameters for the power rail probe. Ripple computes peak-to-peak and RMS values and the RMS is computed at configured ripple frequency. You can also select Record or Cycle mode. Select Cycle mode to specify the clock edges.

## DPM Transient analysis measurement algorithm

### Turn on time

Turn On Time measures the time delay between load current going high to other rail outputs going high when power on happens. Annotation will happen on input and corresponding output waveforms.

### Turn off time

Turn Off Time measures the time delay between current going low to other rail outputs going low when power down happens.

## DPM Power Integrity - Signal Integrity Analysis Algorithm

### Power Supply Induced Jitter

PSIJ measurement correlates the PJ component in High Speed Signals (HSS) with Power Supply output waveform and suppress jitter in high speed signals (victim) induced from power rail signals (aggressor). Jitter suppression filters out the specified frequencies from the victim signal.

Internally, the TIE spectra signals are compared and the correlated frequencies which are induced from the aggressor are figured out. With the help of notch filter, the frequency is removed. The FFT of the victim before and after filtering are plotted which helps in correlating the impact of filtering. The measurement gives out essential results such as eye height, eye width, PJ, and TIE before and after filtering.

Below image shows multi-rail and multi-lane example of effect of noise with various Point of Loads (POL) such as DDR memory, PCIe, etc that depends on the target application.

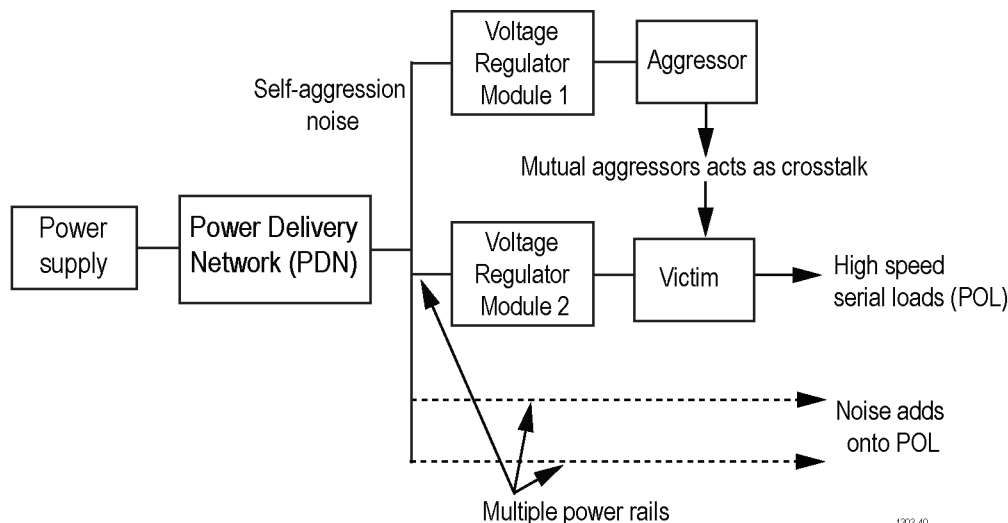

Figure 36: Multi-rail example with different HSS loads (point of loads)



**Note:** You can configure only one power rail (Aggressor) source.

## WBG-DPT measurements algorithm

### Double Pulse Test (DPT)

Double Pulse Test is a method to measure switching characteristics of MOSFET, IGBT, and Diode. MOSFET includes Silicon (Si), Silicon Carbide (SiC), and Gallium Nitride (GaN) power devices.

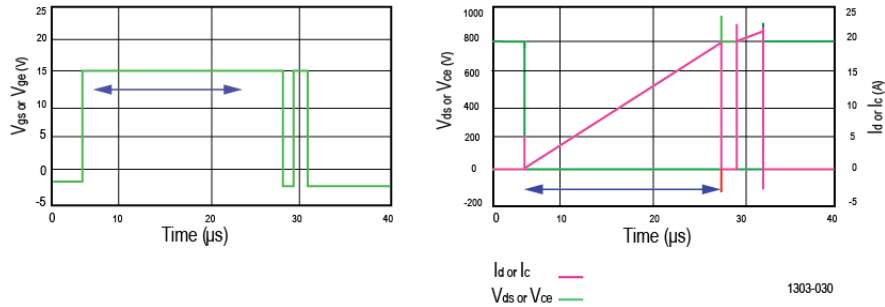

Figure 37: Double pulse waveform

In a DPT, the DUT is switched twice to capture the waveforms for turn on and turn off transitions. The above figure shows a typical DPT waveform used for inductive load switching.

### WBG Auto Level Determination Algorithm

The Automatic Level Determination algorithm is used in Switching Parameter Analysis measurements when **Levels** are set to **Auto**. The algorithm determines signal levels indicated in measurement configure panel. For each turn on/off region of power device, the algorithm internally generates a power waveform and peak power value in the power waveform is determined. The area of search is split into start region and stop region. For example, the area of search could be split into before peak of power (start region) and after peak power (stop region). The start and stop levels are determined within the start and stop region respectively. They are found using Top and Base measurement respectively, which are derived from reference level settings.

For Switching Timing Analysis, Automatic Level Determination algorithm finds the start and stop region. In case the required start level is not found in start region, search region gets expanded to stop region and vice versa.

### WBG-DPT Deskew Algorithm

WBG Deskew calculates the skew between Drain to Source Voltage ( $V_{ds}$ ) and Drain Current ( $I_d$ ) or Collector to Emitter Voltage ( $V_{ce}$ ) and Collector Current ( $I_c$ ) when Power Device is MOSFET or IGBT respectively. The skew value is then applied on to the source to which  $V_{ds}$  or  $V_{ce}$  signal is configured on the oscilloscope.

WBG Deskew differs from conventional oscilloscope Deskew. Conventionally, skew between the probes is computed before starting any measurement on test setup. In WBG-DPT, skew of the measurement system is performed as a post-acquisition of the waveforms.

Follow the procedure to perform WBG Deskew

1. Acquire Double Pulse signal and run **Power Preset** from WBG-DPT Name panel.
2. Ensure that high frequency components of  $V_{ds}$  is acquired by setting 200 MHz band pass filter in channel configuration.
3. Deskew will compute skew value only at turn on transient region.
4. Configure the **Start Level** and **Stop Level** of current waveform from the measurement configuration panel. It is recommended to select **Levels** as **Auto**.
5. Go to Deskew tab and configure circuit parameters depending on the type of probe and DUT.
6. Turn on the power supply. The WBG Deskew performs a double pulse test twice. Tap **Generator Setup** panel for the generator automation during WBG Deskew.

7. Tap **WBG Deskew**, an automated deskew algorithm is executed which will construct a mathematical model of voltage waveform and outputs the waveform to a new math for your visual confirmation. Math and Vds alignment should be verified with same scale and position settings.
8. Algorithm then tries to match the acquired waveform with generated mathematical model and finds the optimum skew value. The measured skew value is set as the channel skew to which Vds is configured.
9. With voltage and current deskewed, measurements can be done on same acquired waveform.

### Configuring Start and Stop Levels

Deskew is performed only at turn on transient region. Drain current ( $I_d$ ) is used as a golden reference waveform for deskew and it is recommended to adjust current start and stop region for better region finding. Algorithm uses the levels as shown below

1. When **Levels** is set to **Auto**, Start Level = 10% - 90% of  $I_d$  and Stop Level = 20% - 80% of  $I_d$ .
2. When **Levels** is set to **Custom** and, Start and Stop should be set based on  $I_d$ , Start Level and Stop Level = User configured levels.
3. When **Levels** is set to **Custom** and, either Start and Stop is set to Vds, Start Level and Stop Level will be same as Auto configuration as shown in step 1.

### Mathematical Model

Two pulses with specific pulse widths and delay time between them are fed to the gate terminal of DUT through an isolated gate driver. At any time during the switching transient, the drain voltage can be mathematically modeled using Kirchhoff Voltage law (KVL).

$$V_{ds\text{low}} + V_{ds\text{high}} + I_d * R_{\text{probe}} + L_{\text{eff}} * \frac{dI_d}{dt} = V_{DD}$$

$R_{\text{probe}}$  is the resistance of probe used for measuring current.  $L_{\text{eff}}$  is the effective inductance as measured at power loop inductance.  $V_{DD}$  is DC bus voltage. During usual operation  $V_{ds\text{low}}$  and  $V_{ds\text{high}}$  are complicated to model mathematically but at turn on/off transition one of these voltages are clamped by body diode, hence it is easy to model mathematically at transition.

### Configuring Effective Inductance ( $L_{\text{eff}}$ ) and Filter Order

While modelling Vds,  $L_{\text{eff}}$  plays key role. If  $L_{\text{eff}}$  is known beforehand, it can be directly configured. In some cases,  $L_{\text{eff}}$  value is not known and hard to find. For each change in effective inductance, Vds is modelled for comparison with acquired Vds. User needs to increase and decrease Effective Inductance value in small steps till mathematical model of Vds gets aligned with actual Vds waveform on scope screen. Easier way to do this is, the effective inductance value is connected to GPIB A knob and scrolling it and clicking WBG Deskew button, one sees the MATH getting updated and observe for alignment of overlapped waveform of modelled Vds and actual Vds in stacked display as shown below:

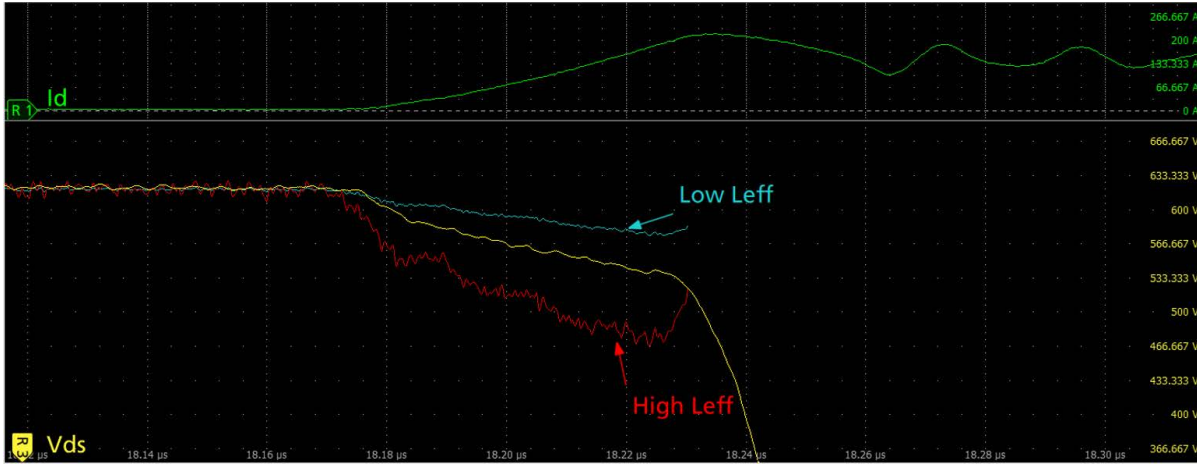

Figure 38:  $V_{ds}$  modelled using low  $L_{eff}$ (blue) and high  $L_{eff}$ (red) to match zero skew acquired  $V_{ds}$ (yellow) during turn on transient

Order of differential filter is crucial to find rate of current change accurately for modelling the voltage drop across inductor. If order of filter is too small, high frequency components are introduced to modeled  $V_{ds}$  waveform. As order increases, high frequency components are smoothed leading to better modelling of waveform. If the filter order is large, the transient nature of modeled waveform will be obscured. A good filter order is between 3 – 20. Effects of filter order is shown in figures below:

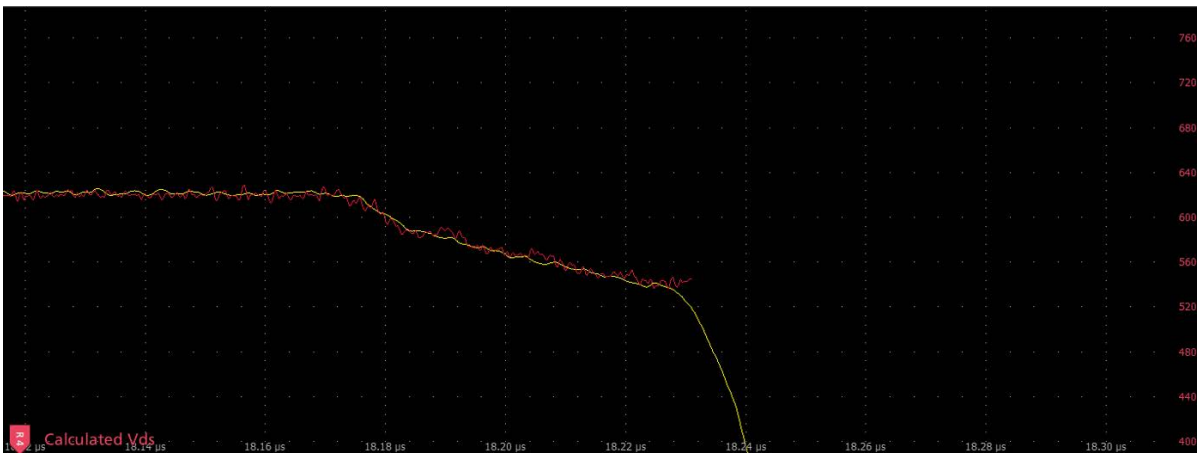

Figure 39:  $V_{ds}$  modeled using perfectly differential order of filter at turn on transient

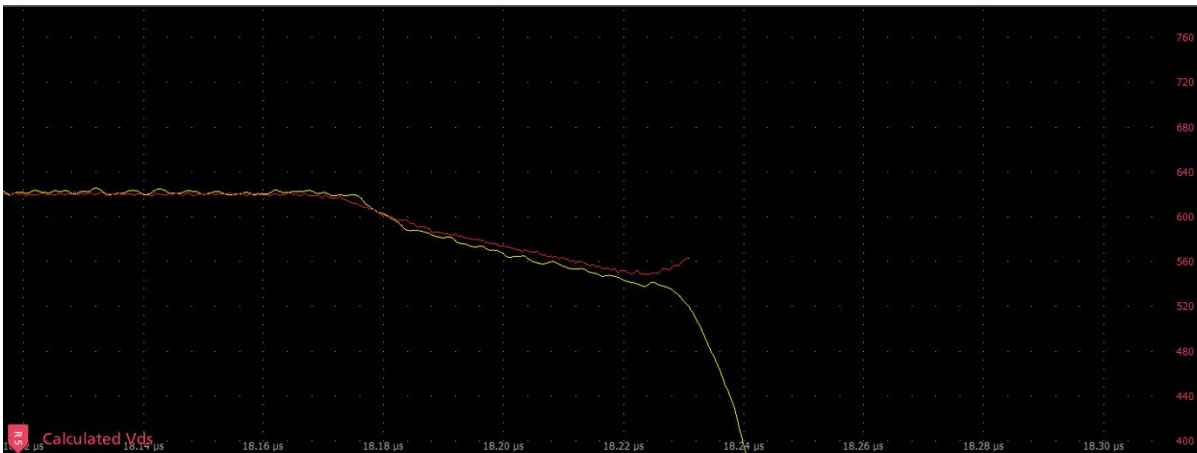

Figure 40: Flat model of  $V_{ds}$  with large differential order filter at turn on transient



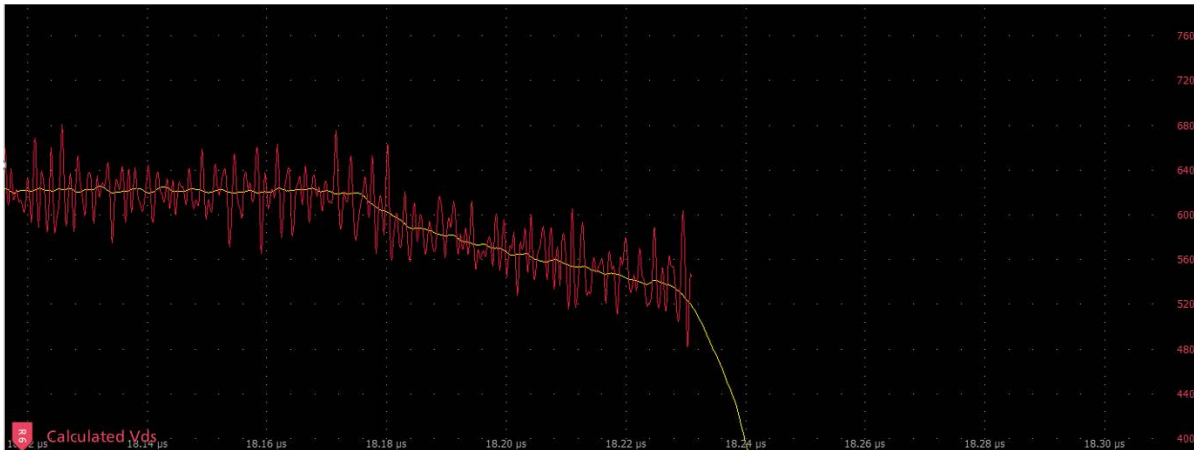

Figure 41: Noisy model of  $V_{ds}$  using small differential order filter at turn on transient

## Switching Parameter Analysis Algorithms

### Eon

Turn on energy for a MOSFET, is measured as the integral of a power waveform computed from 10% of  $I_d$  to 10% of  $V_{ds}$  during turn on condition or specified levels.

Turn on energy for an IGBT, is measured as the integral of a power waveform computed from 10% of  $V_{ge}$  to 2% of  $V_{ce}$  during turn on condition or specified levels.

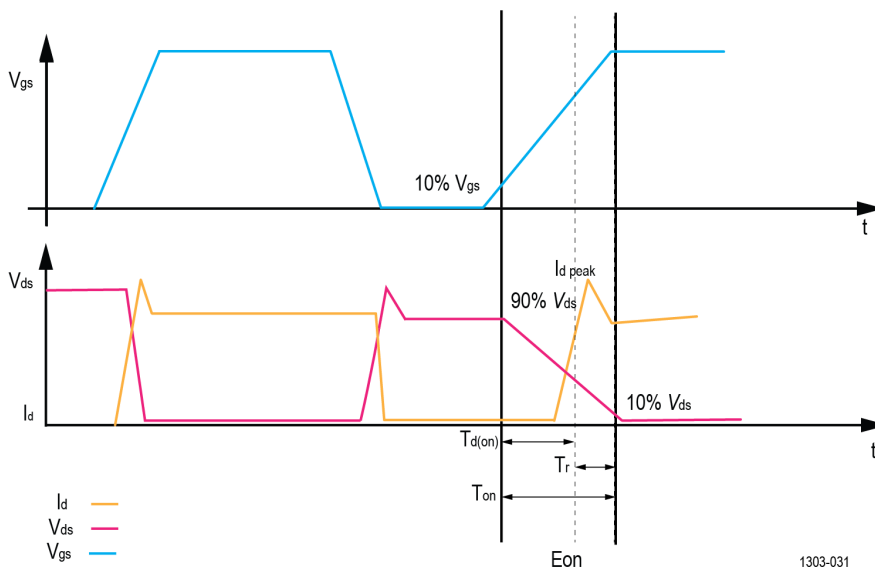

Figure 42: Waveform during turn on time

### Eoff

Turn off energy for a MOSFET, is measured as the integral of power waveform computed between 10% of  $V_{ds}$  and 10% of  $I_d$  during turn off condition or specified levels.

Turn off energy for an IGBT, is measured as the integral of a power waveform computed from 90% of  $V_{ge}$  to 2% of  $I_c$  during turn off condition or specified levels.

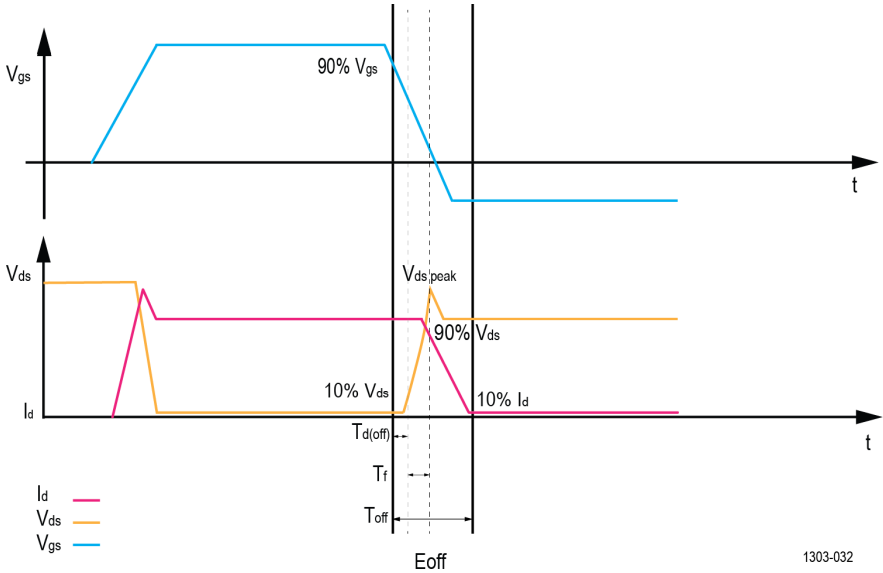

Figure 43: Waveform during turn off time

### Vpeak

Voltage peak is the maximum voltage peak value in the power device during turn off condition of collector current or drain current pulse. Usually, the voltage peak is measured in Eoff region.

### Ipeak

Current peak is the maximum current peak value in the power device during turn on condition of a collector current or drain current pulse. Usually, the current peak is measured in Eon region.

## Switching Timing Analysis Algorithms

### Td(on)

Turn on delay time for a MOSFET is the time interval between 10% of increasing Vgs to 90% of decreasing Vds during turn on condition or specified levels.

Turn on delay time for an IGBT is the time interval between 10% of increasing Vge to 10% of increasing Ic during turn on condition or specified levels.

### Td(off)

Turn off delay time for a MOSFET is the time interval between 90% of the decreasing Vgs to 90% of increasing Vds during turn off condition or specified levels.

Turn off delay time for an IGBT is the time interval between 90% of the decreasing Vge to 90% of decreasing Ic during turn off condition or specified levels.

### Tr

Rise time for a MOSFET is the time interval between 90% and 10% of the Vds during turn on condition or specified levels.

Rise time for an IGBT is the time interval between 10% and 90% of the Ic during turn on condition or specified levels.

## Tf

Fall time for a MOSFET is the time interval between 10% and 90% of the  $V_{ds}$  during turn off condition or specified levels.

Fall time for an IGBT is the time interval between 90% and 10% of the  $I_c$  during turn off condition or specified levels.

## Ton

Turn on time is the sum of the turn on delay time and the rise time. It is the time interval between the beginning of a voltage pulse across the input terminals which switches the power device from off state to the on state.

## Toff

Turn off time is the sum of the turn off delay time and the fall time. It is the time interval between the fall of a voltage pulse across the input terminals which switches the power device from on state to the off state.

## d/dt

Switching  $d/dt$  measures the rate of change of the voltage or current (slew rate), as it rises from the base reference level to the top reference level or as it falls from the top reference level to the base reference level.

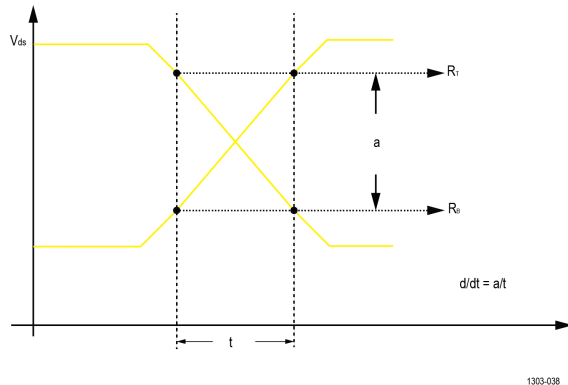

## Reverse Recovery Analysis Algorithms

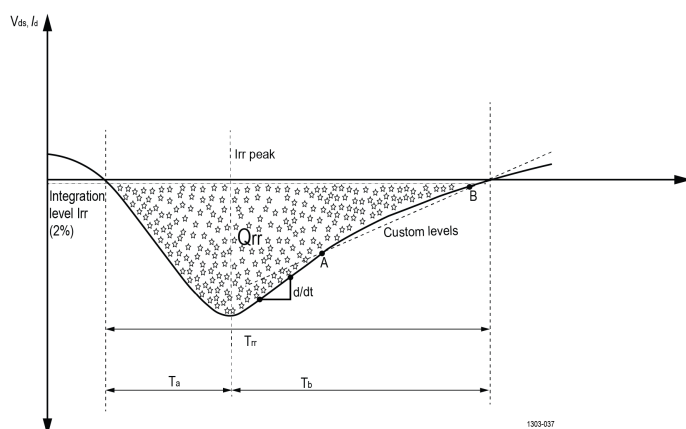

## Trr

Reverse recovery time ( $T_{rr}$ ) is time interval between the instant when the current passes through zero when changing from the forward direction to the reverse direction and the instant when extrapolated reverse current between A and B points reaches zero.

The  $T_{rr}$  is comprised of two time intervals  $t_a$  and  $t_b$  when rectifiers respond with their own peak reverse recovery current  $I_{rr}$  as shown in above figure. The  $t_a$  begins at the moment forward current has been ramped down and intersects the zero-current axis, and concludes at the rectifier  $I_{rr}$  peak response point.

### Q<sub>rr</sub>

Reverse recovery charge (Q<sub>rr</sub>) is the total charge recovered from the power device during a specified integration time of a single collector current or drain current pulse, when the power device is switched from a specified forward current condition to a specified reverse voltage condition with forward biased gate condition.

The recovered charge is measured as:

$$Q_{rr} = \int_{t_0}^{t_0+t_i} I_{rr} \times dt$$

Where:

$t_0$  is the instant when the current passes through zero.

$t_i$  is the specified integration time, preferably when the current has reached 2% of  $I_{rrm}$ .

### Err

Reverse recovery energy (Err) is the energy dissipated within the power device during a specified integration time of a single collector current or drain current pulse, when the power device is switched from a specified forward current condition to a specified reverse voltage condition with forward biased gate condition.

The switching energy is the result of the integration of the product from the device voltage and current during the integration time  $t_i$ .

$$Err = \int_{t_0}^{t_0+t_i} V_R \times I_{rr} \times dt$$

### I<sub>rrm</sub>

Reverse recovery current (I<sub>rrm</sub>) is the maximum reverse current that occurs during the reverse recovery time interval.

### Diode d/dt

Diode d/dt measures the rate of change of voltage or current (slew rate) during the specified start and stop integration levels. Diode d/dt can be measured during rising or falling edge.

## Capacitance Analysis Algorithm

### Q<sub>oss</sub>

The output charge Q<sub>oss</sub> of Wide Band Gap (WBG) device is the charge that must be supplied to the parasitic output capacitances of a power device during each switching cycle.

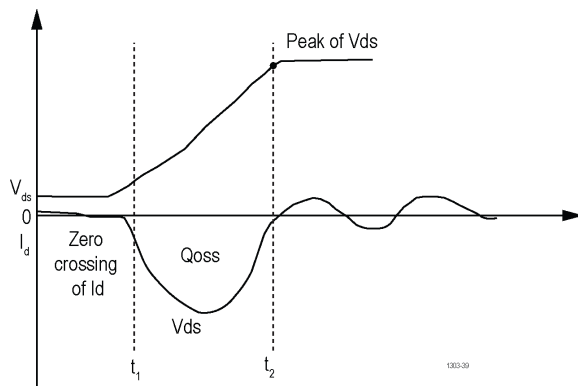

$$Q_{oss} = - \int_{t_1}^{t_2} i_r(t) dt$$

Where

$t_1$  is the instant when the current passes through zero.

$t_2$  is the specified time interval, preferably when Vds has reached 90% of peak voltage.



**Note:** When the edge qualifier is enabled, the gate source is used to find the edges. When it is disabled, Vds or Vce source is used to find the edges and Pulse Region will be set to First Pulse, unlike Multiple Pulse as in all other WBG measurements.

## References

### Power badge error and warning messages

These tables provide information to help resolve error or warning messages that appear on the power measurement badges.

#### Error messages displayed on the power measurement badges

Error Message	Cause	Suggestion
Empty input	The oscilloscope is waiting for a Single Seq trigger.	Check that the oscilloscope has a valid input waveform.
Input source mismatch	Incorrect combination of live (active) and Ref source waveforms.  In the case of two Ref waveforms, the two waveforms recalled must have the same record length and have been acquired with the same timebase setting.	Acquire two waveforms of the same type (active or ref).  Reacquire the Ref waveforms with the same time base and record length.
Too few edges	No edges found on the input waveform as the waveform could be very noisy.	Increase the Hysteresis band and rerun the measurement. The Hysteresis values are set in the measurement configuration menu Reference Levels panel.  Change the Acquisition mode and BW limit to reduce the noise in the waveform.
Error from Frequency measurement	Not able to measure frequency value on the input waveform due to noisy waveform.	Adjust the measurement Hysteresis band to compute edges properly so that frequency can be measured. The Hysteresis values are set in the measurement configuration menu Reference Levels panel.
Error from RMS measurement	Not able to measure RMS value on the input waveform due to noisy waveform.	Adjust the measurement Hysteresis band to compute edges properly so that RMS can be measured. The Hysteresis values are set in the measurement configuration menu Reference Levels panel.
Error from MaxElement measurement	Not able to measure MIN/MAX value on the input waveform due to noisy waveform.	Adjust Hysteresis band to compute edges properly so that MIN/MAX can be measured. The Hysteresis values are set in the measurement configuration menu Reference Levels panel.
Invert probing points	Polarity mismatch between the probe to test points on the DUT.	Check and inverse the probe polarity to match with DUT test points.
Too few edges	The oscilloscope has acquired less than one complete SW cycle.	Increase time base to capture more than one complete cycle. Use <b>Power Autoset</b> to optimize the oscilloscope settings for power measurements.
Insufficient sampling rate	Not enough sampling rate used to capture signal.	Increase the sample rate proportional to input signal frequency. Use <b>Power Autoset</b> to optimize the oscilloscope settings for power measurements.

Table continued...

Error Message	Cause	Suggestion
Too few cycles	Not enough sampling rate used to capture signal.	Increase the sample rate proportional to input signal frequency. Use <b>Power Autose</b> t to optimize the oscilloscope settings for power measurements.
Not enough data	The oscilloscope has acquired less than one complete SW cycle.	Increase time base to capture more than one complete cycle. Use <b>Power Autose</b> t to optimize the oscilloscope settings for power measurements.
Input source mismatch. Current signal expected in current source.	Mismatch between input waveform and wrong source set. For example, if current waveform is used for voltage configuration, this error is shown.	Make sure a Current waveform is set as the input to Current Harmonics measurement.
Input source mismatch. Voltage signal expected in voltage source.	Mismatch between input waveform and wrong source set. For example if voltage waveform is used for current configuration, this error is shown.	Make sure a Voltage waveform is set as the input to Voltage Harmonics measurement.
Invalid input	Incorrect combination of live (active) and Ref source waveforms.  In the case of two Ref waveforms, the two waveforms recalled must have the same record length and have been acquired with the same timebase setting.	Acquire two waveforms of the same type (active or ref).  Reacquire the Ref waveforms with the same time base and record length.
Insufficient horizontal resolution	Not enough sampling rate used to capture signal.	Increase the sample rate proportional to input signal frequency. Use <b>Power Autose</b> t to optimize the oscilloscope settings for power measurements.
Invalid signal frequency	Not able to measure frequency value on the input waveform due to noisy waveform.	Adjust Hysteresis band to compute edges properly so that frequency can be measured. The Hysteresis values are set in the measurement configuration menu Reference Levels panel.
Not enough data	The oscilloscope has acquired less than one complete SW cycle.	Increase time base to capture more than one complete cycle. Use <b>Power Autose</b> t to optimize the oscilloscope settings for power measurements.
Warning from RMS measurement	Not able to measure RMS value on the input waveform due to noisy waveform.	Adjust Hysteresis band to compute edges properly so that RMS can be measured. The Hysteresis values are set in the measurement configuration menu Reference Levels panel.
Too few cycles	The oscilloscope has acquired less than one complete SW cycle.	Increase time base to capture more than one complete cycle. Use <b>Power Autose</b> t to optimize the oscilloscope settings for power measurements.
Not enough data	Table results will not show values.	Check input waveforms and configuration. Recommended to run Power Autose
Too few edges	No of edges found in the gated region is less than the number of edges required for the algorithm for calculation.	Increase the record length.

Table continued...

Error Message	Cause	Suggestion
Pos clipping	Vertical scale is not set properly.	Use <b>Power Autoset</b> to set the vertical scale automatically.
Neg clipping	Vertical scale is not set properly.	Use <b>Power Autoset</b> to set the vertical scale automatically.
Invalid range Indices	No data in the gated region.	Make sure that the input waveforms are valid.
Empty Input	Input waveform has no data.	Make sure to set all the valid inputs.
Input all DC	Input signal is pure DC.	Change the input signal to AC or add some AC component to DC signal.
No data in range	No data in the gated region.	Make sure that the input waveforms are valid.
Unable to connect to generator	Unable to connect to the generator at the specified IP address.	Check the IP address, verify that the generator is powered on, and try to run the measurement again.
No AFG option	AFG option is disabled.	An AFG license is needed.
No Results	Results are not available.	An Internal error has occurred. Results are not available. Check the connections and try again.
Ampl set error	Measurement Runtime Error.	The generator amplitude and impedance values do not match. Restart the measurement.
V/H scale error	Unable to perform vertical or horizontal scaling	Restart the measurement.
Runtime error	Measurement Runtime Error.	Windows OS: Exit the TekScope application and relaunch again. Standard instrument (not Windows OS): Restart the oscilloscope.
Incompatible meas	When any other measurement is added in addition to FRA measurement.	Delete all the measurements other than FRA measurement. There should be only one measurement at a time.
Input Trigger Level is greater than Maximum Input Voltage	Input Trigger Level provided is more than the Maximum Input Voltage in Turn On/ Turn Off measurement.	Adjust the Input Trigger Level such that it is within the range of Maximum Input Voltage waveform.
Not Supported	Selected configurations is not applicable for the IMDA measurement.	Change Input or Output Wiring.
Invalid Wiring	Selected wiring is not applicable for IMDA Efficiency measurement.	Change Input or Output Wiring.
Provide Index Z Pulse	When <b>Index Z</b> box is unchecked in <b>Source Setup</b> panel for IMDA Mechanical measurement.	Measurement requires Index Z pulse to provide output.
Error: Invalid Pole Pairs	This message will display on the measurement badge if pole pairs are a multiple of 3.	Enter a valid number of pole pairs to get results.



## Warning messages displayed on the Power measurement badges

Warning Message	Cause	Suggestion
No data in range	There are no data between the two cursors.	Place the cursors appropriately.
Warning from Frequency measurement	Not able to measure frequency value on the input waveform due to noisy waveform.	Adjust Hysteresis band to compute edges properly so that frequency can be measured. The Hysteresis values are set in the measurement configuration menu Reference Levels panel.
Warning from RMS measurement	Not able to measure RMS value on the input waveform due to noisy waveform.	Adjust Hysteresis band to compute edges properly so that RMS can be measured. The Hysteresis values are set in the measurement configuration menu Reference Levels panel.
Warning from MaxElement measurement	Not able to measure MIN/MAX value on the input waveform due to noisy waveform.	Adjust Hysteresis band to compute edges properly so that MIN/MAX can be measured. The Hysteresis values are set in the measurement configuration menu Reference Levels panel.
Voltage source expected	Mismatch between input waveform and measurement. For example if a current waveform is used for dv/dt, this warning is shown.	Make sure a voltage waveform is set as the voltage source input.
Current source expected	Mismatch between input waveform and measurement. For example if a voltage waveform is used for di/dt, this warning is shown.	Make sure a current waveform is set as the current source input.
Warning from RMS measurement	Not able to measure RMS value on the input waveform due to noisy waveform	Adjust the Hysteresis band to compute edges properly so that RMS can be measured. The Hysteresis values are set in the measurement configuration menu Reference Levels panel.
Invalid Mask	Mask is not of the standard format, cannot have closed mask coordinates or intersection of the coordinate points	Recreate the mask from the SOA mask configure table such that inner mask coordinates do not intersect.
No data in range	No data in the gated region.	Make sure that the input waveforms are valid.
Input > 80% DC	Input signal has higher DC component.	Change the input signal to AC or add more AC component to the DC signal.
Trigger Level is greater than maximum voltage	Trigger level set is greater then the maximum voltage.	Set the maximum voltage higher than the trigger level.
Output Voltage Level reached before input trigger	Output is turned on before the input or there is a spike in the output voltage.	Make sure that the input and output voltage are not interchanged, output is dependent on the input, and run the measurement again.
No PM value	No zero dB crossing on the Gain curve.	Check the test setup connections and try again.
No GM value	No zero degree crossing on the Phase curve.	Check the test setup connections and try again.
Incorrect Input Trigger level	Not able to find the specified Input Trigger Level provided in input source of Turn On/Turn Off measurement .	Adjust the Input Trigger Level such that voltage is within the span of input source waveform of measurement.

Table continued...

Warning Message	Cause	Suggestion
Actual Input Level used in calculation is <n>V	Input Trigger Level provided is over ridden to value<n> by Turn On or Turn Off measurement.	Information about automation of feature of Turn On or Turn Off measurement. Increase the sample rate for better accuracy.
Actual Output<x> Voltage Level used in calculation is <n>V.	Output<x> Voltage Level provided is over ridden to value<n> by Turn On or Turn Off measurement.	Information about automation of feature of Turn On or Turn Off measurement. Increase the sample rate for better accuracy.

### Information messages displayed on the Power measurement badges

Information messages	Description
Actual Input Level used in calculation is n V.	In Turn On Time and Turn Off Time measurements, if the input level is not equal to the maximum of input waveform (n), the maximum of the input waveform is used for computation and the same is displayed as the information message.
Actual Output x Level used in calculation is n V.	In Turn On Time and Turn Off Time measurements, if the output x level is not equal to the maximum output x waveform (x), the maximum of the output x waveform is used for computation and the same is displayed as the information message.

## DPM badge error and warning messages

These tables provide information to help resolve error or warning messages that appear on the DPM measurement badges.

### Error messages displayed on the DPM measurement badges

Error Message	Cause	Suggestion
Empty input	The oscilloscope is waiting for a Single Sequence trigger.	Check that the oscilloscope has a valid input waveform.
Input Trigger Level is greater than Maximum Input Voltage	The specified Input Trigger Level is higher than the Maximum Input Voltage in the DPM Turn On/Turn Off measurement.	Adjust the Input Trigger Level to be within the range of the Maximum Input Voltage waveform.

### Warning messages displayed on the DPM measurement badges

Warning Message	Cause	Suggestion
Incorrect Input Trigger level	Not able to trigger on the specified Input Trigger Level as set in the DPM Turn On/Turn Off measurement.	Adjust the Input Trigger Level to be within the range of the input source waveform.
Output<x> Voltage Level reached before input trigger.	Turn On Time value is negative for the given configuration in the DPM Turn On/Turn Off measurement.	Adjust the Output Voltage Level given for Rail<x> or Adjust the Input Trigger Level for a positive Turn On Time.

Table continued...

Warning Message	Cause	Suggestion
Incorrect Output<x> Voltage level.	Not able to find the specified Output Voltage level for Rail<x> output source as set in the DPM Turn On/Turn Off measurement.	Adjust the Output Voltage Level given for Rail<x> such that voltage is within the span of the Rail<x> source waveform of the measurement.
Not able to correlate configured frequency with HSS PJ component	Configured center frequency cant be correlated between Power Supply and High Speed Signal spectra	Modify center frequency which correlates. Verify from the FFT of High Speed Serial and Power Supply signals

## User defined filter errors and warnings

The following table lists the errors and warning messages for the user defined filters:

### User defined filter errors and warnings

Message	Description
Info: To generate filter response, click on Apply Filter	The Filter response will be blank by default. Run filter to generate the response.
Info: Filter is valid for these sample rates 1 MS/s - 12.5 GS/s	Filter is designed for cutoff frequencies in the range of 0.05 to 0.45 times the Oscilloscope Sample Rate. This message informs the user on the range of valid sample rates for which the filter can be designed.
Error: Odd order is recommended for High-Pass Gaussian filter Error: Odd order is recommended for Band-Stop Gaussian filter	For Gaussian Filters, results are unreliable with the even filter order. So design the filter for Odd order to get a valid filter response.
Error: Filter settings could not be restored	When the loaded filter file is not created using UDF, filter settings cannot be restored and the message indicates that the filter file is not readable.
Error: Invalid SR. Filter is incompatible with the current sample rate	This message will display on the Math badge when there is a mismatch between sample rate configured in Oscilloscope horizontal time base and the sample rates for which filter is designed. To view the filtered signal, set the Oscilloscope sample rate to any of the valid filter sample rates.
Error: Insuf time. Filter requires longer acquisition time	This message will display on the Math badge when the horizontal time base is insufficient. Increase the horizontal scale to view the filtered signal on math.
Error: No valid sample rates for given filter settings	This message will display when the tool couldn't get valid oscilloscope sample rate for the requested cut off frequency/ frequencies. Math Badge displays No Filter applied.
Error: Filter order cannot exceed 15k. Increase the transition width	This message will display on filter creator window when the calculated order is greater than 15k. Increase the transition width to generate a valid response.
Error: Reduce sample rate to get the filter response	This message will display on filter creator window when the number of coefficients go beyond 64000. Reduce the sample rate to generate a valid response.

## WBG-DPT badge error and warning messages

These tables provide information to help resolve error or warning messages that appear on the WBG-DPT measurement badges.

### Error messages displayed on WBG-DPT measurement badges

Error message	Cause	Suggestion
Invalid Pulse Region	Could not find valid pulse region in WBG-DPT measurement	Adjust the start and stop levels
WBG Deskew failed. Change voltage source of WBG Meas <x> to Channel or Reference.	WBG Meas <x> Vds/Vce source type must have been set to Math	Set Vds/Vce source type to Channel or Reference
WBG Deskew failed. Input signals are not connected. Power on the DUT and connect the input signals to configured channels.	Voltage or Current signal on configured channels is empty	Power on the DUT and connect the input signals to configured channels.
Invalid filter order	Differential filter order is set to 0 or twice the samples in input signal	Adjust filter order appropriately
External Generator is Not Connected. Test Connection with valid IP address and re-run.	Could not establish connection with AFG instrument	Make sure the AFG is connected to oscilloscope and re-run test connection
External Generator model is Not Supported. Test Connection with AFG 31k series and re-run.	Connected AFG model is not supported by the WBG-DPT application	Make sure AFG 31000 series instrument is connected and re-run test connection

### Warning messages displayed on the WBG-DPT measurement badges

Warning Message	Cause	Suggestion
No Peak in OFF region	Could not find voltage peak in turn off region	Adjust start and stop levels from measurement configure tab. If you are in Auto mode, go to Custom and set start and stop values. For better precision use Absolute method.
No Peak in ON region	Could not find current peak in turn on region	Adjust start and stop levels from measurement configure tab. If you are in Auto mode, go to Custom and set start and stop values. For better precision use Absolute method.
Adjust start level for pulse <x>	Could not find accurate measurement result at the given pulse number	Adjust start level from measurement configure tab. If you are in Auto mode, go to Custom and set start and stop values. For better precision use Absolute method.
Adjust stop level for pulse <x>	Could not find accurate measurement result at the given pulse number	Adjust stop level from measurement configure tab. If you are in Auto mode, go to Custom and set start and stop values. For better precision use Absolute method.
Adjust start and stop level for pulse <x>	Could not find accurate measurement result at the given pulse number	Adjust start and stop levels from measurement configure tab. If you are in Auto mode, go to Custom and set start and stop values. For better precision use Absolute method.

Table continued...

Warning Message	Cause	Suggestion
Stop level comes before start for pulse <x>	Incorrect measurement start and stop levels	Adjust start and stop levels from measurement configure tab. If you are in Auto mode, go to Custom and set start and stop values. For better precision use Absolute method.
Low Amplitude	Signal amplitude is very low for edge detection	Modify ref high and ref low values from RefLevel tab
Mathematical Model generated. Unable to find skew, modify circuit parameters or hysteresis band	Hysteresis band or some of the circuit parameters is not right for the given input signals	Adjust circuit parameters or hysteresis band to get the right Skew. If not, manually set the skew to match mathematical model.

## Spectrum badge error and warning messages

These tables provide information to help resolve error or warning messages that appear on the Spectrum measurement badges.

### Error messages displayed on Spectrum measurement badges

Error message	Cause	Suggestion
Insufficient Span	If span is not wide enough, then the measurements display an error message in the measurement results badge.	<p>Enter a valid <b>Channel Width</b> in the Channel Power measurement configuration menu.</p> <p>Enter a valid <b>Analysis Bandwidth</b> in the Occupied Bandwidth measurement configuration menu.</p> <p>The bandwidth calculated from adding up the number of channels, the channel width and channel spacing in the ACPR measurement configuration menu.</p>

# Index

## Numerics

1-Wire serial bus menu [297](#)  
250 Kohm termination [497](#)  
8b10b serial bus menu [298](#)

## A

A B Sequence trigger [604](#)  
A event trigger menu [606](#)  
A knob [39](#)  
about the instrument [503](#)  
AC common mode [677](#)  
AC Common mode [235](#)  
AC Common mode measurement [235](#)  
AC Common mode measurement configuration panel [235](#)  
AC line voltage [630](#)  
AC RMS [190](#)  
Acceleration measurement [268](#)  
ACPR [193](#)  
acq trend plot [101](#)  
Acq Trend Plot menu [507](#)  
Acquired waveform [627](#)  
acquiring a signal [85](#)  
Acquisition  
    input channels and digitizers [624](#)  
    sampling [624](#)  
Acquisition concepts [624](#)  
Acquisition controls [39](#)  
Acquisition menu  
    Clear [179](#)  
    Run/Stop [179](#)  
    Single/Seq [179](#)  
acquisition menu, open [88](#)  
acquisition modes [625](#)  
Actions on Failure [221](#)  
Actions panel (Mask Testing) [458](#)  
Active probes [627](#)  
add  
    a bus waveform to the display [296](#)  
    a callout to the screen [114](#)  
    a channel to the display [89](#)  
    a label to a waveform [114](#)  
    a measurement badge [95](#)  
    a measurement plot [99](#)  
    a search badge [107](#)  
    a vertex (mask) [157](#)  
    a vertex (visual trigger) [130](#)  
    DDR measurement plot [286](#)  
    DDR measurements [207](#)  
    filter expression to math equation [465](#)  
    function to math equation [467](#)  
    mask to a screen [157](#)  
    signal to the screen [89](#)  
    statistic readouts to measurement badge [210](#)

add (*continued*)  
    visual trigger area to screen [130](#)  
    waveform to the screen [89](#)  
add a plot [336](#)  
Add Filter (math equation editor) [465](#)  
Add Filter (math waveform) [464](#)  
Add Measurements menu [188](#)  
Add New  
    Bus waveform button [53](#)  
    Math waveform button [53](#)  
    Ref waveform button [53](#)  
add results table menu [337](#)  
Add Variable (math waveform) [464](#)  
Add Variable dialog [466](#)  
adding math waveforms [460](#)  
Adjacent Channel Power Ratio (ACPR) [675](#)  
advanced math waveform [459](#)  
advanced triggering [121](#)  
AFG option [53](#)  
AFG Out (rear panel) [48](#)  
AFG Settings [445](#)  
AFG Sync out [493](#)  
aliasing [646](#)  
Aliasing  
    recognizing [646](#)  
Amplitude Analysis  
    cycle maximum [688](#)  
    cycle minimum [688](#)  
Amplitude Measurement algorithms  
    amplitude [688](#)  
    cycle base [688](#)  
    Cycle Top [688](#)  
amplitude measurements  
    AC RMS [190](#)  
    Amplitude [190](#)  
    Area [190](#)  
    Base [190](#)  
    Maximum [190](#)  
    Mean [190](#)  
    Minimum [190](#)  
    Negative Overshoot [190](#)  
    Peak-To-Peak [190](#)  
    Positive Overshoot [190](#)  
    RMS [190](#)  
    Top [190](#)  
Amplitude measurements [234](#)  
Amplitude Measurements panel [190](#)  
analog channels [439](#)  
Analog view of digital waveform [94](#)  
Angle measurement [269](#)  
annotations [486](#)  
AOS Per tCK measurement (DDR) [207](#)  
AOS Per UI measurement (DDR) [207](#)  
arbitrary/function generator [445](#)  
Area [190](#)

- Area configuration menu (Visual Trigger) [616](#)
- ARINC429 [299](#)
- Audio bus trigger settings [561](#)
- audio serial bus menu [300](#)
- AUS Per tCK measurement (DDR) [207](#)
- AUS per UI measurement (DDR) [207](#)
- Auto Ethernet serial bus menu [301](#)
- Auto Level Determination [714](#)
- Auto Levels algorithm [714](#)
- auto serial bus menu [303](#)
- auto-dim screen [486](#)
- automatic probe compensation (TPP series) [73](#)
- Autoset [85](#)
- Autoset button [39](#)
- Autoset, disable/enable [486](#)
- AUX Out [493](#)
- AUX Out (rear panel) [48](#)
- AUX trigger [129](#)
- Average
  - acquisition mode [179](#)
- average trace (spectrum view) [551](#)

## B

- B knob [39](#)
- B trigger event menu [607](#)
- B-H curve plot [104](#)
- backlight [486](#)
- badge groups
  - badge group caveats [65](#)
  - badge group characteristics [65](#)
  - how to create a group [65](#)
- badge types [55](#)
- badges [55](#), [103](#), [151](#)
- bar graph [102](#), [106](#)
- bar graph plot menu [521](#)
- Base [190](#)
- Bathtub Plot menu [509](#)
- bench conversion kit (LPD64) [39](#)
- bench conversion kit (MSO58LP) [39](#)
- BH curve plot menu [510](#)
- binary virtual keypad [615](#)
- Bit Amplitude [234](#)
- Bit Amplitude measurement [234](#)
- Bit Amplitude: Configuration panel [234](#)
- Bit High [234](#)
- Bit High measurement [234](#)
- Bit High: Configuration panel [234](#)
- Bit Low [234](#)
- Bit Low measurement [234](#)
- Bit Low: Configuration panel [234](#)
- Blackman-Harris FFT window [525](#)
- Blackman-Harris window
  - defined [647](#)
- browse save as location menu [477](#)
- Burst Width [191](#)
- Bus badge [296](#)
- Bus button [39](#)
- Bus Decode Results table [337](#)

- Bus Decode Table menu [341](#)
- bus inputs, parallel [323](#)
- bus menu, parallel [322](#)
- bus search [347](#)
- bus setup [117](#)
- bus setup menus [296](#)
- Bus trigger
  - defined [633](#)
- bus waveforms [93](#)
- Butterworth filter [220](#)

## C

- cable lock [48](#)
- calculate reference levels [486](#)
- callout [114](#)
- Callout button [51](#)
- Callouts [506](#)
- CAN bus
  - .dbc symbolic search config menu [359](#)
- CAN bus trigger settings [561](#)
- CAN dbc [304](#)
- CAN serial bus menu [303](#)
- capturing screen shots [474](#)
- CC-Jitter [230](#)
- CC-Jitter measurement [230](#)
- CC-Jitter measurement configuration panel [230](#)
- change area height (visual trigger) [132](#)
- change area source (visual trigger) [132](#)
- change area width (visual trigger) [132](#)
- change area's center (visual trigger) [132](#)
- change display settings [108](#)
- change mask definition (mask) [160](#)
- change measurement settings [97](#)
- change password (Opt 4-SEC) [501](#)
- change password (Opt 5-SEC) [501](#)
- change password (Opt 6-SEC) [501](#)
- change security password (Opt 4-SEC) [501](#)
- change security password (Opt 5-SEC) [501](#)
- change security password (Opt 6-SEC) [501](#)
- change segment height (mask) [160](#)
- change segment width (mask) [160](#)
- change segment's center (mask) [160](#)
- change waveform colors [492](#)
- changing Callout font, color, size [506](#)
- changing channel handle font, color, size [506](#)
- changing waveform handle font, color, size [506](#)
- channel badge [55](#)
- channel badge (spectrum view) [151](#)
- channel badge menu [439](#)
- Channel buttons (front panel) [39](#)
- Channel Power [193](#), [674](#)
- channel settings menu [439](#)
- Channel Settings menu
  - Other drawer [444](#)
- Clear [89](#)
- clear acquired waveform data [179](#)
- Clear button [39](#)
- Clipping [627](#)

- clipping message [55](#)
- Clock Edge [214](#)
- clock format (12/24 hr), how to set [71](#)
- Clock Offset [214](#)
- Clock Recovery panel [214](#)
- Clock Recovery- Advanced Settings [217](#)
- common touchscreen UI tasks [68](#)
- compensate passive probes [75](#)
- compensate probes [442](#)
- compensate TPP series probes [73](#)
- configuration menus [66](#)
- configure a measurement [97](#)
- Configure AFG [294](#)
- configure cursors (spectrum view) [551](#)
- Configure panel (DDR) [287](#)
- configure profile [254](#)
- connect a monitor [83](#)
- connect digital signals [116](#)
- connect lock cable [36](#)
- connect to a network [76](#)
- connect to the AFG [254](#)
- connected scope preferences, legalese [491](#)
- connecting probes [37](#)
- Constant Clock [214](#)
- contact Tektronix [26](#)
- Control Loop Response (Bode) [254](#)
- Control Loop Response plot [106](#)
- Control Loop Response plot menu [512](#)
- Control windows
  - vertical acquisition [628](#)
- conversion kit, LPD64 to bench use [39](#)
- conversion kit, MSO58LP to bench use [39](#)
- copy files [480](#)
- Coupling [627](#)
- CPHY serial bus menu [305](#)
- create a mask [157](#)
- create visual trigger [130](#)
- Create Waveform Histogram [163](#)
- Create/edit filter configuration menu [462](#)
- Creating
  - create math waveforms [641](#)
- Cursor measurements [644](#)
- cursor readout (spectrum view) [551](#)
- cursor settings [447](#)
- cursors
  - H Bar [447](#)
  - linked [447](#)
  - split [447](#)
  - V Bar [447](#)
  - V&H Bar [447](#)
  - waveform [447](#)
- Cursors button [39](#)
- Cursors button (touchscreen) [51](#)
- cursors menu [109](#), [111](#)
- cursors menu (spectrum view) [551](#)
- Custom Results table menu [343](#)
- custom waveform colors [492](#)
- customizing measurements [168](#)
- CXPI serial bus menu [306](#)

## D

- Damping [214](#)
- Data Rate [191](#)
- date [449](#)
- dbc (CAN bus) [359](#)
- DC Common mode [235](#)
- DC Common mode measurement [235](#)
- DC Common mode measurement configuration panel [235](#)
- DC offset [645](#)
- DCD [230](#), [679](#)
- DCD measurement [230](#)
- DCD measurement configuration panel [230](#)
- DDJ [229](#), [679](#)
- DDJ measurement [229](#)
- DDJ measurement configuration panel [229](#)
- DDR
  - add plot [286](#)
  - amplitude measurements [207](#)
  - AOS [708](#)
  - AOS Per tCK [708](#)
  - AOS Per tCK measurement [207](#)
  - AOS Per UI [708](#)
  - AOS Per UI measurement [207](#)
  - AUS [708](#)
  - AUS Per tCK [708](#)
  - AUS Per tCK measurement [207](#)
  - AUS Per UI [708](#)
  - AUS per UI measurement [207](#)
  - Configure panel [287](#)
  - Filter/Limit Results panel [288](#)
  - Gating panel [287](#)
  - Hold Diff [709](#)
  - Hold Diff measurement [207](#)
  - measurement configuration [286](#)
  - measurements tab [207](#)
  - Reference Levels panel [287](#)
  - Setup Diff [709](#)
  - Setup Diff measurement [207](#)
  - tCH(abs) [710](#)
  - tCH(abs) measurement [207](#)
  - tCH(avg) [709](#)
  - tCH(avg) measurement [207](#)
  - tCK(avg) [709](#)
  - tCK(avg) measurement [207](#)
  - tCKSRE [712](#)
  - tCKSRE measurement [207](#)
  - tCKSRX measurement [207](#)
  - tCL(abs) [710](#)
  - tCL(abs) measurement [207](#)
  - tCL(avg) [709](#)
  - tCL(avg) measurement [207](#)
  - tCMD-CMD [712](#)
  - tCMD-CMDmeasurement [207](#)
  - tDQSCK [711](#)
  - tDQSCK measurement [207](#)
  - tERR(m-n) [711](#)
  - tERR(m-n) measurement [207](#)
  - tERR(n) [711](#)
  - tERR(n) measurement [207](#)



- DDR (continued)
  - timing measurements [207](#)
  - tJIT(cc) [711](#)
  - tJIT(cc) measurement [207](#)
  - tJIT(duty) [710](#)
  - tJIT(duty) measurement [207](#)
  - tJIT(per) [710](#)
  - tJIT(per) measurement [207](#)
  - tPST [709](#)
  - tPSTmeasurement [207](#)
  - tRPRE [708](#)
  - tRPRE measurement [207](#)
  - ttCKSRX [712](#)
  - tWPRE [708](#)
  - tWPRE measurement [207](#)
  - Vix(ac) [708](#)
- DDR measurement configuration menu [285](#)
- DDR Read & Write search [434](#)
- DDR Read search
  - DDR Input Configure menu [436](#)
  - DQ/DQS Levels Configure menu [436](#)
- DDR Read/Write search
  - DDR Input Configure menu [436](#)
  - DQ/DQS Levels Configure menu [436](#)
- DDR Write search
  - DDR Input Configure menu [436](#)
  - DQ/DQS Levels Configure menu [436](#)
- decimal virtual logic keypad [615](#)
- Default Setup button [39](#)
- define custom colors [492](#)
- define inputs (Setup and Hold trigger) [610](#)
- Define Inputs menu (Logic search) [422](#)
- define inputs, Logic trigger [598](#)
- define parallel bus inputs [323](#)
- definition [634](#)
- Delay [191](#)
- delay measurement [667](#)
- delay trigger [633](#)
- delete a measurement badge [98](#)
- delete files [480](#)
- Demo [502](#)
- Deskew Algorithm [714](#)
- deskew channels [444](#)
- Deskew panel (WBG-DPT measurement configuration menu) [294](#)
- deskew probes [82](#)
- diagnostics [497](#)
- Differential crossover [235](#)
- Differential crossover measurement [235](#)
- Differential Crossover measurement configuration panel [235](#)
- digital acquisition [116](#)
- digital channel configuration [449](#)
- digital voltmeter [451](#)
- Diode d/dt measurement [292](#)
- Direction measurement [269](#)
- disable Autoset [486](#)
- disable Ethernet port (Opt 4-SEC) [499](#)
- disable Ethernet port (Opt 5-SEC) [499](#)
- disable Ethernet port (Opt 6-SEC) [499](#)
- disable firmware updates (Opt 4-SEC) [499](#)
- disable firmware updates (Opt 5-SEC) [499](#)
- disable firmware updates (Opt 6-SEC) [499](#)
- disable LAN port (Opt 4-SEC) [499](#)
- disable LAN port (Opt 5-SEC) [499](#)
- disable LAN port (Opt 6-SEC) [499](#)
- disable USB ports (Opt 4-SEC) [499](#)
- disable USB ports (Opt 5-SEC) [499](#)
- disable USB ports (Opt 6-SEC) [499](#)
- disconnect a network drive [79](#)
- display
  - eye diagram [102](#)
- display a channel [89](#)
- display cursors [109](#)
- display cursors (spectrum view) [551](#)
- display mode [155](#)
- display multi-source cursors [111](#)
- display parameters [155](#)
- display settings [486](#)
- Displayed waveform [627](#)
- DJ [228](#), [679](#)
- DJ δδ [228](#)
- documentation [27](#)
- domain name [493](#)
- DPHY serial bus menu [307](#)
- DPM Measurement Name panel [277](#)
- DQ0 measurement
  - phasor diagram [102](#)
- dragging waveform and measurement badges [64](#)
- draw a mask on the screen [157](#)
- draw visual trigger area on screen [130](#)
- draw-a-box button [165](#)
- Draw-a-Box button (Zoom) [67](#)
- Dual Dirac Deterministic Jitter [679](#)
- dual-dirac random jitter [681](#)
- Duration N-Periods [191](#)
- DVM [451](#)
- DVM option [53](#)
- dynamic range limit marker [53](#)

## E

- e\* Scope HTTP Port [493](#)
- e\*Scope [79](#)
- Edge search menu [419](#)
- Edge trigger menu [556](#)
- edit a segment (mask)
  - change a segment's [160](#)
  - change a segment's height [160](#)
  - change a segment's horizontal center [160](#)
  - change a segment's shape [160](#)
  - change a segment's source [160](#)
  - change a segment's vertical center [160](#)
  - change a segment's width [160](#)
  - flip a segment horizontally [160](#)
  - flip a segment vertically [160](#)
  - rotate a segment [160](#)
- edit an area (visual trigger)
  - change an area's [132](#)
  - change an area's height [132](#)
  - change an area's horizontal center [132](#)

- edit an area (visual trigger) *(continued)*
  - change an area's logic true condition [132](#)
  - change an area's shape [132](#)
  - change an area's source [132](#)
  - change an area's vertical center [132](#)
  - change an area's width [132](#)
  - flip an area horizontally [132](#)
  - flip an area vertically [132](#)
  - rotate an area [132](#)
- edit mask segment
  - add a vertex [157](#)
  - move a vertex [157](#)
  - remove a vertex [157](#)
  - resize [157](#)
  - rotate [157](#)
- edit menu [469](#)
- Edit Vertices panel (Mask Testing) [454](#)
- Edit Vertices panel (Visual Trigger) [616](#)
- edit visual trigger area
  - add a vertex [130](#)
  - move a vertex [130](#)
  - remove a vertex [130](#)
  - resize [130](#)
  - rotate [130](#)
- eject USB devices [480](#)
- electrostatic damage, preventing [69](#)
- elements
  - math waveforms [642](#)
- Enable Acquisition History
  - Acquisition menu [179](#)
- Enable the spectrogram [143](#)
- energy plot [105](#)
- enter password (Opt 4-SEC) [500](#)
- enter password (Opt 5-SEC) [500](#)
- enter password (Opt 6-SEC) [500](#)
- enter security password (Opt 4-SEC) [500](#)
- enter security password (Opt 5-SEC) [500](#)
- enter security password (Opt 6-SEC) [500](#)
- Envelope
  - acquisition mode [179](#)
- Envelope acquisition mode [625](#)
- equation editor (math waveform) [464](#)
- erase memory [498](#)
- erase memory (Opt 4-SEC) [499](#)
- erase memory (Opt 5-SEC) [499](#)
- erase memory (Opt 6-SEC) [499](#)
- erase nonvolatile memory [498](#)
- erase nonvolatile memory (Opt 4-SEC) [499](#)
- erase nonvolatile memory (Opt 5-SEC) [499](#)
- erase nonvolatile memory (Opt 6-SEC) [499](#)
- Err measurement [291](#)
- ESD, preventing [69](#)
- eSPI serial bus menu [308](#)
- EtherCAT serial bus menu [310](#)
- EtherCAT serial bus search menu [371](#)
- Ethernet bus trigger settings [561](#)
- Ethernet port (rear panel) [48](#)
- Ethernet serial bus menu [309](#)
- Ethernet, connect to [76](#)
- eUSB serial bus menu [311](#)

- excursion (spectrum view) [548](#)
- expansion point, waveform [53](#)
- Explicit Clock [214](#)
- export log files [497](#)
- external
  - triggering [129](#)
- external monitor [83](#)
- eye diagram
  - display [102](#)
  - mask testing [103](#)
  - plot [102](#)
- eye diagram plot
  - load mask test file [177](#)
  - recall mask test file [177](#)
- eye diagram plot mask [517](#)
- eye diagram plot menu
  - Settings [513](#)
- Eye Height [231](#)
- Eye Height measurement configuration panel [231](#)
- Eye high [682](#)
- EYe High [234](#)
- Eye High measurement [234](#)
- Eye High: Configuration panel [234](#)
- Eye low [682](#)
- EYe Low [234](#)
- Eye Low measurement [234](#)
- Eye Low: Configuration panel [234](#)
- eye mask test configuration menu [453](#)
- Eye measurements [230](#)
- Eye Width [232](#)
- Eye Width measurement configuration panel [232](#)

## F

- F/2 [228](#)
- F/2 measurement [679](#)
- F/4 [228](#)
- F/4 measurement [680](#)
- F/8 [228](#)
- F/8 measurement [680](#)
- factory calibration [497](#)
- Fail When [221](#)
- Fall slew rate [668](#)
- Fall Time [191](#)
- fall time trigger [126](#)
- Falling Slew Rate [191](#)
- Fast Acq button [39](#)
- Fast Frame acquisition mode [625](#)
- Fast Frame concepts [626](#)
- fast frame panel (acquisition badge) [180](#)
- FastAcq [451](#)
- FastAcq acquisition mode [625](#)
- FastFrames [643](#)
- FFT
  - process [646](#)
- FFT aliasing [646](#)
- FFT math waveforms [104](#), [460](#)
- FFT windows [525](#)
- file menu [469](#)

- file utilities menu [480](#)
- filter
  - high pass [170](#)
  - low pass [170](#)
  - measurement [170](#)
- Filter [652](#)
- filter configuration menu [462](#)
- Filter/Limit Results panel [220](#)
- Filter/Limit Results panel (DDR) [288](#)
- firmware, how to update [72](#)
- fixed graticule mode [486](#)
- Flattop2 window
  - defined [648](#)
- FlexChannel connectors (front panel) [39](#)
- FlexRay bus trigger settings [561](#)
- FlexRay serial bus menu [313](#)
- flip a segment (mask) [160](#)
- flip an area (visual trigger) [132](#)
- font color [506](#)
- Force button [39](#)
- Frequency [191](#)
- front panel
  - Acquisition [39](#)
  - Autoset button [39](#)
  - Aux In [39](#)
  - Aux Trig [39](#)
  - Bus button (front panel) [39](#)
  - Channel buttons (front panel) [39](#)
  - Clear button [39](#)
  - Cursors button [39](#)
  - Default Setup [39](#)
  - description [39](#)
  - Fast Acq button [39](#)
  - FlexChannel connectors [39](#)
  - Force button [39](#)
  - High Res button [39](#)
  - Horizontal [39](#)
  - Level knob [39](#)
  - Math button (front panel) [39](#)
  - Miscellaneous [39](#)
  - Mode button [39](#)
  - multipurpose knobs [39](#)
  - Navigate buttons (front panel) [39](#)
  - Position knob [39](#)
  - Position knob (horizontal) [39](#)
  - probe compensation connectors [39](#)
  - Ref button (front panel) [39](#)
  - Run/Stop button [39](#)
  - Scale knob [39](#)
  - Scale knob (horizontal) [39](#)
  - Single/Seq button [39](#)
  - Slope button [39](#)
  - Touch Off button [39](#)
  - Trigger [39](#)
  - USB ports [39](#)
  - Vertical [39](#)
  - Zoom button (front panel) [39](#)
  - Zoom/Pan knobs (horizontal) [39](#)
- functional test [71](#)

## G

- gating [262, 276](#)
- Gating panel (DDR) [287](#)
- Gaussian FFT window
  - definition [648](#)
- Generator setup for AFG [294](#)
- getting help [26](#)
- GPIB address [493](#)
- GPIB talk/listen address [79](#)
- graticule intensity [108](#)
- graticule intensity, setting [622](#)
- graticule style [108, 156](#)
- graticule style, setting [622](#)
- grouping badges and waveforms [65](#)

## H

- H Bar cursors [447](#)
- Hamming FFT window [525](#)
- Hamming window
  - defined [649](#)
- handles, analog and digital [53](#)
- Hanning FFT window [525](#)
- Hanning window
  - defined [649](#)
- harmonics [646](#)
- Harmonics [199, 203](#)
- Harmonics algorithms
  - harmonics algorithm [685](#)
- Height@BER [232, 683](#)
- Height@BER measurement [232](#)
- Height@BER measurement configuration panel [232](#)
- help menu [469](#)
- Help system [69](#)
- hex virtual keypad [615](#)
- Hi Res
  - acquisition mode [179](#)
- high pass filter [170, 220](#)
- High Res acquisition mode [625](#)
- High Res button [39](#)
- High Time [191](#)
- histogram plot [100](#)
- Histogram plot menu [522](#)
- History configuration menu [183](#)
- History menu [89](#)
- History Timestamp Trend [186](#)
- Hold Diff measurement (DDR) [207](#)
- Hold Time [191](#)
- holdoff, trigger [129](#)
- Horizontal acquisition
  - delay [629](#)
  - position [629, 638](#)
  - reference point [638](#)
  - window [627](#)
- Horizontal controls [39](#)
- horizontal measurement units [486](#)
- horizontal menu, open [86](#)
- horizontal mode [451](#)

- horizontal scale [451](#)
- horizontal settings [451](#)
- host name [493](#)
- how to
  - add a callout to the screen [114](#)
  - add a harmonics results table to the screen [343](#)
  - add a measurement [95](#)
  - add a measurement plot [99](#)
  - add a measurement results table to the screen [338](#)
  - Add bus waveform [93](#)
  - add label to a measurement [212](#), [239](#), [266](#), [278](#)
  - Add math waveform [93](#)
  - Add reference waveform [93](#)
  - add waveform to screen [89](#)
  - change display settings [108](#)
  - change graticule intensity [108](#)
  - change graticule style [108](#)
  - change measurement settings [97](#)
  - change persistence [108](#)
  - change waveform colors [492](#)
  - change waveform intensity [108](#)
  - change waveform interpolation [108](#)
  - compensate TPP series probes [73](#)
  - configure a results table [337](#)
  - connect probes [37](#)
  - connect to network [76](#)
  - connect to PC using USB cable [79](#)
  - Define Mask [256](#)
  - delete a measurement [98](#)
  - delete columns in a results table [337](#)
  - delete individual measurements from a results table [337](#)
  - display a spectrum trace [142](#)
  - display cursors [109](#)
  - display multi-source cursors [111](#)
  - download, install firmware [72](#)
  - enable daylight saving time mode [449](#)
  - load a reference waveform [175](#)
  - load a Session file. [176](#)
  - move columns in a results table [337](#)
  - open acquisition menu [88](#)
  - open horizontal menu [86](#)
  - quickly display waveform (Autoset) [85](#)
  - recall a reference waveform [175](#)
  - recall a Session file. [176](#)
  - recall an instrument setup [176](#)
  - remote access the instrument (from Web) [79](#)
  - run signal path compensation (SPC) [73](#)
  - save a plot image to a file [544](#)
  - save a report to a file [174](#)
  - save a screen image [172](#)
  - save a session [174](#)
  - save a spectrum trace file [172](#)
  - save a waveform file [172](#)
  - save instrument settings [173](#)
  - save plot data to a file [544](#)
  - search on an event [107](#)
  - set acquisition parameters [88](#)
  - set clock format (12/24 hr) [71](#)
  - set custom waveform colors [492](#)
  - set Date/Time badge on, off [71](#)

- how to (*continued*)
  - set fall time trigger [126](#)
  - set GPIB talk/listen address [79](#)
  - set horizontal parameters [86](#)
  - set logic trigger [124](#)
  - set pulse width trigger [121](#)
  - set rise time trigger [126](#)
  - set setup/hold trigger [126](#)
  - set time zone [71](#), [449](#)
  - set timeout trigger [122](#), [123](#)
  - set trigger holdoff [129](#)
  - set trigger parameters [87](#)
  - set window trigger [124](#)
  - use Autoset [85](#)
  - use mouse with the UI [68](#)
- How to
  - change display mode (stacked, Overlay) [108](#)
- How to create Waveform Histogram [163](#)
- How to use Waveform Histogram [164](#)

I

- I vs.  $\int V$  plot [104](#)
- I vs.  $\int V$  plot menu [524](#)
- I/O [493](#)
- I2C bus trigger settings [561](#)
- I2C serial bus menu [314](#)
- I2S [300](#)
- I3C serial bus menu [315](#)
- I3C trigger menu [574](#)
- idata, plot [544](#)
- image, plot [544](#)
- IMDA Autoset [274](#)
- IMDA measurement algorithms
  - efficiency [699](#)
  - harmonics [699](#)
- IMDA Measurement Name panel [263](#)
- IMDA measurements [702](#)
- IMDA Measurements
  - Electrical analysis [203](#)
  - IMDA autoset [274](#)
- IMDA measurements: Hall sensors [702](#)
- IMDI measurement algorithms
  - power quality [698](#)
- Impedance plot menu [524](#)
- Impulse-response testing [651](#)
- inactive channel buttons [53](#)
- inductance [104](#)
- Inductance Curve plot menu [523](#)
- ink saver mode [475](#), [486](#)
- Input
  - resistance [627](#)
  - termination [627](#)
- Input Capacitance algorithms
  - Input Capacitance algorithm [687](#)
- Input channel
  - trigger sources [630](#)
- Inrush Current algorithms
  - Inrush Current algorithm [688](#)

- install license [503](#)
- install option license
  - how to [37](#), [68](#), [71–73](#), [76](#), [79](#), [85–89](#), [93](#), [95](#), [97–99](#), [107–109](#), [111](#), [114](#), [121–124](#), [126](#), [129](#), [142](#), [172–176](#), [212](#), [239](#), [256](#), [266](#), [278](#), [337–339](#), [343](#), [449](#), [492](#), [504](#), [505](#), [544](#)
- installed options [503](#)
- installed probes [503](#)
- instrument settings
  - saving [173](#)
- instrument setup
  - recalling [176](#)
- intensity, graticule [108](#)
- intensity, waveform [108](#)
- interpolation [155](#), [627](#)
- Interpolation [625](#)
- Interpolation mode, setting [622](#)
- Invert channel guidelines [440](#)
- inverted screen color mode [486](#)
- IP address [493](#)
- Irrm measurement [292](#)

## J

- J2 [228](#)
- J9 [228](#)
- Jitter Measurement configuration menu overview [225](#)
- Jitter Measurement Name panel [226](#)
- Jitter measurement: SSC Freq Dev measurement [235](#)
- Jitter measurement: SSC Modulation Rate measurement [236](#)
- jitter measurements
  - Phase Noise [195](#), [196](#)
  - TIE [195](#), [196](#)
- Jitter measurements [227](#)
- jitter separation model [486](#)
- Jitter summary [227](#), [680](#)
- Jitter Summary measurement [227](#)
- Jitter Summary measurements configuration panel [227](#)
- JTF BW [214](#)

## K

- Kaiser-Bessel FFT window
  - defined [650](#)
- key features [22](#)
- keyboard [616](#)
- keyboard, installing [83](#)
- keypad [616](#)
- knob A [39](#)
- knob B [39](#)

## L

- label, measurement [212](#), [239](#), [266](#), [278](#)
- LAN [493](#)
- LAN port (rear panel) [48](#)
- LAN reset [493](#)
- LAN Reset [496](#)
- LAN status [493](#)
- LAN, connect to [76](#)

- Left Justified (LJ) audio bus [300](#)
- Level [632](#)
- Level knob [39](#)
- Level knob LED [39](#)
- license file (option install) [505](#)
- license file (option) [29](#)
- license key uninstall [504](#)
- limits
  - measurement [171](#)
- LIN bus trigger settings [561](#)
- LIN serial bus menu [316](#)
- linked cursors [447](#)
- load
  - waveform [175](#)
- load a mask for an eye diagram plot [517](#)
- load an eye diagram mask file [177](#)
- load option license file [505](#)
- loading
  - files [470](#)
  - mask files [470](#)
  - reference waveforms [470](#)
  - setup files [470](#)
- lock to bench or rack [36](#)
- log files, how to export [497](#)
- logic keypad [615](#)
- Logic search menu [420](#)
- Logic Search- Define Inputs menu [422](#)
- logic trigger [124](#), [595](#)
- Logic trigger input settings [598](#)
- Loop BW [214](#)
- low pas filter [170](#)
- low pass filter [220](#)
- Low time [669](#)
- Low Time [191](#)
- LPD64 bench conversion kit [39](#)
- LXI [79](#)

## M

- MAC address [493](#)
- Magnetic property
  - B-H curve [104](#)
- Manchester serial bus menu [317](#)
- manuals [27](#)
- markers (spectrum view) [143](#)
- markers (spectrum view) [150](#)
- marking waveform events (search) [107](#)
- mask
  - change a segment's height [160](#)
  - change a segment's horizontal center [160](#)
  - change a segment's shape [160](#)
  - change a segment's vertical center [160](#)
  - change a segment's width [160](#)
  - change the mask definition [160](#)
  - flip a segment horizontally [160](#)
  - flip a segment vertically [160](#)
  - rotate a segment [160](#)
- mask badge configuration menu [453](#)
- mask hits badge [103](#)

- Mask Test configuration menu (Mask Testing) [458](#)
- mask testing
  - create a mask [157](#)
- Mask Testing
  - Actions To Take On [458](#)
  - badge settings [458](#)
  - Edit Vertices panel [454](#)
  - Mask Test configuration menu [458](#)
  - Segment configuration menu [454](#)
  - segment settings panel [454](#)
- mask testing (eye diagram) [103](#)
- Math button [39](#)
- math editor [644](#)
- Math equation [641](#)
- math syntax [644](#)
- Math waveform
  - differentiation [644](#)
  - elements [642](#)
  - guidelines [643](#)
  - interactions [641](#)
  - offset [645](#)
  - position [645](#)
  - scale [645](#)
  - sources [643](#)
- math waveform equation editor [464](#)
- math waveform menu [459](#)
- math waveforms
  - FFT [104](#)
- max hold trace (spectrum view) [551](#)
- Maximum [190](#)
- Maximum signal level [627](#)
- MDIO serial bus menu [318](#)
- Mean [190](#)
- Measure button [51](#)
- measurement
  - adding a label [168](#)
  - AOS (DDR) [207](#)
  - AOS Per UI (DDR) [207](#)
  - AUS (DDR) [207](#)
  - AUS Per tCK (DDR) [207](#)
  - AUS per UI (DDR) [207](#)
  - customizing [168](#)
  - Hold Diff (DDR) [207](#)
  - plots [99](#)
  - reference levels [168](#)
  - Setup Diff (DDR) [207](#)
  - tCH(abs) (DDR) [207](#)
  - tCH(avg) (DDR) [207](#)
  - tCK(avg) (DDR) [207](#)
  - tCKSRE (DDR) [207](#)
  - tCKSRX (DDR) [207](#)
  - tCL(abs) (DDR) [207](#)
  - tCL(avg) (DDR) [207](#)
  - tCMD-CMD (DDR) [207](#)
  - tDQCK (DDR) [207](#)
  - tERR(m-n) (DDR) [207](#)
  - tERR(n) (DDR) [207](#)
  - tJIT(cc) (DDR) [207](#)
  - tJIT(duty) (DDR) [207](#)
  - tJIT(per) (DDR) [207](#)
- measurement (*continued*)
  - tPST(DDR) [207](#)
  - tRPRE (DDR) [207](#)
  - tWPRE (DDR) [207](#)
  - Vix(ac) (DDR) [207](#)
- Measurement algorithm
  - bit amplitude [678](#)
- Measurement algorithms
  - amplitude [665](#)
  - AOS (DDR) [708](#)
  - AOS Per tCK (DDR) [708](#)
  - AOS Per UI (DDR) [708](#)
  - AUS (DDR) [708](#)
  - AUS Per tCK (DDR) [708](#)
  - AUS Per UI (DDR) [708](#)
  - base [665](#)
  - bit high [678](#)
  - bit low [678](#)
  - burst width [667](#)
  - cycle peak-to-peak [688](#)
  - DC common mode [678](#)
  - differential crossover [678](#)
  - Edge1 [640](#)
  - Edge1Polarity [641](#)
  - Edge2 [640](#)
  - Edge3 [640](#)
  - end [640](#)
  - EndCycle [641](#)
  - frequency [669](#)
  - HighRef [640](#)
  - histogram method [639](#)
  - Hold Diff (DDR) [709](#)
  - hysteresis [640](#)
  - integration algorithm [665](#)
  - LowRef [640](#)
  - maximum [666](#)
  - mean [666](#)
  - MidRef [640](#)
  - min-max method [639](#)
  - minimum [666](#)
  - missing samples [641](#)
  - N-Periods [670](#)
  - negative duty cycle [670](#)
  - negative overshoot [666](#)
  - negative pulse width [671](#)
  - out of range samples [641](#)
  - peak to peak [667](#)
  - period [671](#)
  - phase [671](#)
  - positive duty cycle [671](#)
  - positive overshoot [667](#)
  - positive width [671](#)
  - power quality algorithm [683](#)
  - record length [640](#)
  - rise time [672](#)
  - RMS [667](#)
  - Setup Diff (DDR) [709](#)
  - start [640](#)
  - tCH(abs) (DDR) [710](#)
  - tCH(avg) (DDR) [709](#)

Measurement algorithms (continued)

- tCK(avg) (DDR) [709](#)
- tCKSRE (DDR) [712](#)
- tCKSRX (DDR) [712](#)
- tCL(abs) (DDR) [710](#)
- tCL(avg) (DDR) [709](#)
- tCMD-CMD (DDR) [712](#)
- tDQSCK (DDR) [711](#)
- tERR(m-n) (DDR) [711](#)
- tERR(n) (DDR) [711](#)
- tJIT(cc) (DDR) [711](#)
- tJIT(duty) (DDR) [710](#)
- tJIT(per) (DDR) [710](#)
- top, base [639](#)
- TPOS [641](#)
- tPST (DDR) [709](#)
- tRPRE (DDR) [708](#)
- TSOFF [641](#)
- tWPRE (DDR) [708](#)
- variables [639](#), [668](#)
- Vix(ac) (DDR) [708](#)
- waveform record length [641](#)
- measurement annotations [486](#)
- measurement badge [55](#)
- measurement badge, delete [98](#)
- Measurement configuration menu [210](#)
- measurement filters [170](#)
- measurement gates
  - setting [169](#)
- measurement gating settings [218](#)
- measurement interpolation mode [486](#)
- measurement label [212](#), [239](#), [266](#), [278](#)
- measurement limits [171](#)
- Measurement Name panel [211](#)
- Measurement Results table [337](#)
- Measurement Results table menu [338](#)
- measurement units, horizontal [486](#)
- measurements
  - AC RMS [190](#)
  - Amplitude [190](#)
  - Base [190](#)
  - Burst Width [191](#)
  - Data Rate [191](#)
  - Delay [191](#)
  - Duration N-Periods [191](#)
  - Fall Time [191](#)
  - Falling Slew Rate [191](#)
  - Frequency [191](#)
  - High Time [191](#)
  - Hold Time [191](#)
  - Low Time [191](#)
  - Maximum [190](#)
  - Mean [190](#)
  - Minimum [190](#)
  - Negative Duty Cycle [191](#)
  - Negative Overshoot [190](#)
  - Negative Pulse Width [191](#)
  - Peak-To-Peak [190](#)
  - Period [191](#)
  - Phase [191](#)

measurements (continued)

- Phase Noise [195](#), [196](#)
- Positive Duty Cycle [191](#)
- Positive Overshoot [190](#)
- Positive Pulse Width [191](#)
- Rise Time [191](#)
- Rising Slew Rate [191](#)
- RMS [190](#)
- Setup Time [191](#)
- Skew [191](#)
- TIE [195](#), [196](#)
- Time Outside Level [191](#)
- Top [190](#)
- Unit Interval [191](#)
- Mechanical analysis [203](#)
- memory erase [498](#)
- menu
  - Add Measurements menu [188](#)
  - DDR measurement configuration [285](#)
  - math configuration [460](#)
  - Reference waveform [545](#)
- Menu bar [51](#)
- menu panels [66](#)
- menus [66](#)
- MIL-STD-1553 bus trigger settings [561](#)
- min hold trace (spectrum view) [551](#)
- Minimum [190](#)
- Miscellaneous controls [39](#)
- Mode button (front panel) [39](#)
- monitor, connecting [83](#)
- More button [51](#)
- Motor analysis [263](#)
- mount a network drive (standard instrument) [76](#)
- mount a network drive (Windows OS instrument) [77](#)
- mount a TekDrive [78](#)
- mount drive menu [484](#)
- mouse touchscreen UI equivalents [68](#)
- mouse, installing [83](#)
- movable graticule mode [486](#)
- move a vertex (mask) [157](#)
- move a vertex (visual trigger) [130](#)
- move cursors [109](#)
- move multi-source cursors [111](#)
- moving badges [64](#)
- MSO58LP bench conversion kit [39](#)
- multipurpose knobs [39](#)

**N**

- Navigate buttons (horizontal) [39](#)
- navigation buttons, badges [55](#)
- Negative Duty Cycle [191](#)
- Negative Overshoot [190](#)
- Negative Pulse Width [191](#)
- network address [493](#)
- network drive (standard instrument)
  - mount a network drive [76](#)
  - unmount a network drive [78](#)
- network drive (Windows 10 instrument)



- network drive (Windows 10 instrument (*continued*)
  - unmount a network drive [79](#)
- network drive (Windows OS instrument
  - mount a network drive [77](#)
- network, connect to [76](#)
- NFC serial bus menu [320](#)
- NFC serial bus search menu [398](#)
- nonvolatile memory erase [498](#)
- Normal screen color mode [486](#)
- normal trace (spectrum view) [551](#)
- NPJ [228](#)
- NPJ measurement [680](#)
- NRZ serial bus menu [321](#)
- numeric keypad [616](#)
- Nyquist point [646](#)

## O

- Occupied Bandwidth [676](#)
- octal virtual keypad [615](#)
- Offset
  - math offset and position [645](#)
- on screen keyboard [616](#)
- open acquisition menu [88](#)
- open horizontal menu [86](#)
- opening files [470](#)
- option details [503](#)
- option license [503](#)
- option license file, load [505](#)
- option license, uninstall [30](#), [504](#)
- options
  - install an option [29](#)
  - option license file [29](#)
- Other drawer
  - Channel Settings menu [444](#)
- overlay display mode [155](#)
- overlay mode (waveforms) [108](#)
- Overlay mode, setting [622](#)

## P

- Pan [67](#)
- panels, menu [66](#)
- parallel bus
  - trigger [127](#)
- parallel bus inputs [323](#)
- parallel bus menu [322](#)
- parallel bus search [347](#)
- parallel bus trigger settings [561](#)
- Pass/Fail Testing panel [221](#)
- password, change (Opt 4-SEC) [501](#)
- password, change (Opt 5-SEC) [501](#)
- password, change (Opt 6-SEC) [501](#)
- password, enter (Opt 4-SEC) [500](#)
- password, enter (Opt 5-SEC) [500](#)
- password, enter (Opt 6-SEC) [500](#)
- password, set (Opt 4-SEC) [501](#)
- password, set (Opt 5-SEC) [501](#)
- password, set (Opt 6-SEC) [501](#)

- paste files [480](#)
- Peak Detect
  - acquisition mode [179](#)
- Peak Detect acquisition mode [625](#)
- Peak Marker Result table [345](#)
- peak markers (spectrum view) [548](#)
- Peak Markers results table [346](#)
- Peak-To-Peak [190](#)
- Period [191](#)
- persistence [155](#)
- persistence, waveform [108](#)
- Phase [191](#)
- Phase noise [195](#), [196](#), [228](#)
- Phase Noise [533](#)
- Phase noise configuration panel [227](#)
- Phase noise measurement [228](#)
- Phase Noise measurement: Configure panel [228](#)
- phasor diagram [102](#)
- PJ [228](#), [681](#)
- PK-Pk measurement [235](#)
- PLL clock recovery [214](#)
- PLL model [214](#)
- plot
  - BH Curve [104](#)
  - Control Loop Response (Bode) [106](#)
  - I vs.  $\sqrt{V}$  [104](#)
  - Power Supply Rejection Ratio (PSRR) [106](#)
  - PSRR [106](#)
  - safe operating area (SOA) [105](#)
  - SOA [105](#)
  - spectrum [101](#)
  - time trend [101](#)
  - Trajectory [105](#)
  - XY [101](#)
  - XYZ [101](#)
- Plot
  - acq trend [101](#)
  - bar graph [102](#), [106](#)
  - energy [105](#)
  - histogram [100](#)
  - inductance [104](#)
  - phasor diagram [102](#)
  - power [105](#)
- plot a measurement [99](#)
- Plot button [51](#)
- plot data file [544](#)
- plot image file [544](#)
- plot menu
  - Histogram [522](#)
- plot menu, Acq Trend [507](#)
- plot menu, Time Trend [538](#)
- plot menu, Trend [541](#)
- plot view configuration menus [507](#)
- Plot XY menu [542](#)
- plot XYZ menu [543](#)
- plots, adding [336](#)
- Position [645](#)
- Position control [627](#)
- Position knob [39](#)
- Position knob (horizontal) [39](#)



- Positive Duty Cycle [191](#)
- Positive Overshoot [190](#)
- Positive Pulse Width [191](#)
- Power Autoselect [255](#)
- power cord connector (rear panel) [48](#)
- Power Integrity - Signal Integrity Analysis Algorithm [713](#)
- Power measurement algorithms
  - frequency [689](#)
  - negative duty cycle [689](#)
  - negative pulse width [689](#)
  - period [689](#)
  - positive duty cycle [689](#)
  - positive width [689](#)
- Power Measurement Name panel [239](#)
- Power Measurements
  - Input analysis [199](#)
  - power autoselect [255](#)
  - power preset [256](#)
- power plot [105](#)
- Power Preset [256](#)
- Power Quality [199](#), [203](#)
- Power Quality measurement
  - phasor diagram [102](#)
- Power Rail Autoselect [283](#), [284](#)
- Power Rail Preset [284](#)
- Power Sequence Analysis Measurements
  - turn off time [204](#)
  - turn on time [204](#)
- Power Supply Induced Jitter Algorithm [713](#)
- Power Supply Rejection Ratio [254](#)
- Power Supply Rejection Ratio plot [106](#)
- Power Supply Rejection Ratio plot menu [534](#)
- power-on self tests [497](#)
- preventing ESD [69](#)
- probe
  - unsupported [441](#)
- probe compensation [442](#)
- probe compensation (TPP series) [73](#)
- probe compensation connectors [39](#)
- probe inputs [39](#)
- probe setup
  - analog [440](#)
- probes, connecting [37](#)
- product description [22](#)
- projector, connecting [83](#)
- PSI5 serial bus menu [324](#)
- PSIJ measurements [281](#)
- Pulse Width search menu [422](#)
- pulse width trigger [121](#), [598](#)
- Pulse width trigger [634](#)

## Q

- Q-factor [683](#)
- Q-Factor [234](#)
- Q-Factor measurement [234](#)
- Q-Factor: Configuration panel [234](#)
- QOSS measurement [293](#)
- Qrr measurement [291](#)

## R

- rack mount kit information [39](#)
- readout (spectrum view) [548](#)
- rear panel
  - AFG Out [48](#)
  - AUX Out [48](#)
  - cable lock [48](#)
  - Ethernet port (RJ-45) [48](#)
  - LAN port (RJ-45) [48](#)
  - power cord [48](#)
  - security cable lock [48](#)
  - USB Device port [48](#)
  - USB Host ports [48](#)
  - video output [48](#)
- rear panel connections [48](#)
- recall
  - instrument setup [176](#)
  - waveform [175](#)
- recall an eye diagram mask file [177](#)
- recall mask (SOA plot) [258](#)
- recall mask configuration file for eye diagram plot [517](#)
- recall reference file menu [546](#)
- recall spectrum trace file to spectrum view [154](#)
- recalling [172](#)
- record length [451](#)
- Record length [629](#)
- record view, waveform [53](#)
- Rectangular FFT window [525](#)
- Rectangular window
  - defined [650](#)
- redo last action [486](#)
- Ref button [39](#)
- Ref In [48](#)
- Ref In (rear panel) [48](#)
- reference clock out [493](#)
- reference levels
  - measurement [168](#)
- reference levels panel [261](#), [276](#), [282](#)
- Reference Levels panel (DDR) [287](#)
- reference marker (spectrum view) [150](#)
- Reference waveform menu [545](#)
- reference waveforms [93](#)
- remote access (e\*Scope) [79](#)
- remote access (Web-based) [79](#)
- remote access to Windows instrument [80](#)
- remove a vertex (mask) [157](#)
- remove a vertex (visual trigger) [130](#)
- rename files [480](#)
- reports
  - saving [174](#)
- resize a segment (mask) [157](#)
- resize an area (visual trigger) [130](#)
- Resolver [705](#)
- Results bar [51](#)
- results table (bus) [341](#)
- Results Table button [51](#)
- results tables [337](#)
- return license [503](#)
- Right click menu of Waveform Histogram [622](#)

- right click settings [486](#)
- Right Justified (RJ) audio bus [300](#)
- Ripple Analysis Measurements
  - ripple [204](#)
- Rise Time [191](#)
- rise time trigger [126](#)
- Rise/Fall Time search menu [424](#)
- rise/fall time trigger [600](#), [635](#)
- Rising Slew Rate [191](#)
- Rj [681](#)
- RJ [228](#)
- RJ 66 [681](#)
- RJ 55 [228](#)
- RJDIRAC [681](#)
- RMS [190](#)
- Roll Mode
  - acquisition mode [179](#)
- Rollmode acquisition mode [625](#)
- rotate a segment (mask) [157](#), [160](#)
- rotate an area (visual trigger) [130](#), [132](#)
- RS232 bus trigger settings [561](#)
- RS232 serial bus menu [326](#)
- run signal path compensation [73](#)
- Run/Stop
  - Acquisition menu [179](#)
- Run/Stop button [39](#)
- Runt search menu [425](#)
- Runt trigger [634](#)

## S

- safe operating area plot [105](#)
- Sample
  - acquisition mode [179](#)
- Sample acquisition mode [625](#)
- sample interpolation [627](#)
- sample rate [451](#)
- Sampling process
  - defined [624](#)
- save
  - instrument settings [173](#)
  - reports [174](#)
  - screen image [172](#)
  - sessions [174](#)
  - spectrum trace file [172](#)
  - waveform file [172](#)
- save a plot image to a file [544](#)
- Save As dialog [342](#), [474](#)
- Save as menu for Waveform Histogram [621](#)
- save bus decode results table to file [342](#)
- Save button [39](#)
- save files on trigger event [182](#)
- save harmonics results table to file
  - how to [37](#), [68](#), [71–73](#), [76](#), [79](#), [85–89](#), [93](#), [95](#), [97–99](#), [107–109](#), [111](#), [114](#), [121–124](#), [126](#), [129](#), [142](#), [172–176](#), [212](#), [239](#), [256](#), [266](#), [278](#), [337–339](#), [343](#), [449](#), [492](#), [504](#), [505](#), [544](#)
- Save Mask [457](#)
- save mask (SOA plot) [257](#)
- save measurement results table to file
  - how to [37](#), [68](#), [71–73](#), [76](#), [79](#), [85–89](#), [93](#), [95](#), [97–99](#), [107–109](#), [111](#), [114](#), [121–124](#), [126](#), [129](#), [142](#), [172–176](#), [212](#), [239](#), [256](#), [266](#), [278](#), [337–339](#), [343](#), [449](#), [492](#), [504](#), [505](#), [544](#)
- Save menu action [474](#)
- save plot data to a file [544](#)
- save spectrum trace to a file [154](#)
- Save Waveform Histogram [621](#)
- saving [172](#)
- saving ink on printed screen captures [475](#), [486](#)
- scale buttons, badge [55](#)
- Scale controls
  - math [645](#)
  - positioning [627](#)
- Scale knob [39](#)
- Scale knob (horizontal) [39](#)
- screen capture [172](#)
- screen captures, saving [474](#)
- screen color mode [486](#)
- screen dim [486](#)
- screen image
  - saving [172](#)
- screen keyboard [616](#)
- search [347](#)
- search badge [55](#)
- Search button [51](#)
- search menu
  - DDR Read [431](#)
  - DDR Read & Write [434](#)
  - DDR Write [432](#)
  - Edge [419](#)
  - Pulse Width [422](#)
  - Rise/Fall Time [424](#)
  - Runt [425](#)
  - Setup and Hold [426](#)
  - Timeout [428](#)
  - Window [429](#)
- Search menu
  - Logic [420](#)
- search serial bus [347](#)
- search tables and zoom mode [166](#)
- searching for events [107](#)
- security [498](#)
- security (Opt 4-SEC) [499](#)
- security (Opt 5-SEC) [499](#)
- security (Opt 6-SEC) [499](#)
- security cable lock [48](#)
- Segment configuration menu (Mask Testing) [454](#)
- self tests [497](#)
- SENT bus trigger settings [561](#)
- SENT serial bus menu [328](#)
- Sequence trigger menu [604](#)
- sequence trigger- A event [606](#)
- sequence trigger- B event [607](#)
- sequential acquisition mode [179](#)
- sequential triggering [128](#)
- Sequential triggering [635](#)
- serial bus
  - triggering [128](#)
- serial bus configuration [296](#)

- serial bus menu
  - SENT [328](#)
  - SPMI [333](#)
- serial bus search settings [347](#)
- serial bus trigger settings [561](#)
- serial bus, 1-Wire [297](#)
- serial bus, audio [300](#)
- serial bus, auto [303](#)
- serial bus, CPHY [305](#)
- serial bus, CXPI [306](#)
- serial bus, DPHY [307](#)
- serial bus, eSPI [308](#)
- serial bus, EtherCAT [310](#), [371](#)
- serial bus, Ethernet [309](#)
- serial bus, FlexRay [313](#)
- serial bus, I2C [314](#)
- serial bus, I3C [315](#)
- serial bus, LIN [316](#)
- serial bus, MDIO [318](#)
- serial bus, NFC [320](#), [398](#)
- serial bus, PSI5 [324](#)
- serial bus, RS232 [326](#)
- serial bus, SMBus [329](#), [410](#)
- serial bus, SVID [334](#)
- service name [493](#)
- Session file
  - how to load [176](#)
  - how to recall [176](#)
- sessions
  - saving [174](#)
- set
  - clock format (12/24 hr) [71](#)
  - Date/Time badge display on, off [71](#)
  - GPIB talk/listen address [79](#)
  - time zone [71](#)
- set custom waveform colors [492](#)
- set eye mask hits [453](#)
- set measurement gates [169](#)
- set password (Opt 4-SEC) [501](#)
- set password (Opt 5-SEC) [501](#)
- set password (Opt 6-SEC) [501](#)
- set security password (Opt 4-SEC) [501](#)
- set security password (Opt 5-SEC) [501](#)
- set security password (Opt 6-SEC) [501](#)
- set trigger logic qualification inputs [612](#)
- setting up a bus [296](#)
- Settings bar [51](#)
- settings, Edge trigger [556](#)
- settings, Video trigger [558](#)
- setup
  - parallel bus [118](#)
- Setup [673](#)
- Setup and Hold Search - Define Inputs menu [427](#)
- Setup and Hold search menu [426](#)
- Setup and hold trigger [635](#)
- Setup Diff measurement (DDR) [207](#)
- Setup Time [191](#)
- setup/hold trigger [126](#)
- shared reference levels [486](#)
- show a measurement [95](#)
- signal path compensation [497](#)
- single acquisition mode [179](#)
- single sequence [89](#)
- Single Sequence/Stop After
  - Acquisition menu [179](#)
- Single/Seq
  - Acquisition menu [179](#)
- Single/Seq button [39](#)
- Skew [191](#), [673](#)
- Slope
  - trigger [632](#)
- Slope button (front panel) [39](#)
- SMBus serial bus menu [329](#)
- SMBus serial bus search menu [410](#)
- SOA plot
  - recall mask [258](#)
  - save mask [257](#)
- SOA plot menu [535](#)
- Sources
  - math waveforms [643](#)
- SpaceWire serial bus menu [330](#)
- SPC [497](#)
- SPC (signal path compensation) [73](#)
- spectral FastAcq setting [451](#)
- Spectrogram [677](#)
- Spectrum measurement configuration menu overview [222](#)
- Spectrum measurements configuration menu [223](#)
- spectrum plot [101](#)
- Spectrum Plot menu [536](#)
- Spectrum Time [145](#)
- spectrum view
  - automatic markers [150](#)
  - average trace mode [551](#)
  - channel badge [151](#)
  - concepts [138](#)
  - cursor display on-off [551](#)
  - cursor mode [551](#)
  - cursors configuration menu [551](#)
  - display mode [548](#)
  - excursion [548](#)
  - FFT versus Spectrum View [138](#)
  - front panel controls [150](#)
  - graticule intensity [548](#)
  - graticule style [548](#)
  - how to display a spectrum trace [142](#)
  - M, A, N, m traces [143](#)
  - markers [143](#), [150](#)
  - max hold trace mode [551](#)
  - menus [548](#)
  - min hold trace mode [551](#)
  - normal trace mode [551](#)
  - peak markers [548](#)
  - quantity (markers per waveform) [548](#)
  - readout [548](#)
  - recall trace [154](#)
  - reference marker [150](#)
  - save trace to a file [154](#)
  - selected trace configuration menu [551](#)
  - source waveform [551](#)
  - spectrum badge [151](#)

- spectrum view (*continued*)
  - spectrum trace file names [154](#)
  - spectrum view window configuration menu [548](#)
  - threshold [548](#)
  - time-domain vs frequency domain [138](#)
  - trace handle [143](#)
  - trace mode [551](#)
  - user interface [143](#)
  - waveform intensity [548](#)
  - x-axis scale [548](#)
- Spectrum View
  - Spectrum Time Bar [145](#)
- spectrum view panel (channel menu) [442](#)
- Speed measurement [268](#)
- SPI bus trigger settings [561](#)
- SPI serial bus [331](#)
- split cursors [447](#)
- SPMI bus trigger settings [561](#)
- SPMI serial bus menu [333](#)
- SRJ [228](#)
- SSC FREQ DEV [678](#)
- SSC Freq Dev measurement [235](#)
- SSC Modulation Rate measurement [236](#)
- stacked display mode [155](#)
- stacked mode (waveforms) [108](#)
- Stacked mode, setting [622](#)
- statistic readouts on measurement badge [210](#)
- stop acquisitions [179](#)
- subnet mask [493](#)
- Support [26](#)
- SVID serial bus menu [334](#)
- Switching Loss
  - Trajectory [105](#)
- Switching Parameter Configure panel [289](#)
- Switching Parameter measurements [289](#)
- Switching Parameter measurements Configure panel [289](#)
- Switching Timing measurements [289](#)
- Switching Timing measurements Configure panel [289](#)
- symbolic search config menu (CAN bus) [359](#)
- syntax
  - math editor [644](#)
- system information [503](#)

## T

- T/nT [235](#)
- t/nt measurement [235](#)
- T/nT measurement configuration panel [235](#)
- tCH(abs) measurement (DDR) [207](#)
- tCH(avg) measurement (DDR) [207](#)
- tCK(avg) measurement (DDR) [207](#)
- tCL(abs) measurement (DDR) [207](#)
- tCL(avg) measurement (DDR) [207](#)
- TDM audio bus [300](#)
- tDQSCK measurement (DDR) [207](#)
- Technical support [26](#)
- Tek exponential FFT window
  - defined [651](#)
- TekDrive drive (

- TekDrive drive ( (*continued*)
  - unmount a TekDrive [79](#)
- TekExp FFT window [651](#)
- TekSecure [498, 499](#)
- TekSecure memory erase [498](#)
- TEKTRONIX END USER LICENSE AGREEMENT [26](#)
- Tektronix Technical Support [26](#)
- TekVPI input connectors [39](#)
- Termination [627](#)
- tERR(m-n) measurement (DDR) [207](#)
- tERR(n) measurement (DDR) [207](#)
- text [506](#)
- threshold (spectrum view) [548](#)
- TIE [195, 196, 228, 678](#)
- TIE measurement [228](#)
- TIE measurement configuration panel [228](#)
- time [449](#)
- Time measurement [235](#)
- Time outside level [673](#)
- Time Outside Level [191](#)
- Time to Max [674](#)
- Time to Min [674](#)
- time trend plot [101](#)
- Time Trend Plot menu [538](#)
- time zone [449](#)
- time zone, how to set [71](#)
- Timebase Reference Source
  - Acquisition menu [179](#)
- Timeout search menu [428](#)
- timeout trigger [122, 123, 610](#)
- Timeout trigger [634](#)
- Timestamp menu [187](#)
- timing measurements
  - Burst Width [191](#)
  - Data Rate [191](#)
  - Delay [191](#)
  - Duration N-Periods [191](#)
  - Fall Time [191](#)
  - Falling Slew Rate [191](#)
  - Frequency [191](#)
  - High Time [191](#)
  - Hold Time [191](#)
  - Low Time [191](#)
  - Negative Duty Cycle [191](#)
  - Negative Pulse Width [191](#)
  - Period [191](#)
  - Phase [191](#)
  - Positive Duty Cycle [191](#)
  - Positive Pulse Width [191](#)
  - Rise Time [191](#)
  - Rising Slew Rate [191](#)
  - Setup Time [191](#)
  - Skew [191](#)
  - Time Outside Level [191](#)
  - Unit Interval [191](#)
- TJ@BER [227, 681](#)
- TJ@BER measurement [227](#)
- TJ@BER measurements configuration panel [227](#)
- tJIT(cc) measurement (DDR) [207](#)
- tJIT(duty) measurement (DDR) [207](#)

- tJIT(per) measurement (DDR) [207](#)
- Top [190](#)
- Torque measurement algorithm [706](#)
- Torque measurement: Configure panel [270](#)
- Touch Off button [39](#)
- touchscreen UI tasks [68](#)
- tPST measurement (DDR) [207](#)
- Trajectory plot [105](#)
- Trajectory plot menu [539](#)
- Transient Analysis Measurements
  - overshoot [204](#)
  - undershoot [204](#)
- Transient Response menu [540](#)
- Trend Plot menu [541](#)
- trigger
  - external signal [129](#)
  - level indicators [53](#)
  - logic [595](#)
  - parallel bus [127](#)
  - position indicator [53](#)
  - pulse width [598](#)
  - rise/fall time [600](#)
  - serial bus [128](#)
  - timeout [610](#)
  - window [612](#)
- Trigger
  - considerations [629](#)
  - logic qualification conditions [635](#)
  - modes [631](#)
  - slope and level [632](#)
  - sources [630](#)
- Trigger controls [39](#)
- trigger delay [633](#)
- trigger event file save [182](#)
- trigger holdoff [129](#)
- trigger menu [87](#)
- Trigger menus [556](#)
- trigger out [493](#)
- trigger the oscilloscope [87](#)
- Trigger types [630](#)
- Triggering
  - advanced [633](#)
  - modes [631](#)
  - sources [630](#)
- triggering concepts [121](#), [630](#)
- tRPRE measurement (DDR) [207](#)
- Trr measurement [290](#)
- tWPRE measurement (DDR) [207](#)

## U

- UDF [652](#)
- UDF errors and warnings [727](#)
- undo last action [486](#)
- uninstall an option license [504](#)
- uninstall option license
  - how to [37](#), [68](#), [71–73](#), [76](#), [79](#), [85–89](#), [93](#), [95](#), [97–99](#), [107–109](#), [111](#), [114](#), [121–124](#), [126](#), [129](#), [142](#), [172–176](#), [212](#), [239](#), [256](#), [266](#), [278](#), [337–339](#), [343](#), [449](#), [492](#), [504](#), [505](#), [544](#)

- Unit Interval [191](#)
- unmount a network drive [78](#)
- unmount a network drive (Windows 10 instrument) [79](#)
- unmount a TekDrive [79](#)
- unmount USB devices [480](#)
- unsupported probe [441](#)
- USB [493](#)
- USB bus trigger settings [561](#)
- USB cable, connect to PC [79](#)
- USB Device port (rear panel) [48](#)
- USB Host ports (rear panel) [48](#)
- USB ports (front panel) [39](#)
- USB serial bus menu [335](#)
- use cursors [109](#)
- use multi-source cursors [111](#)
- user button [474](#)
- User Defined Filter [652](#)
- User defined filter errors and warnings [727](#)
- user documentation [27](#)
- user preferences
  - define custom (waveform) colors [486](#)
  - define custom colors [492](#)
  - display settings [486](#)
  - graticule settings (movable or fixed) [486](#)
- using mouse with the touchscreen [68](#)
- utility menu [469](#)

## V

- V Bar cursors [447](#)
- V&H Bar cursors [447](#)
- variables (math equation editor) [466](#)
- Vertical acquisition [628](#)
- Vertical acquisition window [627](#)
- Vertical controls [39](#)
- Vertical offset [628](#)
- vertical settings [439](#)
- video output (rear panel) [48](#)
- Video trigger menu [558](#)
- virtual keyboard [616](#)
- virtual keypad [615](#), [616](#)
- visual trigger
  - change an area's height [132](#)
  - change an area's horizontal center [132](#)
  - change an area's logic true condition [132](#)
  - change an area's shape [132](#)
  - change an area's source [132](#)
  - change an area's vertical center [132](#)
  - change an area's width [132](#)
  - create a visual trigger area [130](#)
  - flip an area horizontally [132](#)
  - flip an area vertically [132](#)
  - rotate an area [132](#)
- Visual Trigger
  - Area configuration menu [616](#)
  - area settings panel [616](#)
  - Edit Vertices panel [616](#)
- visual trigger concepts [636](#)
- voltmeter [451](#)

Volts per division  
maximum [627](#)

## W

Wave Inspector [166](#)  
waveform  
    expansion point [53](#)  
    intensity [108](#)  
    persistence [108](#)  
    recalling [175](#)  
    record view [53](#)  
waveform badge [55](#)  
waveform colors, how to change [486](#), [492](#)  
waveform cursors [447](#)  
Waveform differentiation [644](#)  
waveform dots style, setting [622](#)  
waveform editor [644](#)  
waveform file  
    saving [172](#)  
Waveform Histogram [163](#), [619](#)  
Waveform Histogram badges [55](#)  
Waveform Histogram configuration menu [619](#)  
Waveform Histogram guidelines [164](#)  
Waveform Histogram Result badge menu [620](#)  
Waveform integration [645](#)  
waveform intensity, setting [622](#)  
waveform interpolation [155](#)  
waveform persistence [155](#)  
waveform persistence, setting [622](#)  
waveform preview [638](#)  
waveform style, setting [622](#)  
waveform vectors style, setting [622](#)  
Waveform View [51](#)  
Waveform View settings [622](#)  
Waveforms  
    math [643](#)  
waveforms, saving [474](#)  
Width@BER [233](#), [683](#)  
Width@BER measurement [233](#)  
Width@BER measurement configuration panel [233](#)  
Window search menu [429](#)  
window trigger [124](#), [612](#), [634](#)  
Windows instrument, remote access [80](#)

## X

x-axis scale (spectrum view) [548](#)  
XY plot [101](#)  
XY plot menu [542](#)  
XYZ plot [101](#)  
XYZ plot menu [543](#)

## Z

zoom [165](#), [166](#)  
Zoom [451](#)  
Zoom box [67](#)  
Zoom button (front panel) [39](#)

zoom icon [53](#)  
zoom mode [165](#)  
Zoom overview [67](#)  
Zoom title bar [67](#)  
Zoom/Pan knobs (horizontal) [39](#)  
zooming on search events [166](#)