

Digital Storage Oscilloscope

TBS2000B Series Datasheet

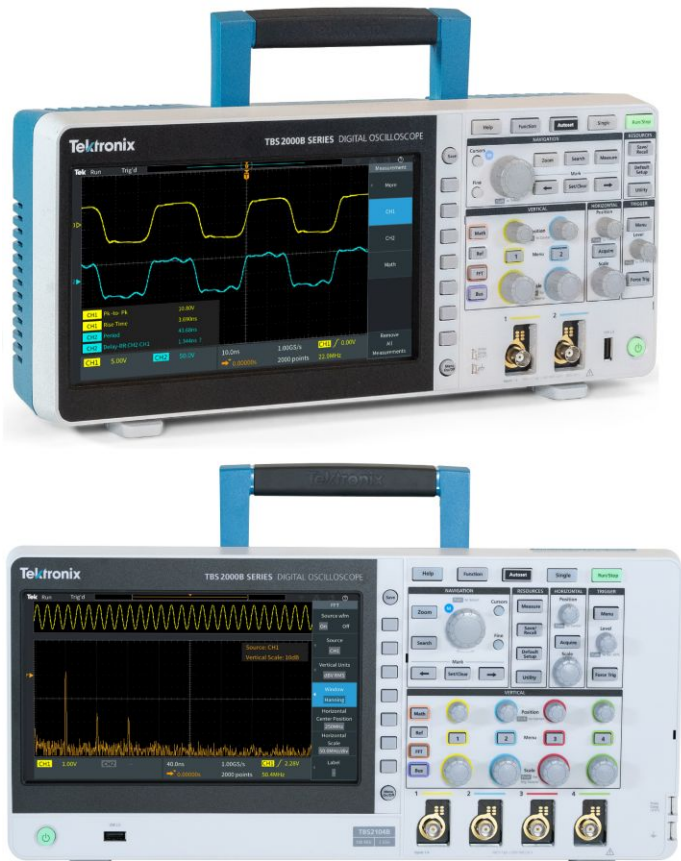

The TBS2000B Series of Oscilloscopes with a 9-inch WVGA display, 5 million point record length and 2 GS/s sample rate, capture and display significantly more signal to help you debug and validate the designs faster. Easily and confidently analyze your signals with new on-waveform cursor readouts and 32 automated measurements, each with informative tips. The TekVPI® probe interface supports traditional passive BNC probes, but also enables wide application coverage with the latest active voltage probes and current probes.

Key performance specifications

- 2 and 4 analog channel models
- 200 MHz, 100 MHz, and 70 MHz bandwidth models up to 2 GS/s sampling rate
- 5 M record length on all channels
- 5 year warranty

Key features

- 9-inch WVGA color display with 15 horizontal grids shows 50% more signal
- TekVPI probe interface supports active, differential, and current probes with automatic scaling and units
- New front-end design enables more accurate measurements
- 32 automated measurements, and FFT function for quick waveform analysis
- Search and Mark features for easy identification of events that occur in the acquired waveform
- HelpEverywhere provides helpful on-screen tips for new users
- Built-in Scope Intro handbook provides operating instructions and oscilloscope fundamentals
- The instrument user interface and the front panel overlay is translated into 10 languages

Connectivity

- USB 2.0 host port on the front panel for quick and easy data storage
- USB 2.0 device port on rear panel for easy connection to a PC
- 10/100BASE-T Ethernet port for remote control over LAN
- Wi-Fi interface provides wireless communications capability support ¹

Education

- Courseware function presents lab exercise guidance on the display
- Fully compatible with TekSmartLab lab management software for education
- Autoset, Cursors and Automated measurements can be disabled to help educators to teach basic concepts to students

¹ A Wi-Fi adapter is available in some countries from Tektronix distributors as an accessory, model TEK-USB-WIFI. See Ordering Information for details.

Designed to make your work easier

The TBS2000B Series is designed for easy operation and quick hands-on learning. Dedicated controls provide quick access to important settings, so you can evaluate signals faster. With the TBS2000B you get 10 vertical divisions and 15 horizontal divisions, so you can see more of your signal. The large display also offers more room for measurement results and menu information.

The Zoom function lets you quickly pan through the record and zoom in to see signal details. The new on screen cursors overlay the cursor measurements on the screen making them intuitive to read and understand.

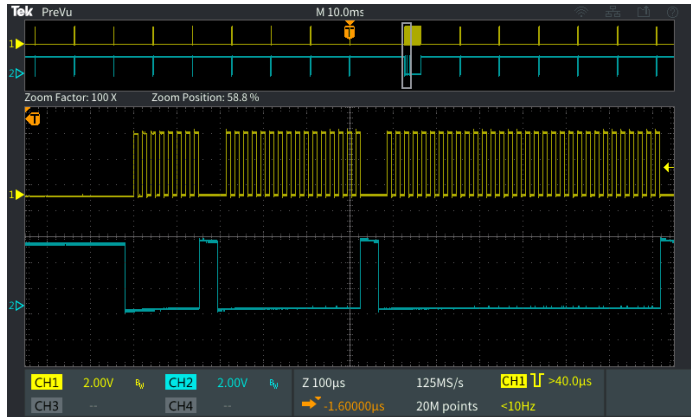

In Zoom mode, an overview of the entire record is shown in the upper part of the display and the lower part displays the detailed Zoomed view.

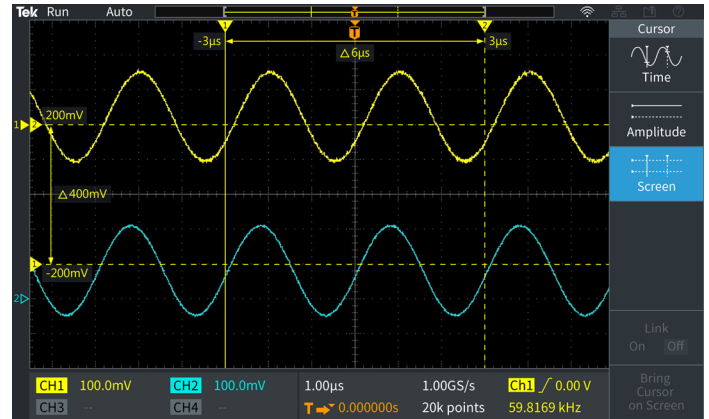

The cursor readouts are presented on the waveform display. Cursors can be used to measure time and amplitude.

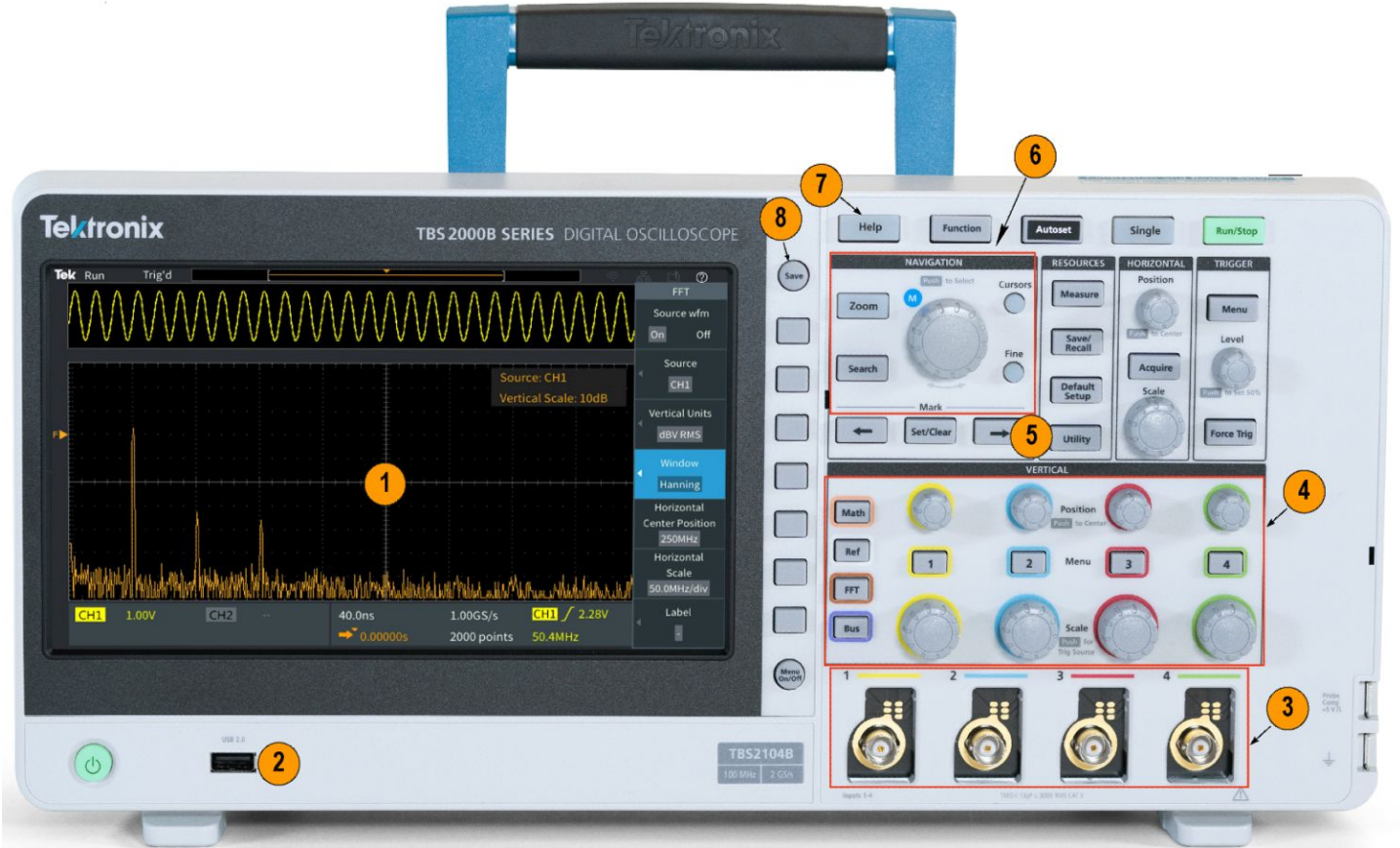

TBS2000B front panel

Image reference	Description
1	Large 9" Display
2	USB port for save / recall
3	TekVPI Probe Interface, for use with passive and active probes
4	Dedicated control knobs per channel

Image reference	Description
5	Search for event for interest
6	Multi purpose knob for navigation, zoom and cursors
7	Help everywhere
8	One-button save



TBS2000B rear panel

Image reference	Description
1	Aux Out signal
2	Ethernet for remote connectivity
3	USB port for WiFi connectivity
4	USB TMC for remote connectivity

Versatile triggering and acquisition modes – The trigger system is designed for troubleshooting today's mixed signal designs. Beyond a basic edge trigger, it also includes pulse width and runt triggering, which are especially useful for troubleshooting digital sections of your designs. Pulse width triggering is perfect for hunting narrow glitches or timeout conditions. Runt trigger is designed to capture signals that are shorter in amplitude than expected.

The Instrument offers several acquisition modes. The default acquisition mode is Sample Mode which works well for most applications. The Peak Detect Mode is useful for hunting spikes, and Average Mode can help reduce noise on repetitive signals.

Quickly search for events of interest – The search button enables you to quickly setup a search criteria based on trigger settings. All occurrences of the event of interest with the acquisition are highlighted with search marks. Easily navigate to each instance of occurrence with dedicated navigation buttons for closer inspection and analysis.



Search and mark



Search through events of interest and mark then through the entire acquisition.

Automated measurements are easier than ever – A comprehensive set of automated measurements enable fast and convenient testing of a wide variety of signal conditions for different applications.

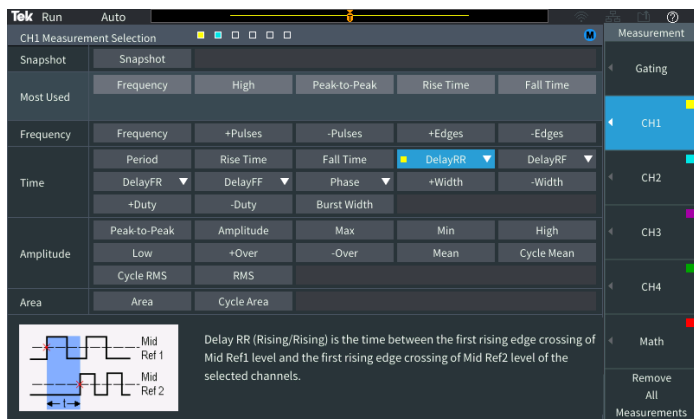

Measurements are all listed and selected on a single screen.

The measurements are grouped into four categories: Frequency, time, amplitude, and area. All the measurements are displayed on a single measurement selection screen making it easy to choose from 32 automated measurements, no more hunting through various menus. Measurements are color coded by the source, and are presented on a transparent background, so waveforms are not obscured by the readouts. The HelpEverywhere system provides help texts with graphics to explain how a measurement is performed, making it easier for new users to know which measurement to use and to interpret the results.

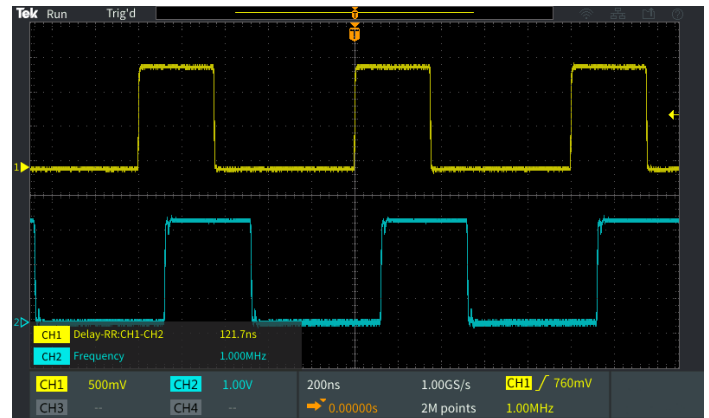

Measurements are transparent so waveforms are not obscured.

FFT function – You can understand the frequency content of your signals with the FFT function by pressing the dedicated front-panel FFT button. Display only the FFT, or turn on the source waveform display to see both the frequency and the time domain waveform. A transparent readout shows important settings without blocking the FFT display.

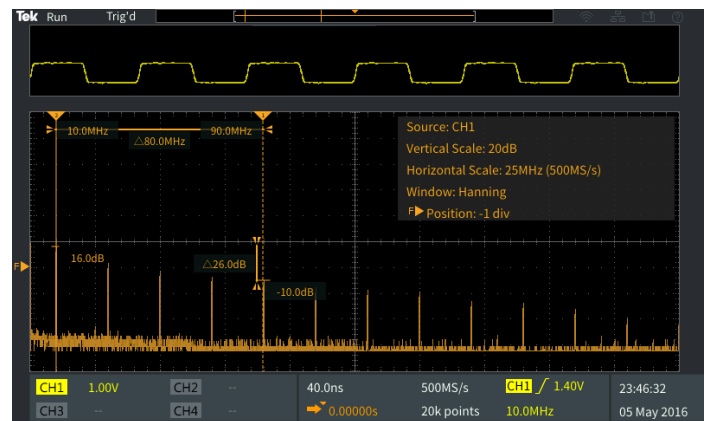

The time domain source waveform can be displayed above the FFT frequency spectrum.

TekVPI® Interface and active probe support

The TekVPI probe interface sets the standard for ease of use in probing. With this interface the TBS2000B Series Oscilloscope supports a wide range of the latest voltage and current probes, providing coverage for many applications. These probes are powered by and communicate with the TBS2000B through the VPI interface. Scale factors and status information, such as error conditions, are sent to the instrument for processing and display. This saves you from having to manually set scale factors, calculate offsets, or the need to degauss your current probes.

The new front end design with higher 2GS/s sample rate offers lower noise and higher effective bits enabling more accurate measurements.



TekVPI probes communicate scale settings, ranges, and status to the TBS2000B.

First in its class with wireless communications

On the rear of the instrument, you will find several communications ports. The USB device port or LAN port can be used to control the instrument using the fully-documented command set.



Wi-Fi adapters are configured through integrated setup menus and support seamless wireless communications

The TBS2000B is the first oscilloscope in its class to support wireless communication. Plug a compatible Wi-Fi dongle into the USB host port and setup the interface for Wi-Fi from the front panel.

Built-in tips for faster setup

HelpEverywhere is a unique feature on the TBS2000B. It shows instant help information as you navigate through key menus. The tips include measurement information, application tips, and general guidance in the form of text and graphics. You can selectively turn tips on and off from the HelpEverywhere menu.

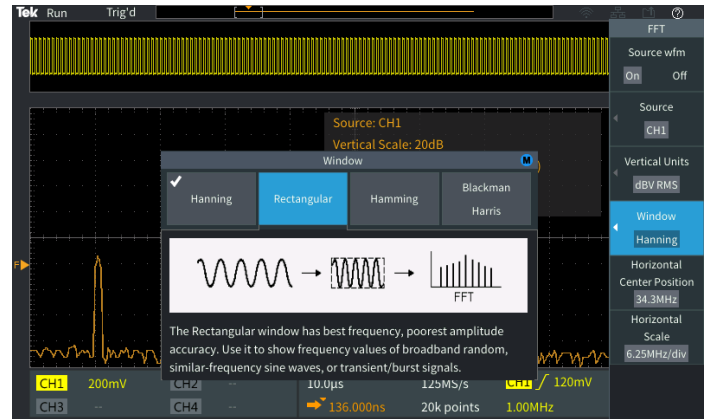

HelpEverywhere tips explain important settings.

On-screen scope fundamentals

Scope Intro handbook is embedded into the TBS2000B help system. Pressing the front panel Function button gives you access to information on oscilloscope basic operations, as well as an overview of the TBS2000B and TekSmartLab Lab Management System for education.

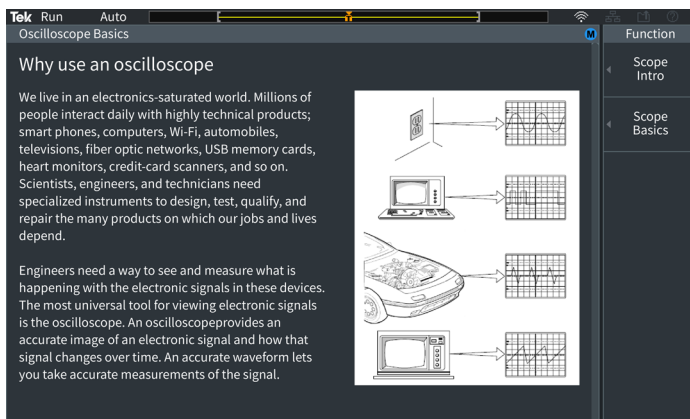
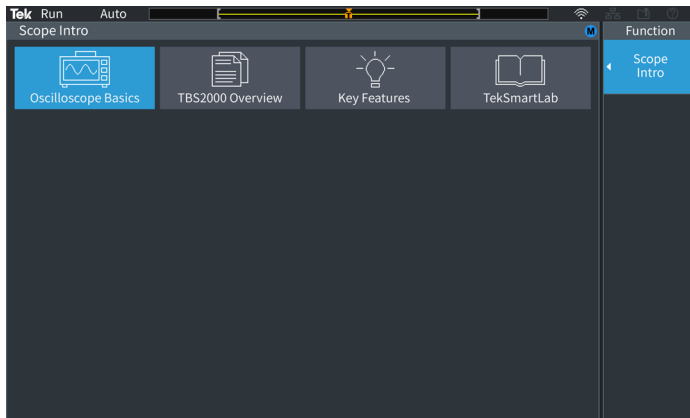

Scope Intro covers basic oscilloscope and TBS2000B usage

Innovative new education solutions

The TBS2000B offers new ways to enable educators to devote more time to teaching circuit concepts instead of lab setup and management.

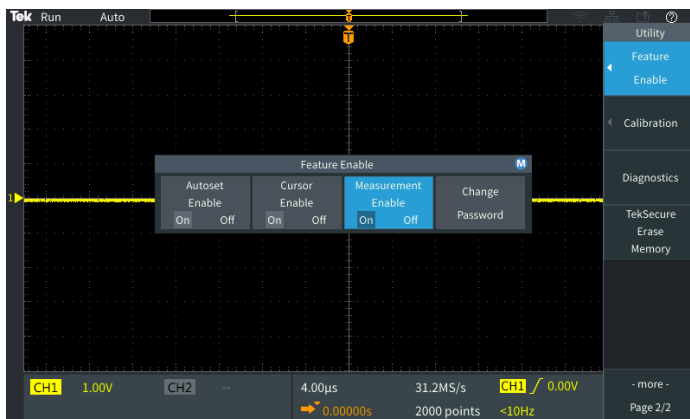

With menus

Educators can disable Autoset, Cursors and automated measurements on the instruments so that they can teach the students on the basic concepts and help them understand how to use the instrument horizontal and vertical controls to get the waveform display, use the graticule to measure time and voltage and manually plot / calculate the signal characteristics.

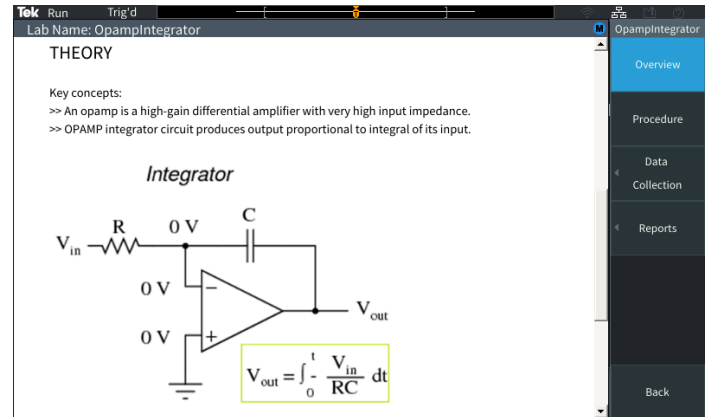

The Courseware function allows students to see lab information on the instrument display.

The integrated Courseware function allows professors to load lab exercises on the instrument to give students guidance at each station and provides a structured framework into which students can capture data to incorporate into their reports. Over 100 sample lab exercises are available for download from the [Tektronix Courseware Resource Center](#).



The TBS2000B can be easily integrated into the TekSmartLab System. Together they enable educators to preset a lab full of instruments with a few mouse-clicks and allow lab instructors to track every student's progress from one central workstation.

TekBench

TekBench™ is PC software that controls Tektronix oscilloscopes and arbitrary function generators. It offers intuitive instrument control, automated measurement data logging, automated frequency response measurements, and easy waveform exporting with required format to eliminate extra time and effort. It allow users to focus on their experiment rather than learning the instrument



TekBench

Performance you can count on

Tektronix has industry-leading service and support, and every TBS2000B Series Oscilloscope is backed with a standard 5-year warranty.

Specifications

All specifications are guaranteed unless noted otherwise. All specifications apply to all models unless noted otherwise.

Model overview

Models	TBS2072B	TBS2074B	TBS2102B	TBS2104B	TBS2202B	TBS2204B
Analog Channels	2	4	2	4	2	4
Bandwidth	70 MHz	70 MHz	100 MHz	100 MHz	200 MHz	200 MHz
Sample rate	2 GS/s	2 GS/s	2 GS/s	2 GS/s	2 GS/s	2 GS/s
Record length	5 M points	5 M points	5 M points	5 M points	5 M points	5 M points

Vertical system analog channels

Hardware bandwidth limits 20 MHz

Input coupling DC, AC, or GND

Input impedance $1\text{ M}\Omega \pm 1\%$, $13\text{ pF} \pm 1.5\text{ pF}$

Input sensitivity range 2mV/div 10 V/div

Vertical resolution 8 bits

Maximum input voltage, 1 M Ω 300 V RMS with peaks $\leq \pm 450\text{ V}$

Acquisition modes

Sample Acquire sampled values.

Peak Detect Captures glitches as narrow as 3.5 ns at all sweep speeds.

Average From 2 to 512 waveforms included in average.

Hi-Res Averages multiple sample of one acquisition interval into one waveform point.

Roll Scrolls waveforms right to left across the screen at sweep speeds slower than or equal to 40 ms/div (400 ms/div at 20M record length).

Waveform math

Arithmetic: Add
Subtract
Multiply
FFT

DC balance $\pm (1\text{ mV} + 0.1\text{ div})$

DC gain accuracy $\pm 2\%$ 10 V/div through 5 mV/div \pm
3% typical 2 mV/div

Vertical system analog channels

DC voltage measurement accuracy
average mode

Average of 16 waveforms $\pm((\text{DC Gain Accuracy}) \times |\text{reading} - (\text{offset} - \text{position})| + \text{Offset Accuracy} + 0.11 \text{ div} + 1 \text{ mV})$

Delta Volts between any two averages of ≥ 16 waveforms acquired with the same oscilloscope setup and ambient conditions $\pm(\text{DC Gain Accuracy} \times |\text{reading}| + 0.08 \text{ div} + 1.4 \text{ mV})$

Vertical position range ± 5 divisions

Vertical offset ranges	Volts/Div setting	Offset range, 1 M Ω
	2 mV/Div to 63 mV/Div	$\pm 1 \text{ V}$
	64 mV/div to 999 mV/div	$\pm 10 \text{ V}$
	1 V/div to 10 V/div	$\pm 100 \text{ V}$

Analog bandwidth, DC coupled

200 MHz models: DC to >200 MHz

100 MHz models: DC to ≥ 100 MHz

70 MHz models: DC to ≥ 70 MHz

Common mode rejection ratio (CMRR), typical 100:1 at 60 Hz, reducing to 10:1 with 50 MHz sine wave with equal Volts/div and coupling settings on each channel.

Channel-to-channel isolation	TBS2072B, TBS2074B	TBS2102B, TBS2104B	TBS2202B, TBS2204B
	$\geq 100:1$ at ≤ 70 MHz	$\geq 100:1$ at ≤ 100 MHz	$\geq 100:1$ at ≤ 200 MHz

Horizontal system analog channels

Maximum duration of time captured at highest sample rate (all channels) 5 ms

Time base range
TBS220x: 1 ns/div to 100 sec/div
TBS207x, TBS210x: 2 ns/div to 100 sec/div

Time-base delay time range -15 divisions to 5000 s

Deskew range ± 100 ns

Time base accuracy ± 25 ppm over any ≥ 1 ms interval

Trigger system

Trigger modes	Auto, Normal, and Single	
Trigger holdoff range	20 ns to 8 s	
Trigger types		
Edge	Positive or negative slope on any channel. Coupling includes DC, HF reject, LF reject, and noise reject.	
Pulse width	Trigger on width of positive or negative pulses that are $>$, $<$, $=$, or \neq a specified period of time.	
Runt	Trigger on a pulse that crosses one threshold but fails to cross a second threshold before crossing the first again.	
Trigger coupling analog channels	DC, Noise Reject, High Freq Reject, Low Freq Reject.	
Sensitivity, edge-type trigger, DC coupled	Trigger Source	Sensitivity
	70 MHz models	0.4 division
	100 MHz models	0.5 division
	200 MHz models	0.7 division
Trigger level ranges	Input channels: ± 4.90 divisions from center screen	

Data storage

Nonvolatile memory retention time, typical	No time limit for Front Panel Settings, saved waveforms, setups, and calibration constants.
Real-Time clock	A programmable clock providing time in years, months, days, hours, minutes, and seconds.

Waveform measurements

Cursors	Time, amplitude and screen.
Automated measurements	32, of which up to six can be displayed on-screen at any one time. Measurements include: Period, Frequency, Rise Time, Fall Time, Positive Duty Cycle, Negative Duty Cycle, Positive Pulse Width, Negative Pulse Width, Burst Width, Phase, Positive Overshoot, Negative Overshoot, Peak to Peak, Amplitude, High, Low, Max, Min, Mean, Cycle Mean, RMS, Cycle RMS, Positive Pulse Count, Negative Pulse Count, Rising Edge Count, Falling Edge Count, Area, Cycle Area, Delay FR, Delay FF, Delay FR, and Delay RR.
Gating	Isolate the specific occurrence within an acquisition to take measurements on, using either the screen, between waveform cursors or full record length.

Waveform math

Arithmetic	Add, subtract, and multiply waveforms.
FFT	Spectral magnitude. Set FFT Vertical Scale to Linear RMS or dBV RMS, and FFT Window to Rectangular, Hamming, Hanning, or Blackman-Harris.

Remote control software

web page	Built-in web page enables remote control of horizontal and vertical scale, trigger settings, and measurements. Allows waveform and image save to USB flash drive.
-----------------	---

Display system

Display type	9 inch (228 mm) wide format liquid crystal TFT color display.
Display resolution	800 horizontal by 480 vertical displayed pixels (WVGA).
Waveform styles	Vectors, Variable Persistence, and Infinite Persistence.
Graticules	Grid, None.
Format	YT and XY.

Input output ports

USB 2.0 high-speed host port	Supports USB mass storage devices, Wi-Fi dongle, One port available on rear panel and one on front panel.
USB 2.0 high-speed device port	
Device port	Rear-panel connector allows for communication/control of oscilloscope through USBTMC or GPIB with a TEK-USB-488.
Compatible USB-WIFI dongles	NETGEAR WNA1000M, WNA3100M, D-LINK DWA-131, TP-LINK TL-WN823N
LAN port (Ethernet)	RJ-45 connector, supports 10/100BASE-T.
Probe compensator	
Amplitude	5 V
Frequency	1 kHz
Kensington-style lock	Rear-panel security slot connects to standard Kensington-style lock.

Power source

Power source voltage	100 to 240 V _{AC} RMS ±10%
Power source frequency	47 Hz to 63 Hz (100 to 240 V) 360 Hz to 440 Hz (100 to 132 V)
Power consumption	40 W maximum

Physical characteristics

Dimensions

TBS2xx2:	Height: 174.9 mm (6.89 in)
	Width: 372.4 mm (14.66 in)
	Depth: 117.7 mm (4.64 in)
TBS2xx4:	Height: 201.5mm (7.93 in)
	Width: 412.8 mm (16.25 in)
	Depth: 128.1 mm (5.58 in)

Weight

TBS2xx2:	2.62 kg (5.8 lbs.), standalone instrument.
	5.1 kg (11.2 lbs.), when packaged for domestic shipment.
TBS2xx4:	4.08 kg (9.0 lbs.), stand-alone instrument.
	6.89 kg (15.2 lbs.), when packaged for domestic shipment.

Cooling clearance	50 mm (2 in) required on left side and rear of instrument.
--------------------------	--

EMC, environment, and safety

Temperature

Operating:	0 °C to +50 °C (+32 °F to 122 °F)
Nonoperating:	-40 °C to +71 °C (-40 °F to 160 °F)

Humidity

Operating:	5% to 95% relative humidity (% RH) at up to +30° C
	5% to 60% RH above +30° C up to +50° C
	non-condensing
Nonoperating:	5% to 95% RH (Relative Humidity) at up to +30° C
	5% to 60% RH above +30° C up to +60° C
	non-condensing

Altitude

Operating:	Up to 3,000 meters (9,842 feet).
Non-Operating:	Up to 12,000 meters (39,370 feet).
	Altitude is limited by possible damage to LCD at higher altitudes. This damage is independent of operation.

Regulatory

Electromagnetic compatibility	EC Council Directive 2014/30/EU
Safety	UL61010-1, UL61010-2-030, CAN/CSA-C22.2 No. 61010.1, CAN/CSA-C22.2 No. 61010-2:030; complies with the Low Voltage Directive 2014/35/EU for Product Safety

Ordering information

Models

Product	Supported instruments
TBS2072B	70 MHz bandwidth, 2 GS/s sample rate, 2-channel digital storage oscilloscope, 5 Mpts record length, 5 year warranty. Certificate of Calibration Standard.
TBS2074B	70 MHz bandwidth, 2 GS/s sample rate, 4-channel digital storage oscilloscope, 5 Mpts record length, 5 year warranty. Certificate of Calibration Standard.
TBS2102B	100 MHz bandwidth, 2 GS/s sample rate, 2-channel digital storage oscilloscope, 5 Mpts record length, 5 year warranty. Certificate of Calibration Standard.
TBS2104B	100 MHz bandwidth, 2 GS/s sample rate, 4-channel digital storage oscilloscope, 5 Mpts record length, 5 year warranty. Certificate of Calibration Standard.
TBS2202B	200 MHz bandwidth, 2 GS/s sample rate, 2-channel digital storage oscilloscope, 5 Mpts record length, 5 year warranty. Certificate of Calibration Standard.
TBS2204B	200 MHz bandwidth, 2 GS/s sample rate, 4-channel digital storage oscilloscope, 5 Mpts record length, 5 year warranty. Certificate of Calibration Standard.

Bandwidth upgrade options

Options	Supported instruments
SUP2-BW7T102	Upgrade 70 MHz to 100 MHz on 2-channel models of TBS2000B Series oscilloscopes
SUP2-BW7T104	Upgrade 70 MHz to 100 MHz on 4-channel models of TBS2000B Series oscilloscopes
SUP2-BW7T202	Upgrade 70 MHz to 200 MHz on 2-channel models of TBS2000B Series oscilloscopes
SUP2-BW7T204	Upgrade 70 MHz to 200 MHz on 4-channel models of TBS2000B Series oscilloscopes
SUP2-BW10T202	Upgrade 100 MHz to 200 MHz on 2-channel models of TBS2000B Series oscilloscopes
SUP2-BW10T204	Upgrade 100 MHz to 200 MHz on 4-channel models of TBS2000B Series oscilloscopes

Standard accessories

Probes	TPP0200	200 MHz, 10x passive probe (one per analog channel) 200 MHz models
	TPP0100	100 MHz, 10x passive probe (one per analog channel) for 70 MHz and 100 MHz models
Accessories	071-3635-xx	Compliance and Safety Instructions
	077-1149-xx	Programmer manual, available in http://www.tek.com
	-	Power cord
	-	Calibration certificate documenting traceability to National Metrology Institute(s) and ISO9001 quality system registration

Warranty Five-year warranty covering all parts and labor, excluding probes.

Recommended accessories

Probes	Tektronix offers over 100 different probes to meet your application needs. For a comprehensive listing of available probes, please visit www.tektronix.com/probes .
P5100A	2.5 kV, 500 MHz, 100X high-voltage passive probe
TDP0500	500 MHz TekVPI [®] differential voltage probe with ± 42 V differential input voltage
THDP0200	± 1.5 kV 200 MHz high-voltage differential probe
THDP0100	± 6 kV 100 MHz high-voltage differential probe
TAP1500	1.5 GHz TekVPI [®] active voltage probe
TCP0020	50 MHz TekVPI [®] 20 Ampere AC/DC current probe
TCP0030A	120 MHz TekVPI [®] 30 Ampere AC/DC current probe
TCP0150	20 MHz TekVPI [®] 150 Ampere AC/DC current probe
TCP2020	50 MHz BNC 20 Ampere AC/DC current probe
P5202A	100 MHz, 640 V High Voltage differential probe
P5205A	100 MHz, 1.3 kV High Voltage differential probe
P5210A	50 MHz, 5.6 kV High Voltage differential probe
Accessories	
ACD2000	Soft transit case for TBS2000B 2-channel instrument
ACD4000B	Soft transit case, for TBS2000B 4-channel instrument
TPA-BNC	TekVPI [®] to TekProbe [®] BNC adapter
TEK-DPG	TekVPI [®] Deskew pulse generator signal source
067-1686-XX	Power measurement deskew and calibration fixture
TEK-USB-488	GPIB-to-USB adapter
TEK-USB-WIFI	USB Wi-Fi ² dongle for TBS2000B Series Oscilloscope only

² Certified to comply with CE, FCC and IC regulations. Available in Australia, Canada, China, EU Region, New Zealand, and United States. For other compatible Wi-Fi adapters, see Compatible USB-WIFI dongles under Input output ports specifications.

Instrument options

Instrument Options

2-WIFI USB Wi-Fi dongle for TBS2000B Series Oscilloscope only

Power plug options

Opt. A0	North America power plug (115 V, 60 Hz)
Opt. A1	Universal Euro power plug (220 V, 50 Hz)
Opt. A2	United Kingdom power plug (240 V, 50 Hz)
Opt. A3	Australia power plug (240 V, 50 Hz)
Opt. A4	North America power plug (240 V, 50 Hz)
Opt. A5	Switzerland power plug (220 V, 50 Hz)
Opt. A6	Japan power plug (100 V, 50/60 Hz)
Opt. A10	China power plug (50 Hz)
Opt. A11	India power plug (50 Hz)
Opt. A12	Brazil power plug (60 Hz)
Opt. A99	No power cord
Opt E1	Universal EURO, United Kingdom and Switzerland

Language options

Opt. L0	English manual
Opt. L1	French manual
Opt. L2	Italian manual
Opt. L3	German manual
Opt. L4	Spanish manual
Opt. L5	Japanese manual
Opt. L7	Simplified Chinese manual
Opt. L8	Traditional Chinese manual
Opt. L9	Korean manual
Opt. L10	Russian manual
Opt. L99	No manual

Language options include translated front-panel overlay for the selected language(s).

Service options

Opt. C3	Calibration Service 3 years. Includes traceable calibration or functional verification applicable, for recommended calibrations. Coverage includes the initial calibration plus 2 years calibration coverage.
Opt. C5	Calibration Service 5 years. Includes traceable calibration or functional verification applicable, for recommended calibrations. Coverage includes the initial calibration plus 4 years calibration coverage.
Opt. D1	Calibration Data Report.
Opt. D3	Calibration Data Report 3 years (with Option C3).
Opt. D5	Calibration Data Report 5 years (with Option C5).
Opt. T3	Three Year Total Protection Plan, includes repair or replacement coverage from wear and tear, accidental damage, ESD or EOS plus preventative maintenance. Including a 5 day turnaround time and priority access to customer support.
Opt. T5	Five Year Total Protection Plan, includes repair or replacement coverage from wear and tear, accidental damage, ESD or EOS plus preventative maintenance. Including a 5 day turnaround time and priority access to customer support.

Probes and accessories are not covered by the oscilloscope warranty and Service Offerings. Refer to the datasheet of each probe and accessory model for its unique warranty and calibration terms.



Tektronix is registered to ISO 9001 and ISO 14001 by SRI Quality System Registrar.



Product(s) complies with IEEE Standard 488.1-1987, RS-232-C, and with Tektronix Standard Codes and Formats.



Product Area Assessed: The planning, design/development and manufacture of electronic Test and Measurement instruments.

ASEAN / Australasia (65) 6356 3900
Belgium 00800 2255 4835*
Central East Europe and the Baltics +41 52 675 3777
Finland +41 52 675 3777
Hong Kong 400 820 5835
Japan 81 (3) 6714 3086
Middle East, Asia, and North Africa +41 52 675 3777
People's Republic of China 400 820 5835
Republic of Korea +822 6917 5084, 822 6917 5080
Spain 00800 2255 4835*
Taiwan 886 (2) 2656 6688

Austria 00800 2255 4835*
Brazil +55 (11) 3759 7627
Central Europe & Greece +41 52 675 3777
France 00800 2255 4835*
India 000 800 650 1835
Luxembourg +41 52 675 3777
The Netherlands 00800 2255 4835*
Poland +41 52 675 3777
Russia & CIS +7 (495) 6647564
Sweden 00800 2255 4835*
United Kingdom & Ireland 00800 2255 4835*

Balkans, Israel, South Africa and other ISE Countries +41 52 675 3777
Canada 1 800 833 9200
Denmark +45 80 88 1401
Germany 00800 2255 4835*
Italy 00800 2255 4835*
Mexico, Central/South America & Caribbean 52 (55) 56 04 50 90
Norway 800 16098
Portugal 80 08 12370
South Africa +41 52 675 3777
Switzerland 00800 2255 4835*
USA 1 800 833 9200

* European toll-free number. If not accessible, call: +41 52 675 3777

For Further Information. Tektronix maintains a comprehensive, constantly expanding collection of application notes, technical briefs and other resources to help engineers working on the cutting edge of technology. Please visit www.tek.com.

Copyright © Tektronix, Inc. All rights reserved. Tektronix products are covered by U.S. and foreign patents, issued and pending. Information in this publication supersedes that in all previously published material. Specification and price change privileges reserved. TEKTRONIX and TEK are registered trademarks of Tektronix, Inc. All other trade names referenced are the service marks, trademarks, or registered trademarks of their respective companies.



28 Jan 2020 3GW-61509-0

