



Brushless

ELECTRIC TORQUE SCREWDRIVER

Industrial Strength



【About SUMAKE】

SUMAKE stands out as a leading provider of an extensive array of essential tools crucial for product assemblies. Within our comprehensive product range, customers can find electric torque screwdrivers, air torque screwdrivers, manual torque screwdrivers, assembly tools, and automotive tools. These tools play a pivotal role in maintaining the highest standards of quality in product assemblies across diverse industries, showcasing SUMAKE's commitment to delivering reliable and efficient solutions for various assembly processes.

One of SUMAKE's key strengths lies in providing a comprehensive selection of tools that not only meet but exceed the requirements of the ISO 9001 standard. This empowers our customers to ensure the highest quality and integrate the latest innovations into their product assemblies. Beyond just supplying top-notch tools that cater to the evolving needs of different industries, SUMAKE is dedicated to sustainable corporate development. This commitment is evident in our efforts to integrate environmental considerations into our operations, reflecting our awareness of the importance of responsible business practices.

In essence, SUMAKE not only serves as a trusted source for essential assembly tools but also as a partner in quality assurance and sustainable development. Our diverse range of tools, adherence to quality standards, and commitment to environmental responsibility collectively contribute to making SUMAKE a reliable and forward-thinking choice for businesses across various sectors.



【SUMAKE Electric Torque Screwdrivers】

SUMAKE Electric Torque Screwdrivers offer a multitude of advantages in assembly applications. Within the realm of production, SUMAKE electric screwdrivers significantly enhance efficiency, reduce operator errors and fatigue, and guarantee precise and consistent torque. The SUMAKE electric torque screwdriver comes in diverse models, featuring options like lever start or push to start, with motor alternatives such as AC Brushless, Premium DC Brushless, and DC Standard Brushed. Our extensive range of torque control screwdrivers includes variants equipped with full auto shut-off clutches for meticulous torque control, as well as economically priced slip/cushion clutches. SUMAKE screwdrivers are available in in-line, angle, and pistol grip, tailored to meet diverse user preferences and application requirements.

SUMAKE Electric Torque Screwdriver have been used in broad application across various industries, including electronics, medical manufacturing, automobile manufacturing, contract manufacturing, and assembly lines. This high-quality torque screwdriver from Sumake has earned the trust of numerous companies around the world, ensuring that precise and repeatable torque is applied and consistently maintained throughout their assembly processes.

Our overarching objective is to provide our valued customers with an extensive and comprehensive range of torque control fastening tools, ensuring that they have access to a diverse selection of high-quality instruments that cater to their specific needs and requirements in the field of fastening applications.



PREMIUM BRUSHLESS FULL AUTO SHUT-OFF DC ELECTRIC SCREWDRIVER



LOW TO MEDIUM TORQUE - 0.008~4.9 N.m Page 1 - 2

MEDIUM TORQUE - 0.3~7 N.m Page 3

HIGH TORQUE - 2~50 N.m Page 4 - 6

BUILT IN COUNTER - 0.02~4.9 N.m Page 7 - 8

AUTOMATION - 0.02~4.9 N.m Page 9 - 10

VACUUM PICKUP Page 11

BRUSHLESS POWER SUPPLY Page 13

POWER SUPPLY & SIGNAL CONTROLLER Page 14

FULL AUTO SHUT-OFF AC ELECTRIC SCREWDRIVER DIRECT PLUG IN Page 15

RECOMMENDATION



TORQUE METERS Page 16

AUTOMATIC SCREW FEEDER Page 17 - 18

ACCESSORIES Page 19 - 20

Premium Brushless DC Screwdriver

Low Torque With Full Auto Shut Off Clutches

Torque Range 0.008~0.98 N.m



Feature

- Smallest & Lightest.(EA-B101L-C/CE3 ~ EA-B103LS1-C/CE3)
- High performance brushless motor.
- All models come standard with ESD safe housing.(Electrostatic discharge)

Lightest & Lowest Torque
0.17Kg Only
0.008~0.34N.m



Lever Start Type
EA-B101L-C/CE3 ~ EA-B103LS1-C/CE3

Bit Shank: Ø4mm

Mini type



Lever Start Type
EA-BN203L/CE6 ~ EA-BN210L/CE6



Push To Start Type
EA-BN210P/CE6

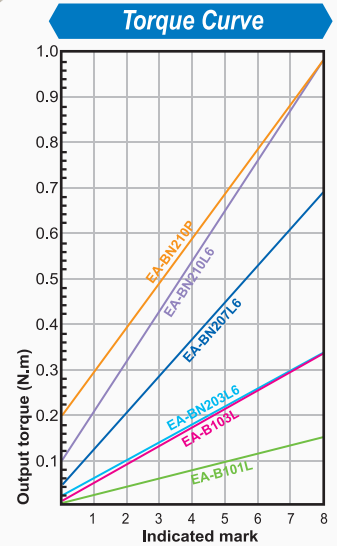

External Dimension unit:mm

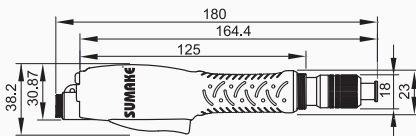

Lever Start Type
EA-B101L-C/CE3 ~ EA-B103LS1-C/CE3

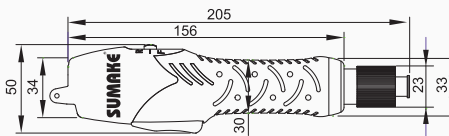

Lever Start Type
EA-BN203L/CE6 ~ EA-BN210L/CE6

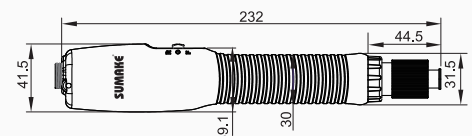

Push To Start Type
EA-BN210P/CE6

Specification:

Power Supply	Model No.	Torque Range ±3%			Unloaded Speed ±10% (r.p.m.)		Available Screw				Net Weight		Overall Length		Power Source	Power Consumption	Bit Type
		kgf-cm	lbf-in	N.m	High	Low	Machine Screw (ø)		Tapping Screw (ø)		g	lb	mm	in			
Lever Start Type																	
	EA-B101L-C/CE3	0.08~1.5	0.07~1.30	0.008~0.15	1000	700	1.0~1.7	0.04~0.07	1.0~1.5	0.04~0.06	170	0.37	180	7.08	DC12V	15W	C
	EA-B101LS1-C/CE3	0.08~1.5	0.07~1.30	0.008~0.15	280	200	1.0~1.7	0.04~0.07	1.0~1.5	0.04~0.06	170	0.37	180	7.08	DC12V	15W	
	EA-B103L-C/CE3	0.5~3.5	0.43~3.04	0.05~0.34	1000	700	1.0~2.3	0.04~0.09	1.0~2.0	0.04~0.08	170	0.37	180	7.08	DC12V	15W	
	EA-B103LS1-C/CE3	0.5~3.5	0.43~3.04	0.05~0.34	280	200	1.0~2.3	0.04~0.09	1.0~2.0	0.04~0.08	170	0.37	180	7.08	DC12V	15W	
	EA-BN203L/CE6	0.2~3.5	0.17~3.04	0.02~0.34	1000	700	1.0~2.3	0.04~0.09	1.0~2.0	0.04~0.08	400	0.88	205	8.07	DC24V/32V	25W	B
	EA-BN203LS1/CE6	0.2~3.5	0.17~3.04	0.02~0.34	500	350	1.0~2.3	0.04~0.09	1.0~2.0	0.04~0.08	400	0.88	205	8.07	DC24V/32V	25W	
	EA-BN203LS2/CE6	0.2~3.5	0.17~3.04	0.02~0.34	370	260	1.0~2.3	0.04~0.09	1.0~2.0	0.04~0.08	400	0.88	205	8.07	DC24V/32V	25W	
	EA-BN203LS3/CE6	0.2~3.5	0.17~3.04	0.02~0.34	230	160	1.0~2.3	0.04~0.09	1.0~2.0	0.04~0.08	400	0.88	205	8.07	DC24V/32V	25W	
	EA-BN207L/CE6	0.5~7.0	0.43~6.08	0.05~0.69	1000	700	1.4~2.6	0.06~0.10	1.4~2.3	0.06~0.09	400	0.88	205	8.07	DC24V/32V	25W	C
	EA-BN210L/CE6	1.0~10	0.87~8.68	0.10~0.98	1000	700	1.6~3.0	0.06~0.12	1.6~2.6	0.06~0.10	400	0.88	205	8.07	DC24V/32V	25W	
Push To Start Type																	
	EA-BN210P/CE6	2.0~10	1.74~8.68	0.20~0.98	1000	700	1.6~3.0	0.06~0.12	1.6~2.6	0.06~0.10	310	0.68	232	9.13	DC24V/32V	25W	

•EA-BN203 - 210 screwdrivers come standard with bit type B HEX 6.35mm

•EA-B101 - 103 screwdrivers come with bit type C Ø4mm

•Note1: Must be ordered with a power supply from page 13.

•Note2: Color chart is used to match up screwdrivers with power supplies.

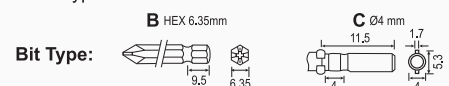

Premium Brushless DC Screwdriver

Low To Medium Torque With Full Auto Shut Off Clutches ■ Torque Range 0.15~4.90 N.m

Feature

- Innovative Brushless motor design eliminates carbon dust and reduces noise and vibration resulting in lower maintenance.
- Brushless motors allow us to build smaller screwdrivers that weigh less, run smoother, reach higher torques, and feel ergonomically comfortable to the user.
- Can be used assemble Watch, Laptop, Digital Camera, DVD player, Cell Phone, High tech Products.
- Precise repeatable torque.
- Highly mobile, easy to operate, high efficiency brushless motor reduces fatigue over long working hours.
- Speed control can be adjusted via power supply.
- All models come standard with ESD safe housing.(Electrostatic discharge)



Lever Start Type
EA-BN412L/CE6 ~ EA-BN419L/CE6
Push to Start Type
EA-BN412P/CE6 ~ EA-BN419P/CE6



Lever Start Type
EA-BN630L/CE6 ~ EA-BN650L/CE6
Push to Start Type
EA-BN630P/CE6 ~ EA-BN650P/CE6



Accessory: Pistol Grip
(For EA-BN630~BN650)
EAA-PG3 (For Push)
EAA-LG3 (For Lever)
EAA-PG3/S (ESD)
EAA-LG3/S (ESD)

External Dimension

unit:mm

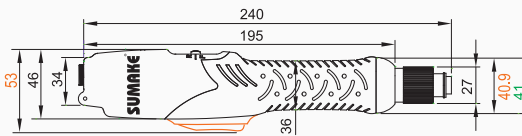

Lever Start Type
EA-BN412L - EA-BN419L

Push to Start Type
EA-BN412P - EA-BN419P

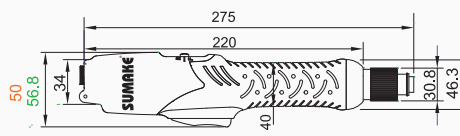

Lever Start Type
EA-BN630L - EA-BN650L

Push to Start Type
EA-BN630P - EA-BN650P

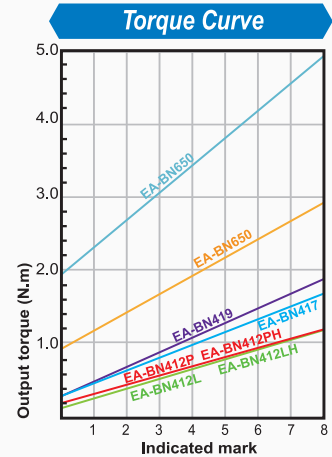

Specification:

Power Supply	Model No.	Torque Range ±3%			Unloaded Speed ±10% (r.p.m.)		Available Screw				Net Weight		Overall Length		Power Source	Power Consumption	Bit Type
		kgf-cm	lbf-in	N.m	High	Low	Machine Screw (ø)		Tapping Screw (ø)		g	lb	mm	in			

Lever Start Type

■	EA-BN412L/CE6	1.5~12	1.3~10.42	0.15~1.18	1000	700	1.6~3.0	0.06~0.12	1.6~2.6	0.06~0.10	540	1.19	240	9.45	DC24V/32V	55W	A B C D
■	EA-BN412LH/CE6	1.5~12	1.3~10.42	0.15~1.18	2000	1400	1.6~3.0	0.06~0.12	1.6~2.6	0.06~0.10	540	1.19	240	9.45	DC24V/32V	55W	
■	EA-BN417LH/CE6	3.0~17	2.6~14.76	0.29~1.67	2000	1400	1.6~3.0	0.06~0.12	1.6~2.6	0.06~0.10	540	1.19	240	9.45	DC24V/32V	55W	
■	EA-BN419L/CE6	3.0~19	2.6~16.49	0.29~1.86	1000	700	2.3~3.5	0.09~0.14	2.3~3.0	0.09~0.12	540	1.19	240	9.45	DC24V/32V	55W	
■	EA-BN630L/CE6	10~30	8.68~26.04	0.98~2.94	1000	750	2.6~4.0	0.10~0.16	2.6~3.5	0.10~0.14	800	1.77	275	10.82	DC40V	90W	A B
■	EA-BN630LH/CE6	10~30	8.68~26.04	0.98~2.94	2000	1500	2.6~4.0	0.10~0.16	2.6~3.5	0.10~0.14	800	1.77	275	10.82	DC40V	90W	
■	EA-BN650L/CE6	20~50	17.36~43.4	1.96~4.90	1000	750	4.0~5.0	0.16~0.20	≤ 4	≤ 0.16	800	1.77	275	10.82	DC40V	120W	

Push To Start Type

■	EA-BN412P/CE6	2.0~12	1.74~10.42	0.20~1.18	1000	700	1.6~3.0	0.06~0.12	1.6~2.6	0.06~0.10	540	1.19	240	9.45	DC24V/32V	55W	A B C D
■	EA-BN412PH/CE6	2.0~12	1.74~10.42	0.20~1.18	2000	1400	1.6~3.0	0.06~0.12	1.6~2.6	0.06~0.10	540	1.19	240	9.45	DC24V/32V	55W	
■	EA-BN417PH/CE6	3.0~17	2.6~14.76	0.29~1.67	2000	1400	1.6~3.0	0.06~0.12	1.6~2.6	0.06~0.10	540	1.19	240	9.45	DC24V/32V	55W	
■	EA-BN419P/CE6	3.0~19	2.6~16.49	0.29~1.86	1000	700	2.3~3.5	0.09~0.14	2.3~3.0	0.09~0.12	540	1.19	240	9.45	DC24V/32V	55W	
■	EA-BN630P/CE6	10~30	8.68~26.04	0.98~2.94	1000	750	2.6~4.0	0.10~0.16	2.6~3.5	0.10~0.14	800	1.77	275	10.82	DC40V	90W	A B
■	EA-BN630PH/CE6	10~30	8.68~26.04	0.98~2.94	2000	1500	2.6~4.0	0.10~0.16	2.6~3.5	0.10~0.14	800	1.77	275	10.82	DC40V	90W	
■	EA-BN650P/CE6	20~50	17.36~43.4	1.96~4.90	1000	750	4.0~5.0	0.16~0.20	≤ 4	≤ 0.16	800	1.77	275	10.82	DC40V	120W	

•Screwdrivers come standard with bit type B HEX 6.35mm

•Note 1: Must be ordered with a power supply from page 13.

•Note 2: Color chart is used to match up screwdrivers with power supplies.

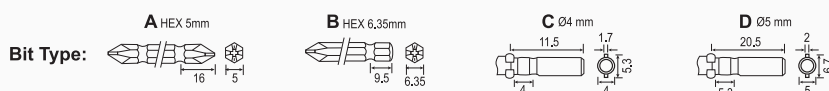

Premium Brushless DC Pistol Screwdriver

Medium Torque With Full Auto Shut Off Clutches

Torque Range 0.3~7 N.m



Top Cable Connection
EA-BTK620LU/CE6 - EA-BTK670LU/CE6



Bottom Cable Connection
EA-BTK620LD/CE6 - EA-BTK670LD/CE6



EPAA50006-B6P-6N
(For BTK620~BTK670)

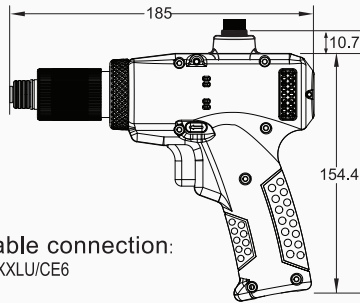

Top cable connection:
EA-BTK6XXLU/CE6

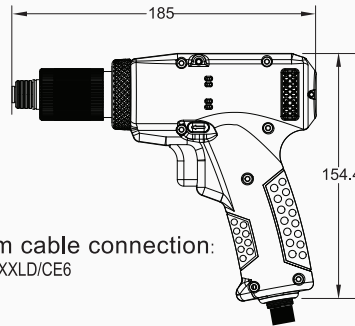

Bottom cable connection:
EA-BTK6XXLD/CE6

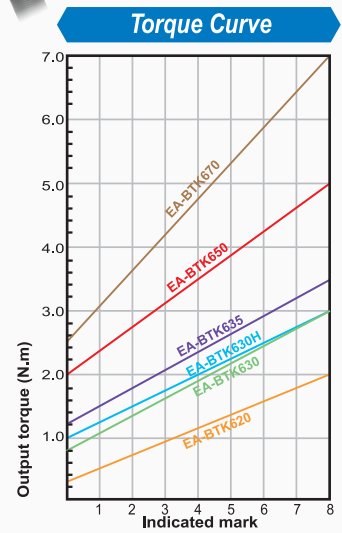

Specification:

Power Supply	Model No.	Torque Range $\pm 3\%$			Unloaded Speed $\pm 10\%$ (r.p.m.)		Available Screw				Net Weight		Overall Length		Power Source	Power Consumption	Bit Type
							Machine Screw (ϕ)		Tapping Screw (ϕ)								
		kgf-cm	lbf-in	N.m	High	Low	mm	in	mm	in	g	lb	mm	in			

Top Cable Connection

■	EA-BTK620LU/CE6	3.06~20.4	2.6~17.7	0.3~2.0	1200	900	2.3~3.5	0.09~0.13	2.3~3.0	0.09~0.12	700	1.54	185	7.28	DC40V	50W	A B
■	EA-BTK630LU/CE6	8.16~30.6	7.1~26.5	0.8~3.0	1200	900	2.6~4.0	0.10~0.15	2.6~3.5	0.10~0.13	700	1.54	185	7.28	DC40V	50W	
■	EA-BTK630LHU/CE6	10.2~30.6	8.9~26.5	1~3.0	3300	2480	2.0~4.0	0.08~0.15	2.0~3.5	0.08~0.13	700	1.54	185	7.28	DC40V	50W	
■	EA-BTK635LHU/CE6	12.24~35.7	10.68~32.04	1.2~3.5	1700	1280	2.6~4.0	0.10~0.15	2.6~3.5	0.10~0.13	700	1.54	185	7.28	DC40V	50W	
■	EA-BTK650LU/CE6	20.4~51	17.7~44.2	2~5	700	530	4.0~5.0	0.15~0.19	≤ 4	≤ 0.16	700	1.54	185	7.28	DC40V	50W	
■	EA-BTK650LHU/CE6	20.4~51	17.7~44.2	2~5	1000	750	4.0~5.0	0.15~0.19	≤ 4	≤ 0.16	700	1.54	185	7.28	DC40V	50W	
■	EA-BTK670LU/CE6	25.5~71.3	22.1~61.9	2.5~7	850	640	5.0~6.0	0.19~0.23	≤ 5	≤ 0.20	700	1.54	185	7.28	DC40V	50W	

Bottom Cable Connection

■	EA-BTK620LD/CE6	3.06~20.4	2.6~17.7	0.3~2.0	1200	900	2.3~3.5	0.09~0.13	2.3~3.0	0.09~0.12	700	1.54	185	7.28	DC40V	50W	A B
■	EA-BTK630LD/CE6	8.16~30.6	7.1~26.5	0.8~3.0	1200	900	2.6~4.0	0.10~0.15	2.6~3.5	0.10~0.13	700	1.54	185	7.28	DC40V	50W	
■	EA-BTK630LHD/CE6	10.2~30.6	8.9~26.5	1~3.0	3300	2480	2.0~4.0	0.08~0.15	2.0~3.5	0.08~0.13	700	1.54	185	7.28	DC40V	50W	
■	EA-BTK635LHD/CE6	12.24~35.7	10.68~32.04	1.2~3.5	1700	1280	2.6~4.0	0.10~0.15	2.6~3.5	0.10~0.13	700	1.54	185	7.28	DC40V	50W	
■	EA-BTK650LD/CE6	20.4~51	17.7~44.2	2~5	700	530	4.0~5.0	0.15~0.19	≤ 4	≤ 0.16	700	1.54	185	7.28	DC40V	50W	
■	EA-BTK650LHD/CE6	20.4~51	17.7~44.2	2~5	1000	750	4.0~5.0	0.15~0.19	≤ 4	≤ 0.16	700	1.54	185	7.28	DC40V	50W	
■	EA-BTK670LD/CE6	25.5~71.3	22.1~61.9	2.5~7	850	640	5.0~6.0	0.19~0.23	≤ 5	≤ 0.20	700	1.54	185	7.28	DC40V	50W	

- Screwdrivers come standard with bit type B HEX 6.35mm
- CE=W/CE Certificate & ESD Housing.
- Note 1: Must be ordered with a power supply from page 13.
- Note 2: Color chart is used to match up screwdrivers with power supplies.

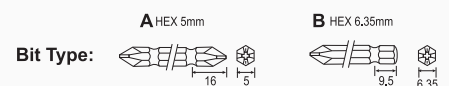

Premium Brushless DC Pistol Screwdriver

High Torque Full Auto Shut Off Clutches

Torque Range 2~18 N.m



Lever Start Type

Top cable connection

EA-BTN960LU/C6 - EA-BTN9180LU/C6

Bottom cable connection

EA-BTN960LD/C6 - EA-BTN9180LD/C6

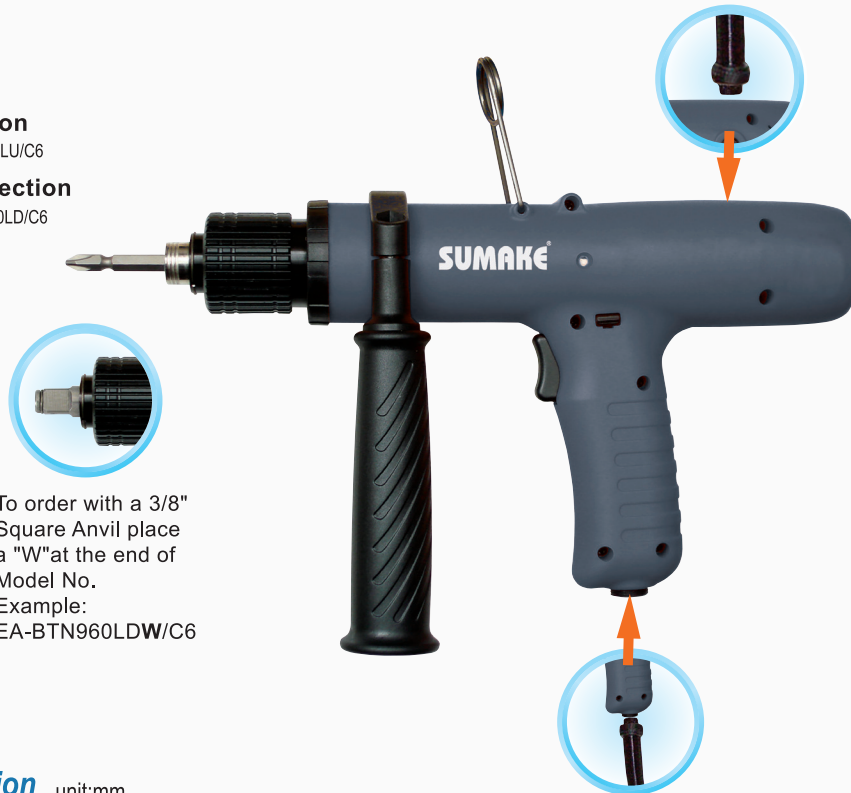

To order with a 3/8" Square Anvil place a "W" at the end of Model No.
Example:
EA-BTN960LDW/C6

External Dimension unit:mm

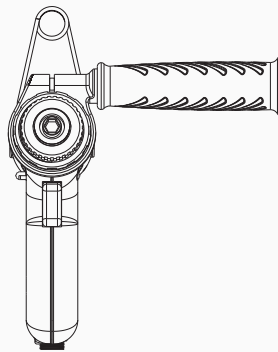
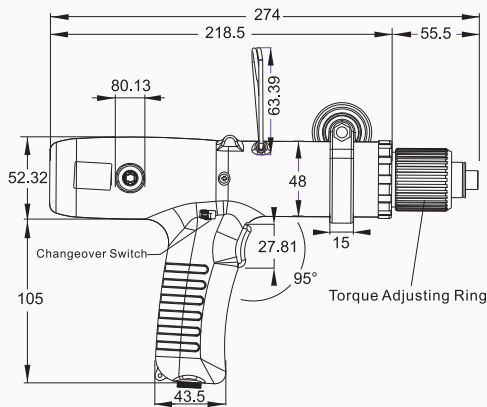

Torque Curve

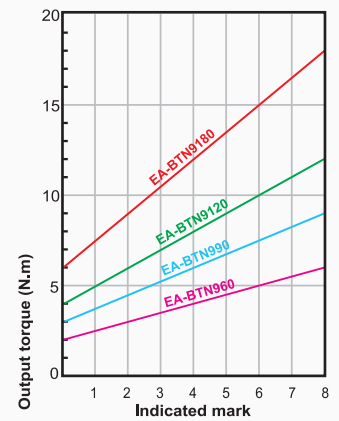

Specification:

Power Supply	Model No.	Torque Range ±5%			Unloaded Speed ±10% (r.p.m.)		Available Screw				Net Weight		Overall Length		Power Source	Power Consumption	Bit Type
							Machine Screw (ø)		Tapping Screw (ø)								
		kgf-cm	lbf-in	N.m	High	Low	mm	in	mm	in	g	lb	mm	in			

Top Cable Connection

■	EA-BTN960LU/C6	20.4~61.2	17.7~53.11	2~6	1000	750	4.0~5.0	0.16~0.20	≤4	≤0.16	1250	2.75	274x157	10.8x6.2	DC40V	100W	B
■	EA-BTN990LU/C6	30.6~91.8	26.55~79.66	3~9	800	600	5.0~6.0	0.20~0.23	≤4.5	≤0.18	1250	2.75	274x157	10.8x6.2	DC40V	120W	
■	EA-BTN9120LU/C6	40.8~122.4	35.4~106.21	4~12	550	410	≤6	≤0.23	≤5	≤0.20	1250	2.75	274x157	10.8x6.2	DC40V	120W	
■	EA-BTN9180LU/C6	61.2~183.6	53.11~159.32	6~18	350	260	≤8	≤0.31	≤6	≤0.23	1250	2.75	274x157	10.8x6.2	DC40V	200W	

Bottom Cable Connection

■	EA-BTN960LD/C6	20.4~61.2	17.7~53.11	2~6	1000	750	4.0~5.0	0.16~0.20	≤4	≤0.16	1250	2.75	274x157	10.8x6.2	DC40V	100W	B
■	EA-BTN990LD/C6	30.6~91.8	26.55~79.66	3~9	800	600	5.0~6.0	0.20~0.23	≤4.5	≤0.18	1250	2.75	274x157	10.8x6.2	DC40V	120W	
■	EA-BTN9120LD/C6	40.8~122.4	35.4~106.21	4~12	550	410	≤6	≤0.23	≤5	≤0.20	1250	2.75	274x157	10.8x6.2	DC40V	120W	
■	EA-BTN9180LD/C6	61.2~183.6	53.11~159.32	6~18	350	260	≤8	≤0.31	≤6	≤0.23	1250	2.75	274x157	10.8x6.2	DC40V	200W	

Screwdrivers come standard with bit type B HEX 6.35mm

●Note 1: Must be ordered with a power supply from page 13.

●Note 2: Color chart is used to match up screwdrivers with power supplies.



Premium Brushless DC Electric Screwdriver

High Torque Full Auto Shut Off

• Torque Range 2~25 N.m



Push to Start Type

EA-BK760P/C6 ~
EA-BK7120P/C6

Lever Start Type

EA-BK760L/C6 ~
EA-BK7120L/C6



Push to Start Type

EA-BAK960P/C6 ~
EA-BAK9250P/C6

Lever Start Type

EA-BAK960L/C6 ~
EA-BAK9250L/C6



Auxiliary Handle

EPC15001
(For EA-BK760~BK7120)

EPCF85002
(for EA-BAK960 ~ EA-BAK9250)



To order with a 3/8" Square Anvil place a "W" at the end of Model No. Example: EA-BK7120LW/C6

External Dimension unit:mm

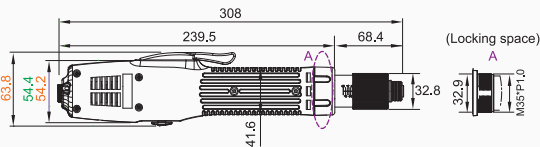

Lever Start Type
EA-BK760L/C6 ~ EA-BK7120L/C6

Push to Start Type
EA-BK760P/C6 ~ EA-BK7120P/C6

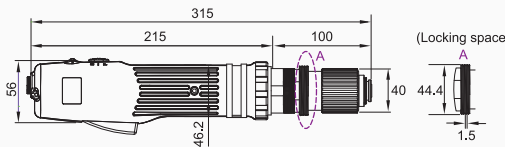

Lever Start Type
EA-BAK960L/C6 ~ EA-BAK9250L/C6

Push to Start Type
EA-BAK960P/C6 ~ EA-BAK9250P/C6

Torque Curve

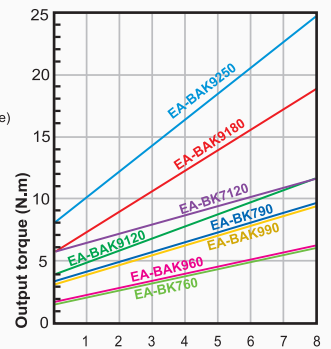

Specification:

Power Supply	Model No.	Torque Range ±5%			Unloaded Speed ±10% (r.p.m.)		Available Screw				Net Weight		Overall Length		Power Source	Power Consumption	Bit Type
		kgf-cm	lbf-in	N.m	High	Low	Machine Screw (ø)		Tapping Screw (ø)		g	lb	mm	in			
							mm	in	mm	in							

Top Cable Connection

■	EA-BK760L/C6	20.4~61.2	17.7~53.11	2~6	1000	750	4.0~5.0	0.16~0.20	≤4	≤0.16	1030	2.27	308	12.1	DC40V	150W
■	EA-BK760LH/C6	20.4~61.2	17.7~53.11	2~6	2000	1500	4.0~5.0	0.16~0.20	≤4	≤0.16	1030	2.27	308	12.1	DC40V	150W
■	EA-BK790L/C6	30.6~91.8	26.55~79.66	3~9	1000	750	≤6	≤0.23	≤5	≤0.19	1030	2.27	308	12.1	DC40V	150W
■	EA-BK7120L/C6	61.2~122.4	53.11~106.21	6~12	880	660	≤8	≤0.32	≤6	≤0.23	1030	2.27	308	12.1	DC40V	150W
■	EA-BAK960L/C6	20.4~61.2	17.7~53.11	2~6	1200	900	4.0~5.0	0.16~0.20	≤4	≤0.16	1250	2.75	315	12.4	DC40V	100W
■	EA-BAK990L/C6	30.6~91.8	26.55~79.66	3~9	900	680	5.0~6.0	0.20~0.23	≤4.5	≤0.18	1250	2.75	315	12.4	DC40V	120W
■	EA-BAK9120L/C6	40.8~122.4	35.4~106.21	4~12	600	450	≤8	≤0.32	≤6	≤0.23	1250	2.75	315	12.4	DC40V	120W
■	EA-BAK9120LH/C6	40.8~122.4	35.4~106.21	4~12	880	660	≤8	≤0.32	≤6	≤0.23	1250	2.75	315	12.4	DC40V	150W
■	EA-BAK9180L/C6	61.2~183.6	53.11~159.32	6~18	370	280	≤10	≤0.4	≤8	≤0.32	1250	2.75	315	12.4	DC40V	150W
■	EA-BAK9180LH/C6	61.2~183.6	53.11~159.32	6~18	600	450	≤10	≤0.4	≤8	≤0.32	1250	2.75	315	12.4	DC40V	150W
■	EA-BAK9250L/C6	81.6~255	70.81~221.28	8~25	370	280	≤10	≤0.4	≤8	≤0.32	1250	2.75	315	12.4	DC40V	150W

Push to Start Type

■	EA-BK760P/C6	20.4~61.2	17.7~53.11	2~6	1000	750	4.0~5.0	0.16~0.20	≤4	≤0.16	1030	2.27	308	12.1	DC40V	150W
■	EA-BK760PH/C6	20.4~61.2	17.7~53.11	2~6	2000	1500	4.0~5.0	0.16~0.20	≤4	≤0.16	1030	2.27	308	12.1	DC40V	150W
■	EA-BK790P/C6	30.6~91.8	26.55~79.66	3~9	1000	750	≤6	≤0.23	≤5	≤0.19	1030	2.27	308	12.1	DC40V	150W
■	EA-BK7120P/C6	61.2~122.4	53.11~106.21	6~12	880	660	≤8	≤0.32	≤6	≤0.23	1030	2.27	308	12.1	DC40V	150W
■	EA-BAK960P/C6	20.4~61.2	17.7~53.11	2~6	1200	900	4.0~5.0	0.16~0.20	≤4	≤0.16	1250	2.75	315	12.4	DC40V	100W
■	EA-BAK990P/C6	30.6~91.8	26.55~79.66	3~9	900	680	5.0~6.0	0.20~0.23	≤4.5	≤0.18	1250	2.75	315	12.4	DC40V	120W
■	EA-BAK9120P/C6	40.8~122.4	35.4~106.21	4~12	600	450	≤8	≤0.32	≤6	≤0.23	1250	2.75	315	12.4	DC40V	120W
■	EA-BAK9120PH/C6	40.8~122.4	35.4~106.21	4~12	880	660	≤8	≤0.32	≤6	≤0.23	1250	2.75	315	12.4	DC40V	150W
■	EA-BAK9180P/C6	61.2~183.6	53.11~159.32	6~18	370	280	≤10	≤0.4	≤8	≤0.32	1250	2.75	315	12.4	DC40V	150W
■	EA-BAK9180PH/C6	61.2~183.6	53.11~159.32	6~18	600	450	≤10	≤0.4	≤8	≤0.32	1250	2.75	315	12.4	DC40V	150W
■	EA-BAK9250P/C6	81.6~255	70.81~221.28	8~25	370	280	≤10	≤0.4	≤8	≤0.32	1250	2.75	315	12.4	DC40V	150W

•Screwdrivers come standard with bit type B HEX 6.35mm •CE=W/CE Certificate & ESD Housing. Example: For Tool W/ESD Model no. is EA-BKXXX/CE6, EA-BAKXXX/CE6.

•Note: High torque screwdriver should be ordered with an Auxiliary Torque Arm.

•Note: These drivers must be ordered with a power supply on page 13.

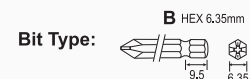

Premium Brushless DC Electric Screwdriver

High Torque Full Auto Shut Off

Torque Range 2~50 N.m



Angle-Lever Start Type

EA-BAKA950L/C6 ~
EA-BAKA9220L/C6

★With 3/8" Sq. Anvil
place "w" at the end of model No.
Example: EA-BAKA950LW/C6



Lever Start Type

EA-BAK9250LH/C6
EA-BAN9350L/C6

Push to Start Type

EA-BAK9250PH/C6
EA-BAN9350P/C6



Lever Start Type

EA-BAN9350LW/C6 w/3/8" Sq. Anvil
EA-BAN9500LW/C6 w/1/2" Sq. Anvil

Push to Start Type

EA-BAN9350PW/C6 w/3/8" Sq. Anvil
EA-BAN9500PW/C6 w/1/2" Sq. Anvil

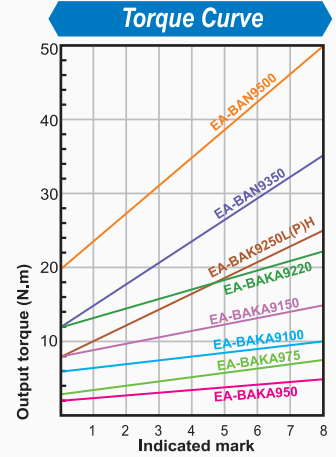

External Dimension unit:mm

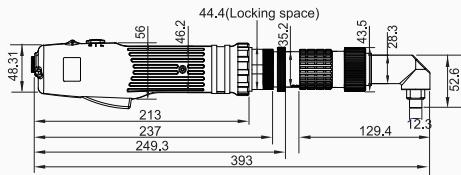

Lever Start Type
EA-BAKA950L/C6 ~ EA-BAKA9220L/C6

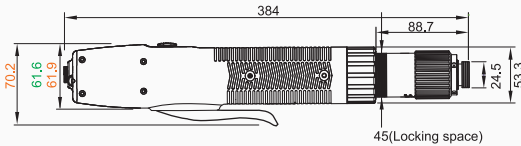

Lever Start Type
EA-BAK9250LH/C6 ~ EA-BAN9500LW/C6

Push to Start Type
EA-BAK9250PH/C6 ~ EA-BAN9500PW/C6

Specification:

Power Supply	Model No.	Torque Range ±5%			Unloaded Speed ±10% (r.p.m.)		Available Screw				Net Weight		Overall Length		Power Source	Power Consumption	Bit Type
		kgf-cm	lbf-in	N.m	High	Low	Machine Screw (ø)		Tapping Screw (ø)		g	lb	mm	in			

Angle -Lever Start Type

■	EA-BAKA950L/C6	20.4~51	17.7~44.25	2~5	1200	900	≤5	≤0.20	≤4	≤0.16	2500	5.5	393	15.4	DC40V	100W	B W (3/8")
■	EA-BAKA975L/C6	30.6~76.5	26.55~66.37	3~7.5	900	680	≤6	≤0.23	≤4.5	≤0.18	2500	5.5	393	15.4	DC40V	120W	
■	EA-BAKA9100L/C6	61.2~102	53.1~88.5	6~10	600	450	≤8	≤0.31	≤6	≤0.23	2500	5.5	393	15.4	DC40V	120W	
■	EA-BAKA9100LH/C6	61.2~102	53.1~88.5	6~10	880	660	≤8	≤0.31	≤6	≤0.23	2500	5.5	393	15.4	DC40V	150W	
■	EA-BAKA9150L/C6	81.6~153	70.8~132.75	8~15	370	280	≤10	≤0.39	≤8	≤0.31	2500	5.5	393	15.4	DC40V	150W	
■	EA-BAKA9150LH/C6	81.6~153	70.8~132.75	8~15	600	450	≤10	≤0.39	≤8	≤0.31	2500	5.5	393	15.4	DC40V	150W	
■	EA-BAKA9220L/C6	122.4~224.4	106.2~194.7	12~22	370	280	≤10	≤0.39	≤8	≤0.31	2500	5.5	393	15.4	DC40V	150W	

Lever Start Type

■	EA-BAK9250LH/C6	81.6~255	70.81~221.28	8~25	550	410	≤10	≤0.4	≤8	≤0.32	2200	4.84	380	15.1	DC40V	150W	B
■	EA-BAN9350L/C6	122.4~357	106.21~309.8	12~35	350	260	≤10	≤0.39	≤8	≤0.31	2200	4.84	380	15.1	DC40V	150W	
■	EA-BAN9350LW/C6	122.4~357	106.21~309.8	12~35	350	260	-	-	-	-	2300	5.06	384	15.1	DC40V	150W	W (3/8")
■	EA-BAN9500LW/C6	204~510	177~442.56	20~50	230	170	-	-	-	-	2200	4.84	380	15.1	DC40V	150W	W (1/2")

Push to Start Type

■	EA-BAK9250PH/C6	81.6~255	70.81~221.28	8~25	550	410	≤10	≤0.4	≤8	≤0.32	2200	4.84	380	15.1	DC40V	150W	B W (3/8")
■	EA-BAN9350P/C6	122.4~357	106.21~309.8	12~35	350	260	≤10	≤0.39	≤8	≤0.31	2200	4.84	380	15.1	DC40V	150W	
■	EA-BAN9350PW/C6	122.4~357	106.21~309.8	12~35	350	260	-	-	-	-	2300	5.06	384	15.1	DC40V	150W	W (3/8")
■	EA-BAN9500PW/C6	204~510	177~442.56	20~50	230	170	-	-	-	-	2200	4.84	380	15.1	DC40V	150W	W (1/2")

●CE=W/CE Certificate & ESD Housing. e.g. For Tool W/ESD Model no. is EA-BAKAXXX/CE6, EA-BANXXX/CE6

●Screwdrivers come standard with bit type B HEX 6.35mm

●Note: High torque screwdriver should be ordered with an Auxiliary Torque Arm.(see page.21)

●Note: These drivers must be ordered with a power supply on page 13.

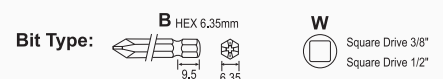

Premium Brushless Counter

DC Full Auto Electric Screwdriver

Feature

- Innovative Brushless motor design eliminates carbon dust and produces less vibration and noise which results in overall lower maintenance costs.
- Torque ranges from 0.02 ~ 4.9 Nm.
- Compact LED counter display and control unit: easy to setup and operate, provides the same functionality as our traditional power supply counter units
- User sets up the counter according to his/her specific requirements then leaves system in automatic mode to inspect and report on the precision of fastening the screws.
- Suitable for production lines, this counter effectively counts, controls, and reports back on the fastening operation; an additional subunit can be provided that allows external control/reporting via a PLC interface.
- Automatic learning can be used to assist the user in setting up the time ranges used to identify good and bad fastening times.
- Two-color housing, ergonomic design, easy to grip.
- Torque Accuracy $\pm 3\%$

Can be ordered with an ESD (Electrostatic discharge) housing with a grounded bit unit for circuit board assembly.

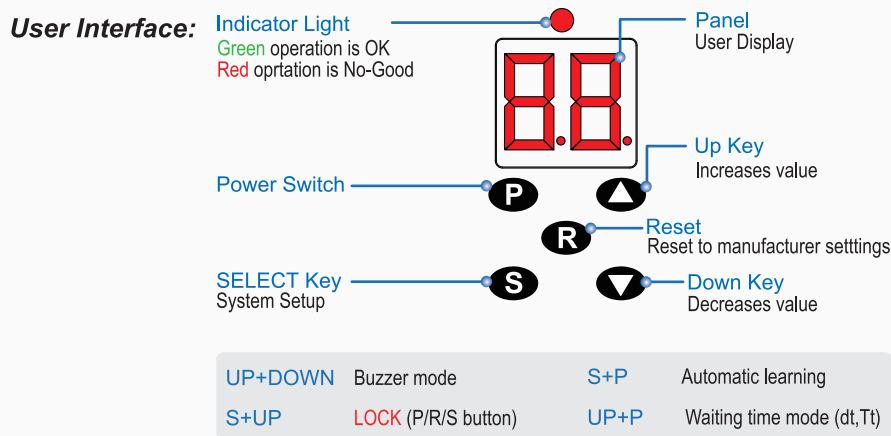

Specifications:

Function	Definition
1) Slow Start Function (For EA-BD2, EA-BD4)	Set to on or off
2) Slow Start Time Range (For EA-BD2, EA-BD4)	0 - 9.9 seconds
3) Slow Start Speed Setting (For EA-BD2, EA-BD4)	30 - 100% of screwdriver RPM
4) Count Function	Sets count up or count down
5) Count Range	1 - 99
6) Screw Time Window Min Acceptable Time	0.00 - 9.90 sec (0.01 increments)
7) Screw Time Window Max Acceptable Time	0.0 - 9.9 secs (0.1 increments)
8) Disable Screwdriver on no-good signal	Turns screwdriver off on bad torque signal
9) Reverse screw action	Determines counting action when a screw is reversed
10) Batch Jobs	1 - 5 jobs can be setup
11) Keypad Locked	Keypad can be locked so end user can not change settings

Output signal (open collector): OK ONE, OK ALL, NG

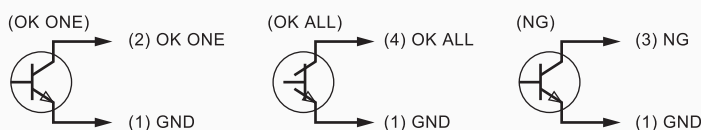

Process Chart:

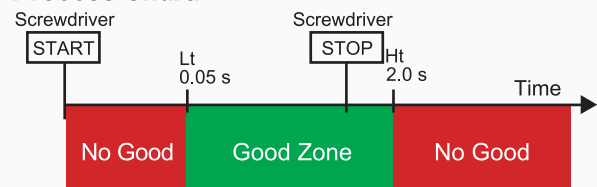

Brushless With Built-In Screw Counter

DC Full Auto Electric Screwdriver

Torque Range 0.02~4.9 N.m



Lever Start Type
EA-BD203L/CE6 ~ EA-BD210L/CE6
Push to Start Type
EA-BD210P/CE6



Lever Start Type
EA-BD412L/CE6 ~ EA-BD419L/CE6
Push to Start Type
EA-BD412P/CE6 ~ EA-BD419P/CE6



Lever Start Type
EA-BD630L/CE6 ~ EA-BD650L/CE6
Push to Start Type
EA-BD630P/CE6 ~ EA-BD650P/CE6

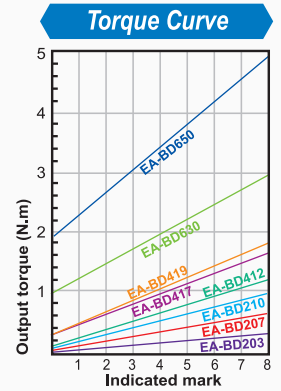

External Dimension unit:mm

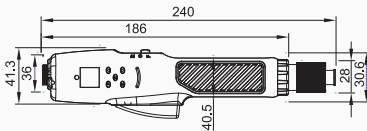

Lever Start Type
EA-BD203L/CE6 ~ EA-BD210L/CE6

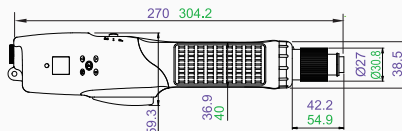

Lever Start Type
EA-BD412L/CE6 ~ EA-BD419L/CE6
EA-BD630L/CE6 ~ EA-BD650L/CE6

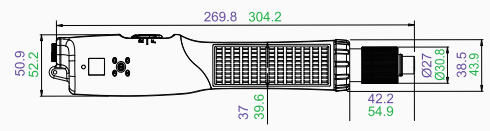

Push to Start Type
EA-BD412P/CE6 ~ EA-BD419P/CE6
EA-BD630P/CE6 ~ EA-BD650P/CE6

Specification:

Power Supply	Model No.	Torque Range $\pm 3\%$			Unloaded Speed $\pm 10\%$ (r.p.m.)		Available Screw				Net Weight		Overall Length		Power Source	Power Consumption	Bit Type	
		kgf-cm	lbf-in	N.m	High	Low	Machine Screw (ϕ)		Tapping Screw (ϕ)		g	lb	mm	in				
Lever Start Type																		
■	EA-BD203L/CE6	0.2~3.5	0.18~3.01	0.02~0.34	1000	700	1.0~2.3	0.04~0.09	1.0~2.0	0.04~0.08	300	0.66	240	9.45	DC24V/32V	25W	B C	
■	EA-BD203LS1/CE6	0.2~3.5	0.18~3.01	0.02~0.34	500	350	1.0~2.3	0.04~0.09	1.0~2.0	0.04~0.08	300	0.66	240	9.45	DC24V/32V	25W		
■	EA-BD207L/CE6	0.5~7	0.43~6.08	0.05~0.69	1000	700	1.4~2.6	0.06~0.10	1.4~2.3	0.06~0.09	300	0.66	240	9.45	DC24V/32V	25W		
■	EA-BD210L/CE6	1.0~10	0.87~8.68	0.10~0.98	1000	700	1.6~3.0	0.06~0.12	1.6~2.6	0.06~0.10	300	0.66	240	9.45	DC24V/32V	25W		
■	EA-BD412L/CE6	1.5~12	1.30~10.42	0.15~1.18	1000	700	1.6~3.0	0.06~0.12	1.6~2.6	0.06~0.10	580	1.28	270	10.63	DC24V/32V	55W	A B C D	
■	EA-BD412LH/CE6	1.5~12	1.30~10.42	0.15~1.18	2000	1400	1.6~3.0	0.06~0.12	1.6~2.6	0.06~0.10	580	1.28	270	10.63	DC32V	55W		
■	EA-BD417LH/CE6	3.0~17	2.60~14.76	0.29~1.67	2000	1400	2.3~3.5	0.09~0.14	2.3~3.0	0.09~0.12	580	1.28	270	10.63	DC32V	55W		
■	EA-BD419L/CE6	3.0~19	2.60~16.49	0.29~1.86	1000	700	2.3~3.5	0.09~0.14	2.3~3.0	0.09~0.12	580	1.28	270	10.63	DC24V/32V	55W		
■	EA-BD630L/CE6	10~30	8.68~26.04	0.98~2.94	1000	750	2.6~4.0	0.10~0.16	2.6~3.5	0.10~0.14	820	1.81	294	11.57	DC40V	90W	A B	
■	EA-BD630LH/CE6	10~30	8.68~26.04	0.98~2.94	2000	1500	2.6~4.0	0.10~0.16	2.6~3.5	0.10~0.14	820	1.81	294	11.57	DC40V	90W		
■	EA-BD650L/CE6	20~50	17.36~43.4	1.96~4.9	1000	750	4.0~5.0	0.16~0.20	≤ 4	≤ 0.16	820	1.81	294	11.57	DC40V	120W	B	
Push to Start Type																		
■	EA-BD210P/CE6	2.0~10	1.74~8.68	0.20~0.98	1000	700	1.6~3.0	0.06~0.12	1.6~2.6	0.06~0.10	310	0.68	230	9.06	DC24V/32V	25W	B C	
■	EA-BD412P/CE6	2.0~12	1.74~10.42	0.20~1.18	1000	700	1.6~3.0	0.06~0.12	1.6~2.6	0.06~0.10	580	1.28	270	10.63	DC24V/32V	55W		
■	EA-BD412PH/CE6	2.0~12	1.74~10.42	0.20~1.18	2000	1400	1.6~3.0	0.06~0.12	1.6~2.6	0.06~0.10	580	1.28	270	10.63	DC24V/32V	55W	A B C D	
■	EA-BD417PH/CE6	3.0~17	2.60~14.76	0.29~1.67	2000	1400	2.3~3.5	0.09~0.14	2.3~3.0	0.09~0.12	580	1.28	270	10.63	DC24V/32V	55W		
■	EA-BD419P/CE6	3.0~19	2.60~16.70	0.29~1.86	1000	700	2.3~3.5	0.09~0.14	2.3~3.0	0.09~0.12	580	1.28	270	10.63	DC24V/32V	55W	A B B	
■	EA-BD630P/CE6	10~30	8.68~26.04	0.98~2.94	1000	750	2.6~4.0	0.10~0.16	2.6~3.5	0.10~0.14	820	1.81	294	11.57	DC40V	90W		
■	EA-BD630PH/CE6	10~30	8.68~26.04	0.98~2.94	2000	1500	2.6~4.0	0.10~0.16	2.6~3.5	0.10~0.14	820	1.81	294	11.57	DC40V	90W		
■	EA-BD650P/CE6	20~50	17.36~43.4	1.96~4.9	1000	750	4.0~5.0	0.16~0.20	≤ 4	≤ 0.16	820	1.81	294	11.57	DC40V	120W	B	

•Screwdrivers come standard with bit type B HEX 6.35mm
•Note 1: Must be ordered with a power supply from page 13.

•Note 2: Color chart is used to match up screwdrivers with power supplies.

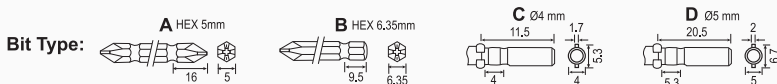

Premium Brushless DC Electric Screwdriver

Automation Assembly Applications

■ Torque Range 0.02~4.9 N.m



EAA-SCBSN6

Signal controller EAA-SCBSN6 is required for enabling/disabling the screwdriver in automation application.

External Dimension unit:mm

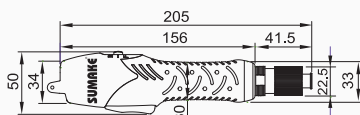

Lever Start Type
EA-BN203LA ~ EA-BN210LA

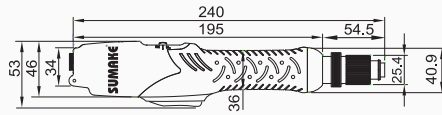

Lever Start Type
EA-BN412LA ~ EA-BN419LA

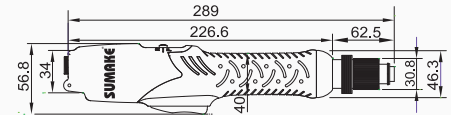

Lever Start Type
EA-BN630LA ~ EA-BN650LA

Specification:

Power Supply	Model No.	Torque Range $\pm 3\%$			Unloaded Speed $\pm 10\%$ (r.p.m.)		Available Screw				Net Weight		Overall Length		Power Source	Power Consumption	Bit Type
		kgf-cm	lbf-in	N.m	High	Low	Machine Screw (ϕ)		Tapping Screw (ϕ)		g	lb	mm	in			
							mm	in	mm	in							
	EA-BN203LA	0.2~3.5	0.17~3.04	0.02~0.34	1000	700	1.0~2.3	0.04~0.09	1.0~2.0	0.04~0.08	482	1.06	260	10.24	DC24V/32V	25W	B C
	EA-BN207LA	0.5~7	0.4~6.1	0.05~0.69	1000	700	1.4~2.6	0.056~0.11	1.4~2.3	0.056~0.09	482	1.06	260	10.24	DC24V/32V	25W	
	EA-BN210LA	1~10	0.9~8.7	0.1~0.98	1000	700	1.6~3.0	0.06~0.12	1.6~2.6	0.06~0.11	482	1.06	260	10.24	DC24V/32V	25W	
	EA-BN412LA	1.5~12	1.3~10.4	0.15~1.18	1000	700	1.6~3.0	0.06~0.12	1.6~2.6	0.06~0.11	740	1.63	323	12.71	DC24V/32V	55W	A B D
	EA-BN412LHA	1.5~12	1.3~10.4	0.15~1.18	2000	1400	1.6~3.0	0.06~0.12	1.6~2.6	0.06~0.11	740	1.63	323	12.71	DC24V/32V	55W	
	EA-BN417LHA	3.0~17	2.6~14.8	0.29~1.67	2000	1400	1.6~3.0	0.06~0.12	1.6~2.6	0.06~0.11	740	1.63	240	9.45	DC24V/32V	55W	
	EA-BN419LA	3.0~19	2.6~16.5	0.29~1.86	1000	700	2.3~3.5	0.09~0.14	2.3~3.0	0.09~0.12	740	1.63	323	12.71	DC24V/32V	55W	B
	EA-BN623LHA	8~23	6.9~19.9	0.78~2.25	3000	2250	2.6~4.0	0.11~0.16	2.6~3.5	0.11~0.14	950	2.09	289	11.38	DC40V	90W	
	EA-BN630LA	10~30	8.7~26	0.98~2.94	1000	750	2.6~4.0	0.11~0.16	2.6~3.5	0.11~0.14	950	2.09	289	11.38	DC40V	90W	
	EA-BN630LHA	10~30	8.7~26	0.98~2.94	2000	1500	2.6~4.0	0.11~0.16	2.6~3.5	0.11~0.14	950	2.09	289	11.38	DC40V	90W	B
	EA-BN650LA	20~50	17.3~43.4	1.96~4.90	1000	750	4.0~5.0	0.16~0.2	≤ 4	≤ 0.16	950	2.09	289	11.38	DC40V	120W	
	EA-BN203LAS-C	0.2~3.5	0.17~3.04	0.02~0.34	1000	700	1.0~2.3	0.04~0.09	1.0~2.0	0.04~0.08	482	1.06	260	10.24	DC24V/32V	25W	
	EA-BN207LAS-C	0.5~7	0.4~6.1	0.05~0.69	1000	700	1.4~2.6	0.056~0.11	1.4~2.3	0.056~0.09	482	1.06	260	10.24	DC24V/32V	25W	
	EA-BN210LAS-C	1~10	0.9~8.7	0.1~0.98	1000	700	1.6~3.0	0.06~0.12	1.6~2.6	0.06~0.11	482	1.06	260	10.24	DC24V/32V	25W	
	EA-BN412LAS-D	1.5~12	1.3~10.4	0.15~1.18	1000	700	1.6~3.0	0.06~0.12	1.6~2.6	0.06~0.11	740	1.63	323	12.71	DC24V/32V	55W	D
	EA-BN412LHAS-D	1.5~12	1.3~10.4	0.15~1.18	2000	1400	1.6~3.0	0.06~0.12	1.6~2.6	0.06~0.11	740	1.63	323	12.71	DC24V/32V	55W	
	EA-BN417LHAS-D	3.0~17	2.6~14.8	0.29~1.67	2000	1400	1.6~3.0	0.06~0.12	1.6~2.6	0.06~0.11	740	1.63	323	12.71	DC24V/32V	55W	
	EA-BN419LAS-D	3.0~19	2.6~16.5	0.29~1.86	1000	700	2.3~3.5	0.09~0.14	2.3~3.0	0.09~0.12	740	1.63	323	12.71	DC24V/32V	55W	B
	EA-BN623LHAS	8~23	6.9~19.9	0.78~2.25	3000	2250	2.6~4.0	0.11~0.16	2.6~3.5	0.11~0.14	950	2.09	289	11.38	DC40V	90W	
	EA-BN630LAS	10~30	8.7~26	0.98~2.94	1000	750	2.6~4.0	0.11~0.16	2.6~3.5	0.11~0.14	950	2.09	289	11.38	DC40V	90W	
	EA-BN630LHAS	10~30	8.7~26	0.98~2.94	2000	1500	2.6~4.0	0.11~0.16	2.6~3.5	0.11~0.14	950	2.09	289	11.38	DC40V	90W	B
	EA-BN650LAS	20~50	17.3~43.4	1.96~4.90	1000	750	4.0~5.0	0.16~0.2	≤ 4	≤ 0.16	950	2.09	289	11.38	DC40V	120W	

•Screwdrivers come with standard bit type B HEX 6.35mm, and ESD housing.

•Note 1: Must be ordered with a power supply from page 13.

•Note 2: Color chart is used to match up screwdriver with power supply.

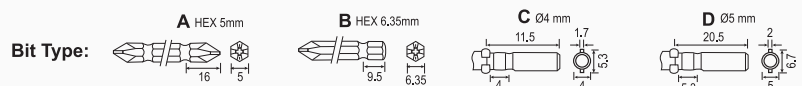

Premium Brushless DC Electric Screwdriver

Automation Assembly Applications With Vacuum Pick-Up



Lever Start Type
EA-BN203LAS-C ~ EA-BN210LAS-C

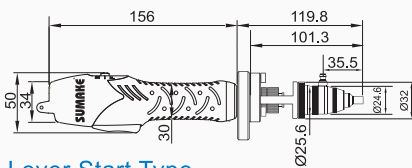

Lever Start Type
EA-BN203LAS-C ~ EA-BN210LAS-C



Lever Start Type
EA-BN412LAS-D ~ EA-BN419LAS-D

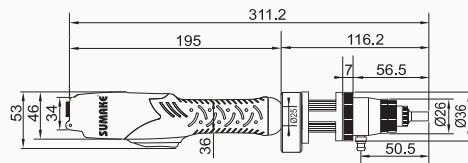

Lever Start Type
EA-BN412LAS-D ~ EA-BN419LAS-D



Lever Start Type
EA-BN623LHAS ~ EA-BN650LAS

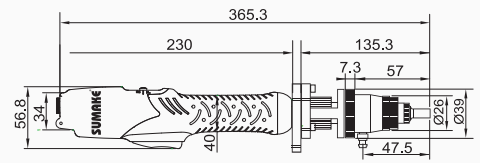

Lever Start Type
EA-BN623LHAS ~ EA-BN650LAS

Option & Accessory:



Vacuum Pump
EAP-200A/C 110-120V
EAP-200E/C 220-240V



Flange for Robot
EPE31700-3

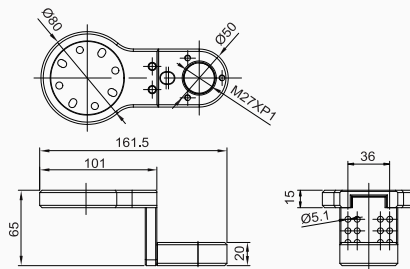
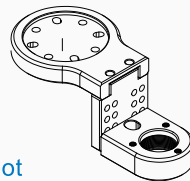

Nosepiece Sizes: unit: mm

Suction Head Model (d2)		Nosepiece		d1Ø	d2Ø	DØ	H	Bit Type	Part No.			
									Bits No.	P x Ød x Mini L1 x L		
EA-BN2XXLAS												
	A	EPSH-B2A-3.2-C			EPP11032-7	2.2	3.2	4.2	1.3		PH001580E4	00 x Ø1.5 x 25 x 80
	B	EPSH-B2A-4.2-C			EPP11032-8	2.7	4.2	5.2	1.3		PH002080E4	00 x Ø2.0 x 25 x 80
	C	EPSH-B2A-5.0-C			EPP11032-9	3.2	5.0	6.0	1.3		PH02080E4	0 x Ø2.0 x 25 x 80
	D	EPSH-B2A-5.5-C			EPP11032-10	3.5	5.5	6.5	1.3		PH13080E4	1 x Ø3.0 x 25 x 80
EA-BN4XXLAS, EA-BN4XXLHAS												
	A	EPSH-B4A-5.5-D			EPP11032-15	3.5	5.5	6.5	2		PH23080E5	2 x Ø3.0 x 25 x 80
	B	EPSH-B4A-6.5-D			EPP11032-17	4.5	6.5	7.5	2		PH24080E5	2 x Ø4.0 x 25 x 80
	C	EPSH-B4A-7.5-D			EPP11032-18	5.5	7.5	8.5	2		PH25080E5	2 x Ø5.0 x 25 x 80
EA-BN6XXLAS, EA-BN6XXLHAS												
	A	EPSH-B6A-5.5			EPP11032-15	3.5	5.5	6.5	2		PH23075B1	2 x Ø3.0 x 25 x 75
	B	EPSH-B6A-6.5			EPP11032-17	4.5	6.5	7.5	2		PH24075B1	2 x Ø4.0 x 25 x 75
	C	EPSH-B6A-7.5			EPP11032-18	5.5	7.5	8.5	2		PH25075B1	2 x Ø5.0 x 25 x 75

Premium Brushless DC Electric Screwdriver

With Vacuum Pickup

Features:

- Works with EA-BN203 ~ EA-BN650 brushless series screwdriver.
- Ideal for non-magnetic screws for example plastic, aluminum, and stainless steel screws.
- Match Screw size to vacuum pick-up adaptor.
- Works on screw head diameters between 3.2 ~ 7.5 mm.



Vacuum Pump

EAP-200A/C 110-120V
EAP-200E/C 220-240V



External Dimension unit:mm

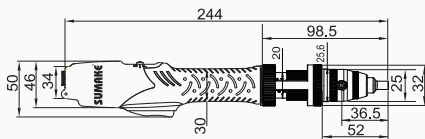

Lever Start Type
EA-BN2

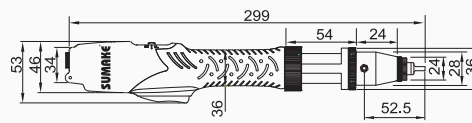

Lever Start Type
EA-BN4

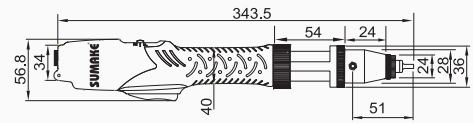

Lever Start Type
EA-BN6

Nosepiece Sizes: unit: mm

Suction Head Model (d2)	Nosepiece	d1Ø	d2Ø	DØ	H	Bit Type	Part No.		
							Bits No.	P x Ød x Mini L1 x L	
EA-BN2, EA-BD2									
EPP11032-7		2.2	3.2	4.2	1.3	HEX6.35	PH001575B1	00 x Ø1.5 x 25 x 75	
EPP11032-8						Ø4	PH001760E4	00 x Ø1.7 x 25 x 60	
EPP11032-9		2.7	4.2	5.2	1.3	HEX6.35	PH002075B1	00 x Ø2.0 x 25 x 75	
EPP11032-10						Ø4	PH02060E4	0 x Ø2.0 x 25 x 60	
EPP11032-15			3.2	5.0	6.0	1.3	HEX6.35	PH02575B1	0 x Ø2.5 x 25 x 75
EPP11032-17							Ø4	PH12560E4	1 x Ø2.5 x 25 x 60
EPP11032-18			3.5	5.5	6.5	1.3	HEX6.35	PH13075B1	1 x Ø3.0 x 25 x 75
EPP11032-15							Ø4	PH13060E4	1 x Ø3.0 x 25 x 60
EA-BN4, EA-BN4H, EA-BD4, EA-BD4H									
EPP11032-15			3.5	5.5	6.5	2	HEX6.35	PH23075B1	2 x Ø3.0 x 25 x 75
EPP11032-17		Ø5					PH23080E5	2 x Ø3.0 x 25 x 80	
EPP11032-18		4.5	6.5	7.5	2	HEX6.35	PH24075B1	2 x Ø4.0 x 25 x 75	
EPP11032-15						Ø5	PH14080E5	1 x Ø4.0 x 25 x 80	
EPP11032-17		5.5	7.5	8.5	2	HEX6.35	PH25075B1	2 x Ø5.0 x 25 x 75	
EPP11032-18						Ø5	PH25080E5	2 x Ø5.0 x 25 x 80	
EA-BN6, EA-BN6H, EA-BD6, EA-BD6H									
EPP11032-15		3.5	5.5	6.5	2	HEX6.35	PH23075B1	2 x Ø3.0 x 25 x 75	
EPP11032-17							PH24075B1	2 x Ø4.0 x 25 x 75	
EPP11032-18		PH25075B1	2 x Ø5.0 x 25 x 75						

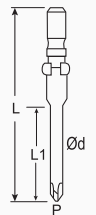

To Order:

- Determine Screwdriver (pages 1, 2, 8).
- Determine Suction Head by screwdriver size and nosepiece size.
- Order all parts: Screwdriver, Suction Head, Power Supply, and Vacuum Pump.



TIGHTENING SOLUTION and ADVANCED ERROR PROOFING



SUMAKE

Advanced JOB-101
Sequence Status 2023/08/15 17:59:36

TS 1 1 1 Name: SEQ-1 TR 1 1 4

Step 1

Tightening Result

Nm	Target Torque 1.0
1.05	High Torque 1.1
	Low Torque 0.9
Degree	Target Angle 20
21	High Angle 360
	Low Angle 60

OK-JOB

Enable Disable Eject Clear End Cycle

Input: [0] [1] [2] [3] [4] [5] [6] [7] [8] [9] [A] [B] [C] [D] [E] [F] Output: [0] [1] [2] [3] [4] [5] [6] [7] [8] [9] [A] [B] [C] [D] [E] [F]

SUMAKE













SMT-CP

SUMAKE

Brushless Power Supply Table

Industrial

Model	Operating vol. (AC)	Output vol. (DC)	Output Capacity	Dimension (LxWxH) (mm)	Weight (Kgs)	Approval	N° Pin	Recommend Model
Power Supply								
1	 SP-B12HL30T/C3	100V-240V	9V;12V	Low/Hi Max 2.5A	100x50x30	0.14	ETL, CE, RoHS	 3 PIN 
2	 SP-B32HL61T/C6	100V-240V	24V;32V	Low/Hi Max 1.8A	145x61x35	0.25	ETL, CE, RoHS	 6 PIN 
3	 SP-B32HL62T/C6	100V-240V	24V;32V	Low/Hi Max 3A	200x80x66	0.46	ETL, CE, RoHS	 6 PIN 
4	 SP-B40HL501T/C6 HI / LO Speed Switch	100V-240V	30V;40V	Low/Hi Max 5A	213x133x68	2.15	ETL, CE, RoHS	 6 PIN 
5	 SP-B40HL801T/C6 HI / LO Speed Switch	115V / 230V	30V;40V	Low/Hi Max 9A	213x133x68	1.94	ETL, CE, RoHS	 6 PIN 
Power Supply Integrate with Screw Counter								
6	 SP-BC32HL101T/C6 (V4.0)	100V-240V	24V;32V	Low/Hi 1.875A	201x130x100	2	ETL, CE, RoHS	 6 PIN 
7	 SP-BC40HL501T/C6 (V4.0)	100V-240V	24V; 32V;40V	Low/Hi 5.5A	247x130x100	2.4	ETL, CE, RoHS	 6 PIN 
8	 SP-BC40HL801T/C6 (V4.0)	115V / 230V	24V; 32V;40V	Low/Hi Max 9A	247x130x100	2.4	ETL, CE, RoHS	 6 PIN 
Signal Controller							For more details, pls refer to P.23	
11	 EAA-SCBSN6	-	-	-	110x92x33	0.2	Must order with the power supply	 6 PIN 
Slow Start								
12	 EAA-SSBN6 (Slow Start)	-	-	-	85x55x35	0.13	Must order with the power supply	 6 PIN 

Page	Recommend Model	Page	Recommend Model	Page	Recommend Model	Page	Recommend Model
P1	 EA-B1  EA-BN2	P2	 EA-BN4H  EA-BN6	P4	 EA-BTN9	P10	 EA-BD2 / EA-BD4
P2	 EA-BN4	P3	 EA-BTK6  EA-BTK6H	P5	 EA-BK7, EA-BAK9		 EA-BD4 H
				P6	 EA-BAKA9, EA-BAN9		 EA-BD6

•Note: Power supplies come with power cable and must be matched with a screwdriver on page 1 - 11.



Brushless Power Supply & Signal Controller

Integrated With Screw Counting



PLC Signal Input /Output function for control screwdriver:

External inputs : Forward/Reverse/Disable/Confirm/Sensor/Clear
External outputs : OK/NG/OK ALL

Model No.	 SP-BC32HL101T/C6 (V4.0)	 SP-BC40HL501T/C6 (V4.0)	 SP-BC40HL801T/C6 (V4.0)
Suitable model (High speed models are available)	EA-BN203~EA-BN419	EA-BN203~EA-BN650 EA-BTK620~EA-BTK650	EA-BK760~EA-BAK9250 EA-BTN960~EA-BAN9500
Input voltage	AC 100-240V 50/60HZ	AC 100-240V 50/60HZ	115V/50HZ, 230V/60HZ
Output voltage	DC 32V; 24V	DC 40V; 32V; 24V	DC 40V; 32V; 24V
Output watt	60W	220W	360W
Count	1-99		
Count method	Count-up / Count-down		
Work with sensor	ON / OFF		
GATE sensor	ON (2 Sensor) / OFF (1 Sensor)		
Slow-start time adjustable	0.1~9.9 seconds		
Slow-start speed adjustable	LO: 100%, L1-L9 Rated Speed 35-85%		
Running time limit-LO	0.0-9.9 seconds		
Running time limit-HI	0.0-9.9 seconds		
NG alarm	On / Off / FF / EF with LED and buzzer		
OK alarm	On / Off / FF / EF with LED and buzzer		
Auto ZERO	ON/OFF		
External inputs	Forward / Reverse / Disable / Confirm / Sensor / Clear		
External outputs	OK / NG / OK ALL		
Screwdriver control	SPEED:HI / LO : SLOW START		
Outside dimensions	200 x 130x 100(mm)	247 x 130 x 100(mm)	247 x 130 x 100(mm)

EAA-SCBSN6 Signal Controller

Suitable all BN screwdrivers

Output Display lights

Shows the status of output signals

Input Display lights

Shows the status of input signals

Output Display and Input Buttons

UP/DOWN input push buttons.
LED display used to setup parameters (for example slow start and run-time parameters).

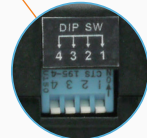

DIP Switch

Used to control specific I/O functions

Features

- Slow Start Time Adjustment (0 - 9.9 sec)
- Slow Start Speed Adjustment (30 - 100% RPM)
- Maximum Run Time Setting (0 - 9.9 sec)

Overview

The Signal Control connects between the screwdriver and the power supply. It allows the user to set up slow start functionality as well as I/O communication with the screwdriver.

Inputs (Dry Contacts):

Remotely Start Screwdriver in Forward
Remotely Start Screwdriver in Reverse
Remotely Enable/Disable Screwdriver

Outputs (Relay):

Screwdriver Started
Screwdriver Running
Screwdriver's Clutch Engaged
Screwdriver in Reverse

AC Electric Screwdriver Direct Plug In

Brushless Low To Medium Torque Full Auto Shut-Off

■ Torque Range 0.15~4.9 N.m



Lever Start Type

110V

ED-B512L1
ED-B512LH1 High Speed
ED-B517LH1 High Speed
ED-B522L1



Push to Start Type

110V

ED-B512P1
ED-B512PH1 High Speed
ED-B517PH1 High Speed
ED-B522P1



Lever Start Type

110V

ED-B625L1
ED-B625LH1 High Speed
ED-B650L1



Push to Start Type

110V

ED-B625P1
ED-B625PH1 High Speed
ED-B650P1

220V

ED-B512L2
ED-B512LH2 High Speed
ED-B517LH2 High Speed
ED-B522L2

220V

ED-B512P2
ED-B512PH2 High Speed
ED-B517PH2 High Speed
ED-B522P2

220V

ED-B630L2
ED-B630LH2 High Speed
ED-B650L2

220V

ED-B630P2
ED-B630PH2 High Speed
ED-B650P2

Specifications :

Model No.	Torque Range ±3%			Uploaded Speed ±10% (r.p.m.)	Available Screw				Net Weight		Overall Length		Power Source	Bit Type
					Machine Screw (φ)		Tapping Screw (φ)							
	kgf-cm	lbf-in	N.m		mm	in	mm	in	g	lb	mm	in		

Lever Start Type

ED-B512L1/C	1.5~12	1.30~10.42	0.15~1.18	1200	1.6~3.0	0.06~0.12	1.6~2.6	0.06~0.10	470	1.03	245	9.65	AC110~120V 50/60Hz	A C D F
ED-B512LH1/C	1.5~12	1.30~10.42	0.15~1.18	2000	1.6~3.0	0.06~0.12	1.6~2.6	0.06~0.10	470	1.03	245	9.65		
ED-B517LH1/C	3.0~17	2.56~14.76	0.29~1.67	2000	1.6~3.5	0.06~0.14	1.6~3.0	0.06~0.12	470	1.03	245	9.65		
ED-B522L1/C	4.0~22	3.47~19.10	0.39~2.16	1200	2.3~4.0	0.09~0.16	2.3~3.5	0.09~0.14	470	1.03	245	9.65	AC220~240V 50/60Hz	A F
ED-B512L2	1.5~12	1.30~10.42	0.15~1.18	1200	1.6~3.0	0.06~0.12	1.6~2.6	0.06~0.10	470	1.03	245	9.65		
ED-B512LH2	1.5~12	1.30~10.42	0.15~1.18	2000	1.6~3.0	0.06~0.12	1.6~2.6	0.06~0.10	470	1.03	245	9.65		
ED-B517LH2	3.0~17	2.56~14.76	0.29~1.67	2000	1.6~3.5	0.06~0.14	1.6~3.0	0.06~0.12	470	1.03	245	9.65	AC110~120V 50/60Hz	A F
ED-B522L2	4.0~22	3.47~19.10	0.39~2.16	1200	2.3~4.0	0.09~0.16	2.3~3.5	0.09~0.14	470	1.03	245	9.65		
ED-B625L1/C	5~25	4.34~21.70	0.49~2.45	1000	2.6~4.0	0.10~0.16	2.6~3.5	0.10~0.14	500	1.10	285	11.2		
ED-B625LH1/C	5~25	4.34~21.70	0.49~2.45	2000	2.6~4.0	0.10~0.16	2.6~3.5	0.10~0.14	500	1.10	285	11.2	AC220~240V 50/60Hz	A F
ED-B650L1/C	20~50	17.36~43.40	1.96~4.9	1000	4.0~5.0	0.16~0.20	≤4	≤0.16	810	1.78	305	12.0		
ED-B630L2/C	10~30	8.68~26.04	0.98~2.94	1200	2.6~4.0	0.10~0.16	2.6~3.5	0.10~0.14	810	1.78	305	12.0		
ED-B630LH2/C	10~30	8.68~26.04	0.98~2.94	2000	2.6~4.0	0.10~0.16	2.6~3.5	0.10~0.14	810	1.78	305	12.0	AC220~240V 50/60Hz	A F
ED-B650L2/C	20~50	17.36~43.40	1.96~4.9	1000	4.0~5.0	0.16~0.20	≤4	≤0.16	810	1.78	305	12.0		

Push to Start Type

ED-B512P1/C	2~12	1.74~10.42	0.2~1.18	1200	1.6~3.0	0.06~0.12	1.6~2.6	0.06~0.10	470	1.03	245	9.65	AC110~120V 50/60Hz	A C D F
ED-B512PH1/C	2~12	1.74~10.42	0.2~1.18	2000	1.6~3.0	0.06~0.12	1.6~2.6	0.06~0.10	470	1.03	245	9.65		
ED-B517PH1/C	3.0~17	2.56~14.76	0.29~1.67	2000	1.6~3.5	0.06~0.14	1.6~3.0	0.06~0.12	470	1.03	245	9.65		
ED-B522P1/C	4.0~22	3.47~19.10	0.39~2.16	1200	2.3~4.0	0.09~0.16	2.3~3.5	0.09~0.14	470	1.03	245	9.65	AC220~240V 50/60Hz	A C D F
ED-B512P2	2~12	1.74~10.42	0.2~1.18	1200	1.6~3.0	0.06~0.12	1.6~2.6	0.06~0.10	470	1.03	245	9.65		
ED-B512PH2	2~12	1.74~10.42	0.2~1.18	2000	1.6~3.0	0.06~0.12	1.6~2.6	0.06~0.10	470	1.03	245	9.65		
ED-B517PH2	3.0~17	2.56~14.76	0.29~1.67	2000	1.6~3.5	0.06~0.14	1.6~3.0	0.06~0.12	470	1.03	245	9.65	AC110~120V 50/60Hz	A F
ED-B522P2	4.0~22	3.47~19.10	0.39~2.16	1200	2.3~4.0	0.09~0.16	2.3~3.5	0.09~0.14	470	1.03	245	9.65		
ED-B625P1/C	5~25	4.34~21.70	0.49~2.45	1000	2.6~4.0	0.10~0.16	2.6~3.5	0.10~0.14	500	1.10	285	11.2		
ED-B625PH1/C	5~25	4.34~21.70	0.49~2.45	2000	2.6~4.0	0.10~0.16	2.6~3.5	0.10~0.14	500	1.10	285	11.2	AC220~240V 50/60Hz	A F
ED-B650P1/C	20~50	17.36~43.40	1.96~4.9	1000	4.0~5.0	0.16~0.20	≤4	≤0.16	810	1.78	305	12.0		
ED-B630P2/C	10~30	8.68~26.04	0.98~2.94	1200	2.6~4.0	0.10~0.16	2.6~3.5	0.10~0.14	810	1.78	305	12.0		
ED-B630PH2/C	10~30	8.68~26.04	0.98~2.94	2000	2.6~4.0	0.10~0.16	2.6~3.5	0.10~0.14	810	1.78	305	12.0	AC220~240V 50/60Hz	A F
ED-B650P2/C	20~50	17.36~43.40	1.96~4.9	1000	4.0~5.0	0.16~0.20	≤4	≤0.16	810	1.78	305	12.0		

● Model number with "C" = AC110~120V with ETL certificate, and AC220~240V with CE certificate.
● Screwdrivers come standard with bit type F HEX 6.35mm

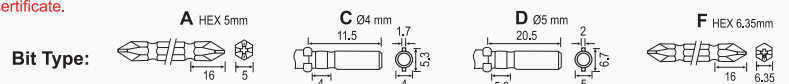

Torque Meter

For Air / Electric Screwdrivers

Features

- Ideal for clutched torque screwdrivers.
- Comes with Torque Certification, AC Charger, Run Down Nut, and a case.
- User can set min and max test torque ranges and will be notified if torque reading falls outside of test range.
- USB 1.0 connector allows data output to computer. (TM-015A, TM-150A)
- Auto-zero option.
- Rechargeable Battery.
- Store up 800 readings.
- Available measurement units: lbs-in, kgF-cm, Nm.
- Works in both clockwise and counterclockwise.

TM-250A
For Auto Shut-off



TM-015A TM-150A
For Auto Shut-off



TM-S50
For Semi-Auto shut off
& Cushion Type Electric Screwdriver









Additional TM-1000 Features

- Full color LCD touch screen.
- Processes statistical calculations: CP, CPK, Sigma
- Torque graphing capabilities.
- Export data via USB or save to SD card.
- Automatic screen rotation to support Pistol Drivers.
- Provides the ability to quickly audit and verify a tool.
- Units: in.oz, in.lb, ft.lb, Nm, cNm, kgF.cm, gF.cm, kgF.m



TM-1000
For Auto-Shut off

Standard Joint Specifications

Model No.							
	SJ-03A	SJ-15A	SJ-15AK	SJ-50A	SJ-150A	SJ-250A	SJ-50S
Measuring Range (N.m)	0.015 ~ 0.3	0.3 ~ 1.5	0.3 ~ 1.5	1.5 ~ 5.0	5.0 ~ 15.0	5.0 ~ 25.0	0.05 ~ 5.0
HEX size(mm)(for bit) 	5	5	6	6	17	19	6
Applicable Models	TM-015A	TM-015A	TM-150A	TM-150A	TM-150A	TM-250A	TM-S50

Model No.	Measuring Range			Accuracy	Recharge Time	Power Supply	Continuous Operation At Full Charge	Battery Life	Dimension (mm) (WxDxH)	Net Weight (kg)	Special Charger			
	kgf-cm	lbf-in	N.m								Input	Output		
TM-015A	0.15-15	0.15-13	0.015-1.5	±0.5%	8hrs	1.2V battery*5	About 30 hours	Rechargeable 300 times	123x230x65 230x125x65	1.8	AC 100V 220-240V	DC 12V 500mA		
TM-150A	1.5-150	1.5-130	0.15-15											
TM-250A	3.0-250	3.0-217	0.3-25								160x210x45	2.0	AC 100V 220-240V	DC 7.2V 120mA
TM-S50	0.5-50	0.44-44	0.05-5											

Model No.	Measuring Range			Input Drive (Female)	Accuracy	Dimension (mm) (WxDxH)	Net Weight (kg)	Housing Material	Overload (Displays at 110%+)	Included Accessories
	kgf-cm	lbf-in	N.m							
TM-1000	50-1000	45-885	5-100	1/2" Dr.	±0.5%	229 x 102 x 80	2.7	Aluminum	150% of full scale	Torque Measuring Adapter x1 SJ1000

SFR50/SF60 Automatic Screw Feeder

For Industrial

Features:

- Adjustable rail accommodates screw thread diameters from 1.0-5.0mm. A rail adjustment kit is included with the feeder to facilitate quick and easy setup.
- Adjustable vibration time, amplitude, and operation shut-off delay allows for optimal feed rates.
- Single rail accommodates all screw sizes.
- Max screw length: 19mm (under head)
- Compact and light weight.



Standard Accessories

	Allen Wrench -L Shaped 2.0 x 108mm		Screw stopper: 1.0-2.0mm - 1 pc 2.0-5.0mm - 1 pc
	earth wire		Meters: 0.8mm - 1 pc 1.0mm - 1 pc 1.2mm - 1 pc 1.5mm - 1 pc 2.0mm - 1 pc
	Bit		Spec. slice on rear of the rail: 0.2mm - 2 pcs 0.5mm - 10 pcs

Features:

- Ideal for integration with automated screwing systems or vacuum pick-up screwdrivers.
- Adjustable rail fits screw size from M1.2 to M5.0, screw length ≤12.5mm and screw head ≤7mm.
- Made with Industrial Brushless Motors.
- Integrated screw counting and screw shortage warning systems.
- Patent design for screw feeding smoothly.

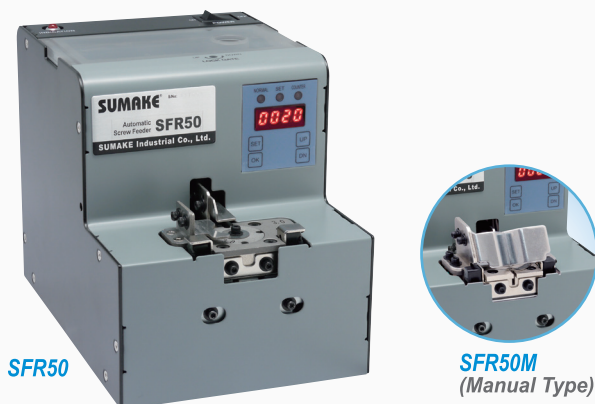

Standard Accessories

	Allen Wrench - L Shaped 2.0 x 108mm
	Spec. slice on front of the rail: 0.2mm - 2 pcs 0.5mm - 10 pcs
	Spec. slice on rear of the rail: 0.2mm - 2 pcs 0.5mm - 10 pcs

Specifications :

Model No.	Applicable Screw	Applicable Screw length	Switching Adaptor	Horizontal Delivery Speed	Power Source	Feeding	Scooping Chamber Capacity	Counter	Dimension L x W x H(mm)	Net Weight (Kg)
SF60	M1.0 ~ M5.0	Up to 19mm (under head)	DC 15V	46~60 pcs/min (0.76~1/sec)	AC 100~240V	Chamber blanking	200~220 cc	X	182 x 126 x 147	N.W. : Approx 2.17 (excluding switching adaptor)
SFR50	M1.2 ~ M5.0	Up to 10mm (under head)	DC 12 V	42~90 pcs/min (0.67~1.43/sec)	AC 100~240V	Chamber blanking	200~220 cc	○	182 x 124 x 150	3.1 (w/o adapter)
SFR50M	M1.2 ~ M5.0	Up to 10mm (under head)	DC 12 V	42~90 pcs/min (0.67~1.43/sec)	AC 100~240V	Chamber blanking	200~220 cc	○	182 x 124 x 150	3.1 (w/o adapter)

SFR20/SFR20M/SFR30 Automatic Screw Feeder

Industrial

Features:

- Ideal for integration with automated screwing systems or vacuum pick-up screwdrivers.
- Made with Industrial Brushless Motors.
- Adjustable rail fits screw head sizes from 1.2 - 9.5 mm and screw lengths from 1 - 15 mm.
- Horizontal linear feeding system increases access to screw head.
- Integrated screw counting and screw shortage warning systems.
- PCB signal output allows full production line integration.

Ideal For Integrating with An Automated Screwdriving System



SFR30



Applicable Screw

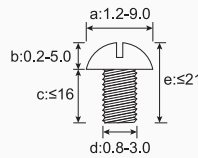

SFR20



SFR20M
(Manual Type)

Applicable Screw

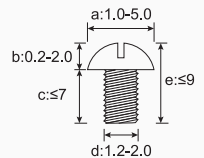

Standard Accessories(SFR30)



Allen Wrench - L Shaped
2.0 x 108mm



Spec. slice on rear of the rail:
0.2mm - 1 pcs
0.5mm - 2 pcs

Standard Accessories



Allen Wrench - L Shaped
2.0 x 108mm

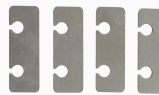

Spec. slice on front of the rail:
0.2mm - 2 pcs
0.5mm - 10 pcs



Spec. slice on rear of the rail:
0.2mm - 2 pcs
0.5mm - 2 pcs

Specification:

Model No.	Applicable Screw Dia. (mm)	Screw Head Dia.(mm)	Applicable Screw Length (mm)	Horizontal Delivery Speed	Scooping Chamber Capacity	Switching Adaptor	Power Source	Feeding	Dimension L x W x H (mm)	Net Weight (kg)
SFR20	M0.8(0.6)~M2.0	1.2~6.5	1.0~8	42~90 pcs/min (0.67~1.43 Sec)	100~120 cc	DC 12 V Switching Adaptor	AC 100~240V	Chamber blanking	159 x 82 x 117	1.5
SFR20M	M0.8 ~ M2.0	1.2~6.5	1.0~8	42~90 pcs/min (0.67~1.43 Sec)	100~120 cc	DC 12 V Switching Adaptor	AC 100~240V	Chamber blanking	159 x 82 x 117	1.5
SFR30	M0.8(0.6)~M3.0	1.2~9.5	1.0~15	46~50 pcs/min (1.2~1.3 Sec)	200~220 cc	DC 12 V Switching Adaptor	AC 100~240V	Chamber blanking	182 x 124 x 146	3.0

•Recommendation: Screw size is required to advice for checking the proper feeder purpose.

Accessories

For Industrial

Spring Balancer



Model No.	Capacity (kg)	Cable Travel (M)	Rope		Rope Dia. (mm)	Net Weight (kg)	Packing: Pcs/Ctn/G.W./Cuff' (kgs)
			Std.	Opt.			
 SA-2201	0.3~0.8	1.4	Cable	Nylon	2.5	0.41	40Pcs/Ctn/19.8/1.7'
SA-2203	0.6~1.5	1.4	Cable	Nylon	2.5	0.46	40Pcs/Ctn/21.0/1.7'
SA-2203-1	1.0~2.0	1.4	Cable	Nylon	2.5	0.53	40Pcs/Ctn/21.0/1.7'
SA-2204	1.5~3.0	1.4	Cable	Nylon	2.5	0.55	40Pcs/Ctn/22.8/1.7'
SA-2207	3.0~5.0	1.3	Cable		3.2	0.81	30Pcs/Ctn/24.0/1.7'

Model No.	Capacity (kg)	Cable Travel (M)	Rope	Rope Dia. (mm)	Net Weight (kg)	Packing: Pcs/Ctn/G.W./Cuff' (kgs)
SA-2204B	0.3~1.2	1.4	Nylon	4	0.57	30Pcs/Ctn/18.0/1.7'

90 Degree Attachment

Outline	Model No.	Applicable Models
	EAA-AH1	EA-BN630L, EA-BN650L EA-BD630L, EA-BD650L <i>* For lever type screwdrivers only.</i> <i>* High speed screwdrivers are not recommended when using angle attachment.</i>
	EAA-AH2	EA-BN412L, EA-BN419L <i>* For lever type screwdrivers only.</i> <i>* High speed screwdrivers are not recommended when using angle attachment.</i>



Pistol Grip:

Outline	Model No.	Applicable Models
	EAA-LG4 EAA-LG4/S(ESD)	EA-BN4(Lever start type)
	EAA-PG4 EAA-PG4/S(ESD)	EA-BN4(Push to start type)
	EAA-LG3 EAA-LG3/S(ESD)	EA-BN630L~EA-BN650L
	EAA-PG3 EAA-PG3/S(ESD)	EA-BN630P~EA-BN650P
	EAA-LG7/S(ESD)	EA-BK760L, EA-BK790L, EA-BK7120L(Lever start type)
	EAA-PG7/S(ESD)	EA-BK760P, EA-BK790P, EA-BK7120P(Push to start type)

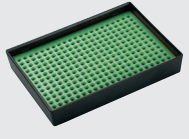
Screw Setter :

Outline	Model No.	Applicable Models
	EAA-SD11	M1.7~2.0 Screw available
	EAA-SD12	M2.0~2.6 Screw available
	EAA-SD13	M3.0~4.0 Screw available

Torque Adjuster:







Outline	Model No.	Applicable Models
	EAA-TA1	EA-BN630 ~ EA-BN650 EA-BD630 ~ EA-BD650
	EAA-TA3	EA-BN412 ~ EA-BN419 EA-BD412 ~ EA-BD419
	EAA-TA4	EA-BN203 ~ EA-BN210

Mag-O-Nets



*The COLOUR MAG-O-NETS provide visible torque making system.

*Increase productivity by easily locating fasteners.

*Fits virtually any standard screwdriver bit.

Parts No.	Specification				Outline				
	I.D. (mm)	O.D. (mm)	Length (mm)	Red	Yellow	Blue	Green	Orange	
AM4K (5pcs Set)	4	17.5	10.3						
AM5K (5pcs Set)	5	17.5	10.3	X	X	X		X	
AM7	7	14	10	X	X	X		X	

















Suspension Holster:

Outline	Model No.	Applicable Models
	EAA-HD2	EA-BN412~EA-BN419 (with torque fixing sleeve) ; EA-BN630~EA-BN650
	EAA-HD4	EA-BN412~EA-BN419
	EAA-HD5	EA-BN203~EA-BN210 (or with torque fixing sleeve)
	EAA-HD6	EA-BN630~EA-BN650, EA-BK760~EA-BK7120, ES-B1803~ES-B1812, EW-B18200, ESM-B18160, ESS-B1805~ESS-B1812
	EAA-HD7	EA-BAK960~EA-BAK9250, EA-BTN960~EA-BTN9180, ES-B1815, ES-B1822

Accessories

For Industrial

Torque Covers:

Outline	Model No.	Applicable Models	Outline	Model No.	Applicable Models
	EAA-TL1	EA-712~EA-748, ED-617~ED-645		EAA-TL8	EA-BN203L~EA-BN210L
	EAA-TL1/E (ESD)	EA-712/E~EA-748/E			
	EAA-TL2	ED-513~ED-520, EA-610~EA-630 ES-618~ES-645		EAA-TL8/E (ESD)	EA-BN203L/E~EA-BN210L/E
	EAA-TL2/E (ESD)	EA-610/E~EA-630/E			
	EAA-TL3	EA-BD203L~EA-BD210L ES-207~ES-215		EAA-TL9	EA-B101L~EA-B103L
	EAA-TL4	EA-203L~EA-210L			
	EAA-TL3/E (ESD)	EA-BD203L/E~EA-BD210L/E		EAA-TL9/E (ESD)	EA-B101L/E~EA-B103L/E
	EAA-TL4/E (ESD)	EA-203L/E~EA-210L/E			
	EAA-TL6	ED-212~ED-219, EA-408~EA-416 EA-BN412~EA-BN419 EA-BD412~EA-BD419		EAA-TL21A	EA-BAK960~9180, EA-BTN960~9180
				EAA-TL22A	EA-BAK960~EA-BAK9250
	EAA-TL6/E (ESD)	EA-BN412/E~EA-BN419/E EA-BD412/E~EA-BD419/E		EAA-TL27A-1A	EA-BK760~EA-BK7120
	EAA-TL7	EA-BN630~EA-BN650 EA-BD630~EA-BD650		EAA-TL28A	EA-BTK6 Series
	EAA-TL7/E (ESD)	EA-BN630/E~EA-BN650/E EA-BD630/E~EA-BD650/E		EAA-TL29A	EA-BAKA9

Power Cord:

* The voltage could be reduced and the signal could be unstable or interferred if cable is over 3M length.

Applicable Models	2M Length (Standard)	3M Length (M.O.Q. 10pcs)	6M Length (M.O.Q. 10pcs)	9M Length (M.O.Q. 10pcs)	3M Recoil (M.O.Q. 10pcs)
EA-BD2xx Series	1 EPAA50005-B6P-6N	-	-	-	9 EPAA50005-B6P-10-1N 12 (Need EPAA50001-157N)
EA-BD4xx & BD6xx Series	2 EPAA50001-56N	4 EPAA50001-84N	7 EPAA50001-102N	8 EPAA50005-B6P-3-4N	10 EPAA50001-105N
EA-BN2xxL Series	3 EPAA50001-16-2N	5 EPAA50001-16-3N	8 EPAA50005-B6P-9-3N	8 EPAA50005-B6P-9-4N	9 EPAA50005-B6P-10-1N 12 (Need EPAA50001-157N)
EA-BN2xxP Series	6 EPAA50005-B6P-6N	-	-	-	-
EA-BN4xx, BN6xx, BK7xx, BTN9xxx & BAK9xxx Series	2 EPAA50001-56N	4 EPAA50001-84N	7 EPAA50001-102N	8 EPAA50005-B6P-3-4N	10 EPAA50001-105N
EA-BTK6xx Series	-	6 EPAA50006-B6P-6N (Standard for EA-BTK6xx)	-	-	11 EPAA50006-B6P-8N (Connect with tool by welding) 9 EPAA50005-B6P-10-1N 12 (Need EPAA50001-157N)
EA-BAN9350 & BAN9500 Series	8 EPAA50005-B6P-9N	8 EPAA50005-B6P-9-1N	8 EPAA50005-B6P-9-3N	8 EPAA50005-B6P-9-4N	9 EPAA50005-B6P-10-1N 12 (Need EPAA50001-157N)





Transducerized
Screwdriver



Cordless
Tools



Industrial
Air Screwdriver



Automatic
Screw Feeder



Torque
Wrench

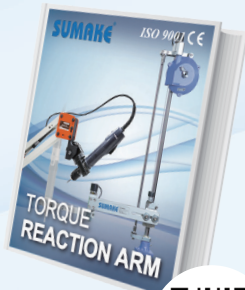

Torque
Reaction Arm



Screwdriver
Bits



SUMAKE®

SUMAKE Industrial Co., Ltd.

4F, NO.351, Yangguang St., Neihu District, Taipei, Taiwan

Tel: 886-2-2659-3500 Fax: 886-2-2659-3700

<http://www.sumake.com> <http://www.aircompressors.com.tw>

E-mail: sales@sumake.com.tw



©SUMAKE We reserve the right to make changes without prior notice.

