



STARRETT-WEBBER GAGE BLOCKS

PRECISION GAGE BLOCKS, STANDARD REFERENCE BARS

GAGE BLOCKS – MAJOR PRODUCT CHARACTERISTICS

Precision gage blocks are the primary standards vital to dimensional quality control in the manufacture of parts. The four major characteristics that are necessary for a precision gage block are accuracy, surface finish, wear resistance and dimensional stability. Other factors are corrosion resistance, hardness, thermal conductivity and coefficient of expansion.

The base material used for gage blocks is crucial in meeting the above criteria. While many materials have been tried, the major types available today are:

- **Traditional high-grade steel** gage blocks, which are generally used in shop floor environments
- **Tungsten Carbide** gage blocks, which have the advantage of being harder and longer wearing than steel (Not available from Starrett-Webber)
- **Ceramic** gage blocks will outwear regular steel and will not corrode
- **Chromium Carbide** gage blocks are considered the top of the line; the finest available. They outwear regular steel and ceramic. In addition, they will not corrode, are very stable and accurate, and have exceptional "wringing" qualities.

croblox® Chromium Carbide is the superior gage block material. The reason that our Webber Gage Division emphasizes gage blocks made from Chromium Carbide is because they are the most stable measuring devices ever developed.

No one in the world except Starrett-Webber has produced the accuracy and stability of our croblox Grand Masters. They were produced in 1955 of Chromium Carbide material to an accuracy within one millionth of an inch (.0000254mm) and have been checked periodically by the U.S. National Bureau of Standards and the U.S. National Institute of Standards and Technology (NIST) and have remained stable over this period.

OTHER CHARACTERISTICS

ACCURACY

All Starrett-Webber gage blocks meet or exceed all known specifications. The flatness, parallelism and surface finish necessary to achieve the required accuracies are the same as or better than government requirements.

STABILITY

Starrett-Webber gage blocks do not change in size except through normal wear. Gage block stability is a characteristic that our Webber Gage Division has mastered with over eighty years of experience. Our gage blocks withstand the test of time.

HARDNESS

Steel blocks have a Rockwell "C" hardness of approximately 64-65. Chromium Carbide blocks have a Rockwell "C" hardness of 71-73, with an unusually fine, hard grain structure, giving them exceptional resistance to wear and abrasion.

THERMAL CONDUCTIVITY AND COEFFICIENT OF EXPANSION

These are not important considerations when measurements are taken in temperature-controlled environments. This is primarily done when measuring to microinches or microns.

On the shop floor, where precision measurements are rarely finer than .0002" or 0.005mm, the coefficient of expansion of steel, chromium carbide and ceramic is so close as to be negligible.

Thermal conductivity is important on the shop floor. However, because it takes time for a gage block to move to the same temperature as the workpiece, we recommend setting the gage block on a heat sink such as a large mass of metal that is at the shop environment temperature.



HOW TO ORDER STARRETT PRECISION GAGE BLOCKS

GAGE BLOCK SETS

1. Order by catalog number.
2. Please specify if you require a Commercial Calibration or Master Calibration. See the catalog page regarding our Accredited Gage Block Calibration Service near the end of this section. A certificate of calibration provides individual readings on each block and provides traceability to NIST. Webber gage block calibrations are NVLAP® accredited by NIST. (We require the end user's name and address to place on the certificate.)
3. Specify if you require special etched serial numbers. We can provide numbers up to a 6-digit maximum. (Our standard practice is to put the same etch number on each block in a set. Blocks are differentiated by their marked size.) If an etched serial number is not specified, we will assign a number that is a coded date.

The buyer of Webber products listed in this catalog agrees to the 100% Relaxed Acceptance Rule contained in ASME B89.7.3.1 (Guidelines for Decision Rules: Considering Measurement Uncertainty in Determining Conformance to Specifications). Products may not be rejected by the purchaser unless his measurements exceed the published tolerances by more than his uncertainty of measurement.

NVLAP® accreditation does not constitute an endorsement of any product by NVLAP® or any agency of the U.S. government.



NVLAP LAB CODE 200038-0

National Institute of Standards and Technology
National Voluntary Laboratory Accreditation Program



STARRETT-WEBBER GAGE DIVISION

24500 Detroit Road
Cleveland, OH 44145
Phone: 440-835-0001
Fax: 440-892-9555
E-mail: sales@starrett-webber.com

DIMENSIONAL NVLAP Code: 20/D03 Gage Blocks

INDIVIDUAL GAGE BLOCKS

1. **Specify Shape**, signified by the following symbols:

- Rectangular 
- Square 
- Heavy Duty 

2. **Specify Material** (croblox®, steel, or ceramic)
3. **Specify Unit of Measure** (inch or metric)
4. **Specify the Size**
5. **Specify Special Lengths**, if applicable (Rectangular Only)
 - Thin block sets (28 pc. inch and 17 pc. metric) are all 1.115" (28.3mm) long. Specify "SS" length.
 - .050", .100", and .150" blocks in inch 81-92 pc. sets are 1.380" long. Specify the Long length, "L".
 - .100" blocks contained in the 36, 38, and 43 pc. sets are 1.380" long. Specify the Long length, "L".
6. **Specify Accuracy Grade** (see next page)
7. **Specify if you require a Commercial, Master or Laboratory Calibration***. See the catalog page regarding our Accredited Gage Block Calibration Service near the end of this section. A certificate of calibration provides individual readings on each block and provides traceability to NIST. Webber gage block calibrations are NVLAP® accredited by NIST. (We require the end user's name and address to place on the certificate.)

* Commercial calibrations are included in the price of gage blocks. Master calibrations are done at extra cost. Laboratory calibrations are done at extra cost and are restricted to Webber croblox® rectangular style gage blocks of grades LM, AA, GGG grades 0.5 and 1, and B89 Grades 00 and K.
8. **Specify if you require special etched serial numbers.** We can provide up to a 6-digit maximum. If an etched serial number is not specified, we will assign a number that is a coded date.



GAGE BLOCK TOLERANCES

GAGE BLOCK TOLERANCES: B89.1.9

Inch System: Tolerances expressed in microinches (.00001") 1 millionth of an inch									
	Order Webber Grade LM			Order Webber Grade AA B89.1.9 Grade 00			Order Webber Grade A1 B89.1.9 Grade 0		
	Size Tolerance	Variation in Length Tolerance	Flatness Tolerance	Size Tolerance	Variation in Length Tolerance	Flatness Tolerance	Size Tolerance	Variation in Length Tolerance	Flatness Tolerance
Thru .050"	+1.2/-1.2	1.2	1.2	+4/-4	2	2	+6/-6	4	4
Thru .400"	+1.2/-1.2	1.2	1.2	+3/-3	2	2	+5/-5	4	4
Thru 1"	+1.2/-1.2	1.2	1.2	+3/-3	2	2	+6/-6	4	4
Thru 2"	+2.0/-2.0	1.2	1.2	+4/-4	2	2	+8/-8	4	4
Thru 3"	+3.0/-3.0	1.2	1.2	+5/-5	3	Rect.: 2, Sq.: 3	+10/-10	4	4
Thru 4"	+4.0/-4.0	1.2	1.2	+6/-6	3	Rect.: 2, Sq.: 3	+12/-12	5	4
Thru 5"				+8/-8	3	Rect.: 2, Sq.: 3	+16/-16	5	4
Thru 6"				+8/-8	3	Rect.: 2, Sq.: 3	+16/-16	5	4
Thru 7"				+10/-10	4	4	+20/-20	6	6
Thru 8"				+10/-10	4	4	+20/-20	6	6
Thru 10"				+12/-12	4	4	+24/-24	6	6
Thru 12"				+14/-14	4	4	+28/-28	7	6
Thru 16"				+18/-18	5	4	+36/-36	8	6
Thru 28"				+20/-20	6	4	+44/-44	10	6

Not Available from Webber B89.1.9 Grade AS1				Not Available from Webber B89.1.9 Grade AS2		
	Size Tolerance	Variation in Length Tolerance	Flatness Tolerance	Size Tolerance	Variation in Length Tolerance	Flatness Tolerance
Thru .050"	+12/-12	6	6	+24/-24	12	10
Thru .400"	+8/-8	6	6	+18/-18	12	10
Thru 1"	+12/-12	6	6	+24/-24	12	10
Thru 2"	+16/-16	6	6	+32/-32	12	10
Thru 3"	+20/-20	6	6	+40/-40	14	10
Thru 4"	+24/-24	8	6	+48/-48	14	10
Thru 5"	+32/-32	8	6	+64/-64	16	10
Thru 6"	+32/-32	8	6	+64/-64	16	10
Thru 7"	+40/-40	10	7	+80/-80	16	10
Thru 8"	+40/-40	10	7	+80/-80	16	10
Thru 10"	+48/-48	10	7	+104/-104	18	10
Thru 12"	+56/-56	10	7	+112/-112	20	10
Thru 16"	+72/-72	12	7	+144/-144	20	10
Thru 20"	+88/-88	14	7	+176/-176	24	10

B89.1.9 Grade 00 exceeds DIN, ISO, BS Grades K

Material Coefficients of Thermal Expansion are:
 Chromium Carbide 4.7 x 10⁻⁶ inch/°F per inch
 SAE 52100 Steel 6.4 x 10⁻⁶ inch/°F per inch
 Ceramic 5.5 x 10⁻⁶ inch/°F per inch

Suggested Replacement Grades for GGG-G-15C		
GGG-G-15C Grade	Webber Grade	B89.1.9 Grade
0.5	LM	—
1	AA	0
2	A1	0
3	A	AS1

The above replacement grades are suggested in B89.1.9. However, the tolerances specified in GGG-G-15C and B89.1.9 are not exactly the same. Gage blocks meeting B89.1.9 specifications may not meet GGG-G-15C requirements and vice versa.



Metric System: Tolerances expressed in micrometers (0.001mm)

	Order Webber Grade LM			Order Webber Grade A1 B89.1.9 Grade 0			Order Webber Grade AA B89.1.9 Grade 00		
	Size Tolerance	Variation in Length Tolerance	Flatness Tolerance	Size Tolerance	Variation in Length Tolerance	Flatness Tolerance	Size Tolerance	Variation in Length Tolerance	Flatness Tolerance
Thru 0.5mm	+03/-03	.03	.03	+10/-10	.05	.05	+14/-14	.10	.10
Thru 10mm	+03/-03	.03	.03	+07/-07	.05	.05	+12/-12	.10	.10
Thru 25mm	+04/-04	.03	.03	+07/-07	.05	.05	+14/-14	.10	.10
Thru 50mm	+05/-05	.03	.03	+10/-10	.06	.05	+20/-20	.10	.10
Thru 75mm	+08/-08	.03	.03	+12/-12	.07	Rect (.05), Sq. (.07)	+25/-25	.12	.10
Thru 100mm	+10/-10	.03	.03	+15/-15	.07	Rect (.05), Sq. (.07)	+30/-30	.12	.10
Thru 125mm				+20/-20	.08	Rect (.05), Sq. (.07)	+40/-40	.14	.10
Thru 150mm				+20/-20	.08	Rect (.05), Sq. (.07)	+40/-40	.14	.10
Thru 175mm				+25/-25	.09	.10	+50/-50	.16	.15
Thru 200mm				+25/-25	.09	.10	+50/-50	.16	.15
Thru 250mm				+30/-30	.10	.10	+60/-60	.16	.15
Thru 300mm				+35/-35	.10	.10	+70/-70	.18	.15
Thru 400mm				+45/-45	.12	.10	+90/-90	.20	.15
Thru 500mm				+50/-50	.14	.10	+1.1/-1.1	.25	.15

Not Available from Webber B89.1.9 Grade AS1

	Size Tolerance	Variation in Length Tolerance	Flatness Tolerance
Thru 0.5mm	+30/-30	.16	.15
Thru 10mm	+20/-20	.16	.15
Thru 25mm	+30/-30	.16	.15
Thru 50mm	+40/-40	.18	.15
Thru 75mm	+50/-50	.18	.15
Thru 100mm	+60/-60	.20	.15
Thru 125mm	+80/-80	.20	.15
Thru 150mm	+80/-80	.20	.15
Thru 175mm	+1.0/-1.0	.25	.18
Thru 200mm	+1.0/-1.0	.25	.18
Thru 250mm	+1.2/-1.2	.25	.18
Thru 300mm	+1.4/-1.4	.25	.18
Thru 400mm	+1.8/-1.8	.30	.18
Thru 500mm	+2.2/-2.2	.35	.18

Not Available from Webber B89.1.9 Grade AS2

	Size Tolerance	Variation in Length Tolerance	Flatness Tolerance
Thru 0.5mm	+60/-60	.30	.25
Thru 10mm	+45/-45	.30	.25
Thru 25mm	+60/-60	.30	.25
Thru 50mm	+80/-80	.30	.25
Thru 75mm	+1.0/-1.0	.35	.25
Thru 100mm	+1.2/-1.2	.35	.25
Thru 125mm	+1.6/-1.6	.40	.25
Thru 150mm	+1.6/-1.6	.40	.25
Thru 175mm	+2.0/-2.0	.40	.25
Thru 200mm	+2.0/-2.0	.40	.25
Thru 250mm	+2.4/-2.4	.45	.25
Thru 300mm	+2.8/-2.8	.50	.25
Thru 400mm	+3.6/-3.6	.50	.25
Thru 500mm	+4.4/-4.4	.60	.25

Material Coefficients of Thermal Expansion are:

Chromium Carbide 8.5×10^{-6} m/°C per m

SAE 52100 Steel 11.5×10^{-6} m/°C per m

Ceramic 9.9×10^{-6} m/°C per m

B89.1.9 Grade 00 exceeds DIN, ISO, BS Grades K

Suggested Replacement Grades for GGG-G-15C

GGG-G-15C Grade	Webber Grade	B89.1.9 Grade
0.5	LM	—
1	AA	0
2	A1	0
3	A	AS1

The above replacement grades are suggested in B89.1.9. However, the tolerances specified in GGG-G-15C and B89.1.9 are not exactly the same. Gage blocks meeting B89.1.9 specifications may not meet GGG-G-15C requirements and vice versa.



GAGE BLOCK SETS

RECTANGULAR INCH SYSTEM GAGE BLOCK SETS, INDIVIDUAL BLOCKS AND ACCESSORIES



All sets are furnished in a handsome, rugged wood case for lasting protection

INCH

Rectangular croblox® Gage Block Sets in Case				
Cat. No.	Accuracy Grade*	Measuring Range	Blocks Per Set	Blocks Included In Sets
RC 81.A1 RC 81.AA RC 81.LM**	B89.1.9 0 B89.1.9 00 Webber LM	.100-12.000 in Steps of .001 .200-12.000 in Steps of .0001	81	9 Blocks .1001 Through .1009 (Steps of .0001) 49 Blocks .101 Through .149 (Steps of .001) 19 Blocks .050 Through .950 (Steps of .050) 4 Blocks 1.000 Through 4.000 (Steps of 1")
RC 88.A1 RC 88.AA RC 88.LM**	B89.1.9 0 B89.1.9 00 Webber LM	.100-12.000 in Steps of .001 .200-12.000 in Steps of .0001 .300-12.000 in Steps of .000025 1/16-12.000 in Steps of 1/64	88	Same as in RC 81. Set, Plus 3 Blocks .100025, .10005, .100075 4 Blocks 1/16, 5/64, 3/32, 7/64
RC 34.A1 RC 34.AA RC 34.LM**	B89.1.9 0 B89.1.9 00 Webber LM	.200-8.000 in Steps of .001 .300-8.000 in Steps of .0001	34	9 Blocks .1001 Through .1009 (Steps of .0001) 9 Blocks .101 Through .109 (Steps of .001) 9 Blocks .110 Through .190 (Steps of .010) 3 Blocks .100 Through .300 (Steps of .100) 1 Block .500 3 Blocks 1.000, 2.000 and 4.000
RC 28.A1 RC 28.AA	B89.1.9 0 B89.1.9 00	.020-.240 in Steps of .001 .040-.240 in Steps of .0001 .060-.240 in Steps of .00005	28	1 Block .02005 9 Blocks .0201 Through .0209 (Steps of .0001) 9 Blocks .021 Through .029 (Steps of .001) 9 Blocks .010 Through .090 (Steps of .010)

For gage block accessories, order AC 11.A Accessory Set in Case. Sets include etched serial numbers and Commercial Calibration Certificate. A Master Calibration Certificate is available at extra cost.

* For complete accuracy specifications, see the beginning of this section.

** Available by special order only.



GAGE BLOCK SETS

RECTANGULAR INCH SYSTEM GAGE BLOCK SETS, INDIVIDUAL BLOCKS AND ACCESSORIES

Our Ceramic Gage Blocks, offered in rectangular, inch and metric, fill the gap between steel and the universally accepted croblox®. While not as stable as croblox®, ceramic is an excellent alternative to steel because of its superior hardness, thermal expansion and wear characteristics.

INCH

Rectangular Ceramic Gage Block Sets in Case				
Cat. No.	Accuracy Grade*	Measuring Range	Blocks Per Set	Blocks Included In Sets
RY 81.A1 RY 81.AA	B89.1.9 0 B89.1.9 00	.100-12.000 in Steps of .001 .200-12.000 in Steps of .0001	81	9 Blocks .1001 Through .1009 (Steps of .0001) 49 Blocks .101 Through .149 (Steps of .001) 19 Blocks .050 Through .950 (Steps of .050) 4 Blocks 1.000 Through 4.000 (Steps of 1")
RY 88.A1 RY 88.AA	B89.1.9 0 B89.1.9 00	.100-12.000 in Steps of .001 .200-12.000 in Steps of .0001 .300-12.000 in Steps of .000025 1/16-12.000 in Steps of 1/64	88	Same as in RY 81. Set, Plus 3 Blocks .100025, .10005, .100075 4 Blocks 1/16, 5/64, 3/32, 7/64
RY 34.A1 RY 34.AA	B89.1.9 0 B89.1.9 00	.200-8.000 in Steps of .001 .300-8.000 in Steps of .0001	34	9 Blocks .1001 Through .1009 (Steps of .0001) 9 Blocks .101 Through .109 (Steps of .001) 9 Blocks .110 Through .190 (Steps of .010) 3 Blocks .100 Through .300 (Steps of .100) 1 Block .500 3 Blocks 1.000, 2.000 and 4.000

Sets include etched serial number and Commercial Calibration Certificate. A Master Calibration Certificate is available at extra cost.

* For complete accuracy specifications, see the beginning of this section.

INCH

Rectangular Steel Gage Block Sets in Case			B89.1.9 Accuracy Grade 0*
Cat. No.	Measuring Range	Blocks Per Set	Blocks Included In Sets
RS 81.A1	.100-12.000 in Steps of .001 .200-12.000 in Steps of .0001	81	9 Blocks .1001 Through .1009 (Steps of .0001) 49 Blocks .101 Through .149 (Steps of .001) 19 Blocks .050 Through .950 (Steps of .050) 4 Blocks 1.000 Through 4.000 (Steps of 1")
RS 88.A1	.100-12.000 in Steps of .001 .200-12.000 in Steps of .0001 .300-12.000 in Steps of .000025 1/16-12.000 in Steps of 1/64	88	Same as in RS 81.A1 Set, Plus 3 Blocks .100025, .10005, .100075 4 Blocks 1/16, 5/64, 3/32, 7/64
RS 92.A1	.100-12.000 in Steps of .001 .200-12.000 in Steps of .0001 .300-12.000 in Steps of .000025 1/16-12.000 in Steps of 1/64	92	Same as in RS 88.A1 Set, Plus 2 Blocks .100" (croblox® Wear Blocks) 2 Blocks .050 (croblox® Wear Blocks)
RS 38.A1	.100-4.000 in Steps of .001 .150-4.000 in Steps of .0001 .200-4.000 in Steps of .00005	38	2 Blocks .050 (croblox® Wear Blocks) 1 Block .05005 9 Blocks .0501 Through .0509 (Steps of .0001) 9 Blocks .051 Through .059 (Steps of .001) 11 Blocks .050 Through .150 (Steps of .010) 4 Blocks .200 Through .500 (Steps of .100) 2 Blocks 1.000 and 2.000
RS 34.A1	.200-8.000 in Steps of .001 .300-8.000 in Steps of .0001	34	9 Blocks .1001 Through .1009 (Steps of .0001) 9 Blocks .101 Through .109 (Steps of .001) 9 Blocks .110 Through .190 (Steps of .010) 4 Blocks .100, .200, .300, .500 3 Blocks 1.000, 2.000, 4.000
RS 28.A1	.020-.240 in Steps of .001 .040-.240 in Steps of .0001 .060-.240 in Steps of .00005	28	1 Block .02005 9 Blocks .0201 Through .0209 (Steps of .0001) 9 Blocks .021 Through .029 (Steps of .001) 9 Blocks .010 Through .090 (Steps of .010)
RS 9.A1	.0625-4.000 in Steps of .0625 .100-4.000 in Steps of .100	9	1 Block .0625, .100, .125, .200, .250, .300, .500, 1.000, 2.000
Micrometer Checking Set			B89.1.9 Accuracy Grade AS1*
Cat. No.	Measuring Range	Blocks Per Set	Blocks Included In Sets
RS 10.A		10	10 blocks .105, .210, .315, .420, .500, .605, .710, .815, .920, 1.000

For gage block accessories, order AC 11.A Accessory Set in Case. See rectangular block accessories on the next page. Sets include etched serial numbers and Commercial Calibration Certificate. A Master Calibration Certificate is available at extra cost.

* For complete accuracy specifications, see the beginning of this section.



GAGE BLOCK SETS

MICROACCURATE® B-GRADE RECTANGULAR STEEL GAGE BLOCK SETS IN CASE

These B-Grade gage block sets are Starrett Global products. Their very affordable price makes them ideal for general shop floor use.

- Etched, unique serial numbers are included on each block. Custom numbers are not available.
- Sets available with a choice of two types of certificates of calibration as described below
- Inch System sets have a tolerance of $\pm 50\mu\text{in}$.
- Metric System sets have a tolerance of $\pm 1.25\mu\text{m}$.



RS 81.B

INCH AND METRIC

MicroAccurate® Inch System Sets			
Cat. No.	Measuring Range	Blocks Per Set	Blocks Included In Sets
RS 81.B RS 81.W	.100-12.000 in steps of .001 .200-12.000 in steps of .0001	81	9 blocks .1001 through .1009 (steps of .0001) 49 blocks .101 through .149 (steps of .001) 19 blocks .050 through .950 (steps of .050) 4 blocks 1.000 through 4.000 (steps of 1)
MicroAccurate® Metric System Sets			
Cat. No.	Measuring Range	Blocks Per Set	Blocks Included In Sets
RS 88.MB RS 88.MW	3.0 through 450 in .0005 steps 2.0 through 450 in .001 steps 1.0 through 450 in .01 steps 1.0 through 450 in .1 steps	88	1 block .5 1 block 1.0005 9 blocks 1.001 through 1.009 (steps of .001) 49 blocks 1.01 through 1.49 (steps of .01) 18 blocks 1 through 9.5 (steps of .5) 10 blocks 10 through 100 (steps of 10)
RS 112.MB RS 112.MW	3.0 through 250 in .0005 steps 2.0 through 250 in .001 steps 1.0 through 250 in .01 steps 1.0 through 250 in .1 steps	112	1 block .5 1 block 1.0005 9 blocks 1.001 through 1.009 (steps of .001) 49 blocks 1.01 through 1.49 (steps of .01) 48 blocks 1 through 24.5 (steps of .5) 4 blocks 25 through 100 (steps of 25)

Specifications	
Cat. No.	Features
RS 81.B RS 88.MB	Calibration performed at Webber Gage in Cleveland, OH. Certificate of Calibration with NVLAP® accreditation. Calibration in accordance with ISO 17025 with dated calibration certificate and NIST traceability number. The name and address of the user may be added to the calibration certificate.
RS 112.MB	Inch System (RS 81.B) uncertainty of measurement ($k=2$): $U = 6 + L$ where L is in inches, but U not less than 7 min. Metric Systems (RS 88.MB and RS 112.MB) uncertainty of measurement ($k=2$): $U = 0.15 + .001L$ where L is in millimeters, but U not less than 0.18 μm .
RS 81.W RS 88.MW	Calibration performed in China in partnership with Webber Gage. Webber Gage samples the measurements to monitor the calibration results. Calibrations are traceable to NIST, but no NIST traceability number or dates will be given. The name and address of the user will be left blank on the calibration certificate.
RS 112.MW	Inch System (RS 81.W) uncertainty of measurement ($k=2$): 10 μin . Metric Systems (RS 88.MW and RS 112.MW) uncertainty of measurement ($k=2$): $U = 0.25 \mu\text{m}$.



GAGE BLOCK ACCESSORIES



AC11..MA

INCH



Rectangular Inch System Steel and croblox® Accessories Individually or Sets as Stated Below

Individual Accessories

Description	Cat. No. Steel	croblox®	Steel Accessories Included Set AC 11.A
Half-Round Jaw .250 Radius	RA 1.		2**
Straight Jaw* .250" Thick	RA 4.	RA 24.	2**
Clamps			
0" – 1-1/2" Capacity	RA 5.		1
1-1/2" – 4" Capacity	RA 6.		1
4" – 6-1/2" Capacity	RA 7.		1
0" – 12" Capacity	RA 8.		1
Scriber Point	RA 11.		1
Center Point, 100 C/L	RA 12.		1
Base Block 1" Thick	RA 13.		1
Case (CS 9111.)			1

Additional Accessories

Cat. No.	Description
	Clamps
RA 9.	0-18" Capacity
RA 10.	0-24" Capacity
RA 14.	0-36" Capacity
	Half-Round Jaws
RA 2.	.200 Radius
RA 3.	.100 Radius

* croblox jaws available as an option at extra cost. Please specify.

** Jaws are normally used in pairs, but are ordered individually. Please order accordingly.

Rectangular croblox® Wear Blocks

Cat. No.	Size
RC .020 WA1	0.020
RC .050 WA1	0.050
RC .100 WA1	0.100

INCH



Square croblox® – Inch System Gage Block Sets in Case

Cat. No.	Accuracy Grade*	Measuring Range	Blocks Per Set	Blocks Included In Sets
SC 81.A1 SC 81.AA	B89.1.9 0 B89.1.9 00	.100-12.000 in Steps of .001 .200-12.000 in Steps of .0001	81	9 blocks .1001 through .1009 (Steps of .0001) 49 blocks .101 through .149 (Steps of .001) 19 blocks .050 through .950 (Steps of .050) 4 blocks 1.000 through 4.000 (Steps of 1)
SC 88.A1 SC 88.AA	B89.1.9 0 B89.1.9 00	.100-12.000 in Steps of .001 .200-12.000 in Steps of .0001 .300-12.000 in Steps of .000025 1/16-12.000 in Steps of 1/64	88	Same as in SC 81. Set, Plus 3 blocks .100025, .10005, .100075 4 blocks 1/16, 5/64, 3/32, 7/64
SC 36.A1 SC 36.AA	B89.1.9 0 B89.1.9 00	.200-8.000 in Steps of .001 .300-8.000 in Steps of .0001	36	1 Block .050 9 blocks .1001 through .1009 (Steps of .0001) 9 blocks .101 through .109 (Steps of .001) 9 blocks .110 through .190 (Steps of .010) 5 blocks .100 through .500 (Steps of .100) 3 blocks 1.000, 2.000, 4.000

All Square croblox® sets above are available with accessories at extra cost. To order, add "X" to catalog number. Accessories are furnished in steel (see following pages). Sets include etched serial numbers and Commercial Calibration Certificate. A Master Calibration Certificate is available at extra cost.

* For complete accuracy specifications, see the beginning of this section.



GAGE BLOCK SETS

INCH SYSTEM INDIVIDUAL GAGE BLOCK SETS IN CASE



SC88.A1X

INCH



Square Steel Gage Block Sets in Case			B89.1.9 Accuracy Grade 0*
Cat. No.	Measuring Range	Blocks Per Set	Blocks Included In Sets
SS 81.A1	.100-12.000 in steps of .001 .200-12.000 in steps of .0001	81	9 blocks .1001 through .1009 (steps of .0001) 49 blocks .101 through .149 (steps of .001) 19 blocks .050 through .950 (steps of .050) 4 blocks 1.000 through 4.000 (steps of 1") Above set also available with accessories** (extra)
SS 88.A1	.100-12.000 in steps of .001 .200-12.000 in steps of .0001 .300-12.000 in steps of .000025 1/16-12.000 in steps of 1/64	88	Same as in SS 81.A1 Set, Plus 3 blocks .100025, .10005, .100075 4 blocks 1/16, 5/64, 3/32, 7/64 Above set also available with accessories** (extra)
SS 36.A1	.200-8.000 in steps of .001 .300-8.000 in steps of .0001	36	1 Block .050 9 blocks .1001 through .1009 (steps of .0001) 9 blocks .101 through .109 (steps of .001) 9 blocks .110 through .190 (steps of .010) 5 blocks .100 through .500 (steps of .100) 3 blocks 1.000, 2.000 and 4.000 Above set also available with accessories** (extra)
SS 28.A1	.020-.240 in steps of .001 .040-.240 in steps of .0001 .060-.240 in steps of .00005	28	1 block .02005 9 blocks .0201 through .0209 (steps of .0001) 9 blocks .021 through .029 (steps of .001) 9 blocks .010 through .090 (steps of .010)
SS 8.A1X	5.000-84 in steps of 1.000	8	8 blocks 5, 6, 7, 8, 10, 12, 16, 20 Accessories Included: 6 each SA 8. Studs 2 each SA 9. flat head screws (long) 2 each SA 10. flat head screws (short) 1 each SA 16. 4-1/2 - 6" tie rod (adjustable) 1 each SA 17. 6-9" tie rod (adjustable) 1 each SA 18. 11-3/4" tie rod 1 each SA 19. 15-3/4" tie rod 2 each SA 20. 19-3/4" tie rods
Square Steel Gage Block Sets in Case			B89.1.9 Accuracy Grade 00*
Cat. No.	Measuring Range	Blocks Per Set	Blocks Included In Sets
SS 8.AAX	5.000-84 in steps of 1.000	8	Same as above SS 8.A1X

* For complete accuracy specifications, see page at the beginning of this section.

** All square steel sets 34 through 88 are available with Accessories at extra cost. To order, add "X" to catalog number. Accessories are steel. See square block Accessories on the next page. Sets include etched serial numbers and Commercial Calibration Certificate. A Master Calibration Certificate is available at extra cost.



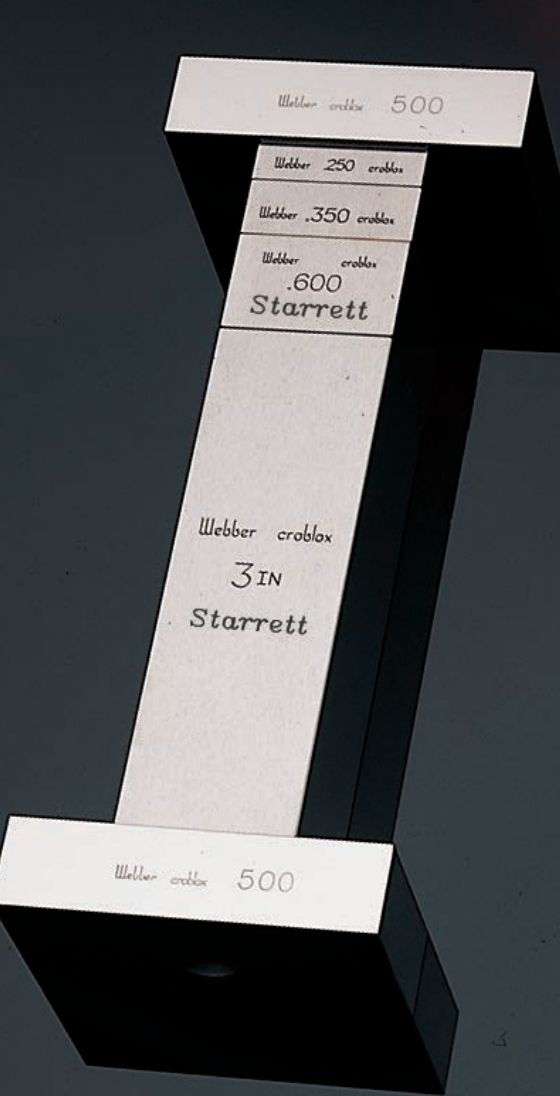

GAGE BLOCK ACCESSORIES

SA 707. STEEL INTERNAL MEASURING MACHINE JAWS

Jaws are double-ended, self-proving, assuring parallelism and squareness. Designed for use with square style gage blocks. Jaws are made of hardened steel material, 2.000" long, 1.000" wide and .500" thick. Both side edges are lapped 90° square to the gaging faces within 30 seconds of arc and extend beyond the gage blocks in the combination, thus forming a square master.

Jaw and gage combination parallelism is quickly checked merely by turning the combination to the opposite side and rechecking the reading. Furnished in pairs.

Additional Accessories	
Cat. No.	Description
	Tie Rods
SA 18.	11-3/4" Solid
SA 19.	15-3/4" Solid
SA 20.	19-3/4" Solid

SQUARE GAGE BLOCK ACCESSORIES STEEL AND CROBLOX[®]

INCH



Square Steel Accessories Individually or Sets as Stated Below

Description	Cat. No.	Steel Accessories Included	
		Set SA 25.A and 81 thru 88 Block Sets when Ordered with Accessories	34 and 36 Block Sets when Ordered with Accessories
Half-Round Jaw*			
.125 Radius	SA 1.	2	
.250 Radius	SA 2.	2	2
Straight Jaw*			
.500" Thick	SA 3.	2	
Scriber Point	SA 4.	1	1
Center Point, .100 C/L	SA 5.	1	
Base Block .500 Thick	SA 6.	1	
Knurled Screw	SA 7.	2	2
Stud	SA 8.	2	2
Flat Head Screw			
Long	SA 9.	2	2
Short	SA 10.	2	2
Slotted Nut	SA 11.	2	2
Tie Rods			
3/4" Solid	SA 12.	1	1
1-1/2" Solid	SA 13.	1	1
2-1/4" Solid	SA 14.	1	1
3" Solid	SA 15.	1	1
4-1/2-6" Adjust	SA 16.	1	1
6-9" Adjust	SA 17.	1	
Case (CS9168)		(For SA 25.A Only)	

*Jaws are normally used in pairs, but are ordered individually. Please order accordingly.



GAGE BLOCKS

INDIVIDUAL RECTANGULAR GAGE BLOCKS

INCH

HOW TO ORDER

RECTANGULAR BLOCK SIZES

- Width: all blocks are .352" wide
- Length: for blocks under .050", length is 1.115"
- For blocks with .050" through .190", length is 1.180"
- For blocks .200" and above, length is 1.380"

EXCEPTIONS

- 28 block sets with blocks to .090" are all 1.115" long
- .050, .060, .070, .080, .090" blocks in this set are listed with the suffix "ss".
- .050, .100, .150" blocks contained in the 81–92-piece sets are 1.380" long. Specify "long length".
- .100" blocks contained in the 36, 38, and 43-block sets are 1.380" long. Specify "long length".

Specify in this Sequence: Shape, Material, Size and Accuracy Grade			
Shape	Material	Size	Accuracy
R=Rectangular	S=Steel	Listed in table	Listed in table
S=Square	C=crobox Y=Ceramic		

Example: RS .250A1 = Rectangular Steel block, size .250, Grade A1 Accuracy

crobox®, Ceramic and Steel Gage Blocks Grade	crobox®		Ceramic		Steel
	A1 0	AA 00	A1 0	AA 00	A1 0
.010	•	•			•
.0101					•
.0101 Through .0109 in Steps of .0001					•
.011 Through .019 in Steps of .001					•
.020 (Wear Blocks)	•				
.020 or .02005	•	•			•
.0201 Through .0209 in Steps of .0001	•	•			•
.021 Through .029 in Steps of .001	•	•			•
0.03	•	•			•
0.04	•	•			•
.050 long*	•	•	•	•	•
.050 (Wear Blocks)	•				
.050S or .050SS	•	•			•
0.0501					•
.0501 Through .0509 in Steps of .0001					•
.051 Through .059 in Steps of .001					•
.060 or .060SS	•	•			•
.0625 (1/16)	•	•	•	•	•
.070 or .070SS	•	•			•
.078125 (5/64)	•	•	•	•	•
.080 or .080SS	•	•			•
.090 or .090SS	•	•			•
.09375 (3/32)	•	•	•	•	•
.100 long*	•	•	•	•	•
.100 (Wear Blocks)	•				
.100S	•	•	•	•	•
0.1000	•	•	•	•	•
0.1001	•	•	•	•	•
0.1001	•	•	•	•	•
.1001 Through .1009 in Steps of .0001	•	•	•	•	•
.101 Through .109 in Steps of .001	•	•	•	•	•
.109375 (7/64)	•	•	•	•	•
.110 Through .119 in Steps of .001	•	•	•	•	•
.120 Through .129 in Steps of .001	•	•	•	•	•
.130 Through .139 in Steps of .001	•	•	•	•	•
.140 Through .149 in Steps of .001	•	•	•	•	•
.150 Long*	•	•	•	•	•
0.15	•	•	•	•	•
.160 Through .190 in Steps of .010	•	•	•	•	•
.200, .250, .300, .350	•	•	•	•	•
.400, .450, .500, .550, .600	•	•	•	•	•
.650, .700, .750	•	•	•	•	•
.800, .850, .900, .950	•	•	•	•	•
1.000	•	•	•	•	•
2.000	•	•	•	•	•
3.000	•	•	•	•	•
4.000	•	•	•	•	•
5.000					•
6.000					•

* Order long length for Webber set replacements.



GAGE BLOCKS

INDIVIDUAL SQUARE GAGE BLOCKS

INCH



HOW TO ORDER

SQUARE BLOCK SIZE

- All square blocks are .950" x .950"
- Blocks have a .265" hole in the center
- On blocks .200" thick and over, the hole is countersunk on both faces (croblox® Wear Blocks are countersunk on one face only)

croblox® and Steel Gage Blocks	croblox®		Steel	
	A1 0	AA 00	A1 0	AA 00
Grade				
0.010			•	
0.020			•	
0.0201			•	
.0201 Through .0209 in Steps of .0001			•	
.021 Through .029 in Steps of .001			•	
0.030			•	
0.040			•	
0.050	•	•	•	
0.060			•	
.0625 (1/16)	•	•	•	
0.070			•	
.078125 (5/64)	•	•	•	
0.080			•	
0.090			•	
.09375 (3/32)	•	•	•	
0.100	•	•	•	
.100 (Wear with Chamfered Hole)	•			
0.1000	•	•	•	
0.1001	•	•	•	
0.1001	•	•	•	
.1001 Through .1009 in Steps of .0001	•	•	•	
.101 Through .149 in Steps of .001	•	•	•	
.109375 (7/64)	•	•	•	
.150 Through .190 in Steps of .010	•	•	•	
0.200	•	•	•	
0.250	•	•	•	
0.300	•	•	•	
0.350	•	•	•	
.400, .450, .500, .550	•	•	•	
.600, .650, .700, .750	•	•	•	
.800, .850, .900, .950	•	•	•	
1.000	•	•	•	
2.000	•	•	•	
3.000	•	•	•	
4.000	•	•	•	
5.000			•	•
6.000			•	•
7.000			•	•
8.000			•	•
10.000			•	•
12.000			•	•
16.000			•	•
20.000			•	•

Specify in this sequence: Shape, Material, Size and Accuracy Grade

Shape	Material	Size	Accuracy
R=Rectangular	S=Steel	Listed in table	Listed in table
S=Square	C=croblox		

Example: SS .125A1 = Square Steel block, size .125 with a Grade A1 accuracy



GAGE BLOCKS

HEAVY-DUTY STEEL GAGE BLOCK SETS AND ACCESSORIES

GAGING AREA 17/32 X 1-1/2"

These heavy-duty gage block sets are primarily used for assembling together into exclusive Webber fixtures.

Precision "yardsticks" and height gages can be built up to a required dimension by wringing blocks together and then by the use of eccentric clamps, locking them into place. All blocks over 1" long have 1/4" holes that accept eccentric clamps. All blocks 6" or larger have an insulated center grip to eliminate temperature variations caused by handling.

Precision scribes and dividers for tool layout can be created in a few seconds. The center point is on a .500" center line of a 1" block. The scriber point may be sharpened indefinitely without altering the original accuracy.

Snap gages with inside or outside calipers can be easily assembled using accessories like the eccentric clamps, a quick-acting clamp, and a pair of half-round or straight jaws.



HD46.A1X

INCH 



Building up blocks into precision "yardsticks"



HD 46.A1X

Snap gage is used to check inside dimensions of ring gage still mounted in internal grinder

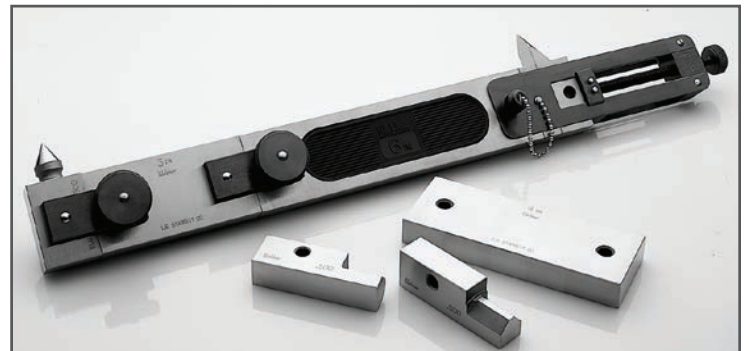

Precision scribes, dividers and snap gages



ACCESSORY SETS

INDICATOR ACCESSORY SET

This heavy-duty accessory mounts on any build-up of heavy-duty blocks and measures the deviation of the work from nominal or desired size. (Indicator is set and checked for zero by placing blocks on any known flat surface.)

HDA 10 and HDA 12 Indicator Accessory Sets consist of a holding block, extension jaw and a precision Starrett indicator. See catalog description below for indicator ranges and graduations.

Indicator Accessory Set



Eccentric clamps are used for combining long blocks



INCH

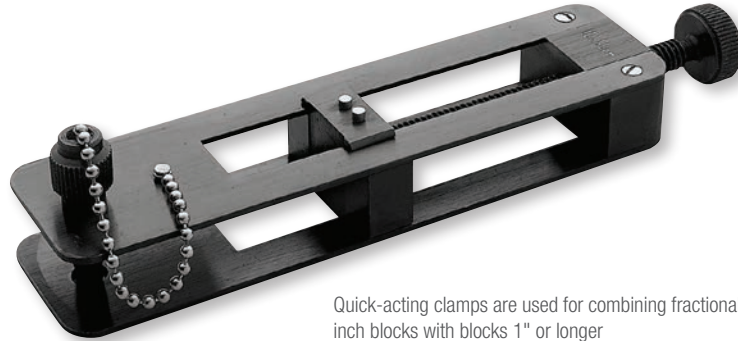

Quick-acting clamps are used for combining fractional inch blocks with blocks 1" or longer

Heavy-Duty Steel Accessories Individually or Sets as stated below

Individual Accessories		Steel Accessories Included in all 42 thru 46 Piece Sets or 84 Piece Set when ordered with Accessories
Description	Cat. No.	
Half-Round Jaw* .500 Radius	HDA 1.	2
Scriber Point	HDA 2.	1
Center Point .500 C/L	HDA 3.	1
Eccentric Clamp	HDA 4.	(See set description next page for qty.)
Quick-Acting Clamp	HDA 5.	1
Base Block 1.500" Thick	HDA 6.	1

Additional Accessories

Individual Accessories		
Description	Cat. No.	
Straight Jaw* 1.000 Thick	HDA 820.	
Indicator Set Consisting of: Indicator Holding Block Extension Jaw (1.000" Thick) Indicator with $\pm .010$ " Range, .0005" Graduations Case	HDA 10.	
Indicator Set As Above Except: Indicator with $\pm .0015$ " Range, .00005" Graduations	HDA 12.	

* Jaws are normally used in pairs, but are ordered individually. Please order accordingly.

WEAR BLOCKS

crobox® Wear Blocks in .050" and .100" sizes are available for use with heavy-duty blocks.

crobox® Wear Blocks	
Cat. No.	Size
HDC .050 WA1	.050"
HDC .100 WA1	.100"



GAGE BLOCK SETS AND ACCESSORIES

HEAVY-DUTY STEEL

INCH

Gage Block Sets and Accessories			B89.1.9 Accuracy Grade 0*
Cat. No.	Measuring Range	Blocks Per Set	Blocks included in Sets
HD 84.A1	.100-12.000 in steps of .001 .200-12.000 in steps of .0001 .300-12.000 in steps of .00005	84	2 blocks .100 Wear croblox® 1 block .10005 9 blocks .1001 through .1009 (steps of .0001) 49 blocks .101 through .149 (steps of .001) 19 blocks .050 through .950 (steps of .050) 4 blocks 1.000 through 4.000 (steps of 1) 3 eccentric clamps Above set also available with 2 additional eccentric clamps and accessories** (extra)
HD 46.A1X	.200-48.000 in steps of .001 .300-48.000 in steps of .0001	46	9 blocks .1001 through .1009 (steps of .0001) 9 blocks .101 through .109 (steps of .001) 9 blocks .110 through .190 (steps of .010) 9 blocks .100 through .900 (steps of .100) 4 blocks 1.000 through 4.000 (steps of 1) 6 blocks 6.000 10 eccentric clamps and accessories** (included)
HD 44.A1X	.200-36.000 in steps of .001 .300-36.000 in steps of .0001	44	9 blocks .1001 through .1009 (steps of .0001) 9 blocks .101 through .109 (steps of .001) 9 blocks .110 through .190 (steps of .010) 9 blocks .100 through .900 (steps of .100) 4 blocks 1.000 through 4.000 (steps of 1) 4 blocks 6.000 8 eccentric clamps and accessories** (included)
HD 42.A1X	.200-24.000 in steps of .001 .300-24.000 in steps of .0001	42	9 blocks .1001 through .1009 (steps of .0001) 9 blocks .101 through .109 (steps of .001) 9 blocks .110 through .190 (steps of .010) 9 blocks .100 through .900 (steps of .100) 4 blocks 1.000 through 4.000 (steps of 1) 2 blocks 6.000 6 eccentric clamps and accessories** (included)

Sets include etched serial numbers and Commercial Calibration Certificate. A Master Calibration Certificate is available at extra cost.
Case for HD 84.A1 has space for accessories and six 6.000" heavy-duty blocks. To order with accessories, add "X" to catalog number.
* For complete accuracy specifications, see page at the beginning of this section.
** See previous page for accessories.

Individual Heavy-Duty Gage Blocks – Steel Only
Block Size
0.050
.100, .100025, .10005, .100075
.1001 Through .1009 In Steps of .0001
.101 Through .149 In Steps of .001
.150 Through .190 In Steps of .010
.200 Through .950 In Steps of .050
1.000
2.000
3.000
4.000
6.000
10.000
20.000

To order individual blocks, specify HD followed by size and accuracy grade. Example: HD .050 A1



GAGE BLOCK SETS

METRIC SYSTEM GAGE BLOCK SETS, INDIVIDUAL BLOCKS AND ACCESSORIES

The following pages include these metric system items in the order shown:

Rectangular gage blocks and accessories

Square gage blocks and accessories



Metric rectangular 88 piece and square 112 sets are shown

RS 9.MA1 MINI-METRIC RECTANGULAR STEEL GAGE BLOCK SET

This mini-metric set of precision gage blocks calibrates micrometers, vernier gages and similar measuring tools. The gage blocks are also useful as setting masters for comparator-type dimensional gages and are useful in teaching the basics of metric measurement.

The set has a capacity of 61mm in 1, 0.5mm or 0.25mm steps. Its nine hardened steel blocks include these sizes: 1, 2, 2.25, 2.5, 3, 5, 10, 15 and 25mm. They are finished to B89.1.9 Accuracy Grade 0 and are furnished in a lined metal case.



Metric set RS 9.MA1



GAGE BLOCK SETS

RECTANGULAR CROBLOX® GAGE BLOCK SETS IN CASE

METRIC

Rectangular croblox Gage Block Sets in Case, One Millimeter Base				
Cat. No.	Accuracy Grade*	Measuring Range	Blocks Per Set	Blocks Included In Sets
RC 45.MA1 RC 45.MAA	B89.1.9 0 B89.1.9 00	3.0 through 450 (steps of .001) 2.0 through 450 (steps of .01) 1.0 through 450 (steps of .1)	45	9 blocks 1.001mm through 1.009mm (steps of .001) 9 blocks 1.01mm through 1.09mm (steps of .01) 9 blocks 1.1mm through 1.9mm (steps of .1) 9 blocks 1mm through 9mm (steps of 1) 9 blocks 10mm through 90mm (steps of 10)
RC 88.MA1 RC 88.MAA	B89.1.9 0 B89.1.9 00	3.0 through 450 (steps of .0005) 2.0 through 450 (steps of .001) 1.0 through 450 (steps of .01) 1.0 through 450 (steps of .1)	88	1 block .5 1 block 1.0005 9 blocks 1.001mm through 1.009 (steps of .001) 49 blocks 1.01mm through 1.49 (steps of .01) 18 blocks 1mm through 9.5mm (steps of .5) 10 blocks 10mm through 100mm (steps of 10)
RC 112.MA1 RC 112.MAA	B89.1.9 0 B89.1.9 00	3.0 through 250 (steps of .0005) 2.0 through 250 (steps of .001) 1.0 through 250 (steps of .01) 1.0 through 250 (steps of .1)	112	1 block .5 1 block 1.0005 9 blocks 1.001 through 1.009 (steps of .001) 49 blocks 1.01 through 1.49 (steps of .01) 48 blocks 1mm through 24.5mm (steps of .5) 4 blocks 25mm through 100mm (steps of 25)

Sets include etched serial numbers and Commercial Calibration Certificate. Metric croblox® Wear Blocks and/or Master Calibration Certificate are available at extra cost. For gage block accessories, order AC 11.MA Metric Accessory Set in Case.

* For complete accuracy specifications, see page at the beginning of this section.



Set RY 88.MA1

RECTANGULAR CERAMIC

METRIC

Now there's another addition to the famous Starrett-Webber line of precision gage blocks. Ceramic, offered in rectangular, inch and metric, fills the gap between steel and the universally accepted croblox®. While not as stable as croblox®, ceramic is an excellent alternative to steel because of its superior hardness, thermal expansion and wear characteristics.

Gage Block Sets in Case				
Cat. No.	Accuracy Grade*	Measuring Range	Blocks Per Set	Blocks Included In Sets
RY 45.MA1 RY 45.MAA	B89.1.9 0 B89.1.9 00	3.0 through 450 in .001 steps 2.0 through 450 in .01 steps 1.0 through 450 in .1 steps	45	9 blocks 1.001 through 1.009 (steps of .001) 9 blocks 1.01 through 1.09 (steps of .01) 9 blocks 1.1 through 1.9 (steps of .1) 9 blocks 1 through 9 (steps of 1) 9 blocks 10 through 90 (steps of 10)
RY 88.MA1 RY 88.MAA	B89.1.9 0 B89.1.9 00	3.0 through 450 in .0005 steps 2.0 through 450 in .001 steps 1.0 through 450 in .01 steps 1.0 through 450 in .1 steps	88	1 block .5 1 block 1.0005 9 blocks 1.001 through 1.009 (steps of .001) 49 blocks 1.01 through 1.49 (steps of .01) 18 blocks 1 through 9.5 (steps of .5) 10 blocks 10 through 100 (steps of 10)

Sets include etched serial numbers and Commercial Calibration Certificate. A Master Calibration Certificate is available at extra cost.

* For complete accuracy specifications, see page at the beginning of this section.



GAGE BLOCK SETS

RECTANGULAR STEEL – METRIC SYSTEM

METRIC

One Millimeter Base

Gage Block Sets in Case			B89.1.9 Accuracy Grade 0*
Cat. No.	Measuring Range	Blocks Per Set	Blocks Included In Sets
RS 9.MA1	1.0 through 61.0 in 1.0 steps 2.0 through 61.0 in .5 steps 4.0 through 61.0 in .25 steps	9	3 blocks 1.0, 2.0, 2.25 4 blocks 2.5, 3.0, 5.0, 10.0 2 blocks 15.0, 25.0
RS 45.MA1	3.0 through 450 in .001 steps 2.0 through 450 in .01 steps 1.0 through 450 in .1 steps	45	9 blocks 1.001 through 1.009 (steps of .001) 9 blocks 1.01 through 1.09 (steps of .01) 9 blocks 1.1 through 1.9 (steps of .1) 9 blocks 1 through 9 (steps of 1) 9 blocks 10 through 90 (steps of 10)
RS 88.MA1	3.0 through 450 in .0005 steps 2.0 through 450 in .001 steps 1.0 through 450 in .01 steps 1.0 through 450 in .1 steps	88	1 block .5 1 block 1.0005 9 blocks 1.001 through 1.009 (steps of .001) 49 blocks 1.01 through 1.49 (steps of .01) 18 blocks 1 through 9.5 (steps of .5) 10 blocks 10 through 100 (steps of 10)
RS 112.MA1	3.0 through 250 in .0005 steps 2.0 through 250 in .001 steps 1.0 through 250 in .01 steps 1.0 through 250 in .1 steps	112	1 block .5 1 block 1.0005 9 blocks 1.001 through 1.009 (steps of .001) 49 blocks 1.01 through 1.49 (steps of .01) 48 blocks 1 through 24.5 (steps of .5) 4 blocks 25 through 100 (steps of 25)
Micrometer Checking Set			B89.1.9 Accuracy Grade AS1*
Cat. No.	Measuring Range	Blocks Per Set	Blocks Included In Sets
RS 10.MA		10	10 blocks 2.5, 5.1, 7.7, 10.3, 12.9, 15.0, 17.6, 20.2, 22.8, 25.0

Sets include etched serial numbers and Commercial Calibration Certificate. Metric croblox® Wear Blocks and/or Master Calibration Certificate are available at extra cost.

For gage block accessories, order AC 11.MA Metric Accessory Set in Case.

See rectangular metric block accessories on the next page.

* For complete accuracy specifications, see page at the beginning of this section.



AC11.MA

RECTANGULAR GAGE BLOCK ACCESSORIES STEEL AND CROBLOX®

Rectangular Steel and croblox Accessories Individually or Sets as Stated Below

Individual Accessories			
Description	Cat. No.		Steel Accessories Included Set AC 11.MA
	Steel	croblox®	
Half-Round Jaw 5mm Radius	RA 101.		2**
Straight Jaw* 5mm Thick	RA 104.	RA 204.	2**
Clamps			
0-38mm Capacity	RA 5.		1
38-100mm Capacity	RA 6.		1
100-165mm Capacity	RA 7.		1
0-300mm Capacity	RA 8.		1
Scriber Point	RA 11.		1
Center Point, 2mm C/L	RA 112.		1
Base Block, 25mm Thick	RA 113.		1
Case (CS 9111.)			1
Additional Accessories			
Individual Accessories			
Description	Cat. No.		Steel Accessories Included Set AC 11.MA
	Steel	croblox®	
Clamps			
0-450mm Capacity	RA 9.		
0-600mm Capacity	RA 10.		
0-900mm Capacity	RA 14.		

* croblox jaws available as an option at extra cost. Please specify.

** Jaws are normally used in pairs, but are ordered individually. Please order accordingly.

Rectangular croblox Wear Blocks

Cat. No.	Size
RCM 1.0 WA1	1.0
RCM 2.0 WA1	2.0



GAGE BLOCK SETS

SQUARE COMBINATION CROBLOX® AND STEEL METRIC SYSTEM GAGE BLOCK SETS IN CASE

METRIC



An ideal combination of value, price and convenience, these sets include a popular selection of croblox® and steel as listed.

Gage Block Sets in Case, Two Millimeter Base			B89.1.9 Accuracy Grade 0*
Cat. No.	Measuring Range	Blocks Per Set	Blocks** Included in Sets
S2CS 45.MA1	6.0 through 450 in .001 steps 4.0 through 450 in .01 steps 2.0 through 450 in .1 steps	45	1 block 1.0 - steel 9 blocks 2.001 through 2.009 (steps of .001) 9 blocks 2.01 through 2.09 (steps of .01) 9 blocks 2.1 through 2.9 (steps of .1mm) 9 blocks 1.0 through 9.0 (steps of 1.0mm) 8 blocks 10 through 90 (steps of 10mm) - steel
S2CS 88.MA1	6.0 through 450 in .0005 steps 4.0 through 450 in .001 steps 2.0 through 450 in .01 steps 2.0 through 450 in .1 steps	88	2 blocks .5 and 1.0 - steel 1 block 2.0005 9 blocks 2.001 through 2.009 (steps of .001) 49 blocks 2.01 through 2.49 (steps of .01) 18 blocks 1.5 through 10.0 (steps of .5) 9 blocks 20 through 100 (steps of 10) - steel
S2CS 112.MA1	6.0 through 250 in .0005 steps 4.0 through 250 in .001 steps 2.0 through 250 in .01 steps 2.0 through 250 in .1 steps	112	2 blocks .5 and 1.0 - steel 1 block 2.0005 9 blocks 2.001 through 2.009 (steps of .001) 49 blocks 2.01 through 2.49 (steps of .01) 18 blocks 1.5 through 10.0 (steps of .5) 29 blocks 10.5 through 24.5 (steps of .5) - steel 4 blocks 25m through 100 (steps of 25) - steel
S2C 77.MA1	6.0 through 300 in .0005 steps 4.0 through 300 in .001 steps 2.0 through 300 in .01 steps 2.0 through 300 in .1 steps	77	5 blocks .5, 1.0, 1.5, 2.0, 2.0005 9 blocks 2.001 through 2.009 (steps of .001) 50 blocks 2.01 through 2.50 (steps of .01) 5 blocks 3.0, 3.5, 4.0, 4.5, 5.0 5 blocks 10, 15, 20, 25, 30 3 blocks 50, 75, 100
Gage Block Sets in Case, Two Millimeter Base			B89.1.9 Accuracy Grade 00*
Cat. No.	Measuring Range	Blocks Per Set	Blocks** Included in Sets
S2C 77.MAA	6.0 through 300 in .0005 steps 4.0 through 300 in .001 steps 2.0 through 300 in .01 steps 2.0 through 300 in .1 steps	77	Same as above S2C 77.MA1

Metric croblox® Wear Blocks are available as option. Sets include etched serial numbers and Commercial Calibration Certificate. A Master Calibration Certificate is available at extra cost.

* For complete accuracy specifications, see page at the beginning of this section.

** All blocks are croblox, except as noted.

STEEL SA 711. INTERNAL MEASURING MACHINE JAWS

Double ended, self proving - assures parallelism and squareness. Designed for use with square style gage blocks, jaws are made of hardened steel 50.8mm long, 25.4mm wide and 12mm thick. Both side edges are lapped 90° square to the gaging faces within 30 seconds of arc and extend beyond the gage blocks in the combination, thus forming a square master.

Jaw and gage combination parallelism is checked merely by turning the combination to the opposite side and rechecking the reading. Furnished in pairs.

SA712 and SA711



GAGE BLOCK SETS

SQUARE STEEL – METRIC SYSTEM GAGE BLOCK SETS IN CASE

METRIC



Gage Block Sets in Case, Two Millimeter Base			B89.1.9 Accuracy Grade 0*
Cat. No.	Measuring Range	Blocks Per Set	Blocks Included in Sets
S2S 45.MA1	6.0 Through 450 in .001 Steps 4.0 Through 450 in .01 Steps 2.0 Through 450 in .1 Steps	45	1 Block 1.0 9 Blocks 2.001 Through 2.009 (Steps of .001) 9 Blocks 2.01 Through 2.09 (Steps of .01) 9 Blocks 2.1 Through 2.9 (Steps of .1) 9 Blocks 2.0 Through 10.0 (Steps of 1.0) 8 Blocks 20 Through 90 (Steps of 10)
S2S 77.MA1	6.0 Through 300 in .0005 Steps 4.0 Through 300 in .001 Steps 2.0 Through 300 in .01 Steps 2.0 Through 300 in .1 Steps	77	5 Blocks .5, 1.0, 1.5, 2.0, 2.0005 9 Blocks 2.001 Through 2.009 (Steps of .001) 50 Blocks 2.01 Through 2.50 (Steps of .01) 5 Blocks 3.0, 3.5, 4.0, 4.5, 5.0 5 Blocks 10, 15, 20, 25, 30 3 Blocks 50, 75, 100
S2S 88.MA1	6.0 Through 450 in .0005 Steps 4.0 Through 450 in .001 Steps 2.0 Through 450 in .01 Steps 2.0 Through 450 in .1 Steps	88	2 Blocks .5, 1.0 1 Block 2.0005 9 Blocks 2.001 Through 2.009 (Steps of .001) 49 Blocks 2.01 Through 2.49 (Steps of .01) 18 Blocks 1.5 Through 10.0 (Steps of .5) 9 Blocks 20 Through 100 (Steps of 10)
S2S 112.MA1	6.0 Through 250 in .0005 Steps 4.0 Through 250 in .001 Steps 2.0 Through 250 in .01 Steps 2.0 Through 250 in .1 Steps	112	1 Block .5 1 Block 2.0005 9 Blocks 2.001 Through 2.009 (Steps of .001) 49 Blocks 2.01 Through 2.49 (Steps of .01) 48 Blocks 1.0 Through 24.5 (Steps of .5) 4 Blocks 25 Through 100 (Steps of 25)
SS 8.MA1X	125 to 2100	8	8 Blocks 125, 150, 175, 200, 250, 300, 400, 500 Accessories Included: 6 Each SA 8. Studs 2 Each SA 9. Flat Head Screws (long) 2 Each SA 10. Flat Head Screws (short) 1 Each SA 16. 114-152 Tie Rod (adjustable) 1 Each SA 17. 152-228 Tie Rod (adjustable) 1 Each SA 18. 298 Tie Rod 1 Each SA 19. 400 Tie Rod 2 Each SA 20. 502 Tie Rods
Cat. No.	Measuring Range	Blocks Per Set	B89.1.9 Accuracy Grade 00*
SS 8.MAAX	125 to 2100	8	Blocks Included in Sets Same as Above SS 8.MA1X

Sets include etched serial numbers and Commercial Calibration Certificate. A Master Calibration Certificate is available at extra cost.

* For complete accuracy specifications, see page at the beginning of this section.



GAGE BLOCK SETS

SQUARE STEEL OR CROBLOX[®] – METRIC SYSTEM GAGE BLOCK ACCESSORIES

METRIC



Square Steel Accessories Individually or Sets as Stated Below

Individual Accessories	Cat. No.	Steel Accessories Included
Half-Round Jaw**		
3mm Radius	SA 101.	2
6mm Radius	SA 102.	2
Straight Jaw**		
12mm Thick	SA 103.	2
Scriber Point	SA 4.	1
Center Point 2mm C/L	SA 105.	1
Base Block 12mm Thick	SA 106.	1
Knurled Screw	SA 7.	2
Stud	SA 8.	2
Flat Head Screw		
Long	SA 9.	2
Short	SA 10.	2
Slotted Nut	SA 11.	2
Tie Rods		
19mm Solid	SA 12.	1
38mm Solid	SA 13.	1
57mm Solid	SA 14.	1
76mm Solid	SA 15.	1
114-152mm Adjustable	SA 16.	1
152-228mm Adjustable	SA 17.	1
Case (CS 9168.)		1

Additional Accessories

Individual Accessories	Cat. No.
Tie Rods	
298mm	SA 18.
400mm	SA 19.
502mm	SA 20.

** croblox[®] jaws available as an option at extra cost. Please specify.

** Jaws are normally used in pairs, but are ordered individually. Please order accordingly.

Square croblox[®] Wear Blocks

Cat. No.	Size
SCM 2.0 WA1	2.0mm with 1 Side Countersunk



GAGE BLOCK SETS

INDIVIDUAL RECTANGULAR AND SQUARE GAGE BLOCKS - METRIC SYSTEM

croblox®, CERAMIC AND STEEL

RECTANGULAR BLOCK SIZES

- Width: all blocks are 9mm wide
- Length: For blocks 10mm thick and under, length is 30mm
For blocks 10.5mm thick and above, length is 35mm

Exceptions:

*Blocks are 28.3mm long

** When ordering 0.5mm block, specify length (28.3 or 30mm)

Individual Rectangular Gage Blocks		croblox®		Ceramic		Steel
Size/Millimeters	Grade	A1 0	AA 00	A1 0	AA 00	A1 0
0.3, 0.4*						•
0.5**		•	•	•	•	•
0.6 Through 0.9 in .1 Steps*						•
1.0 or 1.0005		•	•	•	•	•
1.0 Wear Blocks		•				
1.001 Through 1.009 in Steps of .001		•	•	•	•	•
1.01 Through 1.14 in Steps of .01		•	•	•	•	•
1.15 Through 1.49 in Steps of .01		•	•	•	•	•
1.5 Through 1.9 in Steps of .1		•	•	•	•	•
2.0		•	•	•	•	•
2.0 Wear Blocks		•				
2.25						•
2.5		•	•	•	•	•
3.0 Through 4.5 in Steps of .5		•	•	•	•	•
5.0 Through 6.5 in Steps of .5		•	•	•	•	•
7.0 Through 10.0 in Steps of .5		•	•	•	•	•
10.5 Through 14.5 in Steps of .5		•	•			•
15.0		•	•	•	•	•
15.5 Through 19.5 in Steps of .5		•	•			•
20.0		•	•	•	•	•
20.5 Through 24.5 in Steps of .5		•	•			•
25.0 and 30.0		•	•	•	•	•
40.0		•	•	•	•	•
50.0		•	•	•	•	•
60.0		•	•	•	•	•
70.0		•	•	•	•	•
75.0 and 80.0		•	•	•	•	•
90.0		•	•	•	•	•
100.0		•	•	•	•	•

SQUARE BLOCK SIZES

- All blocks are 24.1mm x 24.1mm
- Blocks have a 6.7mm hole in the center
- On blocks 5.0mm thick and over, the hole is countersunk on both faces. (croblox Wear Blocks are countersunk on one face only)

Individual Square Gage Blocks		croblox®		Steel	Steel Only	
Size/Millimeters	Grade	A1 0	AA 00	A1 0	A1 0	AA 00
0.5 mm		•	•	•		
1.0		•	•	•		
1.5		•	•	•		
2.0 Wear Blocks with 1 Side Countersunk		•				
2.0 or 2.0005		•	•	•		
2.001 Through 2.009 in .001 Steps		•	•	•		
2.01 Through 2.49 in .01 Steps		•	•	•		
2.5 Through 2.9 in .1 Steps		•	•	•		
3.0 Through 10.0 in .5 Steps		•	•	•		
10.5 Through 14.5 in .5 Steps					•	
15mm		•	•	•		
15.5 Through 19.5 in .5 Steps					•	
20.0mm		•	•	•		
20.5 Through 24.5 in .5 Steps					•	
25.0		•	•	•		
30.0		•	•	•		
40.0					•	
50.0		•	•	•		
60.0					•	
70.0					•	
75.0		•	•	•		
80.0					•	
90.0					•	
100.0		•	•	•		
125.0					•	•
150.0					•	•
175.0					•	•
200.0					•	•
250.0					•	•
300.0					•	•
400.0					•	•
500.0					•	•

HOW TO ORDER

Specify in this sequence: Shape, Material, "M" for Metric, Size and Accuracy Grade

Shape	Material	Size	Accuracy
R=Rectangular	S=Steel	Listed in table	Listed in table
S=Square	C=croblox®		
	Y= Ceramic		

Example: RSM 2.0.A1 = Rectangular Steel block, Metric size 2.0, Grade A1 Accuracy



REFERENCE BARS

STANDARD REFERENCE BARS

12", 19", 25", 37", 49"/300, 500, 650, 950, 1250MM

These Standard Reference Bars are invaluable for use in checking table movement of machine tools, accuracy of vernier height gages, surface plate transfer measurement, and for final inspection of precision machine tools and coordinate measuring machines.

The "channel design" places additional measuring pads at appropriate points over the length of the bar as reference points for x, y or z axis measurements. Channel design permits use of the bar on its base (vertical), or on its back, or either side (horizontal). The alternating gage block jaws and spacer blocks are permanently wrung and fastened together to form 1" increments for inch bars and 25mm increments for metric bars.

A special bushing arrangement allows the master stack to conform to thermal conditions prevailing during use, thus providing a true master even under less than perfect laboratory conditions. Mating surfaces are treated during assembly to prevent corrosion.

Non-standard lengths and measuring increments are available on special order. A Certificate of Calibration is included. All models are furnished with storage case.

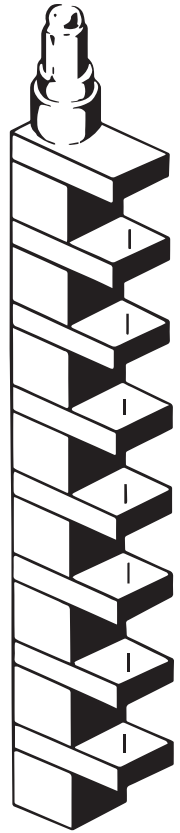

With Channel Design

Inch System			Millimeter System		
Cat. No.	EDP	Size	Cat. No.	EDP	Size
RBC 12.	92626	12"	RBCM 300.	93642	300mm
RBC 19.	92627	19"	RBCM 500.	92617	500mm
RBC 25.	92628	25"	RBCM 650.	93053	650mm
RBC 37.	92629	37"	RBCM 950.	92619	950mm
RBC 49.	92630	49"	RBCM 1250.	92620	1250mm

Free Standing Stack Without Channel Design – Vertical Position Only

Inch System			Millimeter System		
Cat. No.	EDP	Size	Cat. No.	EDP	Size
RB 8.	92616	8"	RBM 200.	93261	200mm
RB 10.	92623	10"	RBM 250.	93262	250mm
RB 12.	92624	12"	RBM 300.	93263	300mm
RB 18.	92625	18"	RBM 450.	93264	450mm

Specifications

Description	Inch System	Millimeter System
Tolerance (Stack)	expressed in μin .	expressed in μm
Maximum:	2.5L + 10L in inches	.0025L + .25L in millimeters
Minimum:	- 10	- .25
Parallelism: Gage Surfaces to Base and Each Other	15 μin .	0.4 μm
Uncertainty of Calibration	10 + 2.0L in inches expressed in μin .	.25 + .002L in millimeters expressed in μm .

The accuracy of the surface that supports the gage must be taken into account when determining the accuracy of any measurements.

Standard Sizes are 12", 19", 25", 37" and 49" in the inch system and 300mm, 500mm, 650mm, 950mm and 1250mm in the millimeter system





AG 18.W



AG 16.R

GAGE BLOCK SETS

ANGLE GAGE BLOCK SETS

Angle Gage Blocks permit fast, simple and accurate measurements of any angle. They are far superior to sine bar measuring methods, that involve trigonometric formulae and complex stacks of gage blocks.

Angle gage blocks come in three accuracies: croblox® Reference Angle Blocks with a 1-second accuracy, steel Calibration Grade Angle Blocks with 2-second accuracy, and steel Working Grade Angle Blocks with 5-second accuracy. Each grade can be purchased in sets that will measure in steps of one-second, one-minute or one-degree to suit any need. (See angle block specification information on next two pages.)

- **Reference Angle Blocks croblox: 1-second accuracy.** Designed for optical or as reference standards for autocollimators, spectrometers, etc. They are unsurpassed for use in aerospace, optical, and precision instrument fields.
- **Calibration Angle Blocks Steel: 2-second accuracy.** The same high quality as the Reference Grade Angle Blocks.
- **Working Angle Blocks Steel: 5-second accuracy.** These angles are designed for shop or tool room. The longer gaging surfaces are made for use with an indicator. These blocks reduce set-up time and minimize error in grinding both simple and compound angles.

Angle Gage Block Sets in Case				
Cat. No.	Description/Accuracy Grade	Blocks Per Set	Measuring Range	Blocks Included In Sets
AG 6.R AG 6.C	Reference Grade ± 1.0 Second Calibration Grade ± 2.0 Seconds	6	0-99° in 1° Steps	6 Blocks: 1°, 3°, 5°, 15°, 30°, 45°
AG 11.R AG 11.C	Reference Grade ± 1.0 Second Calibration Grade ± 2.0 Seconds	11	0-99° in 1' Steps	6 Blocks: 1°, 3°, 5°, 15°, 30°, 45° 5 Blocks: 1', 3', 5', 20', 30'
AG 16.R AG 16.C	Reference Grade ± 1.0 Second Calibration Grade ± 2.0 Seconds	16	0-99° in 1" Steps	6 Blocks: 1°, 3°, 5°, 15°, 30°, 45° 5 Blocks: 1", 3", 5", 20", 30" 5 Blocks: 1", 3", 5", 20", 30"

Cases for Angle Gage Block Sets	
Cat. No.	Description
CS 9135	Calibration Set and Reference Case

* One 6" (150mm) parallel and one 6" (150mm) knife edge are included with Working Grade Sets in addition to the listed sizes.

To Order Individually, Specify in the Following Key Sequence:			
Angle Gage Prefix	Numeric Size of Angle	Angle Units (Degree, Min., Sec.)	Accuracy Grade R or C
AG	45	D	R

Example: AG 45.DR = a Reference 45° Angle Block
AG 30. MC = Calibration Grade 30' Angle Block

NOTE: The catalog numbers and specifications of our angle gage blocks have been changed in response to updated requirements concerning the application of the uncertainty of measurement. See the next two pages for information regarding the specifications of our angle blocks.



WEBBER GAGE BLOCKS

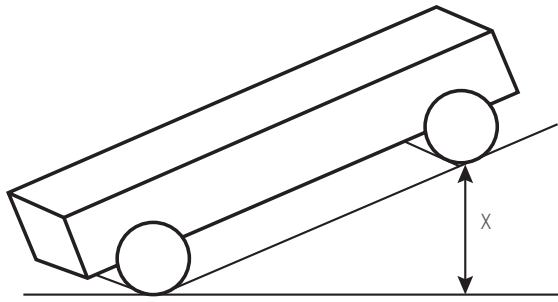

USING ANGLE GAGE BLOCKS

SUPERIOR TO SINE BAR METHODS

A precision angle has always been difficult to set because of the involved trigonometric formula that is used with the sine bar.

The main difficulty lies in the dimension X in diagram, which often results in a figure with many decimal places. Gage blocks can only approximate this value. For example, to measure 44° 30' using a 5" sine bar the following steps are required:

Sine for 44° 30' angle	.7009093
For dimension X multiply by 5	3.5045465
	.1005
	.104
Gage Blocks necessary to match this dimension	.300
	3.000
	3.5045

3.5045465 – 3.5045 = Residual error .0000465
This error cannot be eliminated in sine bar procedure.

With angle gage blocks, you take a 45° block from the set, wring on a 30° block so that the plus end of 45° block contacts the minus end of 30° block, and you have an angle of 44° 30'. It is not only easy to accomplish, it is absolutely accurate.

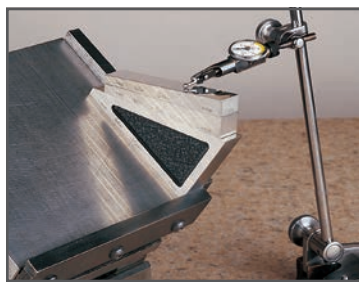

SETTING A REVOLVING MAGNETIC CHUCK

A chuck is set for a 38° angle. Three blocks, +30°, +5° and +3°, are assembled and mounted with the parallel*. The indicator quickly tells if the setting is accurate. Adjustment is a matter of seconds. A revolving chuck teams up perfectly with angle blocks to make possible several applications in tool grinding that are more difficult with other methods.

EASE AND VERSATILITY

A set consisting of only 16 blocks will measure 356,400 angles in steps of one second, to an accuracy of 1/5,000,000th of a circle! These micro-accurate blocks can be used in either plus or minus positions. In example "A", take the 30° angle and add the 5° angle to obtain a measurement of 35° (making sure that both plus ends are together). In "B", use the same two blocks but wring them together so that the minus end of the 5° block is over the plus end of the 30° block. This will subtract 5° from 30°, thus giving a 25° measurement.

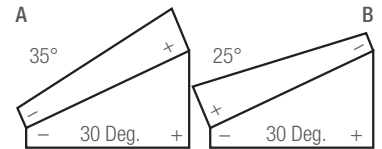

INDEXING A LARGE ROTARY TABLE

A Webber Angle Block or True Square is positioned on the work and a beam of light from an autocollimator is directed against the gaging surface. This becomes 0°, or the reference surface. Other angle blocks are then added in proper combination to measure each succeeding angle. The table is rotated and inspected at each position with reference to the light beam. This method indexes large workplaces quickly, with accuracy measured in fractional seconds.

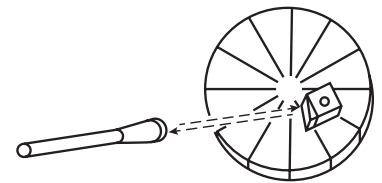

INSPECTING A SIMPLE ANGLE

The photo above shows a workpiece on which an angle of 30° is required. The workpiece is resting on a parallel* which is wrung to angle blocks forming 30°. The entire set-up is lined up vertically with an angle plate and then indicated across the top of the work to determine the correctness of the angle.



*Parallels are not necessary, but they are convenient because of their longer reference surface.

Angle Gage Block Specifications	Accuracy In Microinches (Microns)	
Material	Reference Grade croblox®	Calibration Grade Steel
Tolerances: Deviation From Nominal	±1.0 second	±2.0 second
Flatness of Gaging Surfaces	6µin. (0.15µm)	8µin. (0.20µm)
Flatness and Parallelism of Sides	8µin. (0.20µm)	8µin. (0.20µm)
Squareness of Sides to Gaging Surfaces	6 seconds	8 seconds
Area of Gaging Surfaces†	1 x 2" (25 x 50mm)	1 x 2" (25 x 50mm)
Surface Finish (Gage Surfaces Only)	0.4µin. AA (.01µm AA)	0.6µin. AA (.015µm AA)
Estimated Uncertainty of Measurement (k=2)	0.6 seconds	1.0 seconds

Flatness tolerances exclude 1.5mm from the edges on all angle blocks, except where marked with **. Then 3mm from the edge is excluded.
† Dimension of gaging surfaces in millimeters is approximate.



WEBBER GAGE BLOCKS

TRUE SQUARES

True squares are designed for fast, precision indexing with angle gage blocks.

All faces of Webber True Squares are at precisely 90° to adjacent sides, with perfect optical flatness and parallelism to permit use with autocollimators.

Applications for fast precision indexing and setting of angular grinding fixtures are almost unlimited. For example: the work and the true square are mounted together on a revolving fixture. A notch is ground by two successive cuts, one at 90° with the true square, and the other at 2° with the addition of two angle blocks (+3° and -1°) mounted on square. An indicator reading is taken before each grind. This process is then repeated by turning the True Square to successive zero readings.

True Squares are designed for use as an accessory to our angle gage blocks to easily make angles greater than 45° and through 180°.

Webber True Squares also permit a fast, easy check of indexing tables. The gaging faces are at precise 90° angles with optical flatness and finishes that permit the use of autocollimators.

The catalog numbers and specifications of our True Squares have been changed in response to updated requirements concerning the application of the uncertainty of measurement.

True Square Specifications				
Cat. No.	TS 21.R	TS 21.C	TS 44.W	TS 66.W
Grade	Reference	Calibration	Working	Working
Material	croblox®	Steel	Steel	Steel
Tolerances: Deviation From Nominal	±1.0 second	±2.0 second	±5.0 second	±5.0 second
Flatness of Gaging Surfaces	6µin. (0.15µm)	8µin. (0.20µm)	14µin. (0.35µm)*	14µin. (0.35µm)*
Flatness & Parallelism of Sides	8µin. (0.20µm)	8µin. (0.20µm)	16µin. (0.40µm)*	16µin. (0.40µm)*
Squareness of Sides to Gaging Surfaces	6 seconds	8 seconds	12 seconds	12 seconds
Area of Gaging Surfaces†	1" x 2" (25 x 50mm)	1" x 2" (25 x 50mm)	5/8" x 4" (16 x 100mm)	5/8" x 6" (16 x 150mm)
Surface Finish (Gage Surfaces Only)	0.4µin. AA (0.01µm AA)	0.6µin. AA (.015µm AA)	1.0µin. AA (.025µm AA)	1.0µin. AA (.025µm AA)
Estimated Uncertainty of Measurement (K=2)	0.6 seconds	1.0 seconds	3.5 seconds	4.0 seconds

Flatness tolerances exclude 1.5mm from the edges on all angle blocks except where marked with *. Then, 3mm from the edge is excluded.
 † Dimension of gaging surfaces in millimeters is approximate.

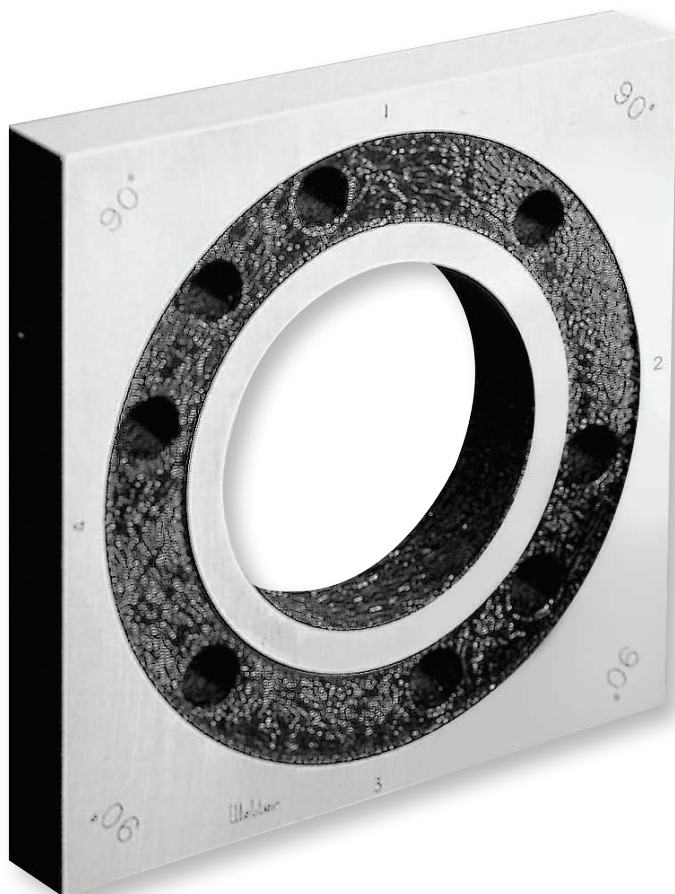

True Square



CROBLOX[®]

CROBLOX REFLECTING CUBES

Stable and maintenance free, reflecting cubes are ideal for 90° indexing or alignment in optical tooling or inspection.

croblox[®] Reflecting Cube

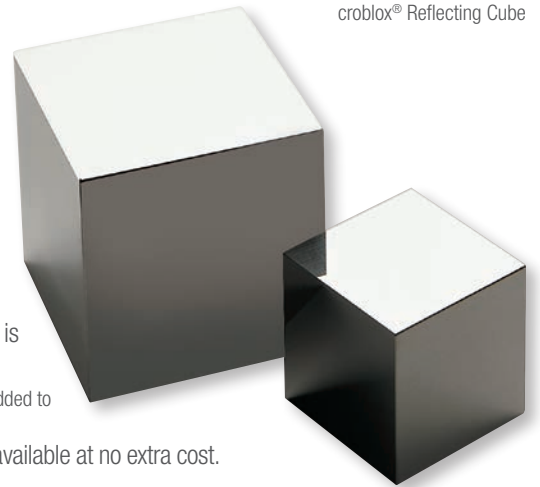

TO ORDER, SPECIFY THE FOLLOWING INFORMATION:

- The number and position of all finished sides, including the base:
 - NOTE:** for fixturing purposes during manufacturing, the bottom face must be one of the finished sides. The bottom face is etched with the Webber logo, a serial number, and face identifications as applicable.
- Specify the manufacturing tolerances of the 90° angles, 1 second, 3 seconds, or other angular specification.
- A certificate of calibration showing the deviation from 90° of the finished sides is available at extra cost.
 - NOTE:** Our uncertainty of measurement is estimated to be ±1.0 seconds. This uncertainty should be added to the manufacturing tolerance to give practical tolerance of the cube.
- If requested, a copy of the material certificate from our supplier of chrome-carbide is available at no extra cost.

To Order Webber Optical Cubes

Specify all 6 parts to the part number

Prefix	Size	Face Code	Hole Pattern	Hole Type	Accuracy
CUBE	.50	A thru K (See Face Table)	(blank) or 1 thru 4 (See Hole Pattern Chart)	(blank) or	1 SEC* 3 SEC* 5 SEC 10 SEC
	.75			S=Fine Thrd	
	1.0			T=Coarse Thrd	
	1.5			U=Thru Hole	
	2.0			V=Thru Hole with C-Sink Y=C'Bore thru hole (See Hole Pattern Chart for available dimensions)	

*Not Available In 0.50" Size

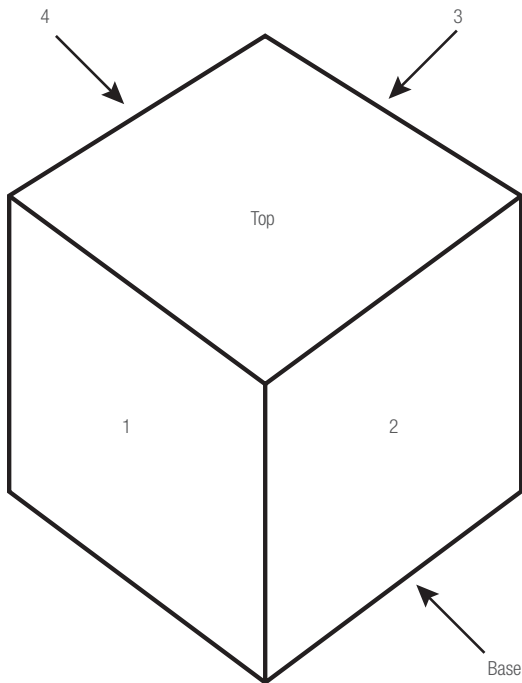

Cubes are made to order from semifinished blanks in six standard sizes: 0.50" (12.7mm), 0.75" (19.0mm), 0.95" (24.1mm), 1.00" (25.4mm), 1.50" (38.1mm), and 2.00" (50.8mm). Also available is a .950" (24.1m) square with a 17/64" (6.7mm) countersunk center hole.

Example: CUBE 1.0 A 3SEC

CUBE 1.0 = 1" Cube
 A = finished 6 sides
 1SEC = orthogonal to 3 second accuracy.
 (No holes were specified in this example.)

Reflectivity of finished faces is nominally:
 Visible Blue Light ($\lambda = 4200 \text{ \AA}$) $\approx 50\%$
 Visible Red Light ($\lambda = 6900 \text{ \AA}$) $\approx 60\%$
 Infrared ($\lambda = 10.6 \mu\text{m}$) $> 80\%$
 We are unable to measure or certify reflectivity. If reflectivity testing is required, the user must arrange for testing through a third party.

Face Code Table

Face Code	No. of Finished Faces	Finished Faces
A	6	ALL
B	5	1-2-3-4-Base
C	5	1-2-3-Top-Base
D	4	1-2-3-Base
E	4	1-3-Top-Base
F	4	1-2-Top-Base
G	3	1-3-Base
H	3	1-2-Base
J	3	1-Top-Base
K	2	1-Base



Hole Pattern Dimensions and Hole Types

Dimensions are shown in Inches.

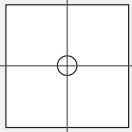
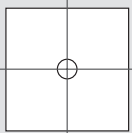
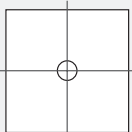
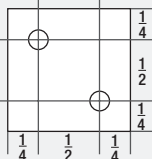
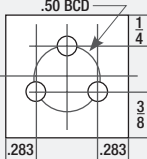
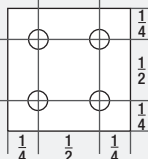
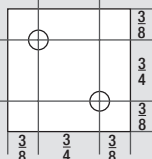
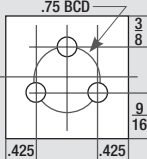
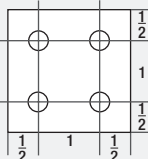
	Hole Pattern-1	Hole Pattern-2	Hole Pattern-3	Hole Pattern-4
CUBE .50	 <p>Min. Good Thread .28 T1 S1 T2 S2 U0 U1 U2 U3 V0 V1 C'Bore Depth = .20" Y0 Y1 Y2</p>			
CUBE .75	 <p>Min. Good Thread .40 T1 S1 T2 S2 U1 U2 U3 U4 V1 V2 V3 V4 C'Bore Depth = .38" Y1 Y2 Y3</p>	 <p>Min. Good Thread .40 T1 S1 T2 S2 U1 U2 U3 C'Bore Depth = .38" Y1</p>		
CUBE .95	 <p>.266 Dia. Thru Hole 72° C-Sink. Min. 100" Deep for #8 Flat Head Screw</p>			
CUBE 1.0	 <p>Min. Good Thread .50 T2 S2 T3 S3 T4 S4 U2 U3 U4 V2 V3 V4 C'Bore Depth = .50" Y2 Y3 Y4</p>	 <p>Min. Good Thread .50 T2 S2 T3 S3 U2 U3 U4 C'Bore Depth = .50" Y2</p>	 <p>.50 BCD Min. Good Thread .50 T2 S2 T3 S3 U2 U3 U4 C'Bore Depth = .50" Y2</p>	 <p>Min. Good Thread .50 T2 S2 T3 S3 U2 U3 U4 C'Bore Depth = .50" Y2</p>
CUBE 1.5	 <p>Min. Good Thread .62 T3 S3 T4 S4 U3 U4 U5 V3 V4 V5 C'Bore Depth = .75" Y3 Y4 Y5</p>	 <p>Min. Good Thread .62 T3 S3 T4 S4 U3 U4 U5 V3 V4 C'Bore Depth = .75" Y3 Y4</p>	 <p>.75 BCD Min. Good Thread .62 T3 S3 T4 S4 U3 U4 U5 V3 V4 C'Bore Depth = .75" Y3 Y4</p>	 <p>Min. Good Thread .62 T3 S3 T4 S4 U3 U4 U5 V3 V4 C'Bore Depth = .75" Y3 Y4</p>
CUBE 2.0	 <p>Min. Good Thread .75 T3 S3 T4 S4 U4 U5 U6 V3 V4 V5 C'Bore Depth = 1.25" Y4 Y5</p>	 <p>Min. Good Thread .75 T3 S3 T4 S4 U4 U5 U6 V3 V4 V5 C'Bore Depth = 1.25" Y4 Y5</p>	 <p>1.0 BCD Min. Good Thread .75 T3 S3 T4 S4 U4 U5 U6 V3 V4 V5 C'Bore Depth = 1.25" Y4 Y5</p>	 <p>Min. Good Thread .75 T3 S3 T4 S4 U4 U5 U6 V3 V4 V5 C'Bore Depth = 1.25" Y4 Y5</p>

Legend for Hole Types

Threaded Hole		Thru Hole	72° Countersunk Hole	Counterbore Hole for Cap Head Screw	
T1 = 6-32	S1 = 6-40	U0 = 0.128 Dia. for #4 Screw	V0 = 0.128 Dia. for #4 Screw	Y0 = for #4 Screw 0.128 Dia. Thru Hole	0.21 Dia. C'Bore
T2 = 8-32	S2 = 8-36	U1 = 0.156 Dia. for #6 Screw	V1 = 0.156 Dia. for #6 Screw	Y1 = for #6 Screw 0.180 Dia. Thru Hole	0.29 Dia. C'Bore
T3 = 10-24	S3 = 10-32	U2 = 0.180 Dia. for #8 Screw	V2 = 0.180 Dia. for #8 Screw	Y2 = for #8 Screw 0.180 Dia. Thru Hole	0.29 Dia. C'Bore
T4 = 1/4-20	S4 = 1/4-28	U3 = 0.206 Dia. for #10 Screw	V3 = 0.206 Dia. for #10 Screw	Y3 = for #10 Screw 0.206 Dia. Thru Hole	0.34 Dia. C'Bore
		U4 = 0.266 Dia. for 1/4" Screw	V4 = 0.266 Dia. for 1/4" Screw	Y4 = for 1/4" Screw 0.266 Dia. Thru Hole	0.40 Dia. C'Bore
		U5 = 0.328 Dia. for 5/16" Screw	V5 = 0.328 Dia. for 5/16" Screw	Y5 = for 5/16" Screw 0.332 Dia. Thru Hole	0.50 Dia. C'Bore
		U6 = 0.391 Dia. for 3/8" Screw			

Tolerances are ± .010" except for Counterbore depth: ± .020"

Example: CUBE 1.5 D 2 Y4 1SEC

CUBE 1.5 = 1-1/2" Cube

D = finished front, right, and base

2 = two holes located in corners of the cube (See Pattern Table for hole location)

Y4 = .266 Dia. thru hole with .40 Dia C'Bore for 1/4" cap screw

For 1.5" cube, C'Bore depth = .75" (See Pattern Table)

1SEC = finished sides orthogonal to 1 second accuracy



OPTICAL

OPTICAL POLYGONS

Webber Optical Polygons provide an easy, accurate method of checking and calibrating angles. They are designed for use with autocollimators in measuring angle spacing.

The exclusive one-piece design provides compact, fixed master for precise angle spacing. Target faces are highly reflective and optically flat.

Chrome carbide polygons provide a hardness of Rockwell 71-73 C and a corrosion resistance 10-20 times that of 18-8 stainless steel, resulting in lifetime accuracy.

Maintenance problems are virtually eliminated due to their ruggedness and extreme stability.

A 1" mounting hole, flanged bushing, lapped washer and hold-down bolt, furnished with each unit, permit mounting the polygon in any desired attitude. Available in two accuracy grades. Furnished in case. Certificate of Calibration included.



Optical Polygon

Optical Polygon Specifications						
No. of Sides	Angle Spacing Degrees	Diameter Across Corners in (mm)	Height in (mm)	Target Size in (mm)	Area Sq. In.	Area Sq. Cm.
3	120					
4	90					
5	72					
6	60	2.90" (73.6mm)	.880" (22.3mm)	.75" x .75" (19 x 19mm)	.56	3.60
8	45					
9	40					
10	36					
12	30					

To order polygons, specify number in the following key/sequence:

Optical Polygon OP
No./Faces
Decimal
Accuracy Grade

Example: OP 3.0 = A 3-sided optical polygon with a 0 Reference Accuracy

Optical Polygon Specifications			
Accuracy Grade	Target Area Flatness*	Accuracy of Calibration (Uncertainty)	Maximum Deviation of Faces from Nominal 3-12
Reference: 0 Calibration: 1	4 μin. (.10 μm)	±1.0 sec.	±1.0 sec. ±2.0 sec.

* Excludes .020" (0.5mm) from edges.

All sizes: Flatness and parallelism – top and bottom – .00005"; maximum pyramidal error ±15 seconds.

FUSED QUARTZ OPTICAL FLATS



Fused Quartz Opticla Flat

For visually checking the flatness of seals, gages and mating surfaces. Through means of interpreting light interference patterns or bands, the optical flat provides a simple, accurate precision method for measuring surface flatness. Flats are crafted from high quality fused quartz and provide the maximum resistance to wear, damage and temperature variations.

Starrett-Webber optical flats are available in single or double surfaces and three accuracy grades. The double flat has both surfaces finished to tolerance but not necessarily parallel. Double flats provide longer service because wear is distributed over two surfaces. All are furnished with case.

Coating is available and it aids readability when applied to one surface. Coating is of value on single-sided flats only. Coating on a double surface will reduce the readability of the other surface.

When ordering, specify size, accuracy grade, single or double side, and coated or not.

Fused Quartz Optical Flats, Accuracy Grades	
Reference Grade	1 μin. (.03 μm)
Master Grade	2 μin. (.05 μm)
Working Grade	4 μin. (.10 μm)

Fused Quartz Optical Flats, Standard Sizes*		
1 x 1/2" (25 x 12.7mm)	3 x 11/16" (75 x 17.5mm)	5 x 7/8" (125 x 22mm)
2 x 5/8" (50 x 16mm)	4 x 3/4" (100 x 19mm)	6 x 1" (150 x 25mm)

* Dimensions shown in millimeters are approximate.

Larger sizes available on special order.

Optical flats are made to U.S. Federal Specifications GG-O-635. Certificate of Calibration available at extra cost.

Accuracy of Calibration (uncertainty) 3μin. (0.08μm).





CHAMOIS

These Starrett-Webber synthetic chamois cloths, rather than natural chamois, are recommended for wiping gage surfaces. They can be used with solvents and oils, including Starrett M-1® All-Purpose Lubricant, and are washable in detergents.

Chamois	
Cat. No.	Description
CH 1.	Dry
CH 2.	Lubricated

CH 1.

GAGE BLOCK STONES

If a block does not wring together with other blocks, it may be the result of nicks or other damage. Examine blocks carefully with a magnifying glass. If a small burr is found, it may be removed with a gage block stone.

Starrett-Webber stones, when used moderately, may be rubbed directly on the gaging surfaces without danger of decreasing the size of the gage block. Available in 3 styles/ materials as listed.

GS 13 is recommended for use with steel gage blocks

SAO 13 is recommended for general use. Steel, ceramic, or carbide blocks

SAO 23 is recommended for use with carbide and ceramic gage blocks



Gage Block Stones

Gage Block Stones		
Cat. No.	For Block Material	Description
GS 13.	Steel	Black Granite Stone, 1/4 x 1 x 3" (6.3 x 25 x 75mm)
SAO 13.		Sintered Aluminum Oxide, 5/16 x 1 x 3" (8 x 25 x 75mm)
SAO 23.	Steel or Carbide	Serrated Aluminum Oxide with Case, 1 x 2 x 3" (25 x 50 x 75mm)





NVLAP LAB CODE 200038-0

ACCREDITED GAGE BLOCK CALIBRATION SERVICE

In accordance with: ISO 17025
ANSI/NCSL Z540-1
ISO 10012-1
former MIL-STD-45662A

MASTER CALIBRATION

The calibration procedure is regarded as a process to be controlled and monitored using SPC techniques. Information that would enable the analysis of control data is to be recorded and can be made available to the user upon request (at extra cost). A second master, sometimes referred to as a control block, is used in the calibration. The purpose of the second master is to generate known difference reading which can be analyzed. The average of the known differences of several readings of the two masters and the range of their differences can be analyzed using statistical techniques. The calibration process can be demonstrably controlled.

Reported measurement uncertainties based upon a 95% confidence level (two standard deviations) are dynamic, reflecting the current performance of the specific equipment and operator. Other factors included in the stated uncertainty are derived from a detailed error analysis. The error analysis is based upon experimentation whenever possible or industry consensus from estimates derived from NIST publications. Experimental checks of the stated uncertainty levels are made using laboratory comparison techniques involving both internal repeatability studies and external comparisons with other calibration laboratories.

Our Reference Gage Blocks are calibrated directly by NIST. All other reference standards are periodically checked and calibrated either by NIST or NVLAP accredited laboratories. Documented histories are maintained. Statistical methods are used to control all of our master gages.

NOTICE: Webber Gage cannot recommend recalibration due dates on our calibration certificates or calibration stickers. Recalibration due dates must be provided to us at the time of order. If this information is not provided, the recalibration due date will be left blank for the user to add.

LABORATORY CALIBRATION

Each block calibrated using our Laboratory Calibration procedure is calibrated three times using our Master Calibration procedure as described above - Using different transfer master blocks, operators and equipment when possible for all three measurements. The results are averaged together and reported. This results in the lowest possible uncertainty reported to the user as random errors in the measuring process are averaged out.

This calibration service is restricted to Webber rectangular croblox® gage blocks of Webber grades LM or AA, GGG grades 0.5 and 1, and B89 grades 00 and K.

COMMERCIAL CALIBRATION

Calibrations are performed using the same program as our Master calibrations except that the second master, the control block, is omitted. By omitting this control block some of the statistical tests are also omitted which results in larger uncertainty.

All necessary information to confirm the calibration is recorded. All raw data from the comparator, the temperature of the blocks, the temperature of the comparator, and the relative humidity of the surrounding environment is recorded for each measurement. Applied correction factors are broken down and are recorded, as well as the results of any calibrations.

Our Reference Gage Blocks are calibrated directly by the National Institute of Standards and Technology. All other reference standards are calibrated either by NIST or NVLAP accredited laboratories. Documented histories are maintained of our measuring and test equipment. Statistical methods are used to control our Master Gage Blocks.

Reported uncertainties are based on a 95% confidence level. Experimental checks of the uncertainty are made using laboratory comparison techniques involving repeatability studies and external comparisons with other calibration laboratories.

Approximate Best Uncertainty (k=2) for blocks through 4" (100mm) in length

Grade	Commercial Calibration		Master Calibration		Laboratory Calibration	
	Uncertainty	Minimum	Uncertainty	Minimum	Uncertainty	Minimum
Webber LM					0.65 + 0.7L	1.4µin
GGG 0.5					.016 + .0007L	.035µm
Webber AA						
B89 Grade 00, K	1.6 + 1.0L	2.4 µin	1.2 + 0.7L	1.7µin	0.65 + 0.7L	1.4µin
GGG 1	.04 + .001L	.060µm	.03 + .0007L	.045µm	.016 + .0007L	.035µm
Webber A1						
B89 Grade 0	2.0 + 1.0L	3.0 µin	1.8 + 0.7L	2.0µin		
GGG 2	.05 + .001L	.075µm	.045 + .0007L	.050µm		
B89 Grade AS1	2.0 + 1.0L	3.0 µin	1.8 + 0.7L	2.0µin		
GGG 3	.05 + .001L	.075µm	.05 + .0007L	.050µm		

NVLAP® accreditation does not constitute an endorsement of any product by NVLAP® or any agency of the U.S. Government.



STARRETT-WEBBER GAGE CALIBRATION

GAGE BLOCK CALIBRATION SERVICES

We offer expert and comprehensive gage block calibration and repair services for Starrett-Webber gage blocks.

Calibration will help you prevent production inaccuracies. It will identify a worn gage block before it can create a problem. Regular, periodic calibration of your gage blocks will ensure that your gage blocks are as accurate and dependable as when they were new.

COMPREHENSIVE AND FAST

Starrett-Webber gage block calibration is performed promptly – your gage blocks will be ready to be returned to you within a few days after we receive them.

The calibration process is as follows:

1. After receiving your gage blocks, we document their arrival, then clean each block to remove oil, grease and film. The case is also thoroughly cleaned.
2. Next, we lightly stone each block to remove small nicks and burrs. This does not guarantee that the blocks will wring if they are heavily nicked, scratched, or burred.
3. Your gage blocks are then individually compared with master blocks that are accurate to fractions of one millionth of an International Inch. Starrett-Webber Grand Master Blocks are Starrett-Webber croblox® (solid chrome carbide). Our exclusive Grand Master Gage Blocks are calibrated directly by the U.S. National Institute of Standards and Technology (NIST).
4. Our automated system generates a Certificate of Calibration to ensure complete accuracy in recording gage block size. This certificate shows the deviation from the marked size of each block and marks those sizes which need replacing.
5. We will then provide a quotation for recommended replacements in the original material and croblox, if applicable.
6. If replacements are not required, or if you have instructed us only to calibrate and return the set, the gage blocks are packed and returned to you with a Certificate of Calibration showing the "as found" readings.
7. If you authorize replacements, your Certificate of Calibration is marked to indicate which blocks were replaced and the date of replacement. At your request, we can issue an "as found" and an "as left" certificate for an additional fee.

PLEASE PROVIDE THE FOLLOWING INFORMATION:

When sending gage blocks to us for calibration, please specify whether you want us to:

- A. Calibrate, issue a certificate and return only;
- B. Calibrate, advise condition and hold for instructions; or
- C. Calibrate, replace worn and missing blocks, then return.

If your order specifies replacement for worn and missing blocks and the cost of replacement approaches that of a new set, we will inform you, provide a quote price and wait for your instructions.

BE SURE TO PROTECT YOUR VALUABLE GAGE BLOCKS BY PACKAGING THEM CAREFULLY

Gage block cases are made for immobile storage – not as shipping crates.

It is good practice to carefully follow these steps when preparing your gage blocks for shipment:

- Treat them with rust preventative. Starrett M1® Lubricant is an excellent choice for this job.
- Place wax paper over the blocks.
- If necessary, add cushioning inside lid to prevent excessive movement of blocks in the inserts. Do not overdo this – the lid should not have to be forced to close.
- Seal the closed case with reinforced heavy tape. Note that the case clasp alone is not adequate to ensure that the case remains closed during shipment.
- Use a strong, oversize outer shipping container. Carefully surround the case with a generous amount of firm cushioning material to ensure that your blocks withstand shock in transit.
- Be sure to mark the shipping box as "Fragile."

AS GOOD AS NEW

When you receive your freshly calibrated gage block set with all necessary of the recommended repairs and/or replacements, you can rely on them to be essentially as good as new – that is, the most reliable and trusted gage blocks available – Starrett-Webber.

