

SKF Endoscopes TKES 10 series



Table of contents

EC Declaration of conformity3

Safety recommendations4

1. Introduction5

2. Description.....6

3. Technical data7

3.1 Kit content..... 7

3.2 Standard insertion tubes 8

3.3 Display Unit..... 9

4. Operating instructions10

4.1 Prepare for first use.....10

4.2 Use of articulated tube (standard supply with TKES 10A only).....12

4.3 Standard functions – Camera Mode15

4.4 Photo recording.....15

4.5 Video recording15

4.6 Side view adapter16

4.7 Advanced settings and functions16

4.8 Viewing and deleting recorded photos and videos.....19

4.9 Video output.....19

4.10 Transferring images and videos to the PC20

5. Maintenance.....21

6. Spare parts and accessories22

Original instructions

EC Declaration of conformity

We,
SKF Maintenance Products
Kelvinbaan 16
3439 MT Nieuwegein
The Netherlands

herewith declare that the following product:

**SKF Endoscope
TKES 10 series**

has been designed and manufactured in accordance with:
EMC DIRECTIVE 2004/108/EC as outlined in the harmonized norm for

EN 61000-4-2:1995+A1:1998+A2:2000
EN 61000-4-3:2006
EN 61326-1:2006 Class B
EN 61326-2-2:2006

EUROPEAN ROHS DIRECTIVE 2011/65/EU

Nieuwegein, The Netherlands,
January 2014



Sébastien David
Manager Product Development and Quality



Safety recommendations

Warning

- This device must not be used for medical or veterinary purposes.
- Do not modify or disassemble the unit.
- Do not use this item in explosive atmospheres.

Caution

- Keep the device out of the reach of children.
- Do not look directly into the LED's at the end of the insertion tube, your eyesight may be seriously damaged.
- Do not forcibly bend twist or elongate the insertion tube.
- Strong impact of the instrument and insertion tube may result in breakage of the objective lens (made of glass) at the tip of the insertion tube.
- Do not use or store the device at a temperature higher than 60 °C or lower than -20 °C.
- Do not use in a manner not specified in this instruction for use.
- Do not use the device in direct sunlight.
- Store the device in a dry and adequately ventilated environment.
- Keep away from acid or alkaline solutions and do not use in an atmosphere containing their vapours.
- Do not remove the SD Memory Card while data is being saved to the card. This may cause the data loss or damage to the card.
- The instrument contains no user serviceable parts. Opening the endoscope voids warranty. All service work must be carried out by an authorized SKF workshop. Only use genuine SKF spares and accessories. Other spares and accessories may damage the endoscope.

1. Introduction

The SKF Endoscopes TKES 10 series are compact handheld instruments that allow the user to view applications in restricted spaces that could not normally be seen with the naked eye.

The TKES 10 series are supplied in a sturdy carrying case and consists of a display unit, insertion tube, mains adapter and side view adapter. The display unit, with a 3.5" wide angle TFT LCD screen, has the capacity of viewing, storing and reviewing photos and video images. Images can also be displayed directly on a TV screen or stored and transferred to a PC for viewing later. The display unit is powered by rechargeable Li-Ion battery and a universal charger is included. To facilitate easy handling, the display unit has powerful magnets on the back allowing it to be affixed to suitable surfaces.

The TKES 10 series are available with three different types of insertion tubes of 1 metre (3.3 ft) length. All insertion tubes are equipped with powerful adjustable LED lighting.

TKES 10F

The TKES 10F has a flexible insertion tube, with a tip diameter of 5,8 mm (0.23 in), is ideal for use when the subject to be viewed is in the direct line of sight and the tube direction can be manipulated by the user.

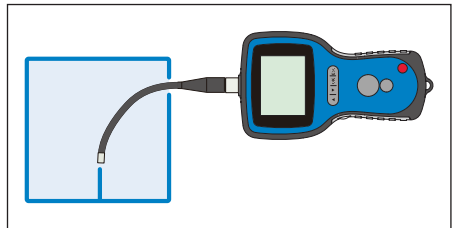

Figure 1. TKES 10F with flexible insertion tube

TKES 10S

The TKES 10S has a semi-rigid insertion tube, with a tip diameter of 5,8 mm (0.23 in), is well suited for viewing subjects that are not in the direct line of sight. By bending the tube and by careful manipulation, such subjects can be viewed.

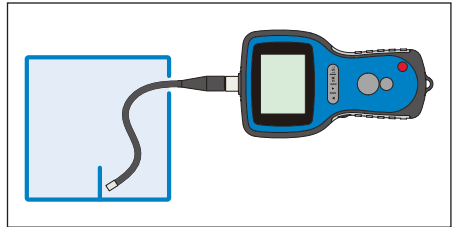

Figure 2. TKES 10S with semi-rigid insertion tube

TKES 10A

The TKES 10A has an articulated insertion tube, with a tip diameter of 5,8 mm (0.23 in), can be used to view objects that are either directly or indirectly in the line of sight. The flexible tube can be manipulated by the user and when in the region of the subject of interest then the tip can be articulated to view the subject.

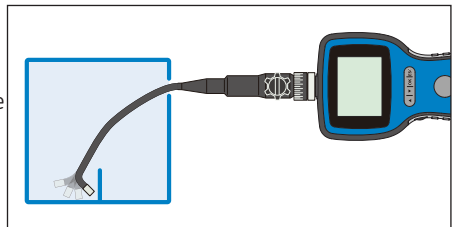

Figure 3. TKES 10A with articulated insertion tube

Other lengths of insertion tubes are available, see chapter “6. Spare parts and accessories”.

2. Description

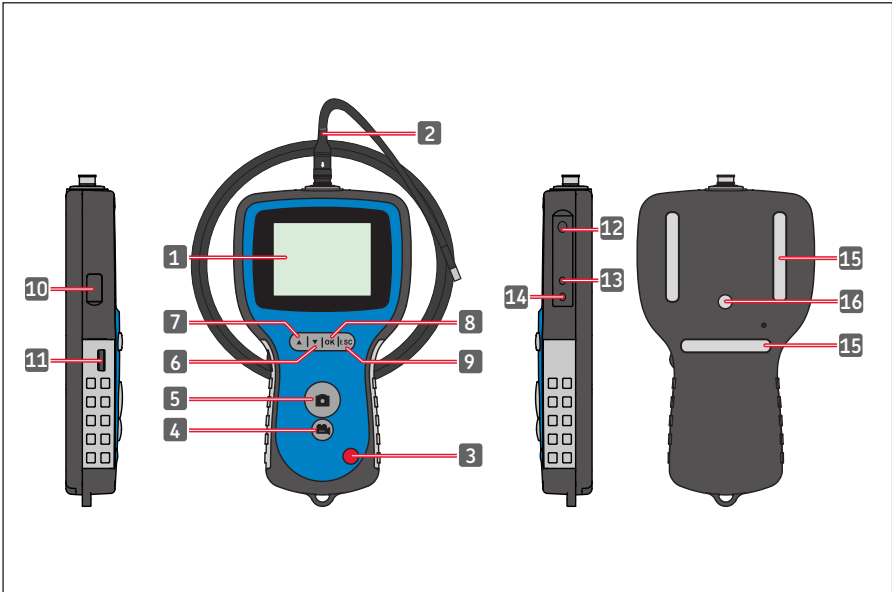

Figure 4. TKES 10 Endoscope

1. Display unit	9. Escape button
2. Insertion tube	10. USB connector
3. POWER button	11. LED intensity control
4. Video REC button	12. SD slot
5. PHOTO button	13. TV OUT connector
6. DOWN button	14. DC IN connector
7. UP button	15. Magnets (3x)
8. OK button	16. Tripod connector

3. Technical data

3.1 Kit content

Designation	TKES 10F	TKES 10S	TKES 10A
Description	SKF Endoscope with Flexible Tube, 1m	SKF Endoscope with Semi-Rigid Tube, 1m	SKF Endoscope with Articulated Tube, 1m
Display unit	TKES 10	TKES 10	TKES 10
Tube	Flexible, 1m (TKES TF-1)	Semi-rigid, 1m (TKES TS-1)	Articulated, 1m (TKES TA-1)
USB cable ¹	yes	yes	yes
Video cable ²	yes	yes	yes
Power adapter ³	yes	yes	yes
SD Card ⁴	yes	yes	yes
Side view adapter ⁵	yes	yes	yes
Instructions for use	Yes, MP5394	Yes, MP5394	Yes, MP5394
CD with all available instructions for use	Yes	Yes	Yes
Carrying dimensions	360 x 260 x 115 mm (14.2 x 10.2 x 4.5 in.)	360 x 260 x 115 mm (14.2 x 10.2 x 4.5 in.)	530 x 360 x 115 mm (20.9 x 14.2 x 4.5 in.)
Total weight (incl. case)	2,1 kg (4.6 lb)	2,1 kg (4.6 lb)	3,3 kg (7.3 lb)

1. USB Cable: enables connection to PC for convenient file transfer and maintenance
2. Video Cable: connects display unit to TV
3. Power Adapter: enables the display unit internal batteries to be recharged
4. SD card: For storage of photos and videos.
Compatible with SD & SDHC cards up to 32 GB.
Refer to Preparation for use (chapter 4.1) for direction of card insertion
5. 45° side view adapter allows viewing of objects 90° to the tip

3.2 Standard insertion tubes

Designation	TKES TF-1	TKES TS-1	TKES TA-1
Tube type	Flexible Insertion tube	Semi-rigid Insertion tube	Articulated Insertion tube
Image sensor	CMOS Image Sensor	CMOS Image Sensor	CMOS Image Sensor
Light source	4 adjustable white LEDs	4 adjustable white LEDs	4 adjustable white LEDs
Resolution Photo / Video	640 x 480 / 640 x 480 pixels	640 x 480 / 640 x 480 pixels	320 x 240 / 320 x 240 pixels
Size tip diameter	5,8 mm	5,8 mm	5,8 mm
Tube length	1 m	1 m	1 m
Field of View (FOV)	67°	67°	55°
Depth of Field (DOF)	1,5 cm - 6cm	1,5 cm - 6 cm	2 cm - 6 cm
Resistant to water & fuels	yes to most fuels and solvents	yes to most fuels and solvents	yes to most fuels and solvents
Min bending radius	50 mm	50 mm	50 mm
Working temperature range	-20 to 60 °C	-20 to 60 °C	-20 to 60 °C
Ingress Protection	IP67	IP67	IP67
Adjustability	Fully flexible	Flexible tube that can be bent to shape	300° tip articulation 330° rotatable neck

3.3 Display Unit

Designation	TKES 10
Display	3,5" TFT LCD, 320 x 240 Pixels
Interface	Mini USB 1,1 / AV out
Battery (not user serviceable)	Rechargeable Li-Polymer Battery (3,7V)
Power adapter	100 - 240 V AC in / 5,5 V DC out. Included: US, UK, EU and Australian plugs
Recording medium	SD card (2GB minimum supplied), SDHC compatible
Photo Storage Format	JPEG (640 x 480)
Storage capacity	Up to 50 000 pictures or 120 min. of video on a 2 GB card
Video Recording Format	ASF (320 x 240 or 640 x 480 depending insertion tube type)
Video Out Format	NTSC & PAL
Frame rate	30 fps
Compression Format	MPEG4
Video size	10 min. = 150 MB
Working & Storage / Battery charging temperature range	-20 °C to 60 °C / 0 to 40 °C
Functions	Snapshot, Video recording, Picture & video review on LCD screen, TV Out, transfer of picture & video from SD card to PC, Digital zoom, reflecting & mirroring
Magnets	3 x
Battery life	4 hours (average)
Tripod connection	1/4 in x 20 UNC x 8 mm
Ingress Protection	IP 55

4. Operating instructions

4.1 Prepare for first use

On first use it is important that the SD card is inserted as shown in figure 5.

(The SD card slot can be found underneath a rubber cap):

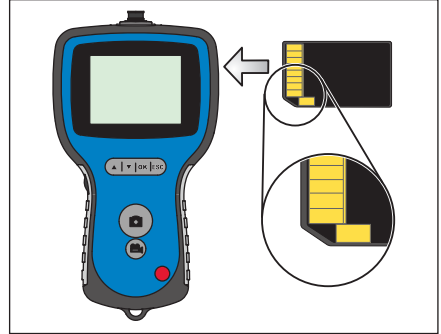

Figure 5. Insert SD card

Connect the insertion tube to the display unit as shown in figure 6 and tighten the locking collar.

Be careful not to over-tighten it. Remove the protective cap on the tip of the insertion tube.

For use of the articulated insertion tube, see 4.2 Use of articulated tube (Standard supply with TKES 10A only).

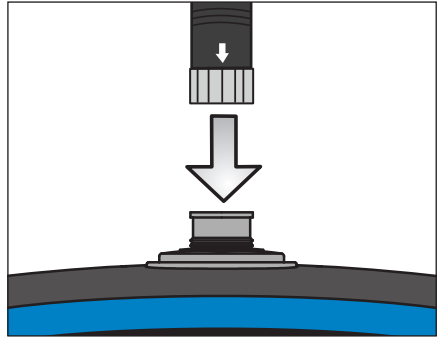

Figure 6. Connect tube

When used with side view adapter, see 4.6 side view adapter.

Unscrew the ring from the tube tip, place the ring in the side view adapter box. Screw the side view adapter into the tube tip.

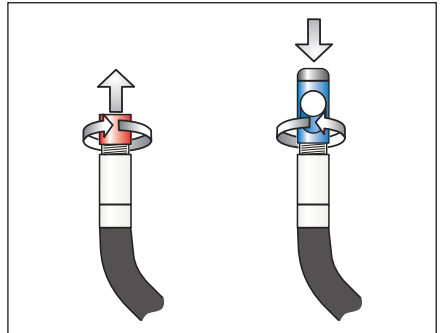

Figure 7. Side view adapter

Press the POWER button for 3-5 seconds to turn the display unit on. The Start-up screen is shown briefly followed by the status screen for five seconds, as shown in figures 8 and 9.



Figure 8. Start-up screen

The status screen shows the capacity of the SD card (in a green/blue bar) and the status of the internal battery.

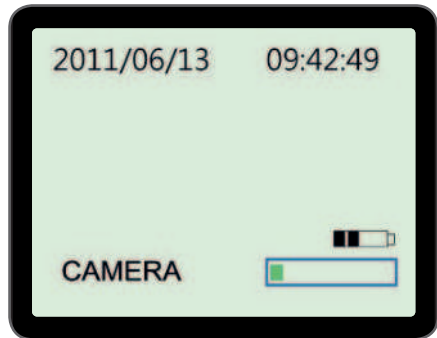

Figure 9. Status screen

If the TKES 10 has been stored for a long time then the display might not turn on. The most likely cause is insufficient battery charge. Use the power adapter to re-charge the battery, using the DC IN connection (see Fig. 4). The TKES 10 should be stored at room temperature, charged to about 30-50% of capacity. We recommend that the batteries be charged once per year to prevent premature battery failure.

4.2 Use of articulated tube (standard supply with TKES 10A only)

As with all insertion tubes, the articulated tube must also be properly connected to the display unit (see 4.1 Prepare for first use). The tube supplied is a so called 2-way articulated tube, it can rotate around the neck and the tip can bend with the articulation control knob in two directions (see Fig. 10).

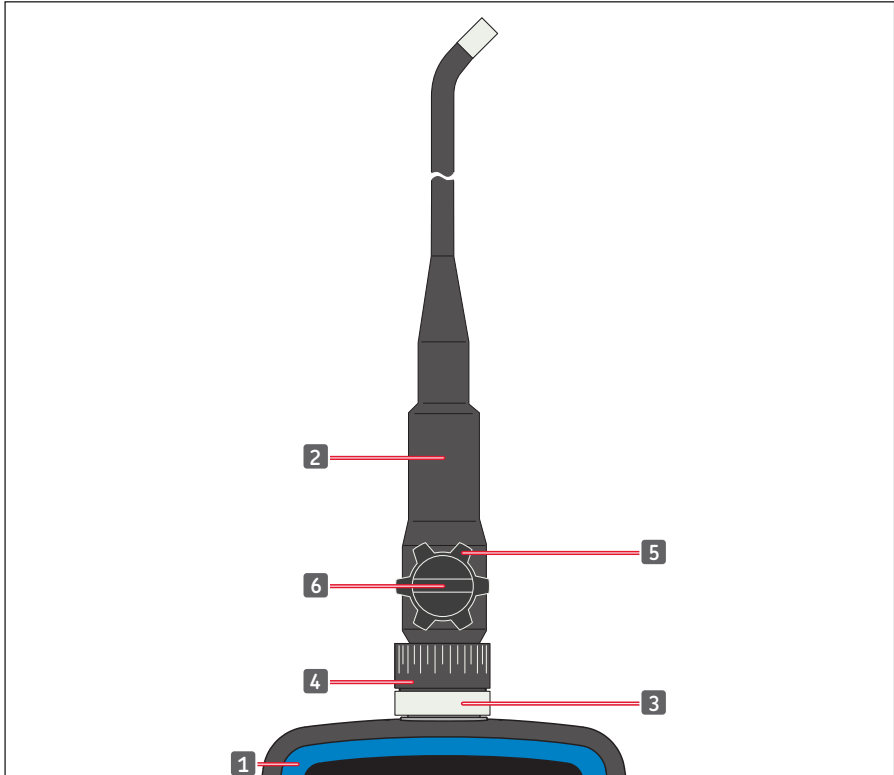

Figure 10. Controls of the articulated tube

1. Display unit	4. Neck turning ring
2. Articulated Insertion tube	5. Articulation control knob
3. Locking collar	6. Articulation tightness knob

The complete tube can that be rotated at the neck over 330°, meaning 165° to the right and 165° to the left (see Fig. 11).



Warning: Do not over rotate or use excessive force in rotating the tube. Tube can be irreparably damaged!

The articulation locking knob must first be loosened (see Fig. 12), before the tip can be articulated by means of the articulation control knob (see Fig. 13). Tighten the articulation locking knob as required.

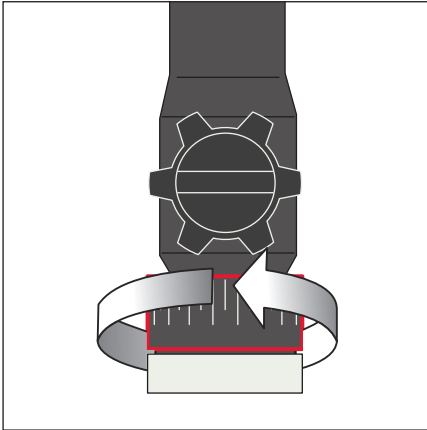

Figure 11. Rotation over the neck

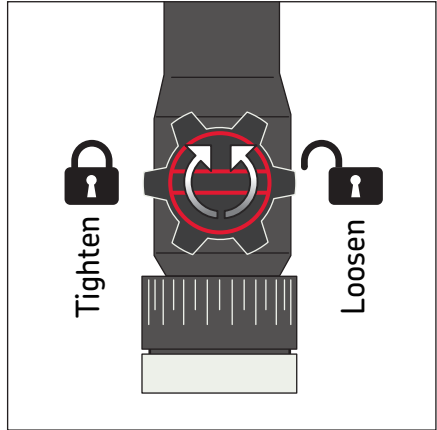

Figure 12. Tightening tip movement

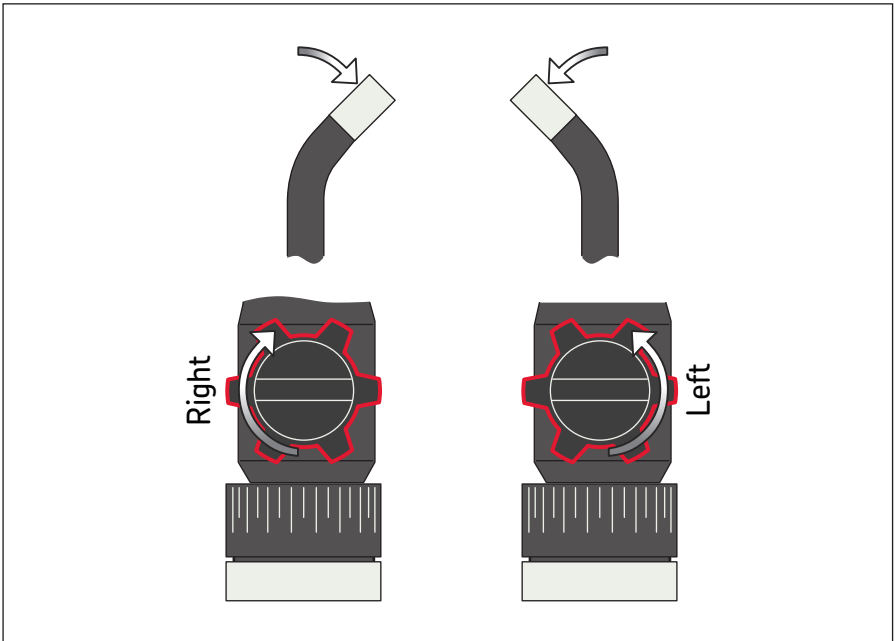

Figure 13. Articulation of tip

Warning

- Do not turn the articulation control knob until the insertion tube is straightened out, or it will cause permanent damage to the insertion tube.
- Do not turn the articulation control knob when the tip of the insertion tube is stuck or blocked by something, or it will cause permanent damage.
- Do not turn the Articulation control knob forcibly when the articulation locking knob is turned to the right (the articulation is fixed).
- Do not rotate the articulation tube more than 165° either direction.
- Loosen the articulation locking knob before retracting the insertion tube from the application.

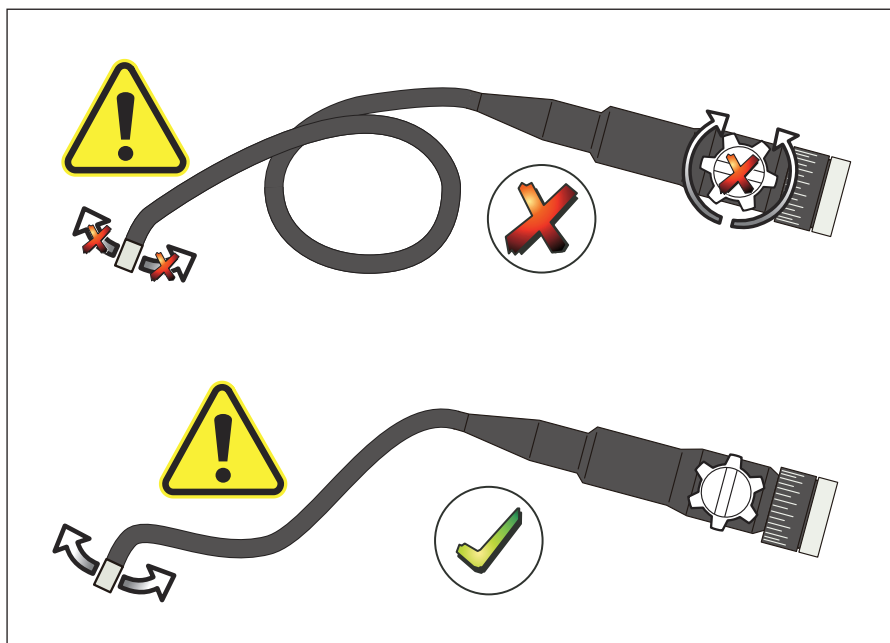

Figure 14.

4.3 Standard functions – Camera Mode

Press the POWER button for 3-5 seconds to turn the display unit on. After the status screen has disappeared then a “live” image can be seen. This is the camera mode.

It is strongly advised to properly set-up the TKES 10 before first use. In particular “Date & Time”, “Language” and “Video Format” (see 4.7 Advanced settings and functions). The indexing of saved photos and videos is based on date and time only. Proper set-up of other parameters, before first use, can make the operation of the TKES 10 easier in the future.

Use the LED intensity control (see Fig. 4) to adjust the brightness of the LED’s.

To turn the TKES 10 off: press the POWER button for 3-5 seconds.

Note:

After use, do not forget to place the protective rubber cap on the tip of the insertion tube.

4.4 Photo recording



PHOTO button

OK

OK or Confirm button



UP button



Video REC button

ESC

Escape button



DOWN button

In camera mode, press the PHOTO button to record a still image.

The photo is stored to the SD card in .jpg format with a file name in the form of a running number (e.g. IMG00001.jpg).



This is confirmed by a brief display of the icon on the screen.

4.5 Video recording

In preview mode, press the Video REC button will start the recording of a video.

The video icon is shown in the top right corner also the duration (see Fig. 15).

To stop recording, press the Video REC button again. The video icon disappears.

The display goes back to preview mode.

The video is automatically stored to the SD card in .asf format with a file name in the form of a running number (eg. IMG00002.asf).



Figure 15. Recording a video

4.6 Side view adapter

The side view adapter allows viewing at 90° to the insertion tube tip axis. This is ideal for viewing pipe walls. To mount the side view adapter, unscrew the chrome tip of the insertion tube and replace it with the side view adapter (see 4.1 Prepare for first use, Fig. 7).

Note:

The articulating tube has a different tip thread size to the flexible and semi-rigid insertion tubes

4.7 Advanced settings and functions

Switch the unit on. Ensure that camera mode is active (i.e. a “live” picture can be seen). Press the OK button to access the menus. Use UP or DOWN button to navigate. Press OK to confirm.

A. Delete all

Warning:

Be careful using this option, as everything will be deleted from the SD card! Navigate to DELETE ALL in the menu, press the OK button. Select YES or NO using the UP or DOWN buttons. Confirm with the OK button.

B. Video output

See “4.9 Video output” for more details.

C. Date/ time setup

Press UP or DOWN button to select year/month/day or hour/minute/second. Press PHOTO button to increase the value and the REC button to decrease the value.

The date and time can be displayed in the preview image mode. Use either the PHOTO or REC button to toggle between display “ON” and “OFF” (see Fig. 16 and 17).



Figure 16. Display ON



Figure 17. Display OFF

Confirm selection and exit the menu by pressing OK.

D. Language

Navigate to LANGUAGE in the menu, press the OK button. Select the required language using the UP or DOWN buttons and confirm with the OK button.

E. Video format

Navigate to VIDEO FORMAT in the menu, press the OK button. Select the required video format (NTSC or PAL) using the UP or DOWN buttons. Confirm with the OK button.

F. Auto power off

Navigate to AUTO POWER OFF in the menu, press the OK button. Select the required auto power off time (5, 10, 15, 30 minutes or Disable) using the UP or DOWN buttons. Confirm with the OK button.

G. Digital zoom

In preview mode, all pictures can be magnified on the screen to clearly display details.

The digital zoom can magnify the image to a maximum of 2x.

Navigate to DIGITAL ZOOM and press OK. Press UP and DOWN to select the required magnifying ratio (between 1.0 and 2.0). The current ratio is displayed on the screen.

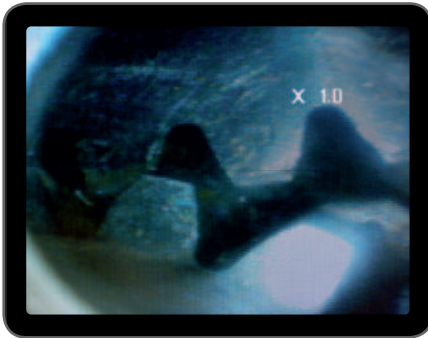

Figure 18. Digital zoom set at 1.0

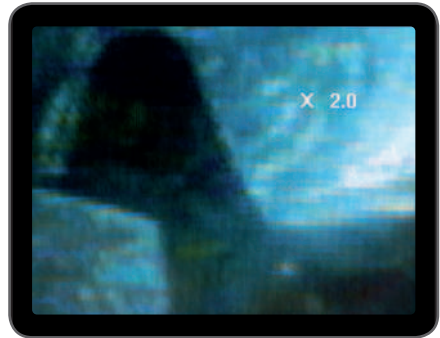

Figure 19. Digital zoom set at 2.0

Only the original picture can be saved on the SD card.

H. Mirror

In preview mode, the picture displayed can be mirrored horizontally or vertically, or rotated to accommodate the needs for inspection. This is particularly required when using the 90° side view mirror. Navigate to MIRROR and select the required changes to be done on the picture. Press OK to validate.

Note:

Note that only the original picture can be saved on the SD card.



Figure 20. Disable: Displays the original picture



Figure 21. Horizontal: Mirrors the image around the horizontal axis



Figure 22. Vertical: Mirrors the image around the vertical axis



Figure 23. Folding: Rotates the image by 180°

4.8 Viewing and deleting recorded photos and videos

In the camera mode, press the UP or DOWN buttons, the last photo or video will be displayed. Press the UP or DOWN buttons to navigate to the photo (see Fig. 24) or video (see Fig. 25) to be viewed.



Figure 24. View photo



Figure 25. View video

To play the video, press the Video REC button. Press the Video REC button again to pause.

To revert to Camera mode, press the ESC button

To delete a saved photo, press the OK button whilst it is displayed.

To delete a saved video, make sure the video is not in play mode, press the OK button.

A delete menu will show. Toggle between the Yes and No options using the UP or DOWN buttons. Press the OK button to confirm.

4.9 Video output

This function allows live pictures or recorded photos and videos to be displayed on a TV screen or beamer. First make sure that the Video format is set correctly to the used TV system (PAL or NTSC). (see 4.7.E Video format)

Connect the black video cable to the display unit TV out connector.

Ensure that the other end of the video cable is properly connected to the TV or beamer.

Press the OK button to select menu options, select Video Output and press the OK button.

The display unit screen will turn black and the display will be shown on the TV.

You can transfer the screen back to the display unit by selecting the same function.

Note:

The function will detect automatically if the video cable is already inserted in the TV OUT connector. If the video cable is not inserted, then the screen image will remain on the display unit.

4.10 Transferring images and videos to the PC

The computer must be running MS Windows™ 2000 or later, Mac OS X.

Turn the endoscope on. Connect the USB cable to the endoscope and the computer.

Look for the drive with the SD card files (see Fig. 26).

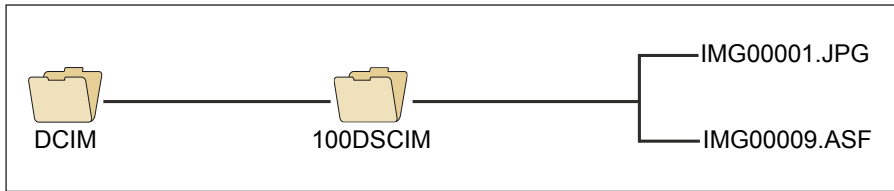

Figure 26. File storage

The files can then transferred and viewed on the PC. Alternatively the SD card can be removed and inserted into an SD card reader to retrieve the files.

In general, on a PC running MS Windows™ 2000 or later with Windows Media player, no special software is required to display JPG and ASF files.

5. Maintenance

Cleaning

The display unit can be cleaned with a cotton cloth moistened with a mild soap solution. The camera can be cleaned using a cotton brush and or lens-cleaning cloth to gently remove any dirt and dust. Soap, alcohol or another lens cleaning fluid can be sprayed over the lens directly. Use a lens-cleaning cloth to wipe it off. Use of acetone is prohibited.

Trouble shooting	Solution
No image on the display after turning the power on:	Battery is exhausted. Connect the display unit to the power adapter supplied and recharge batteries. The TKES 10 can be used when connected to ac power.
No image, only words on the LCD monitor after turning the power on:	Check that the insertion tube is correctly connected to the display unit.
Unable to take photos or record video:	SD card not present, wrongly inserted, full or faulty. Check SD card is present, check SD card insertion, check SD capacity, check if SD card is faulty (check if SD card works in other devices).
Shut down:	When all functions freeze or fail, insert an insulated needle into the hole on the back of the main unit. The system will restart automatically (see Fig. 27).

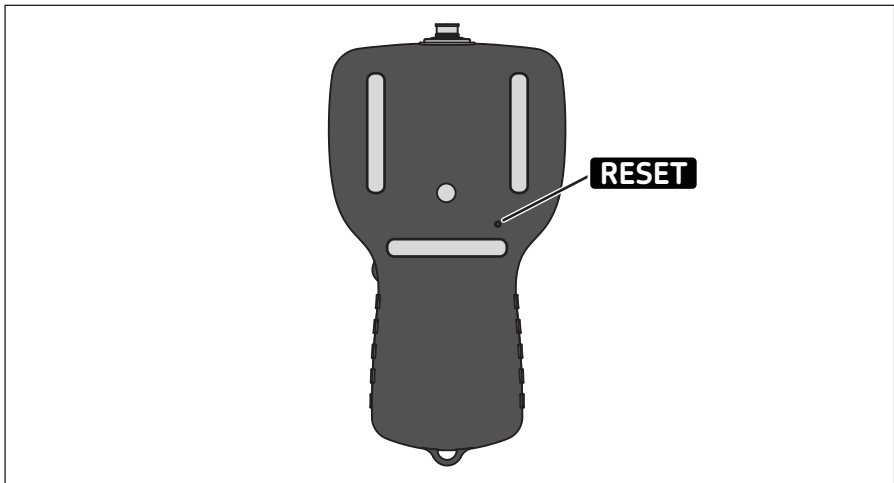

Figure 27. Resetting the TKES 10

6. Spare parts and accessories

Designation	Description	Length
TKES TF-1	Flexible insertion tube	1 m
TKES TF-2	Flexible insertion tube	2 m
TKES TF-3	Flexible insertion tube	3 m
TKES TF-5	Flexible insertion tube	5 m
TKES TS-1	Semi-rigid insertion tube	1 m
TKES TS-2	Semi-rigid insertion tube	2 m
TKES TS-3	Semi-rigid insertion tube	3 m
TKES TS-5	Semi-rigid insertion tube	5 m
TKES TA-1	Articulated insertion tube in a case	1 m
TKES 10-DU	Display unit with standard accessories, without tube in a case	
TDTC 1/B	General toolcase without inlay, size B	
TKES 10A-CC	Toolcase with inlay for TKES 10A	





skf.com | mapro.skf.com | skf.com/mount

© SKF is a registered trademark of the SKF Group.

© SKF Group 2018

The contents of this publication are the copyright of the publisher and may not be reproduced (even extracts) unless prior written permission is granted. Every care has been taken to ensure the accuracy of the information contained in this publication but no liability can be accepted for any loss or damage whether direct, indirect or consequential arising out of the use of the information contained herein.

MP5394 EN · 2018/09