

# SDG1000X Plus Series

## Arbitrary Waveform Generator

User Manual

EN01B



SIGLENT TECHNOLOGIES CO.,LTD



# Contents

<b>1</b>	<b>Introduction</b> .....	<b>1</b>
<b>2</b>	<b>Important Safety Information</b> .....	<b>2</b>
2.1	General Safety Summary .....	2
2.2	Safety Terms and Symbols.....	4
2.3	Working Environment .....	5
2.4	Cooling Requirements .....	6
2.5	Power and Grounding Requirements .....	6
2.6	Cleaning.....	7
2.7	Abnormal Conditions .....	8
2.8	Safety Compliance .....	8
	<b>Informations</b> .....	<b>9</b>
	Exigence de Sécurité .....	9
	Termes et symboles de sécurité.....	11
	Environnement de travail.....	12
	Exigences de refroidissement .....	13
	Connexions d'alimentation et de terre.....	13
	Nettoyage .....	14
	Conditions anormales.....	15
	Conformité en matière de sécurité .....	15
<b>3</b>	<b>First Steps</b> .....	<b>16</b>
3.1	Delivery Checklist .....	16
3.2	Quality Assurance.....	16
3.3	Maintenance Agreement .....	16
<b>4</b>	<b>Document Conventions</b> .....	<b>17</b>
<b>5</b>	<b>Introduction to SDG1000X Plus Series Arbitrary Waveform Generator</b> .....	<b>18</b>
<b>6</b>	<b>Quick get start</b> .....	<b>19</b>
6.1	Front panel.....	19
6.2	Rear panel .....	20
<b>7</b>	<b>Screen display area</b> .....	<b>21</b>
<b>8</b>	<b>Front Panel Control</b> .....	<b>22</b>

8.1	Waveform selection settings.....	22
8.2	Mod/Sweep/Burst settings.....	22
8.3	Number keyboard and knob .....	22
8.4	Common function buttons .....	23
<b>9</b>	<b>Basic waveform settings .....</b>	<b>24</b>
9.1	Standard waveform settings.....	24
9.2	Harmonic settings.....	29
9.3	Noise settings .....	32
9.4	PRBS settings.....	34
9.5	Arbitrary Waveform settings .....	37
9.5.1	DDS mode .....	37
9.5.2	TrueArb mode.....	37
9.5.3	Data source .....	39
9.6	Sequence settings .....	43
9.7	Multi Pulse settings.....	46
<b>10</b>	<b>Modulation/Sweep/Burst settings .....</b>	<b>49</b>
10.1	Overview.....	49
10.2	Modulation .....	50
10.2.1	Source selection.....	50
10.2.2	Modulation type .....	51
10.3	Sweep.....	60
10.3.1	Sweep type.....	60
10.3.2	Sweep mode.....	61
10.3.3	Trigger Source.....	61
10.3.4	Scanning parameter settings.....	61
10.4	Burst.....	64
10.4.1	Burst type .....	64
10.4.2	Trigger Source.....	65
10.4.3	Burst parameter settings .....	65
<b>11</b>	<b>Store/Recall .....</b>	<b>68</b>
11.1.1	Storage .....	68
11.1.2	File type .....	69
11.1.3	File operation .....	70
<b>12</b>	<b>Accessibility settings .....</b>	<b>73</b>
12.1	System settings .....	73

12.1.1	Set Number Format.....	73
12.1.2	Set language .....	73
12.1.3	Power on settings.....	73
12.1.4	Set To Default.....	74
12.1.5	Set beeper .....	74
12.1.6	Set up screen saver .....	74
12.1.7	View system information .....	74
12.1.8	Set up firmware upgrade.....	75
12.1.9	Help .....	75
12.1.10	UI Style .....	75
12.1.11	Open Source Description .....	75
12.2	Testing/Calibration .....	76
12.3	Counter.....	79
12.4	output setting .....	81
12.4.1	Load.....	81
12.4.2	Polarity.....	82
12.4.3	EqPhase .....	82
12.4.4	Wave Combine .....	82
12.4.5	Amplitude.....	83
12.4.6	Power on output status.....	83
12.5	Channel cope and coupling.....	85
12.5.1	Channel cope .....	85
12.5.2	Channel coupling.....	85
12.5.3	Channel tracking.....	87
12.6	Interface settings .....	89
12.6.1	USB settings.....	90
12.6.2	GPIB settings.....	90
12.6.3	LAN settings .....	91
12.7	Sync.....	94
12.8	Clock source .....	96
12.9	Phase mode.....	97
12.10	Overvoltage protection .....	98
12.11	Multi device synchronization .....	99
<b>13</b>	<b>General inspection and troubleshooting .....</b>	<b>100</b>
13.1.1	General inspection .....	100
13.1.2	Troubleshooting.....	100
<b>14</b>	<b>Service and support .....</b>	<b>101</b>

14.1.1	Maintenance summary .....	101
14.1.2	Contact SIGLENT .....	101
<b>APPENDIX A</b>	.....	<b>102</b>
<b>APPENDIX B</b>	.....	<b>103</b>
<b>APPENDIX C</b>	.....	<b>106</b>

# 1 Introduction

This user manual includes important safety and installation information related to the SDG1000X Plus series of Arbitrary Waveform Generator and includes simple tutorials for basic operation of the instrument.

The series includes the following models:

<b>Model</b>	<b>Analogy Bandwidth</b>	<b>Maximum Sampling Rate</b>	<b>Analog Channel</b>
SDG1062X Plus	60 MHz	1 GSa/s (4X Interpolation )	2
SDG1032X Plus	30 MHz	1 GSa/s (4X Interpolation )	2
SDG1022X Plus	25 MHz	1 GSa/s (4X Interpolation )	2

## 2 Important Safety Information

This manual contains information and warnings that must be followed by the user for safe operation and to keep the product in a safe condition.

### 2.1 General Safety Summary

Carefully read the following safety precautions to avoid personal injury and prevent damage to the instrument and any products connected to it. To avoid potential hazards, please use the instrument as specified.

#### **To Avoid Fire or Personal Injury.**

##### **Use Proper Power Line.**

Only use a local/state approved power cord for connecting the instrument to mains power sources.

##### **Ground the Instrument.**

The instrument grounds through the protective terra conductor of the power line. To avoid electric shock, the ground conductor must be connected to the earth. Make sure the instrument is grounded correctly before connect its input or output terminals.

##### **Connect the Signal Wire Correctly.**

The potential of the signal wire is equal to the earth, so do not connect the signal wire to a high voltage. Do not touch the exposed contacts or components.

##### **Look over All Terminals' Ratings.**

To avoid fire or electric shock, please look over all ratings and signed instructions of the instrument. Before connecting the instrument, please read the manual carefully to gain more information about the ratings.

##### **Equipment Maintenance and Service.**

When the equipment fails, please do not dismantle the machine for maintenance. The equipment contains capacitors, power supply, transformers, and other energy storage devices, which may cause high voltage damage. The internal devices of the equipment are sensitive to static electricity, and direct contact is easy to cause irreparable damage to the equipment. It is necessary to return to the factory or the company's designated maintenance organization for maintenance. Be sure to pull out the power supply when repairing the equipment. Live line operation is strictly prohibited. The equipment can only be powered on when the maintenance is completed and the maintenance is confirmed to be successful.



**Identification of Normal State of Equipment.**

After the equipment is started, there will be no alarm information and error information at the interface under normal conditions. The curve of the interface will scan from left to right freely; if there is a button in the scanning process or there is an alarm or error prompt, the device may be in an abnormal state. You need to view the specific prompt information. You can try to restart the setting. If the fault information is still in place, do not use it for testing. Contact the manufacturer or the maintenance department designated by the manufacturer to carry out maintenance to avoid the wrong test data caused by the use of the fault or endanger the personal safety.

**Not Operate with Suspected Failures.**

If you suspect that there is damage to the instrument, please let qualified service personnel check it.

**Avoid Circuit or Wire Exposed Components Exposed.**

Do not touch exposed contacts or components when the power is on.

**Do not operate in wet/damp conditions.****Do not operate in an explosive atmosphere.****Keep the surface of the instrument clean and dry.**

**Only probe assemblies that meet the requirement of UL61010-031 and CAN/CSA-C22.2 No.61010-031 shall be used.**

**Only a lithium battery with the same specifications as the original battery should be used to replace the battery on board.**







**Not to use the equipment for measurements on mains circuits, not to use the equipment for measurements on voltage exceed the voltage range describe in the manual. The maximum additional transient voltage cannot exceed 1300V.**

**The responsible body or operator should refer to the instruction manual to preserve the protection afforded by the equipment. If the equipment is used in a manner not specified by the manufacturer, the protection provided by the equipment may be impaired.**

**Any parts of the device and its accessories are not allowed to be changed or replaced, other than authorized by the manufacturer or agent.**

## 2.2 Safety Terms and Symbols

When the following symbols or terms appear on the front or rear panel of the instrument or in this manual, they indicate special care in terms of safety.

	This symbol is used where caution is required. Refer to the accompanying information or documents to protect against personal injury or damage to the instrument.
	This symbol warns of a potential risk of shock hazard.
	This symbol is used to denote the measurement ground connection.
	This symbol is used to denote a safety ground connection.
	This symbol shows that the switch is an On/Standby switch. When it is pressed, the scope's state switches between Operation and Standby. This switch does not disconnect the device's power supply. To completely power off the scope, the power cord must be unplugged from the AC socket after the instrument is in the standby state.
	This symbol is used to represent alternating current, or "AC".
CAUTION	The "CAUTION" symbol indicates a potential hazard. It calls attention to a procedure, practice, or condition which may be dangerous if not followed. Do not proceed until its conditions are fully understood and met.
WARNING	The "WARNING" symbol indicates a potential hazard. It calls attention to a procedure, practice, or condition which, if not followed, could cause bodily injury or death. If a WARNING is indicated, do not proceed until the safety conditions are fully understood and met.

## 2.3 Working Environment

The design of the instrument has been verified to conform to EN 61010-1 safety standard per the following limits:

### Environment

The instrument is used indoors and should be operated in a clean and dry environment with an ambient temperature range.

Note: Direct sunlight, electric heaters, and other heat sources should be considered when evaluating the ambient temperature.



**WARNING:** Do not operate the instrument in explosive, dusty, or humid environments.

### Ambient Temperature

Operating: 0 °C to +40 °C

Non-operation: -20 °C to +60 °C

**Note:** Direct sunlight, radiators, and other heat sources should be taken into account when assessing the ambient temperature.

### Humidity

Operating: 5% ~ 90 %RH, 30 °C, derate to 50 %RH at 40 °C

Non-operating: 5% ~ 95% RH

### Mains supply voltage fluctuations

Refer to 2.5 Power and Ground Requirements

### Altitude

Operating: ≤ 3,048 m, 30 °C

Non-operating: ≤ 15,000 m

### Installation (overvoltage) Category

This product is powered by mains conforming to installation (overvoltage) Category II.

**Note:** Installation (overvoltage) category I refers to situations where equipment measurement terminals are connected to the source circuit. In these terminals, precautions are done to limit the

transient voltage to a correspondingly low level.

Installation (overvoltage) category II refers to the local power distribution level which applies to equipment connected to the AC line (AC power).

### Degree of Pollution

The signal source may be operated in environments of Pollution Degree II.

**Note:** Degree of Pollution II refers to a working environment that is dry and non-conductive pollution occurs. Occasional temporary conductivity caused by condensation is expected.

### IP Rating

IP20 (as defined in IEC 60529).

## 2.4 Cooling Requirements

This instrument relies on the forced air cooling with internal fans and ventilation openings. Care must be taken to avoid restricting the airflow around the apertures (fan holes) at each side of the scope. To ensure adequate ventilation it is required to leave a 15 cm (6 inch) minimum gap around the sides of the instrument.



**CAUTION:** Do not block the ventilation holes located on both sides of the scope.



**CAUTION:** Do not allow any foreign matter to enter the scope through the ventilation holes, etc.

## 2.5 Power and Grounding Requirements

The instrument operates with a single-phase, 100 to 240 Vrms (+/-10%) AC power at 50/60 Hz (+/-5%), or single-phase 100 to 120 Vrms (+/-10%) AC power at 400 Hz (+/-5%).

No manual voltage selection is required because the instrument automatically adapts to line voltage.

Depending on the type and number of options and accessories (probes, PC port plug-in, etc.), the instrument can consume up to 50 W of power.

**Note:** The instrument automatically adapts to the AC line input within the following ranges:

Voltage Range:	90 - 264 Vrms	90 - 132 Vrms
Frequency Range:	47 - 63 Hz	380 - 420 Hz

The instrument includes a grounded cord set containing a molded three-terminal polarized plug and a standard IEC320 (Type C13) connector for making line voltage and safety ground connection. The AC inlet ground terminal is connected directly to the frame of the instrument. For adequate protection against electrical shock hazards, the power cord plug must be inserted into a mating AC outlet containing a safety ground contact. Use only the power cord specified for this instrument and certified for the country of use.

	<p><b>WARNING:</b> Electrical Shock Hazard!</p> <p>Any interruption of the protective conductor inside or outside of the scope, or disconnection of the safety ground terminal creates a hazardous situation.</p> <p>Intentional interruption is prohibited.</p>
---	--

The position of the instrument should allow easy access to the socket. To make the instrument completely power off, unplug the instrument power cord from the AC socket.

The power cord should be unplugged from the AC outlet if the scope is not to be used for an extended period.

	<p><b>CAUTION:</b> The outer shells of the front panel terminals (CH1, CH2) are connected to the instrument's chassis and therefore to the safety ground.</p>
---	---

## 2.6 Cleaning

Clean only the exterior of the instrument, using a damp, soft cloth. Do not use chemicals or abrasive elements. Under no circumstances allow moisture to penetrate the instrument. To avoid electrical shock, unplug the power cord from the AC outlet before cleaning.

	<p><b>WARNING:</b> Electrical Shock Hazard!</p> <p>No operator serviceable parts inside. Do not remove covers.</p> <p>Refer servicing to qualified personnel</p>
---	--

## 2.7 Abnormal Conditions

Do not operate the scope if there is any visible sign of damage or has been subjected to severe transport stresses.

If you suspect the scope's protection has been impaired, disconnect the power cord and secure the instrument against any unintended operation.

Proper use of the instrument depends on careful reading of all instructions and labels.

	<p><b>WARNING:</b> Any use of the scope in a manner not specified by the manufacturer may impair the instrument's safety protection. This instrument should not be directly connected to human subjects or used for patient monitoring.</p>
---	---

## 2.8 Safety Compliance

This section lists the safety standards with which the product complies.

### U.S. nationally recognized testing laboratory listing

1. UL 61010-1:2012/R: 2018-11. Safety Requirements for Electrical Equipment for Measurement, Control, and Laboratory Use – Part 1: General Requirements.
2. UL 61010-2-030:2018. Safety Requirements for Electrical Equipment for Measurement, Control, and Laboratory Use – Part2-030: Particular requirements for testing and measuring circuits.

### Canadian certification

1. CAN/CSA-C22.2 No. 61010-1:2012/A1:2018-11. Safety Requirements for Electrical Equipment for Measurement, Control, and Laboratory Use – Part 1: General Requirements.
2. CAN/CSA-C22.2 No. 61010-2-030:2018. Safety Requirements for Electrical Equipment for Measurement, Control, and Laboratory Use – Part 2-030: Particular requirements for testing and measuring circuits.

## Informations

essentielles sur la sécurité

Ce manuel contient des informations et des avertissements que les utilisateurs doivent suivre pour assurer la sécurité des opérations et maintenir les produits en sécurité.

### Exigence de Sécurité

Lisez attentivement les précautions de sécurité ci - après afin d'éviter les dommages corporels et de prévenir les dommages aux instruments et aux produits associés. Pour éviter les risques potentiels, utilisez les instruments prescrits.

#### **Éviter l'incendie ou les lésions corporelles.**

#### **Utilisez un cordon d'alimentation approprié.**

N'utilisez que des cordons d'alimentation spécifiques aux instruments approuvés par les autorités locales.

#### **Mettez l'instrument au sol.**

L'instrument est mis à la Terre par un conducteur de mise à la terre de protection du cordon d'alimentation. Pour éviter un choc électrique, le conducteur de mise à la terre doit être mis à la terre. Assurez - vous que l'instrument est correctement mis à la terre avant de connecter les bornes d'entrée ou de sortie de l'instrument.

#### **Connectez correctement le fil de signalisation.**

Le potentiel de la ligne de signal est égal au potentiel au sol, donc ne connectez pas la ligne de signal à haute tension. Ne touchez pas les contacts ou les composants exposés.

#### **Voir les cotes de tous les terminaux.**

Pour éviter un incendie ou un choc électrique, vérifiez toutes les cotes et signez les instructions de l'instrument. Avant de brancher l'instrument, lisez attentivement ce manuel pour obtenir de plus amples renseignements sur les cotes.

#### **Entretien du matériel.**

En cas de défaillance de l'équipement, ne pas démonter et entretenir l'équipement sans autorisation. L'équipement contient des condensateurs, de l'alimentation électrique, des transformateurs et d'autres dispositifs de stockage d'énergie, ce qui peut causer des blessures à haute tension. Les dispositifs internes de l'équipement sont sensibles à l'électricité statique. Le contact direct peut

facilement causer des blessures irrécupérables à l'équipement. L'équipement doit être retourné à l'usine ou à l'organisme de maintenance désigné par l'entreprise pour l'entretien. L'alimentation électrique doit être retirée pendant l'entretien. La ligne ne doit pas être mise sous tension tant que l'entretien de l'équipement n'est pas terminé et que l'entretien n'est pas confirmé.

**Identification de l'état normal de l'équipement.**

Après le démarrage de l'équipement, dans des conditions normales, il n'y aura pas d'information d'alarme et d'erreur au bas de l'interface, et la courbe de l'interface sera balayée librement de gauche à droite; si un blocage se produit pendant le processus de numérisation, ou si l'information d'alarme ou d'erreur apparaît au bas de l'interface, l'équipement peut être dans un état anormal. Pour voir l'information d'alarme spécifique, vous pouvez d'abord essayer de redémarrer. Si l'information sur la défaillance est toujours présente, ne l'utilisez pas pour l'essai. Contactez le fabricant ou le Service de réparation désigné par le fabricant pour effectuer l'entretien afin d'éviter d'apporter des données d'essai erronées ou de mettre en danger la sécurité personnelle en raison de l'utilisation de la défaillance.

**Ne pas fonctionner en cas de suspicion de défaillance.**

Si vous soupçonnez des dommages à l'instrument, demandez à un technicien qualifié de vérifier.

**L'exposition du circuit ou de l'élément d'exposition du fil est évitée.**

Lorsque l'alimentation est connectée, aucun contact ou élément nu n'est mis en contact.

**Ne pas fonctionner dans des conditions humides / humides.**

**Pas dans un environnement explosif.**

**Maintenez la surface de l'instrument propre et sec.**

**Le Circuit d'alimentation électrique ne peut pas être mesuré à l'aide du dispositif, ni la tension qui dépasse la plage de tension décrite dans le présent manuel.**

**Seuls les ensembles de sondes conformes aux spécifications du fabricant peuvent être utilisés.**

**L'organisme ou l'opérateur responsable doit se référer au cahier des charges pour protéger la protection offerte par le matériel. La protection offerte par le matériel peut être compromise si celui-ci est utilisé de manière non spécifiée par le fabricant.**









**Aucune pièce du matériel et de ses annexes ne peut être remplacée ou remplacée sans l'autorisation de son fabricant.**

**Remplacer la batterie dans l'appareil avec les mêmes spécifications de batterie au lithium.**

## Termes et symboles de sécurité

Lorsque les symboles ou termes suivants apparaissent sur le panneau avant ou arrière de l'instrument ou dans ce manuel, ils indiquent un soin particulier en termes de sécurité.

	Ce symbole est utilisé lorsque la prudence est requise. Reportez-vous aux informations ou documents joints afin de vous protéger contre les blessures ou les dommages à l'instrument.
	Ce symbole avertit d'un risque potentiel de choc électrique.
	Ce symbole est utilisé pour désigner la connexion de terre de mesure.
	Ce symbole est utilisé pour indiquer une connexion à la terre de sécurité.
	Ce symbole indique que l'interrupteur est un interrupteur marche / veille. Lorsqu'il est enfoncé, l'état de l'instruments bascule entre Fonctionnement et Veille. Ce commutateur ne déconnecte pas l'alimentation de l'appareil. Pour éteindre complètement l'instruments, le cordon d'alimentation doit être débranché de la prise secteur une fois l'instruments en état de veille.
	Ce symbole est utilisé pour représenter un courant alternatif, ou "AC".
CAUTION	Le symbole " CAUTION" indique un danger potentiel. Il attire l'attention sur une procédure, une pratique ou une condition qui peut être dangereuse si elle n'est pas suivie. Ne continuez pas tant que ses conditions n'ont pas été entièrement comprises et remplies.
WARNING	Le symbole " WARNING" indique un danger potentiel. Il attire l'attention sur une procédure, une pratique ou une condition qui, si elle n'est pas suivie, pourrait entraîner des blessures corporelles ou la mort. Si un AVERTISSEMENT est indiqué, ne continuez pas tant que les conditions de sécurité ne sont pas entièrement comprises et remplies.

## Environnement de travail

La conception de l'instrument a été certifiée conforme à la norme EN 61010-1, sur la base des valeurs limites suivantes:

### Environnement

L'instrument doit être utilisé à l'intérieur dans un environnement propre et sec dans la plage de température ambiante.

Note: la lumière directe du soleil, les réchauffeurs électriques et d'autres sources de chaleur doivent être pris en considération lors de l'évaluation de la température ambiante.



**ATTENTION:** ne pas utiliser l'instrument dans l'air explosif, poussiéreux ou humide.

### Température ambiante

En fonctionnement: 0 °C à +40 °C

Hors fonctionnement: -20 °C à +60 °C

**Note:** pour évaluer la température de l'environnement, il convient de tenir compte des rayonnements solaires directs, des radiateurs thermiques et d'autres sources de chaleur.

### Humidité

Fonctionnement: 5% ~ 90% HR, 30 °C, 40 °C réduit à 50% HR  
Hors fonctionnement: 5% ~ 95%, 65 °C, 24 heures

### Fluctuation de la tension d'alimentation

Voir connexions d'alimentation et au sol

### Altitude

Fonctionnement: ≤ 3048 m

À l'arrêt: ≤ 15,000 m

### Catégorie d'installation (surtension)

Ce produit est alimenté par une alimentation électrique conforme à l'installation (surtension) Catégorie II.

### Installation (overvoltage) Category Definitions Définition de catégorie d'installation (surtension)

La catégorie II d'installation (surtension) est un niveau de signal applicable aux terminaux de mesure d'équipement reliés au circuit source. Dans ces bornes, des mesures préventives sont prises pour limiter la tension transitoire à un niveau inférieur correspondant.

La catégorie II d'installation (surtension) désigne le niveau local de distribution d'énergie d'un équipement conçu pour accéder à un circuit alternatif (alimentation alternative).

### Degré de pollution

Un instruments peut être utilisé dans un environnement Pollution Degree II.

**Note:** Pollution Degree II signifie que le milieu de travail est sec et qu'il y a une pollution non conductrice. Parfois, la condensation produit une conductivité temporaire.

### IP Rating

IP20 (as defined in IEC 60529).

## Exigences de refroidissement

Cet instrument repose sur un refroidissement à air forcé avec des ventilateurs internes et des ouvertures de ventilation. Des précautions doivent être prises pour éviter de restreindre le flux d'air autour des ouvertures (trous de ventilateur) de chaque côté de la lunette. Pour assurer une ventilation adéquate, il est nécessaire de laisser un espace minimum de 15 cm (6 pouces) sur les côtés de l'instrument.



**ATTENTION:** Ne bloquez pas les trous de ventilation situés des deux côtés de la lunette.



**ATTENTION:** Ne laissez aucun corps étranger pénétrer dans la lunette par les trous de ventilation, etc.

## Connexions d'alimentation et de terre

L'instrument fonctionne avec une alimentation CA monophasée de 100 à 240 Vrms (+/- 10%) à 50/60 Hz (+/- 5%), ou monophasée 100 - 120 Vrms (+/-10 %) Alimentation CA à 400 Hz (+/-5%).

Aucune sélection manuelle de la tension n'est requise car l'instrument s'adapte automatiquement à la tension de ligne.

Selon le type et le nombre d'options et d'accessoires (sondes, plug-in de port PC, etc.), l'instrument peut consommer jusqu'à 50 W d'énergie.

**Remarque:** l'instrument s'adapte automatiquement à l'entrée de ligne CA dans les plages suivantes:

Plage de tension:	90 - 264 Vrms	90 - 132 Vrms
Gamme de fréquences:	47 - 63 Hz	380 - 420 Hz

L'instrument comprend un jeu de cordons mis à la terre contenant une fiche polarisée à trois bornes moulée et un connecteur standard IEC320 (Type C13) pour établir la tension de ligne et la connexion de mise à la terre de sécurité. La borne de mise à la terre de l'entrée CA est directement connectée au châssis de l'instrument. Pour une protection adéquate contre les risques d'électrocution, la fiche du cordon d'alimentation doit être insérée dans une prise secteur correspondante contenant un contact de sécurité avec la terre. Utilisez uniquement le cordon d'alimentation spécifié pour cet instrument et certifié pour le pays d'utilisation.

	<p><b>Avertissement:</b> risque de choc électrique!</p> <p>Toute interruption du conducteur de terre de protection à l'intérieur ou à l'extérieur de la portée ou la déconnexion de la borne de terre de sécurité crée une situation dangereuse.</p> <p>L'interruption intentionnelle est interdite.</p>
---	--

La position de l'instruments doit permettre un accès facile à la prise. Pour éteindre complètement l'instruments, débranchez le cordon d'alimentation de l'instrument de la prise secteur.

Le cordon d'alimentation doit être débranché de la prise secteur si la lunette ne doit pas être utilisée pendant une période prolongée.

	<p><b>ATTENTION:</b> les enveloppes extérieures des bornes du panneau avant (CH1, CH2) sont connectées au châssis de l'instrument et donc à la terre de sécurité.</p>
---	---

## Nettoyage

Nettoyez uniquement l'extérieur de l'instrument à l'aide d'un chiffon doux et humide. N'utilisez pas de produits chimiques ou d'éléments abrasifs. Ne laissez en aucun cas l'humidité pénétrer dans l'instrument. Pour éviter les chocs électriques, débranchez le cordon d'alimentation de la prise secteur avant de le nettoyer.

	<p><b>Avertissement:</b> risque de choc électrique!</p> <p>Aucune pièce réparable par l'opérateur à l'intérieur. Ne retirez pas les capots.</p> <p>Confiez l'entretien à un personnel qualifié</p>
---	--

## Conditions anormales

Utilisez l'instrument uniquement aux fins spécifiées par le fabricant.

N'utilisez pas la lunette s'il y a des signes visibles de dommages ou si elle a été soumise à de fortes contraintes de transport.

Si vous pensez que la protection de l'instruments a été altérée, débranchez le cordon d'alimentation et sécurisez l'instrument contre toute opération involontaire.

Une bonne utilisation de l'instrument nécessite la lecture et la compréhension de toutes les instructions et étiquettes.

	<p><b>Avertissement:</b> Toute utilisation de l'instruments d'une manière non spécifiée par le fabricant peut compromettre la protection de sécurité de l'instrument. Cet instrument ne doit pas être directement connecté à des sujets humains ni utilisé pour la surveillance des patients.</p>
---	---

## Conformité en matière de sécurité

La présente section présente les normes de sécurité applicables aux produits.

### U.S. nationally recognized testing laboratory listing

1. UL 61010-1:2012/R:2018-11. Prescriptions en matière de sécurité pour les appareils électriques utilisés en laboratoire et de mesure - partie 1: prescriptions générales.
2. UL 61010-2-030:2018. Prescriptions de sécurité pour les appareils électriques de mesure, de contrôle et de laboratoire - partie 2 - 030: prescriptions spéciales pour les circuits d'essai et de mesure.

### Canadian certification

1. CAN/CSA-C22.2 No. 61010-1:2012/A1:2018-11. Prescriptions en matière de sécurité pour les appareils électriques utilisés en laboratoire et de mesure - partie 1: prescriptions générales.
2. CAN/CSA-C22.2 No. 61010-2-030:2018. Prescriptions de sécurité pour les appareils électriques de mesure, de contrôle et de laboratoire - partie 2 - 030: prescriptions spéciales pour les circuits d'essai et de mesure.

## 3 First Steps

### 3.1 Delivery Checklist

First, verify that all items listed on the packing list have been delivered. If you note any omissions or damage, please contact your nearest **SIGLENT** customer service center or distributor as soon as possible. If you fail to contact us immediately in case of omission or damage, we will not be responsible for replacement.

### 3.2 Quality Assurance

The signal source has a 3-year warranty (1-year warranty for probe and accessories) from the date of shipment, during normal use and operation. **SIGLENT** can repair or replace any product that is returned to the authorized service center during the warranty period. We must first examine the product to make sure that the defect is caused by the process or material, not by abuse, negligence, accident, abnormal conditions, or operation.

**SIGLENT** shall not be responsible for any defect, damage, or failure caused by any of the following:

- a) Attempted repairs or installations by personnel other than **SIGLENT**.
- b) Connection to incompatible devices/incorrect connection.
- c) For any damage or malfunction caused by the use of non-**SIGLENT** supplies. Furthermore, **SIGLENT** shall not be obligated to service a product that has been modified. Spare, replacement parts and repairs have a 90-day warranty.

The signal source firmware has been thoroughly tested and is presumed to be functional. Nevertheless, it is supplied without a warranty of any kind covering detailed performance. Products not made by **SIGLENT** are covered solely by the warranty of the original equipment manufacturer.

### 3.3 Maintenance Agreement

We provide various services based on maintenance agreements. We offer extended warranties as well as installation, training, enhancement and on-site maintenance, and other services through specialized supplementary support agreements. For details, please consult your local **SIGLENT** customer service center or distributor.

## 4 Document Conventions

For convenience, text surrounded by a box border is used to represent the button of the front panel. For example, Utility represents the "Utility" button on the front panel. Use italicized text with character shading to represent clickable menus, options, and virtual buttons on the display screen. For example, Frequency represents the "Frequency" menu on the screen:

▶Frequency	▶Amplitude	▶ Offset	▶ Phase	Harmonic	
Period	HighLevel	LowLevel	Delay	Off	

For the operations that contain multiple steps, the description is in the form of "Step 1 > Step 2 >...". As an example, follow each step in the sequence to enter the system information interface:

Utility > System > Page1/3 > System Info

Press the Utility button on the front panel as step 1, click the System option on the screen as step 2, click the Page1/3 option on the screen as step 3, and click the System Info option on the screen as step 4 to enter the upgrade interface.

## 5 Introduction to SDG1000X Plus Series Arbitrary Waveform Generator

The SDG1000X Plus series dual channel function/arbitrary waveform generator has a maximum bandwidth of 60MHz and excellent sampling system indicators of 1GSa/s sampling rate and 16bit vertical resolution. Based on traditional DDS technology, it adopts innovative TrueArb and EasyPulse technologies to overcome the inherent defects of DDS technology in outputting arbitrary waves and square waves/pulses, and can provide users with high fidelity and low jitter signals. In addition, SDG1000X Plus also provides PRBS code generation, sequence wave output, and dual pulse output functions to meet a wider range of application needs.

Below are its performance characteristics, which will help you gain a deeper understanding of the technical specifications of SDG1000X Plus.

- Dual channel, maximum output frequency of 60 MHz, maximum output amplitude of 20 Vpp.
- 1 GSa/s analog-to-digital converter sampling rate, 16 bit vertical resolution.
- Using TrueArb technology, outputting any wave point by point, while ensuring no loss of waveform details, can achieve 1  $\mu$  Low jitter waveform output with variable sampling rate of Sa/s~250MSa/s.
- Supporting sequence wave playback function, with a maximum storage depth of 8 Mpts per channel.
- Adopting EasyPulse technology, it can output low jitter square waves/pulses, and the pulse wave can achieve fine adjustable pulse width and rising/falling edges, with extremely high adjustment resolution and range.
- Support multi pulse output function, which can be used to measure the switch parameters of power equipment and evaluate its dynamic characteristics.
- Can output PRBS code types up to 40 Mbps.
- Rich analog and digital modulation functions: AM, DSB-AM, FM, PM, FSK, ASK, PSK, and PWM.
- Scanning and Burst functions.
- Channel merging function.
- Hardware frequency meter function.
- 196 built-in arbitrary waves.
- Rich communication interfaces: standard USB Host, USB Device (USBTMC), LAN (VXI-11), optional GPIB.
- Built in WebServer supports controlling instruments through a web browser.
- 4.3 inch display screen.



## 6 Quick get start

### 6.1 Front panel



- A. **Power button** Used to turn on or off the signal generator. When the power button is turned off, the signal generator is in a power-off state.
- B. **USB Host** Used to connect USB storage devices, it can read waveforms or status files from the USB flash drive, or store the current instrument status to the USB flash drive.
- C. **Display area** Display the menu and parameter settings, system status, and prompt information of the current function.
- D. **Numeral key** Used to input parameter values.
- E. **Knob** When setting parameters, rotate the knob to increase (clockwise) or decrease the parameter value; When storing or reading files, rotate the knob to select the file.
- F. **Direction keys** Used to change the position of the cursor.
- G. **CH1/CH2 output control**  Output Button used to turn channel output on or off, Signal output from BNC port; Long press to quickly set the load to switch between 50 Ω and HiZ.
- H. **Channel switch key** Used to switch CH1 or CH2 to the currently selected channel.
- I. **Mode/Auxiliary function keys** Function menu shortcut key, can quickly enter the modulation/scanning/pulse train function menu, parameter settings, file manager, and view system information.
- J. **Waveform selection** Used to select output waveform.
- K. **Menu softkeys** Correspond one-to-one with the menu displayed above, press any soft key to activate the corresponding menu.

## 6.2 Rear panel



- A. **Counter** Frequency meter measured signal input port.
- B. **Aux In/Out** Input/output ports for triggering signals, output ports for synchronous signals, and input ports for external modulation signals.
- C. **10MHz In** External 10MHz reference clock input port.
- D. **Ground terminal** Used for instrument grounding.
- E. **AC power input** Power input port of signal generator.
- F. **10MHz Out** Internal 10MHz reference clock output port.
- G. **USB Device** Through this interface, a PC can be connected and the signal generator can be controlled through the upper computer software EasyWaveX or user-defined programming.
- H. **LAN port** Used to connect the signal generator to a computer or the network where the computer is located for remote control.

## 7 Screen display area

The interface of SDG1000X Plus can only display the parameters and waveform of one channel. The following figure shows the interface when CH1 selects sine wave AM modulation. The content displayed on the interface may vary depending on the current functionality.

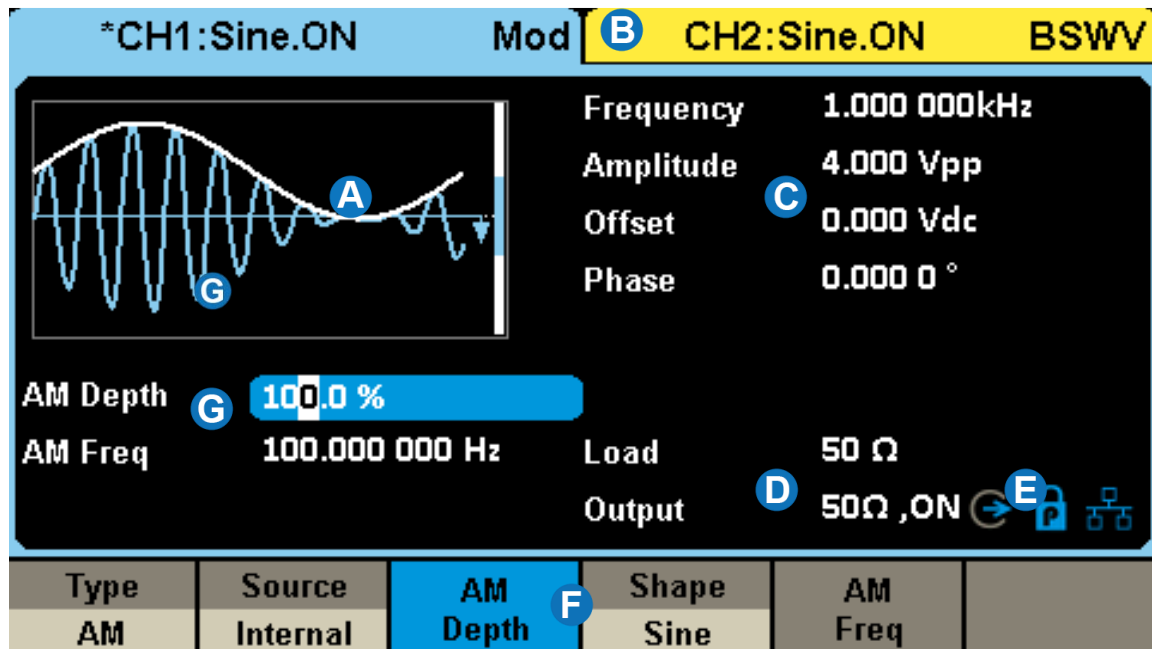

- A. **Waveform display area** Display the currently selected waveform for each channel.
- B. **Channel output configuration status bar** The status display area of CH1 and CH2 indicates the selection status and output configuration of the current channel.
- C. **Basic waveform parameter area** Display the parameter settings for the current waveform of each channel.
- D. **Channel parameter area** Display the load settings and output status of the currently selected channel.
- E. **Prompt** From left to right are the clock source prompt, phase mode prompt, and LAN connection status prompt, respectively.
- F. **Menu** Display the operation menu corresponding to the currently selected function, and select the corresponding function through the menu soft key.
- G. **Modulation parameter area** Display the parameters of the current channel modulation function.

## 8 Front Panel Control

### 8.1 Waveform selection settings

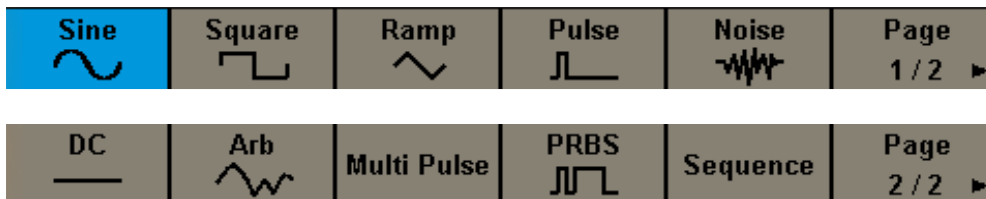

There is a column of **Waveforms** selection buttons under the Waveforms operation interface, which are sine wave, square wave, triangular wave, pulse wave, Gaussian white noise, DC, arbitrary wave, multi pulse, PRBS, and sequence wave.

### 8.2 Mod/Sweep/Burst settings



Press the **Burst** / **Mod** / **Sweep** button to quickly turn on/off the pulse train/modulation/sweep function and jump to the corresponding parameter settings page. When the function is turned on, the corresponding button light will light up.

### 8.3 Number keyboard and knob



Use the numeric keypad to directly input the numerical value and magnitude of the selected parameter. For example, to set the frequency to 1 MHz, press button **1** and **MHz** in sequence.



In addition to using the numeric keypad to directly input parameter values, knobs can also be used to achieve continuous adjustment of parameters. Press the knob on the selected parameter box, and press the button below the knob **◀** And **▶** Select the digit to be adjusted with the key, then turn the knob clockwise to increase the value, or counterclockwise to decrease the value.

## 8.4 Common function buttons

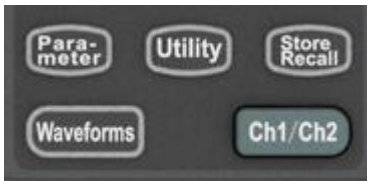

Press the **Parameter** / **Utility** / **Store/Recall** button to quickly switch to the corresponding settings page for waveform parameter configuration, auxiliary function settings, and storage calls.

Press the **Ch1/Ch2** button to quickly switch between the CH1 and CH2 parameter settings pages.

Press the **Waveform** button to quickly access the waveform selection menu; Press the **Utility** button to quickly access the system settings menu.



Use the **Output** button to turn on/off the signal output of the output interface on the front panel. Select the corresponding channel, press the **Output** button, the button light will be on, and at the same time, turn on the output switch to output a signal; Press the **Output** button again to turn off the output. Long press the **Output** button to quickly switch load settings between "50  $\Omega$ " and "HiZ".

## 9 Basic waveform settings

### 9.1 Standard waveform settings

This section applies to sine waves, square waves, pulses, triangular waves, and direct currents. Taking setting a sine wave as an example, the following will explain some basic parameters of the standard waveform.

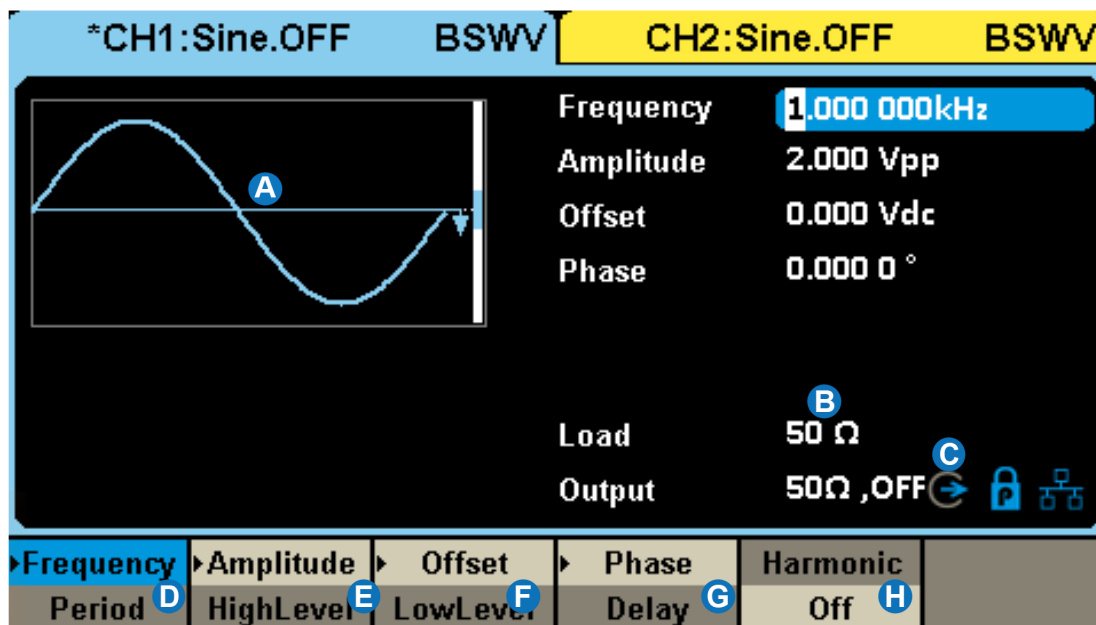

- A. Waveform preview image
- B. Load parameter display
- C. Output status display
- D. Frequency/cycle parameter setting menu
- E. Amplitude/High Level Parameter Setting Menu
- F. Offset/Low Level Parameter Setting Menu
- G. Phase/Delay Parameter Setting Menu
- H. Harmonic parameter setting menu (only applicable to sine waves)

## Load

To understand the setting of the load, it is first necessary to understand that due to the voltage division effect of the load and the internal resistance of the signal source (Figure 9.1), the voltage  $V_o$  seen by the user is a variable related to the load  $R_L$ :

$$V_o = V_s \cdot \frac{R_L}{R_L + R_s}$$

Among them,  $V_s$  is the output voltage of the signal source before the internal resistance, and  $R_s$  is the internal resistance of the signal source. Due to the inability of the signal source to automatically recognize the size of  $R_L$ , users need to inform the signal source of this value by inputting the "load" value, and then the signal source calculates the expected  $V_s$  based on the  $R_L$  and  $V_o$  set by the user, so that under any load situation, the voltage value obtained by the user is consistent with the expected value.

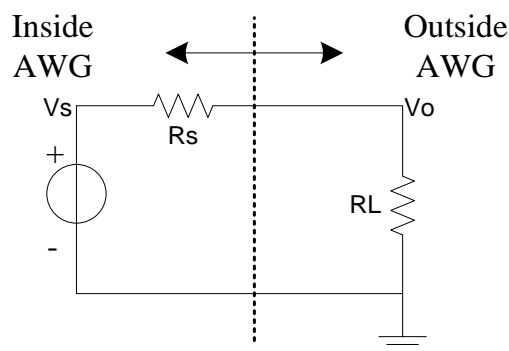

Figure 9-1

## Waveform parameters

The parameters that can be set for each standard wave are different, as shown in the table below:

Table 9-1 Explanation of Standard Waveform Parameters

Sine	
Frequency/Period	The frequency/period of the signal. The unit of frequency is Hz, and the unit of period is s. The relationship between the two is: <i>Frequency = 1 / Period</i>
Amplitude/HighLevel Offset/LowLevel	Frequency=1/amplitude value/offset of a periodic signal, linked to high/low levels. The amplitude value refers to the difference between the highest point (high level, unit V) and the lowest point (low level, unit V) of a signal. The supported units include Vpp, Vrms, and dBm (available when the load $\neq$ HiZ); The offset refers to the DC component superimposed on the signal waveform, measured in volts; The relationship between several parameters is: <i>Amplitude value (Vpp) = HighLevel - LowLevel</i> <i>Offset = (HighLevel + LowLevel) / 2</i>

Phase/Delay	<p>The phase/delay of the signal is only meaningful when the dual channel phase mode is phase locked, used to set the phase relationship between two channels. The unit of phase is °, and the unit of delay is s. The relationship between the two is:</p> $\text{Delay} = - (\text{period} \times \text{phase} / 360 \text{ } ^\circ)$
<b>Square</b>	
Frequency/Period	Same as sine wave.
Amplitude/HighLevel Offset/LowLevel	Same as sine wave.
Phase/Delay	Same as sine wave.
DutyCycle	The ratio of the positive pulse width to the period of a square wave, in %
<b>Pulse</b>	
Frequency/Period	Same as sine wave.
Amplitude/HighLevel Offset/LowLevel	Same as sine wave.
Width/DutyCycle	<p>Pulse width refers to the positive pulse width of a pulse, measured in seconds; Duty cycle refers to the ratio of positive pulse width to cycle, measured in %. The relationship between the two is:</p> $\text{Pulse width} = \text{period} \times \text{duty cycle}$
Rise/Fall	The rising edge refers to a rising time of 10% to 90%, and the falling edge refers to a falling time of 90% to 10%, both of which are measured in seconds. The rising and falling edges are independent of each other and can be set separately
Delay	Same as sine wave.
<b>Ramp</b>	
Frequency/Period	Same as sine wave.
Amplitude/HighLevel Offset/LowLevel	Same as sine wave.
Phase/Delay	Same as sine wave.
Symmetry	The ratio of the time and period during which a triangular wave is rising, expressed in %
<b>DC</b>	
Offset	Same as sine wave.





Application example: Set CH1 output sine wave with the following parameters:

- load = 50  $\Omega$
- frequency = 1 MHz
- amplitude = 0 dBm
- offset = 0 V
- phase = 180°

### 1. Select waveform

Press the **Waveforms** button and select "Sine" from the pop-up waveform selection menu:

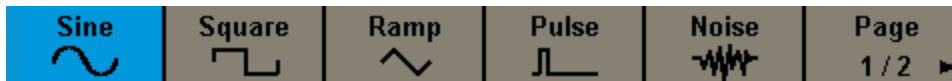

### 2. Set load

Long press the **Output** button for 2 seconds, and the load parameter will display 50  $\Omega$ .

### 3. Set waveform parameters

Set frequency: Select the frequency setting menu, type **1** in the numeric keypad on the front panel, and then select the unit in **MHz** from the pop-up menu.

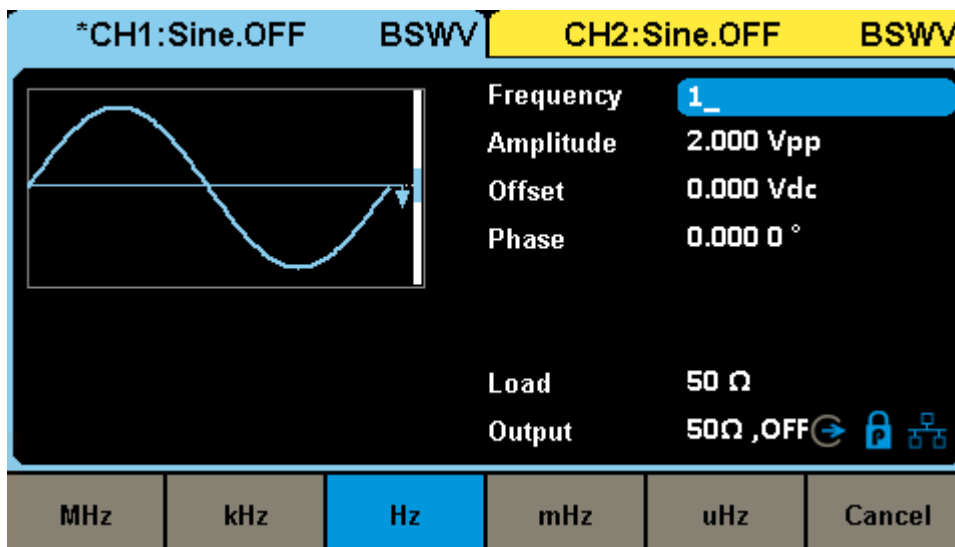

Set amplitude: Select the amplitude setting menu, type **0** in the numeric keypad on the front panel, and then select the unit in **dBm** from the pop-up menu.

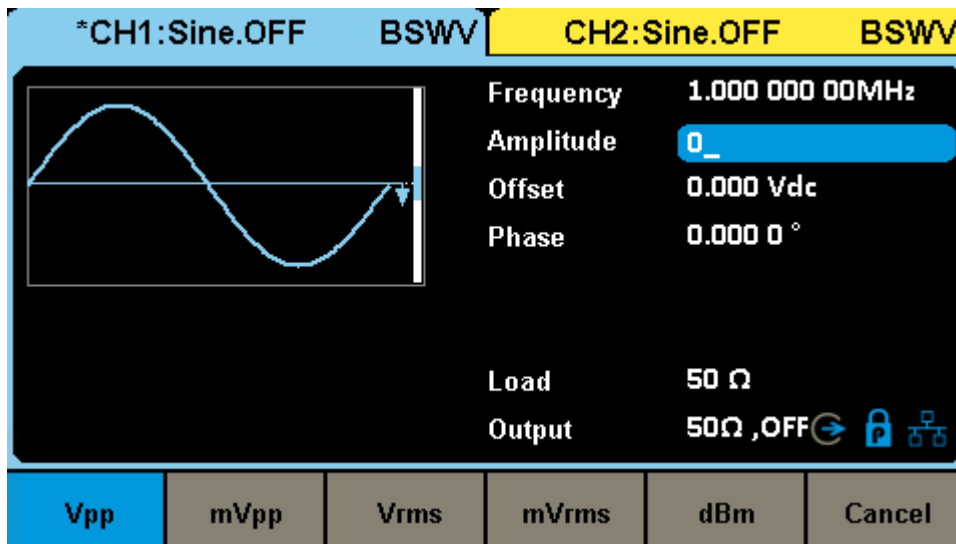

Set offset: Select the offset setting menu, type  in the numeric keypad on the front panel, and then select the unit as  from the pop-up menu.

Set phase: Select the phase setting menu, type  in the numeric keypad on the front panel, and then select the unit as  from the pop-up menu.

#### 4. Open output

Select channel 1, press the  button, the button light will be on, and at the same time, turn on the output switch to output a signal.

Follow the above steps to output the expected sine wave. The carrier wave page after setting is as follows:

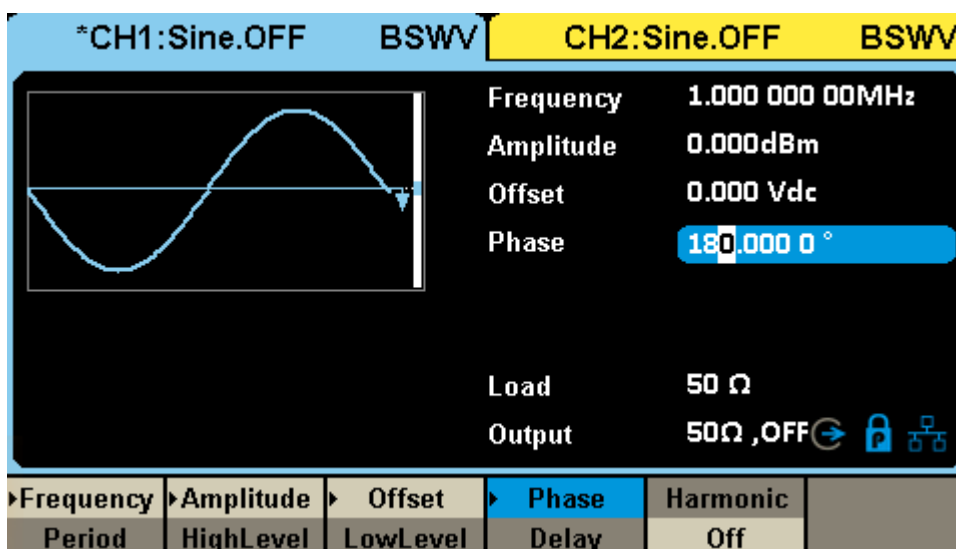

## 9.2 Harmonic settings

Harmonics are a sub function of the sine wave generation function, Can output harmonics with specified number, amplitude, and phase, Used to simulate sine waves with poor linearity.

Under the parameter settings page for carrier wave=sine wave, Clicking on "Harmonics" will bring up a menu for setting harmonic parameters, You can enter the interface for harmonic settings.

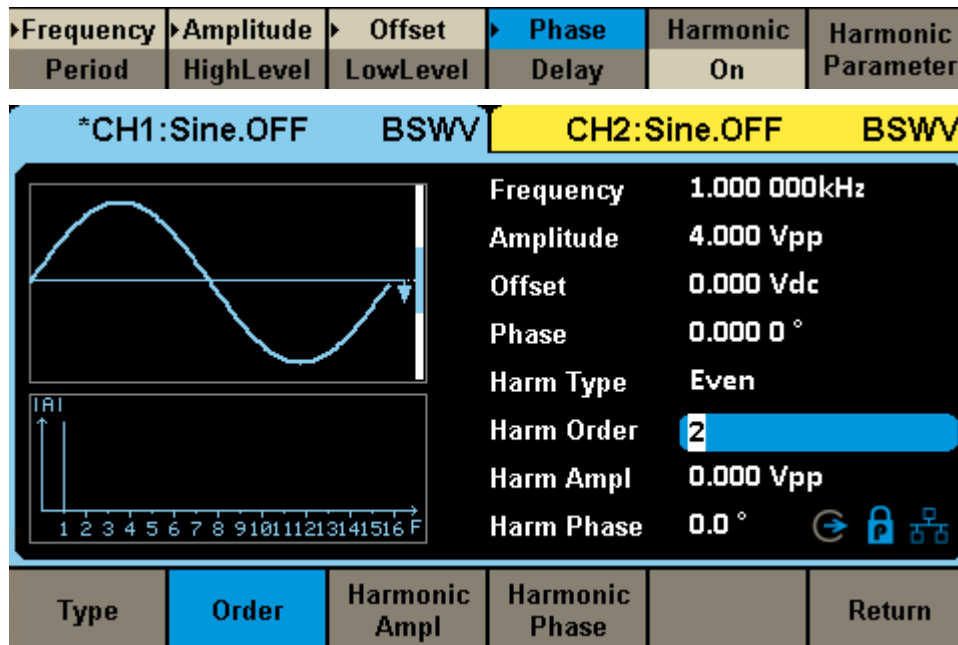

### Set harmonic type

Click on the parameter value area of the harmonic type in the "Type" parameter setting box, and select the harmonic type in the pop-up parameter selection dialog box. If only odd harmonics are set, select "odd harmonics"; If only even harmonics are set, select "even harmonics"; If both odd and even harmonics need to be set, select "Custom".



### Set harmonic frequency

Click on the "Frequency" parameter setting menu, and then type the desired harmonic frequency through the numeric keypad or through the knob. If the type is odd harmonic, only odd values can be entered; If the type is even harmonic, only even values can be entered; If the type is custom, you can type any integer within the range of 2 to the maximum number of harmonics.

### Set harmonic amplitude

Click on the "Harmonic Amplitude" setting menu, use the numeric keypad or knob to set the desired amplitude, and then select the unit as "Vpp" or "dBc". The unit "Vpp" is suitable for setting the absolute amplitude of harmonics, and the unit "dBc" is suitable for setting the relative amplitude of harmonics.

relative to the fundamental frequency signal.

### Set harmonic phase

Click on the "Phase" setting menu, then type the desired value through the knob or numeric keypad. The unit of phase is  $^{\circ}$ .

### Enable harmonic function

After setting all harmonic parameters, the time-domain waveform can be previewed through the waveform preview diagram, and the harmonic schematic diagram can be used to browse the set harmonics and their approximate amplitudes. After confirming accuracy, open the output of the channel to output harmonic waveforms.



Application example: Set CH1 output sine wave and its harmonics, with the following parameters:

- fundamental frequency = 1 kHz, fundamental amplitude = 0 dBm
- Second harmonic amplitude -30dBc, phase  $0^{\circ}$
- Third harmonic amplitude -40dBc, phase  $0^{\circ}$

1. Refer to the application example in the previous section and set the waveform, frequency, and amplitude of the fundamental wave.

2. Set harmonics

Because harmonics contain both second and third harmonics, it is necessary to set "Type" to "Custom";

First, set the amplitude and phase of the second harmonic: select "number" as "2"; Select the unit of "harmonic amplitude" as "dBc", and then set the value to "-30"; Set the "harmonic phase" to "0" and default the unit to  $^{\circ}$  ;

Set the amplitude and phase of the third harmonic again using the same method as the second harmonic.

Follow the above steps to output the expected sine wave and harmonics. The harmonic page after setting is as follows:

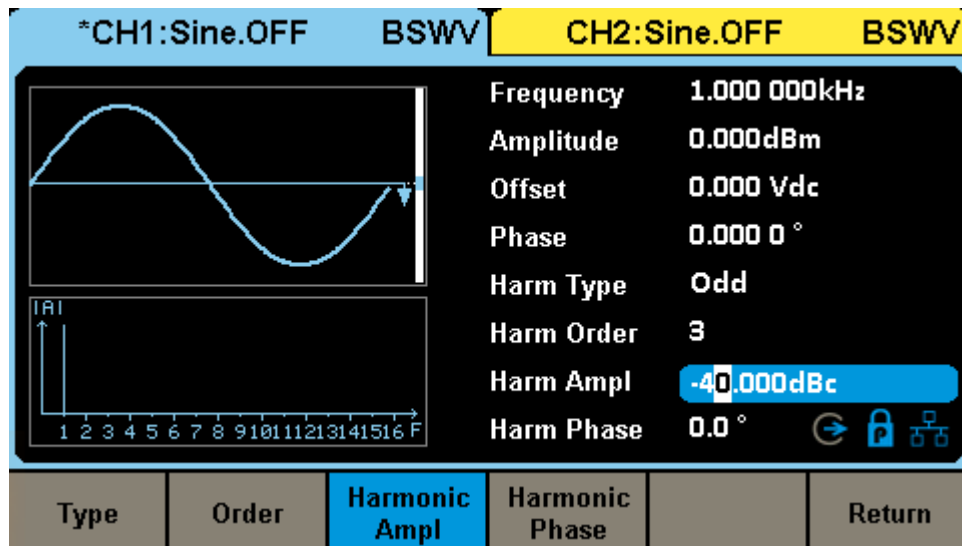

## 9.3 Noise settings

The noise generation function can provide Gaussian noise with adjustable bandwidth.

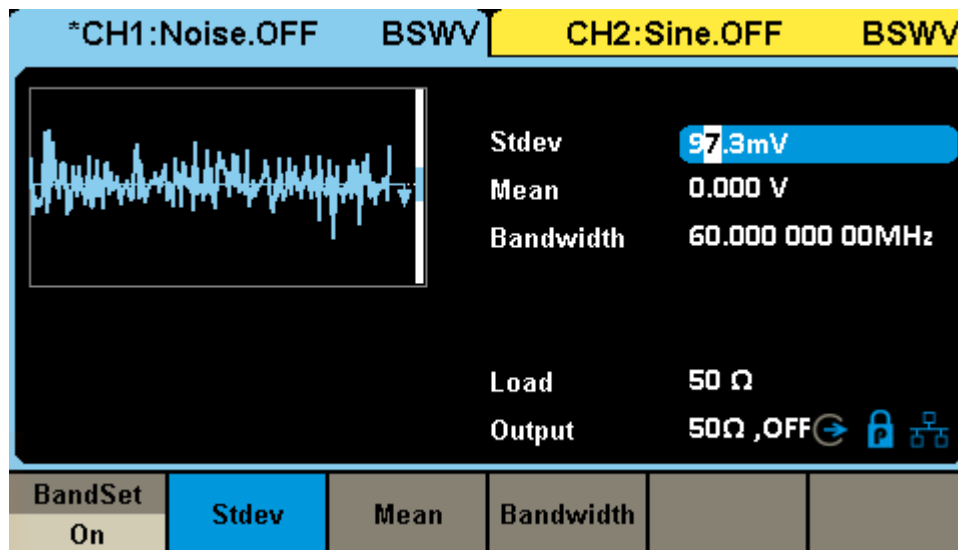

### Set waveform parameters

The waveform parameters of noise include "standard deviation" and "mean". Due to the noise following a Gaussian distribution (normal distribution), using mean ( $m$ ) and standard deviation ( $\sigma$ ) It can characterize its distribution characteristics. The setting method refers to the waveform parameter settings of sine waves.

Table 9–2 Explanation of Noise Waveform Parameters

Noise	
Stdev	Standard deviation of noise sequence.
Mean	Mean value of noise sequence (mathematical expectation).

### Set bandwidth

To set the bandwidth for noise, first click on the switch area in the bandwidth switch settings box, open the bandwidth settings, and then type in the desired value and unit.



Application example: Set the noise of CH2 output with the following parameters:

- Stdev  $\sigma = 100$  mVrms
- Mean  $E = 0$  V
- Bandwidth = 20 MHz
- External load with high resistance

1. If the current parameter setting page is CH1, switch to CH2.
2. Set the waveform to "Noise".
3. Set "load" to "high resistance".
4. Set the "standard deviation" to 100 mV.
5. Set the "mean" to 0 V.
6. Open "Bandwidth Settings" and set the bandwidth to 20 MHz in the "Bandwidth" parameter settings box that appears below.
7. Open output.

Follow the above steps to output the expected noise. The parameter page after setting is as follows:

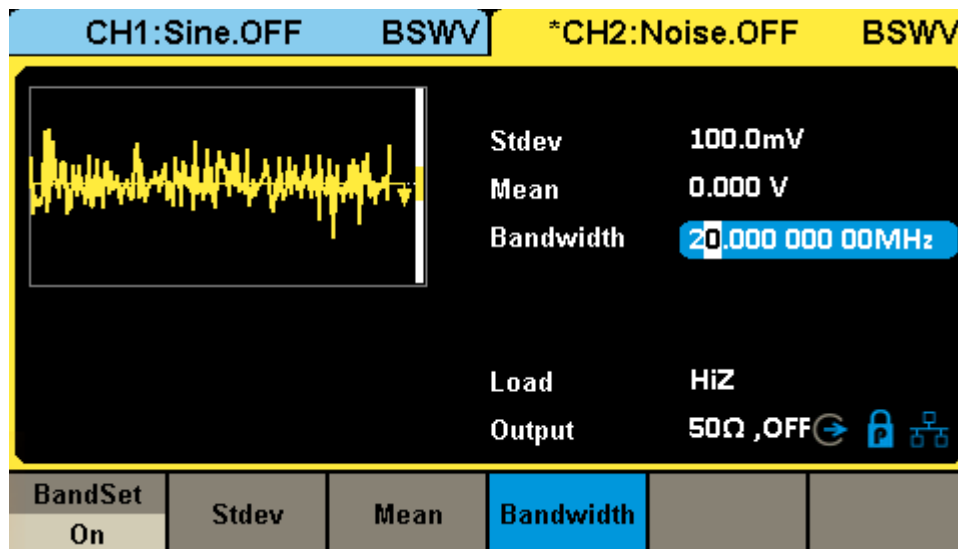

## 9.4 PRBS settings

The PRBS generation function can generate a maximum bit rate of 40 Mbps along a configurable pseudo-random sequence.

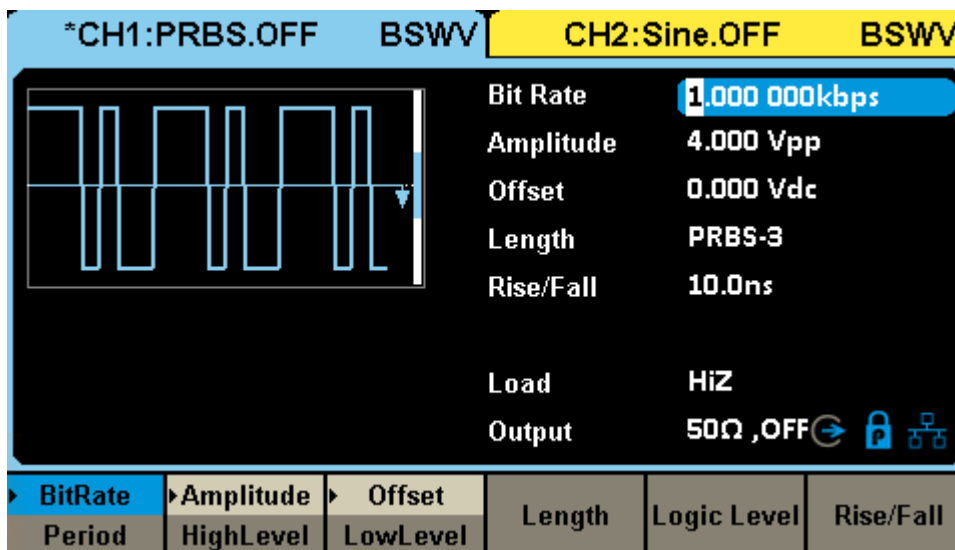

### Set waveform parameters

The waveform parameters of PRBS are shown in the table below. The setting method refers to the waveform parameter settings of sine waves.

Table 9–3 Description of PRBS waveform parameters

PRBS	
BitRate/Period	The bit rate/symbol period of PRBS sequence, with the unit of bit rate being bps and the unit of symbol period (UI) being s. The relationship between the two is: $Bit\ rate = 1 / Period$
Amplitude/HighLevel Offset/LowLevel	Same as sine wave.
Logic Level	Used to quickly set the amplitude to some standard levels. See Table 9.4 for details.
Length	PRBS-3~32 can be set, corresponding to lengths $(2^3-1) \sim (2^{32}-1)$ .
Rise/Fall	Refers to a rise time of 10% to 90% and a decrease time of 90% to 10%, in seconds. Setting both rising and falling edges simultaneously.



Table 9–4 Logic Levels Supported by PRBS

Logic level	Amplitude (Vpp)	Offset (V)
TTL/CMOS	5.00	2.50
LVTTL/LVCMOS	3.30	1.65
ECL	0.80	-1.30
LVPECL	0.80	2.00
LVDS	0.35	1.25



The preset logic levels in the table are only valid when the output mode is single ended.



Application example: Set PRBS for CH1 to output the following parameters:

- Differential Output
- BitRate = 1 Mbps
- Differential swing = 300 mVpp
- Length is PRBS-7
- edge = 20 ns

1. Turn on differential output in "logic level".
2. Set the "bit rate" to 1 Mbps.
3. Set the "amplitude" to 300 mVpp and the "offset" to 0.
4. Set the "length" to PRBS-7.
5. Set the "edge" to 20 ns.
6. Open output.

Follow the above steps to output the expected PRBS waveform. The parameter page after setting is as follows:

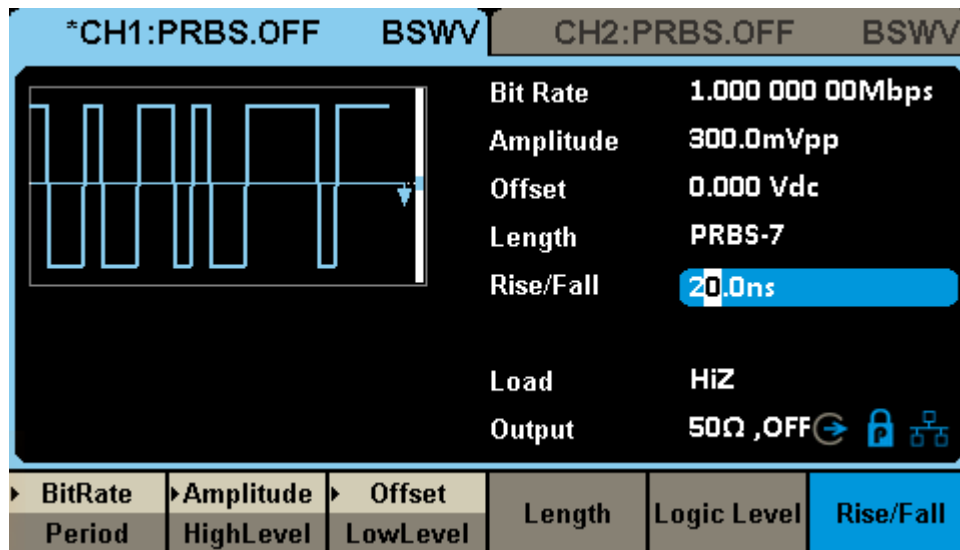

## 9.5 Arbitrary Waveform settings

Any wave provides two working modes: DDS mode and point-to-point output mode. On the parameter setting page for any wave with a carrier wave, click on the mode parameter value area in the "Mode" parameter setting box to select the desired working mode.

### 9.5.1 DDS mode

In DDS mode, the signal generator outputs any specified wave in the traditional DDS manner. At this point, the basic waveform parameter settings are the same as the sine wave, refer to the "Standard waveform settings" section.

For the selection and editing of data sources for any wave, refer to the "Data Sources" section.

### 9.5.2 TrueArb mode

In the point by point output mode, the signal generator samples the TrueArb technique (Figure 9.2) and outputs the specified waveform sequence point by point at the specified sampling rate. TrueArb overcomes the serious drawbacks of traditional DDS technology, which may increase jitter and distortion when generating arbitrary waves, while retaining its advantages of low cost and simplicity and flexibility.

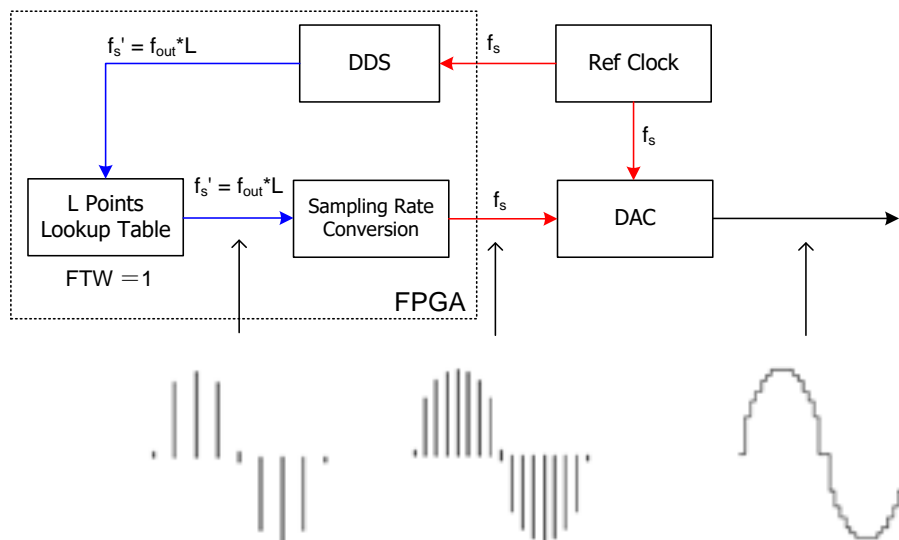
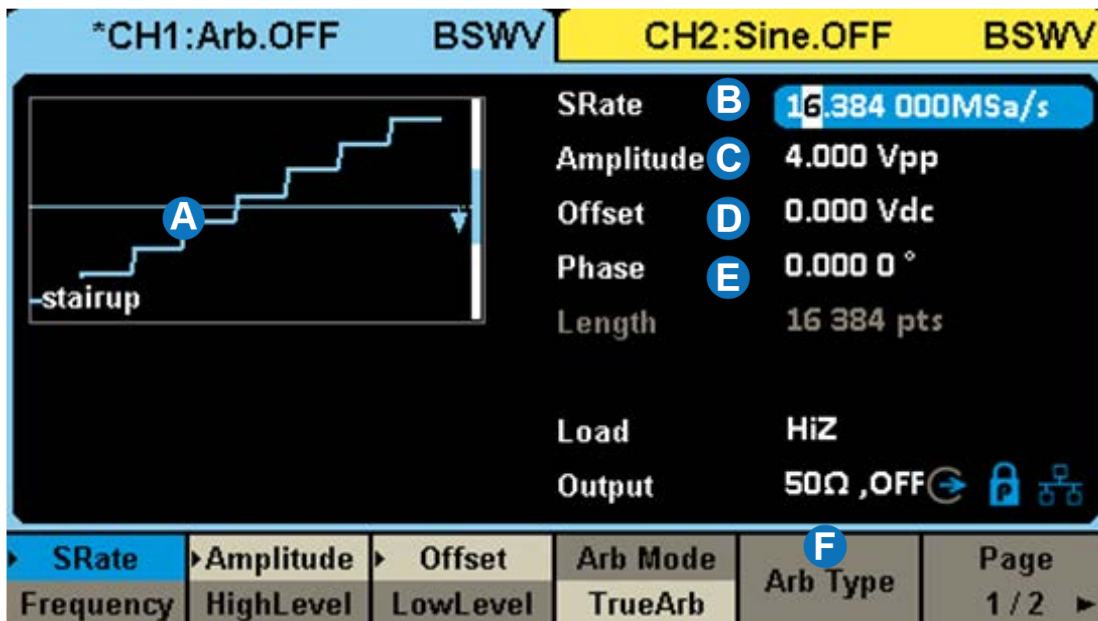

Figure 9.2 TrueArb Technology Principle Block Diagram



- A. Waveform preview
- B. SRate/frequency parameter setting box
- C. Amplitude parameter setting box
- D. Offset parameter setting box
- E. Phase parameter setting box
- F. Selection of waveform data source

### Set waveform parameters

The waveform parameters outputted point by point are shown in the table below. The setting method refers to the waveform parameter settings of sine waves.

Table 9-5 Explanation of Point by Point Output Waveform Parameters

TrueArb	
SRate/Frequency	The sampling rate/frequency of the signal. The unit of sampling rate is Sa/s, which refers to the rate at which waveform points are captured; The unit of frequency is Hz. The relationship between the two is $SRate = frequency \times Length$
Amplitude/HighLevel Offset/LowLevel	Same as sine wave.
interpolation method	The interpolation methods for waveforms are detailed in Table 9.6

Table 9–6 Interpolation Methods Supported for Point by Point Output

interpolation method	Description
0-order hold	Zero-Order hold
Linear	linear interpolation

### 9.5.3 Data source

Click on the "Load Waveform" parameter setting menu to enter the data source selection interface. The data sources include built-in waveforms and stored waveforms.

#### Built in waveform

Built in waveforms are pre configured waveforms within a signal generator, which can be divided into several types: commonly used, mathematical, engineering, window functions, trigonometric functions, square waves, medical electronics, modulation, filters, and demonstrations. There are multiple waveforms available for selection under each type.

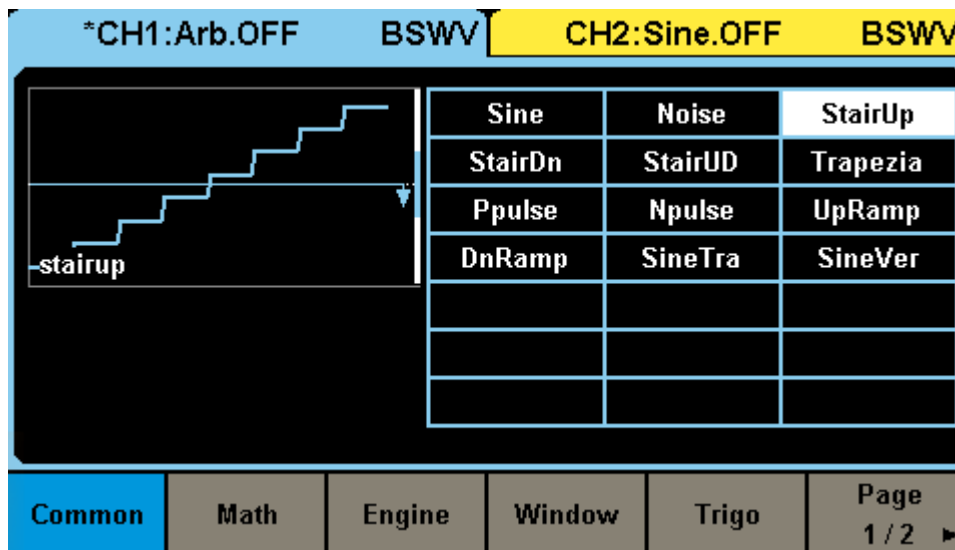

#### Existing waveform

The saved waveform is a waveform file saved by the user in a local directory, external USB drive, or sent to the device through the upper computer software (EasyWaveX) and saved locally. When selecting the data source as "saved waveform", the file manager window will be automatically called. Select the waveform file that needs to be called in this window, and then click "Load" to proceed. For the operation method of the file management window, please refer to the "Store/Recall" chapter.

#### EasyWaveX

EasyWaveX, an arbitrary wave editing software, provides 12 standard waveforms including Sine,

Square, Ramp, Pulse, Noise, and DC, which can meet the most basic needs; At the same time, it also provides users with manual drawing, line drawing (including horizontal lines, vertical lines, and two-point lines), coordinate drawing (coordinates can be entered through the mouse or table, and there are two ways to connect and smooth), and equation drawing, making creating complex waveforms light and easy.

Regarding the use of EasyWaveX, please refer to the software's user manual.



Application example: Using the upper computer software EasyWaveX to generate digital clock and data waveforms that simulate the following timing relationships, and downloading them to the CH1 and CH2 outputs of any waveform generator, with adjustable rates.

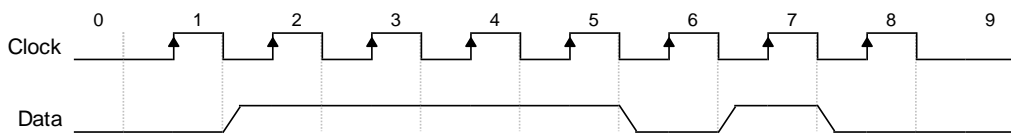

1. Connect devices and computers with EasyWaveX upper computer software installed via USB or LAN.
2. Open EasyWaveX and create any wave at 30 points.
3. In the "Properties" section of the toolbar, select "Waveform Properties" , Input the voltage levels of each point in the "Draw Point Table" point by point according to the clock's "0" and "1" jump pattern, as shown in the following figure:

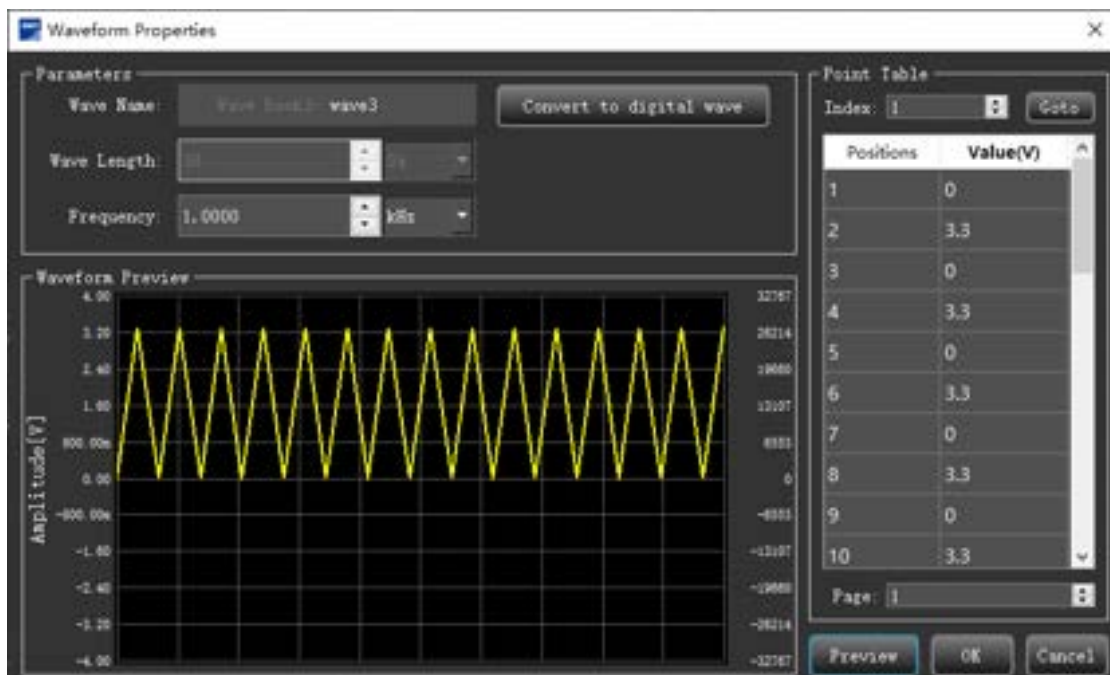

4. After entering, view the waveform in the waveform preview window of the main program. In the "Properties" area of the toolbar, select "View Properties" , Change the "interpolation method" to "zero order preservation" to obtain the correct waveform preview of the digital clock:

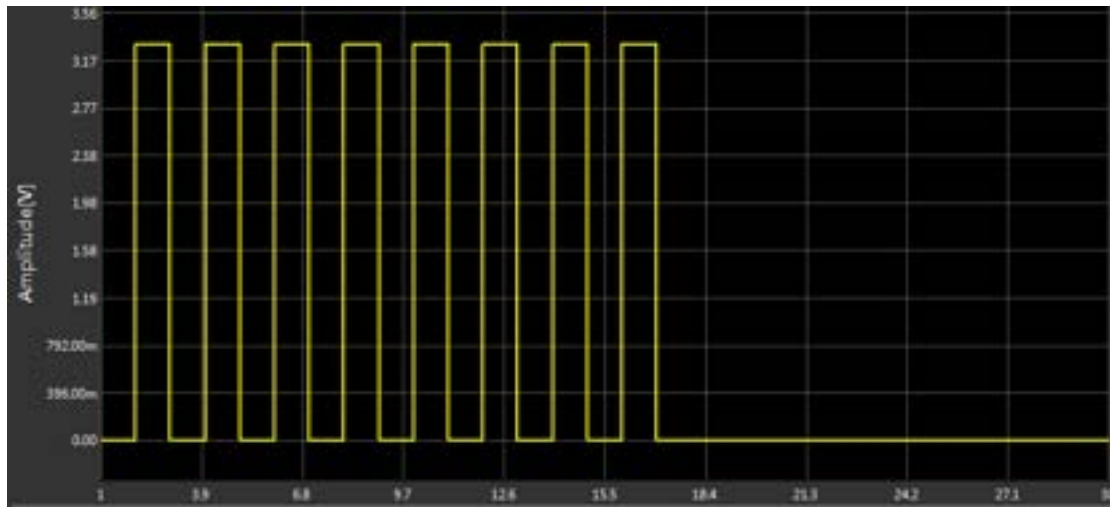

5. Execute `communication > Send waveform to signal source`, select the device to perform waveform output in the pop-up dialog box, click `connect`, and select the download target channel as CH1:



6. Generate data files using the same method and download them to the device's CH2.  
 7. Set the "interpolation method" of two channels to "0-order hold" on the device.  
 8. Set the amplitude and rate of clock and data output on the device as needed. For example, to set the clock frequency to 1 MHz, set the sampling rate of the clock channel to 2 MSA/s. Due to the synchronization of clock and data, CH1 and CH2 can be set to frequency coupling with a ratio

of 1 (refer to the " Channel cope and coupling " section for the setting method), In this way, you only need to set the speed of one channel, and the speed of the other channel can be updated synchronously. The final clock and data signals output by the device are as follows:

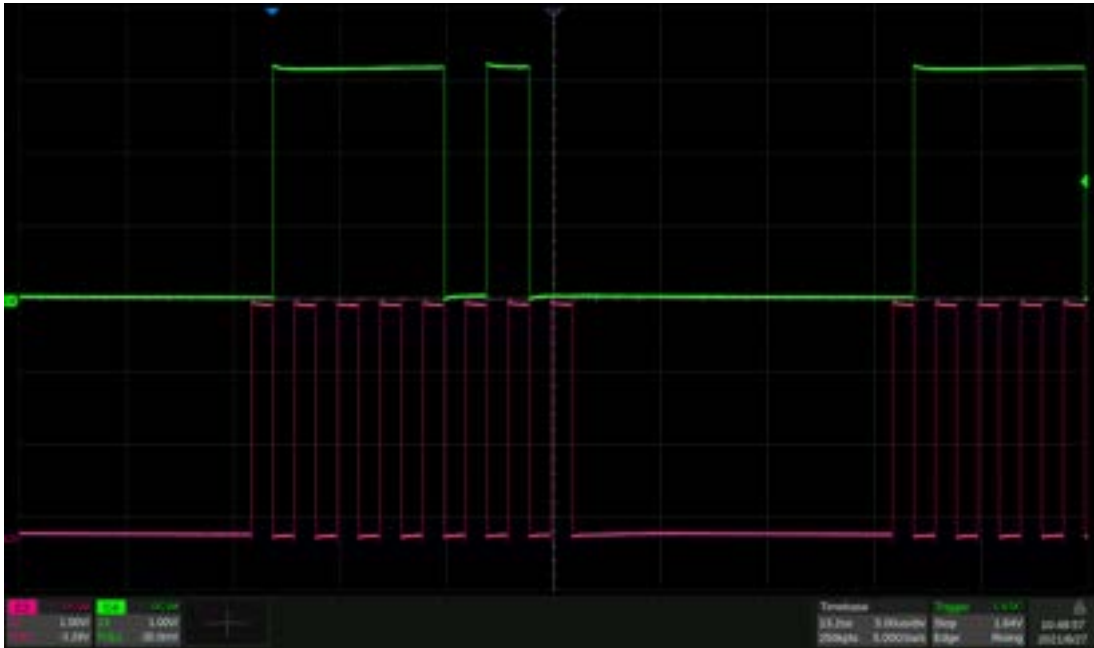

The waveform generated by EasyWaveX can be saved as a CSV file for further editing. After the editing is completed, it can be imported into EasyWaveX and distributed to the device through EasyWaveX. CSV files can also be stored on a USB drive, and the device can directly call them from the USB drive.



## 9.6 Sequence settings

SDG1000X Plus can output sequence waveforms, and the sequence waveform and output sequence can be user-defined. The maximum number of total waveform points for a sequence wave is 8 Mpts. The edited sequence waveform can be stored in the instrument's internal or external memory.

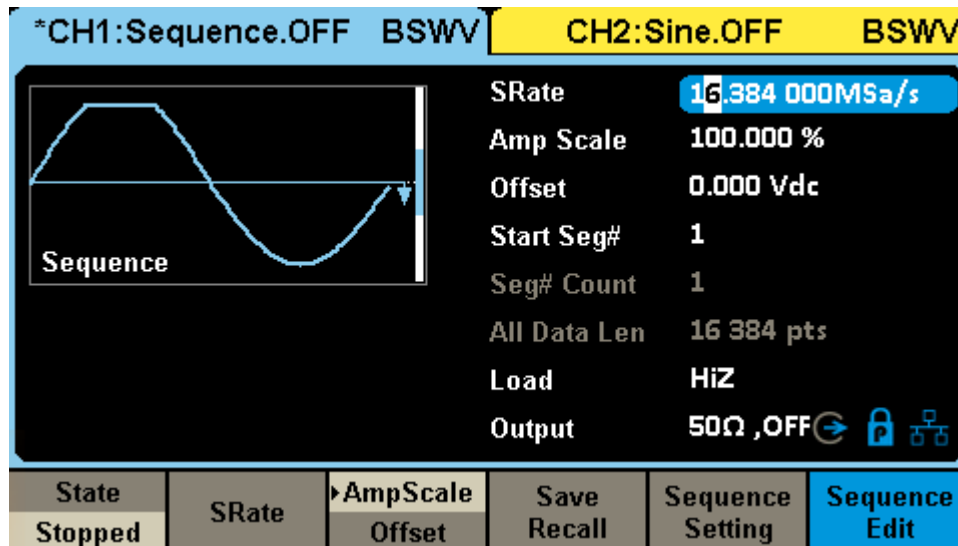

### Set waveform parameters

Table 9–7 Description of waveform parameters for segments

Sequence	
State	Start or stop the sequence wave output, press the corresponding function button to switch between stop and play. The waveform is only output when the status is running and the Output is turned on.
SRate	Set the sampling rate for waveform output.
AmpScale	Set the amplitude of each waveform segment separately in waveform editing, and the amplitude scaling setting here will proportionally reduce the amplitude of all waveform segments.
Offset	Set the offset level of the entire sequence waveform.
Save/Recall	Save the current sequence wave file or load a stored sequence wave file.

### Sequence settings

Table 9–8 Functional Definition of Sequence Settings

operate	Description
Run mode	It can switch between continuous and single step operation modes. Continuous mode is where each waveform segment is played in the set order after departure, and repeated after completion. Single step mode outputs a waveform every time it is triggered.

IntPolation	Setting interpolation method refers to the interpolation strategy for the entire sequence waveform when the set sampling rate is below 250MSa/s. Two methods can be set: "zero order preservation" or "linear interpolation".
Source	Set the trigger signal source. In single step mode, there are two types of trigger sources: manual and external. In continuous mode, it is fixed as an internal trigger source.
Hold Value	The level value output during the idle time when a waveform is not triggered or when a waveform is played, and the next waveform is not played, has three states: termination value, intermediate value, and starting value.
Start Seg	Set which waveform segment the sequence wave starts playing from.
Decreasing	The user can edit the waveform length, and when the set waveform length is less than the length of the original waveform file, the sampling method used is. Supports three sampling methods: linear sampling, tail truncation, and head truncation.
Increasing	The interpolation method used when the set waveform length is greater than the length of the original waveform file. Supports four interpolation methods: linear interpolation, zero, hold, and periodic repetition.
edge	When the triggering source is external, the rising or falling edge can be selected for triggering.

## Sequence editing

Table 9–9 Functional Definition of Sequence Editing

Interpolation method		Description
ADD Seg		Add a waveform at the end of the sequence.
Del Seg		Delete the current waveform segment.
Insert Seg		Insert a waveform before the current position.
Clear List		Clear all segments of the sequence waveform.
Seg Setting	Length	Set the length of the current waveform segment.
	Loop	Set the number of repetitions of the current waveform segment, and the total waveform length space occupied by a certain segment is the waveform length multiplied by the number of plays.
	Goto	Set the waveform to be played in the next segment after the current waveform is played.
	Data Source	Select a waveform file, which can be either a saved waveform or a built-in waveform.
	Amplitude/ HighLevel	Set waveform amplitude/high level.
	Offset/ LowLevel	Set waveform offset/low level.



Application example: Output a waveform sequence and sequentially output the following segments:

- wave = Sine, 16384 pts, 2Vpp, Repeat 1 times
- wave = Square\_Duty50, 16384 pts, 1Vpp, Repeat 2 times
- wave = UpRamp, 16384 pts, 2Vpp, Repeat 3 times

1. In the waveform selection menu, select "Sequence" waveform.
2. Go to "Sequence Editing", click on "Add Section", and add 2 waveforms.
3. Select the first waveform segment through the knob, go to segment settings > data sources > built-in waveforms, and select "Sine" in the directory with "waveform type"="common".
4. Set the "playback count" of the first paragraph to 1.
5. Set the "amplitude" to 2 Vpp and the offset to 0 V.
6. Follow similar steps 3-5 to set the waveform and parameters for the second segment.
7. Follow similar steps 3-5 to set the waveform and parameters for the third segment.
8. Click the "Running/Stopped" button to start sequence playback.
9. Open output.

The following figure shows the actual output waveform:

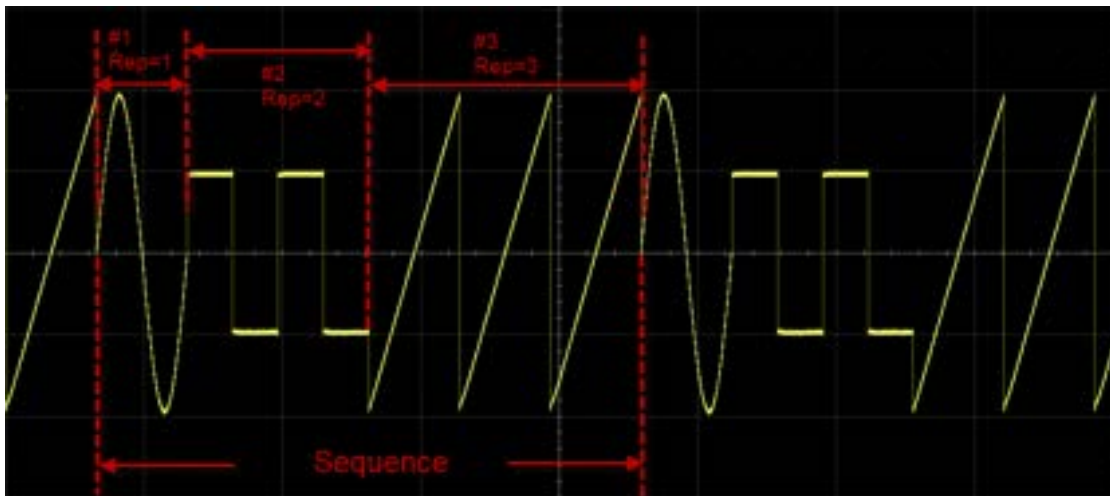

In the case of Sequence, the actual output amplitude is also affected by the amplitude scaling of the carrier setting interface. For example, if the amplitude set on the Sequence page is 2 Vpp, and the amplitude scaled to 50% on the Carrier Settings page, the actual output amplitude is 1 Vpp.

## 9.7 Multi Pulse settings

The SDG1000X Plus has a built-in multi pulse output function, which facilitates the testing of the switching characteristics of power devices.

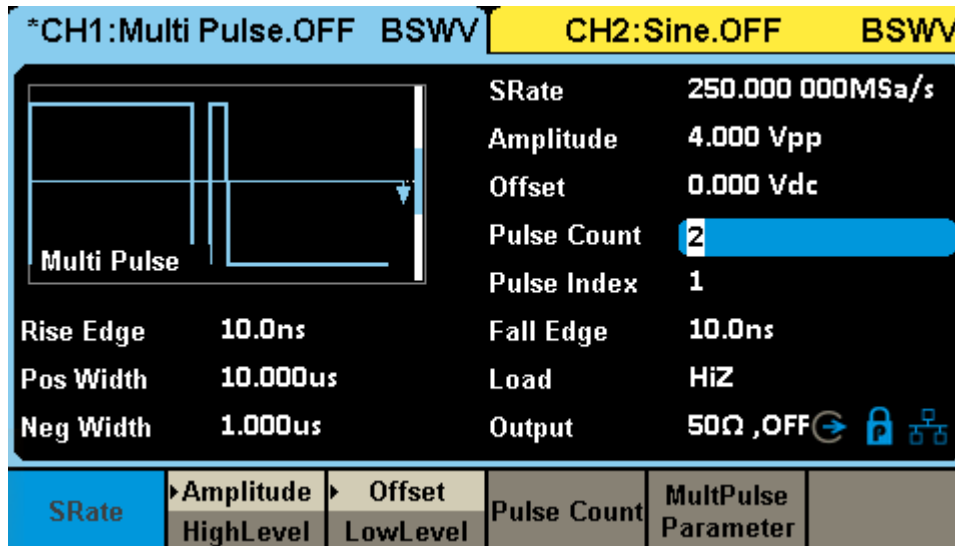

### Set waveform parameters

The parameters of multi pulse waves mainly include: sampling rate, amplitude/high level, offset/low level, delay, pulse number, rising edge, falling edge, positive pulse width, and negative pulse width. The setting method refers to the waveform parameter settings of sine waves.

Table 9–10 Explanation of Multi Pulse waveform parameters

Multi Pulse	
SRate	The sampling rate is limited to 250MSa/s.
Amplitude/HighLevel Offset/LowLevel	Same sine wave parameter settings.
Pulse Count	Set the number of multi pulse waveform pulses.
Multi Pulse Parameter	Set the rise time, fall time, positive pulse width, and negative pulse width of the pulse.



Application example: Set CH1 output dual pulse with the following parameters

- Pulse Count = 2
- Amplitude = 2 Vpp
- Offset = 0 V
- Pulse 1/2 Rise = 30ns
- Pulse 1/2 Fall = 20ns
- Pulse 1/2 Positive pulse width = 10us
- Pulse 1/2 Negative pulse width = 20us

### 1. Select waveform

Press the **Waveforms** button and select "Multi Pulse" from the pop-up waveform selection menu:

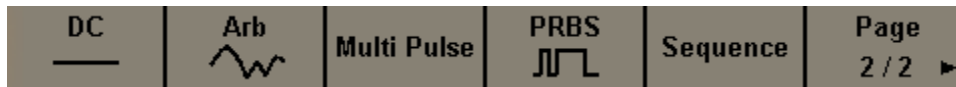

### 2. Set waveform parameters

**Set amplitude:** Select the amplitude setting menu, type **2** in the numeric keypad on the front panel, and then select the unit as **Vpp** from the pop-up menu.

**Set offset:** Select the offset setting menu, type **0** in the numeric keypad on the front panel, and then select the unit as **Vdc** from the pop-up menu.

**Set pulse count:** Select the pulse count setting menu, type **2** in the numeric keypad on the front panel, and then select confirm from the pop-up menu.

**Set rising edge:** Enter the pulse parameter setting menu, select 1 for the current pulse, then click on the rising edge, type **30** in the numeric keypad on the front panel, and then select the unit as **ns** in the pop-up menu. Pulse 2 is the same.

**Set falling edge:** Enter the pulse parameter setting menu, select 1 for the current pulse, then click on the falling edge, type **20** in the numeric keypad on the front panel, and then select the unit as **ns** in the pop-up menu. Pulse 2 is the same.

**Set positive pulse width:** Enter the pulse parameter setting menu, select 1 for the current pulse, then click on the positive pulse width, type **10** in the numeric keypad on the front panel, and then select the unit as **us** in the pop-up menu. Pulse 2 is the same.

**Set negative pulse width:** Enter the pulse parameter setting menu, select 1 for the current pulse, then click on negative pulse width, type **20** in the numeric keypad on the front panel, and then select the unit as **us** in the pop-up menu. Pulse 2 is the same.

### 3. Open output

Select channel 1, press the **Output** button, the button light will be on, and at the same time, turn on the output switch to output a signal.

Follow the above steps to output the expected sine wave. The carrier page after setting is as follows:

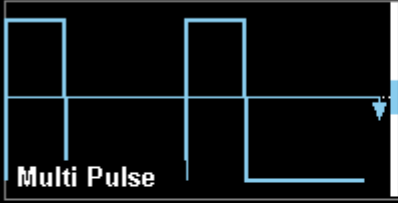
*CH1:Multi Pulse.OFF BSWV		CH2:Sine.OFF BSWV	
 <p>Multi Pulse</p>		SRate 250.000 000MSa/s Amplitude 2.000 Vpp Offset 0.000 Vdc Pulse Count <b>2</b> Pulse Index 2 Rise Edge 30.0ns Pos Width 10.000us Neg Width 20.000us	Fall Edge 20.0ns Load HiZ Output 50Ω ,OFF
SRate	Amplitude HighLevel	Offset LowLevel	Pulse Count
			MultPulse Parameter

## 10 Modulation/Sweep/Burst settings

### 10.1 Overview

Modulation / Sweep / Burst can all be seen as modulation of the carrier wave. In addition to conventional modulation, sweep frequency is a special type of frequency modulation, while burst is a type of pulse modulation.

SDG1000X Plus provides rich modulation functions, including AM, DSB-AM, FM, PM, FSK, ASK, PSK, and PWM. Different modulation parameters need to be set according to different modulation types. When amplitude modulation, the modulation frequency, modulation depth, modulation waveform, and signal source type can be set; During frequency modulation, the frequency modulation frequency, frequency deviation, modulation waveform, and signal source type can be set; During phase modulation, the modulation frequency, phase deviation, modulation waveform, and signal source type can be set; When using frequency shift keying modulation, the keying frequency, hopping frequency, and signal source type can be set; When amplitude shift keying modulation is used, the keying frequency, carrier frequency, and source type can be set; When using phase shift keying modulation, the modulation rate, polarity, and source type can be set; When pulse width modulation is used, the modulation frequency, pulse width/duty cycle deviation, modulation waveform, and signal source type can be set. Below, different modulation types will be introduced one by one, with a focus on their parameter settings.

## 10.2 Modulation

SDG1000X Plus supports commonly used analog modulation (AM/DSB-AM/FM/PM/PWM, etc.) and digital keying (ASK/FSK/PSK, etc.). The modulation source can be selected from both internal and external sources.

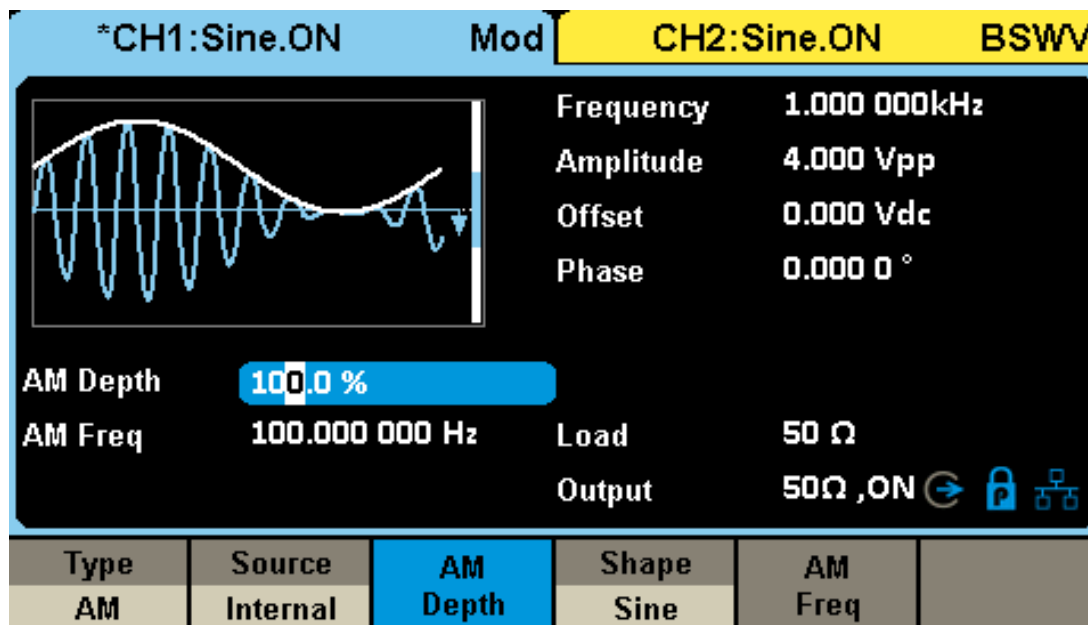

### 10.2.1 Source selection

There are a total of two sources of modulated waves: internal and external. Detailed instructions can be found in the table below:

Table 10–1 Modulation Wave Source and Description

Source	Description
Internal	The modulation signal is generated internally from the DDS module, and corresponding modulation waves are generated based on the user's configuration (modulation frequency, modulation waveform), etc.
External	<p>The modulation signal is input externally.</p> <p>When the modulation type is analog modulation (AM/DSB-SC/FM/PM/PWM, etc.), the external source is input from the external modulation interface. The amplitude of the input analog signal determines the modulation coefficient (modulation depth/frequency offset/phase offset/pulse width deviation, etc.), and the requirements for external modulation amplitude are detailed in the parameter "amplitude corresponding to 100% modulation" in the data manual. For instructions on 100% modulation, please refer to Table 10.2.</p> <p>When the modulation type is digital keying (ASK/FSK/PSK, etc.), the external source is input from the external trigger interface. The input numerical sequence must meet the electrical requirements of the external trigger interface (see data manual for details).</p>



Table 10–2 Explanation of 100% modulation

	Description
AM	Corresponding modulation depth=100%.
FM	Corresponding frequency offset=the situation where frequency offset is set. For example, if the amplitude of the external modulation input is 50% of the amplitude corresponding to 100% modulation, the resulting frequency offset is 50% of the set frequency offset.
PM	Corresponding frequency offset=setting phase offset. For example, if the amplitude of the external modulation input is 50% of the amplitude corresponding to 100% modulation, the resulting phase offset is 50% of the set phase offset.

### 10.2.2 Modulation type

The following table reflects the various modulation types supported by SDG1000X Plus and their compatibility with carriers:

Table 10–3 Compatibility Relationship between Modulation Type and Carrier

carrier modulate	Sine	Square	Pulse	Ramp	Noise	DDS	TrueArb
AM	●	●		●		●	●
DSB-AM	●	●		●		●	●
FM	●	●		●		●	
PM	●	●		●		●	
PWM			●				
FSK	●	●		●		●	
ASK	●	●		●		●	
PSK	●	●		●		●	

#### AM

AM is amplitude modulation, which is a modulation method that uses the amplitude of the modulated wave to control the amplitude of the carrier wave.

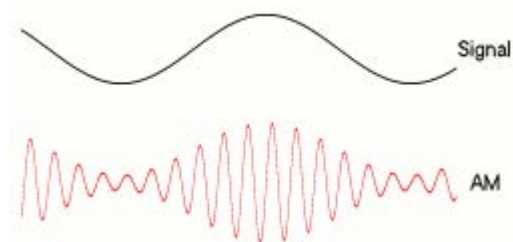

The configurable parameters of AM are shown in the table below:

Table 10-4 Explanation of AM modulation parameters

<b>AM</b>	
AM Depth	<p>Also known as amplitude modulation coefficient (m), Determined by the maximum value <math>U_{cm,max}</math> and minimum value <math>U_{cm,min}</math> of the amplitude modulation wave envelope:</p> $m = \frac{U_{cm,max} - U_{cm,min}}{U_{cm,max} + U_{cm,min}}$ <p>When the source is internal or channel, this value can be directly set; When the signal source is external, it is determined by the amplitude of the external modulation input.</p>
AM Freq	<p>The frequency of the modulated wave.</p> <p>When the source is internal, this value can be directly set; When the signal source is external, it is determined by the frequency of the external modulation input or another channel.</p>
AM Shape	<p>The shape of the modulated wave.</p> <p>When the source is internal, this value can be directly set; When the signal source is external, it is determined by the waveform of the external modulation input or another channel.</p>

The amplitude strategy of AM is to maintain the power of the carrier consistent with the unmodulated state, that is, the power of the carrier is independent of the modulation depth. This is a normal phenomenon where the peak to peak value of the AM waveform exceeds the set value. The following figure shows the amplitude comparison of a 60MHz, 0dBm carrier at no modulation and 100% modulation depth. It can be seen that after modulation is turned on, the peak to peak value in the time domain increases, but the power of the carrier in the frequency domain remains unchanged.



Unmodulated time-domain diagram

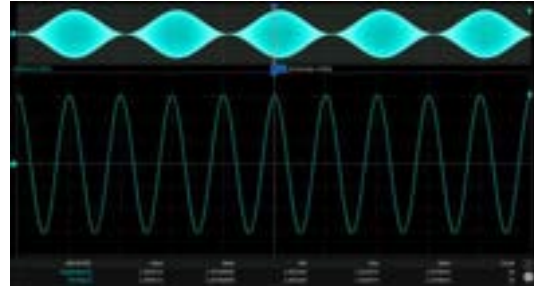

100% modulation depth time-domain diagram

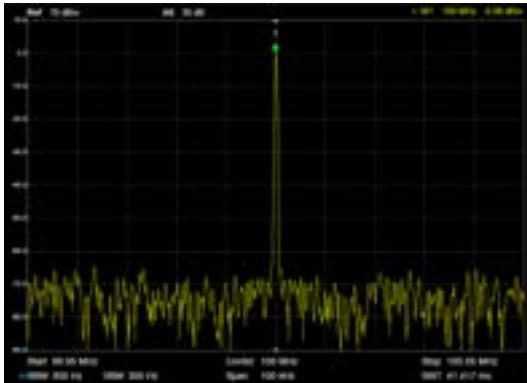

Unmodulated spectrogram

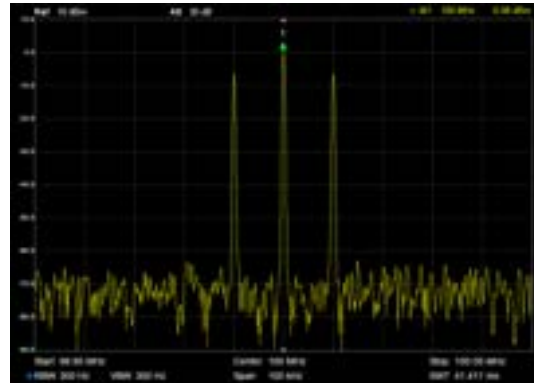

100% modulation depth spectrogram

**DSB-AM**

DSB-AM is a dual sideband amplitude modulation that suppresses the carrier wave.

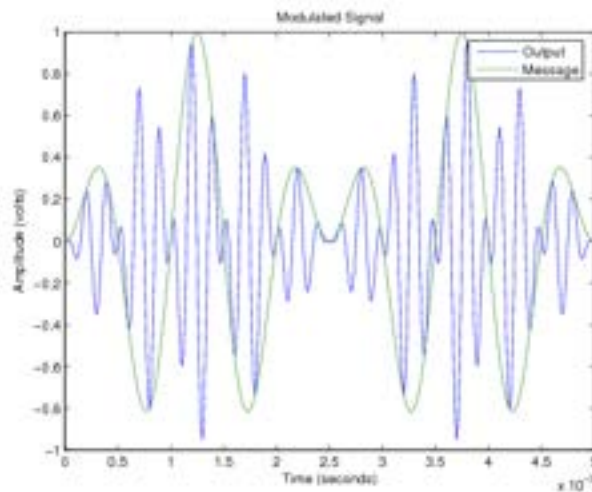

The configurable parameters of DSB-AM are shown in the table below:

Table 10–5 Description of DSB-AM modulation parameters

<b>DSB-AM</b>	
DSB Freq	Same as AM.
DSB Shape	Same as AM.

**FM**

FM is a frequency modulation method that uses the amplitude of the modulated wave to control the frequency of the carrier wave.

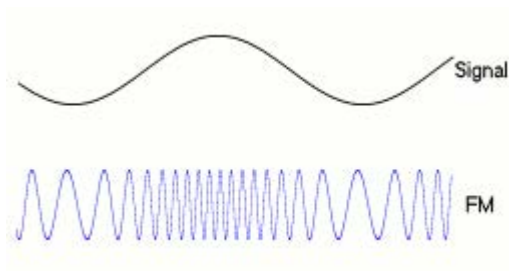

The configurable parameters of FM are shown in the table below:

Table 10–6 FM Modulation Parameter Description

<b>FM</b>	
FM Freq	Same as AM.
FM Shape	Same as AM.
FM Dev	<p>The maximum value <math>\Delta f</math> of instantaneous frequency deviation from carrier frequency <math>f_c</math>, when the frequency deviation reaches, it corresponds to the maximum or minimum amplitude of the modulated wave. The modulated carrier frequency varies within the range of <math>f_c \pm \Delta f</math>.</p> <p>When the source is internal or channel, this value can be directly set; When the signal source is external, it is determined by the amplitude of the external modulation input, and the full amplitude of the external modulation corresponds to the set frequency deviation.</p>

**PM**

PM is a phase modulation method that uses the amplitude of the modulated wave to control the instantaneous phase of the carrier wave.

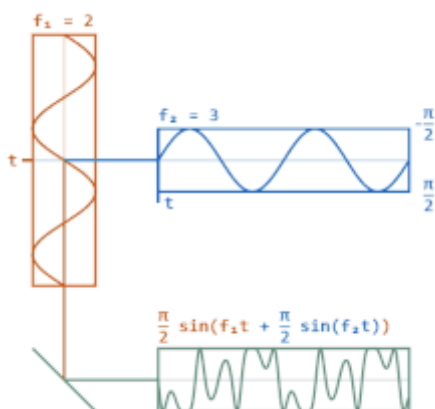

The PM's configurable parameters are shown in the table below:

Table 10–7 Description of PM modulation parameters

<b>PM</b>	
PM Freq	Same as AM.
PM Shape	Same as AM.
Phase Dev	<p>The maximum value <math>\Delta\phi</math> of the instantaneous phase <math>\phi_c(t)</math> when the instantaneous phase deviates from the carrier without modulation, when the phase deviation reaches, it corresponds to the maximum or minimum amplitude of the modulated wave. The modulated carrier phase varies within the range of <math>\phi_c(t) \pm \Delta\phi</math>.</p> <p>When the source is internal or channel, this value can be directly set; When the signal source is external, it is determined by the amplitude of the external modulation input, and the full amplitude of the external modulation corresponds to the set phase deviation.</p>

### PWM

PWM, also known as pulse width modulation, is only applicable to the case where the carrier wave equals Pulse. It refers to a modulation method that uses the amplitude of the modulated wave to control the positive pulse width of the carrier wave.

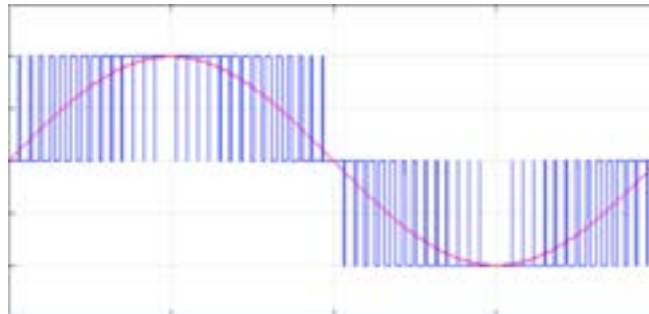

The adjustable parameters of PWM are shown in the table below:

Table 10–8 Description of PWM modulation parameters

<b>PWM</b>	
PWM Freq	Same as AM.
PWM Shape	Same as AM.
Width Dev	<p>The deviation of positive pulse width from the maximum value of positive pulse width without modulation, and when the deviation of pulse width reaches, it corresponds to the maximum or minimum value of modulation wave amplitude.</p> <p>When the source is internal or channel, this value can be directly set; When the signal source is external, it is determined by the amplitude of the external modulation input, and the full amplitude of the external modulation corresponds to the set pulse width deviation.</p>

### ASK

ASK stands for amplitude keying, specifically referring to binary amplitude keying. The amplitude of the modulated carrier varies with the 1/0 state of the binary sequence, that is, the presence or absence of the carrier amplitude is used to represent 1 or 0.

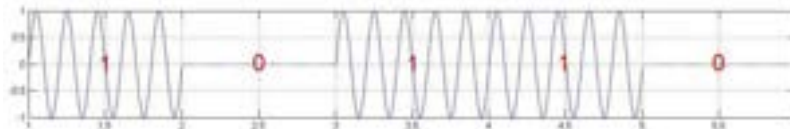

The configurable parameters of ASK are shown in the table below:

Table 10–9 ASK parameter description

ASK	
Key Freq	The bit rate of a binary sequence. When the signal source is internal, this value can be directly set, and the internal source is a clock sequence with a specified frequency; When the signal source is external, it is determined by the 0/1 state of the external trigger port input.

### FSK

FSK stands for frequency keying, specifically referring to binary frequency keying. The amplitude of the modulated carrier varies with the 1/0 state of the binary sequence, that is, when the carrier frequency is, it represents transmission 0, and when the carrier frequency is, it represents transmission 1.



The configurable parameters of FSK are shown in the table below:

Table 10–10 FSK parameter description

FSK	
Key Freq	Same as ASK.
Hop Freq	Represents the frequency of 1, i.e. $f_1$ . The frequency representing 0 (i.e. $f_0$ ) is the currently set carrier frequency

### PSK

PSK stands for phase keying, specifically referring to binary phase keying. The instantaneous phase of the modulated carrier varies with the 1/0 state of the binary sequence.

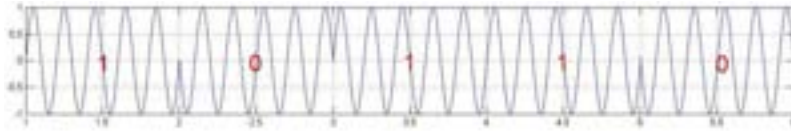

The configurable parameters of PSK are shown in the table below:

Table 10–11 PSK parameter description

PSK	
PSK Rate	Same as ASK.
Polarity	Positive/Negative. When in positive phase, the phase is $0^\circ$ when changing from 0 to 1; When changing from 1 to 0, the phase is $180^\circ$ ; When reversed, it is opposite.



Application example: Output a frequency modulation wave with an internal modulation source, and the parameters are as follows:

- Carrier waveform = Sine, Carrier Frequency = 10 MHz
- FM Shape = Triangle, FM Freq = 1 MHz, FM Dev = 10 MHz

1. Set "Mod" to "On".
2. Set "Modulation Type" to "FM".
3. Set "Source Selection" to "Internal".
4. Set the "modulation frequency" to 1 MHz.
5. Set the "frequency deviation" to 10 MHz.
6. Set "Modulation Waveform" to "Triangle".
7. Open output.

Follow the above steps to output the expected frequency modulation waveform. The modulation parameter page after setting is as follows:

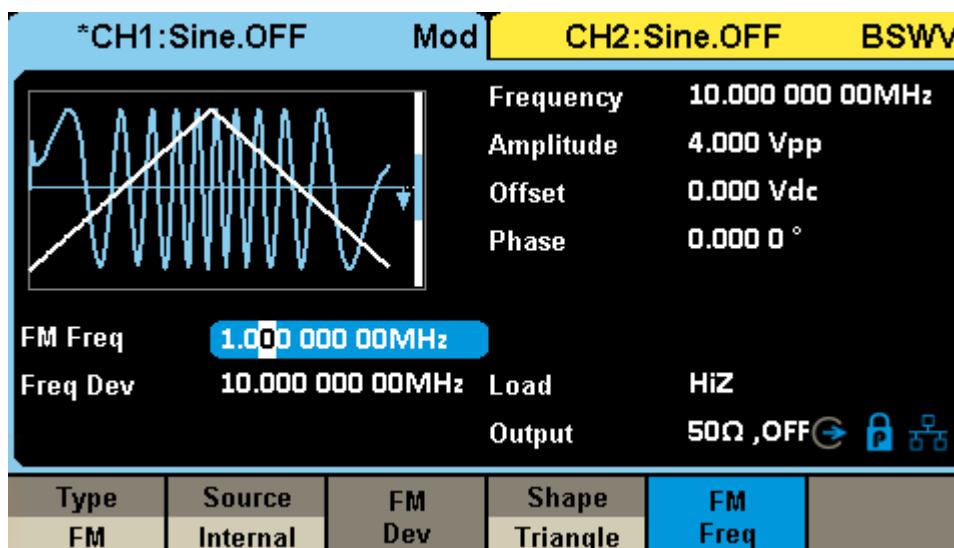

Application example: Output an amplitude modulation wave with an external modulation source, and the parameters are as follows:

- Carrier waveform = Sine, Carrier Frequency = 20 kHz
- AM Shape = Sine, AM Freq = 1 kHz, AM depth = 50%

1. Set the "waveform" of the carrier wave to Sine and the "frequency" to 20 kHz on the parameter settings page of the carrier wave.
2. Enter the interface for modulation/scanning/pulse train settings and set "Mod" to "On".
3. Set "Modulation Type" to "AM".
4. Set "Source Selection" to "External", set the waveform of the external input modulation signal to Sine, and the frequency to 1 kHz. According to the data manual, when the external input amplitude is  $\pm 5V$  pk-pk, it corresponds to 100% modulation, Therefore, setting the amplitude of the external modulation signal to  $\pm 2.5V$  pk-pk can obtain 50% modulation depth. External modulation signals can be provided by another signal source or by another channel of this device.
5. Open output

Follow the above steps to output the expected frequency modulation waveform. The modulation parameter page after setting is as follows. Note that since the frequency, shape, and depth of the modulation wave at this time are entirely determined by the external modulation input signal, the relevant parameters are no longer displayed on the settings page.



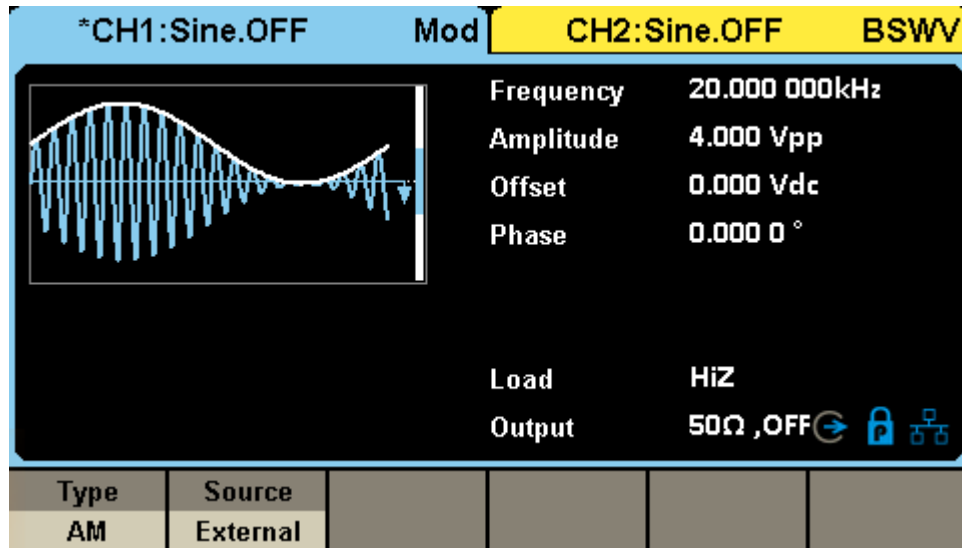

## 10.3 Sweep

Sweep belongs to special frequency modulation (FM) or amplitude modulation (AM). When the frequency sweep is turned on, the carrier output frequency or amplitude can vary according to the set pattern (linear/logarithmic) and can be controlled by the trigger signal.

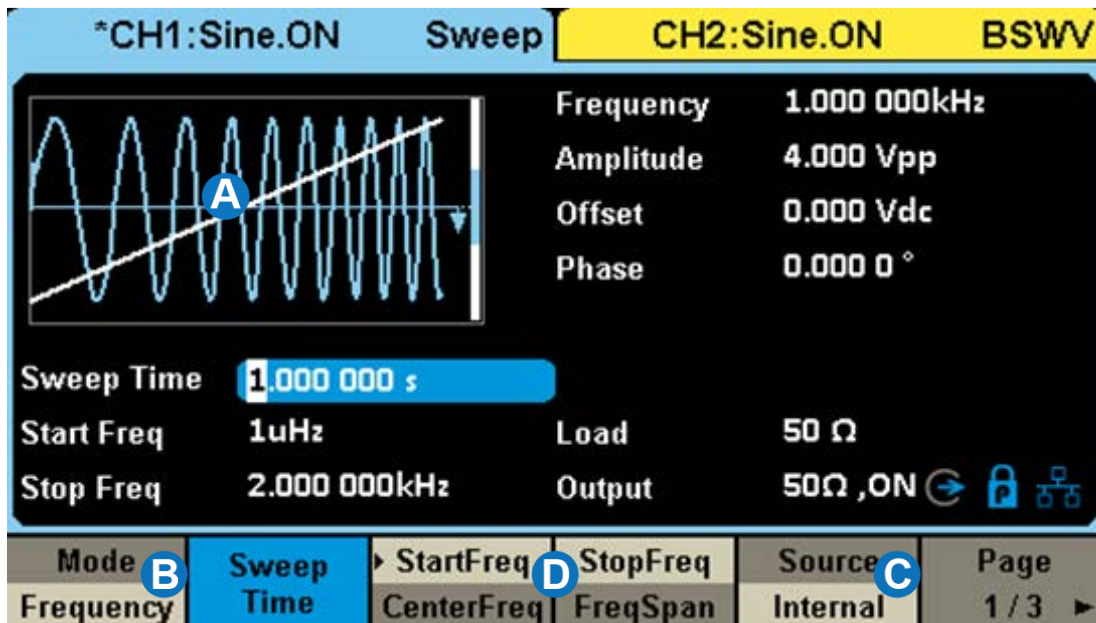

- A. Waveform preview image
- B. Sweep mode setting box
- C. Trigger Source Setting Box
- D. Sweep parameter settings box

### 10.3.1 Sweep type

The sweep types are divided into frequency sweep and amplitude sweep, and detailed explanations are shown in the table below:

Table 10–12 Type of Sweep

Sweep type	Description
Frequency	A special frequency modulation (FM).
Amplitude	A special amplitude modulation (AM).

### 10.3.2 Sweep mode

The sweep mode can be divided into two types: linear and logarithmic, as detailed in the table below:

Table 10–13 Sweep Mode

Sweep mode	Description
Linear	FM/AM with sawtooth modulation wave. Its frequency/amplitude changes linearly from the starting frequency/amplitude to the ending frequency/amplitude during the scanning cycle.
log	The frequency variation follows a $10^x$ rule and is commonly used for frequency response testing in some channels. The frequency response is generally plotted in logarithmic coordinates (10 octaves), so in order to see a uniform distribution of samples on the logarithmic coordinate plot, logarithmic scanning (only supports frequency scanning) is needed.

### 10.3.3 Trigger Source

There are three types of trigger sources used for scanning: internal, external, and manual. Please refer to the table below for detailed instructions:

Table 10–14 Trigger Sources for Sweep

Trigger Source	Description
Internal	Controlled by an internal timer for frequency sweep loop output.
External	The signal generator receives the trigger signal input from the rear panel of the instrument, and outputs a frequency sweep every time it receives a rising edge of a CMOS pulse. After the frequency sweep is completed, the carrier frequency will return to the starting frequency and remain unchanged until the next trigger arrives.
Manual	When manually triggered, a <b>trigger</b> button will appear on the parameter page. Press this button once to output a frequency sweep. After the frequency sweep is completed, the carrier frequency will return to the starting frequency and remain unchanged until the next trigger arrives

### 10.3.4 Sweep parameter settings

The sweep parameters and their detailed explanations are shown in the table below:

Table 10–15 Sweep Parameters and Explanation

Sweep parameters	Description
Sweep Time	The time spent on a single frequency sweep.
StartFreq/CenterFreq	Sweep frequency parameters. The relationship is as follows:

StopFreq/FreqSpan	CenterFreq = (StartFreq + StopFreq) / 2 FreqSpan =   StopFreq - StartFreq   (The same applies to amplitude parameters during amplitude sweep)
Direction	There are three modes: up, down, and up and down. Up represents scanning frequency from low to high; Downward represents scanning frequency from high to low; The up and down mode is only applicable to linear scanning, which scans from the starting frequency to the ending frequency within the scanning time, and then scans back to the starting frequency. This method is equivalent to using a triangular wave for frequency modulation, and the symmetry of the triangular wave can be set, corresponding to different up scanning times and down scanning times. (The same applies to amplitude parameters during amplitude sweep)
Trig Out	When the trigger source is internal or manual, the trigger output interface on the rear panel can output a trigger signal, and the rising edge of the trigger signal corresponds to the start of scanning.



Application example: Output a sweep frequency sine wave in linear and logarithmic patterns, with the following parameters:

- Direction = up, StartFreq = 100 Hz, StopFreq = 100 kHz
- Sweep Time = 3 ms
- Source = Internal, Trigger output on

1. Set the "waveform" of the carrier wave to "Sine" on the parameter settings page of CH1 carrier wave;
2. Enter the interface for frequency sweep settings;
3. Set "Scan Type" to "Linear";
4. Set "Trigger Source" to "Internal";
5. Set the "sweep time" to 3 ms and the "sweep direction" to "upward";
6. Set the "starting frequency" to 100 Hz and the ending frequency to 100 kHz;
7. Turn on trigger output. Using the characteristic of triggering the rising edge of the output to synchronize with the starting frequency, use it to trigger an oscilloscope to observe a stable sweep signal;
8. Open the output of CH1 and observe the results;
9. Change the "scan type" to "logarithmic" and observe the results.

By following the above steps, the expected sweep frequency signal can be output. After setting, the linear sweep parameter page is as follows. The parameters for logarithmic sweep frequency only differ at the "sweep type".

The result of frequency sweep output is as follows (the red trace in the figure represents the sweep signal, and the blue trace represents the trigger signal):

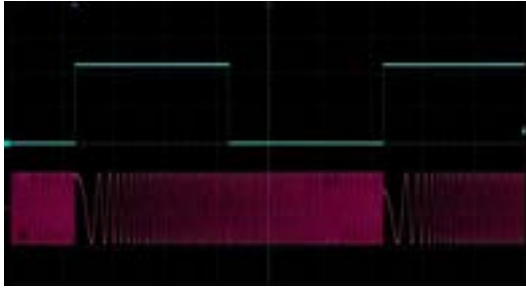

Linear sweep result

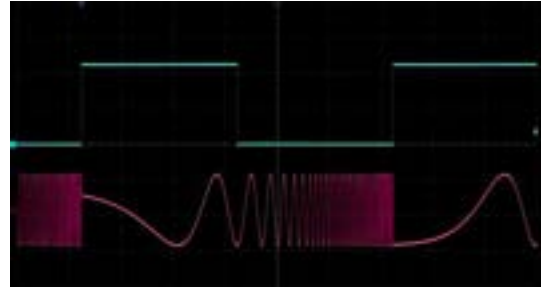

Logarithmic sweep result

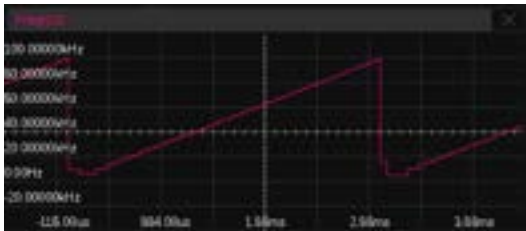

Linear sweep frequency vs time

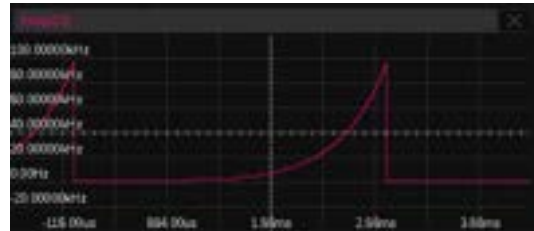

Logarithmic sweep frequency vs time

This example can help users gain a deeper understanding of the difference between linear scanning and logarithmic scanning: scanning from 100 Hz to 100 kHz, with a scanning time of 3 ms, the frequency increases by  $10^3$  times, and logarithmic scanning increases by 10 times every 1 ms. The table below lists the frequency values corresponding to each time point in logarithmic and linear sweep modes.

Time (ms)	0	1	2	3
Frequency (Hz) -- Logarithmic sweep frequency	100	1000	10000	100000
Frequency (Hz) -- Linear sweep frequency	100	33400	66700	100000

## 10.4 Burst

Burst is a burst signal. Triggering the output of a certain number of carrier cycles through a certain control signal.

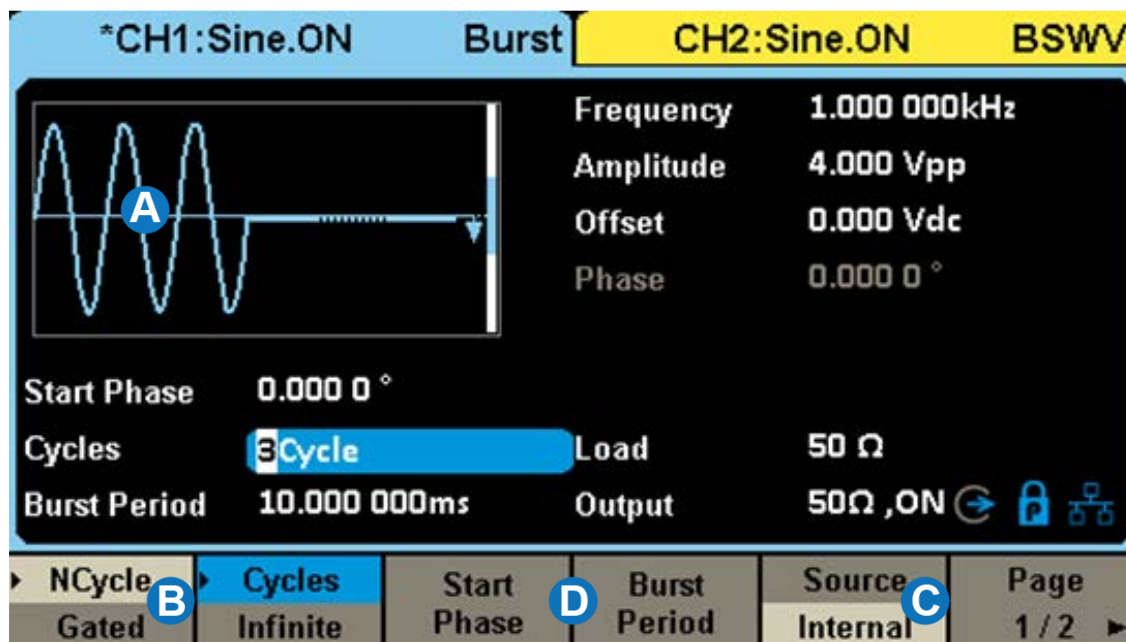

- A. Waveform preview image
- B. Burst type setting box
- C. Trigger Source Setting Box
- D. Burst parameter setting box

### 10.4.1 Burst type

Burst types are divided into N-loop and gate control, and detailed explanations are shown in the table below:

Table 10–16 Types of Burst

Burst type	Description
NCycle	Each time triggered, output a specified number (N) of carrier cycles.
Gated	When the gate signal is valid, the carrier is output; otherwise, it is not output. The gate signal can be high or low effective.

## 10.4.2 Trigger Source

Burst uses three types of trigger sources: internal, external, and manual, similar to frequency scanning. Detailed instructions can be found in the table below:

Table 10–17 Burst Trigger Sources

Trigger Source	Description
Internal	Controlled by an internal timer for pulse train loop output.
External	The signal generator receives trigger signals/gate control signals input from the instrument's rear panel. As a trigger signal, every time a CMOS pulse rising edge is received, a pulse train is output. When used as a gate control signal, the output of the carrier signal is determined by judging the height of the signal.
Manual	When manually triggered, a <b>trigger</b> button will appear in the parameter setting area, which outputs a pulse train every time it is pressed.

## 10.4.3 Burst parameter settings

The Burst parameter and its detailed description are shown in the table below:

Table 10–18 Burst parameters and explanations

Burst parameter	Description
Start Phase	Initial phase when starting to output pulse train.
Burst Period	This parameter is only available when the trigger source is internal and is used to set the cycle period of the internal timer.
Cycles	This parameter is only available when Burst type=N cycles, and is used to specify the number of cycles contained in each pulse string. Click on the parameter name area in the parameter settings box to set the number of cycles to "infinite", which means that continuous carriers will be output continuously after receiving the trigger, used to control the carrier to output after a specific event occurs.
Polarity	This parameter is only available when Burst type=gating, used to specify the polarity of the gating signal. When polarity is positive, only when the gate is highly effective can the carrier signal be output; When polarity is negative, the carrier signal is output only when the gate is low and effective.
Trig Delay	This parameter is only available when the trigger source is internal or manual, and is used to set the delay time of the trigger signal. The minimum value of trigger delay represents the minimum delay that can be achieved on hardware.
Trig Out	This parameter is only available when triggering source=internal or manual, and can be set to rising edge alignment, falling edge alignment, or off.
Edge	This parameter is only available when the trigger source is external and is used to specify the rising or falling edge of the response trigger signal.



Application example: Using a 10 kHz sine wave as the carrier, output a pulse train every 10 ms, with each pulse train containing 5 cycles.

1. Set the "waveform" of the carrier wave to "Sine" and the "frequency" to 10 kHz on the parameter settings page of the carrier wave.
2. Enter the interface for pulse train settings.
3. Set "Burst Type" to "N-loop".
4. Set "Trigger Source" to "Internal".
5. Set the Burst cycle to 10 ms.
6. Set the number of loops to 5.
7. Turn on trigger output. Using the characteristic of triggering the rising edge of the output to synchronize with the pulse train sequence, use it to trigger the oscilloscope to stably capture the pulse train signal.
8. Open channel output and observe the results.

By following the above steps, the expected pulse train signal can be output. The parameter page for the pulse train after setting is as follows.

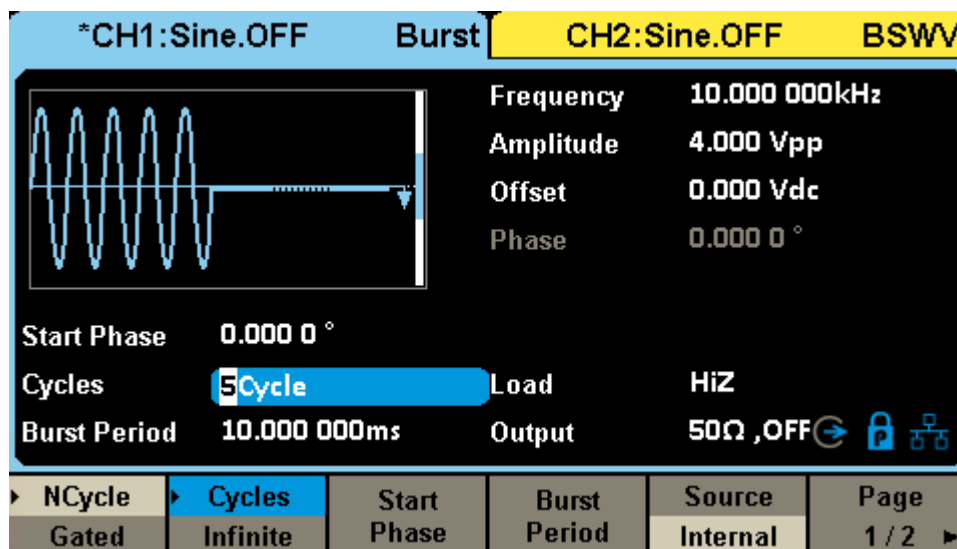

Application example: Manual triggering, outputting 3 pulse trains each time with a 10 ms interval. Each pulse train contains 10 pulses, with a carrier frequency of 10 kHz and a pulse width of 20 us.

1. On the parameter settings page of the carrier, set the "waveform" of the carrier to "Pulse", set the "frequency" to 10 kHz, and set the "pulse width" to 20 us;
2. Enter the interface for pulse train settings;
3. Set "Burst Type" to "N-loop";



4. Set "Trigger Source" to "Manual";
5. Set the Burst cycle to 10 ms;
6. Set the "number of cycles" to 10;
7. Set the number of pulse trains to 3;
8. Turn on trigger output. By utilizing the characteristic of synchronizing the rising edge of the trigger output with the pulse train sequence, it can be used as a trigger signal to capture the pulse train;
9. Open channel output;
10. Click the **trigger** button in the 2/2 menu of the current page, and use the trigger output signal on the oscilloscope to trigger for a single capture.

By following the above steps, the expected pulse train signal can be output. The parameter page for the pulse train after setting is as follows.

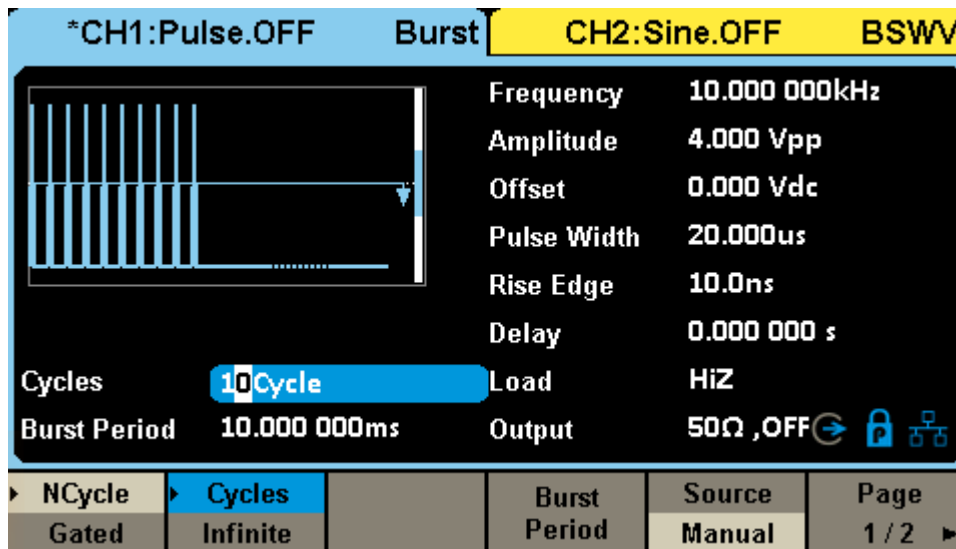

## 11 Store/Recall

SDG1000X Plus supports storing and calling settings files, waveform files, and firmware upgrade files. The storage and retrieval locations include internal storage (Local) or external USB storage devices (such as USB drives). The storage and invocation operations are implemented through a file manager, as shown in the following figure:

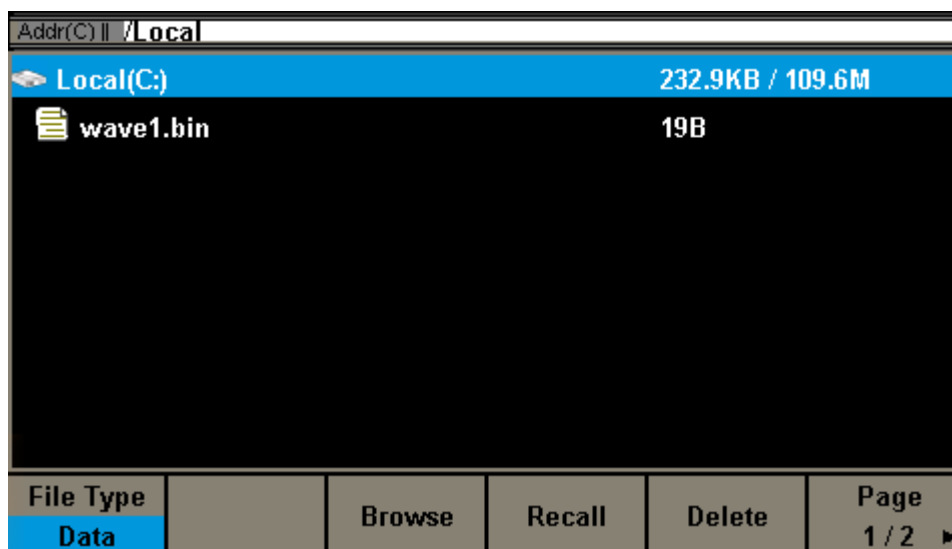

### 11.1.1 Storage

SDG1000X Plus supports storing the current state of the instrument in internal or external memory, and supports users to call it when needed. Users can download any wave file to internal storage through any wave editing software EasyWaveX, or read any wave file from a USB drive and save it to internal storage. SDG1000X Plus provides an internal non-volatile memory and an external memory interface.

#### Local(C:)

SDG1000X Plus provides internal non-volatile memory, allowing users to save instrument status and any wave files to the C drive.

#### USB Device(0:)

The SDG1000X Plus comes standard with a USB Host located on the left side of the instrument front panel, supporting USB storage and firmware upgrades. When inserting a USB host interface into a mobile medium such as a USB drive, the file management interface will display the "USB Device (0:)" drive letter and prompt "USB device connected". When the USB drive is removed from the USB host interface, the system will prompt "USB device disconnected." and the corresponding drive letter will disappear.

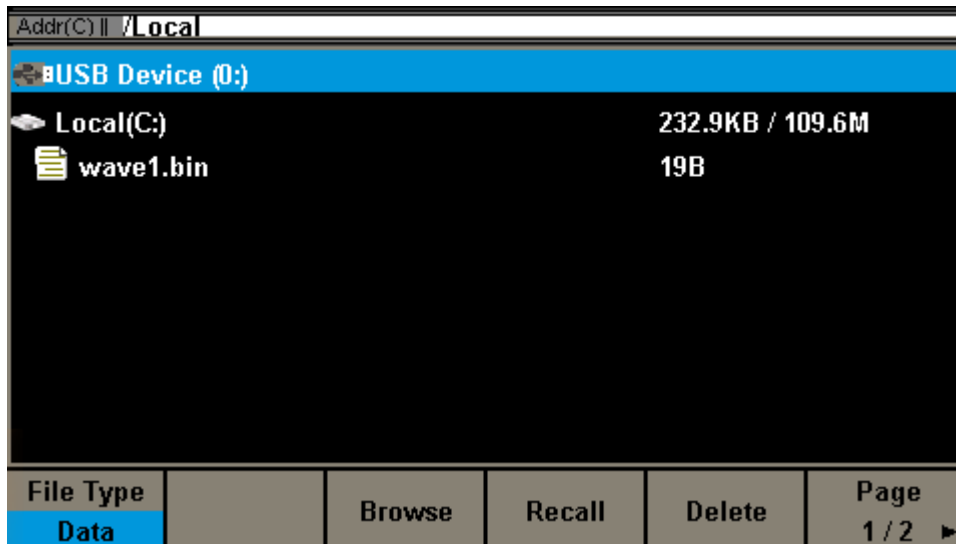
**Attention:**

SDG1000X Plus can only recognize files with English characters, numbers, and underscores. If you use other special characters to name files or folders, it may not display properly in the file management interface.

**Browse**

- You can use the knob to switch between Local (C:) and USB Device (0:), or directly click on the corresponding position on the screen to select, select browse, press the knob, or click on the selected folder to expand the current storage directory.
- Use the knob to switch files or folders in the current directory. Select browse, press the knob or click on the selected folder to expand the subdirectories of the current directory. Select<up>in the subdirectories and choose browse or press the knob to return to the previous level of directory.

**11.1.2 File type****State file**

Store the working status of the instrument in \*. XML format in internal memory. The stored status file includes: waveform parameters selected for two channels, modulation, frequency sweep, pulse train parameters used, auxiliary function parameters and system parameters under the Utility menu, etc.

**Data file**

SDG1000X Plus supports reading data files in \*. csv and \*. dat formats from external memory, converting them into \*. bin format and storing them in internal memory. After reading, the instrument automatically enters the arbitrary wave function interface.

Users can also edit any waveform through the upper computer software EasyWaveX, download it to

the instrument through a remote interface, and store it in \*.bin format in internal memory.

### 11.1.3 File operation

#### 1. Save

Users can store the instrument status in both the internal non-volatile memory and external memory for easy retrieval next time. The specific operations for storing instrument status are as follows:

##### Select the required storage file type

Select Store/Recall → File Type, and select the file storage type as Status File.

##### Select storage file location

Use a knob or directly click on the corresponding position on the touch screen to select the location you want to store.

##### Save the File

Select Save and the system will enter the file name input interface.

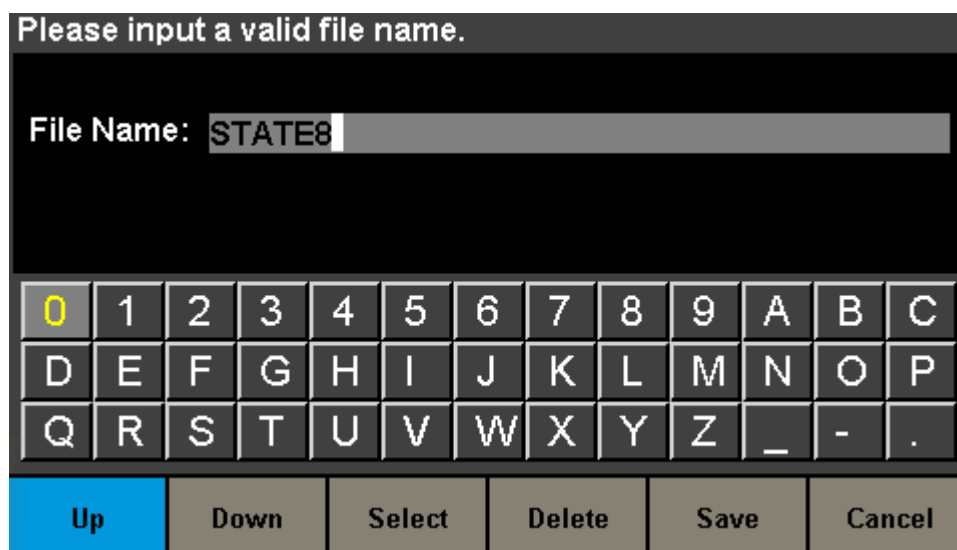

##### File name input

SDG1000X Plus can name files in English.

##### Character selection

Users can select the desired character in the UI up and down using the knob and menu soft keys, and then confirm by selecting the menu item. The selected character will be displayed in the file name input area.

##### Delete

To delete any character in a file name, you can first use the left and right arrow keys to move the cursor position in the file name, and then select Delete from the operation menu to delete the corresponding character. Change the position of the cursor to delete characters at any position.

### **save the file**

After completing the file name input in the file name input interface, select save, and the signal generator will save the file to the currently selected directory with the specified file name and file type.

## **2. Recall**

Users can call up the instrument status or any waveform data edited by the user. The specific operation is as follows:

### **Select the desired type of read file**

Select Store/Recall → File Type, select the file read type as Status or Data File.

### **Select the status/data file to read**

Use the knob to select the directory where the file to be read is located, select browse, or press the knob to expand the current directory. Use the knob again or directly click on the corresponding position on the touch screen to select the file you want to read.

### **Read the file**

Choosing to read, pressing the knob down, or simply clicking on the file on the screen will bring up the corresponding file and provide a prompt message after successful reading.

## **3. Delete**

Users can delete status and data files from both internal and external storage. The specific operation is as follows:

### **Select the files that need to be deleted**

Use a knob or directly click on the corresponding position on the touch screen to select the file you want to delete.

### **Delete the file**

Select delete and a prompt box will pop up asking "Are you sure you want to delete this file?" Select OK to delete the currently selected file.

## **4. Copy/Paste**

SDG1000X Plus supports copying files from internal and external storage to each other. For example, copying any wave file from a USB flash drive to the interior of the instrument, the specific operation is as follows:

**Select file type as data**

Select Store/Recall → File Type, and select the file read type as Data File.

**Select the file to be copied**

Rotate the knob to select USB Device (0:), press browse or press the knob to expand the USB drive directory, select the file you want to copy with the knob, and press 1/2 of the current page → copy.

**Paste this file**

Rotate the knob to select Local (C:), press browse or press the knob to expand the internal storage directory, and select paste.

## 12 Accessibility settings

The auxiliary functions (Utility) of SDG1000X Plus can select and set functions such as synchronization signal output, channel copying, system settings, detection/calibration, and frequency meter.

<b>System</b>	Test/Cal	Counter	Output Setup	CH Copy Coupling	Page 1 / 3 ▶
<b>Interface</b>	Sync	Clock	Phase Mode	OverVoltage Protection	Page 2 / 3 ▶
<b>Multi-Device Sync</b>					Page 3 / 3 ▶

### 12.1 System settings

Number Format	Language English	PowerOn Setting	<b>Set To Default</b>	Beeper On	Page 1 / 3 ▶
ScrnSvr Off	System Info	Firmware Update	Help	UI Style Classical	Page 2 / 3 ▶
<b>Open source knowledgme</b>					Page 3 / 3 ▶

#### 12.1.1 Set Number Format

Execute **Utility** > **System** > **Number Format** , select the decimal point and separator in the pop-up list.

#### 12.1.2 Set language

The operation interface of SDG1000X Plus supports Simplified Chinese and English.

Execute **Utility** > **System** > **Language** , Select the language in the pop-up list.

#### 12.1.3 Power on settings

You can set the power on status to last time, default, and custom. Customization requires calling the status file.

Execute **Utility** > **System** > **PowerOn Setting** , Set the power on mode.

### 12.1.4 Set To Default

The status of the instrument can be configured to factory settings.

Execute **Utility** > **System** > **Set To Default** , Click on it.

### 12.1.5 Set beeper

Execute **Utility** > **System** > **Beeper** , Set to turn on/off.

### 12.1.6 Set up screen saver

After the device enters an idle state and remains idle for a certain period of time, the screensaver program will be enabled. The screensaver program will turn off the backlight of the display screen after the specified time to save power consumption.

Execute **Utility** > **System** > **ScrnSvr** , Idle time can be specified. The available screen saver idle times are: 1 minute, 5 minutes, 15 minutes, 30 minutes, and 1 hour. You can also choose "close" to disable the screen saver.

After the screen saver takes effect, touching the screen, pressing buttons, turning the knob, or moving the mouse can all cause the device to exit the screen saver program.

### 12.1.7 View system information

Execute **Utility** > **System** > **System Info** , You can view the current version information of the device. The system information includes the content shown in the following figure:





### 12.1.8 Set up firmware upgrade

Execute **Utility** > **System** > **Firmware Update** , Select the ADS firmware that needs to be upgraded and load it.

### 12.1.9 Help

Execute **Utility** > **System** > **Help** , You can view help information for the device.

### 12.1.10 UI Style

Execute **Utility** > **System** > **UI Style** , Just set Classic/General.

### 12.1.11 Open Source Description

Execute **Utility** > **System** > **Open source knowledge** , You can view the open source information of the device.

## 12.2 Testing/Calibration

SDG1000X Plus provides self-test functions, including screen testing, button testing, lighting testing, and board level testing.

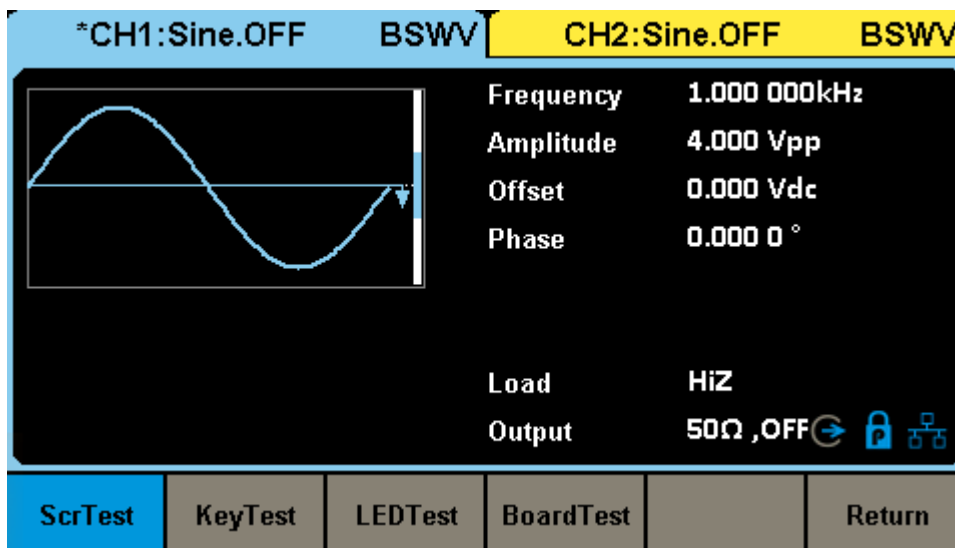

### Screen test

Screen testing is mainly used to discover whether there are serious color deviation, defects, or screen scratches in the device display. Execute **Utility** > **Test/Cal** > **SelfTest** > **ScrTest**. The device enters the screen test interface as shown below, which displays pure red.

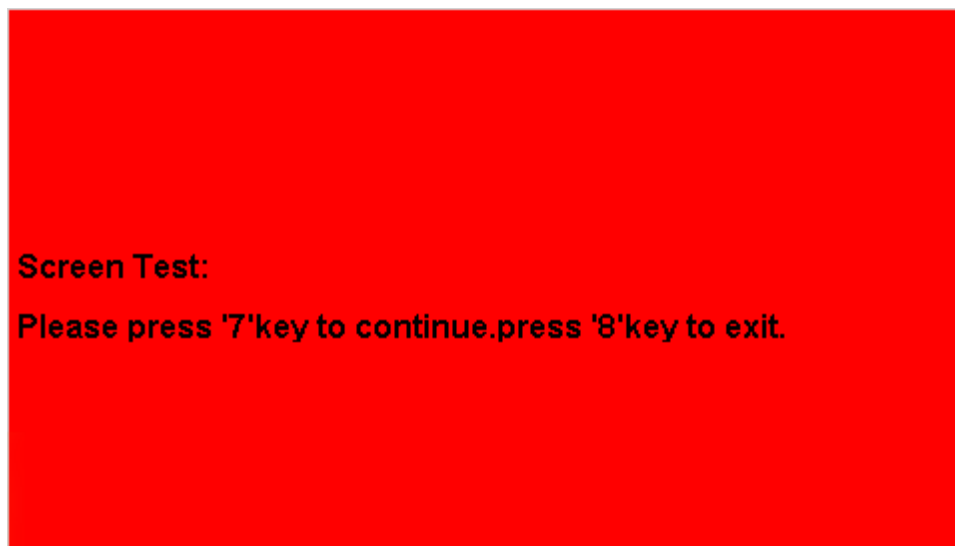

Press the on-screen prompts for **7** consecutive keys to switch to green and blue screen display modes. Observe the screen for serious color differences, stains, or scratches on the interface corresponding to each color.

You can repeatedly press the **7** keys to switch between different color test interfaces until the final confirmation. Then press the **8** key to exit the screen test mode.

### Key test

Key testing is mainly used to detect issues such as unresponsive or insensitive buttons or knobs on the front panel of the device. Execute **Utility** > **Test/Cal** > **SelfTest** > **KeyTest** . The device enters the following interface:

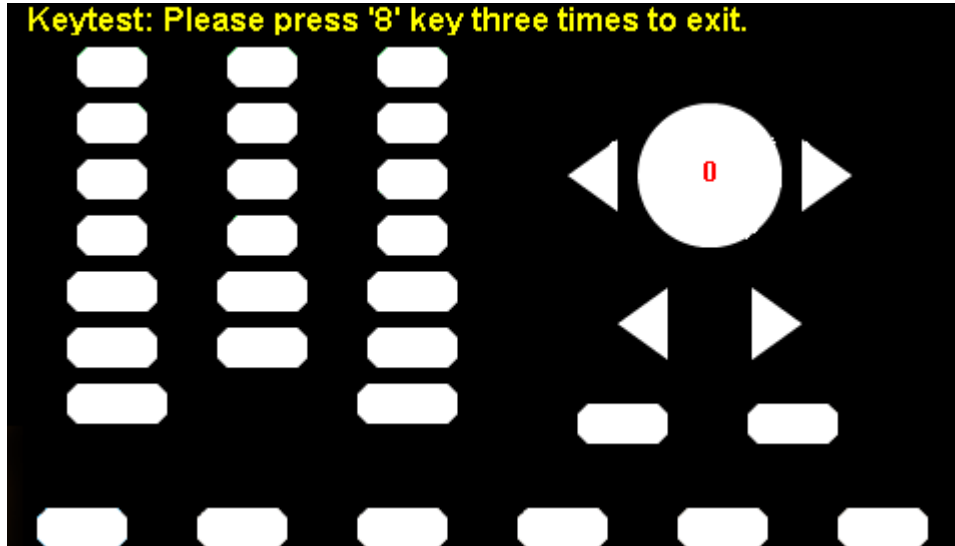

As shown in the above figure, perform knob and button tests.

**Knob Test** - Rotate each knob to the left or right in order from top to bottom and from left to right, and press it to observe whether the corresponding value on the display interface (default to 0) increases in real time, and whether the knob lights up after being pressed.

**Key Test** - Press each button in order from top to bottom, left to right, and observe whether the corresponding buttons on the display interface light up in real time.

After testing all knobs and buttons, follow the on-screen prompts and press the **8** keys three times in a row to exit the button testing mode.

### LED test

LED testing is mainly used to discover whether the button lights on the front panel of the device can light up and whether the brightness is poor. Execute **Utility** > **Test/Cal** > **SelfTest** >

**LEDTest** . The device enters the following interface:

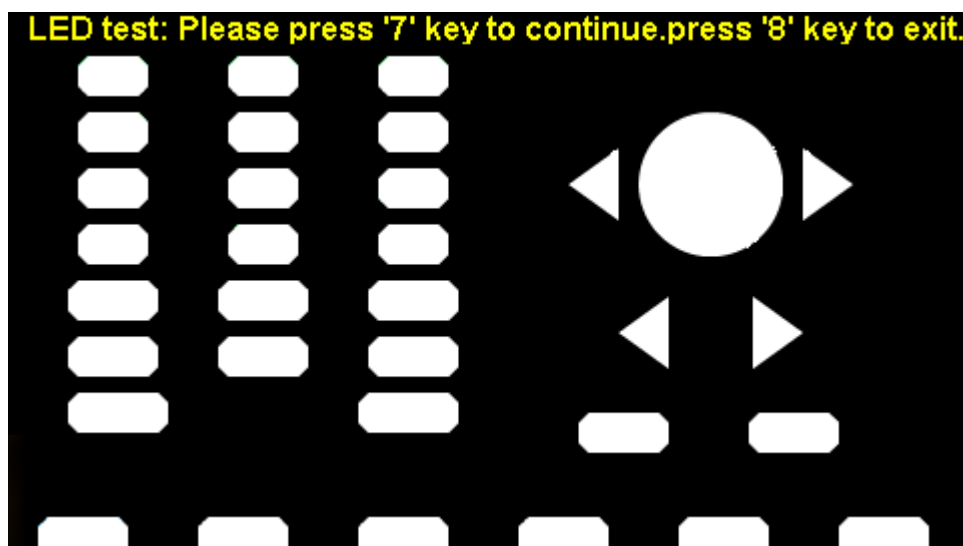

As shown in the above figure, after pressing the **[7]** keys according to the screen prompts, the first LED on the front panel will be lit, and the corresponding position of the key on the screen will light up. Continue to press key **[7]** to switch to the next button light. Press the **[7]** keys continuously according to this method until all button lights are tested, and observe whether all button lights on the front panel can be lit up in real time.

After testing all the button lights, press the **[8]** keys according to the screen prompts to exit the testing mode.

### Board test

Board level testing mainly performs self checks on some key chips of the equipment. When the equipment fails, this can be executed to confirm whether it is caused by hardware failure. Execute **Utility** > **Test/Cal** > **SelfTest** > **BoardTest** . The device enters the interface shown below. If all devices prompt "Pass", it indicates that the critical chip is working properly. Otherwise, maintenance is needed to restore the device to normal.

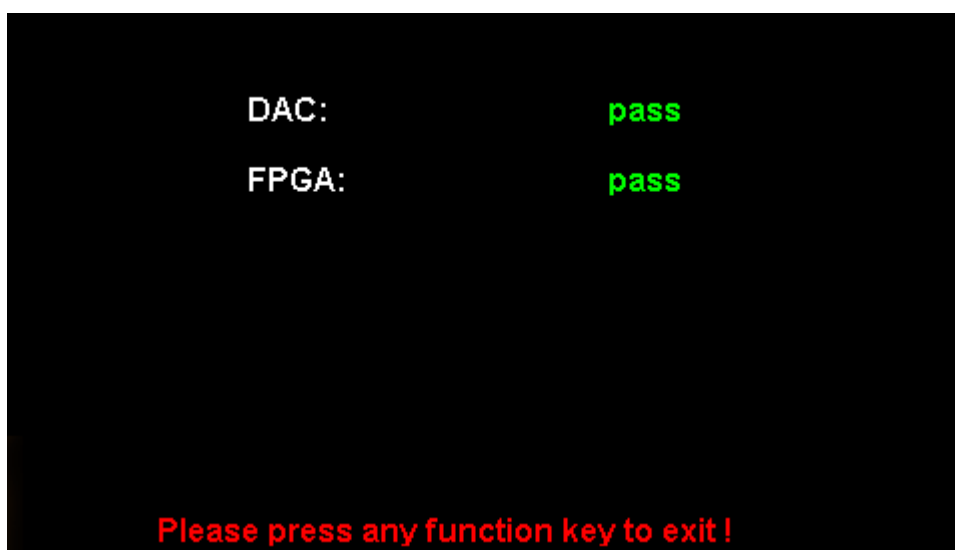

## 12.3 Counter

The SDG1000X Plus is equipped with a high-precision, broadband frequency meter that can measure input signals from 100mHz to 200MHz. The dual channel output can be measured simultaneously with the frequency meter.

Counter:ON				
	Frequency	Pwidth	Duty	Freq Dev
Value	0.000 000 0 Hz	0.000 000 s	0.0 %	0.000ppm
Mean	0.000 000 0 Hz	0.000 000 s	0.0 %	0.000ppm
Min	0.000 000 0 Hz	0.000 000 s	0.0 %	0.000ppm
Max	0.000 000 0 Hz	0.000 000 s	0.0 %	0.000ppm
Sdev	0.000 000 0 Hz	0.000 000 s	0.0 %	0.000ppm
Num	0	0	0	0
Ref Freq	10.000 000 00MHz			
State	▶Frequency	▶Pwidth	▶RefFreq	Setup
On	Period	Nwidth	TrigLev	Clear

Table 12-1 Explanation of Frequency Meter Setting Menu

Function menu	setting	Description
Frequency/Period		Display the frequency or period of measurement.
PWidth/NWidth		Display the measured positive or negative pulse width.
RefFreq		Set reference frequency.
TrigLev		Set the trigger level, when the input signal reaches the specified trigger level, the system triggers and obtains the measurement reading.
Duty		Display the measured duty cycle.
Setup		Enter the frequency meter settings menu.
Clear		Clear statistical data to zero.

The frequency meter setting operation menu is as follows:

Mode	HFR	Default			Accept
AC	Off				

Table 12–2 Explanation of Frequency Meter Setting Menu

Function menu	setting	Description
HFR	On	Enable high-frequency suppression function to filter out high-frequency noise and improve measurement accuracy when measuring low-frequency signals.
	Off	Turn off high-frequency suppression function.
Mode	AC	Set to AC coupling mode.
	DC	Set to DC coupling mode.
Default		Restore default settings.
Accept		back

### Trigger level

Set the triggering level of the measurement system. When the input signal reaches the specified triggering level, the system triggers and obtains measurement readings. The default value is 0V, and the range can be set from -3V to 1.8V. Select the trigger level, use the numeric keypad to enter the desired value, and select the desired unit (V or mV) from the pop-up unit menu; Or use knobs and directional keys to change their values.

### High-frequency suppression

When measuring low-frequency signals, high-frequency suppression can be used to filter out high-frequency noise and improve measurement accuracy. Select high-frequency suppression to turn on or off the high-frequency suppression function. The default is "off".

- When measuring low-frequency signals with a frequency less than 250kHz, turn on high-frequency suppression to filter out high-frequency noise interference;
- When measuring high-frequency signals with a frequency greater than 250kHz, turn off high-frequency suppression, and the maximum measurable frequency is 200MHz.

## 12.4 output setting

In the output settings menu, corresponding parameters for load/high resistance, conventional/reverse phase, and in-phase can be set.

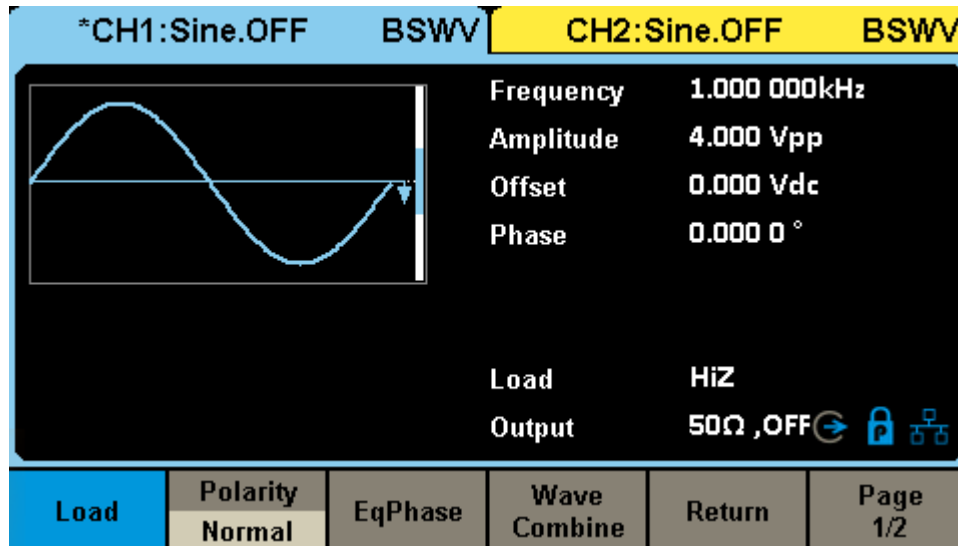

Table 12–3 Description of Output Setting Function Menu

Function menu	setting	Description
Load	50Ω	Set the load value of the Output output to 50 Ω.
	HighZ	Set the output load to high impedance.
Polarity	Normal	Set waveform regular output.
	Invert	Set waveform reverse output.
EqPhase		Make channel 1 and channel 2 have the same phase.
Wave Combine		Merge Channel 1 and Channel 2.
Amplitude		Set channel output amplitude limit.
Power-on State		Set the channel output status after startup.
Page1/2		Switch menu pages.

### 12.4.1 Load

Execute **Utility** > **Output Setup** > **Load** . Select high resistance or 50 Ω from the pop-up menu, or press and hold the corresponding Output button for 2 seconds to quickly switch between high resistance and 50 Ω.

High resistance: display HiZ;

Load: Display resistance value (default to 50  $\Omega$ , range from 50  $\Omega$  to 100k  $\Omega$ ).

The SDG1000X Plus provides a fixed series output impedance of 50  $\Omega$  internally. The setting of load value is the process by which the user informs the instrument of the external load value. The purpose of providing this option is to enable the user to match the displayed signal parameters (such as amplitude and offset) with the expected value. That is to say, if the actual impedance of the load does not match the specified impedance, there will be deviation in the displayed signal parameters (such as amplitude and offset). Therefore, it is necessary to ensure that the actual load impedance is consistent with the specified impedance.

### 12.4.2 Polarity

Execute **Utility** > **Output Setup** > **Polarity** .

Set the signal on the CH1 or CH2 connector to either regular output or reverse output.

As shown in the following figure:

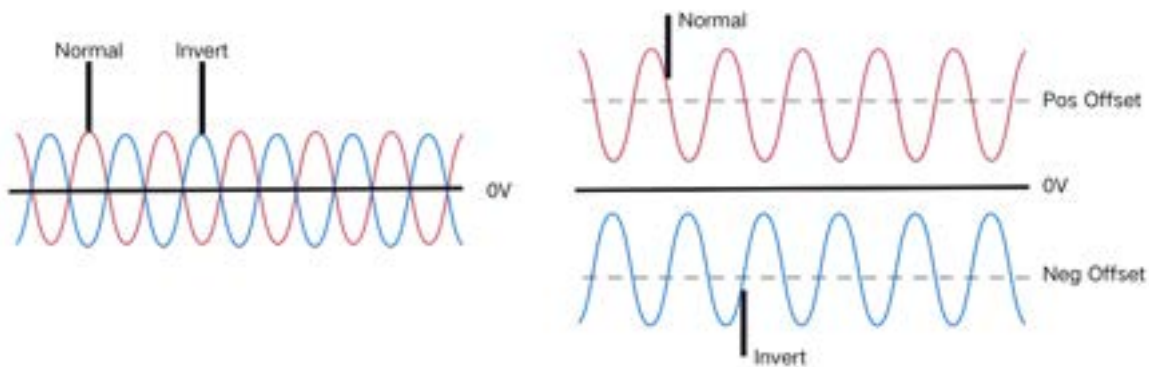

**Note:** When the waveform is reversed, the synchronization signal related to the waveform is not reversed.

### 12.4.3 EqPhase

SDG1000X Plus provides in-phase function. After selecting in-phase, the instrument will reconfigure two channels to output according to the set frequency and phase. For two signals with the same frequency or a multiple frequency relationship, phase alignment can be achieved by executing

**Utility** > **Output Setup** > **EqPhase** .

### 12.4.4 Wave Combine

The output port of channel 1 of the signal source can output the waveform of CH1 in normal mode and CH1+CH2 in merge mode; Similarly, the output port of channel 2 of the signal source can output



the waveform of CH2 in normal mode and CH1+CH2 in merge mode.

Execute **Utility** > **Output Setup** > **Wave Combine** . Enter the channel merge function interface, as shown in the following figure:

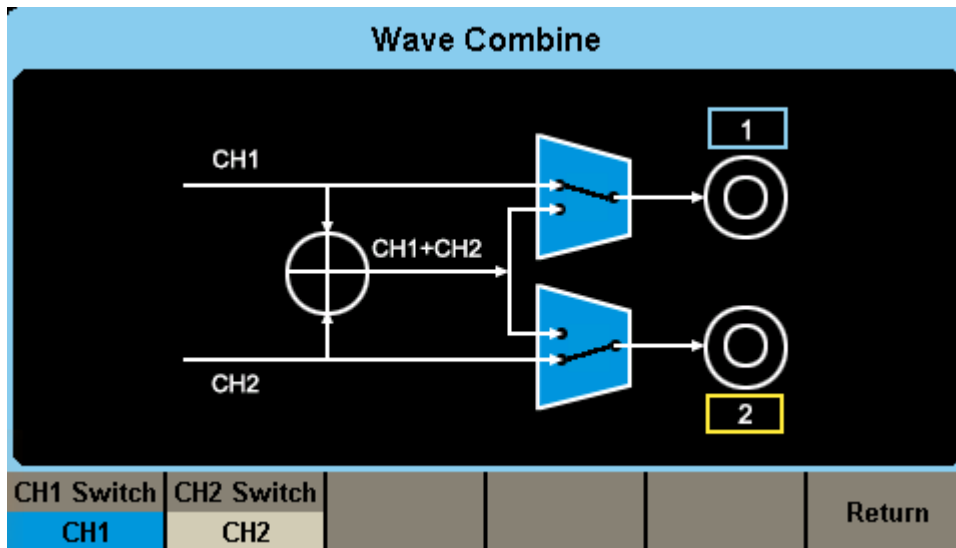

Table 12–4 Channel Merge Function Menu Description

Function menu	setting	Description
CH1 switch	CH1	CH1 outputs waveform in CH1 configuration.
	CH1+CH2	CH1 outputs waveforms in the configuration of CH1+CH2.
CH2 switch	CH2	CH2 outputs waveform in CH2 configuration.
	CH1+CH2	CH2 outputs waveforms in the configuration of CH1+CH2.
Return		Complete the current operation and return to the previous menu level.

### 12.4.5 Amplitude

In some application scenarios, users need to limit the amplitude of channel output to ensure that amplitude sensitive signal receiving devices are not damaged, Execute **Utility** > **Output Setup** > **Amplitude** , Enter the amplitude setting page and limit the maximum output amplitude. The default maximum amplitude is the maximum amplitude value that the device can provide. Effective immediately after setting on both channels.

### 12.4.6 Power on output status

In some application scenarios, users need to turn on the power channel output as soon as they turn

it on.

Execute **Utility** > *Output Setup* > *Power-on State* , This function requires setting the power on to last or custom mode.

## 12.5 Channel cope and coupling

### 12.5.1 Channel cope

SDG1000X Plus supports the function of copying the state and waveform between two channels, that is, copying all parameter settings and states of one channel to the other channel.

Execute **Utility** > **CH Copy Coupling** > **Channel Copy**, Enter the channel replication settings interface.

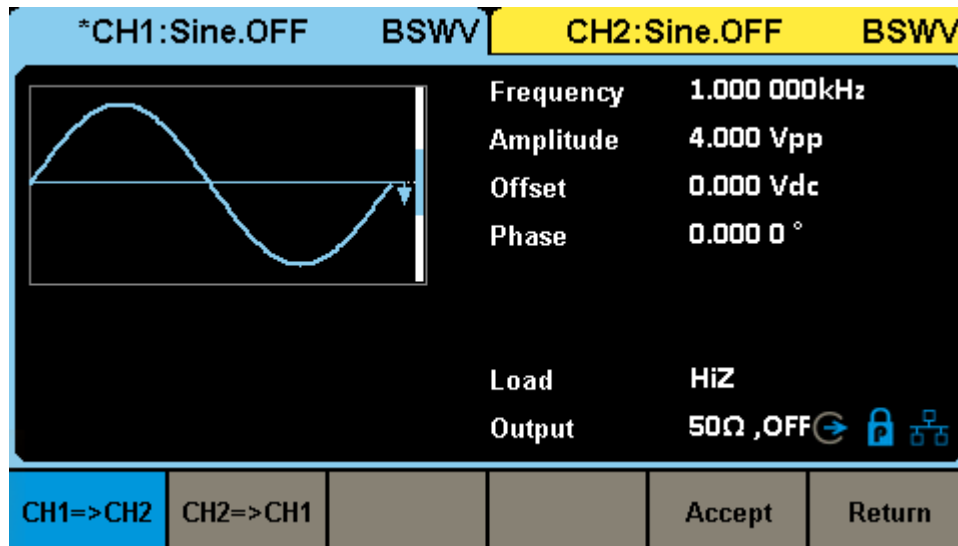

Table 12–5 Channel Copy Menu Description

Function menu	setting	Description
CH1=>CH2		Copy the parameter settings and status used in CH1 to CH2.
CH2=>CH1		Copy the parameter settings and status used by CH2 to CH1.
Accept		Complete the current operation and return to the main menu.
Return		Abandon current operation and return to the previous menu level.

**Note:** The coupling and tracking functions are mutually exclusive to the channel copying function. When the channel coupling or tracking function is turned on, the channel copying menu will not be displayed.

### 12.5.2 Channel coupling

SDG1000X Plus supports coupling of frequency, amplitude, and phase. You can set the frequency

deviation/frequency ratio, amplitude deviation/amplitude ratio, or phase deviation/phase ratio for two channels. When the coupling function is turned on, CH1 and CH2 are each other's reference sources. When the frequency, amplitude, or phase of one channel (which serves as the reference source) is changed, the frequency, amplitude, or phase of the other channel will be automatically adjusted and always maintain the specified deviation/proportion with the reference channel.

Execute **Utility** > **CH Copy Coupling** > **Channel Coupling** , Enter the channel coupling setting interface.

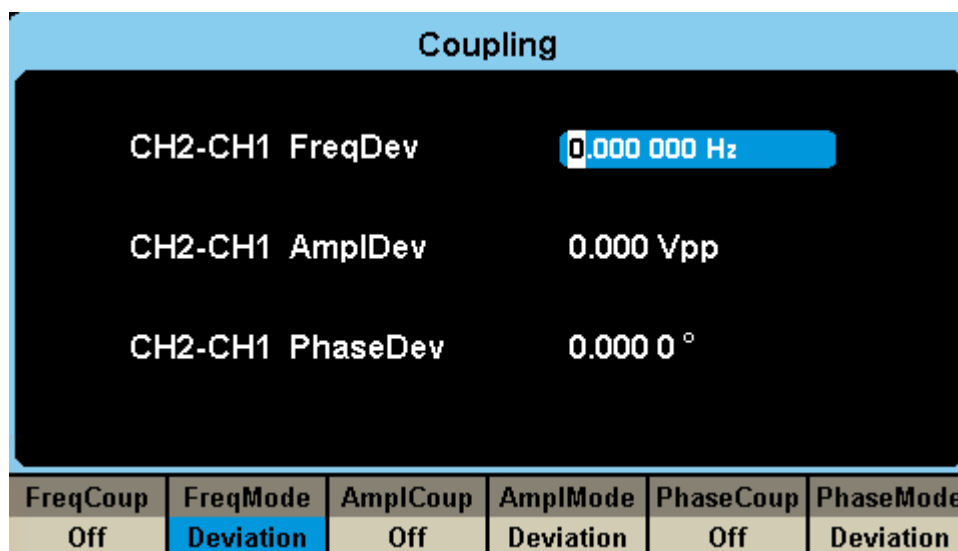

### FreqCoup

1. Turn on frequency coupling

By **FreqCoup** , the frequency coupling function can be turned on or off. The default is "off".

2. Frequency mode

By **FreqMode** , you can select "frequency deviation" or "frequency proportion", and then use the numeric keypad or knob to enter the desired value.

- Frequency ratio: The frequency ratio of CH2 and CH1. The parameter relationship is:  $\text{FreqCH2}:\text{FreqCH1}=\text{FreqRatio}$ .
- Frequency deviation: The frequency deviation of CH2 and CH1. The parameter relationship is:  $\text{FreqCH2} - \text{FreqCH1} = \text{FreqDev}$ .

### AmplitudeCoup

1. Open amplitude coupling

By **AmplitudeCoup** , the amplitude coupling function can be turned on or off. The default is "off".

2. Amplitude mode

By **AmplitudeMode** , you can choose "amplitude deviation" or "amplitude ratio", and then use the numeric keypad or knob to enter the desired value.

- Amplitude ratio: The amplitude ratio of CH2 and CH1. The parameter relationship is:  $\text{AmplitudeCH2}:\text{AmplitudeCH1}=\text{AmplitudeRatio}$ .

$\text{AmplCH1} = \text{AmplRatio}$ .

- Amplitude deviation: The amplitude deviation of CH2 and CH1. The parameter relationship is:  $\text{AmplCH2} - \text{AmplCH1} = \text{AmplDev}$ .

### PhaseCoup

1. Turn on phase coupling

By **PhaseCoup**, the phase coupling function can be turned on or off. The default is "off".

2. Phase mode

By **PhaseCoup**, you can choose "phase deviation" or "phase proportion", and then use the numeric keypad or knob to enter the desired value.

- Phase ratio: The phase ratio of CH2 and CH1. The parameter relationship is:  $\text{PhaseCH2} - \text{PhaseCH1} = \text{PhaseRatio}$ .
- Phase deviation: The phase deviation of CH2 and CH1. The parameter relationship is:  $\text{PhaseCH2} - \text{PhaseCH1} = \text{PhaseDev}$ .

### Key points:

1. The coupling function is only effective when both channels are in basic wave (Sine, Square, Ramp, Pulse, or Arc) mode.
2. When the phase coupling function is turned on, modifying the phase of one channel will cause the phase of the other channel to change accordingly. At this time, there is no need to perform the same phase function to make the two channels truly in phase.
3. The channel coupling and channel copying functions are mutually exclusive. When the coupling function is turned on, the channel copying menu will not be displayed.

## 12.5.3 Channel tracking

When the tracking function is turned on and the parameters or status of CH1 are adjusted, the corresponding parameters or status of CH2 are automatically adjusted to the same parameters or status as CH1. At this time, the dual channels can output the same signal.

Execute **Utility** > **CH Copy Coupling** > **Track**, Tracking function can be turned on or off.

When the tracking function is turned on, the channel copying and coupling function menu will not be displayed, the user interface will switch to CH1, and cannot switch to CH2.

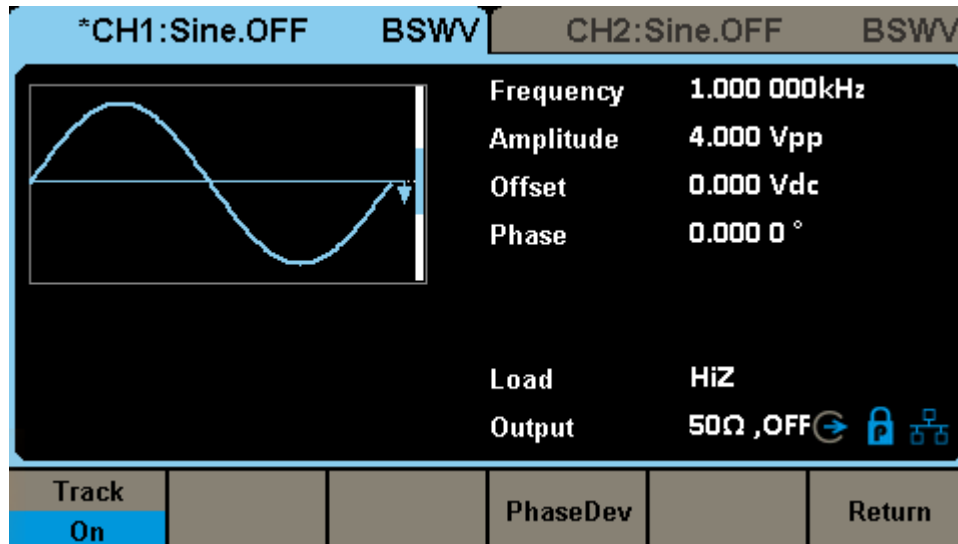

Select **PhaseDev**, enter the phase deviation setting interface, and then use the numeric keypad or directional keys and knobs to input the desired value.

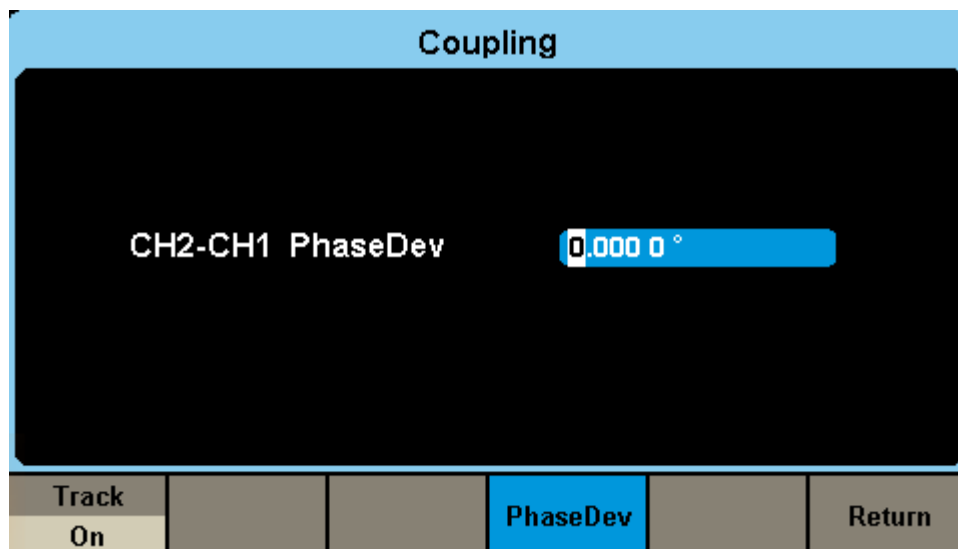

Phase deviation: The phase deviation of CH2 and CH1. The parameter relationship is:  $\text{PhaseCH2} - \text{PhaseCH1} = \text{PhaseDev}$ .

## 12.6 Interface settings

The SDG1000X Plus comes with USB, LAN (VXI-11), and GPIB (optional) interfaces. Users can set GPIB and LAN interface parameters as needed, and USB parameters do not need to be configured.

Execute **Utility** > **Page1/3** > **Interface** , Can interface to set menu.

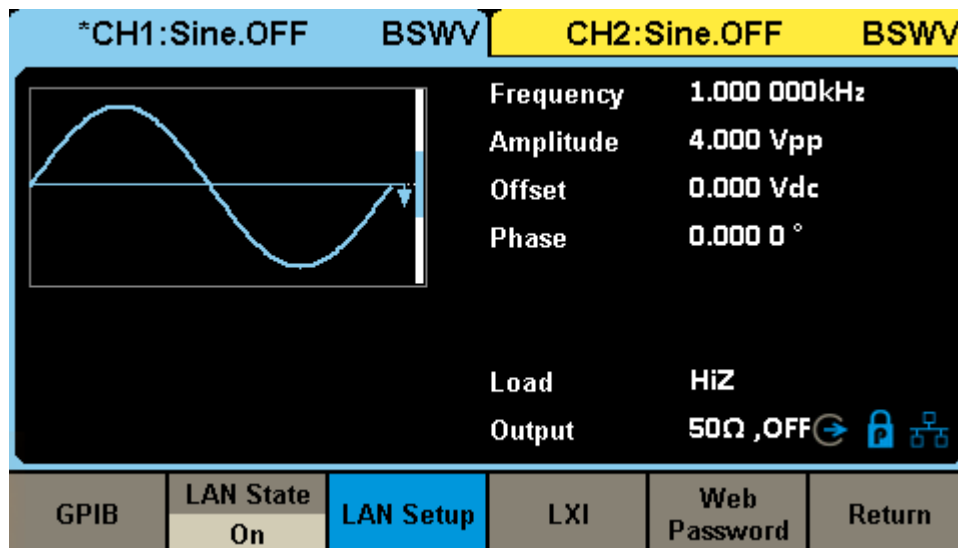

Table 12–6 Interface Settings Menu Description

Function menu	setting	Description
GPIB		General purpose interface bus.
LAN State	On	Open LAN.
	Off	Turn off LAN.
LAN Setup		Set the IP address, subnet mask, and default gateway for instrument communication.
LXI		Set LXI configuration.
Web Password		Set web access password.
Return		Save the current settings and return to the previous menu level.

You can remotely control SDG1000X Plus through the following two methods:

- **User defined programming**

Users can program and control instruments through the Standard commands for Programmable Instruments (SCPI) command. For detailed instructions on commands and programming, please refer to the programming manual of this product.

- **Using PC software**

Users can use NI (National Instruments Corporation)'s "Measurement&Automation Explorer" software to control the instruments.

### **12.6.1 USB settings**

SDG1000X Plus supports USBTMC protocol for communication with computers. You need to complete the following steps to establish a connection.

#### **1. Connecting devices**

Connect the SDG1000X Plus (via the USB Device interface on the instrument's rear panel) to the computer using a USB data cable.

#### **2. Installing USBTMC driver on computer**

Recommend using NI Visa.

#### **3. Remote communication with computers**

Open the "Measurement&Automation Explorer" software, select the resource name corresponding to the instrument, select "Open VISA Test Panel", open the remote command control panel, and you can send commands and read data through this panel.

### **12.6.2 GPIB settings**

Each device on the GPIB interface must have a unique address. The factory default value for GPIB is 18, with a setting range of 1-30. The selected address is saved in non-volatile memory and displayed when powered on.

#### **1. Connecting devices**

Connect the SDG1000X Plus to the computer using the USB-GPIB module (optional). Please ensure that your computer has a GPIB card installed, then connect the USB end of the USB-GPIB module to the USB Host interface on the front panel of the SDG1000X Plus, and connect the GPIB end of the USB-GPIB module to the GPIB card port on your computer.

#### **2. Installing GPIB card drivers on the computer**

Please correctly install the GPIB card driver connected to the computer.

#### **3. Set the GPIB address of the instrument**

After entering the operation menu of the auxiliary system function, select **Interface** > **GPIB** . Users can change their values by rotating the knob, directional keys, and numeric keypad. After entering, select OK to save the current settings.



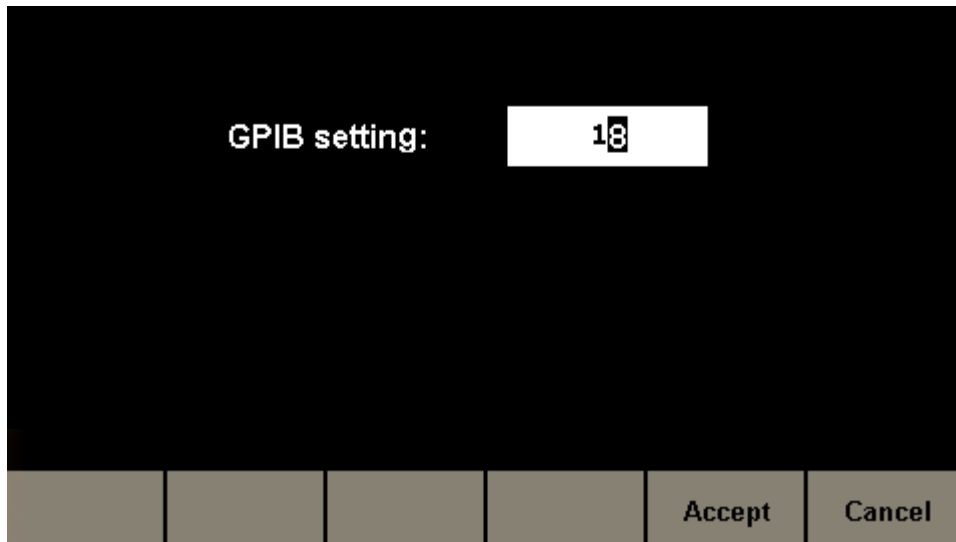

#### 4. Remote communication with computers

Open the "Measurement&Automation Explorer" software, successfully add the GPIB device, and open the remote command control panel to send commands and read data through this panel.

### 12.6.3 LAN settings

SDG1000X Plus provides remote operation through LAN interface, allowing you to view and modify the current LAN configuration.

#### 1. Connecting devices

Connect the SDG1000X Plus to the computer or the local area network where the computer is located using a network cable.

#### 2. Configure network parameters

After entering the operation menu of the auxiliary system function, select **Interface** > **LAN State** > **On**, open the network, then select **LAN Setup** to enter the interface shown below.

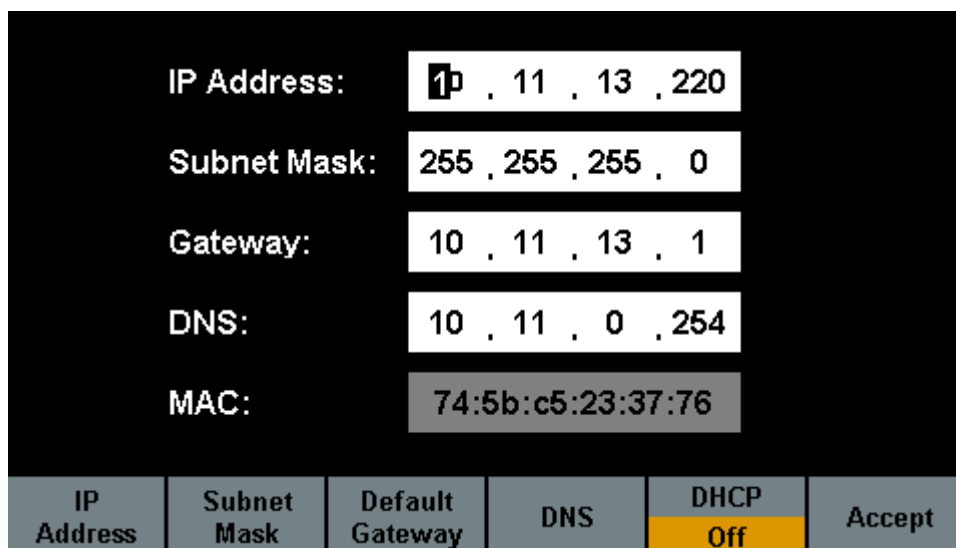

Table 12–7 Explanation of LAN Parameter Settings

Function menu	setting	Description
IP Address		Set IP address.
Subnet Mask		Set subnet mask.
Default Gateway		Set default gateway.
DHCP	On	Dynamically configure network parameters such as IP addresses.
	Off	Manually setting network parameters such as IP address.
DNS		Set up DNS.
Accept		Save the current settings and return to the previous menu level.

- **Set IP address**

The format of the IP address is nnn.nnn.nnn.nnn, with the first nnn ranging from 1 to 223 and the other three nnns ranging from 0 to 255. We suggest that you consult your network administrator for an available IP address.

Select the **IP address** and use the arrow keys and numeric keypad or knob to enter the desired IP address. This setting will be saved in non-volatile memory, and the instrument will automatically load the set IP address on the next boot.

- **Set subnet mask**

The format of the subnet mask is nnn.nnn.nnn.nnn, where nnn ranges from 0 to 255. We suggest that you consult your network administrator for an available subnet mask.

Select the **subnet mask** and use the arrow keys and numeric keypad or knob to enter the desired subnet mask. This setting will be saved in non-volatile memory, and the instrument will automatically load the set subnet mask on the next boot.

- **Set default gateway**

The default gateway format is nnn.nnn.nnn.nnn, where nnn ranges from 0 to 255. We suggest that you consult your network administrator for an available default gateway.

Select the **default gateway** and use the directional keys and numeric keypad or knob to enter the desired default gateway. This setting will be saved in non-volatile memory, and the instrument will automatically load the default gateway set on the next boot.

- **Description**

If the instrument is directly connected to the computer, set the IP address, subnet mask, and default gateway for the instrument and computer separately. The subnet masks and default gateways of both must be the same, and their IP addresses must be within the same network segment.

If the instrument is connected to the local area network where the computer is located, please obtain the available IP address and other network parameters from your network administrator. Please refer to the relevant knowledge of TCP/IP network protocol.

- **DHCP**

In this mode, the DHCP server in the current network allocates network parameters such as IP addresses to the signal generator. Press the DHCP button, select "On" or "Off" DHCP configuration mode, default to "Off".

### **3. Remote communication with computers**

Open the "Measurement&Automation Explorer" software, successfully add network devices (VISA TCP/IP Resource...), select the corresponding resource name for the instrument, select "Open VISA Test Panel", open the remote command control panel, and you can send commands and read data through this panel.

## 12.7 Sync

When synchronization is turned on, the [ Aux In/Out ] interface on the instrument's rear panel can output a CMOS signal of the same frequency as the basic waveform (excluding Noise and DC), any waveform, and modulation waveform (excluding external modulation), with a maximum frequency of 10MHz.

Execute **Utility** > **Page1/3** > **Sync** , You can enter the synchronized settings interface.

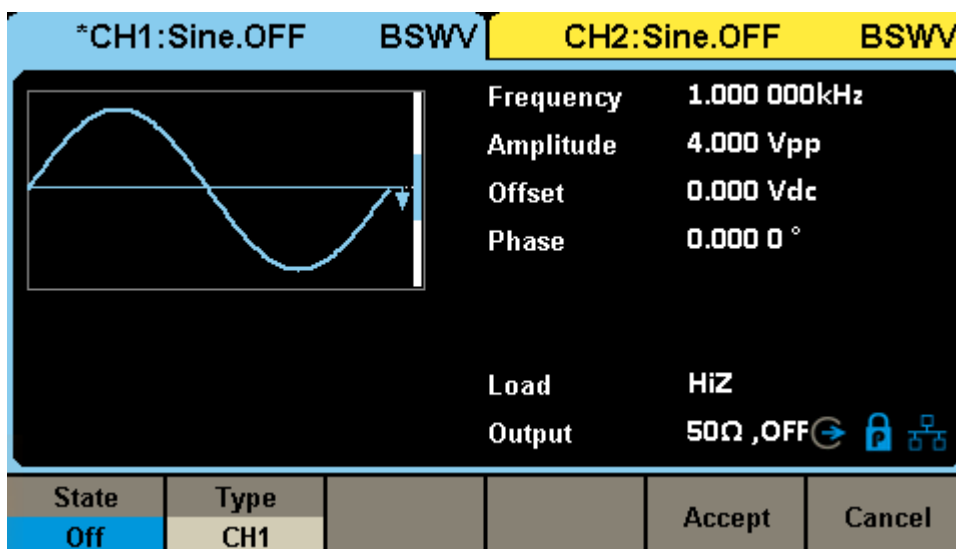

Table 12–8 Description of synchronization setting function menu

Function menu	setting	Description
State	On	Turn on synchronous output.
	Off	Turn off synchronous output.
Type	CH1	Select channel 1 as the source for synchronous output.
	CH2	Select channel 2 as the source for synchronous output.
Accept		Complete synchronization settings and return to the previous menu level.

### Synchronous signals for various waveforms:

#### 1. Basic waveform

When the frequency of the basic waveform is less than or equal to 10MHz, the synchronous signal is a pulse wave with a fixed pulse width of 100ns, and the frequency is the frequency of the basic waveform.

When the frequency of the basic waveform is greater than 10MHz, there is no synchronization signal.  
Noise and DC: No synchronous signal.

#### 2. Arbitrary wave

A synchronous signal is a pulse wave with a fixed pulse width of 100ns and a frequency of any waveform.

### **3. Adjusted waveform**

During internal modulation, the synchronization signal is a pulse wave with a fixed pulse width of 100ns.

For AM, DSB-AM, FM, PM, and PWM, the frequency of the synchronization signal is the modulation frequency.

For ASK, FSK, and PSK, the frequency of the synchronization signal is the keying frequency.

When external modulation is used, the [ Aux In/Out ] interface on the instrument's rear panel is used to input external modulation signals, and there is no synchronization signal output.

### **4. Sweep and Burst output waveforms**

When the Sweep and Burst functions are turned on, there is no synchronization signal output and the synchronization menu is not displayed.

## 12.8 Clock source

The SDG1000X Plus provides an internal 10MHz clock source and also receives an external clock source input from the [ 10MHz In/Out ] connector on the instrument's rear panel (input frequency requirement: 10MHz, minimum amplitude 1.4Vpp). It can also output a clock source from the [ 10MHz In/Out ] connector for use by other devices.

Execute **Utility** > **Page1/3** > **Clock** , Select "Internal" or "External". The default selection is "Internal". If "External" is selected, the system will check whether the [ 10MHz In/Out ] connector on the rear panel of the instrument has a valid external clock signal input. If no valid external clock source is detected, a prompt message "No external clock source detected!" will pop up, and the clock source will be displayed as "external".

## 12.9 Phase mode

Execute **Utility** > **Page1/3** > **Clock** , You can enter the phase mode setting interface.

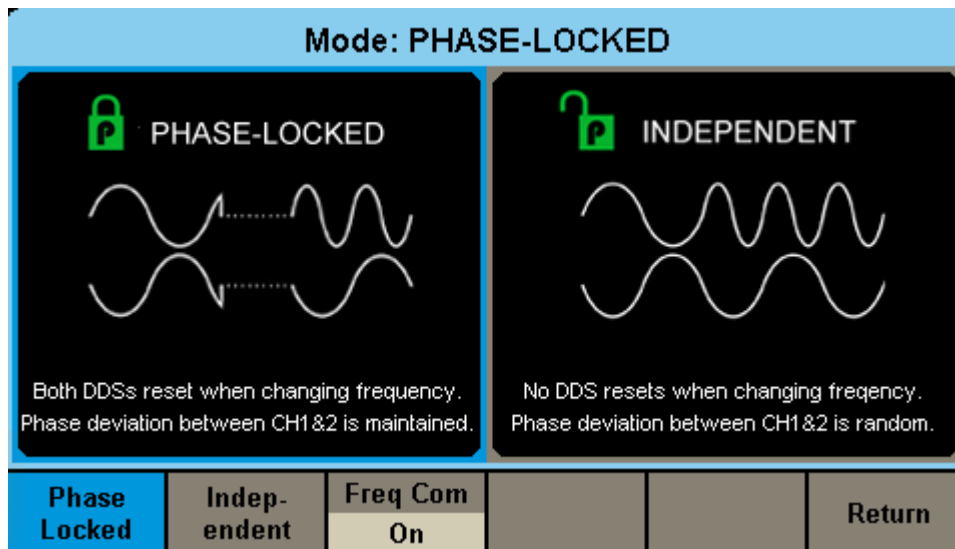

### Phase Locked

When changing the frequency, the DDS of both channels will reset and the phase difference between channel 1 and channel 2 will remain unchanged.

### Independent channel

When changing the frequency, the DDS of both channels will not reset, and the phase difference between channel 1 and channel 2 will randomly change. At this time, setting phase parameters is prohibited and the phase menu will not be displayed.

### Frequency compensation

When the frequency of two channels is an integer multiple, the software may lose accuracy in calculating the frequency of the two channels, so the actual output frequency is not a complete integer multiple relationship, resulting in phase drift of the output signal of the two channels. Frequency compensation can be achieved by correcting the frequency control word to ensure that the two channel output waveforms do not produce phase drift.

## 12.10 Overvoltage protection

Execute **Utility** > **Page1/3** > **OverVoltage Protection** , You can enter the overvoltage protection setting interface.

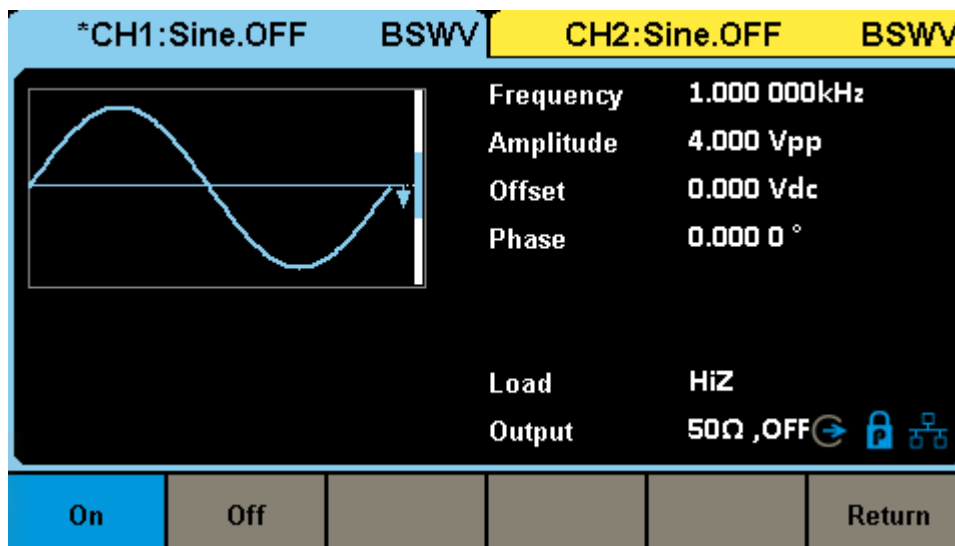

The output terminals of CH1 and CH2 channels are equipped with overvoltage protection function. If one of the following conditions is met, overvoltage protection is generated. When overvoltage protection is generated, a prompt message pops up on the screen and the output is turned off.

- The instrument amplitude is set to  $\geq 3.2V_{pp}$  or the output offset is  $\geq |2V_{DC}|$ , and the absolute value of the input voltage is greater than  $11V \pm 0.5V$ .
- The instrument amplitude is set to  $< 3.2V_{pp}$  and the output offset is  $< |2V_{DC}|$ . The absolute value of the input voltage is greater than  $4V \pm 0.5V$ .



## 12.11 Multi device synchronization

The SDG1000X Plus supports synchronization between two or more devices and can achieve in-phase output, used for applications that expand multiple two channel devices into four or more channels. Execute **Utility** > *Page1/3* > *Page2/3* > *Multi-Device Sync* , can enter the multi device synchronization settings interface.

### Method of synchronization between instruments:

#### Synchronization of two instruments

Connect the [ 10MHz Out ] of the host (with the clock source being "internal") to the [ 10MHz In ] of the slave (with the clock source being "external"), and connect the host's [ Trig/Sync ] to the slave's [ Trig/Sync ]. Then, set the two instruments to the same output frequency, open the channel output, and press the synchronization device in the host to achieve synchronization between the two instruments.

#### Synchronization of multiple instruments

Divide the [ 10MHz Out ] and [ Trig/Sync ] of the host (clock source as "internal") into multiple channels, and then connect them to the [ 10MHz In ] and [ Trig/Sync ] of multiple instruments (clock source as "external"). Set each instrument to the same output frequency, turn on the output, and press the synchronization device in the host to achieve synchronization of multiple instruments.

After pressing the synchronization device, the synchronization signal is transmitted from the host's Trig/Sync to the slave's Trig/Sync through the BNC cable. The slave receives the synchronization signal at a certain time relative to the host, so there is actually a certain phase difference between the output waveforms of the slave and the host. The magnitude of the phase difference is related to the BNC cable used, and it is recommended to use the BNC cable standard in the product. A fixed phase difference can be achieved through Compensate for slave delay.

## 13 General inspection and troubleshooting

### 13.1.1 General inspection

When you receive a new SDG1000X Plus series function/arbitrary waveform generator, it is recommended that you check it step by step as follows.

#### **Check for any damage caused by transportation issues**

If you find that the packaging box or foam plastic protective pad is seriously damaged, please keep it until the whole machine and accessories pass the electrical and mechanical tests.

#### **Check attachments**

Regarding the provided attachment details, there is a detailed explanation in Appendix A "SDG1000X Plus Series Functions/Any Waveform Generator Attachment". You can refer to this to check if the attachments are complete. If any missing or damaged attachments are found, please contact the SIGLENT distributor or local office responsible for this business.

#### **Inspect the entire machine**

If external damage to the instrument is found and the corresponding test is not passed, please contact the SIGLENT dealer or local office responsible for this business. SIGLENT will arrange for repair or replacement of the new machine.

### 13.1.2 Troubleshooting

If the power switch is pressed, the SDG1000X Plus series function/any waveform generator LCD screen still appears black. Please follow the following steps to handle it:

- Check if the power supply is powered on;
- Check if the power switch is properly connected;
- Restart the instrument;
- If you still cannot use this product normally, please contact SIGLENT and let us serve you.

If the setting is correct but there is no waveform output, please follow the following steps to handle it:

- Check if the signal connection wire is properly connected to the Output port;
- Check if the BNC cable is properly connected;
- Check if the channel output is turned on;
- After completing the above checks, set the power on to the previous setting and restart the instrument.

## 14 Service and support

### 14.1.1 Maintenance summary

**SIGLENT** warrants that the products it manufactures and sells will be free from defects in materials and workmanship for three years from the date of shipment from an authorized **SIGLENT** distributor. If a product is proved to be defective within the warranty period, **SIGLENT** will provide repair or replace the unit as described in the complete warranty statement.

To arrange for service or obtain a copy of the complete warranty statement, please contact your nearest **SIGLENT** sales and service office. Except as provided in this summary or the applicable warranty statement, **SIGLENT** makes no warranty of any kind, express or implied, including but not limited to the implied warranties of merchantability and special applicability. In no event shall **SIGLENT** be liable for indirect, special or consequential damages.

### 14.1.2 Contact SIGLENT

SIGLENT TECHNOLOGIES CO., LTD

Address: 3/F, NO.4 building, Antongda Industrial Zone, 3rd Liuxian Road, 68th District, Baoan District, Shenzhen, P.R. China

Tel: 400-878-0807

E-mail: [market@siglent.com](mailto:market@siglent.com)

<http://www.siglent.com>

## APPENDIX A

### **SDG1000X Plus Series Function/Arbitrary Waveform Generator Accessories:**

#### **Standard Accessories:**

A power cord that meets the standards of the host country

One USB data cable

A set of arbitrary wave drawing software EasyWaveX (free download from the website)

A product qualification certificate

A product calibration report

A Quick Guide

One BNC coaxial cable

#### **Purchase attachments:**

USB-GPIB adapter

SPA1010 power amplifier

20dB attenuator

## APPENDIX B

### Default setting

The default settings for SDG1000X Plus series functions/arbitrary waveform generators are as follows:

Project	Default state
Channel default state	Off
<b>DC Output</b>	
on/off	off
offset	0V
<b>Basic waveform</b>	
Frequency	1kHz
Amplitude	4V
Offset	0V
Phase	0°
Symmetry	50%
<b>AM (default)</b>	
Source selection	internal
modulated waveform	Sine
modulation frequency	100Hz
modulation depth	100%
<b>FM</b>	
Source selection	internal
modulated waveform	Sine
modulation frequency	100Hz
Frequency deviation	100Hz

<b>Project</b>	<b>Default state</b>
<b>PM</b>	
Source selection	internal
modulated waveform	Sine
modulation frequency	100Hz
phase deviation	100°
<b>ASK</b>	
Source selection	internal
Keying frequency	100Hz
<b>FSK</b>	
Source selection	internal
Keying frequency	100Hz
Frequency hopping	1MHz
<b>PSK</b>	
Source selection	internal
Modulation Rate	100Hz
polarity	normal phase
<b>PWM</b>	
Source selection	internal
modulated waveform	Sine
modulation frequency	100Hz
Pulse width deviation	190µs
<b>Sweep</b>	
Sweep Time	1 s
Stop frequency	1.5 KHz

<b>Project</b>	<b>Default state</b>
Start frequency	500Hz
Frequency range	1 KHz
center frequency	1 KHz
Trigger Source	internal
Trigger Output	Off
Scanning method	linear
Scanning direction	up
<b>Burst</b>	
Burst Period	10ms
Starting phase	0.00°
Burst mode	NCycle
N cycles	1Cycle
Trigger Source	internal
Trigger Output	Off
delay	684ns

**Note:** The default startup parameters for channel 1 and channel 2 are the same.

## APPENDIX C

### Daily maintenance and cleaning

#### Daily maintenance

When storing or placing the instrument, do not expose the LCD monitor to direct sunlight for a long time.

Attention:

To avoid damaging the instrument or connecting wires, do not place them in mist, liquids, or solvents.

#### clean

Regularly inspect the instruments and probes according to the operating conditions. Please clean the outer surface of the instrument according to the following steps:

1. Use a soft cloth to wipe off the floating dust on the outside of the instrument and connecting wires.  
When cleaning the LCD screen, be careful not to scratch the transparent plastic protective screen.
2. Use a soft cloth soaked in water to clean the instrument, please be careful to disconnect the power.

#### Attention:

- To avoid damaging the surface of the instrument or connecting wires, do not use any abrasive or chemical cleaning agents.
- Before re powering on for use, please confirm that the instrument has dried thoroughly to avoid electrical short circuits or even personal injury caused by moisture.





## About SIGLENT

SIGLENT is an international high-tech company, concentrating on R&D, sales, production and services of electronic test & measurement instruments.

SIGLENT first began developing digital oscilloscopes independently in 2002. After more than a decade of continuous development, SIGLENT has extended its product line to include digital oscilloscopes, isolated handheld oscilloscopes, function/arbitrary waveform generators, RF/MW signal generators, spectrum analyzers, vector network analyzers, digital multimeters, DC power supplies, electronic loads and other general purpose test instrumentation. Since its first oscilloscope was launched in 2005, SIGLENT has become the fastest growing manufacturer of digital oscilloscopes. We firmly believe that today SIGLENT is the best value in electronic test & measurement.

### Headquarters:

SIGLENT Technologies Co., Ltd  
Add: Bldg No.4 & No.5, Antongda Industrial  
Zone, 3rd Liuxian Road, Bao'an District,  
Shenzhen, 518101, China  
Tel: + 86 755 3688 7876  
Fax: + 86 755 3359 1582  
Email: [sales@siglent.com](mailto:sales@siglent.com)  
Website: [int.siglent.com](http://int.siglent.com)

### North America:

SIGLENT Technologies America, Inc  
6557 Cochran Rd Solon, Ohio 44139  
Tel: 440-398-5800  
Toll Free: 877-515-5551  
Fax: 440-399-1211  
Email: [info@siglentna.com](mailto:info@siglentna.com)  
Website: [www.siglentna.com](http://www.siglentna.com)

### Europe:

SIGLENT Technologies Germany GmbH  
Add: Staetzlinger Str. 70  
86165 Augsburg, Germany  
Tel: +49(0)-821-666 0 111 0  
Fax: +49(0)-821-666 0 111 22  
Email: [info-eu@siglent.com](mailto:info-eu@siglent.com)  
Website: [www.siglenteu.com](http://www.siglenteu.com)

Follow us on  
Facebook: [SiglentTech](https://www.facebook.com/SiglentTech)

