

SCP5000 Series Current Probe Instructions



Contents

SCP5000 Series Current Probes.....	2
Safety Notices.....	2
Safe Probing.....	3
Features and Applications	7
Description of Products.....	8
Description of Operation Interface	10
Specifications.....	11
Mechanical Specifications.....	14
Environmental Characteristics	14
Operating Method	15
Methods to Deal With Abnormal Situation	18
Q&A	18
Packing List.....	19
Care and Maintenance	20
Contact SIGLENT	20

SCP5000 Series Current Probes

Safety Notices

CAUTION

A **CAUTION** notice denotes a hazard. It calls attention to an operating procedure, practice, or the like that, if not correctly performed or adhered to, could result in damage to the product or loss of important data. Do not proceed beyond a **CAUTION** notice until the indicated conditions are fully understood and met.

WARNING

A **WARNING** notice denotes a hazard. It calls attention to an operating procedure, practice, or the like that, if not correctly performed or adhered to, could result in personal injury or death. Do not proceed beyond a **WARNING** notice until the indicated conditions are fully understood and met.

Safe Probing

This device is designed to comply with Safety Standards and has been thoroughly tested for safety prior to shipment. However, mishandling during use could result in injury or death, as well as damage to the device. Be certain that you understand the instructions and precautions in the manual before use. We disclaim any responsibility for accidents or injuries not resulting directly from device defects.

WARNING

- Never attach the clamp to a circuit that operates over the maximum rated voltage to earth.
- Please avoid clamping around bare conductors during measurement.
- While clamping and measuring, do not touch the clamp in front of the barrier or the conductor being measured.
- Be careful to avoid damaging the insulation surface while taking measurements.
- Make sure that the waveform measuring equipment connected to this device's output terminal (SAPBUS) is equipped with a protective earthing with double-insulation construction.
- Do not allow the device to get wet, and do not take measurements with wet hands. This may cause an electric shock.
- If the waveform measuring instrument being connected to the output terminal (SAPBUS) on this device is equipped with any other measurement terminals, take the following precautions to ensure that the other instrument does not form a bridge between the probe and any hazardous live part of a part.
- Isolate the terminal to which the probe is connected from other terminals on the measuring instrument using basic insulation conforming to the measurement category, working voltage, and pollution degree requirements of the circuit being tested.
- If basic insulation requirements cannot be met between the terminal to which this device is connected and other terminals of the measuring instrument, make sure that the voltage input to the measurement terminal does not exceed the Separated

Extra-Low Voltage Earthed.

- Read and observe all warnings and precautions relating to electrical safety for the measuring instrument being connected to the probe.

CAUTION

- To avoid damage to the device, protect it from vibration or shock during transport and handling, and be especially careful to avoid dropping.
- Do not store or use the device where it could be exposed to direct sunlight, high temperature, humidity, or condensation. Under such conditions, the device may be damaged and insulation may deteriorate so that it no longer meets specifications.
- Before using the device the first time, verify that it operates normally to ensure that the no damage occurred during storage or shipping. If you find any damage, contact your dealer or SIGLENT representative.
- This device is not designed to be entirely water- or dust- proof. To avoid damage, do not use it in a wet or dusty environment.
- The sensor head is a precision assembly including a molded component, a ferrite core, and a Hall Effect element. It may be damaged if subjected to sudden changes in ambient temperature, or mechanical strain or shock, and therefore great care should be exercised in handling it.
- The matching surfaces of the sensor head are precision ground, and should be treated with care. If these surfaces are scratched, performance may be impaired.
- Foreign substances such as dust on the contact surfaces of the sensor head can cause acoustic resonance and degrade measurement, so it should be cleaned by gently wiping with a soft cloth.
- To avoid damaging the sensor cable and power supply cable, do not bend or pull the cables.
- When the power is on, keep closed, except when clamping them onto the conductor to be measured. The facing surface of the core section can be scratched while it is open.
- Do not place any un-clamped conductor with an electric current of a frequency of

10 kHz or more near the sensor head. Current flowing in the conductor nearby may heat up the sensor head and cause its temperature to rise, leading to damage to the sensor. For example, when one side of a go-and-return conductor is clamped and the other side is also placed near the sensor head even if the electric current is lower than the consecutive maximum current, electric currents in both sides will heat up the wires and raise the temperature, thereby causing damage to the sensor.

- The maximum continuous input range is based on heat that is internally generated during measurement. Never input current in excess of this level. Exceeding the rated level may result in damage to the probe.
- The maximum continuous input range varies according to the frequency of the current being measured.
- If excess current is input, generated heat activates a built-in safety function that blocks normal output. If this happens, remove the input immediately (remove the sensor from the conductor being measured or reduce the input current to zero). Wait until the sensor has had sufficient time to cool before resuming operation.
- Even if the input current does not exceed the rated continuous maximum, continuous input for an extended period of time may result in activation of the safety circuit to prevent damage resulting from heating of the sensor.
- At high ambient temperatures, the built-in safety circuit may activate at current input levels below the rated continuous maximum.
- Continuous input of current exceeding the rated maximum or repeated activation of the safety function may result in damage to the unit.
- The probe is rated for maximum input under two conditions in addition to the input maximums shown in the Specifications. These are (1) 30 A peak for non-continuous input and (2) 50 A peak for pulse widths 10 μ s. (1) indicates an upper waveform response limit of 30 A peak. Use the sensor at RMS current input levels that are within the rated continuous maximums. (2) Indicates the upper response limit for a single input pulse.
- When opening the sensor head of the probe, be sure to operate with the opening lever. If an upper core is forced to open when the sensor head is locked, the open close mechanism can be damaged.

NOTE

- The output of this unit is terminated internally. Use an oscilloscope with an input impedance of at least 1 MΩ.
- Immediately after powering on the probe, the probe may be subject to an appreciable offset drift due to the effect of self heating. To counteract this, allow the probe to warm up for about 30 minutes before carrying out measurement.
- When performing continuous measurements, it is necessary to be aware that the offset voltage drifts, depending on factors such as the ambient temperature.
- Under certain circumstances, oscillation may occur if the probe is connected to the power supply while the power supply is on. This does not indicate a malfunction. Oscillation can be stopped and operation restored to normal by opening and closing the sensor head.
- Depending on the measured current frequency, some sound maybe produced by resonance, but has no effect on measurements.
- The reading may be affected by the position within the clamp aperture of the conductor being measured. The conductor should be in the center of the clamp aperture.
- When carrying out a measurement, push the opening lever of the sensor to lock the probe and check that the sensor head is properly closed. If the sensor head is not properly closed, an accurate measurement is not possible.
- Accurate measurement may be impossible in locations subject to strong external magnetic fields, such as transformers and high-current conductors, or in locations subject to strong external electric fields, such as radio transmission equipment.
- At high frequencies, common mode noise may affect measurements taken on the high voltage side of circuits. If this occurs, reduce the frequency range of the waveform measuring instrument or clamp onto the low- voltage side of the circuit.

Features and Applications

The SCP5000 series current probes are wide band width DC / AC active current probes, featuring high bandwidth, fast and accurate capture the current wave, accuracy up to 1% and low circuit insertion loss. This probe can be used with any oscilloscope having a high-impedance SAPBUS input.

The key features include:

- Highly accurate current measurements
- Wide bandwidth
- Accurate and easy current measurements
- DC/AC measuring capabilities
- Over-current protection with popup indicator information
- High and low range selection
- Low current measurements
- Degaussing and automatic zero setting
- UI visualization operation design, more convenient and faster to use

Applications:

- Switching and linear power design
- LED lighting design
- New energy resources
- Frequency conversion household appliances
- Experiment of electronic engineering
- Semiconductor devices design
- Inverters / transformer design
- Electronic ballast design
- Industrial control / consumer electronic design
- Engine driven design
- Power electronic and electrical drive experiment
- Electric vehicle transportation design

Description of Products

SCP5030, SCP5030A:

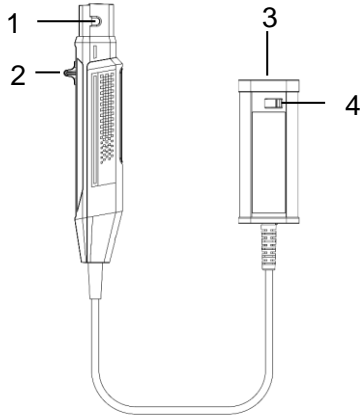

SCP5150, SCP5500:

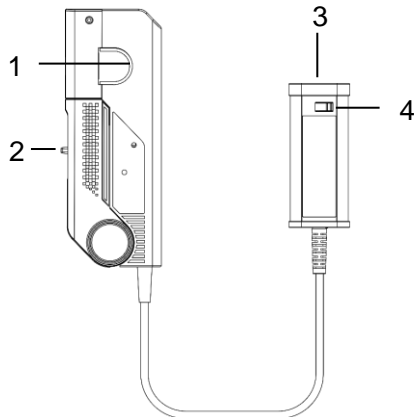

1. Sensor Head

The core component to measure conductor current. The component contains a precise semi-conductor that could be damaged by drastic change of environmental temperature, external pressure and shock. Please be careful during measurement.

2. Opening Lever

The operating lever used to open the sensor head. Move the lever to open the sensor jaw, put in the cable under test, and push the lever to lock the sensor head to measure the current.

3. Output Connector

This probe can be used with any oscilloscope having a SAPBUS input.

4. Toggle lock

Use to lock probe to the BNC connector of oscilloscope or unlock from scope.

Description of Operation Interface

Connect the SCP5000 with oscilloscope, click on the channel parameter area in the bottom left corner of the oscilloscope user interface to open the channel parameter setting dialog box. Click "Probe" to pop up the probe information interface, where you can set the probe.

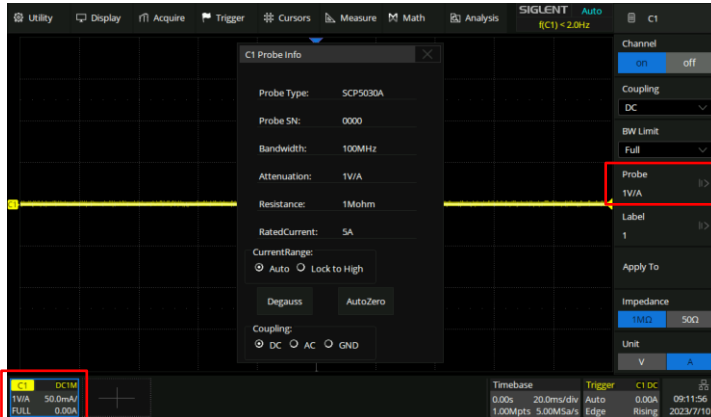

The information includes following contents:

- Probe Type: The type of the currently connected probe.
- Probe SN: The serial number of the currently connected probe.
- Bandwidth (-3dB)
- Attenuation: Attenuation ratio.
- Resistance: Oscilloscope input resistance value.
- RatedCurrent: Rated current value of the current range.
- CurrentRange: Current range state. Auto: Automatic mode; Lock to High: The probe range is locked to the maximum attenuation ratio.
- Degauss / AutoZero: Frequent usage of the device will generate residual magnetic field. Please degauss and zero set before measurement for better measurement precision. Click the "Degauss" and "AutoZero" to trigger the process.
- Coupling: DC coupling: passing through all components of the signal; AC coupling: suppressing the DC component of the signal; GND: Grounding.

Specifications

Model		SCP5030 (A)		SCP5150		SCP5500	
Bandwidth (-3 dB)		SCP5030	DC-50 MHz (picture1.a)	DC-12 MHz (Figure 4)		DC-2 MHz (Figure 7)	
		SCP5030A	DC-100 MHz (picture1.b)				
Rise Time		SCP5030	≤ 7 ns	≤29 ns		≤175 ns	
		SCP5030A	≤ 3.5 ns				
Continuous maximum input range		SCP5030	30 Arms (picture2.a)	150 Arms (Figure 5)		500 Arms (Figure 8)	
		SCP5030A	30 Arms (picture2.b)				
Max peak current value		50 Apk		300 Apk		750 Apk	
Range		5 A	1X	30 A	10X	75 A	10X
		30 A	10X	150 A	100X	500 A	100X
Overload		5 A	≥5 A	30 A	≥30 A	75 A	≥75 A
		30 A	≥50 A	150 A	≥300 A	500 A	≥750 A
Current transfer ratio		5 A	1 V/A	30 A	0.1 V/A	75 A	0.1 V/A
		30 A	0.1 V/A	150 A	0.01 V/A	500 A	0.01 V/A
Resolution		5 A	1 mA	30 A	10 mA	75 A	10 mA
		30 A	10 mA	150 A	100 mA	500 A	100 mA
Accuracy (DC, 45-66 Hz)		5 A	±1%±1 mA	30 A	±1%±10 mA	75 A	±1%±10 mA
		30 A	±1%±10 mA	150 A	±1%±100 mA	500 A	±1%±100 mA
Input resistance		SCP5030	Reference (Figure 3.a)	Reference (Figure 6)		Reference (Figure 9)	
		SCP5030A	Reference (Figure 3.b)				
Delay	Probe	14 ns		36 ns		42 ns	
	BUS cable (1 .5m)	7.5 ns					
Terminal load requirements		≥100 kΩ					
Power Supply		Directly powered by the oscilloscope through SAPBUS					
Voltage of insulated wire		300 V CAT I		600 V CATII 300 V CATIII			
Safety compliance		EN61010-1: 2010+A1:2019 EN 61010-2-032:2019					
EMC standard		EN61326-1:2013 EN61000-3-2:2014 EN61000-3-3:2013					

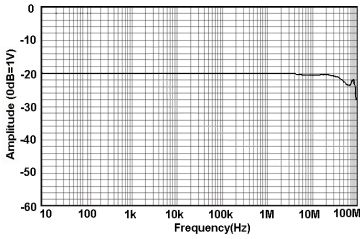

Fig 1.a SCP5030
Amp- Frequency curve

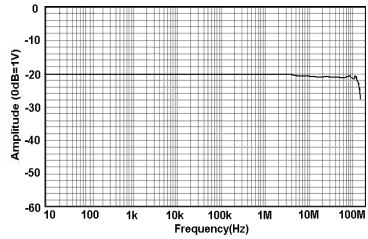

Fig 1.b SCP5030A
Amp- Frequency curve

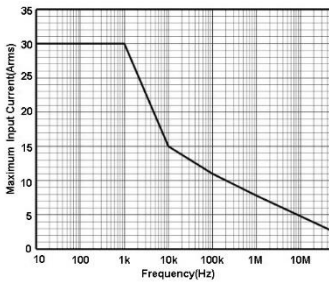

Fig 2.a SCP5030
Continuous maximum input measurement

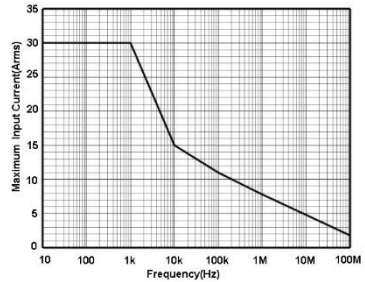

Fig 2.b SCP5030A
Continuous maximum input measurement

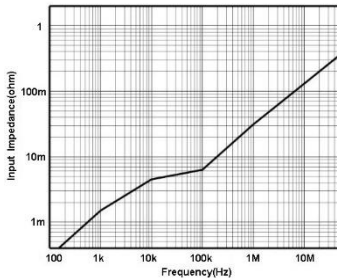

Fig 3.a SCP5030
Input impedance VS Frequency

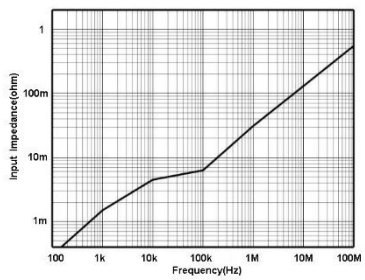

Fig 3.b SCP5030A
Input impedance VS Frequency

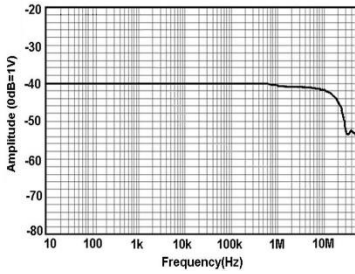

Fig 4 SCP5150
Amp- Frequency curve

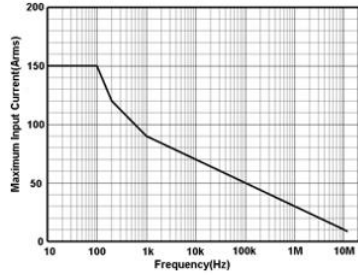

Fig 5 SCP5150
Continuous maximum input
measurement

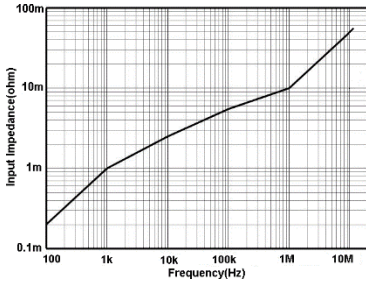

Fig 6 SCP5150
Input impedance VS Frequency

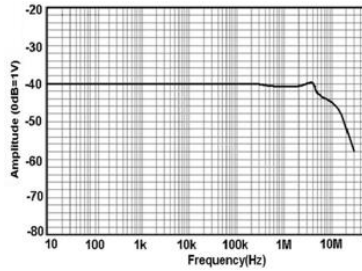

Fig 7 SCP5500
Amp- Frequency curve

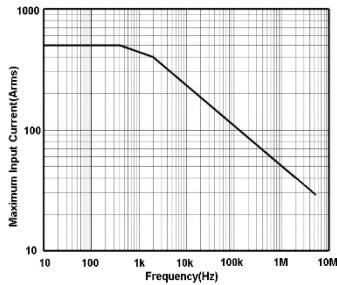

Fig 8 SCP5500
Continuous maximum input
measurement

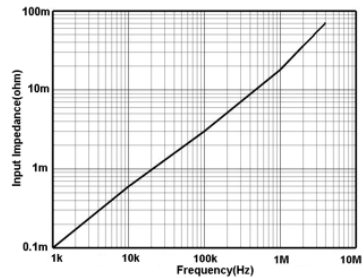

Fig 9 SCP5500
Input impedance VS Frequency

Mechanical Specifications

Model	SCP5030/SCP5030A	SCP5150 / SCP5500
Measurement conductor diameter max	5 mm	20 mm
Clamp dimensions (L*W*H)	176*39.5*18 mm	174*67.5*30 mm
Termination unit (L*W*H)	92*39*24.5 mm	
Probe weight	270 g	475 g

Environmental Characteristics

Operating temperature and humidity	0-40°C, 80% or less
Storage temperature and humidity	-10-50°C, 80% or less
Operating altitude	2000 m
Storage altitude	12000 m

Operating Method

Note

- The output interface of this machine is set inside. When using the oscilloscope, it is automatically configured with high input resistance (1 MΩ).
- Please make sure the current measured doesn't surpass the maximum current. The magnetic core will saturate. The saturated magnetic core will neutralize the generate waveform during saturation. The overcharged inrush might cause mistaken degaussing and need to be zero set again.
- When power is connected, offset might occur because of the heat generated by the machine. But it will be stabilized after about 30 min.
- Strong magnetic field like transformer, large circuit, high electricity like wireless will cause deviation.
- The voltage might deviate because of the surrounding temperature, so please be careful when testing sequentially.
- The frequency of the current under test may cause resonance, but this won't influence the testing.
- The position of conductor under test in the sensor will influence the result, so please move the conductor under test into the center of the sensor.
- Before measuring, push the opening lever to the lock state and confirm that the opening lever is locked and the entire part is indeed closed. If the entire part is not truly closed, it will not be able to measure normally.

**Attention**

- When disconnecting the output terminal, please pull out the connector after unlocking. The output terminal will be damaged if you force to drag the cable out before unlocking.
- The continuous maximum input range is the fixed value caused by the machine's operating heat. Please do not put in current higher than this value, or the device will be damaged.
- The continuous maximum input range will change according to the frequency of the current under test. The probe will be damaged when operate under overcharged current.
- When the input current continuously surpasses the maximum input range, the self-protection will be activated by the heating of the sensor and cause wrong output. Please stop the current input and wait for full cool down before next operation.
- The protection circuit will be mistakenly activated by the high temperature even when the continuous current under test is below the max input.
- When the connect input surpass the max input range current and activate the protection function too often, the device may be damaged.
- You must open the entire part through switch controller.
- At the lock state, please do not press the entire part as shown below.

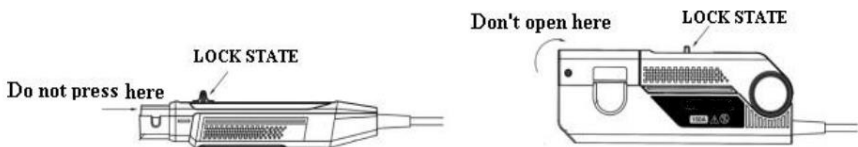

Preparation before testing

- Prepare the high frequency current probe SCP5000 series and oscilloscope.
- Set the oscilloscope: Zero set the oscilloscope and turn the oscilloscope mode to DC mode.
- Choose the proper range according to the current under test.

Degaussing and Zero setting

- Connect the SCP5000 with oscilloscope (Make sure the input impedance of the oscilloscope is 1 M Ω).
- Lock the probe and confirm that the opening lever is in lock state.
- In the probe setting interface of the oscilloscope, click "Degauss / AutoZero" to degauss and zero set.

Measurement methods:

- Confirm the previous steps.
- Move the switch control pole of the sensor, open the head of the sensor and make the current direction mark on the front end of the sensor consistent with the flow direction of the measured current, and clamp the measured conductor in the middle of the sensor head.
- Move the switch control pole of the sensor to lock state, make sure the entire part is closed.
- Configure appropriate vertical sensitivity and observe the waveform under test.

Methods to Deal With Abnormal Situation

Situation	Possible reason	Dealing method
Can't measure DC, or the value obtained is comparatively low in the frequency range	Abnormal power supply	Reconnect SAPBUS
	Oscilloscope set to AC coupling	Set to DC coupling
	Sensor is not locked	Please lock the sensor
Auto degaussing or zero setting unsuccessful	The probe is on the operating circuit under test when degaussing or zero setting is applied	Turn off the circuit under test and zero set again.
The amplitude is comparatively low in the frequency range	The input resistance of the test equipment like oscilloscope is 50 Ω	Set the resistance over 1 M Ω

Q&A

Does SCP5000 series fit the oscilloscope of any brand?

A: SCP5000 series has standard SAPBUS interface can be applied to the oscilloscope equipped with SAPBUS, and the probe is powered directly by the oscilloscope.

Can SCP5000 series product measure small current?

A: Yes. For now, the SCP5000 series current probe has two optional ranges, and one is for small current. The current resolution of the SCP5030(A) is 1 mA. When measuring small current, please accurately zero set and degaussing the probe, and do not change the position of the probe hand grip. To observe the waveform please set the bandwidth restriction of the oscilloscope to 20 MHz to eliminate the interference of noise. When measuring extremely small current (a few mA for example), one could make a few more loop of cable around the probe and divide the result with number of loop to obtain the actual current value.

Any more tips?

A:

- When measuring high frequency current, please do not let the current surpass the value shown by the curve of max peak current vs frequency. The max continuous current over the curve will burn the probe.
- To measure accurately, please degauss and zero set the probe, and make sure the probe is locked during the process.
- Set the input impedance of the oscilloscope to 1 M Ω (default)
- Make sure the probe is locked during testing.
- The probe should be away from the interference source like transformer. The method to judge if the probe is interfered is to put the probe close to circuit under test. IF there's any output, there could be interference in the testing environment because the probe is not on the circuit yet.
- The current under test should not surpass the limit value of the probe.
- Please always maintain your probe and do not use it in the humid environment
- If there's anything wrong with the probe, please set it back for repairing. If you dismantled the device on your own, we won't guarantee for repairing.

Packing List

Packing list	
Item	Quantity
Probe	1
Instruction manual	1
Test report	1

Care and Maintenance

1. Keep the probe clean and dry.
2. Please wipe with soft dry cloth when clean needed, must not use chemicals to clean.
3. Please put the probe in the package provided, and put it in cool, clean and dry places.
4. Please put the probe in the package provided to prevent shock.
5. Do not forcefully pull the input and output lead to prevent bending, twisted and folding.

Contact SIGLENT

SIGLENT TECHNOLOGIES CO., LTD

Address: 3/F, Building 4, Antongda Industrial Zone, Liuxian Road, Baoan District, Shenzhen, P.R. CHINA

Service Tel: 0086 755 3688-7876

Post Code: 518101

E-mail:sales@siglent.com

<http://www.siglent.com>

About SIGLENT

SIGLENT is an international high-tech company, concentrating on R&D, sales, production and services of electronic test & measurement instruments.

SIGLENT first began developing digital oscilloscopes independently in 2002. After more than a decade of continuous development, SIGLENT has extended its product line to include digital oscilloscopes, isolated handheld oscilloscopes, function/arbitrary waveform generators, RF/MW signal generators, spectrum analyzers, vector network analyzers, digital multimeters, DC power supplies, electronic loads and other general purpose test instrumentation. Since its first oscilloscope was launched in 2005, SIGLENT has become the fastest growing manufacturer of digital oscilloscopes. We firmly believe that today SIGLENT is the best value in electronic test & measurement.

Headquarters:

SIGLENT Technologies Co., Ltd
Add: Bldg No.4 & No.5, Antongda
Industrial Zone, 3rd Liuxian Road,
Bao'an District, Shenzhen, 518101,
China
Tel: + 86 755 3688 7876
Fax: + 86 755 3359 1582
Email: sales@siglent.com
Website: int.siglent.com

North America:

SIGLENT Technologies America, Inc
6557 Cochran Rd Solon, Ohio 44139
Tel: 440-398-5800
Toll Free: 877-515-5551
Fax: 440-399-1211
Email: info@siglentna.com
Website: www.siglentna.com

Europe:

SIGLENT Technologies Germany
GmbH
Add: Staetzlinger Str. 70
86165 Augsburg, Germany
Tel: +49(0)-821-666 0 111 0
Fax: +49(0)-821-666 0 111 22
Email: info-eu@siglent.com
Website: www.siglenteu.com

Follow us on
Facebook: SiglentTech



2 7 7 4 0 1 0 5 6 2