

HIGH-PERFORMANCE OVENS



220 – 240 Voltage



Installation - Operation Manual

SMO28HP-2, SMO10HP-2

SMO28HP-2 formerly designated SMO34HP-2

These ovens require permanent connect wiring (also known as hardwiring) to a power supply.

Pictured on the front cover, left to right: SMO28HP-2, SMO10HP-2

The SMO28HP-2 was previously designated SMO34HP-2

Warning: This product contains chemicals, including triglycidyl isocyanurate, known to the State of California to cause cancer as well as birth defects or other reproductive harm. For more information, go to www.P65Warnings.ca.gov.



¡Advertencia! Este producto contiene sustancias químicas, incluido el triglicidil isocianurato, que el estado de California sabe que causa cáncer, así como defectos de nacimiento u otros daños reproductivos. Para obtener más información, visite www.P65Warnings.ca.gov.

Avertissement! Ce produit peut vous exposer à des produits chimiques, dont l'isocyanurate de triglycidyle, reconnu par l'État de Californie pour provoquer le cancer, des anomalies congénitales ou d'autres problèmes de reproduction. Pour plus d'informations, visitez le site www.P65Warnings.ca.gov.

SMO High-Performance Ovens

220 – 240 Voltage

Part Number (Manual): 4861777

Revision: June 22, 2020

Sheldon Part ID Numbers:

Model	SMO10HP-2	SMO28HP-2
Part ID	SLFHP1022-H	SLFHP2822-H

The Part ID denotes the specific build version of the model.



SHEL LAB is a brand of Sheldon Manufacturing, INC, an ISO 9001 certified manufacturer.



Safety Certifications

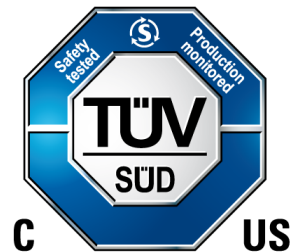

These units are CUE listed by TÜV SÜD America as forced air ovens for professional, industrial, or educational use where the preparation or testing of materials is done at an ambient air pressure range of 22.14 – 31.3 inHg (75 – 106 kPa) and no flammable, volatile, or combustible materials are being heated.

The units have been tested to the following requirements:

- CAN/CSA-22.2 No. 61010-1:2012
- CAN/CSA-C22.2 No. 61010-2-010:2015
- UL 61010-1:2012
- UL 61010-2-010:2015
- EN 61010-1:2010
- EN 61010-2-010:2014

TABLE OF CONTENTS

INTRODUCTION	5
<i>Read this Manual</i>	5
<i>Safety Considerations and Requirements</i>	5
<i>Contacting Assistance</i>	6
<i>Manufacturing Warranty</i>	6
<i>Engineering Improvements</i>	6
<i>Reference Sensor Device</i>	7
RECEIVING YOUR UNIT	9
<i>Inspect the Shipment</i>	9
<i>Orientation Images</i>	10
<i>Record the Data Plate Information</i>	12
INSTALLATION	13
<i>Hardwire Requirement</i>	13
<i>Installation Procedure Checklist</i>	13
<i>Required Ambient Conditions</i>	14
<i>Required Clearances</i>	14
<i>Power Source Requirements</i>	15
<i>Power Feed Wiring</i>	16
<i>Lifting and Handling</i>	16
<i>Leveling</i>	17
<i>Install the Oven</i>	17
<i>Installation Cleaning and Disinfecting</i>	17
<i>Shelving Installation</i>	18
GRAPHIC SYMBOLS	19
CONTROL OVERVIEW	21
OPERATION	23
<i>Operating Precautions</i>	23
<i>Theory of Operations</i>	24
<i>Put the Oven into Operation</i>	26
<i>Set the High Temperature Limit</i>	27
<i>Setting the Constant Temperature Setpoint</i>	28
<i>Temperature Programs</i>	28
<i>High Temperature Limit Activated</i>	29
<i>Venting the Exhaust Port</i>	30
<i>Power Exhaust Blower</i>	31
<i>Data Port</i>	33
<i>Changing the Unit of Measurement</i>	33
USER MAINTENANCE	35
<i>Cleaning and Disinfecting</i>	35
<i>Door Gaskets and Chamber Integrity</i>	36
<i>Electrical Components</i>	36
<i>Calibrating the Temperature Display</i>	37
<i>Unlocking the Temperature Controller</i>	41
<i>Heating Issues – Diagnostic Questionnaire</i>	44
UNIT SPECIFICATIONS	49
<i>Weight</i>	49
<i>Dimensions</i>	49
<i>Capacity</i>	50
<i>Air Flow Performance</i>	50
<i>Temperature Performance</i>	51
<i>Power</i>	52
PARTS LIST	53

INTRODUCTION

Thank you for purchasing a SHEL LAB oven. We know you have many choices in today's competitive marketplace when it comes to constant temperature equipment. We appreciate you choosing ours. We stand behind our products and will be here if you need us.

READ THIS MANUAL

Failure to follow the guidelines and instructions in this user manual may create a protection impairment by disabling or interfering with the unit safety features. This can result in injury or death.

Before using the unit, read the manual in its entirety to understand how to install, operate, and maintain the unit in a safe manner. Ensure all end-users are given appropriate training before the unit begins service.

Keep this manual available for use by all end-users.

SAFETY CONSIDERATIONS AND REQUIREMENTS

Follow basic safety precautions, including all national laws, regulations, and local ordinances in your area regarding the use of this unit. If you have any questions about local requirements, please contact the appropriate agencies.

SOPs

Because of the range of potential applications this unit can be used for, the end-user or their supervisors must draw up a site-specific standard operating procedure (SOP) covering each application and associated safety guidelines. This SOP must be written and available to all end-users in a language they understand.

Intended Applications and Locations

SMOHP forced-air ovens are engineered for constant temperature forced-air drying, curing, and baking applications in professional, industrial, and educational environments. The units are not intended for use at hazardous or household locations.

Power

Your unit and its recommended accessories are designed and tested to meet strict safety requirements.

- Always hardwire the unit power feed to a protective earth-grounded electrical source that conforms to national and local electrical codes. If the unit is not grounded, parts such as knobs and controls may conduct electricity and cause serious injury.
- Position the unit so the end-user can quickly and easily disconnect or uncouple the power feed in the event of an emergency.
- Avoid damaging the power feed. Do not bend the power feed excessively, step on it, or place heavy objects on it. A damaged power feed can be a shock or fire hazard. Never use a power feed if it is damaged or altered in any way.
- Use only approved accessories. Do not modify system components. Any alterations or modifications to your unit not explicitly authorized by the manufacturer can be dangerous and will void your warranty.

CONTACTING ASSISTANCE

Phone hours for Sheldon Customer Support are 6 am – 4:30 pm Pacific Coast Time (west coast of the United States, UTC -8) Monday – Friday. Please have the following information ready when calling or emailing Customer Support: the **model, serial, and part numbers** and **Part ID** (see page 12).

support@sheldonmfg.com
1-800-322-4897 extension 4
(503) 640-3000 extension 4
FAX: (503) 640-1366

Sheldon Manufacturing, INC.
P.O. Box 627
Cornelius, OR 97113
USA

MANUFACTURING WARRANTY

For information on your warranty and online warranty registration please visit:

- sheldonmanufacturing.com/warranty

ENGINEERING IMPROVEMENTS

Sheldon Manufacturing, Inc. continually improves all of its products. As a result, engineering changes and improvements are made from time to time. Therefore, some changes, modifications, and improvements may not be covered in this manual. If your unit's operating characteristics or appearance differs from those described in this manual, please contact your SHEL LAB dealer or customer service representative for assistance.

INTRODUCTION

REFERENCE SENSOR DEVICE

Must be purchased separately

A reference sensor device is required for calibrating the oven temperature display.

Reference devices must meet the following standards:

- Accurate to at least 0.1°C

The device should be regularly calibrated, preferably by a third party.

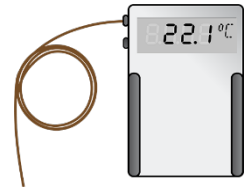

Temperature Reference

Temperature Probes

Use a digital device with a wire thermocouple probe that can be introduced into the unit chamber through the unit access port. Select a thermocouple suitable for the application temperature you will be calibrating at.

Why a Probe?

Reference readings taken outside the chamber using wire temperature probes avoid chamber door openings. Openings disrupt the chamber temperature. Each disruption requires **a minimum 1-hour wait** to allow the atmosphere to re-stabilize before continuing.

No Alcohol or Mercury Thermometers

Alcohol thermometers do not have sufficient accuracy to conduct accurate temperature calibrations. **Never place a mercury thermometer in the unit chamber.** Always use thermocouple probes.



RECEIVING YOUR UNIT

INSPECT THE SHIPMENT

- When a unit leaves the factory, safe delivery becomes the responsibility of the carrier.
- **Damage sustained during transit is not covered by the manufacturing defect warranty.**
- Save the shipping carton until you are certain that the unit and its accessories function properly.

When you receive your unit, inspect it for concealed loss or damage to its interior and exterior. If you find any damage to the unit, **follow the carrier's procedure for claiming damage or loss.**

1. Carefully inspect the shipping carton for damage.
2. Report any damage to the carrier service that delivered the unit.
3. If the carton is not damaged, open the carton and remove the contents.
4. Inspect the unit for signs of damage. See the orientation depictions on the next pages as a reference.
5. The unit should come with an Installation and Operation Manual and a Programming Guide.
6. Verify that the correct number of accessory items has been included.
7. Carefully check all packaging for accessory items before discarding.

Included Accessories

Model	Shelves	Shelf Clips	Leveling Feet
SMO10HP-2	3	12 Clips	4
SMO28HP-2	6	24 Clips	4

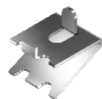

Shelves

SMO10HP-2

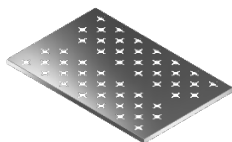

SMO28HP-2



RECEIVING

ORIENTATION IMAGES

SMO28HP-2



Access Port – Back of Oven

Fuse Holders for
Accessory Outlet
(2 amps each)

Accessory
Outlet 6-20R

Power Supply
Feed

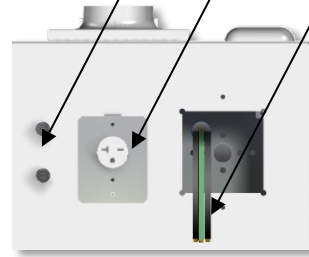

Power Panel
(Back)

Permanent Connect Wire Braid
6 gauge, 6 inches (150 mm)

Intake Vent

Control Panel

Exhaust Vent

Temperature Sensor Probes



Door
Gasket

Chamber Ceiling Liner



Shelf Standard Mounting Rail

RECEIVING

SMO10HP-2

Fuse Holders for Accessory Outlet (2 amps each) Accessory Outlet 6-20R Power Supply Feed

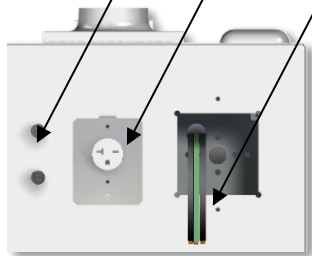

Power Panel (Back)

Permanent Connect Wire Braid
6 gauge, 6 inches (150 mm)

Access Port – Back of Oven



Intake Vent

Control Panel

Exhaust Vent

Temperature Sensor Probes

Door Gasket

Chamber Ceiling Liner

Shelf Standard Mounting Rail

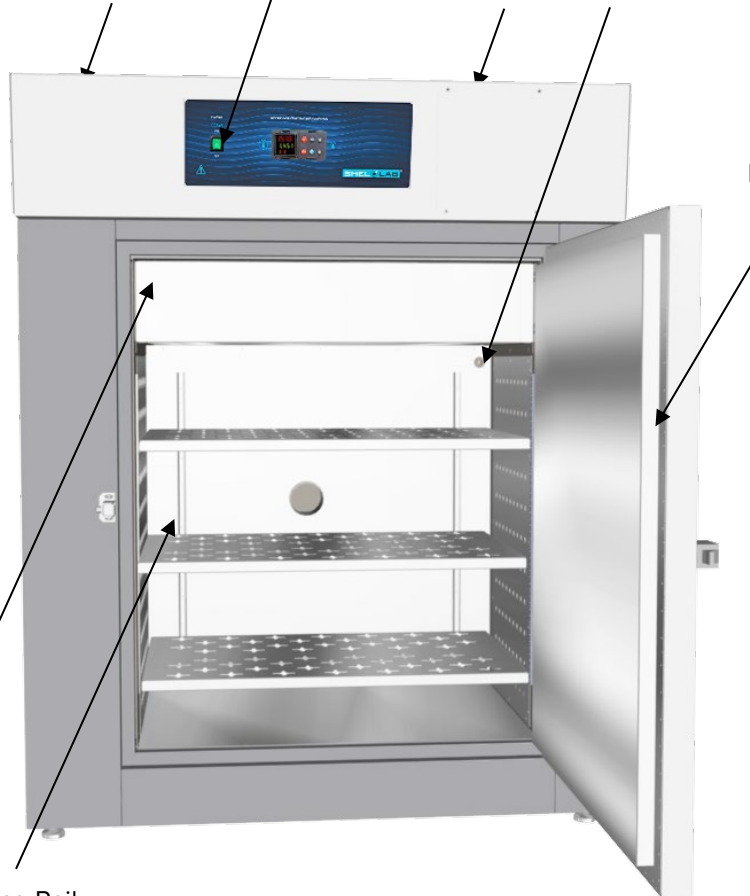

RECORD THE DATA PLATE INFORMATION

The data plate contains the unit **model number**, **serial number**, **part number**, and **part ID**. Customer Support will need this information during any support call. Record it below for future reference.

- The data plate is located on the back of the oven, next to the power inlet.

Plate Information

MODEL NO:	
SERIAL NO:	
PART NO:	
PART ID:	

HARDWIRE REQUIREMENT

The oven requires permanent connect wiring (commonly known as hardwiring). Wiring to the power source **must be performed by a qualified electrical technician**. All other Installation steps may be performed by the end-user.

INSTALLATION PROCEDURE CHECKLIST

For installing the unit in a new workspace location.

Pre-Installation

- ✓ Check that the required ambient conditions for the unit are met, page 14.
- ✓ Check that the spacing clearance requirements are met, page 14.
 - Unit dimensions may be found on page 49.
- ✓ Check that a suitable permanent connect electrical power supply is present, page 15.

Install the oven in a suitable workspace location

- ✓ Review the lifting and handling instructions, page 16.
- ✓ Install the unit leveling feet, page 17.
- ✓ Install the oven in its workspace location, page 17.
 - The oven may be connected to its power supply after this procedure.

Set up the oven for use

- ✓ Clean the unit and shelving (recommended), page 17.
- ✓ Install the shelving, page 18.

INSTALLATION

REQUIRED AMBIENT CONDITIONS

These units are intended for use **indoors**, at room temperatures between **15°C and 40°C (59°F and 104°F)**, at no greater than **80% Relative Humidity** (at 25°C / 77°F). Operating outside these conditions may adversely affect the unit temperature performance.

When selecting a location to install the unit, consider all environmental conditions that can affect its temperature performance. These include:

- Proximity to other ovens, autoclaves, and any device producing significant radiant heat
- Heating and cooling vents or other sources of fast-moving air currents
- High-traffic areas
- Direct sunlight

REQUIRED CLEARANCES

These clearances are required to provide airflows for ventilation and cooling.

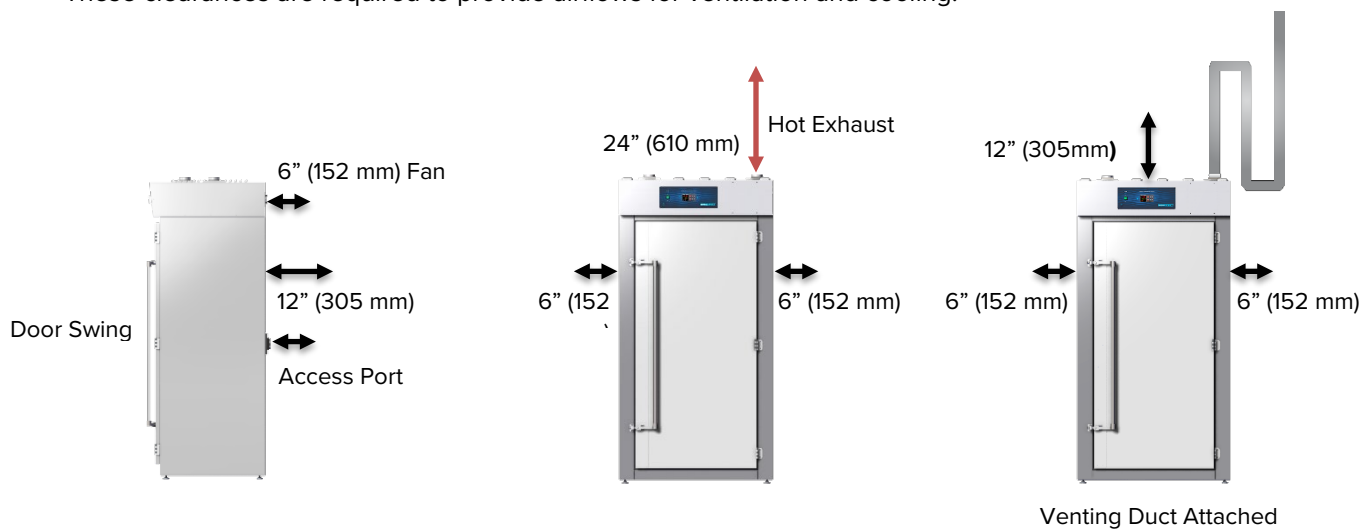

6 inches (152 mm) of clearance is required on the sides of the unit.

12 inches (305 mm) of clearance is required on the back of the unit.

24 inches (620 mm) of headspace clearance is required between the exhaust vent and any overhead cover or partition if no exhaust venting is connected.

- **12 inches (305 mm)** of headspace clearance will suffice if the oven exhaust is vented from the workspace through a duct or other channeling.

Do not place objects on top of the oven. Exception: A power exhaust blower may be mounted on the top exhaust vent.

The chamber access port is located on the back of the oven. Leave sufficient clearance for end-users to safely access this port.

POWER SOURCE REQUIREMENTS

When selecting a location for the oven, verify that each of the following requirements is satisfied:

Power Supply: The power supply must meet the power requirements listed on the unit data plate.

- These units are intended for **220 – 240 volt, 50/60 Hz** applications at the following amperages:

Model	Amperage	Model	Amperage
SMO10-HP-2	26	SMO28-HP-2	50

- The power source must be **single phase** and **protective earth grounded**.
- The power source must conform to all national and local electrical codes.
- **The unit may be damaged if the supplied voltage varies by more than 10% from the data plate rating.**
- Use a separate circuit to prevent loss of the unit due to overloading or circuit failure.

Switch or circuit breaker: A switch or circuit-breaker must be used in the building installation to protect against overcurrent conditions. The recommended circuit-breakers are:

- SMO10HP-2 **30 amps**
- SMO28HP-2 **60 amps**

Power Feed Disconnect: The oven must be positioned so all end-users have access to the power feed disconnect in case of emergencies.

- The disconnect must be in close proximity to the equipment and within easy reach of the end-user.
- The disconnect must be marked as the disconnecting device for the equipment.

Accessory Outlet Fuses: The oven is provided with a pair of 2-amp fuses installed adjacent to the external power receptacle used to power accessory blower fans.

- The fuses protect against overcurrent conditions related to the operation of any attached exhaust blower.
- If one fuse blows, the outlet will depower. The cause of a blown fuse should be determined prior to replacing it.

These fuses do not provide protection against overcurrent events associated with major components of the oven. Overcurrent protection for the oven must be set up in the location power supply external to the unit. See the circuit breaker requirements.





POWER FEED WIRING

The oven comes provided with an integral 6-inch (150 mm) wire braid consisting of:

- SMO10HP-2 – two 6-gauge hot wires and a 6-gauge earth ground.
- SMO28HP-2 – two 6-gauge hot wires and a 6-gauge earth ground.

The wires for power source connection should be in accordance with the following for all units:
Green/Yellow – Earth; Black – Hot; Black – Hot.

The oven must be earth grounded using the protective conductor terminal (green with yellow stripe wire). Do not remove the protective conductor (earth connection). Removing the protective conductor will negate the oven protections against potentially dangerous electric shocks and create a possible fire hazard.

LIFTING AND HANDLING

The unit is heavy. Use appropriate lifting devices that are sufficiently rated for these loads. Follow these guidelines when lifting the unit.

- Lift the unit only from its bottom surface.
- Doors, handles, and knobs are not adequate for lifting or stabilization.
- Restrain the unit completely while lifting or transporting so it cannot tip.
- Remove all moving parts, such as shelves and trays, and lock doors in the closed position during transfers to prevent shifting and damage.

INSTALLATION

LEVELING

Install the 4 leveling feet in the corner holes on the bottom of the oven.

The oven must be level and stable for safe operation.

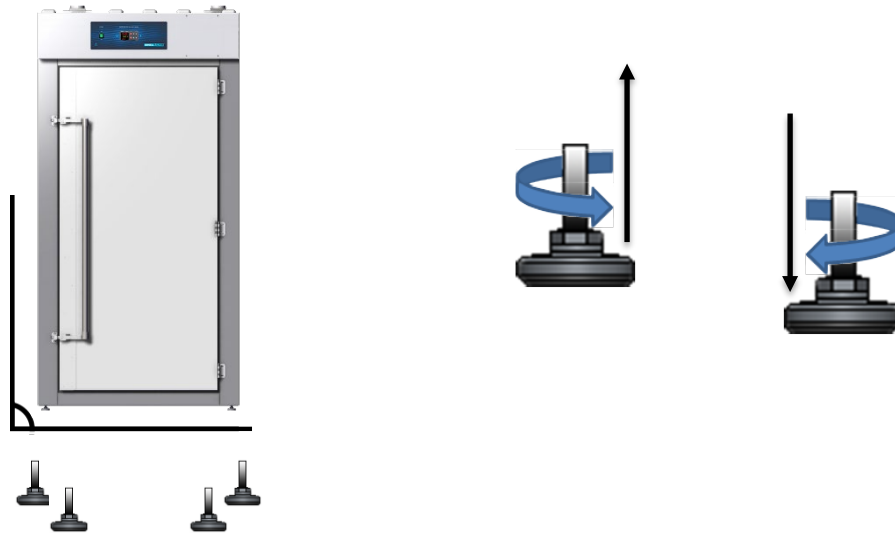

Note: To prevent damage when moving the unit, turn all 4 leveling feet so that the leg of each foot sits inside the unit.

INSTALL THE OVEN

Place the unit in a workspace location that meets the criteria discussed in the previous entries of the Installation section.

- Verify that the oven stands level and does not rock. Adjust the leveling feet as needed.
- **A qualified technician may now connect the oven to its power source.**



INSTALLATION CLEANING AND DISINFECTING

The manufacturer recommends cleaning and disinfecting the shelving and oven chamber prior to installing the shelving in the chamber. The unit was cleaned at the factory but may have been exposed to contaminants during shipping.

- Remove all wrappings and coverings from shelving prior to cleaning and installation.
- See the **Cleaning and Disinfecting** topic in the User Maintenance chapter (page 35) for more information on how to clean the oven chamber and shelving.
- **Do not clean with deionized water.**

SHELVING INSTALLATION

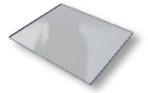

Airflow: The horizontal airflow in the chamber moves from the small duct holes in the chamber right wall, across the shelf space, and into the large holes in the left wall. To maximize airflow, avoid obstructing the duct holes on either side as much as possible when placing shelves.

Spacing: Space the shelves evenly in the oven chamber to ensure the best possible temperature uniformity.

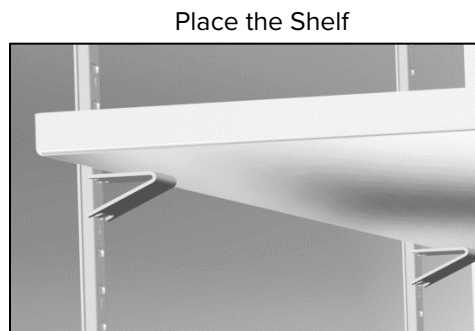
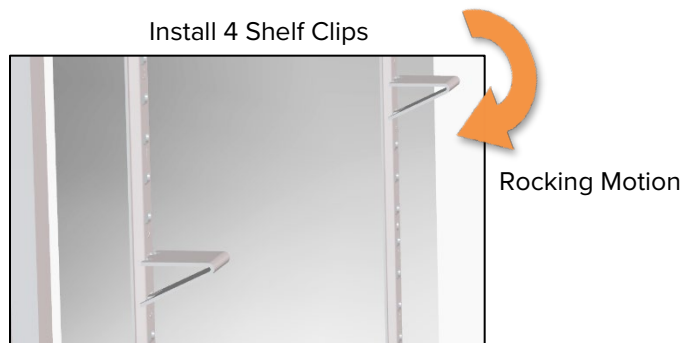







1. Install the shelf clips in the slots of the shelf standard mounting rails located on the sides of the chamber interior, 4 clips per shelf.
 - a. Squeeze each clip, insert the top tab first, and then the bottom tab using a rocking motion.

2. Set the shelves on the clips.
 - a. Verify the shelves are level.

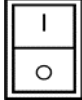
GRAPHIC SYMBOLS

The unit is provided with graphic symbols on its exterior. These identify hazards and adjustable components as well as important notes in the user manual.

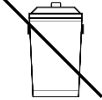
Symbol	Definition
	Consult the user manual Consulter le manuel d'utilisation
	Indicates adjustable temperature Indique température réglable
	AC Power Repère le courant alternatif
	I/ON O/OFF I indique que l'interrupteur est en position marche. O indique que le commutateur est en position d'arrêt.
	Protective earth ground Terre électrique
	Indicates UP and DOWN respectively Touches de déplacements respectifs vers le HAUT et le BA
	Potential shock hazard Risque de choc électrique
	Caution hot surface Attention surface chaude
	Recycle the unit. Do not dispose of in a landfill. Recycler l'unité. Ne jetez pas dans une décharge.

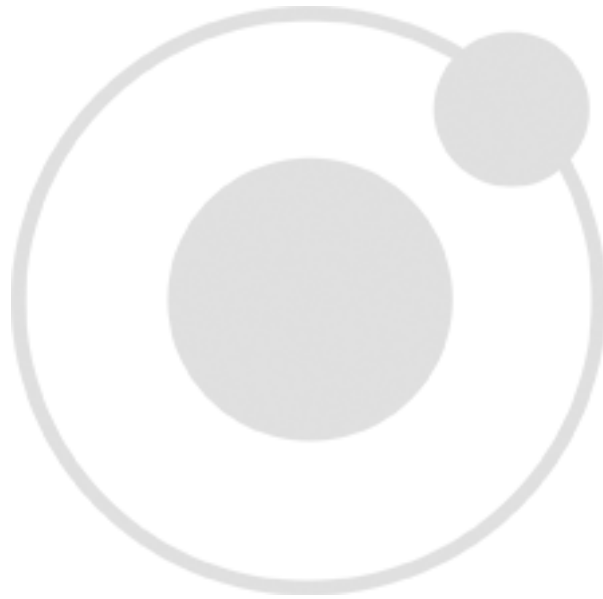

CONTROL OVERVIEW



Control Panel

Power Switch

The switch illuminates when in the ON (I) position.



Temperature Controller – Display on Homepage



Top Line (Red): Present chamber air temperature

Middle Line (Green): The constant temperature setpoint

Bottom Line: Flashing “2” indicates active heating



While on the homepage, the **Up** and **Down** arrow buttons adjust the constant temperature setpoint. Pressing and holding both buttons navigates from the homepage to menu pages. On the menu pages, the buttons adjust calibration offsets and heating program variables.



When starting on the homepage, the green **Advance** button navigates forward through parameter option pages including Units of Measurement (Celsius or Fahrenheit). The button also advances forward in menus and parameter lists when programming a temperature recipe.



The gray **Reset** button returns the display to the previous page or menu. Pushing the Reset button repeatedly returns the display to the homepage.



The EZ1 button launches temperature Program 1. Pushing EZ1 again while running aborts Program 1.



The EZ2 button launches temperature Program 2 (Step 11). Pushing EZ2 again while running aborts Program 2.





Safe operation of the oven is dependent on the actions and behavior of the oven operators.

Operating personnel must read and understand the Operating Precautions in this section prior to operating the oven. The operators must follow these instructions to prevent injuries and to safeguard their health, environment, and the materials being treated in the oven, as well as to prevent damage to the oven. Failure to adhere to the Safety Guidelines and Operating Cautions, deliberately or through error, is a hazardous behavior on the part of the operator.



Le fonctionnement sûr du four dépend des actions et du comportement des opérateurs du four. Le personnel d'exploitation doit lire et comprendre les consignes de sécurité et les précautions d'utilisation de cette section avant d'utiliser le four. Les opérateurs doivent suivre ces instructions pour prévenir les blessures et protéger leur santé, leur environnement et les matériaux traités dans le four, ainsi que pour éviter d'endommager le four. Le non-respect des consignes de sécurité et des précautions d'utilisation, délibérément ou par erreur, est un comportement dangereux de la part de l'opérateur.



OPERATING PRECAUTIONS

- Do not use this oven in unsafe improper applications that produce flammable or combustible gases, vapors, liquids, or fuel-air mixtures in quantities that can become potentially explosive.
- Outgassed byproducts may be hazardous to or noxious for operating personnel. Exhaust should be vented to a location outside the workspace in a safe manner in accordance with all applicable laws, ordinances, and regulations. Do not operate the oven in an unsafe area with noxious fumes.
- Do not use this oven for applications heating hazardous fibers or dust. These materials can become airborne and come into contact with hot surfaces.
- Individual ovens are not rated to be explosion proof. Follow all building certification requirements and laws for Class I, II, or III locations as defined by the US National Electric Code.
- The bottom surface of the chamber should not be used as a work surface. It runs hotter than the shelf temperatures. Never place samples or product on the oven chamber floor.
- Do not place sealed or filled containers in the oven. These may burst open when heated.
- Do not place alcohol or mercury thermometers in the oven. These devices may rupture under heat or other improper uses.
- Do not move the oven until it has finished cooling.

Warning: The vent dampeners may be hot to the touch. These areas are marked with Hot Surface labels. Proper PPE should be employed to minimize the risk of burns.

Avertissement: Les clapets d'aération peuvent être chauds au toucher. Ces zones sont marqués avec des étiquettes de Surface chaude. Les EPI approprié devraient être employée pour réduire au minimum le risque de brûler.



THEORY OF OPERATIONS

Heating



The oven temperature controller stores an end-user-selected constant temperature setpoint. When powered, the oven heats the chamber atmosphere to the setpoint. The controller board is wired to a solid-state temperature probe located in the chamber on the rear wall. When the controller detects that the chamber temperature has dropped below the temperature setpoint, it pulses power to the heating elements.

The controller uses proportional-integral-derivative analytical feedback-loop functions when measuring and controlling the chamber air temperature. PID-controlled heating pulse lengths are proportional to the difference between the measured chamber temperature and the current setpoint. The frequency of pulses is derived from the rate of change in the difference. The integral function slows the rate of pulses when the temperature nears the setpoint to avoid overshooting.

The oven relies on natural heat radiation for cooling. The oven can achieve a low-end operating temperature of the ambient room temperature plus the internal waste heat of the oven.

Heating Options



The oven can either heat to and run at a constant temperature setpoint or execute a programmable multistep temperature recipe with ramp up, heat soak, and ramp down intervals.

Air Circulation



The oven continually circulates air internally while powered in order to maintain temperature uniformity and stability in the oven chamber and to speed drying rates. Air is forced through vent holes on the right side of the chamber, blows across the shelf space, and is then pulled into a duct that makes up the left chamber wall. From there, the air is drawn upward into a heating duct by the action of the blower fan. The oven is intended to be run as a closed air-cycle system.

Vents: Intake and Exhaust

The oven is provided with an intake vent and an exhaust vent. These may be opened or closed using dampener slides located on the vents. The vents are intended to be opened **after** the heat treatment or bake out phase of an application is complete. Opening the dampener vents during an application may speed the rate of material drying, depending on the nature of the sample material, outgassed byproducts, and ambient conditions. However, running the oven with the vents open introduces a significant flow of cool air into the chamber while allowing heated air to exit. This impacts the temperature uniformity and stability of the chamber and lowers the chamber temperature.



Accessory Power Exhaust Outlet

SMOHP ovens come with an external accessory power outlet to supply electricity to a power exhaust fan attached to the oven exhaust vent. The outlet and any attached blower are either activated by the temperature controller as part of a user-programmed heating recipe or can be activated from the homepage options when the oven is running a constant temperature setpoint. The primary application of the power exhaust fan is to positively vent exhaust out of the workspace around the oven. The standard receptacle is a 240 volt, North American 6-20R.



The operation of the fan affects the oven chamber temperature, significantly lowering the temperature ceiling by boosting the rate that cooler outside air is brought in.

High Limit Control System

The temperature controller contains a heating cutoff system with independent circuitry connected to a redundant solid-state temperature sensor probe inside the oven chamber. This high limit system depowers the oven heating elements whenever the chamber air temperature exceeds the current limit setting. This safeguards the oven in the event of a failure of the main temperature control circuitry or main temperature sensor probe.



The high limit is set by the end-user to a minimum of 10°C above the highest temperature of the application process the oven is currently being used for. Failure to set the high limit control system voids the oven manufacturing defect warranty in the event of an overtemperature event.

OPERATION



PUT THE OVEN INTO OPERATION

Perform the procedures below after the unit has been installed in a new workplace location. These prepare the oven for normal use.

1. Turn on the Oven

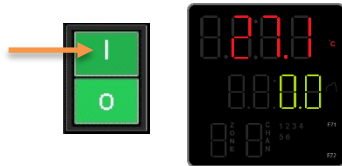

Place the oven **Power Switch** in the ON (I) position.

- The controller display will illuminate and default to the homepage.



2. Set the High Limit Temperature

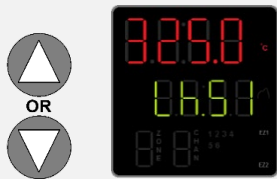

Use the [Set the High Temperature Limit](#) procedure on page 27 to set the Limit heating cutoff to at least 10°C above the highest intended temperature of your application.



3. Setting the Operating Temperature

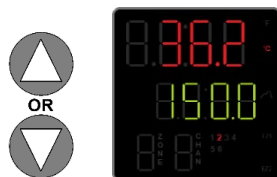

Read these procedures and descriptions.

[Setting the Constant Temperature Setpoint.](#) See the procedure on page 28.

Or

[Program multistep heating recipes.](#) See the description on page 28.

Reminder: The intake and exhaust vents must be closed for the oven to meet its temperature specifications.

The oven is now ready for use.

OPERATION

SET THE HIGH TEMPERATURE LIMIT

Note: Test the high limit system once per year for functionality.

Set the high temperature limit at least 10°C above the highest temperature the oven will run at during your recipe program or constant-temperature application. See the High Temperature Limit system explanation on page 25.

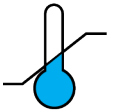

1. Advance to the Limit High Setpoint, starting on the homepage



Push Advance multiple times



- Push the Advance button repeatedly until “Lh.S1” (Limit High Setpoint) shows in the green mid-level display line.

2. Adjust the high limit to at least 10°C above the highest temperature of your application



Adjust



- The oven will automatically save and apply the new High Limit setting after you have stopped adjusting.

Note: If you are just checking the current high temperature limit setting, push the Reset button to exit the Limit High Setpoint menu and return to the homepage without saving any changes.

3. Return to the Homepage



Push Reset



- Returned to the homepage.

End of Procedure



SETTING THE CONSTANT TEMPERATURE SETPOINT

1. Adjust the Constant Temperature Setpoint on the Homepage



- Stay 10°C below the high limit setpoint.

Note: Holding down an arrow button will cause the temperature to advance in increments of ten (10).

2. Release the Arrow buttons after adjusting the Setpoint



Oven Heating

- There may be a brief pause as the oven controller calculates the optimum power usage to achieve the setpoint starting from the current oven chamber temperature.
- A small illuminated 2 near the bottom of the display indicates the temperature controller is calling for heat.

TEMPERATURE PROGRAMS



Please see the temperature program manual included with this oven for how to program automated heating recipes. The manual provides illustrated explanations for all major program functions and programming steps.

EZ1

Pushing EZ1 launches heating Program 1. Pushing EZ1 again while running aborts Program 1.

EZ2

Pushing EZ2 launches heating Program 2 (Step 11). Pushing EZ2 again while running aborts Program 2.

HIGH TEMPERATURE LIMIT ACTIVATED

The High Limit system cuts off heating in the oven whenever the chamber temperature meets or exceeds the Limit setting. Heating remains disabled until the oven end-user clears the Limit cutoff.

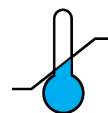

Indicators

When heating is cut off, the oven display flashes two alternating alert screens. Additionally, an illuminated “4” on the bottom display level specifies that the oven should be routing electricity away from the heating elements.

Activation of the Limit cutoff is accompanied by a click sound.

Possible Causes of High Limit Activation

- The oven temperature is set above or near the High Limit cutoff setting. The High Limit should be set **at least 10°C above** the highest intended temperature of your heating application.
- A heat source in the oven chamber is pushing the oven temperature above the limit setting.
- Significant outgassing in the chamber may be interfering with the measured temperature.
- Attempting to heat a significant mass of product or samples may trigger a temperature overshoot and subsequent Limit cutoff.
- The oven temperature controller circuitry or sensor probe has failed.

If you suspect an ignition event in the oven chamber or a hardware failure **wait for the oven to cool to room temperature before opening a chamber door**. Contact [Customer Support](#) for assistance.

Clearing the High Limit Heating Cutoff

- Clearing the cutoff restores power to the oven heating elements.
- The oven chamber temperature must be below the High Limit cutoff setting before clearing the cutoff.
- Always verify it is safe to resume heating before clearing the High Limit cutoff.

1. Push the Reset button.



- The alert screens will flash 2 additional times before the oven controller clears the cutoff, ending it.

Alternating Alert Screens



Attention Screen



Heating Off

VENTING THE EXHAUST PORT

Optional: The oven does not require venting to operate. However, evacuating exhaust out of the workspace can help prevent elevated temperatures and the buildup of unpleasant odors.

- Obtain flexible, non-insulated ducting.
- Attach the ducting to the lip of the exhaust port on the top, right side of the oven. See the images below.
 - Secure the ducting to the lip using a clamp (for example a crimp clamp).
- Include a U-shaped bend in the duct to prevent moisture condensate in the ducting from sliding back down into the oven chamber.
- Position or connect the free end of the ducting so that it safely channels exhaust away from the workspace and any areas occupied by personnel.
- Make sure the exhaust port is open when venting.

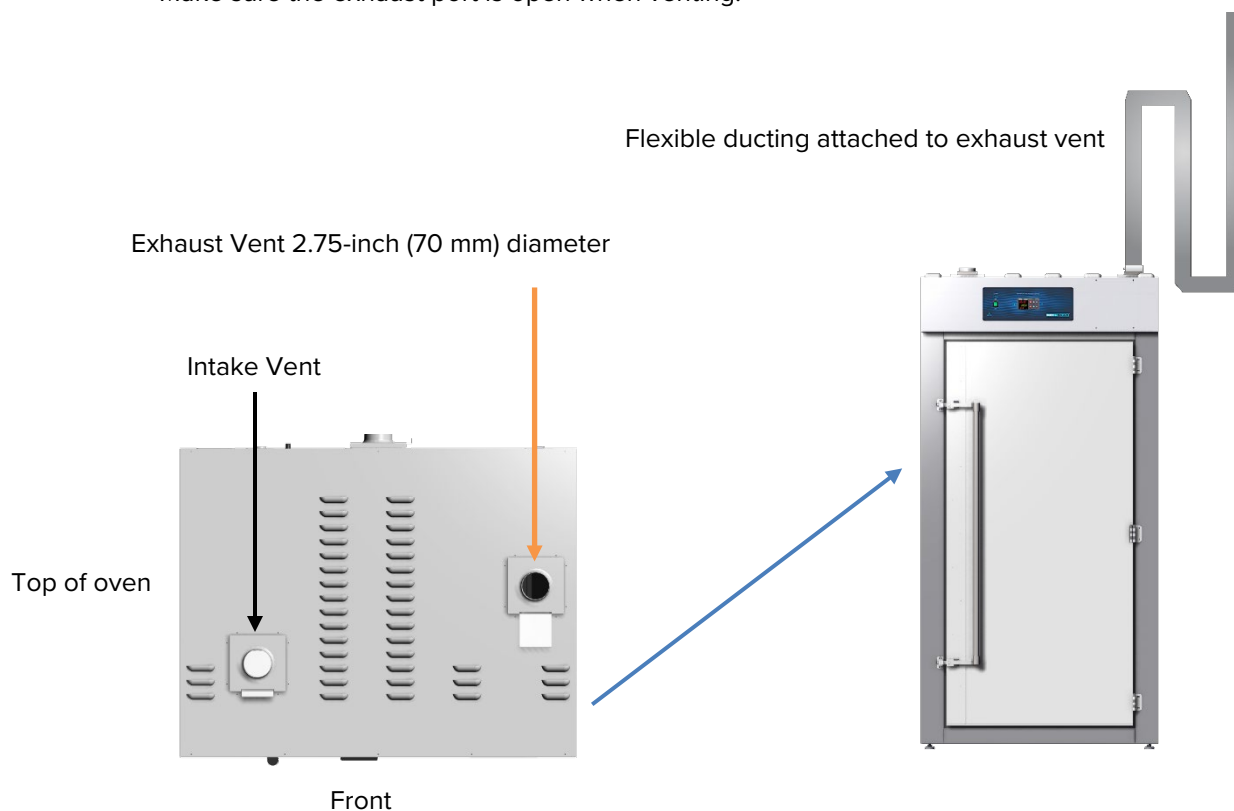

OPERATION

POWER EXHAUST BLOWER

Note: Exposure to sustained oven chamber temperatures above 80°C will damage the exhaust blower while it is turned off. Leave the oven exhaust vent dampener closed until it is time to turn on the blower and actively vent the oven chamber.



SHEL LAB offers an accessory forced-air power exhaust blower that can be mounted directly on the exhaust vent cover.

Mounting the Exhaust Blower

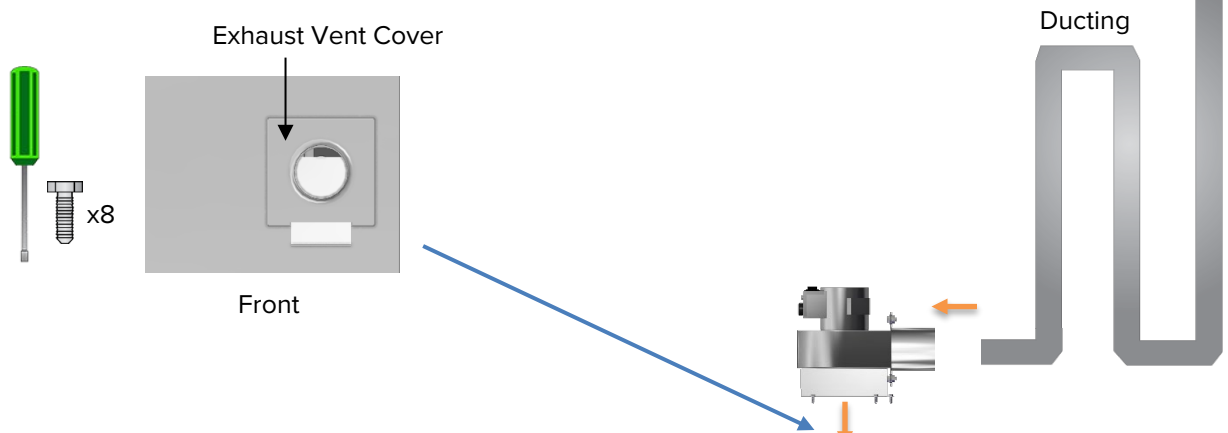

- 1.** Remove the 8 screws from the exhaust vent cover assembly on the top, right side, of the oven. **Leave the cover in place.**
- 2.** Mount the blower on the vent cover, positioning the exhaust output toward the back of the oven. Ensure that the exhaust blower and assembly screw holes are aligned.
- 3.** Reinstall the 8 screws to secure the exhaust blower and vent assembly to the unit.
- 4.** Attach flexible, non-insulated ducting to the exhaust blower to vent exhaust away from the workspace.
- 5.** Plug the exhaust blower into the 220 – 240 volt receptacle on the back of the oven.

Continued next page

OPERATION

Continued from the previous page

Activating the Power Exhaust Blower

The exhaust blower can be activated either as part of a heating recipe program or manually from the homepage Options menu while running a constant temperature setpoint. The exhaust blower will significantly impact the oven chamber temperature when on and should be used after completing a heat application.

Manually Turning on the Exhaust Blower



1. Advance to the homepage Event parameter.
 - a. Starting on the homepage, push the green Advance button 3 times so the green display reads “Ent 1”.



2. Turn on the blower.
 - a. Push the Up or Down arrow button to change the red top-line display from off to on.
 - The blower power outlet will turn on after approximately 2 seconds. Activation of the power outlet is indicated by the Red “3” light on the oven display.



3. Push the Reset button to return to the homepage.
4. To turn off the blower, advance to the Event parameter again from the homepage and change the setting from on to off.

DATA PORT

The 9-pin RS485 data port, located on the back of the oven, connects to the oven temperature controller. It is primarily intended for updating the controller software but can be used for data logging and graphical temperature recipe programming. Accessing the controller with a computer requires a 9-pin RS485-to-USB converter cable and driver software.

Applications and Utility Software

- **National Instrument LabView** and **Watlow Specview** — Temperature monitoring and data logging in graphical user interface environments.
- **Watlow's EZ Zone™ Configurator** — Programming temperature recipes in a drop-down menu environment. Configurator can also be used to copy and save the controller configuration file, which includes the currently programmed heating recipes.
 - Configurator is available for free on the Watlow website.

CHANGING THE UNIT OF MEASUREMENT

The controller can display temperatures in either Celsius or Fahrenheit.



x5

1. Starting on the homepage, push the green Advance button until reaching the “C_F1” units of measurement option.



2. Use the Arrow buttons to change the measurement parameter on the top display line to your preferred unit of measurement.

- “C” is Celsius and “F” Fahrenheit.



3. Push the Reset button to save and return to the homepage.



End of Procedure



Warning: Disconnect the unit from its power supply prior to maintenance or cleaning of this unit.

Avertissement: Avant d'effectuer toute maintenance ou entretien de cet appareil, débrancher le cordon secteur de la source d'alimentation.



CLEANING AND DISINFECTING

- Periodic cleaning is required.
- Do not use spray-on cleaners or disinfectants. These can leak through openings and coat electrical components.
- Do not use cleaners or disinfectants that contain solvents capable of harming paint coatings or stainless steel surfaces. **Do not use chlorine-based bleaches or abrasives; these will damage the chamber liner.**
- Consult with the manufacturer or their agent if you have any doubts about the compatibility of decontamination or cleaning agents with the parts of the equipment or with material contained in it.
- If a hazardous material or substance has spilled in the unit, immediately initiate your site Hazardous Material Spill Containment protocol. Contact your local Site Safety Officer and follow instructions per the site policy and procedures.

Warning: Exercise caution if cleaning the unit with alcohol or flammable cleaners. Always allow the unit to cool down to room temperature prior to cleaning and make sure all cleaning agents have evaporated or otherwise been completely removed prior to putting the unit back into service.

Avertissement: Soyez prudent lorsque vous nettoyez l'appareil avec de l'alcool ou des produits de nettoyage inflammables. Laissez toujours refroidir l'appareil à la température ambiante avant le nettoyage et assurez-vous que tous les produits de nettoyage se sont évaporés ou ont été complètement enlevés avant de remettre l'appareil en service.



Cleaning

1. Disconnect the unit from its power supply.
2. Remove all removable accessory components such as shelving.
3. Clean the unit with a mild soap and water solution, including all corners.
 - Do not use an abrasive cleaner. These will damage metal surfaces.
 - Do not use deionized water to rinse or clean with.
 - Take special care when cleaning around the temperature sensor probes in the chamber to prevent damage. Do not clean the probes.
4. Rinse with distilled water and wipe dry with a soft cloth.

Disinfecting

Disinfect the oven if algae, mold, bacteria, or other biological contaminants are an issue. For maximum effectiveness, disinfection procedures are typically performed after cleaning.

Keep the following points in mind when disinfecting the oven:

- Turn off and disconnect the unit to safeguard against electrical hazards.
- Disinfect the oven chamber using commercially available disinfectants that are non-corrosive, non-abrasive, and suitable for use on stainless steel and glass surfaces. Contact your local Site Safety Officer for detailed information on which disinfectants are compatible with your applications.
- If permitted by your protocol, remove all removable interior accessories (shelving and other non-attached items) from the chamber when disinfecting.
- Disinfect all surfaces in the chamber, making sure to thoroughly disinfect the corners. Exercise care to avoid damaging the sensor probes.
- When disinfecting external surfaces, use disinfectants that will not damage painted metal, glass, and plastic.

DOOR GASKETS AND CHAMBER INTEGRITY

Periodically, inspect the door latch, trim, catch, and gasket for signs of deterioration. Failure to maintain the integrity of the door system shortens the lifespan of the oven.

These units use snap-in fiberglass door gaskets. The only tool required for swapping out these gaskets is a cutting implement for tailoring the length of the new gasket. Use proper PPE for handling exposed fiberglass when making the cuts.

ELECTRICAL COMPONENTS

Electrical components do not require maintenance. If the oven fails to operate as specified, please contact your SHEL LAB distributor or [Customer Support](#) for assistance.

CALIBRATING THE TEMPERATURE DISPLAY

Note: Performing an accurate calibration of the temperature display requires a temperature reference device. Please see the [Reference Sensor Devices](#) entry on page 7 for the minimum device requirements.

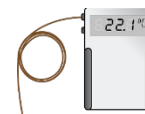

Temperature calibrations match the temperature display to the actual air temperature inside the oven chamber. The actual air temperature is supplied by a reference sensor device. Calibrations compensate for software drifts in the controller as well as deviations caused by the natural material evolution of the sensor probe in the heated chamber space. Calibrate as often as required by your laboratory or production protocol, or regulatory compliance schedule. Always calibrate to the industry or regulatory standards required for your application.

A Suggested Calibration Set Up



Use non-marking, heat-resistant polyamide tape to hold the thermocouple probe in place. The oven manufacturer recommends Kapton brand tape, 0.5 inches width (12.7 mm), 2 mil thickness.

1. Introduce the reference device thermocouple sensor probe into the oven chamber through the rear access port.

2. Position the probe in the chamber.

- Place the probe head as close as possible to the geometric center point of the chamber.
- The probe head must be at least 2 inches (51 mm) from the surface of the shelving to prevent heatsinking.

3. Secure the probe head in position with the non-marking, heat-resistant tape.

4. Close and latch the oven door. The door must be closed and latched to carry out an accurate calibration.

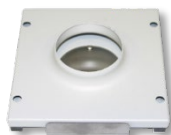

5. Verify the intake and exhaust vents are closed. Both vents **must be closed** for an accurate calibration.

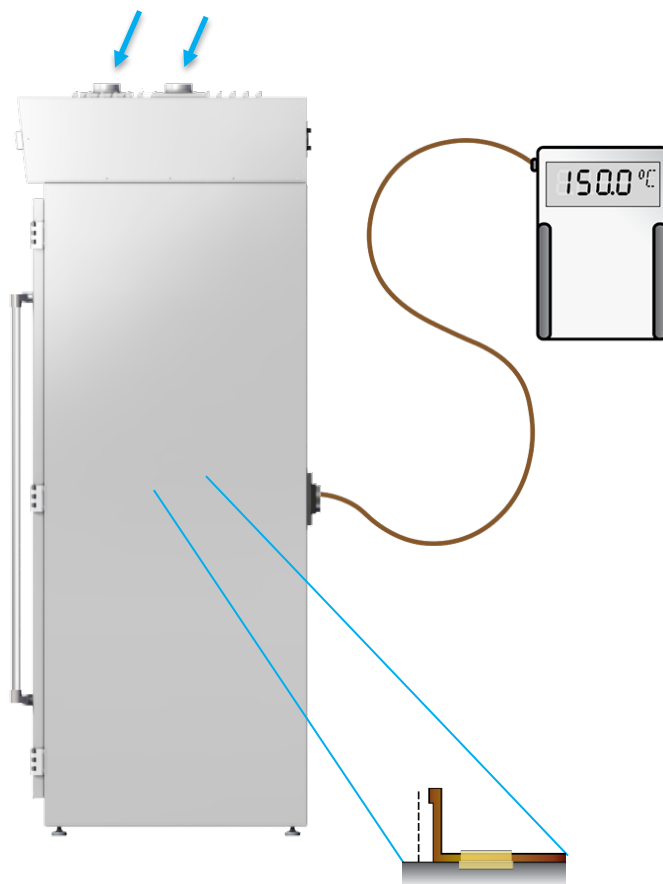

MAINTENANCE

6. The oven temperature must be stable in order to perform an accurate calibration. The temperature is considered stabilized when the oven chamber has operated with the door closed at your calibration temperature for at least one hour with no fluctuations greater than the specified stability of the oven (see page 51).

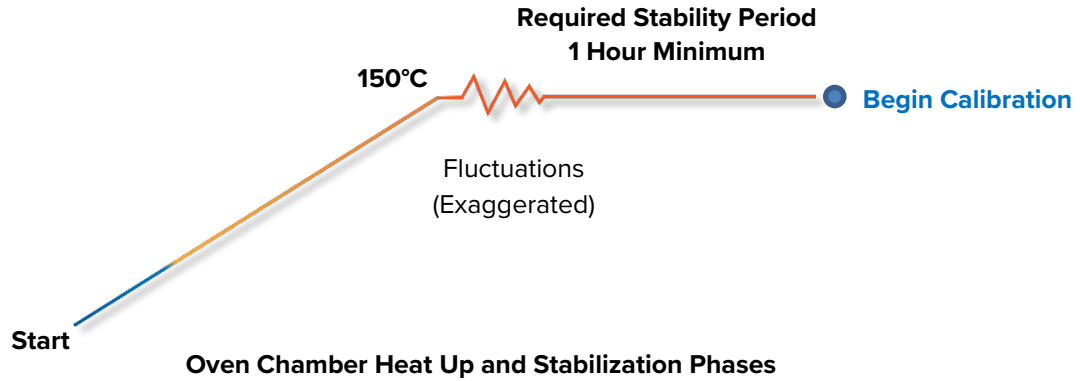

Suggested Calibration Procedure

1

Once the chamber has stabilized, compare the reference temperature device and chamber temperature display readings.

- a. If the readings are the same, or the difference between the two falls within the acceptable range of your protocol, the display is accurately showing the chamber temperature. **The Temperature Calibration procedure is now complete.**

-OR-

- b. See Step 2 if a difference falls outside the acceptable range of your protocol.



2

The display requires a calibration adjustment.

- The difference between the reference device and the display is an **offset value**.
- Examples of offset values:

Reference Sensor Reading	Oven Temp Display	Offset Value
152.0°C	150°C	2
149.1°C	150°C	-0.9
148.0°C	150°C	-2

- **Note the offset value for use in Step 5.**



Continued next page

Calibration continued

3

Unlock the controller.

- See the Unlocking procedure on page 41.

Note: The temperature controller must be unlocked in order to access the Operations menu and enter a calibration offset.



4

Navigate to the Operations menu after unlocking the controller.



- Press and hold both the **Up** and **Down** arrow buttons simultaneously for approximately 5 seconds.
- Release the buttons when “A1” appears on the top display line and “oPEr” appears in the mid display line.

Note: The Operations menu will not appear if the controller is not unlocked.



Operations Menu

5

Advance through the Operations menu options to the Temperature Calibration offset parameter.



- Push the green **Advance** button repeatedly until “i.CA” appears in the green mid display line and a number value in the red top line.



6

Adjust the number value in the top display line to match the offset value from step 2, using the arrow buttons.



7

Save the calibration offset and return to the homepage.



- Push the **Reset** button 3 times so the display shows the homepage.
- The oven will now begin heating or passively cooling to reach the setpoint with the corrected display value.



Continued next page

Calibration continued

8



Wait 30 Minutes

Wait for 30 minutes for the oven to stabilize, **after the oven has achieved the setpoint** with the corrected display value.

- Failure to wait until the oven is fully stabilized will result in an inaccurate reading.



9

Compare the reference device reading with the chamber display again.

- If the reference device and the chamber temperature display readings are the same, or the difference falls within the range of your protocol, **the unit is now calibrated for temperature.**

-OR-

- See the next step if the readings still fail to match or fall outside of your protocol range.

Reference Device



10

If the two readings are not the same, and the difference still falls outside the acceptable range of your protocol, repeat steps 3 – 7 up to two more times.

- You may skip Step 3 by leaving the controller unlocked until the unit is successfully calibrated.
- Three attempts may be required to successfully calibrate units that are more than $\pm 2^{\circ}\text{C}$ out of calibration.

Reference Device

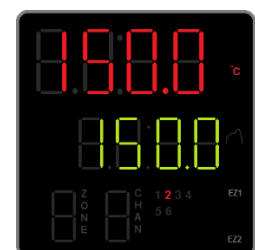

Note: Always relock the temperature controller after a successful calibration has been carried out. This safeguards against a user accidentally changing the controller configuration file and interfering with the functionality of the unit.

If the temperature difference between the unit and reference device readings fall outside your protocol after three calibration attempts, contact Customer Support or your distributor for assistance.

End of Procedure

UNLOCKING THE TEMPERATURE CONTROLLER

The oven temperature controller is software locked at the factory to ensure the integrity of its configuration file. This safeguards against end-users accidentally altering the oven functionality or safe operating bounds.

The controller must be unlocked in order to access the Operations menu and enter calibration offsets.

Backing Up the Configuration File

The manufacturer recommends saving the controller configuration file prior to making any changes to Operations options. See the Configurator software description in the [Data Port](#) entry on page 33. This will allow you to restore the configuration file in the event a change is made that adversely affects the operation of the oven.

1

Navigate to the Lock menu.



Both



- a. Press and hold **both** the **Reset** and **Advance** buttons for approximately 8 – 9 seconds.

Note: If the top red line shows the “CUST” Custom option, use the **Up** or **Down** arrow buttons to scroll to the “Loc” Security Setting option. Then push the **Advance** button as per Step 2.



2

Advance to the lock “LoC.o” parameter.



- a. Push the **Advance** button once.

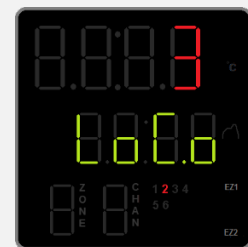

3

Adjust the LoC.o setting from 3 to 2.



- a. Push the **Down** arrow button.



Continued next page

Unlocking the Controller Continued

4

Advance to the second security parameter, “LoC.P”



- a. Push the **Advance** button once, saving the previous parameter and advancing to the next parameter.



5

Adjust the LoC.P setting from 2 to 3.



- a. Push the **Up** arrow button.



6

Advance twice. Skip through the “PAS.E” Password Enable parameter to “rLoc”, leaving “PAS.E” set to Off.



x2

- a. Push the **Advance** button twice.



Leave set to Off

7

Adjust the rLOC parameter from 2 to 5.



- a. Push the **Up** arrow button.



8

Advance to the “SLOC” Write Security parameter.



- a. Push the **Advance** button once.



Continued next page

Unlocking the Controller Continued

9

Change the “SLoC” parameter from 2 to 5.



- a. Push the **Up** arrow button.



10

Return to the homepage to access the now unlocked Operations page.



- a. Push the **Reset** button twice.



Relocking the Controller

Always relock the controller after completing a calibration or other Operations menu procedure.

- To relock controller, repeat the Unlocking procedure, only this time **restore** all of the Security lock parameters to the locked settings.
- When first navigating from the homepage to the Factory menu to relock the controller, the red top display line will show the “CUS” Custom option.
- Use the arrow buttons to scroll to the “LoC” Security option, then push the **Advance** button as per Step 2 and perform the rest of the procedure.

Parameter	Locked	Unlocked	Parameter Function
LoC.o	3	2	Operations Page
LoC.P	2	3	Programming Page
PAS.E	Off	Off	Password Enable
rLoC	2	5	Read Lock
SLoC	2	5	Write Security

HEATING ISSUES — DIAGNOSTIC QUESTIONNAIRE

If the unit is experiencing heating issues, use this questionnaire to gather information on the unit prior to contacting Customer Support. Gathering and sharing this information aids Customer Support in making timely and accurate remote diagnoses. Additionally, datalogger files, as well as pictures and videos of the unit in its failure mode, are valuable diagnostic resources that can be shared with Customer Support.

Overview

You will be performing the following tasks to gather onsite data:

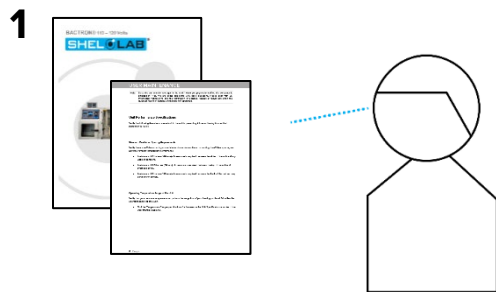

Verify the Unit Conditions using the procedure on page 45.

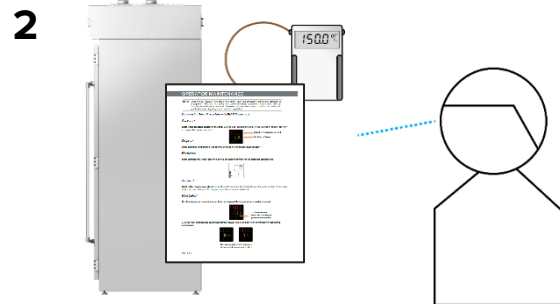

Read the Preparing topic on page 46, then observe the unit in operation using the Heating Diagnostic questions on page 47.

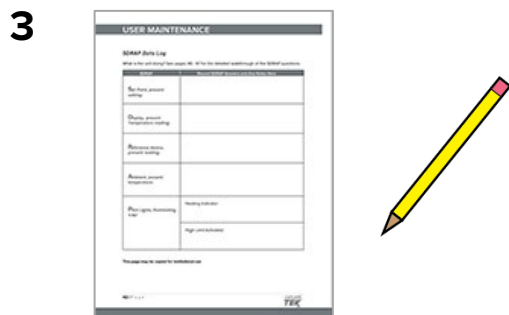

Record your observations in the Heating Diagnostic Log on page 48.



Unit Model Information

Find the unit data plate (see the Orientation Photos on pages 10 – 11 for the location) and record the information on it below. This information is critical for accurate diagnoses as displays, gauges, valves, and port types vary based on the unit model and customization options.

MODEL NO:	
SERIAL NO:	
PART NO:	
PART ID:	

Note: Does the car actually have gas in the tank? Have you physically verified the computer is plugged in? Yes, we are going to ask some very basic questions. Please bear with us. Methodical verifications and the elimination of potential failure causes are often the quickest means of getting a unit back into operation.

Verify the Unit Conditions

Verify the following items to make sure the unit is actually malfunctioning.

Condition Checks	Condition Data Location	Record Results Here
<p>Ambient Conditions: Verify the room temperature falls within the required range.</p>	<p>See the Required Ambient Conditions topic on page 14. Operating the unit outside the specified room temperature range will adversely impact its temperature performance.</p>	<p>The room temperature falls within the required range: Yes or No?</p>
<p>Spacing Clearances: Verify there is enough ventilation spacing around the unit.</p>	<p>See the Required Clearances topic on page 14. Insufficient ventilation spacing may be adversely impacting temperature performance.</p>	<p>The oven has the minimum required clearance spacing around it: Yes or No?</p>
<p>Operating Range: Verify the oven is designed to achieve the temperature you are attempting to run it at.</p>	<p>See the unit Temperature Specs on page 51. The oven will not operate outside the Range specification.</p>	<p>Are you attempting to operate the oven within the specified range: Yes or No?</p>
<p>Heat-up Time: Verify the oven has enough time to come up to temperature.</p>	<p>See the unit Temperature Specs on page 51. The oven will not heat up faster than the stated Time to Temperature specifications.</p>	<p>The oven is being allowed sufficient time to come up to temperature: Yes or No?</p>
<p>Stability and Uniformity: Verify the unit is rated to provide the stability and uniformity you are attempting to achieve.</p>	<p>See the unit Temperature Specs on page 51. The oven will not reliably achieve a better performance than the stated Uniformity and Stability specifications. *</p>	<p>You are attempting to achieve uniformity and / or stability matching the stated specifications: Yes or No?</p>

* The oven may require time to achieve the specified temperature stability and uniformity after heating up to or cooling down to an operating setpoint. This is affected by the ambient conditions around the oven, the mass of the product or samples in the oven chamber, as well as the volume of outgassing taking place. The longer the oven has been operating, the more heat soaked it is. This generally shortens the time for the temperature to stabilize.

MAINTENANCE

Required Item: Temperature reference device. A calibrated digital thermometer with wire thermocouple probes. The device must be accurate to at least 0.1°C.

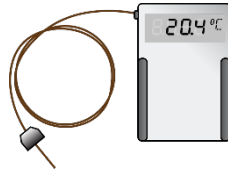

Preparing for the Heating Diagnostic Observations

1. The unit must be hardwired to a power source that meets the requirements in the Installation chapter (page 15) and turned on.



2. Verify that the intake and exhaust vents are both fully closed.



3. Secure the reference temperature device sensor probe at the center of the middle shelf, with the probe head 2 inches above the shelf surface.

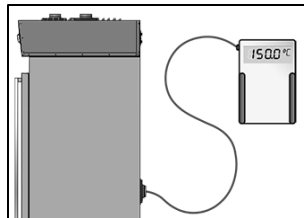

4. The unit must have adequate time to come up to temperature and stabilize. **Failure to wait will result in an inaccurate diagnosis.**



- See the oven Time to Temperature specifications on page 51.
- Start the Heating Diagnostic Questions **when the allotted time has passed**, even if the unit fails to achieve the setpoint temperature.

MAINTENANCE

Heating Diagnostic Questions

Record the answers in the log on page 48.

Setpoint?

What is the current temperature setpoint?

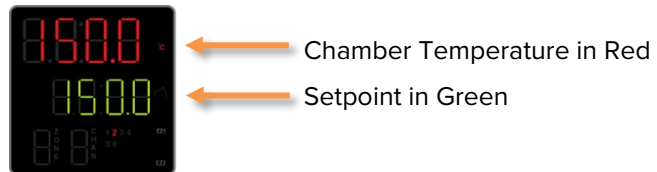

Chamber Temperature?

What temperature is presently showing on the temperature controller display?

Reference?

Optional: What temperature is the reference device presently showing for the chamber?

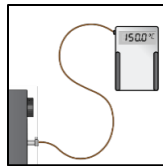

Heating Indicator On?

Is the heating active indicator on the temperature controller display flashing or otherwise illuminating, Y/N?

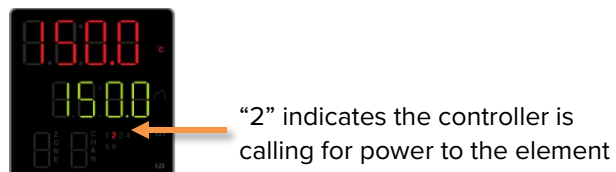

High Limit Activated?

Has the High Limit cutoff activated, Y/N?



Alternating alert screens flash when the high limit heating cutoff is active.

Ambient?

What is the current room temperature? For best results, measure the temperature in the same section of the room where the unit is located. Do not place your thermometer on the unit.

Heating Diagnostic Data Log

Record answers to the Heating Diagnostic questions in this log. These document the unit behavior.

Diagnostic Questions	Record Answers and Any Notes Here
S etpoint, present setting:	
C hamber Temperature, present reading:	
R eference Device, present reading:	
H eating Indicator On, Y/N?	
H igh Limit Activated, Y/N?	
A mbient, present temperature:	

Other valuable diagnostic resources to share:

- Datalogger data
- Pictures and video of the unit in failure mode
- How long has the temperature issue been occurring?

Share!

Share the Heating Diagnostic Data Log and Unit Specifications data with Customer Support. This data is crucial for offsite personnel making accurate remote diagnoses and is used to help ensure Customer Support can resolve the issue.

Facilities Technicians

The Heating Diagnostic Log and Unit Specifications data are also useful to any institutional repair technicians at your facility who may be responsible for servicing of out-of-warranty units.

This page may be copied for institutional use

End Diagnostic Data Procedure

UNIT SPECIFICATIONS

These ovens are 220 – 240 voltage single phase units. Please refer to the oven data plate for individual electrical specifications.

Technical data specified applies to units with standard equipment at an ambient temperature of 25°C and at nominal voltage. The temperatures specified are determined in accordance with factory standard following DIN 12880 respecting the recommended wall clearances of 10% of the height, width, and depth of the inner chamber. All indications are average values, typical for units produced in the series. We reserve the right to alter technical specifications at all times.

WEIGHT

Model	Shipping	Net
SMO10HP-2	450 lb / 204 kg	357.0 lb / 163.0 kg
SMO28HP-2	694 lb / 315 kg	569.4 lb / 258.3 kg

DIMENSIONS

By Inches

Model	Exterior W × D × H	Interior W × D × H
SMO10HP-2	44.1 x 29.9 x 56.7 in	29.8 x 20.6 x 30.0 in
SMO28HP-2	42.5 x 34.1 x 85.9 in	31.7 x 26.0 x 60.9 in

By Millimeters

Model	Exterior W × D × H	Interior W × D × H
SMO10HP-2	1121 x 760 x 1440 mm	757 x 524 x 762 mm
SMO28HP-2	1080 x 866 x 2182 mm	805 x 660 x 1546 mm

SPECIFICATIONS

CAPACITY

Model	Cubic Feet	Liters
SMO10HP-2	10.6	301.0
SMO28HP-2	28.0	792.0

Shelf Capacity by Weight

Model	Per Shelf	Total
SMO10HP-2	75.0 lb / 34.0 kg	225.0 lb / 102.0 kg
SMO28HP-2	75.0 lb / 34.0 kg	450.0 lb / 204.0 kg

AIR FLOW PERFORMANCE

Ventilation Rates

Model	Cubic Feet per Minute @80°C	Liters per Minute @80°C
SMO10HP-2	51	1444
SMO28HP-2	44	1246

Air Changes per Hour

Model	@80°C
SMO10HP-2	304
SMO28HP-2	95

Air Velocity Across Shelf Space

Model	Linear Feet per Minute	Meters per Minute
SMO10HP-2	144	43.9
SMO28HP-2	476	145

SPECIFICATIONS

TEMPERATURE PERFORMANCE

Range

Model	Operating Range
SMO10HP-2	Ambient +15° to 306°C
SMO28HP-2	Ambient +15° to 306°C

Uniformity

Model	@80°C	@150°C	@306°C
SMO10HP-2	±1.5°C	±2.5°C	±5.5°C
SMO28HP-2	±1.5°C	±2.5°C	±5.5°C

Stability

Model	@80°C	@150°C	@306°C
SMO10HP-2	±0.2°C	±0.3°C	±0.4°C
SMO28HP-2	±0.2°C	±0.3°C	±0.4°C

Heat Up Times from Ambient (25°C)

Model	To 80°C	To 150°C	To 306°C
SMO10HP-2	6 minutes	14 minutes	31 minutes
SMO28HP-2	6 minutes	15 minutes	31 minutes

Continued next page

SPECIFICATIONS

Temperature Performance Continued

Recovery Times from a 30 Second Door Opening

Model	@ 80°C	@ 150°C	@ 306°C
SMO10HP-2	3 minutes	3 minutes	6 minutes
SMO28HP-2	3 minutes	3 minutes	5 minutes





Recovery Times from a 60 Second Door Opening

Model	@ 80°C	@ 150°C	@ 306°C
SMO10HP-2	5 minutes	6 minutes	10 minutes
SMO28HP-2	5 minutes	5.5 minutes	10 minutes

POWER

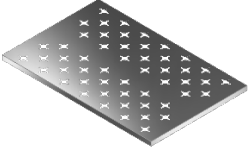
Model	AC Voltage	Amperage	Frequency	Phase
SMO10HP-2	220 – 240	26	50/60 Hz	1
SMO28HP-2	220 – 240	50	50/60 Hz	1

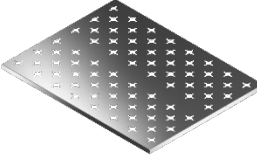
PARTS LIST

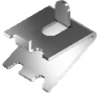
Description	Parts Number	Description	Parts Number
Adjustable Leveling Feet	 2700506	Shelf Assembly, 19 x 29", SMO10HP-2	 995-00007
Door Gasket Fiberglass with clips, 1ft section SMO10HP-2 (requires 11.5 feet) SMO28HP-2 (requires 17 feet)	 3450642	Shelf Assembly, 23 x 31, SMO28HP-2	 995-00005
Power Exhaust Blower Unit, 220 Volt, all models	 9990741	Shelf Clip, 1	 1250512

Ordering

Accessories and replacement parts can be ordered online at parts.sheldonmfg.com.

If the required item is not listed online, or if you require assistance in determining which part or accessory you need contact SHEL LAB by emailing parts@sheldonmfg.com or by calling 1-800-322-4897 ext. 3 or (503) 640-3000 ext. 3.

Please have the **Model**, **Serial**, and **Part** numbers, and the **Part ID** of the unit ready. Customer Support needs this information to match your unit to its correct part.



P.O. Box 627
Cornelius, OR 97113
USA

support@sheldonmfg.com
sheldonmanufacturing.com

1-800-322-4897
(503) 640-3000
FAX: 503 640-1366