

# R&S<sup>®</sup> RT-ZC30 Current Probe User Manual



1409.7872.02 – 02

This manual describes the following R&S products:

- R&S®RT-ZC30, Current Probe (1409.7772.02)
- R&S®RT-ZA13, Probe Power Supply (1409.7789.02)

© 2017 Rohde & Schwarz GmbH & Co. KG

Mühlhofstr. 15, 81671 München, Germany

Phone: +49 89 41 29 - 0

Fax: +49 89 41 29 12 164

Email: [info@rohde-schwarz.com](mailto:info@rohde-schwarz.com)

Internet: [www.rohde-schwarz.com](http://www.rohde-schwarz.com)

Subject to change – Data without tolerance limits is not binding.

R&S® is a registered trademark of Rohde & Schwarz GmbH & Co. KG.

Trade names are trademarks of their owners.

The following abbreviations are used in this manual: R&S®RT-ZC30 is abbreviated as R&S RT-ZC30.

# Basic Safety Instructions

## Always read through and comply with the following safety instructions!

All plants and locations of the Rohde & Schwarz group of companies make every effort to keep the safety standards of our products up to date and to offer our customers the highest possible degree of safety. Our products and the auxiliary equipment they require are designed, built and tested in accordance with the safety standards that apply in each case. Compliance with these standards is continuously monitored by our quality assurance system. The product described here has been designed, built and tested in accordance with the EC Certificate of Conformity and has left the manufacturer's plant in a condition fully complying with safety standards. To maintain this condition and to ensure safe operation, you must observe all instructions and warnings provided in this manual. If you have any questions regarding these safety instructions, the Rohde & Schwarz group of companies will be happy to answer them.

Furthermore, it is your responsibility to use the product in an appropriate manner. This product is designed for use solely in industrial and laboratory environments or, if expressly permitted, also in the field and must not be used in any way that may cause personal injury or property damage. You are responsible if the product is used for any purpose other than its designated purpose or in disregard of the manufacturer's instructions. The manufacturer shall assume no responsibility for such use of the product.

The product is used for its designated purpose if it is used in accordance with its product documentation and within its performance limits (see data sheet, documentation, the following safety instructions). Using the product requires technical skills and, in some cases, a basic knowledge of English. It is therefore essential that only skilled and specialized staff or thoroughly trained personnel with the required skills be allowed to use the product. If personal safety gear is required for using Rohde & Schwarz products, this will be indicated at the appropriate place in the product documentation. Keep the basic safety instructions and the product documentation in a safe place and pass them on to the subsequent users.











Observing the safety instructions will help prevent personal injury or damage of any kind caused by dangerous situations. Therefore, carefully read through and adhere to the following safety instructions before and when using the product. It is also absolutely essential to observe the additional safety instructions on personal safety, for example, that appear in relevant parts of the product documentation. In these safety instructions, the word "product" refers to all merchandise sold and distributed by the Rohde & Schwarz group of companies, including instruments, systems and all accessories. For product-specific information, see the data sheet and the product documentation.

## Safety labels on products

The following safety labels are used on products to warn against risks and dangers.

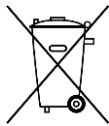
Symbol	Meaning	Symbol	Meaning
	Notice, general danger location Observe product documentation		ON/OFF Power
	Caution when handling heavy equipment		Standby indication
	Danger of electric shock		Direct current (DC)

## Basic Safety Instructions

Symbol	Meaning	Symbol	Meaning
	Caution ! Hot surface		Alternating current (AC)
	Protective conductor terminal To identify any terminal which is intended for connection to an external conductor for protection against electric shock in case of a fault, or the terminal of a protective earth		Direct/alternating current (DC/AC)
	Earth (Ground)		Class II Equipment to identify equipment meeting the safety requirements specified for Class II equipment (device protected by double or reinforced insulation)
	Frame or chassis Ground terminal		EU labeling for batteries and accumulators For additional information, see section "Waste disposal/Environmental protection", item 1.
	Be careful when handling electrostatic sensitive devices		EU labeling for separate collection of electrical and electronic devices For additional information, see section "Waste disposal/Environmental protection", item 2.
	Warning! Laser radiation For additional information, see section "Operation", item 7.		

### Signal words and their meaning

The following signal words are used in the product documentation in order to warn the reader about risks and dangers.



Indicates a hazardous situation which, if not avoided, will result in death or serious injury.



Indicates a hazardous situation which, if not avoided, could result in death or serious injury.



Indicates a hazardous situation which, if not avoided, could result in minor or moderate injury.



Indicates information considered important, but not hazard-related, e.g. messages relating to property damage.

In the product documentation, the word ATTENTION is used synonymously.

These signal words are in accordance with the standard definition for civil applications in the European Economic Area. Definitions that deviate from the standard definition may also exist in other economic areas or military applications. It is therefore essential to make sure that the signal words described here are always used only in connection with the related product documentation and the related product. The use of signal words in connection with unrelated products or documentation can result in misinterpretation and in personal injury or material damage.

## Basic Safety Instructions

### Operating states and operating positions

*The product may be operated only under the operating conditions and in the positions specified by the manufacturer, without the product's ventilation being obstructed. If the manufacturer's specifications are not observed, this can result in electric shock, fire and/or serious personal injury or death. Applicable local or national safety regulations and rules for the prevention of accidents must be observed in all work performed.*

1. Unless otherwise specified, the following requirements apply to Rohde & Schwarz products: predefined operating position is always with the housing floor facing down, IP protection 2X, use only indoors, max. operating altitude 2000 m above sea level, max. transport altitude 4500 m above sea level. A tolerance of  $\pm 10\%$  shall apply to the nominal voltage and  $\pm 5\%$  to the nominal frequency, overvoltage category 2, pollution degree 2.
2. Do not place the product on surfaces, vehicles, cabinets or tables that for reasons of weight or stability are unsuitable for this purpose. Always follow the manufacturer's installation instructions when installing the product and fastening it to objects or structures (e.g. walls and shelves). An installation that is not carried out as described in the product documentation could result in personal injury or even death.
3. Do not place the product on heat-generating devices such as radiators or fan heaters. The ambient temperature must not exceed the maximum temperature specified in the product documentation or in the data sheet. Product overheating can cause electric shock, fire and/or serious personal injury or even death.

### Electrical safety

*If the information on electrical safety is not observed either at all or to the extent necessary, electric shock, fire and/or serious personal injury or death may occur.*

1. Prior to switching on the product, always ensure that the nominal voltage setting on the product matches the nominal voltage of the mains-supply network. If a different voltage is to be set, the power fuse of the product may have to be changed accordingly.
2. In the case of products of safety class I with movable power cord and connector, operation is permitted only on sockets with a protective conductor contact and protective conductor.
3. Intentionally breaking the protective conductor either in the feed line or in the product itself is not permitted. Doing so can result in the danger of an electric shock from the product. If extension cords or connector strips are implemented, they must be checked on a regular basis to ensure that they are safe to use.
4. If there is no power switch for disconnecting the product from the mains, or if the power switch is not suitable for this purpose, use the plug of the connecting cable to disconnect the product from the mains. In such cases, always ensure that the power plug is easily reachable and accessible at all times. For example, if the power plug is the disconnecting device, the length of the connecting cable must not exceed 3 m. Functional or electronic switches are not suitable for providing disconnection from the AC supply network. If products without power switches are integrated into racks or systems, the disconnecting device must be provided at the system level.
5. Never use the product if the power cable is damaged. Check the power cables on a regular basis to ensure that they are in proper operating condition. By taking appropriate safety measures and carefully laying the power cable, ensure that the cable cannot be damaged and that no one can be hurt by, for example, tripping over the cable or suffering an electric shock.

## Basic Safety Instructions

6. The product may be operated only from TN/TT supply networks fuse-protected with max. 16 A (higher fuse only after consulting with the Rohde & Schwarz group of companies).
7. Do not insert the plug into sockets that are dusty or dirty. Insert the plug firmly and all the way into the socket provided for this purpose. Otherwise, sparks that result in fire and/or injuries may occur.
8. Do not overload any sockets, extension cords or connector strips; doing so can cause fire or electric shocks.
9. For measurements in circuits with voltages  $V_{rms} > 30$  V, suitable measures (e.g. appropriate measuring equipment, fuse protection, current limiting, electrical separation, insulation) should be taken to avoid any hazards.
10. Ensure that the connections with information technology equipment, e.g. PCs or other industrial computers, comply with the IEC 60950-1 / EN 60950-1 or IEC 61010-1 / EN 61010-1 standards that apply in each case.
11. Unless expressly permitted, never remove the cover or any part of the housing while the product is in operation. Doing so will expose circuits and components and can lead to injuries, fire or damage to the product.
12. If a product is to be permanently installed, the connection between the protective conductor terminal on site and the product's protective conductor must be made first before any other connection is made. The product may be installed and connected only by a licensed electrician.
13. For permanently installed equipment without built-in fuses, circuit breakers or similar protective devices, the supply circuit must be fuse-protected in such a way that anyone who has access to the product, as well as the product itself, is adequately protected from injury or damage.
14. Use suitable overvoltage protection to ensure that no overvoltage (such as that caused by a bolt of lightning) can reach the product. Otherwise, the person operating the product will be exposed to the danger of an electric shock.
15. Any object that is not designed to be placed in the openings of the housing must not be used for this purpose. Doing so can cause short circuits inside the product and/or electric shocks, fire or injuries.
16. Unless specified otherwise, products are not liquid-proof (see also section "Operating states and operating positions", item 1). Therefore, the equipment must be protected against penetration by liquids. If the necessary precautions are not taken, the user may suffer electric shock or the product itself may be damaged, which can also lead to personal injury.
17. Never use the product under conditions in which condensation has formed or can form in or on the product, e.g. if the product has been moved from a cold to a warm environment. Penetration by water increases the risk of electric shock.
18. Prior to cleaning the product, disconnect it completely from the power supply (e.g. AC supply network or battery). Use a soft, non-linting cloth to clean the product. Never use chemical cleaning agents such as alcohol, acetone or diluents for cellulose lacquers.

## Operation

1. Operating the products requires special training and intense concentration. Make sure that persons who use the products are physically, mentally and emotionally fit enough to do so; otherwise, injuries or material damage may occur. It is the responsibility of the employer/operator to select suitable personnel for operating the products.

## Basic Safety Instructions

2. Before you move or transport the product, read and observe the section titled "Transport".
3. As with all industrially manufactured goods, the use of substances that induce an allergic reaction (allergens) such as nickel cannot be generally excluded. If you develop an allergic reaction (such as a skin rash, frequent sneezing, red eyes or respiratory difficulties) when using a Rohde & Schwarz product, consult a physician immediately to determine the cause and to prevent health problems or stress.
4. Before you start processing the product mechanically and/or thermally, or before you take it apart, be sure to read and pay special attention to the section titled "Waste disposal/Environmental protection", item 1.
5. Depending on the function, certain products such as RF radio equipment can produce an elevated level of electromagnetic radiation. Considering that unborn babies require increased protection, pregnant women must be protected by appropriate measures. Persons with pacemakers may also be exposed to risks from electromagnetic radiation. The employer/operator must evaluate workplaces where there is a special risk of exposure to radiation and, if necessary, take measures to avert the potential danger.
6. Should a fire occur, the product may release hazardous substances (gases, fluids, etc.) that can cause health problems. Therefore, suitable measures must be taken, e.g. protective masks and protective clothing must be worn.
7. Laser products are given warning labels that are standardized according to their laser class. Lasers can cause biological harm due to the properties of their radiation and due to their extremely concentrated electromagnetic power. If a laser product (e.g. a CD/DVD drive) is integrated into a Rohde & Schwarz product, absolutely no other settings or functions may be used as described in the product documentation. The objective is to prevent personal injury (e.g. due to laser beams).
8. EMC classes (in line with EN 55011/CISPR 11, and analogously with EN 55022/CISPR 22, EN 55032/CISPR 32)
  - Class A equipment:  
Equipment suitable for use in all environments except residential environments and environments that are directly connected to a low-voltage supply network that supplies residential buildings  
Note: Class A equipment is intended for use in an industrial environment. This equipment may cause radio disturbances in residential environments, due to possible conducted as well as radiated disturbances. In this case, the operator may be required to take appropriate measures to eliminate these disturbances.
  - Class B equipment:  
Equipment suitable for use in residential environments and environments that are directly connected to a low-voltage supply network that supplies residential buildings

### Repair and service

1. The product may be opened only by authorized, specially trained personnel. Before any work is performed on the product or before the product is opened, it must be disconnected from the AC supply network. Otherwise, personnel will be exposed to the risk of an electric shock.

## Basic Safety Instructions

- Adjustments, replacement of parts, maintenance and repair may be performed only by electrical experts authorized by Rohde & Schwarz. Only original parts may be used for replacing parts relevant to safety (e.g. power switches, power transformers, fuses). A safety test must always be performed after parts relevant to safety have been replaced (visual inspection, protective conductor test, insulation resistance measurement, leakage current measurement, functional test). This helps ensure the continued safety of the product.

### Batteries and rechargeable batteries/cells

*If the information regarding batteries and rechargeable batteries/cells is not observed either at all or to the extent necessary, product users may be exposed to the risk of explosions, fire and/or serious personal injury, and, in some cases, death. Batteries and rechargeable batteries with alkaline electrolytes (e.g. lithium cells) must be handled in accordance with the EN 62133 standard.*

- Cells must not be taken apart or crushed.
- Cells or batteries must not be exposed to heat or fire. Storage in direct sunlight must be avoided. Keep cells and batteries clean and dry. Clean soiled connectors using a dry, clean cloth.
- Cells or batteries must not be short-circuited. Cells or batteries must not be stored in a box or in a drawer where they can short-circuit each other, or where they can be short-circuited by other conductive materials. Cells and batteries must not be removed from their original packaging until they are ready to be used.
- Cells and batteries must not be exposed to any mechanical shocks that are stronger than permitted.
- If a cell develops a leak, the fluid must not be allowed to come into contact with the skin or eyes. If contact occurs, wash the affected area with plenty of water and seek medical aid.
- Improperly replacing or charging cells or batteries that contain alkaline electrolytes (e.g. lithium cells) can cause explosions. Replace cells or batteries only with the matching Rohde & Schwarz type (see parts list) in order to ensure the safety of the product.
- Cells and batteries must be recycled and kept separate from residual waste. Rechargeable batteries and normal batteries that contain lead, mercury or cadmium are hazardous waste. Observe the national regulations regarding waste disposal and recycling.
- Follow the transport stipulations of the carrier (IATA-DGR, IMDG-Code, ADR, RID) when returning lithium batteries to Rohde & Schwarz subsidiaries.

### Transport

- The product may be very heavy. Therefore, the product must be handled with care. In some cases, the user may require a suitable means of lifting or moving the product (e.g. with a lift-truck) to avoid back or other physical injuries.
- Handles on the products are designed exclusively to enable personnel to transport the product. It is therefore not permissible to use handles to fasten the product to or on transport equipment such as cranes, fork lifts, wagons, etc. The user is responsible for securely fastening the products to or on the means of transport or lifting. Observe the safety regulations of the manufacturer of the means of transport or lifting. Noncompliance can result in personal injury or material damage.



## Instrucciones de seguridad elementales

3. If you use the product in a vehicle, it is the sole responsibility of the driver to drive the vehicle safely and properly. The manufacturer assumes no responsibility for accidents or collisions. Never use the product in a moving vehicle if doing so could distract the driver of the vehicle. Adequately secure the product in the vehicle to prevent injuries or other damage in the event of an accident.

### **Waste disposal/Environmental protection**

1. Specially marked equipment has a battery or accumulator that must not be disposed of with unsorted municipal waste, but must be collected separately. It may only be disposed of at a suitable collection point or via a Rohde & Schwarz customer service center.
2. Waste electrical and electronic equipment must not be disposed of with unsorted municipal waste, but must be collected separately.  
Rohde & Schwarz GmbH & Co. KG has developed a disposal concept and takes full responsibility for take-back obligations and disposal obligations for manufacturers within the EU. Contact your Rohde & Schwarz customer service center for environmentally responsible disposal of the product.
3. If products or their components are mechanically and/or thermally processed in a manner that goes beyond their intended use, hazardous substances (heavy-metal dust such as lead, beryllium, nickel) may be released. For this reason, the product may only be disassembled by specially trained personnel. Improper disassembly may be hazardous to your health. National waste disposal regulations must be observed.
4. If handling the product releases hazardous substances or fuels that must be disposed of in a special way, e.g. coolants or engine oils that must be replenished regularly, the safety instructions of the manufacturer of the hazardous substances or fuels and the applicable regional waste disposal regulations must be observed. Also observe the relevant safety instructions in the product documentation. The improper disposal of hazardous substances or fuels can cause health problems and lead to environmental damage.

For additional information about environmental protection, visit the Rohde & Schwarz website.

## Instructions for Electrostatic Discharge Protection

---

### **NOTICE**

#### **Risk of damaging electronic components**

To avoid damage of electronic components, the operational site must be protected against electrostatic discharge (ESD).

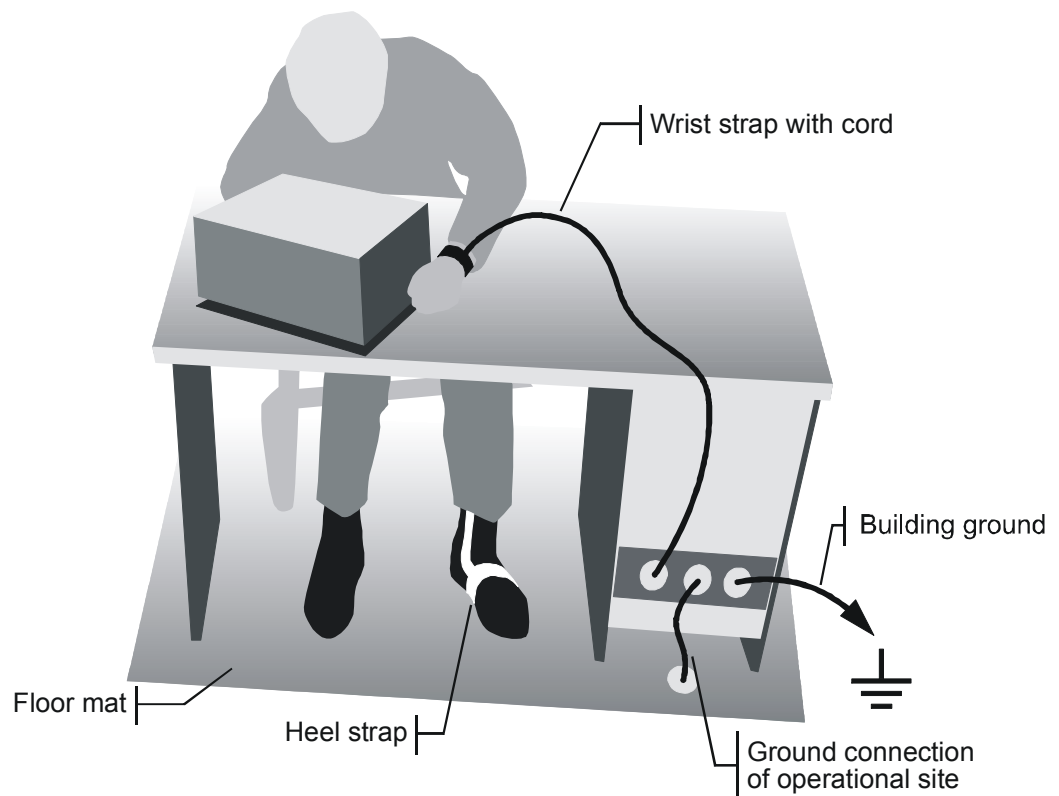

The following two methods of ESD protection may be used together or separately:

- Wrist strap with cord to ground connection
  - Conductive floor mat and heel strap combination
-

# Customer Support

## Technical support – where and when you need it

For quick, expert help with any Rohde & Schwarz equipment, contact one of our Customer Support Centers. A team of highly qualified engineers provides telephone support and will work with you to find a solution to your query on any aspect of the operation, programming or applications of Rohde & Schwarz equipment.

## Up-to-date information and upgrades

To keep your instrument up-to-date and to be informed about new application notes related to your instrument, please send an e-mail to the Customer Support Center stating your instrument and your wish. We will take care that you will get the right information.

### Europe, Africa, Middle East

Phone +49 89 4129 12345  
[customersupport@rohde-schwarz.com](mailto:customersupport@rohde-schwarz.com)

### North America

Phone 1-888-TEST-RSA (1-888-837-8772)  
[customer.support@rsa.rohde-schwarz.com](mailto:customer.support@rsa.rohde-schwarz.com)

### Latin America

Phone +1-410-910-7988  
[customersupport.la@rohde-schwarz.com](mailto:customersupport.la@rohde-schwarz.com)

### Asia/Pacific

Phone +65 65 13 04 88  
[customersupport.asia@rohde-schwarz.com](mailto:customersupport.asia@rohde-schwarz.com)

### China

Phone +86-800-810-8228 /  
+86-400-650-5896  
[customersupport.china@rohde-schwarz.com](mailto:customersupport.china@rohde-schwarz.com)



# Contents

<b>1 Notes on Safety</b> .....	<b>5</b>
<b>2 Product Description</b> .....	<b>10</b>
2.1 Product Overview.....	10
2.2 Key Features.....	10
2.3 Inspecting the Contents.....	10
2.4 Description of the Probe.....	11
2.4.1 Probe Overview.....	11
2.4.2 Terminator.....	12
2.4.3 Sensor.....	13
2.4.4 Key and LEDs.....	14
<b>3 Measuring Procedure</b> .....	<b>16</b>
3.1 Preparing the Measurement.....	16
3.2 Demagnetizing and Zero Adjustment.....	19
3.3 Connecting the Probe to the DUT.....	20
3.4 Disconnecting the Probe from the DUT.....	25
3.5 Troubleshooting.....	26
<b>4 Maintenance and Service</b> .....	<b>28</b>
4.1 Service Strategy.....	28
4.2 Returning the Probe for Servicing.....	28
4.3 Cleaning.....	29
4.4 Calibration Interval.....	29
4.5 Discarding the Probe.....	29
<b>5 R&amp;S RT-ZA13 Probe Power Supply</b> .....	<b>30</b>



# 1 Notes on Safety

Thank you for purchasing the R&S RT-ZC30 current probe.

To obtain maximum performance from the device, please read this manual first, and keep it handy for future reference.

---

**⚠ WARNING****Risk of physical injury**

This device is designed to comply with IEC 61010 Safety Standards, and has been thoroughly tested for safety before shipment. However, mishandling during use could result in injury or death, and damage the device. Be certain that you understand the instructions and precautions in the manual before use.

---

Follow these precautions to ensure safe operation and to obtain the full benefits of the various functions.

**⚠ DANGER****Risk of fatal injury**

- To avoid electric shock, do not remove the device's cover. The internal components of the device carry high voltages and may become very hot during operation.
- To avoid electric shock and short circuits, never attach the clamp to bare, unisolated conductors.  
Make sure to measure at a location on an insulated wire where the insulation is sufficient for the circuit voltage.



- Be careful to avoid damaging the insulation surface while taking measurements.
- Refer to the derating characteristics when measuring current that includes a high-frequency component and never measure any current that exceeds the rated current. Use with high frequencies or strong magnetic fields may cause the device to become abnormally hot, resulting in fire, equipment damage, or burns.
- To prevent fire or damage of the measurement target and device as well as burns, exercise caution concerning the following when measuring high-frequency currents or currents that contain high-frequency components:
  - Eddy current loss may cause heating of the sensor head.
  - Dielectric heating may cause heating of cord insulation and other materials.
- Connect the probe only to the secondary side of a breaker, so the breaker can prevent an accident if a short circuit occurs. Never connect it to the primary side of a breaker, because unrestricted current flow could cause a serious accident if a short circuit occurs.
- Be sure to observe all operating precautions for the oscilloscope and other instruments to which this device is connected.

**⚠ DANGER****Risk of fatal injury**

- This device is made for use with the R&S RT-ZA13 probe power supply.
- When using a measurement instrument that does not provide isolation between its input terminals and chassis or other input terminals, please pay attention to the following points. If a signal is applied to an input terminal other than that to which this device is connected, do not connect the ground-side terminal to any nonground potential. Otherwise, short-circuit current flows through the R&S RT-ZA13 probe power supply, or this device from the ground terminal, which could cause an electrical accident or damage.

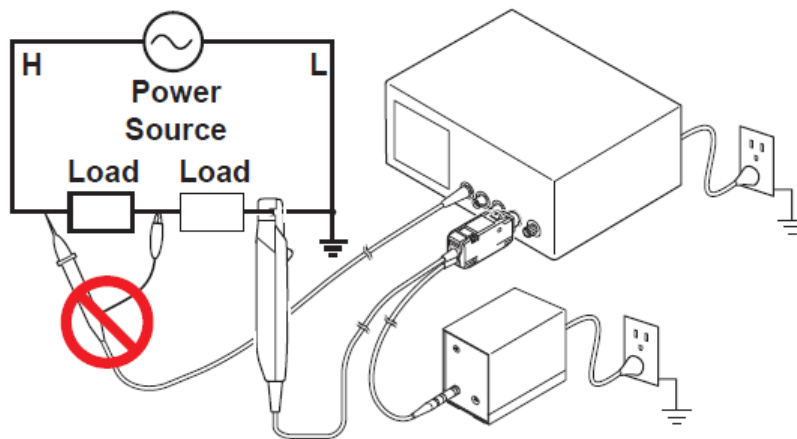
**⚠ WARNING****Shock hazard**

To avoid shock and short circuits, turn off all power before connecting the device.

Do not allow the device to get wet, and do not take measurements with wet hands. This may cause an electric shock.

To avoid electric shock when measuring live lines, wear appropriate protective gear, such as insulated rubber gloves, boots, and a safety helmet.



**NOTICE****Risk of instrument damage**

- To avoid damage to the device, protect it from vibration or shock during transport and handling, and be especially careful to avoid dropping.
- To avoid damage to the device, do not place the device on an unstable table or an inclined place. Dropping or knocking down the device can cause injury or damage to the device.
- Do not store or use the device where it could be exposed to direct sunlight, high temperature, humidity, or condensation. Under such conditions, the device may be damaged and insulation may deteriorate so that it no longer meets its specifications.
- Do not store or use the device near induction heating systems (such as high-frequency induction heating systems and IH cooking equipment)
- Before using the device the first time, verify that it operates normally to ensure that no damage occurred during storage or shipping. If you find any damage, contact your dealer or R&S representative.
- This device is not designed to be entirely water- or dust-proof. To avoid damage, do not use it in a wet or dusty environment.
- The sensor head is a precision assembly including a molded component, a ferrite core, and a Hall effect element. It may be damaged if subjected to sudden changes in ambient temperature, or mechanical strain or shock, and therefore great care should be exercised in handling it.
- Do not apply a static electricity or other source of high voltage to the sensor. Doing so may damage the internal Hall elements and circuitry of the sensor.
- The mating surfaces of the sensor head are precision, and should be treated with care. If these surfaces are scratched, performance may be impaired.
- Do not place foreign objects between the mating faces of the sensor head, insert foreign objects into the gaps of the sensor head, or touch the mating faces. Doing so may worsen the performances of the sensor or interfere with clamping action.
- While the POWER LED is on, keep the core section of the sensor closed, except when clamping it onto the conductor to be measured. The mating surface of the core section can be scratched while it is open.

- Keep the sensor head closed when not in use, to avoid accumulating dust or dirt on the mating core surfaces, which could interfere with clamp performance.
- Avoid stepping on or pinching the cable, which could damage the cable insulation.
- Keep the cable well away from heat sources, as bare conductors could be exposed if the insulation melts.
- Do not obstruct the ventilation holes on the sides and bottom of the terminator, as it could overheat and be damaged, or cause a fire.

**Strong electromagnetic fields**

Correct measurement may be impossible in the presence of strong magnetic fields, such as near transformers and high-current conductors, or in the presence of strong electromagnetic fields such as near radio transmitters.

## 2 Product Description

### 2.1 Product Overview

The R&S RT-ZC30 is an AC/DC current probe. It allows the user to make current measurements from DC to 120 MHz. By clamping on the conductor to be measured, the current waveform is captured easily without interrupting the electric circuit.

### 2.2 Key Features

- The sensor head has a clamp design that makes it possible to easily observe current waveforms while current continues to flow through the conductor being measured.
- LED warnings indicate overload and unlocked sensor head.
- You can observe low-current waveforms at the high sensitivity of 1 V/A.
- Broadband frequency characteristics DC to 120 MHz.
- Demagnetization and automatic zero adjustment functions make it easy to get ready for measurement.

### 2.3 Inspecting the Contents

- Inspect the package for damage.  
Keep a damaged package and the cushioning material until the contents have been checked for completeness and the device has been tested.  
If the packaging material shows any signs of stress, notify the carrier as well as your Rohde & Schwarz service center. Keep the package and cushioning material for inspection.
- Inspect the probe.  
If there is any damage or defect, or if the R&S RT-ZC30 current probe does not operate properly, notify your Rohde & Schwarz service center.
- Inspect the accessories.

## Description of the Probe

If the contents are incomplete or damaged, notify your Rohde & Schwarz service center.

The following accessories are delivered with the probe:

- User manual
- Carrying case
- R&S RT-Zxx datasheet
- Calibration certificate
- Documentation of calibrated values

## 2.4 Description of the Probe

### 2.4.1 Probe Overview

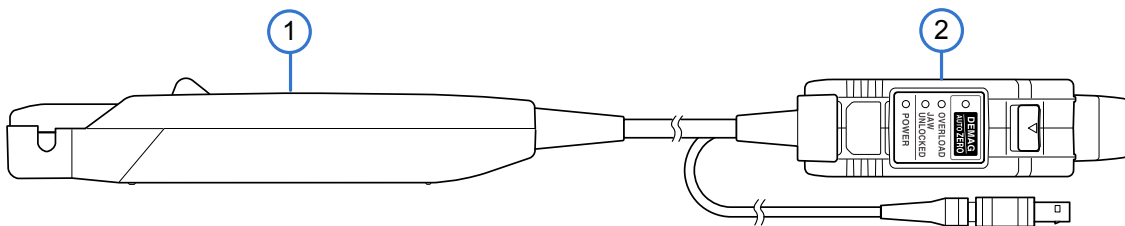

**Figure 2-1: Probe overview**

- 1 = Sensor
- 2 = Terminator

## 2.4.2 Terminator

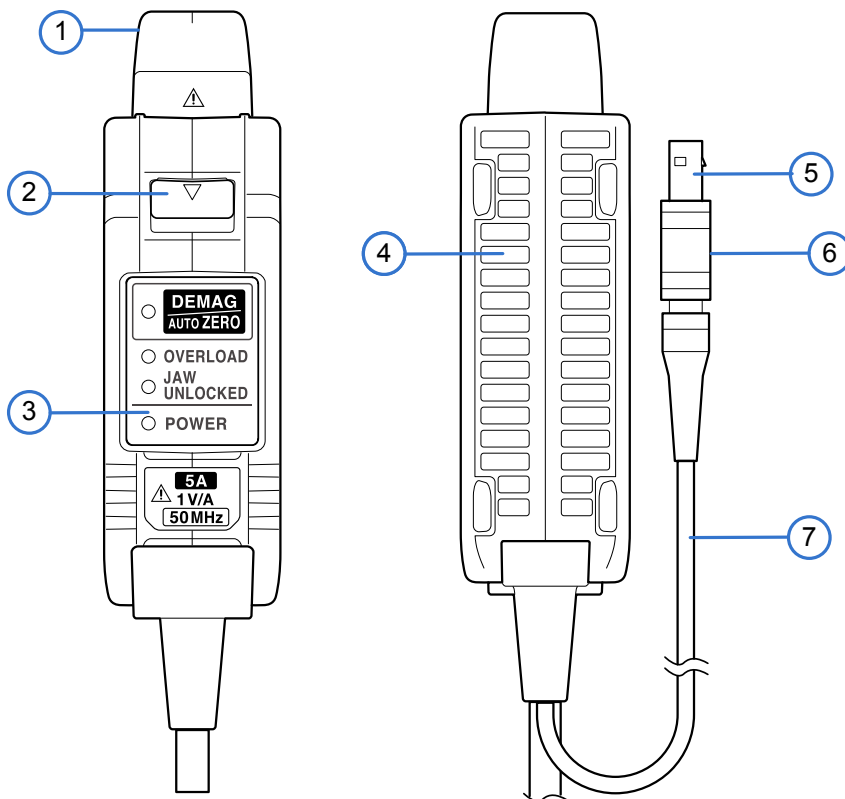

**Figure 2-2: Terminator overview**

- 1 = Output connector
- 2 = Unlock lever
- 3 = Key and LEDs
- 4 = Ventilation holes
- 5 = Power plug
- 6 = Shell
- 7 = Power supply cord

### Output connector

Connect to the BNC input connector of the waveform measuring instrument.

The current waveform of the measured conductor is output at a constant rate (1 V/A).

The terminator's output connector can be connected when the locking pin on the waveform measurement instrument's BNC input connector is in either the horizontal or vertical orientation.

### Unlock Lever

The lock mechanism keeps the clamp closed.

## Power plug

Connect the plug to the R&S RT-ZA13 probe power supply receptacle to supply power to the sensor.

## 2.4.3 Sensor

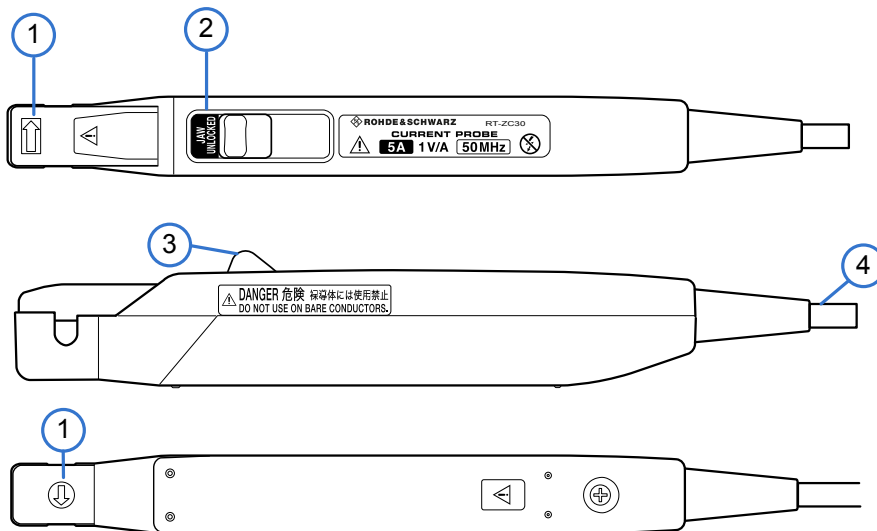

**Figure 2-3: Sensor overview**

- 1 = Current direction indication
- 2 = Jaw unlocked
- 3 = Opening lever
- 4 = Sensor cord

### Current direction indication

Clamp the device to the conductor so that the direction in which the current being measured is flowing matches the arrow.

### Opening lever

Operating lever for opening the sensor head. Always use this lever to open the sensor head.

### JAW UNLOCKED indication

If the sensor head is unlocked you can see this indication on the probe.

### Sensor head

The sensor head clamps on the conductor being measured, and carries out the actual current measurement.

## 2.4.4 Key and LEDs

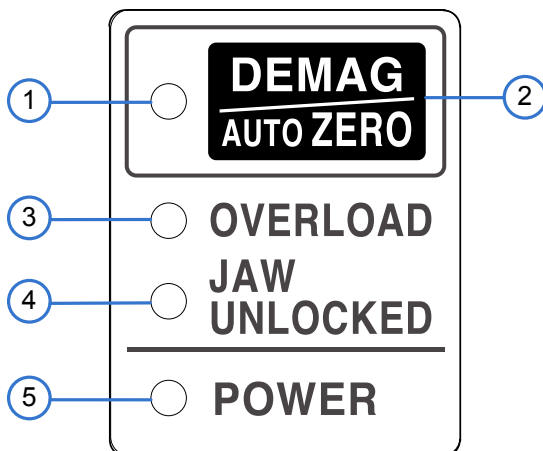

**Figure 2-4: Key and LEDs**

- 1 = DEMAG/AUTO ZERO LED
- 2 = DEMAG/AUTO ZERO Key
- 3 = OVERLOAD
- 4 = JAW UNLOCKED LED
- 5 = POWER LED

The key is used to perform demagnetization and zero adjustment, while the LEDs indicate the device status.

### **DEMAG/AUTO ZERO key**

Performs demagnetization and zero adjustment.

Press this key long (approx. 1 sec.) for demagnetization and zero adjustment.

Press this key short (within 0.5 sec.) for a zero adjustment only.

Demagnetization and zero adjustment cannot be performed in the following circumstances:

- The sensor head is unlocked (JAW UNLOCKED LED is lit up)
- During an overload condition (the OVERLOAD LED is flashing)
- When a measured current is detected

### **DEMAG/AUTO ZERO LED**

Shows the status of the demagnetization/zeroing process. The following states are defined:

## Description of the Probe

Color	State
Slow flashing orange	<ul style="list-style-type: none"> <li>• Before demagnetization and zero adjustment (when either can be performed)</li> <li>• After an overload is detected</li> <li>• When demagnetization terminated abnormally</li> </ul>
Orange	During demagnetization and zero adjustment process
Off	After demagnetization and zero adjustment is successfully completed

**OVERLOAD LED**

Shows the overload status of the system The following states are defined:

Color	State
Slow flashing red	Indicates that the maximum rated current is about to be reached. Exercise care so as not to exceed the rating.
Fast flashing red	Indicates that the maximum rated current is being exceeded. Remove the sensor from the measurement target immediately.

**JAW UNLOCKED LED**

The JAW UNLOCKED LED turns red (lighting up continuously) if the sensor head is not locked.

**POWER LED**

The POWER LED turns green (lighting up continuously) when the device is energized.



## 3 Measuring Procedure

### 3.1 Preparing the Measurement

#### NOTICE

##### Voltage check

When using a different power supply than the R&S RT-ZA13 probe power supply, before turning on the power, make sure that the voltage of the used power supply matches the supply voltage indicated in the data sheet "R&S RT-Zxx Oscilloscope Probes".



- The output of this device is terminated internally. Use a high impedance input of the measuring instrument. With an input impedance of  $50 \Omega$ , accurate measurement is not possible.
- If using BNC-banana plug adapters or similar to connect to input terminals other than BNC connectors, make sure the polarity is correct.
- Turn the collar until it clicks, and check that it is locked securely.

1. Have the R&S RT-ZA13 probe power supply, and an oscilloscope or waveform measuring instrument ready.
2. Turn the power switch off and connect the power cord.
3. Connect the power plug of the R&S RT-ZC30 to the power receptacle of the R&S RT-ZA13 probe power supply.

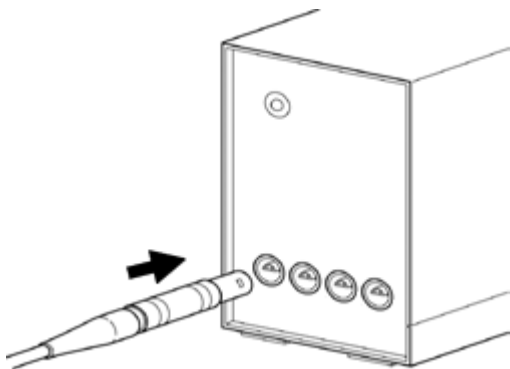

## Preparing the Measurement

4. Check that the conductor being measured is not clamped when supplying power to the R&S RT-ZC30. When power is turned on, a demagnetizing waveform is initially applied to the output. This is intentional in the design, and not a fault.
5. Turn the R&S RT-ZA13 probe power supply power switch on, and check that the front panel power indicator lights.  
The POWER LED lights up in green and the DEMAG/AUTO ZERO LED is slowly flashing in orange.

6. Connect the output connector of the R&S RT-ZC30 to one of the BNC input connectors of the oscilloscope. Turn the collar until it clicks, and check that it is locked securely.

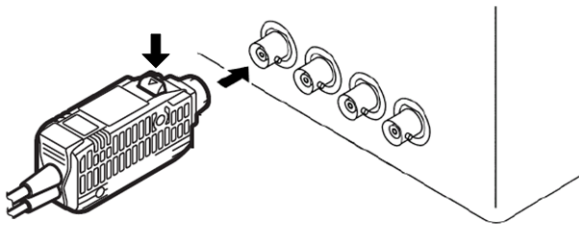

**Figure 3-1: Oscilloscope inputs**

The current waveform of the measured conductor is output at a constant rate (1 V/A).

7. Configure the probe connection at the oscilloscope. Make sure to set the following:
  - Vertical unit = Ampere
  - Coupling = DC
  - Termination = 1 M $\Omega$
  - Manual Gain = 1 V/A

Alternatively, select "Predefined probe" = R&S RT-ZC30 if this selection is available on the instrument.

The procedure depends on the used instrument and is described in the oscilloscope's user manual. Supported oscilloscopes are listed in the R&S RT-Zxx data sheet.

8. When disconnecting the output connector, be sure to release the lock before pulling off the connector. Forcibly pulling the connector without releasing the lock, or pulling on the cable can damage the terminator.

**NOTICE****Risk of instrument damage**

- Check that the conductor being measured is not clamped when supplying power to the device. A demagnetizing waveform may be generated when power is supplied, causing damage to components connected to the circuit being measured.
- To avoid damaging the terminator, keep it oriented in a straight line relative to the waveform measurement instrument when connecting and disconnecting it.

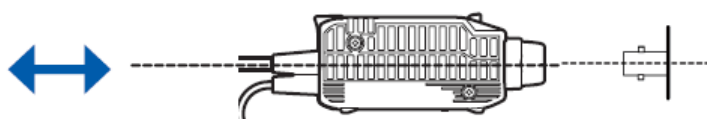

- To avoid damaging the output connector, pull the unlock lever toward you and then pull the connector out and away from the waveform measurement instrument.
- To avoid damaging the output connector of the terminator, or the BNC input terminal's locking mechanism on the waveform measuring instrument, do not rotate when both terminals are connected. Ensure that connections are not subject to stress.

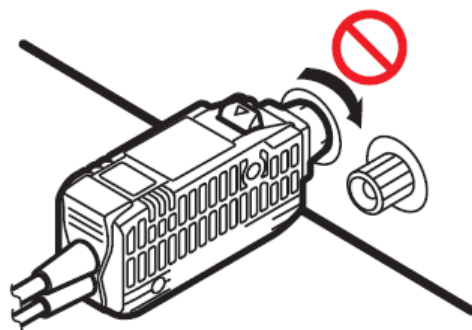

## 3.2 Demagnetizing and Zero Adjustment

### NOTICE

#### Risk of circuit damage

- Do not demagnetize while the R&S RT-ZC30 is clamping a conductor to be measured. Demagnetizing causes current to flow into the conductor, which may damage parts in the circuit to be measured.

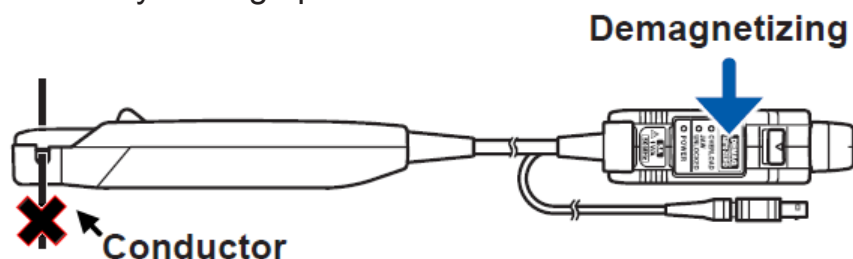

- Check that the conductor being measured is not clamped when supplying power to the R&S RT-ZC30. When power is turned on, a demagnetizing waveform is initially applied to the output. This is intentional in the design, and not a fault.

1. With the waveform measuring instrument input at ground, adjust the waveform to the zero position.
2. Connect the R&S RT-ZC30 current probe and configure the oscilloscope as described in [Chapter 3.1, "Preparing the Measurement"](#), on page 16.
3. Make sure that there is no conductor in the sensor aperture.
4. Press the opening lever until the JAW UNLOCK indication disappears, and check that the sensor head is properly closed.
5. Press and hold the DEMAG/ AUTO ZERO key for about 1 second. Zero-adjustment will be performed after demagnetization. The process takes about 20 seconds. During demagnetizing, a demagnetizing waveform is shown on the oscilloscope. The positive and negative components of this waveform may be asymmetrical.

**Note:** If the DEMAG/AUTO ZERO LED continues flashing instead of turning off when the DEMAG/AUTO ZERO key is pressed, demagnetization and zero adjustment did not complete normally.

**NOTICE****Risk of instrument damage**

When opening the sensor head, always operate the opening lever. Subjecting the sensor head to force from the directions shown in the figure while it is locked may damage the clamping mechanism.

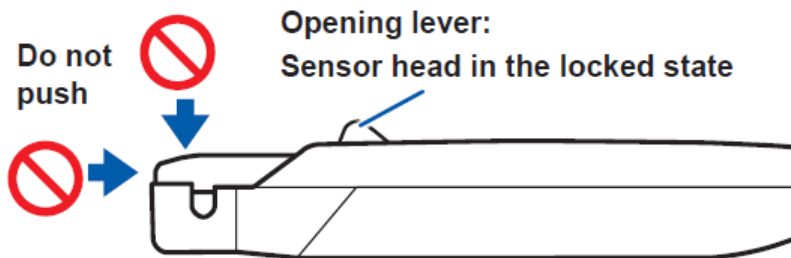

### 3.3 Connecting the Probe to the DUT

1. Check that the system is safe, and that the preparations described in the preceding sections have been carried out.
2. Pull the sensor opening lever, so that the sensor head opens.

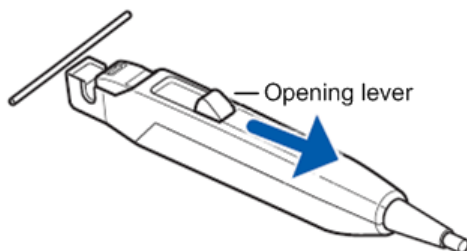

3. Align the sensor so that the current direction indication matches the direction of current flow through the conductor to be measured. The conductor should be in the center of the clamp aperture because the measurement may be affected by the position within the clamp aperture of the conductor being measured.
4. Press the opening lever until the JAW UNLOCKED indication disappears, and check that the sensor head is properly closed. The JAW UNLOCKED LED turns off.

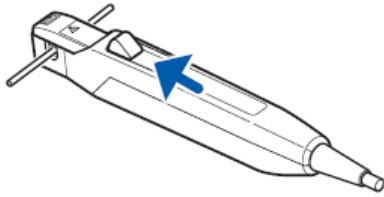

If the sensor head is not properly closed, accurate measurement is not possible.



- To measure DC or low-frequency current, multiple windings may be used to increase relative sensitivity (10 windings multiplies the measured current by a factor of 10). However, in this case, the windings should be made radially, with a diameter of at least 20 cm.

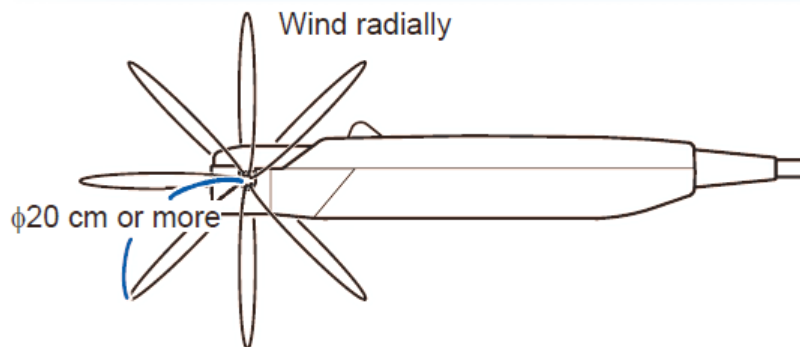

- Cord placement and the act of clamping the probe onto the conductor being measured may trigger load fluctuations, affecting the observed waveform.

**NOTICE****Risk of instrument damage due to continuous input current**

- The maximum continuous input range is based on heat that is internally generated during measurement. Always keep the input current below this level. Exceeding the rated level may result in damage to the probe.
- The maximum continuous input range varies according to the frequency of the current being measured. Refer to the data sheet "R&S RT-Zxx Oscilloscope Probes, Specifications"
- The device may sustain damage from self-heating even at current levels that are lower than the maximum rated current. The maximum rated current is a recommended value that assumes sine-wave input under standard conditions. Self-heating may happen if the ambient temperature increases or the measurement current waveform contains other frequency components.
- If the input current exceeds a certain level, generated heat activates a built-in safety function that blocks normal output. If this happens, remove the input immediately (remove the sensor from the conductor being measured, or reduce the input current to zero). Wait until the sensor has had sufficient time to cool before resuming operation.
- Even if the input current does not exceed the rated continuous maximum current, continuous input for an extended period of time may result in activation of the safety circuit to prevent damage resulting from heating of the sensor.

**NOTICE****Risk of instrument damage due to continuous input current**

- At high ambient temperatures, the built-in safety circuit may activate at current input levels below the rated continuous maximum current.
- Continuous input of current exceeding the rated maximum or repeated activation of the safety function may result in damage to the device.
- Current measurement exceeding approx. 1 kHz may result in temperature rise on the sensor-head. This is attributed to excitation loss that cannot be prevented due to natural physical principles. Be careful to avoid injury, electric shock due to short-circuits, or damage to the device that may be caused by the increased temperature.
- Do not place any unclamped conductor with an electric current of a frequency of 10 kHz or more near the sensor head. Current flowing in the conductor nearby may heat up the sensor head and cause its temperature to rise, leading to damage to the sensor. For example, when one side of a go-and-return conductor is clamped and the other side is also placed near the sensor head as shown in the diagram, even if the electric current is lower than the consecutive maximum current, electric currents in both sides will heat up the sensor and raise the temperature, thereby causing damage to the sensor.

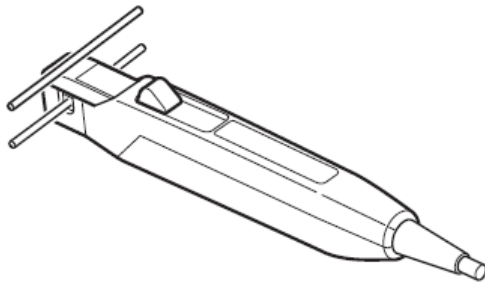





- Immediately after powering on, this device may be subject to an appreciable offset drift due to the effect of self-heating. To counteract this, allow the device to warm up for about 30 minutes before carrying out measurements.
- When performing continuous measurements, it is necessary to be aware that the offset voltage drifts, depending on factors such as the ambient temperature.
- Under certain circumstances, oscillation may occur while the power supply is on. This does not indicate a malfunction. Oscillation can be stopped and operation restored to normal by opening and closing the sensor head.
- Depending on the amplitude and frequency of the current being measured, the sensor head may emit a resonant sound. This sound may also occur during demagnetizing operation, but it does not represent a malfunction or device failure.

If foreign matter is adhered to the facing surfaces on the sensor head so that a slight gap exists between the upper and lower sensors, the sensor head may also emit a resonant sound. Remove any foreign matter using the cleaning method described in this manual.

An increase in the volume of the resonant sound during use may indicate that the gap between the upper and lower sensors has increased. Since the sensor characteristics may change, it is recommended to calibrate the device.

- i** At high frequencies, common mode noise may affect measurements taken on the high voltage side of circuits. If this occurs, reduce the frequency range of the waveform measuring instrument, or clamp onto the low-voltage side of the circuit, as appropriate.

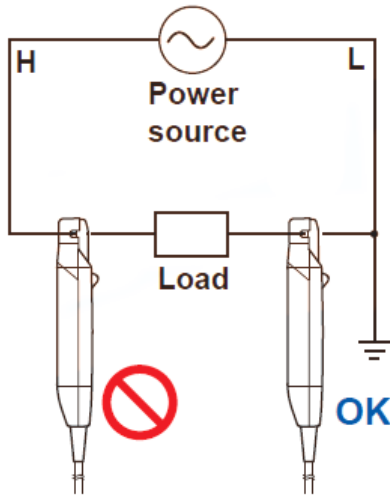

### 3.4 Disconnecting the Probe from the DUT

Once measurement has completed:

1. Pull the opening lever toward you and remove the device from the conductor being measured.
2. Disconnect the terminator from the waveform measurement instrument.
3. Turn the R&S RT-ZA13 probe power supply POWER switch off.
4. Remove the power plug of the device from the R&S RT-ZA13 probe power supply.
5. Unplug the R&S RT-ZA13 probe power supply power cord from the electrical outlet.

**NOTICE****Risk of instrument damage**

- To prevent wire breaks, do not pull on the cord to disconnect the output connector from the waveform measurement instrument. Always grip the terminator and pull the unlock lever toward you before disconnecting the connector.
- When disconnecting the device, grip the power supply plug's shell and do not pull on cords in order to prevent wiring breaks in the device's power cord or damage to R&S RT-ZA13 probe power supply.

### 3.5 Troubleshooting

You can determine the nature of an error by observing the device's LED. The following table explains possible error indications and their cause.

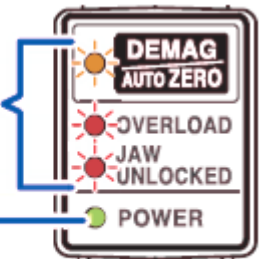
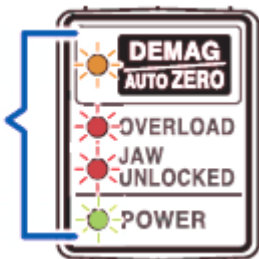
Error State	Meaning
<p>LEDs continue to flash quickly.</p> <p>LED is lit up continuously.</p> 	<p>A temperature anomaly has been detected due to heating caused by an overload.</p> <p>Remove the device from the conductor being measured immediately. Allow the device to cool under conditions of no input and then press the DEMAG/AUTO ZERO key. The device returns to its state when it was turned on.</p> <p>Start measurement after performing demagnetization and zero adjustment again. It is recommended to calibrate the device since internal components may have been subject to stress.</p>
<p>LEDs continue to flash quickly.</p> 	<p>An internal CPU malfunction (checksum error) has occurred. Send it to the service center for repair.</p>

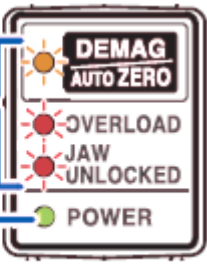
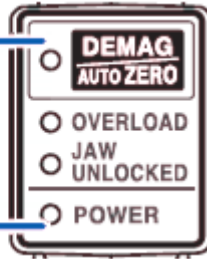
Error State	Meaning									
<p>LEDs flash quickly three times</p> <p>LED is lit up continuously.</p> 	<p>This issue occurs when the DEMAG/ AUTO ZERO key is pressed under the circumstances described in the table below.</p> <p>Demagnetization and automatic zero adjustment cannot be performed. Perform demagnetization and zero adjustment again after implementing the remedy described below.</p>	<table border="1"> <thead> <tr> <th data-bbox="715 573 938 663">Circumstances</th> <th data-bbox="938 573 1428 663">Remedy</th> </tr> </thead> <tbody> <tr> <td data-bbox="715 663 938 779">When the JAW UNLOCKED LED is lit up</td> <td data-bbox="938 663 1428 779">Lock the sensor head. (Press the opening lever until the JAW UNLOCKED indicator turns off.)</td> </tr> <tr> <td data-bbox="715 779 938 1077">When the OVERLOAD LED is flashing</td> <td data-bbox="938 779 1428 1077">Remove the device from the conductor being measured.</td> </tr> <tr> <td data-bbox="715 902 938 1077">When a current of 0.5 A (RMS) or greater has been detected</td> <td data-bbox="938 902 1428 1077"></td> </tr> </tbody> </table>	Circumstances	Remedy	When the JAW UNLOCKED LED is lit up	Lock the sensor head. (Press the opening lever until the JAW UNLOCKED indicator turns off.)	When the OVERLOAD LED is flashing	Remove the device from the conductor being measured.	When a current of 0.5 A (RMS) or greater has been detected	
Circumstances		Remedy								
When the JAW UNLOCKED LED is lit up		Lock the sensor head. (Press the opening lever until the JAW UNLOCKED indicator turns off.)								
When the OVERLOAD LED is flashing		Remove the device from the conductor being measured.								
When a current of 0.5 A (RMS) or greater has been detected										
<p>All LEDs off even though the device is receiving power</p> 	<p>The device has malfunctioned. Send it to the service center for repair.</p>									

## 4 Maintenance and Service

### 4.1 Service Strategy

Like all Rohde & Schwarz devices, Rohde & Schwarz probes are of high quality and require only minimum service and repair. However, if the probe needs to be serviced, contact your Rohde & Schwarz service center. Return a defective probe to the Rohde & Schwarz service center for diagnosis and exchange.

You can return the R&S RT-ZC30 current probe for calibration. The service personnel will perform the required tests.

### 4.2 Returning the Probe for Servicing

Use the original packaging to return your Rohde & Schwarz probe to your Rohde & Schwarz service center. A list of all service centers is available on [www.services.rohde-schwarz.com](http://www.services.rohde-schwarz.com).

If you cannot use the original packaging, consider the following:

1. Use a sufficiently sized box.
2. Protect the probe from damage and moisture (e.g. with bubble wrap).
3. Use some kind of protective material (e.g. crumpled newspaper) to stabilize the probe inside the box.
4. Seal the box with tape.
5. Address the package to your nearest Rohde & Schwarz service center.

## 4.3 Cleaning

### NOTICE

#### Device damage caused by cleaning agents

Cleaning agents contain substances that may damage the device; for example, solvent may damage the labeling or plastic parts.

Never use cleaning agents such as solvents (thinners, acetone, etc.), acids, bases or other substances

### NOTICE

#### Device damage caused by static electricity

Before cleaning the facing surfaces of the sensor head, discharge any static electricity at your hands. Thus you ensure that no high voltage caused by static electricity is applied to the device. Application of a high voltage to the device may damage the internal Hall elements or circuitry. You can attract static electricity to your hands by touching a nearby metal object.

To clean the exterior of the probe, use a soft cloth moistened with either distilled water or isopropyl alcohol. Before using the probe again, make sure to dry it completely.

## 4.4 Calibration Interval

The recommended calibration interval for R&S RT-ZC30 current probe is two years. For servicing, send the probe to your nearest Rohde & Schwarz service center (see [Chapter 4.2, "Returning the Probe for Servicing"](#), on page 28).

## 4.5 Discarding the Probe

Handle and dispose the probe in accordance with local regulations.

## 5 R&S RT-ZA13 Probe Power Supply

This unit is a special-purpose power supply for the R&S RT-ZC10 and R&S RT-ZC20 current probes.

You can connect up to four current probes to the power supply.

### Front view

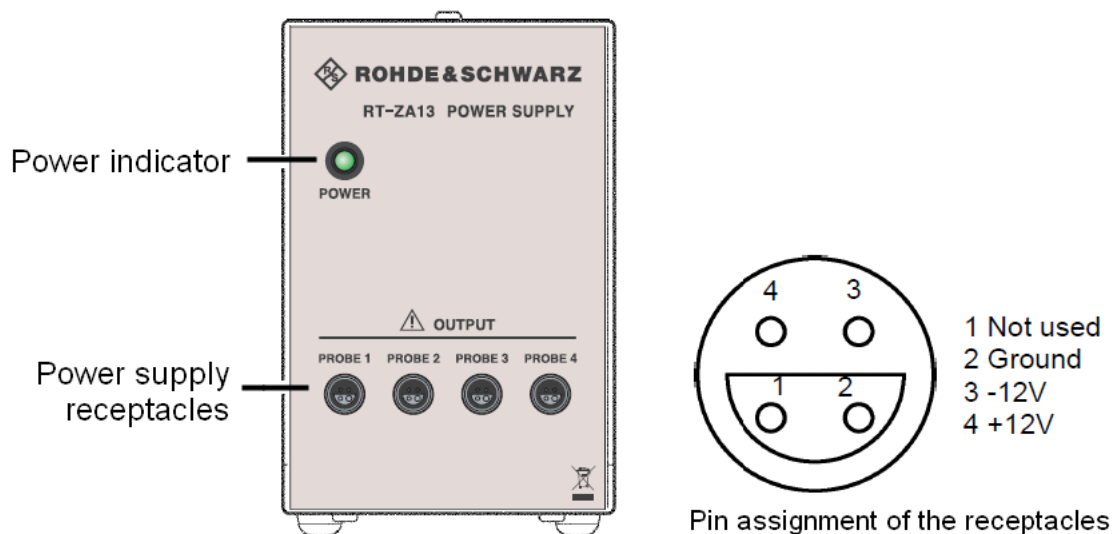

### Rear view

