

R&S®NRX Power Meter User Manual



1178556602
Version 09

ROHDE & SCHWARZ
Make ideas real



This manual describes the R&S®NRX (1424.7005K02) with firmware version FW 02.50 and later. In addition to the base unit, the following options are described:

- R&S®NRX-B1 (1424.7805K02)
- R&S®NRX-B4 (1424.8901K02)
- R&S®NRX-B8 (1424.8301K02)
- R&S®NRX-B9 (1424.8601K02)
- R&S®NRX-K2 (1424.9208K02)
- R&S®NRX-K4 (1424.9308K02)
- R&S®NRX-K301 (1444.0041K02)

© 2021 Rohde & Schwarz GmbH & Co. KG

Mühlhofstr. 15, 81671 München, Germany

Phone: +49 89 41 29 - 0

Email: info@rohde-schwarz.com

Internet: www.rohde-schwarz.com

Subject to change – data without tolerance limits is not binding.

R&S® is a registered trademark of Rohde & Schwarz GmbH & Co. KG.

Trade names are trademarks of the owners.

1178.5566.02 | Version 09 | R&S®NRX

Throughout this manual, products from Rohde & Schwarz are indicated without the ® symbol, e.g. R&S®NRX is indicated as R&S NRX.

Contents

1	Safety and regulatory information.....	11
1.1	Safety Instructions.....	11
1.2	Labels on the product.....	13
1.3	Warning messages in the documentation.....	14
1.4	Korea certification class B.....	14
2	Welcome.....	15
2.1	Documentation overview.....	15
2.1.1	Getting started manual.....	15
2.1.2	User manual.....	15
2.1.3	Instrument security procedures.....	15
2.1.4	Printed safety instructions.....	15
2.1.5	Data sheets and brochures.....	15
2.1.6	Release notes and open source acknowledgment (OSA).....	16
2.2	Key features.....	16
3	Getting started.....	17
3.1	Preparing for use.....	17
3.1.1	Lifting and carrying.....	17
3.1.2	Unpacking and checking.....	17
3.1.3	Choosing the operating site.....	17
3.1.4	Setting up the product.....	18
3.1.5	Considerations for test setup.....	20
3.1.6	Connecting to power.....	20
3.1.7	Connecting to LAN.....	21
3.1.8	Connecting power sensors.....	21
3.1.9	Connecting USB and external devices.....	23
3.1.10	Switching on or off.....	24
3.2	Instrument tour.....	25
3.2.1	Front panel tour.....	25
3.2.2	Rear panel tour.....	29
4	Operating concepts.....	33

4.1	Manual operation.....	33
4.1.1	Start dialog.....	33
4.1.2	Main measurement dialog.....	34
4.1.3	Status information.....	36
4.1.4	Notification center.....	37
4.1.5	Selecting the display layout.....	38
4.1.6	Swapping measurement panes.....	40
4.1.7	Editing parameters.....	41
4.1.8	Creating and saving screenshots.....	42
4.1.9	Restricting manual operation.....	42
4.2	Remote operation.....	43
4.3	Remote control.....	44
4.3.1	Switching to remote control (REMOTE).....	44
4.3.2	Returning to manual operation (LOCAL).....	45
5	Measurement basics.....	46
5.1	Parallel measurements.....	46
5.2	Sensor assignment and memory.....	46
5.3	Performing a measurement.....	48
5.4	Limit violation.....	49
5.5	Settings conflict.....	50
6	Measurement and display configuration.....	52
6.1	Configuration for all measurement types.....	52
6.1.1	Display settings.....	52
6.1.2	Controlling the measurement.....	62
6.1.3	Triggering.....	63
6.1.4	Measurement settings dialog.....	69
6.2	Continuous average.....	72
6.2.1	Continuous average result display.....	72
6.2.2	Continuous average settings.....	73
6.3	Burst average.....	74
6.3.1	Burst average result display.....	75
6.3.2	Burst average settings.....	75
6.4	Trace.....	76

6.4.1	Trace result display.....	76
6.4.2	Trace settings.....	77
6.4.3	Trace Marker dialog.....	78
6.5	Pulse analysis.....	81
6.5.1	Pulse analysis result display.....	82
6.5.2	Pulse analysis settings.....	82
6.5.3	Pulse Analysis dialog.....	83
6.6	Time gate.....	90
6.6.1	Time gate result display.....	91
6.6.2	Time gate settings.....	92
6.6.3	Gate Configuration dialog.....	94
6.7	Timeslot.....	95
6.7.1	Timeslot result display.....	96
6.7.2	Timeslot settings.....	98
6.7.3	Timeslot Configuration dialog.....	99
6.8	Statistics.....	101
6.8.1	Statistics result display.....	101
6.8.2	Statistics settings.....	103
6.8.3	Measurement Settings dialog.....	104
6.8.4	Scale Configuration dialog.....	105
6.8.5	Statistics Timing dialog.....	107
6.9	NRT.....	108
6.9.1	NRT result display.....	108
6.9.2	NRT settings.....	109
6.9.3	Measurement Main Configuration dialog.....	113
7	Sensor configuration.....	115
7.1	Mode settings.....	115
7.2	Correction settings.....	119
7.3	Filter settings.....	122
7.4	Range settings.....	126
7.5	NRT measurement type.....	128
7.5.1	NRT mode settings.....	129
7.5.2	NRT correction settings.....	130

7.5.3	NRT filter settings.....	132
8	Saving and recalling settings.....	134
9	Zeroing sensors.....	136
10	System settings.....	138
10.1	Connections.....	138
10.1.1	Network settings.....	139
10.1.2	Remote settings.....	142
10.1.3	Input/output settings (I/O).....	145
10.1.4	Sensor manager.....	151
10.2	Instrument info.....	154
10.2.1	System info.....	154
10.2.2	Security settings.....	157
10.2.3	Option settings.....	162
10.2.4	Help & copyrights.....	165
10.3	Hardware configuration.....	166
10.4	Test.....	167
10.5	Global settings.....	168
11	Option management.....	170
11.1	Installing a license key.....	170
12	Firmware update.....	171
12.1	Firmware update via PC and USB or ethernet connection.....	171
12.1.1	Hardware and software requirements.....	171
12.1.2	Preparing an update.....	172
12.1.3	Updating the application firmware.....	173
12.2	Firmware update via a USB flash memory stick.....	176
12.2.1	Hardware and software requirements.....	176
12.2.2	Preparing an update.....	176
12.2.3	Updating the application firmware.....	177
13	Remote control commands.....	178
13.1	Conventions used in SCPI command descriptions.....	178
13.2	Common commands.....	178

13.3	Addressing measurements and power sensors.....	187
13.4	Making measurements.....	188
13.4.1	Using MEASure?.....	188
13.4.2	Using CONFigure and READ?.....	189
13.4.3	Using CONFigure, INITiate and FETCH?.....	190
13.4.4	Configuring one setting at a time.....	190
13.4.5	Structure of combining commands.....	191
13.5	Starting and ending a measurement.....	193
13.6	Measurement settings and results.....	196
13.6.1	Configuring display and results.....	197
13.6.2	Configuring the trigger.....	229
13.6.3	Selecting the measurement.....	238
13.6.4	Selecting the power sensor.....	242
13.6.5	Relative measurements.....	243
13.6.6	Continuous average measurements.....	245
13.6.7	Burst average measurements.....	260
13.6.8	Trace measurements.....	269
13.6.9	Pulse analysis measurements.....	279
13.6.10	Time gate measurements.....	295
13.6.11	Timeslot measurements.....	297
13.6.12	Statistics measurements.....	309
13.6.13	NRT measurements.....	319
13.6.14	Querying measurement results.....	326
13.7	Calculation functions.....	328
13.7.1	Selecting a calculation function.....	328
13.8	Configuring sensors.....	330
13.8.1	Setting the frequency.....	330
13.8.2	Sensor modes.....	331
13.8.3	Sensor corrections.....	335
13.8.4	Sensor filters.....	340
13.8.5	Sensor ranges.....	348
13.8.6	Standardized signals.....	351
13.8.7	Frequency selective power sensors.....	364

13.8.8	NRT measurement type.....	366
13.9	Configuring the test generator.....	376
13.10	Configuring the analog signal output and the trigger input/output.....	378
13.11	Zeroing.....	387
13.12	Running selftests.....	389
13.13	Managing setups and correction tables.....	392
13.14	System information and configuration.....	399
13.14.1	Presetting.....	399
13.14.2	Shutdown and reboot.....	400
13.14.3	Firmware update.....	400
13.14.4	Network settings.....	403
13.14.5	Remote settings.....	406
13.14.6	Managing sensors.....	409
13.14.7	Instrument information.....	410
13.14.8	Date and time settings.....	412
13.14.9	Notifications and errors.....	415
13.14.10	Locking.....	419
13.15	Using the status register.....	419
13.15.1	General status register commands.....	419
13.15.2	Reading the CONDition part.....	420
13.15.3	Reading the EVENT part.....	421
13.15.4	Controlling the ENABLE part.....	421
13.15.5	Controlling the negative transition part.....	422
13.15.6	Controlling the positive transition part.....	423
13.16	Remote emulation.....	423
13.16.1	R&S NRP2 compatibility.....	424
14	Remote control basics.....	464
14.1	Remote control interfaces and protocols.....	464
14.1.1	USB interface.....	464
14.1.2	Ethernet interface.....	465
14.1.3	GPIB interface.....	468
14.2	SCPI command structure.....	468
14.2.1	Syntax for common commands.....	469

14.2.2	Syntax for device-specific commands.....	469
14.2.3	SCPI parameters.....	470
14.2.4	Overview of syntax elements.....	473
14.2.5	Structure of a command line.....	473
14.2.6	Responses to queries.....	474
14.3	Command sequence and synchronization.....	475
14.3.1	Preventing overlapping execution.....	475
14.4	Status reporting system.....	475
14.4.1	Hierarchy of the status registers.....	476
14.4.2	Structure of a SCPI status register.....	477
14.4.3	Status byte (STB) and service request enable register (SRE).....	479
14.4.4	IST flag and parallel poll enable register (PPE).....	480
14.4.5	Device status register.....	480
14.4.6	Questionable status register.....	482
14.4.7	Standard event status and enable register (ESR, ESE).....	486
14.4.8	Operation status register.....	487
15	Troubleshooting.....	497
15.1	Displaying information.....	497
15.2	Notifications.....	497
15.2.1	Interpreting notifications and their number.....	498
15.3	Performing tests.....	501
15.4	Collecting information for technical support.....	502
15.5	Contacting customer support.....	502
16	Transporting.....	503
17	Maintenance, storage and disposal.....	504
17.1	Cleaning.....	504
17.2	Storage.....	504
17.3	Disposal.....	504
	Glossary: List of abbreviations.....	505
	List of commands.....	507
	Index.....	526

1 Safety and regulatory information

The product documentation helps you use the product safely and efficiently. Follow the instructions provided here and in the following chapters.

Intended use

Combined with the supported R&S power sensors, the R&S NRX base unit is intended for power measurements in development and production. The supported R&S power sensors are listed in the data sheet. Observe the operating conditions and performance limits stated in the data sheet.

Target audience

The target audience is developers and technicians. The required skills and experience in power measurements depend on the used operating concept. While manual operation is suitable for beginners, remote control requires expertise in power measurements.

Depending on the used R&S power sensor, the applications vary greatly. A profound knowledge of the intended application and test setup is recommended.

Where do I find safety information?

Safety information is part of the product documentation. It warns you of potential dangers and gives instructions on how to prevent personal injury or damage caused by dangerous situations. Safety information is provided as follows:

- In [Chapter 1.1, "Safety Instructions"](#), on page 11. The same information is provided in many languages as printed "Safety Instructions". The printed "Safety Instructions" are delivered with the product.
- Throughout the documentation, safety instructions are provided when you need to take care during setup or operation.

1.1 Safety Instructions

Products from the Rohde & Schwarz group of companies are manufactured according to the highest technical standards. To use the products safely, follow the instructions provided here and in the product documentation. Keep the product documentation nearby and offer it to other users.

Use the product only for its intended use and within its performance limits. Intended use and limits are described in the product documentation such as the data sheet, manuals and the printed "Safety Instructions". If you are unsure about the appropriate use, contact Rohde & Schwarz customer service.

Using the product requires specialists or specially trained personnel. These users also need sound knowledge of at least one of the languages in which the user interfaces and the product documentation are available.

Never open the casing of the product. Only service personnel authorized by Rohde & Schwarz are allowed to repair the product. If any part of the product is damaged or broken, stop using the product. Contact Rohde & Schwarz customer service at <http://www.customersupport.rohde-schwarz.com>.

Lifting and carrying the product

The maximum weight of the product is provided in the data sheet. To move the product safely, you can use lifting or transporting equipment such as lift trucks and forklifts. Follow the instructions provided by the equipment manufacturer.

Choosing the operating site

Only use the product indoors. The product casing is not waterproof. Water that enters can electrically connect the casing with live parts, which can lead to electric shock, serious personal injury or death if you touch the casing. If Rohde & Schwarz provides accessories designed for your product, e.g. a carrying bag, you can use the product outdoors.

Unless otherwise specified, you can operate the product up to an altitude of 2000 m above sea level. The product is suitable for pollution degree 2 environments where nonconductive contamination can occur. For more information on environmental conditions such as ambient temperature and humidity, see the data sheet.

Setting up the product

Always place the product on a stable, flat and level surface with the bottom of the product facing down. If the product is designed for different positions, secure the product so that it cannot fall over.

If the product has foldable feet, always fold the feet completely in or out to ensure stability. The feet can collapse if they are not folded out completely or if the product is moved without lifting it. The foldable feet are designed to carry the weight of the product, but not an extra load.

If stacking is possible, keep in mind that a stack of products can fall over and cause injury.

If you mount products in a rack, ensure that the rack has sufficient load capacity and stability. Observe the specifications of the rack manufacturer. Always install the products from the bottom shelf to the top shelf so that the rack stands securely. Secure the product so that it cannot fall off the rack.

Connecting to power

The product is an overvoltage category II product. Connect the product to a fixed installation used to supply energy-consuming equipment such as household appliances and similar loads. Keep in mind that electrically powered products have risks, such as electric shock, fire, personal injury or even death.

Take the following measures for your safety:

- Before switching on the product, ensure that the voltage and frequency indicated on the product match the available power source. If the power adapter does not adjust automatically, set the correct value and check the rating of the fuse.





- Only use the power cable delivered with the product. It complies with country-specific safety requirements. Only insert the plug into an outlet with protective conductor terminal.
- Only use intact cables and route them carefully so that they cannot be damaged. Check the power cables regularly to ensure that they are undamaged. Also ensure that nobody can trip over loose cables.
- If the product needs an external power supply, use the power supply that is delivered with the product or that is recommended in the product documentation or a power supply that conforms to the country-specific regulations.
- Only connect the product to a power source with a fuse protection of maximum 20 A.
- Ensure that you can disconnect the product from the power source at any time. Pull the power plug to disconnect the product. The power plug must be easily accessible. If the product is integrated into a system that does not meet these requirements, provide an easily accessible circuit breaker at the system level.

Cleaning the product

Use a dry, lint-free cloth to clean the product. When cleaning, keep in mind that the casing is not waterproof. Do not use liquid cleaning agents.

Meaning of safety labels

Safety labels on the product warn against potential hazards.

	<p>Potential hazard</p> <p>Read the product documentation to avoid personal injury or product damage.</p>
	<p>Electrical hazard</p> <p>Indicates live parts. Risk of electric shock, fire, personal injury or even death.</p>
	<p>Hot surface</p> <p>Do not touch. Risk of skin burns. Risk of fire.</p>
	<p>Protective conductor terminal</p> <p>Connect this terminal to a grounded external conductor or to protective ground. This connection protects you against electric shock if an electric problem occurs.</p>

1.2 Labels on the product

Labels on the casing inform about:

- Personal safety, see ["Meaning of safety labels"](#) on page 13
- Environment safety, see [Table 1-1](#)
- Identification of the product, see [Chapter 3.2.2.7, "Name plate"](#), on page 31.

Table 1-1: Labels regarding environment safety

	<p>Labeling in line with EN 50419 for disposal of electrical and electronic equipment after the product has come to the end of its service life.</p> <p>For more information, see "Disposing electrical and electronic equipment" on page 504.</p>
---	--

1.3 Warning messages in the documentation

A warning message points out a risk or danger that you need to be aware of. The signal word indicates the severity of the safety hazard and how likely it will occur if you do not follow the safety precautions.

WARNING

Potentially hazardous situation. Could result in death or serious injury if not avoided.

CAUTION

Potentially hazardous situation. Could result in minor or moderate injury if not avoided.

NOTICE

Potential risks of damage. Could result in damage to the supported product or to other property.

1.4 Korea certification class B



이 기기는 가정용(B급) 전자파 적합기기로서 주로 가정에서 사용하는 것을 목적으로 하며, 모든 지역에서 사용할 수 있습니다.

2 Welcome

This chapter provides an overview of the user documentation and an introduction to the R&S NRX.

2.1 Documentation overview

This section provides an overview of the R&S NRX user documentation. Unless specified otherwise, you find the documents on the R&S NRX product page at:

www.rohde-schwarz.com/manual/NRX

2.1.1 Getting started manual

Introduces the R&S NRX and describes how to set up and start working with the product. A printed version is delivered with the instrument.

2.1.2 User manual

Contains the description of all instrument modes and functions. It also provides an introduction to remote control, a complete description of the remote control commands with programming examples, and information on maintenance, instrument interfaces and error messages. Includes the contents of the getting started manual .

The user manual is provided on the R&S NRX for download under:

[System] > "Instrument Info" > "Help & Copyrights"

For further details, see [Chapter 10.2.4, "Help & copyrights"](#), on page 165.

2.1.3 Instrument security procedures

Deals with security issues when working with the R&S NRX in secure areas. It is available for download on the Internet.

2.1.4 Printed safety instructions

Provides safety information in many languages. The printed document is delivered with the product.

2.1.5 Data sheets and brochures

The data sheet contains the technical specifications of the R&S NRX. It also lists the firmware applications and their order numbers, and optional accessories.

The brochure provides an overview of the instrument and deals with the specific characteristics.

See www.rohde-schwarz.com/brochure-datasheet/NRX

2.1.6 Release notes and open source acknowledgment (OSA)

The release notes list new features, improvements and known issues of the current firmware version.

The open source acknowledgment and the license texts of open source software packages used in the R&S NRX software are provided under:

[System] > "Instrument Info" > "Help & Copyrights"

For further details, see [Chapter 10.2.4, "Help & copyrights"](#), on page 165.

See www.rohde-schwarz.com/firmware/NRX

2.2 Key features

The R&S NRX supports:

- Easy RF power measurements
- Multi-channel measurements
- RF pulse analysis
- System integration

The R&S NRX is a versatile, user-friendly base unit.

- Straightforward numerical and graphical display of measured values, plus intuitive operation with touchscreen-based graphical user interface
- Supports up to four R&S NRP and R&S NRQ6 power sensors.
- Supports all sensor-dependent measurement functions
- Hardware interfaces for remote control and triggering
- Code emulation of the R&S NRP2
- Optional high-precision CW and pulse mode reference source module
- Optional power reflection measurements with R&S NRT-Zxx directional power sensors

See also the R&S NRX fact sheet at www.rohde-schwarz.com.

3 Getting started

3.1 Preparing for use

Here, you can find basic information about setting up the product for the first time.

• Lifting and carrying	17
• Unpacking and checking	17
• Choosing the operating site	17
• Setting up the product	18
• Considerations for test setup	20
• Connecting to power	20
• Connecting to LAN	21
• Connecting power sensors	21
• Connecting USB and external devices	23
• Switching on or off	24

3.1.1 Lifting and carrying

See "[Lifting and carrying the product](#)" on page 12.

The R&S NRX weighs below 3 kg, details are provided in the data sheet. Due to the low weight, you can move the R&S NRX easily.

3.1.2 Unpacking and checking

1. Unpack the product carefully.
2. Retain the original packing material. Use it when transporting or shipping the product later.
3. Using the delivery notes, check the equipment for completeness.
4. Check the equipment for damage.

If the delivery is incomplete or equipment is damaged, contact Rohde & Schwarz.

3.1.3 Choosing the operating site

Specific operating conditions ensure proper operation and avoid damage to the product and connected devices. For information on environmental conditions such as ambient temperature and humidity, see the data sheet.

See also "[Choosing the operating site](#)" on page 12.

Electromagnetic compatibility classes

The electromagnetic compatibility (EMC) class indicates where you can operate the product. The EMC class of the product is given in the data sheet under "General data".

- Class B equipment is suitable for use in:
 - Residential environments
 - Environments that are directly connected to a low-voltage supply network that supplies residential buildings
- Class A equipment is intended for use in industrial environments. It can cause radio disturbances in residential environments due to possible conducted and radiated disturbances. It is therefore not suitable for class B environments. If class A equipment causes radio disturbances, take appropriate measures to eliminate them.

3.1.4 Setting up the product

See also:

- ["Setting up the product"](#) on page 12
- ["Intended use"](#) on page 11

3.1.4.1 Placing the product on a bench top

The R&S NRX is a small and lightweight product. You can stack the R&S NRX with other products, but place the R&S NRX on top. In the following procedure, the weight indication for stacking refers to the most common design of larger Rohde & Schwarz instruments. Verify the load suitable for your product before stacking.

To place the product on a bench top

1. Place the product on a stable, flat and level surface. Ensure that the surface can support the weight of the product. For information on the weight, see the data sheet.
2. **CAUTION!** Foldable feet can collapse. See ["Setting up the product"](#) on page 12. Always fold the feet completely in or out. With folded-out feet, do not place anything on top or underneath the product.
3. **WARNING!** A stack of products can fall over and cause injury. Never stack more than three products on top of each other. Instead, mount them in a rack.

Stack as follows:

- If the products have foldable feet, fold them in completely.
- It is best if all products have the same dimensions (width and length). If the products have different dimensions, stack according to size and place the smallest product on top.
- Do not exceed the permissible total load placed on the product at the bottom of the stack:
 - 50 kg when stacking products of identical dimensions (left figure).

- 25 kg when stacking smaller products on top (middle figure).

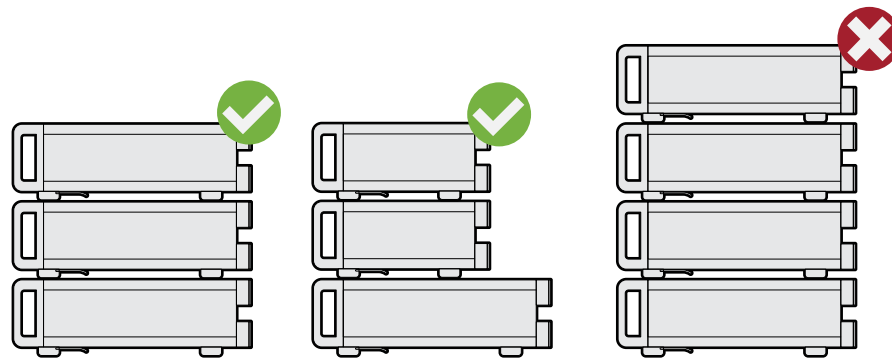

Left = Stacked correctly, same dimensions
 Middle = Stacked correctly, different dimensions
 Right = Stacked incorrectly, too many products

4. **NOTICE!** Overheating can damage the product.

Prevent overheating as follows:

- Keep a minimum distance of 10 cm between the fan openings of the product and any object in the vicinity.
- Do not place the product next to heat-generating equipment such as radiators or other products.

3.1.4.2 Mounting the product in a rack

To prepare the rack

1. Observe the requirements and instructions in "[Setting up the product](#)" on page 12.
2. **NOTICE!** Insufficient airflow can cause overheating and damage the product.
Design and implement an efficient ventilation concept for the rack.

To mount the product in a rack

1. Use an adapter kit to prepare the product for rack mounting.
 - a) Order the rack adapter kit designed for the product. For the order number, see data sheet.
 - b) Mount the adapter kit. Follow the assembly instructions provided with the adapter kit.
2. Grab the product by the handles and push it onto the shelf until the rack brackets fit closely to the rack.
3. Tighten all screws on the rack brackets to secure the product in the rack.

To unmount the product from a rack

1. Loosen the screws at the rack brackets.

2. Remove the product from the rack.
3. If placing the product on a bench top again, unmount the adapter kit from the product. Follow the instructions provided with the adapter kit.

3.1.5 Considerations for test setup

Cable selection and electromagnetic interference (EMI)

Electromagnetic interference (EMI) can affect the measurement results.

To suppress electromagnetic radiation during operation:

- Use high-quality shielded cables, for example, double-shielded RF and LAN cables.
- Always terminate open cable ends.
- Ensure that connected external devices comply with EMC regulations.
- Do not use USB connecting cables exceeding 5 m.

Preventing electrostatic discharge (ESD)

Electrostatic discharge is most likely to occur when you connect or disconnect a DUT.

- ▶ **NOTICE!** Risk of electrostatic discharge. Electrostatic discharge can damage the electronic components of the product and the device under test (DUT).

Ground yourself to prevent electrostatic discharge damage:

- a) Use a wrist strap and cord to connect yourself to ground.
- b) Use a conductive floor mat and heel strap combination.

3.1.6 Connecting to power

The R&S NRX can be used with different AC power voltages and adapts itself automatically to them. Adjusting the R&S NRX to a particular AC supply voltage is therefore not required. Refer to the data sheet for the requirements of voltage and frequency.

For safety information, see "[Connecting to power](#)" on page 12.

1. Plug the AC power cable into the AC power connector on the rear panel of the product. Only use the AC power cable delivered with the product.

2. Plug the AC power cable into a power outlet with ground contact.

The required ratings are listed next to the AC power connector and in the data sheet.

Further information:

- [Chapter 3.2.2.5, "AC supply and power switch"](#), on page 30

3.1.7 Connecting to LAN

See [Chapter 10.1.1, "Network settings"](#), on page 139.

3.1.8 Connecting power sensors

The R&S NRX supports a wide range of R&S power sensors. See the data sheet for detailed information.

Depending on the power sensor, you have different choices for connecting power sensors.

3.1.8.1 Sensor connectors A to D

See [Chapter 3.2.1.1, "Sensor connectors A and B"](#), on page 25 and [Chapter 3.2.2.8, "Sensor connectors C and D"](#), on page 32.

Suitable for:

- R&S NRP power sensors: R&S NRP xxS/T/A USB and R&S NRPxxSN/TN/AN LAN models
- R&S NRQ6
- R&S NRP-Zxx power sensors

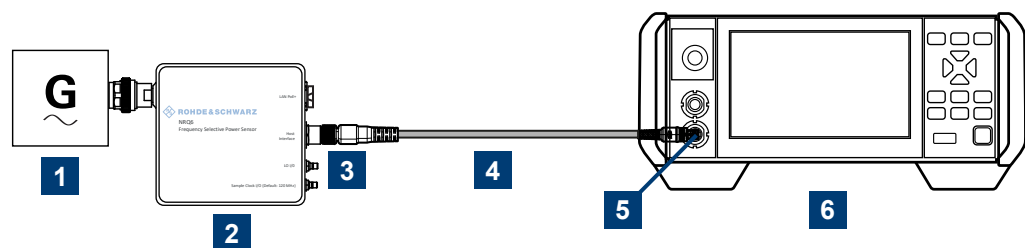

Figure 3-1: Setup with an R&S power sensor (example)

- 1 = Signal source
- 2 = R&S power sensor
- 3 = Host Interface connector
- 4 = R&S NRP-ZK8
- 5 = Sensor connector of the R&S NRX
- 6 = R&S NRX

Use an R&S NRP-ZK8 cable to connect an R&S power sensor to the R&S NRX. If you use an R&S NRP-ZK6 cable, the reference clock and trigger are not supported.

1. 8-pin female connector of R&S NRP-ZK8:
 - a) Insert the screw-lock cable connector into the host interface of the R&S power sensor.
 - b) Tighten the union nut manually.
2. 8-pin male connector of R&S NRP-ZK8:
 - a) Insert this connector into one of the sensor ports of the R&S NRX.

3. Connect the RF connector of the R&S power sensor to the signal source. For details, see the user manual of the R&S power sensor.

Note: Incorrectly connecting/disconnecting an R&S power sensor can damage the power sensor or lead to erroneous results.

3.1.8.2 Optional interface for R&S NRT-Z sensors (R&S NRX-B9)

See [Chapter 3.2.1.2, "Module bay"](#), on page 26.

Suitable for R&S NRT-Zxx directional power sensors.

Communication between the R&S NRT-Zxx directional power sensor and a base unit is only possible with a baud rate setting of 38400 Bd. This setting is the factory default that must be restored if the setting was changed. If the R&S NRT-Zxx directional power sensor is not recognized by the base unit, check that the baud rate setting of the R&S NRT-Zxx directional power sensor is 38400 Bd.

See the manual of the R&S NRT-Zxx directional power sensor for details.

The arrow on the power sensor casing shows the forward power flow.

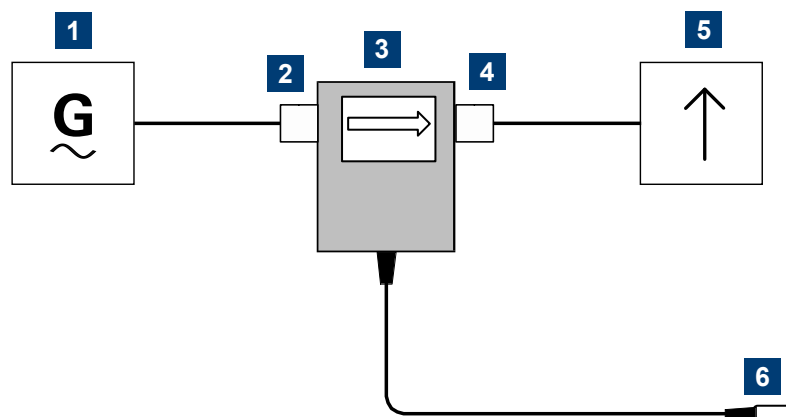

Figure 3-2: Connecting to source and load

- 1 = source
- 2 = port 1 (RF connector)
- 3 = R&S NRT-Zxx directional power sensor
- 4 = port 2 (RF connector)
- 5 = load
- 6 = host interface connector

To connect the R&S NRT-Zxx directional power sensor

Connect the R&S NRT-Zxx directional power sensor between source and load of your test setup as follows.

1. Connect RF connector (2, port 1) to the source.
 - a) Insert RF connector (2) straight into the RF connector of the source. Take care not to tilt the R&S NRT-Zxx directional power sensor.

- b) Tighten the RF connector securely by hand.
2. Connect RF connector (4, port 2) to the load.
 - a) Insert RF connector (4) straight into the RF connector of the load. Take care not to tilt the R&S NRT-Zxx directional power sensor.
 - b) Tighten the RF connector tightly by hand.

During the measurement, the RF power flow can be high. Power leakage has the risk of electric shock and severe skin burns.
3. Connect the host interface connector of the R&S NRT-Zxx directional power sensor (6) to the interface for R&S NRT-Z sensors (R&S NRX-B9).

To disconnect the R&S NRT-Zxx directional power sensor

1. **CAUTION!** Risk of electric shock and severe skin burns. During the measurement, the RF power flow can be high.

Switch off the RF power before touching the RF connectors.
2. Unscrew the RF connectors by hand.
3. Disconnect the cable of the R&S NRT-Zxx directional power sensor (6) from the interface for R&S NRT-Z sensors (R&S NRX-B9).

3.1.8.3 LAN interface

See [Chapter 3.2.2.2, "Ethernet interface"](#), on page 30.

Suitable for LAN power sensors.

R&S power sensors that are connected to the LAN interface are not recognized automatically. Add them, see ["To add a LAN power sensor"](#) on page 151.

3.1.8.4 USB 2.0 host interfaces

See [Chapter 3.2.1.5, "USB host interface"](#), on page 29 and [Chapter 3.2.2.4, "USB host interface"](#), on page 30.

Suitable for USB power sensors. You can increase the number of connected power sensors by using USB hubs.

3.1.9 Connecting USB and external devices

Apart from connecting power sensors, you can use the USB interfaces to connect USB devices. You can increase the number of connected devices by using USB hubs.

Due to the large number of available USB devices, there is almost no limit to the possible expansions. In the following, useful USB devices are listed exemplarily:

- Memory stick for easy transfer of data to/from a computer (e.g. firmware updates).
- Mouse if you prefer this way of operation over a touchscreen.

3.1.10 Switching on or off

Table 3-1: Overview of power states

Status	LED	Position of power switch
Off	Off	[0]
Standby	● orange	[1]
Ready	● green	[1]

To switch on the product

The product is off but connected to power.

1. Set the switch on the power supply to position [1]. See [Chapter 3.2.2.5, "AC supply and power switch"](#), on page 30.
The LED of the [standby] key is orange. See [Chapter 3.2.1.6, "On/standby key"](#), on page 29.
2. Press the [standby] key.
The LED changes to green. The product boots.
See [Chapter 4.1.1, "Start dialog"](#), on page 33.
If the previous session ended regularly, the product uses the settings from the last session.
3. If you want to return to a defined initial state, perform a preset.
See ["Preset"](#) on page 135.

To shut down the product

The product is in the ready state.

- ▶ Press the [standby] key.
The operating system shuts down. The LED changes to orange.

To disconnect from power

The product is in the standby state.

1. **NOTICE!** Risk of data loss. If you disconnect the product from power when it is in the ready state, you can lose settings and data. Shut it down first.
Set the switch on the power supply to position [0].
The LED of the standby key is switched off.
2. Disconnect the product from the power source.

Further information:

- [Chapter 8, "Saving and recalling settings"](#), on page 134
- [Chapter 3.2.1.6, "On/standby key"](#), on page 29

3.2 Instrument tour

The meanings of the labels on the product are described in [Chapter 1.2, "Labels on the product"](#), on page 13.

- [Front panel tour](#).....25
- [Rear panel tour](#)..... 29

3.2.1 Front panel tour

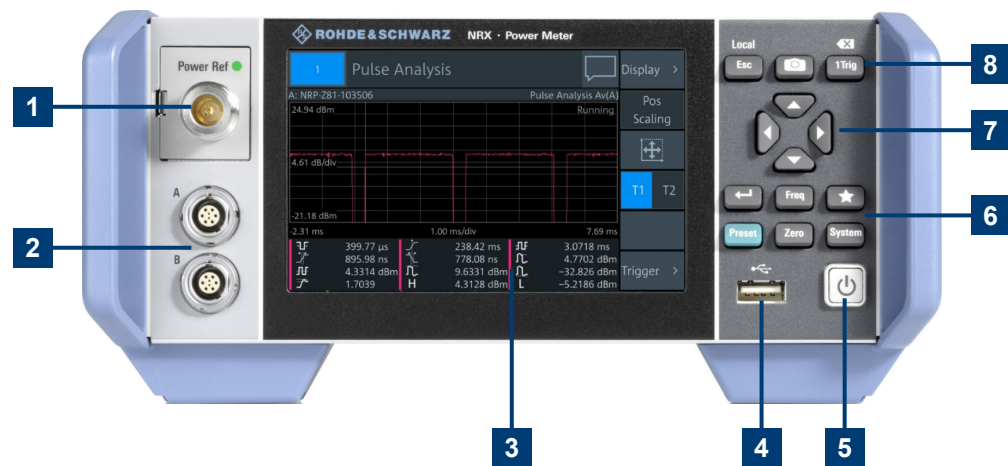

Figure 3-3: Front panel of the R&S NRX

- 1 = Module bay for optional connectors, see [Chapter 3.2.1.2, "Module bay"](#), on page 26.
- 2 = Sensor connectors A and B, see [Chapter 3.2.1.1, "Sensor connectors A and B"](#), on page 25.
- 3 = Touchscreen, see [Chapter 3.2.1.3, "Touchscreen"](#), on page 27.
- 4 = USB host interface, see [Chapter 3.2.1.5, "USB host interface"](#), on page 29.
- 5 = On/standby key, see [Chapter 3.2.1.6, "On/standby key"](#), on page 29.
- 6, 8 = Keys, see [Chapter 3.2.1.4, "Keys"](#), on page 27.
- 7 = Cursor keys, see ["Cursor keys"](#) on page 28.

3.2.1.1 Sensor connectors A and B

See (2) in [Figure 3-3](#).

Sensor connectors A and B are used to connect the R&S NRP power sensors and the R&S NRQ6. For details on the supported power sensors, see the data sheet.

The complete functional range, including external trigger and reference clock for the synchronization of connected sensors, is provided by these connectors.

Further information:

- [Chapter 3.1.8, "Connecting power sensors"](#), on page 21

3.2.1.2 Module bay

See (1) in [Figure 3-3](#).

Two options fit in this bay. If you have both options, you can exchange them, see "[To exchange the option](#)" on page 26.

If no option is installed, the module bay is closed by a cover.

Sensor check source (R&S NRX-B1)

Used as a power reference for testing the connected power sensors and the cabling. The LED of the sensor check source (R&S NRX-B1) shows the state, see [Table 3-2](#).

You can remove the option and send it to Rohde & Schwarz for calibration. Contact the Rohde & Schwarz customer service.

Table 3-2: Possible states

Illumination	State	Signal Output setting
Off	No signal is generated.	"Off"
Steady green	Continuous wave is output.	"CW"
Blinking green	Pulse signal is output.	"Pulse"
Blinking red	Settings conflict exists. For example if "Pulse" is set and the power level is set to 20 dBm.	"CW" or "Pulse"

Interface for R&S NRT-Z sensors (R&S NRX-B9)

Provides an optional power sensor interface to connect an R&S NRT-Zxx power sensor. For supported power sensors, see the data sheet.

To exchange the option

1. Press the latch to the right, using your thumb nail or a small pen.



2. Pull the option from its casing.
3. Insert the other option.
4. Press until you hear a click when the latch locks.

Further information:

- [Chapter 3.1.8, "Connecting power sensors"](#), on page 21
- ["Sensor Check Source tab"](#) on page 146

- [Chapter 13.9, "Configuring the test generator"](#), on page 376
- [Chapter 3.1.8.2, "Optional interface for R&S NRT-Z sensors \(R&S NRX-B9\)"](#), on page 22

3.2.1.3 Touchscreen

See (3) in [Figure 3-3](#).

The R&S NRX displays results in panes. Depending on the measurement mode, values are displayed digitally or graphically.



False triggers can occur

If an object (e.g. a human finger) that is charged with static electricity is brought near the touch panel, false triggers can occur.

This behavior is caused by the principle of operation of a PCAP (projected capacitive) touch panel.

Further information:

- ["Using the touchscreen"](#) on page 33

3.2.1.4 Keys

See (4) in [Figure 3-3](#).

Esc

[Esc] / Local

If you press shortly:

- Changes to the next-higher hierarchy level.
- Escapes from the entry mode in text boxes and lists.
- Closes dialogs without losing any entries that have been made.
- Switches from remote control mode (all controls disabled) to manual operation.

If you press and hold:

- Goes to the start dialog that shows an overview of the active measurements. See [Chapter 4.1.1, "Start dialog"](#), on page 33.

Further information:

- ["Going back to a higher hierarchy level"](#) on page 33
- [Chapter 4.3.2, "Returning to manual operation \(LOCAL\)"](#), on page 45



Screenshot

Creates a screenshot of the current display.

See [Chapter 4.1.8, "Creating and saving screenshots"](#), on page 42.

Remote command:

`SYSTem:HCOPY` on page 229

1 Trig

[1Trig] / Delete

- Controls the measurements depending on the trigger mode:
 - For all trigger modes except "Single", starts and stops the measurement.
 - For the "Single" trigger mode, enables and triggers the measurement.

Changes of the trigger state apply to all measurements.

See also ["Trigger Mode"](#) on page 66.

- Resets the auxiliary values that provide additional information about the measured values.

See also ["Auxiliary Values"](#) on page 55.

- Deletes numbers or text in a field so that you can enter a new value.



Enter

- Confirms entries in text fields, dialogs and selections in lists.
- Shows a frame around the control in focus. You can change the focus using the [Cursor keys](#).



[Freq]

Sets the carrier frequency of the applied signal. This value is used for frequency-response correction of the measurement result.

Remote command:

[\[SENSe<Sensor>:\] FREQuency \[:CW\]](#) on page 330



Favorites

Reserved for future use.



[Preset]

Opens the "Save / Recall / Preset" dialog.

See [Chapter 8, "Saving and recalling settings"](#), on page 134.

If you press [Preset] again, the preset function starts.

See ["Preset"](#) on page 135.

If you press the [Preset] key during booting, the R&S NRX starts with the factory default state.



[Zero]

Pressing [Zero] opens the "Zeroing Sensors" dialog.

If you press [Zero] again, "Zero All Sensors" starts.

Also displays status information:

- Zeroing status
- Sensor status



[System]

Opens the "System Overview" dialog.

See [Chapter 10, "System settings"](#), on page 138.

Cursor keys

See (5) in [Figure 3-3](#).

The cursor keys are context-sensitive. The control in focus is indicated by a focus frame. Use the cursor keys as follows:

- Selecting an element in the navigation pane.
- Selecting the active pane.
- Selecting an element from a list.

- Moving the cursor in text boxes.
- Changing the value of an entry in a text box.

3.2.1.5 USB host interface

See (6) in [Figure 3-3](#).

USB 2.0 (universal serial bus) interface of the type A (host USB). Used to connect:

- USB power sensors
- External devices like a keyboard, mouse, or memory stick

Further information:

- [Chapter 3.1.8.4, "USB 2.0 host interfaces"](#), on page 23
- [Chapter 3.1.9, "Connecting USB and external devices"](#), on page 23

3.2.1.6 On/standby key

See (7) in [Figure 3-3](#).

The on/standby key switches between standby and ready state, if the power switch is set to [I].

Further information:

- [Chapter 3.2.2.5, "AC supply and power switch"](#), on page 30
- [Chapter 3.1.10, "Switching on or off"](#), on page 24

3.2.2 Rear panel tour

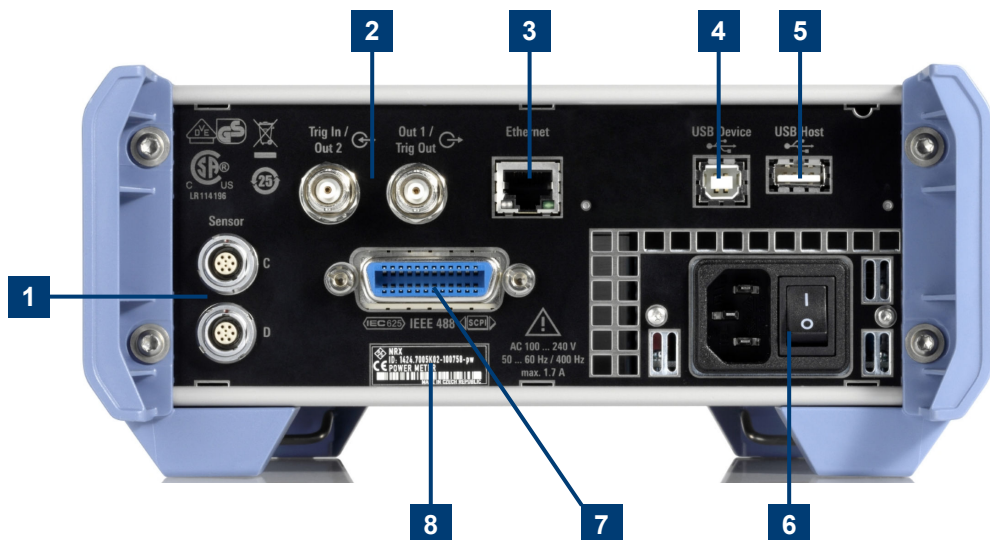

Figure 3-4: Rear panel of the R&S NRX

- 1 = Sensor connectors C and D (optional), used to connect R&S power sensors, see [Chapter 3.2.2.8, "Sensor connectors C and D"](#), on page 32.
- 2 = Trig In / Out 2 and Out 1 / Trig Out connectors, see [Chapter 3.2.2.1, "Trig In / Out 2 and Out 1 / Trig Out connectors"](#), on page 30.
- 3 = Ethernet interface, see [Chapter 3.2.2.2, "Ethernet interface"](#), on page 30.
- 4 = USB device interface, see [Chapter 3.2.2.3, "USB device interface"](#), on page 30.
- 5 = USB host interface, see [Chapter 3.2.2.4, "USB host interface"](#), on page 30.
- 6 = AC supply and power switch, see [Chapter 3.2.2.5, "AC supply and power switch"](#), on page 30.
- 7 = IEC 625/IEEE 488 interface, optional, see [Chapter 3.2.2.6, "IEC 625/IEEE 488 interface"](#), on page 31.
- 8 = Name plate, see [Chapter 3.2.2.7, "Name plate"](#), on page 31

3.2.2.1 Trig In / Out 2 and Out 1 / Trig Out connectors

See (1) in [Figure 3-4](#).

The Out 1 / Trig Out BNC connectors supply an analog signal with a voltage between 0 V and 2.5 V. It can be used to output a voltage that is proportional to the measured value (e.g. for level regulation) or a digital signal for limit monitoring.

The Trig In / Out 2 BNC connectors can be used either as an external trigger input with a switchable impedance (10 k Ω or 50 Ω) or as a second analog output.

By default, both connectors are disabled.

Further information:

- ["I/O 1, I/O 2 tabs"](#) on page 147

3.2.2.2 Ethernet interface

See (2) in [Figure 3-4](#).

The Ethernet connector is an RJ45 socket for remote controlling the R&S NRX via a network.

3.2.2.3 USB device interface

See (3) in [Figure 3-4](#).

USB 2.0 (universal serial bus) interface of the type B (receptacle). Used to connect the R&S NRX to a computer for USB remote control.

3.2.2.4 USB host interface

See (4) in [Figure 3-4](#).

See [Chapter 3.2.1.5, "USB host interface"](#), on page 29.

3.2.2.5 AC supply and power switch

See (5) in [Figure 3-4](#).

Observe the safety instructions in ["Connecting to power"](#) on page 12.

When the R&S NRX is connected to the AC supply, it automatically sets itself to the correct range for the applied voltage. The range is printed on the casing. There is no need to set the voltage manually.

Further information:

- [Chapter 3.1.6, "Connecting to power"](#), on page 20

3.2.2.6 IEC 625/IEEE 488 interface

See (6) in [Figure 3-4](#).

Requires GPIB/IEEE488 interface (R&S NRX-B8).

IEC bus (IEEE 488) interface for remote control of the R&S NRX. Used to connect a controller to remote control the R&S NRX. Use a shielded cable for the connection.

Characteristics of the IEC bus (IEEE 488) interface:

- 8-bit parallel data transfer
- Bidirectional data transfer
- Three-wire handshake
- High data transfer rate
- Maximum length of connecting cables 15 m (single connection 2 m)

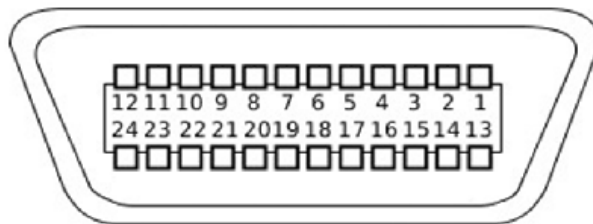

3.2.2.7 Name plate

See (7) in [Figure 3-4](#).

Shows the type, identification and name of the R&S NRX. The device ID consists of:

<stock number> - <serial number> - <checksum>

The framed 6 digits in [Figure 3-5](#) are the individual serial number.



Figure 3-5: Name plate

The name plate also shows the parts of the default hostname. The default hostname consists of <type>-<serial number>.

For the R&S NRX with the name plate shown in [Figure 3-5](#), the default hostname is:

NRX-100758

Further information:

- ["System Info"](#) on page 155
- ["Host Name"](#) on page 140

3.2.2.8 Sensor connectors C and D

See (8) in [Figure 3-4](#).

Requires 3rd and 4th R&S NRP sensor connector (R&S NRX-B4).

For more details, see [Chapter 3.2.1.1, "Sensor connectors A and B"](#), on page 25.

4 Operating concepts

• Manual operation	33
• Remote operation	43
• Remote control	44

4.1 Manual operation

Using the graphical user interface of the R&S NRX and the keys on the front panel, you can easily configure the settings and measure in the provided measurement modes.

Using the touchscreen

A touchscreen allows you to interact with the software using various finger gestures on the screen. The basic gestures supported by the software and most applications are described here. Further actions using the same gestures may be possible.



Tap = touch the screen quickly, usually on a specific element. You can tap most elements on the screen to access the settings belonging to that element (topic).

In graphs, use the following gestures:

- *Pan* = put your fingers on the touchscreen and move them while keeping contact. Thus, you can bring offscreen extensions of the graph into view.
- *Pinch* = move two fingers toward each other to change the zoom.

Going back to a higher hierarchy level

Esc

The [Esc] key is the essential control element to navigate back, for example after you have opened a dialog by tapping an element.

- ▶ Press **Esc** shortly to change to the next-higher hierarchy level.
- ▶ Keep **Esc** pressed to go to the highest hierarchy level, the start dialog.

4.1.1 Start dialog

1. Connect a power sensor to the R&S NRX.
See [Chapter 3.1.8, "Connecting power sensors"](#), on page 21.
2. Boot the R&S NRX.
After successful booting, the R&S NRX displays the start dialog.

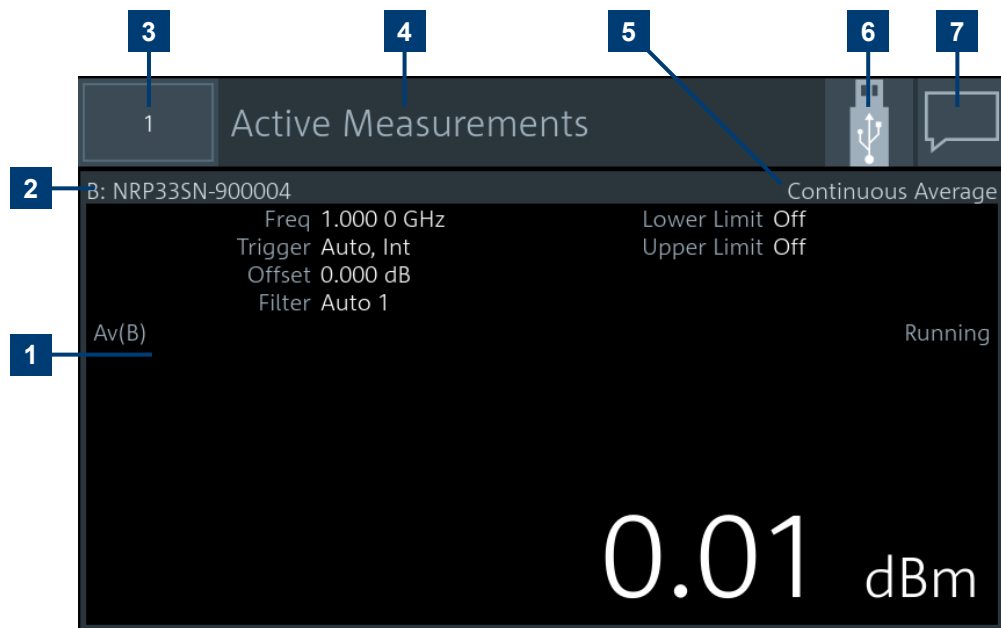

Figure 4-1: Start dialog (example for setup with one power sensor)

- 1 = Measurement pane
- 2 = Connected sensors
- 3 = Miniature display layout. See [Chapter 4.1.5, "Selecting the display layout"](#), on page 38.
- 4 = Title
- 5 = Measurement type
- 6 = Status information. See [Chapter 4.1.3, "Status information"](#), on page 36.
- 7 = Notification center status. See [Chapter 4.1.4, "Notification center"](#), on page 37.

In the measurement pane, the settings, results and status of the active measurements are displayed. The layout depends on the selected display layout. See [Chapter 4.1.5, "Selecting the display layout"](#), on page 38.

4.1.2 Main measurement dialog

From the start dialog, you can access the measurements.

To access a measurement

- ▶ In the start dialog, tap the pane of the measurement you want to access. In this example, tap (7) in [Figure 4-1](#).

The selected measurement is displayed in full screen. Its number is highlighted in the miniature display layout in the upper left corner.

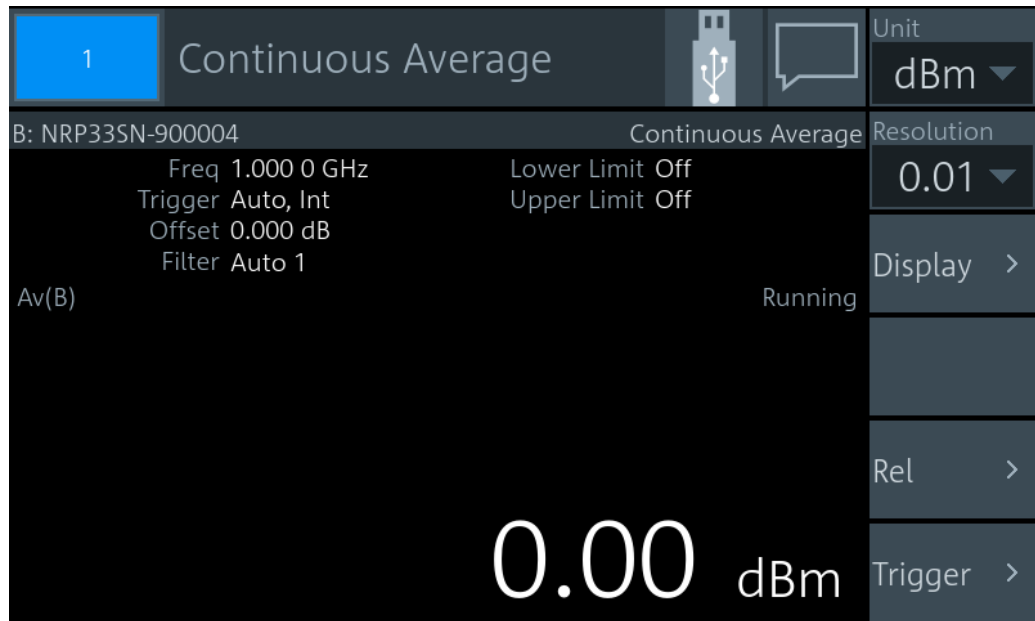

Layout of the main measurement dialog

The operating philosophy in the main measurement dialog is independent of the measurement type. The dialog is divided into touch areas that lead to different settings.

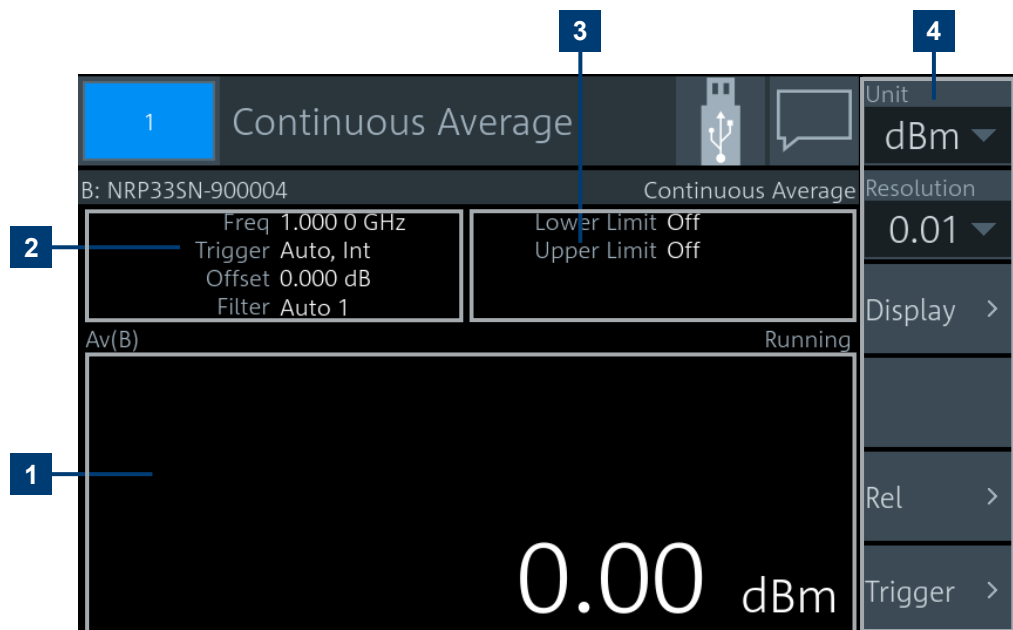

Figure 4-2: Layout of the main measurement dialog (example)

- 1 = Measurement value displayed in the measurement pane
- 2 = Settings displayed in the measurement pane
- 3 = Limit values displayed in the measurement pane
- 4 = Navigation pane



- ▶ Tap the *displayed settings*, (1) in [Figure 4-2](#), to access the sensor settings.
The "Primary Sensor" dialog is displayed.
See [Chapter 7, "Sensor configuration"](#), on page 115.
- ▶ Tap the *displayed limit values*, (2) in [Figure 4-2](#), to change limit values.
The "Limit Monitor" dialog is displayed.
See ["Limit Monitor"](#) on page 59.
- ▶ Tap the *displayed measurement value or graph*, (3) in [Figure 4-2](#), to change the measurement type, assign a sensor, access the sensor settings, ...
The "Measurement Settings" dialog is displayed.
See [Chapter 6.1.4, "Measurement settings dialog"](#), on page 69.
- ▶ Tap an *element in the navigation pane*, (4) in [Figure 4-2](#), to configure the trigger, the presentation of the measurement result and further measurement-specific settings.
See [Chapter 6.1, "Configuration for all measurement types"](#), on page 52.



Tapping other areas in the measurement pane can open further dialogs, but these dialogs are measurement-specific and there is no general rule that applies to all measurements.

4.1.3 Status information

The status information is displayed in the upper right corner, left from the notification center. See [Figure 4-1](#).

Table 4-1: Status symbols

Symbol	Description	Further information
	Memory stick is connected and ready for use.	Chapter 3.1.9, "Connecting USB and external devices" , on page 23
	Memory stick is connected and initialization is in progress. When the moving green dot vanishes, the memory stick is ready for use.	
	R&S NRX is in remote control.	Chapter 4.3.2, "Returning to manual operation (LOCAL)" , on page 45

Symbol	Description	Further information
	LLO means local lockout. R&S NRX is in remote control. Manual operation is disabled.	
	Identification and initialization of a connected power sensor is in progress.	

4.1.4 Notification center

The notification center collects all information during the operation of the R&S NRX:





- Notices
- Warning messages
- Error messages

The notification status is displayed in the upper right corner:

- The displayed symbol belongs to the most severe message. For example, if one error and 5 notices are present, the symbol of the error message is displayed. The symbols used are explained in [Table 4-2](#).
- The number of all messages is displayed in the color of the most severe message.

See (6) in [Figure 4-1](#).

Table 4-2: Notification symbols

Symbol	Description
	No message is available.
	Only one or more notices are present.
	At least one warning message is present. Yellow is the assigned color.
	At least one error message is present. Red is the assigned color.

To display the messages

- ▶ Tap the notification symbol in the upper left corner.

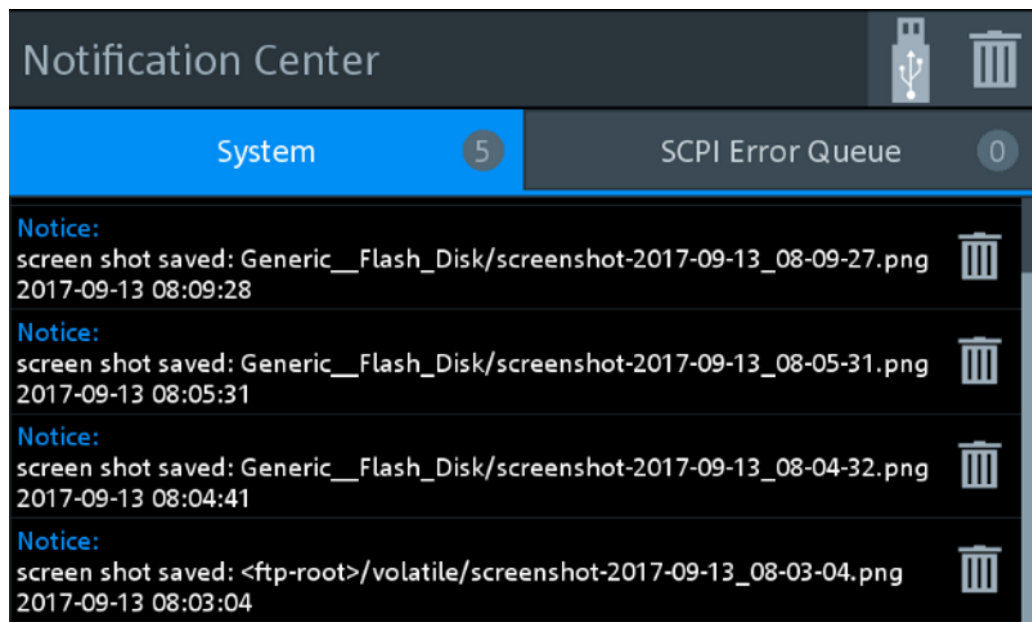

The "Notification Center" dialog has two tabs:

- "System"
All messages concerning the instrument are listed.
- "SCPI Error Queue"
Messages related to the remote command functionality are displayed.

To delete notices no longer needed

- ▶ If you want to delete a specific notice, tap the bin symbol next to the notice.
- ▶ If you want to delete all notices, tap the bin symbol in the right corner.

Further information:

- [Chapter 15.2, "Notifications"](#), on page 497

4.1.5 Selecting the display layout

You can split the measurement display into panes. A maximum number of 4 panes is possible, one for each measurement.

To change the display layout

1. Press and hold [Esc] until the start dialog is displayed.
2. Tap the miniature display layout in the upper left corner.



3. Select how many measurement panes you want to display.
For example, if you select 2 panes, the measurement display looks as follows:



Figure 4-3: Two measurement panes

Remote command:

`DISPlay:LAYout` on page 201

`DISPlay[:WINDow<Window>][:STATe]` on page 203

4.1.6 Swapping measurement panes

You can swap the position of measurement panes using drag and drop. The numbering of the panes is not changed.

To change the position of a measurement pane

- Touch & hold a measurement pane and drag it into the new position.



The two panes have changed position:

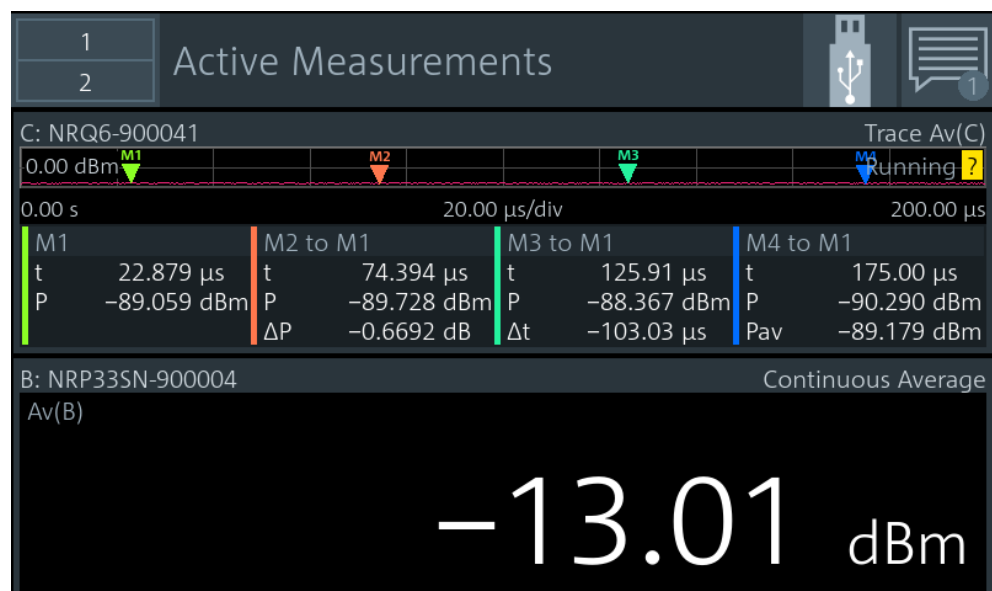

In the "Select Display Layout" dialog, you can see that the positions of pane 1 and pane 2 are exchanged, but the numbering of the panes is unchanged.

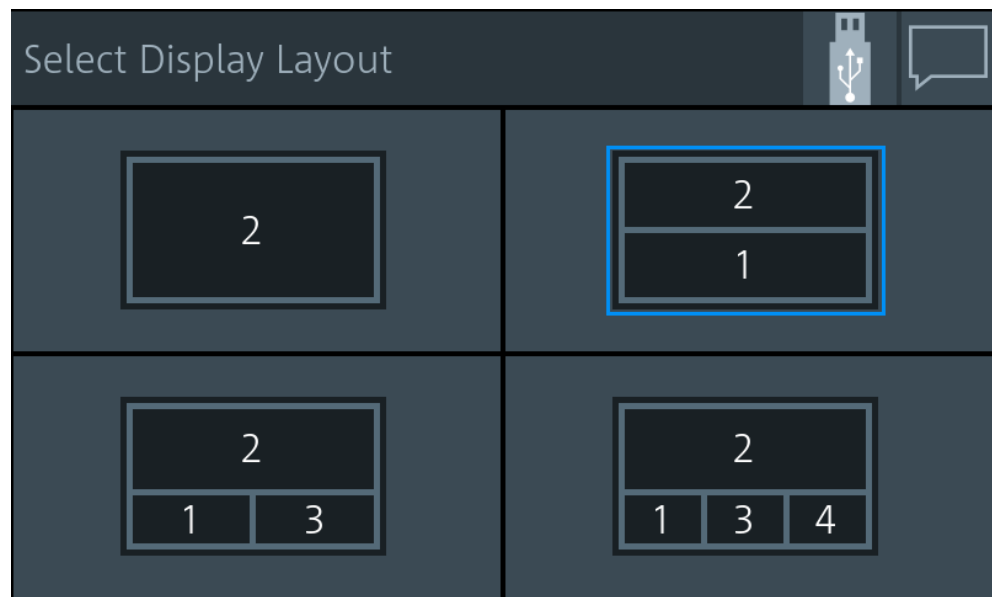

Remote command:

`DISPlay[:WINDow<Window>]:POSition` on page 203

4.1.7 Editing parameters

1. Tap a parameter to change its value.
Depending on the selected parameter, a numeric or an alphanumeric editor is displayed.
2. Tap **+ -** to display the value range of the parameter ("Min", "Max").
3. If "More x/x" is displayed, more units are available than displayed. Tap "More x/x" to scroll through the units.
Example: "More 2/4" means, page 2 is displayed, 4 pages are available in total.

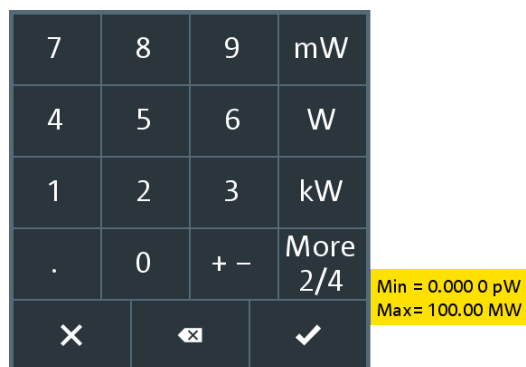

Figure 4-4: Numeric editor (example)

Use the alphanumeric editor as a standard keyboard.

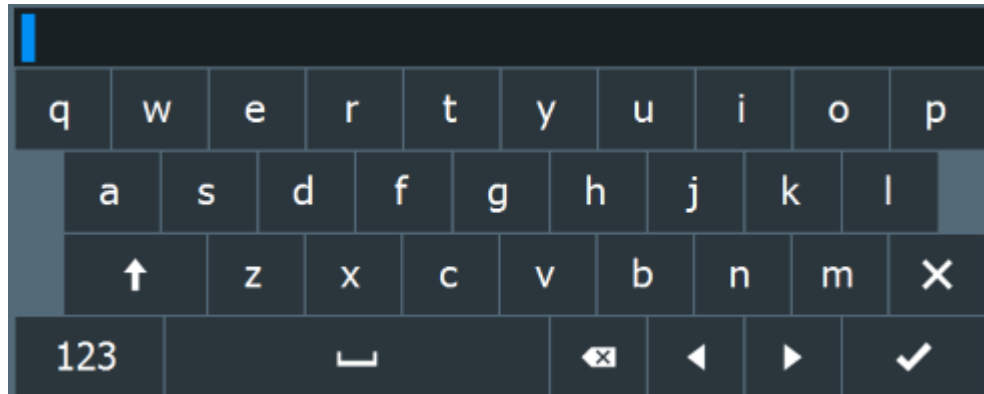

Figure 4-5: Alphanumeric editor

4.1.8 Creating and saving screenshots

You can create a screenshot of the current display, for example to save graphical measurement results.

- ▶ Press the [Screenshot] key on the front panel.

The R&S NRX saves the screenshot in PNG format.

If a memory stick is connected, the PNG is saved on the memory stick.

Otherwise, the PNG is saved in the volatile directory of the FTP directory. You can download the PNG using FTP.

For preconfigured user identification and password, see ["Old Password"](#) on page 160.

In the "Notification Center", a "Notice" message shows the file path and name.

Remote control:

[SYSTEM:HCOPY](#) on page 229

Further information:

- [Chapter 3.1.9, "Connecting USB and external devices"](#), on page 23
- [Chapter 3.2.1.5, "USB host interface"](#), on page 29

4.1.9 Restricting manual operation

For security measures, you can restrict the manual operation allowed at the R&S NRX.

1. Select [System] > "Instrument Info" > "Security".
2. On the "General" tab, select "User Interface".

The "User Interface" dialog contains settings to restrict access in various degrees. See ["User Interface"](#) on page 158.

- ▶ To lift the restrictions indicated by 
 - a) Tap the touchscreen.
 - b) Enter the security password.

Further information:

- ["Security Password to Unlock Settings"](#) on page 158

4.2 Remote operation

VNC (virtual network computing) simulates the user interface of the R&S NRX. Thus, you can operate the R&S NRX manually from an external computer in the same way as operating the R&S NRX itself. During VNC operation, local operation (manual operation, see [Chapter 4.1, "Manual operation"](#), on page 33) and remote operation have equal access rights. Both users see the same screen contents of the R&S NRX and can operate the R&S NRX simultaneously.

By default, VNC access is enabled. Any user in the network who knows the password and IP address of the R&S NRX can access the R&S NRX. To prevent access, disable the VNC server service under ["VNC"](#) on page 160.

Prerequisites

- LAN interface of the external computer is configured for the network.
- R&S NRX and the computer are connected using a LAN network.

To set up a connection using a VNC viewer

1. On the external computer, install the VNC viewer if it is not installed already.
2. Open the VNC viewer.
3. Enter the host name or the IP address of the R&S NRX.
See also ["Overview tab"](#) on page 140.
4. Click "Connect".
5. Enter the session password.
For preconfigured password, see ["Old Password"](#) on page 160.

To set up a connection using a web browser



1. Open the web browser.
2. Enter as web address: *http://<hostname>* or *http://<IP address>*. For example, *http://nrx-104711*.
See also ["Overview tab"](#) on page 140.
3. Enter the password.
For preconfigured password, see ["Old Password"](#) on page 160.

Operating the front panel keys

You can operate the front panel keys using shortcuts, see [Table 4-3](#).

In the web browser, you can use also the buttons below the measurement dialog that visualize the front panel keys.

Table 4-3: Shortcuts for the front panel keys

Front panel key	Remote operation replacement
[1 Trig]	Backspace
[Esc]	ESC
 Favorites	Ctrl + C
[Freq]	Ctrl + F
 Screenshot	Ctrl + Y
[Preset]	Ctrl + P
[System]	Ctrl + E
[Zero]	Ctrl + N

4.3 Remote control

The R&S NRX is equipped with various interfaces for connecting it to a controller for remote control:

- IEC/IEEE bus interface (standard equipment) in line with the standards IEC 60625.1 (IEEE 488.1) and IEC 60625.2 (IEEE 488.2)
- Gigabit Ethernet interface
- USB 2.0 interface for remote control and firmware update

Connectors are installed at the rear of the R&S NRX. See [Chapter 3.2, "Instrument tour"](#), on page 25.

The interfaces support the SCPI (standard commands for programmable instruments) standard, version 1999.0 of May 1999. The SCPI standard is based on the IEEE 488.2 standard. It defines a standardized command language for controlling measuring and test instruments with functions beyond the scope of the IEEE 488.2 standard.

For a detailed description of the remote commands, see [Chapter 13, "Remote control commands"](#), on page 178.

4.3.1 Switching to remote control (REMOTE)

Prerequisites

- A link is established between the controller and the R&S NRX.
- The R&S NRX is configured correctly.

After power-up, the R&S NRX is always in manual control mode, "LOCAL". When the R&S NRX receives a SCPI command, it switches to remote control irrespective of the selected interface.

4.3.2 Returning to manual operation (LOCAL)

If the R&S NRX is in remote control, you can display settings using the front-panel keys and the touchscreen, but you cannot change settings. To do that, you have to return to manual operation.

The R&S NRX remains in remote control until you perform one of the following actions. Make sure that the R&S NRX is free for you to use.

- ▶ Press the [Esc/Local] key. See "[\[Esc\] / Local](#)" on page 27.
If the manual operation was disabled by the `&LLO` command (local lockout) and the [Esc/Local] key does not work, switch the R&S NRX off and on again.
- ▶ Send the `>L` command (go to local).
- ▶ Tap the symbol on the touchscreen.
See [Chapter 4.1.3, "Status information"](#), on page 36.

5 Measurement basics

In a measurement, the R&S NRX uses all sensor-dependent measurement functions and displays the results. Thus, you can configure both the measurement and the sensor. The R&S NRX saves all settings.

- [Parallel measurements](#)..... 46
- [Sensor assignment and memory](#)..... 46
- [Performing a measurement](#).....48
- [Limit violation](#)..... 49
- [Settings conflict](#)..... 50

5.1 Parallel measurements

An R&S NRX without enhancements supports the configuration of one power sensor for one measurement type. If you want to use more than one power sensor simultaneously, you can extend both to a maximum of 4 with the following options:

- second measurement channel (R&S NRX-K2)
- 3rd and 4th measurement channel (R&S NRX-K4)

For details on ordering information, refer to the brochure of the R&S NRP power meter family.

You can configure the display to accommodate the number of measurements you want to watch simultaneously, see [Chapter 4.1.5, "Selecting the display layout"](#), on page 38.

If you connect more than 4 power sensors simultaneously, the R&S NRX notifies you. Use the sensor manager to handle more than 4 power sensors, see [Chapter 10.1.4, "Sensor manager"](#), on page 151.

5.2 Sensor assignment and memory

When you connect an R&S power sensor to the R&S NRX, the R&S NRX tries to recognize the sensor. The sensor recognition is based on the sensor type and the serial number of the power sensor.

The following scenarios are possible:

- Sensor type has never been connected before.
The R&S NRX uses its settings for the measurement.
- Sensor type has been connected before.
The R&S NRX assigns the sensor to the measurement type it was assigned before. The port where the sensor is connected is of no concern. You do not have to use the same port for the same sensor type.
See ["Example: Using different ports for the same sensor type"](#) on page 47.
- Sensor type is different to the sensor type that was previously assigned to the measurement. Decide whether you want to use the settings of the sensor.

- "Use Default"
Uses the sensor settings. For details, see the user manual of the sensor.
- "Cancel"
Keeps the measurement settings and does not assign the sensor to the measurement.

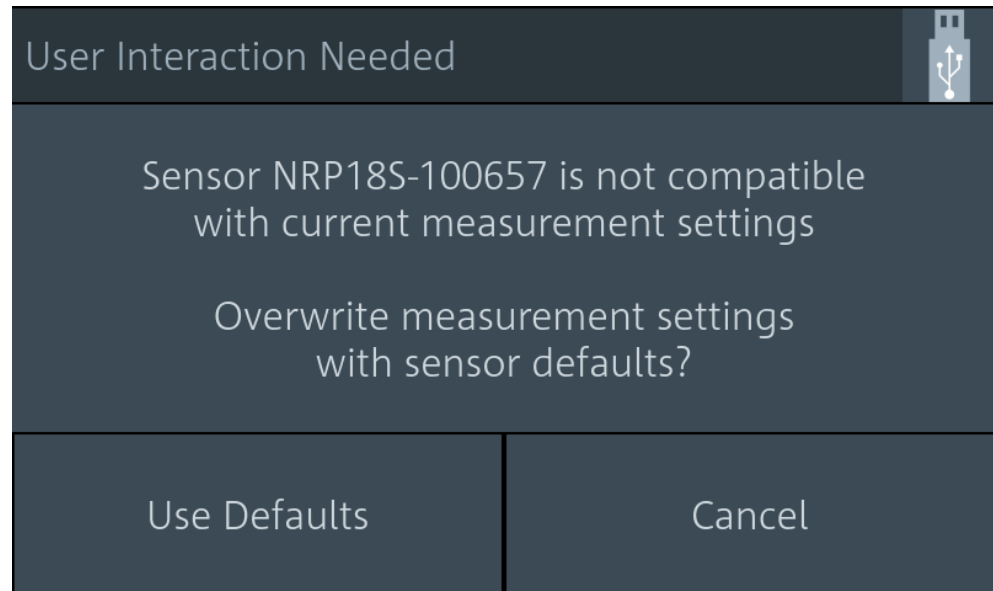

If conflicting settings occur when connecting a sensor, the R&S NRX shows where the problematic setting is located. See [Chapter 5.5, "Settings conflict"](#), on page 50.

Example: Using different ports for the same sensor type

1. Connect an R&S NRQ6 to port A.
2. Perform a trace measurement.
3. Remove the R&S NRQ6 and connect it to port B.

The R&S NRX recognizes the sensor type and assigns the R&S NRQ6 to the same measurement.

Example: Using two sensors of the same type

1. Connect the first R&S NRP-Z81 to port A.
2. Connect the second R&S NRP-Z81 to port B.
3. Swap ports.

The R&S NRX distinguishes sensors of the same type due to their unique serial number and assigns them to the same measurement as before.

The sensor assignment is deleted by a preset, reset or sanitization. If the R&S NRX has no memory of a previous sensor assignment, the R&S NRX assigns the measurements according to the port, to which the power sensors are connected. The number of measurement panes is adapted automatically.

Example: Connecting sensors after a preset

1. Connect an R&S NRQ6 to port A.

The measurement results are displayed in measurement pane 1.

2. Connect an R&S NRP33SN to port C.

The display layout is extended to 3 measurement panes. The measurement results of the R&S NRP33SN are displayed in measurement pane 3. Measurement pane 2 is unused.

3. Disconnect the R&S NRP33SN from port C and connect it to port B.

4. Press [Preset].

The display layout is reduced to 2 measurement panes. The power sensors are assigned according to their port. The assignment of the R&S NRQ6 is unchanged, but the R&S NRP33SN is assigned to measurement pane 2.

Further information:

- [Chapter 13.3, "Addressing measurements and power sensors"](#), on page 187
Suffix usage in remote control

5.3 Performing a measurement

This measurement description is designed to give you a first impression. For further information, see the description of the measurements, their results and their settings:

- [Chapter 6.1, "Configuration for all measurement types"](#), on page 52
- [Chapter 6, "Measurement and display configuration"](#), on page 52
- [Chapter 7, "Sensor configuration"](#), on page 115

Setup

1. Connect one or more R&S power sensors to the R&S NRX. See [Chapter 3.1.8, "Connecting power sensors"](#), on page 21.

How many R&S power sensors you can connect depends on the options of your R&S NRX. See [Chapter 5.1, "Parallel measurements"](#), on page 46.

2. Connect each R&S power sensor to a DUT (signal source). See the user manual of the R&S power sensor for information on topics that need your special attention.

Starting a measurement

1. Preset the R&S NRX and the connected R&S power sensors.

- a) Press the [Preset] key.
- b) Tap "Preset".

See also [Chapter 8, "Saving and recalling settings"](#), on page 134.

2. Depending on the power sensor and the measurement conditions, consider to zero the power sensor:

Execute zeroing:

Note: Turn off all measurement signals before zeroing. An active measurement signal during zeroing causes an error.

- a) Switch off the power of the signal source.
- b) Press the [Zero] key.
- c) Tap "Zero All Sensors".

See also [Chapter 9, "Zeroing sensors"](#), on page 136.

3. Configure the measurement.
 - a) Open the "Measurement Settings" dialog, as described in [Chapter 4.1.2, "Main measurement dialog"](#), on page 34.
 - b) Select the "Measurement Type", for example "Continuous Average".
 - c) Tap "Quick Setup" > "Auto Set".

4. Switch on the signal source.

The measurement starts, and the result is displayed in dBm.

5. If necessary, perform further settings.

5.4 Limit violation

If a measured value violates the set limits, it is highlighted in red.

- ▶ To change the limit settings, tap the displayed limit values. See also (2) in [Figure 4-2](#).

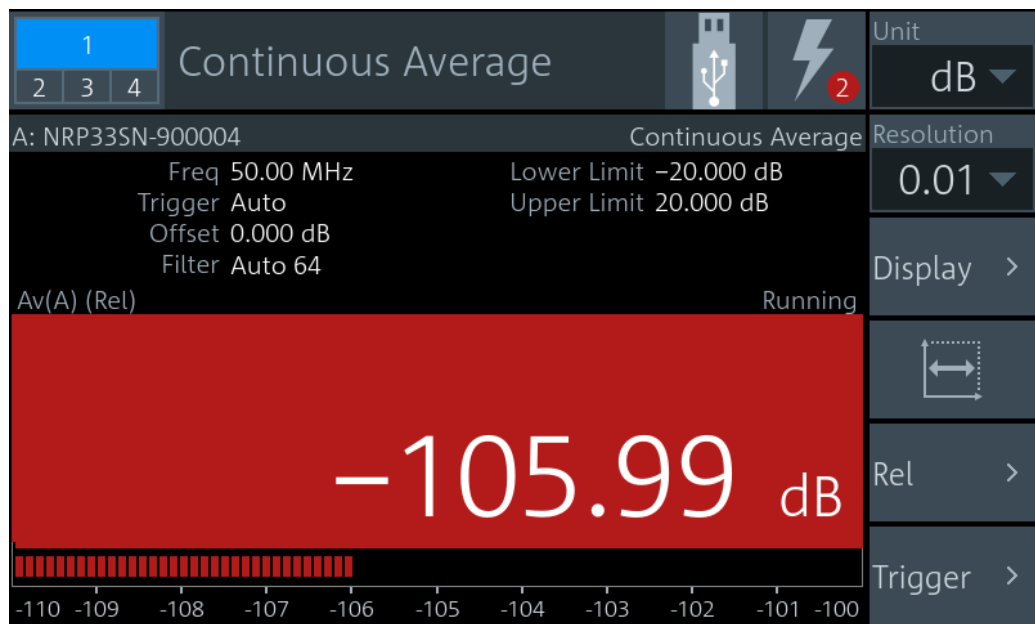

5.5 Settings conflict

A settings conflict can occur for the following reasons:

- The sensor assigned to the measurement does not support a set value. If it is a numeric value, the suitable range for the sensor is given in the tooltip.
- The sensor assigned to the measurement does not support the measurement type.
- Other contradictory settings, for example the lower limit value is higher than the upper limit value.

Contradictory settings are allowed so that you are not hampered in your workflow. But they cause an error message in the notification center. Furthermore, the contradictory setting is highlighted and the control elements in the hierarchies above that are leading to this setting are highlighted, too. Thus, you can follow the problem across the hierarchies to solve the settings conflict. The only control element that is not highlighted due to a settings conflict is the measurement value. The measurement value is only highlighted in red when it is violating the set limits, as shown in [Chapter 5.4, "Limit violation"](#), on page 49.

Example: The sensor does not support the measurement type

The notification center indicates an error, but the no control element is highlighted. The error message reports a settings conflict.

Solving the error

1. Tap the *displayed measurement value or graphic*. See also [Figure 4-2](#).
The "Measurement Settings" dialog is displayed.
The "Measurement Type" is highlighted.



2. Select another measurement type that the sensor supports, or assign another sensor.



A setting that differs from the preset value is also indicated across the hierarchies by a pencil symbol, if the visualization is enabled. See "[Visualize Non-Preset State](#)" on page 169.



6 Measurement and display configuration

The different measurement types and their specific configuration settings are described in the following. Settings available for all measurements are described in [Chapter 6.1, "Configuration for all measurement types"](#), on page 52.

• Configuration for all measurement types	52
• Continuous average	72
• Burst average	74
• Trace	76
• Pulse analysis	81
• Time gate	90
• Timeslot	95
• Statistics	101
• NRT	108

6.1 Configuration for all measurement types

The main measurement dialog offers access to all measurement settings. The layout of the dialog and how to open it are described in [Chapter 4.1.2, "Main measurement dialog"](#), on page 34.

In the navigation pane, you can directly set the unit and the resolution for numeric results. These settings are also available under "Display".

The settings available for all measurements are described in the following, while measurement-specific settings are separately for each measurement.

6.1.1 Display settings

Access: Main measurement dialog > "Display"

The available display settings depend on the measurement type and whether the result display is numeric or graphical:

- Resolution and unit of a measurement
- Graphical or numerical display of measured values
- Scaling parameters for graphical display

The statistics measurement has no "Display" settings, but you can scale the display.

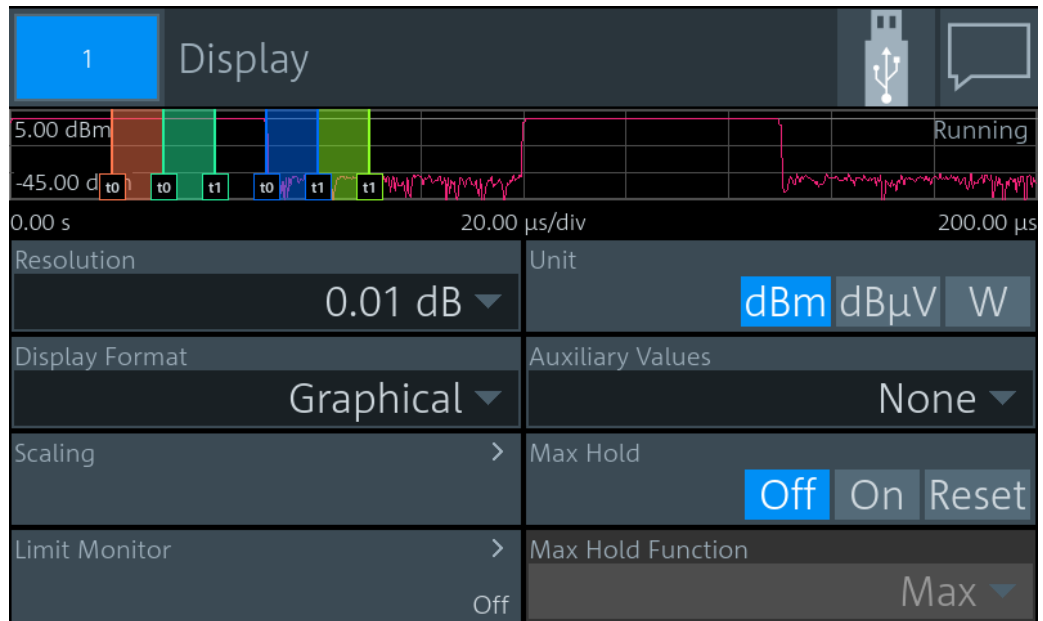

Figure 6-1: Display dialog, example for time gate measurement

Resolution.....	54
Unit.....	54
Forward Unit.....	54
Display Format.....	54
Auxiliary Values.....	55
Scaling.....	55
L Scale Lower Limit.....	55
L Scale Upper Limit.....	56
L Forward Scale Lower Limit, Reflection Scale Lower Limit.....	56
L Forward Scale Upper Limit, Reflection Scale Upper Limit.....	56
L Start Time.....	57
L Time / Div.....	57
L Trace Length.....	57
L Power Reference.....	57
L Power / Div.....	57
L Power Span.....	58
L Unit.....	58
Relative Measurements.....	58
L Forward Reference Value, Reflection Reference Value.....	58
L Forward Relative State, Reflection Relative State.....	58
Max Hold.....	59
Max Hold Function.....	59
Limit Monitor.....	59
L Lower Limit State.....	59
L Lower Limit.....	59
L Upper Limit State.....	60
L Upper Limit.....	60
L Forward Lower Limit State, Reflection Lower Limit State.....	60

↳ Forward Lower Limit, Reflection Lower Limit.....	61
↳ Forward Upper Limit State, Reflection Upper Limit State.....	61
↳ Forward Upper Limit, Reflection Upper Limit.....	61

Resolution

Configures the resolution of the measurement. For logarithmic power values (dB, dBm or dB μ V), the number of decimal places is set directly. For linear power values (W, $\Delta\%$, 1), the number of decimal places depends on the selected resolution and the magnitude of the result.

"1 dB | 0.1 dB | 0.01 dB | 0.001 dB "

Sets the resolution to the specified value.

Remote command:

`CALCulate<Measurement>:RESolution`

`[SENSe<Sensor>:]RRESolution`

Unit

Sets the unit of the display. The available units depend on the [Channel Calculation Function](#).

"dBm"	Power in dBm
"dB μ V"	Power in dB μ V
"W"	Power in W
"dB"	Quotient of the power values as dB
" $\Delta\%$ "	Difference between the power values in W, given in %. 0 % means that the powers in both channels are equal.
"x1"	Quotient of the power values (non-logarithmic)

Remote command:

`UNIT<Measurement>:POWER[:VALue]` on page 219

`UNIT<Measurement>:POWER:RATio` on page 218

Forward Unit

Available for NRT measurements.

Sets the unit of the forward power measurement.

"dBm"	Power in dBm
"dB μ V"	Power in dB μ V
"W"	Power in W

Remote command:

`UNIT<Measurement>:POWER[:VALue]`

`UNIT<Measurement>:POWER:RATio`

Display Format

Available for continuous average, burst average, time gate, timeslot, NRT measurements.

Sets the display format of the measured values.

"Scalar Digital" Numeric format

"Scalar Analog"

Numeric format with bar chart

"Graphical"

Available for time gate, timeslot measurements.
Measured values are plotted over time.

Remote command:

[CALCulate<Measurement>:DMODE](#) on page 198

Auxiliary Values

Available for the graphic displays of continuous average, burst average measurements. Only displayed if the measurement result display is shown in full screen.

Determines which additional information about the measured values is shown in the display. If you press [1 Trig / Delete], you reset the auxiliary values.

"None"

No additional values are measured.

"Extremes"

Displays the maximum, the minimum and the max-min values since the search for extreme values has been started. With logarithmic units, the peak-to-peak value equals the quotient of the measured values converted into linear units.

"Statistics"

Displays the long-term mean, the standard deviation and the total number of measurement results that have been evaluated since the search for statistic values has been started.

Remote command:

[CALCulate<Measurement>:AVALue](#) on page 198

Scaling

Configures the display scaling. The available parameters depend on the following settings:

- [Measurement Type](#)
- ["Display Format"](#) on page 54

Scale Lower Limit ← Scaling

If [Display Format](#) is set to "Scalar Analog", available for continuous average, burst average, time gate, timeslot measurements.

Defines the lower limit of the bargraph display.

Remote command:

[CALCulate<Measurement>:METer<DirectionalChannel>:LOWer\[:DATA\]:RATio:RCoefficient](#) on page 205

[CALCulate<Measurement>:METer<DirectionalChannel>:LOWer\[:DATA\]:RATio:RFRatio](#) on page 205

[CALCulate<Measurement>:METer<DirectionalChannel>:LOWer\[:DATA\]:RATio:RLOSs](#) on page 206

[CALCulate<Measurement>:METer<DirectionalChannel>:LOWer\[:DATA\]:RATio:SWR](#) on page 206

[CALCulate<Measurement>:METer<DirectionalChannel>:LOWer\[:DATA\]:RATio\[:VALue\]](#) on page 207

[CALCulate<Measurement>:METer<DirectionalChannel>:LOWer\[:DATA\]:POWER\]](#) on page 207

Scale Upper Limit ← Scaling

If [Display Format](#) is set to "Scalar Analog", available for continuous average, burst average, time gate, timeslot measurements.

Defines the upper limit of the bargraph display.

Remote command:

```
CALCulate<Measurement>:METer<DirectionalChannel>:UPPer[:DATA]:
RATio:RCOefficient on page 208
CALCulate<Measurement>:METer<DirectionalChannel>:UPPer[:DATA]:
RATio:RFRatio on page 208
CALCulate<Measurement>:METer<DirectionalChannel>:UPPer[:DATA]:
RATio:RLOSSs on page 209
CALCulate<Measurement>:METer<DirectionalChannel>:UPPer[:DATA]:
RATio:SWR on page 209
CALCulate<Measurement>:METer<DirectionalChannel>:UPPer[:DATA]:
RATio[:VALue] on page 210
CALCulate<Measurement>:METer<DirectionalChannel>:UPPer[:DATA][:
POWER] on page 210
```

Forward Scale Lower Limit, Reflection Scale Lower Limit ← Scaling

Available for NRT measurements.

Defines the lower limit of the bargraph display.

Remote command:

```
CALCulate<Measurement>:METer<DirectionalChannel>:LOWer[:DATA]:
CCDF
CALCulate<Measurement>:METer<DirectionalChannel>:LOWer[:DATA]:
RATio:RCOefficient
CALCulate<Measurement>:METer<DirectionalChannel>:LOWer[:DATA]:
RATio:RFRatio
CALCulate<Measurement>:METer<DirectionalChannel>:LOWer[:DATA]:
RATio:RLOSSs
CALCulate<Measurement>:METer<DirectionalChannel>:LOWer[:DATA]:
RATio:SWR
CALCulate<Measurement>:METer<DirectionalChannel>:LOWer[:DATA]:
RATio[:VALue]
CALCulate<Measurement>:METer<DirectionalChannel>:LOWer[:DATA][:
POWER]
```

Forward Scale Upper Limit, Reflection Scale Upper Limit ← Scaling

Available for NRT measurements.

Defines the upper limit of the bargraph display.

Remote command:

```
CALCulate<Measurement>:METer<DirectionalChannel>:UPPer[:DATA]:
CCDF
CALCulate<Measurement>:METer<DirectionalChannel>:UPPer[:DATA]:
RATio:RCOefficient
```

```

CALCulate<Measurement>:METer<DirectionalChannel>:UPPer[:DATA]:
RATio:RFRatio
CALCulate<Measurement>:METer<DirectionalChannel>:UPPer[:DATA]:
RATio:RLOSs
CALCulate<Measurement>:METer<DirectionalChannel>:UPPer[:DATA]:
RATio:SWR
CALCulate<Measurement>:METer<DirectionalChannel>:UPPer[:DATA]:
RATio[:VALue]
CALCulate<Measurement>:METer<DirectionalChannel>:UPPer[:DATA][:
POWer]

```

Start Time ← Scaling

Available for trace, pulse analysis measurements. If [Display Format](#) is set to "Graphical", available for time gate, timeslot measurements.

Defines the position of the left screen edge relative to the delayed trigger. The value can be negative so that signal components are displayed before the trigger event.

Remote command:

```
CALCulate<Measurement>:TRACe:X[:SCALe]:LEFT on page 211
```

Time / Div ← Scaling

Available for trace, pulse analysis measurements. If [Display Format](#) is set to "Graphical", available for time gate, timeslot measurements.

Sets the time resolution of the results window. The time per division is one tenth of the [Trace Length](#).

Trace Length ← Scaling

Available for trace, pulse analysis measurements. If [Display Format](#) is set to "Graphical", available for time gate, timeslot measurements.

Sets the duration of the trace.

Remote command:

```
CALCulate<Measurement>:TRACe:X[:SCALe]:LENGTH on page 211
```

Power Reference ← Scaling

Available for trace, pulse analysis, time gate, timeslot measurements.

Sets the power reference value. The reference value is assigned to the top line of the grid.

Remote command:

```
CALCulate<Measurement>:TRACe:Y[:SCALe]:TOP:DB on page 213
```

```
CALCulate<Measurement>:TRACe:Y[:SCALe]:TOP:DBM on page 213
```

```
CALCulate<Measurement>:TRACe:Y[:SCALe]:TOP:DBUV on page 214
```

```
CALCulate<Measurement>:TRACe:Y[:SCALe]:TOP:DPCT on page 214
```

```
CALCulate<Measurement>:TRACe:Y[:SCALe]:TOP:ONE on page 214
```

```
CALCulate<Measurement>:TRACe:Y[:SCALe]:TOP:WATT on page 215
```

Power / Div ← Scaling

Available for trace, pulse analysis, time gate, timeslot, statistics measurements.

Sets the vertical scaling. The power per division is one tenth of the [Power Span](#).

The combination of [Power Reference](#) and this parameter define the vertical orientation of the trace.

Remote command:

`[SENSe<Sensor>:] TRACe:TIME` on page 216

Power Span ← Scaling

Available for trace, pulse analysis, time gate, timeslot measurements.

Sets the power level range.

Remote command:

`CALCulate<Measurement>:TRACe:Y[:SCALe]:SPAN:DB` on page 211

`CALCulate<Measurement>:TRACe:Y[:SCALe]:SPAN:DBM` on page 212

`CALCulate<Measurement>:TRACe:Y[:SCALe]:SPAN:DBUV` on page 212

`CALCulate<Measurement>:TRACe:Y[:SCALe]:SPAN:DPCT` on page 212

`CALCulate<Measurement>:TRACe:Y[:SCALe]:SPAN:ONE` on page 212

`CALCulate<Measurement>:TRACe:Y[:SCALe]:SPAN:WATT` on page 213

Unit ← Scaling

Sets the unit of the power axis.

Relative Measurements

Available for NRT measurements.

Groups the settings for relative measurements.

Forward Reference Value, Reflection Reference Value ← Relative Measurements

Available for NRT measurements.

Available if [Forward Relative State](#), [Reflection Relative State](#) is set to "On" or "Set".

Sets the reference value.

Remote command:

`CALCulate<Measurement>:RELative<DirectionalChannel>[:MAGNitude]`

`CALCulate<Measurement>:RELative<DirectionalChannel>:CCDF`

`CALCulate<Measurement>:RELative<DirectionalChannel>:POWer[:MAGNitude]`

`CALCulate<Measurement>:RELative<DirectionalChannel>:RATio:RCoefficient`

`CALCulate<Measurement>:RELative<DirectionalChannel>:RATio:RFRatio`

`CALCulate<Measurement>:RELative<DirectionalChannel>:RATio:RLOSS`

`CALCulate<Measurement>:RELative<DirectionalChannel>:RATio:SWR`

`CALCulate<Measurement>:RELative<DirectionalChannel>:RATio[:MAGNitude]`

`[SENSe<Sensor>:] POWer:REFerence`

Forward Relative State, Reflection Relative State ← Relative Measurements

Available for NRT measurements.

Allows you to relate measured power to a reference value.

Off	Displays the absolute power or power ratio.
On	Displays the relative power or power ratio. As reference value, the value specified under Forward Reference Value , Reflection Reference Value is used.
Set	Assigns the current measurement result as reference value and displays the relative power.

Remote command:

```
CALCulate<Measurement>:RELative<DirectionalChannel>:STATe
```

Max Hold

If enabled, displays the highest value measured for each point (pixel) of the selected display type.

Remote command:

```
CALCulate<Measurement>:HOLD[:STATe]
```

Max Hold Function

For all measurement functions, the R&S NRX stores the maximum and minimum values and the calculated differences between these values.

The selected setting applies to both power and reflection indication. You can change at any time.

"Max"	Maximum value
"Min"	Minimum value
"Max – Min"	Difference between maximum and minimum value

Remote command:

```
CALCulate<Measurement>:HOLD:FUNCTION
```

Limit Monitor

Available for continuous average, burst average, time gate, timeslot, NRT measurements.

For each window with digital or digital/analog result display, you can set an upper and a lower limit.

Lower Limit State ← Limit Monitor

Available for continuous average, burst average, time gate, timeslot measurements.

Enables or disables the monitoring function for the lower limit.

Remote command:

```
CALCulate<Measurement>:LIMit<DirectionalChannel>:LOWer:STATe
```

Lower Limit ← Limit Monitor

Available for continuous average, burst average, time gate, timeslot measurements.

Available if [Lower Limit State](#) is set to "On".

Defines a lower limit.

Remote command:

```
CALCulate<Measurement>:LIMit<DirectionalChannel>:LOWer[:DATA]
CALCulate<Measurement>:LIMit<DirectionalChannel>:LOWer[:DATA]:
POWer
CALCulate<Measurement>:LIMit<DirectionalChannel>:LOWer[:DATA]:
RATio:RCOefficient
CALCulate<Measurement>:LIMit<DirectionalChannel>:LOWer[:DATA]:
RATio:RFRatio
CALCulate<Measurement>:LIMit<DirectionalChannel>:LOWer[:DATA]:
RATio:RLOSS
CALCulate<Measurement>:LIMit<DirectionalChannel>:LOWer[:DATA]:
RATio:SWR
CALCulate<Measurement>:LIMit<DirectionalChannel>:LOWer[:DATA]:
RATio[:VALue]
```

Upper Limit State ← Limit Monitor

Available for continuous average, burst average, time gate, timeslot measurements.

Enables or disables the monitoring function for the upper limit.

Remote command:

```
CALCulate<Measurement>:LIMit<DirectionalChannel>:UPPer:STATe
```

Upper Limit ← Limit Monitor

Available for continuous average, burst average, time gate, timeslot measurements.

Available if [Upper Limit State](#) is set to "On".

Defines an upper limit.

Remote command:

```
CALCulate<Measurement>:LIMit<DirectionalChannel>:UPPer[:DATA]
CALCulate<Measurement>:LIMit<DirectionalChannel>:UPPer[:DATA]:
POWer
CALCulate<Measurement>:LIMit<DirectionalChannel>:UPPer[:DATA]:
RATio:RCOefficient
CALCulate<Measurement>:LIMit<DirectionalChannel>:UPPer[:DATA]:
RATio:RFRatio
CALCulate<Measurement>:LIMit<DirectionalChannel>:UPPer[:DATA]:
RATio:RLOSS
CALCulate<Measurement>:LIMit<DirectionalChannel>:UPPer[:DATA]:
RATio:SWR
CALCulate<Measurement>:LIMit<DirectionalChannel>:UPPer[:DATA]:
RATio[:VALue]
```

Forward Lower Limit State, Reflection Lower Limit State ← Limit Monitor

Available for NRT measurements.

Enables or disables the monitoring function for the lower limit.

Remote command:

```
CALCulate<Measurement>:LIMit<DirectionalChannel>:LOWer:STATe
```

Forward Lower Limit, Reflection Lower Limit ← Limit Monitor

Available for NRT measurements.

Defines a lower limit.

Remote command:

```
CALCulate<Measurement>:LIMit<DirectionalChannel>:LOWer[:DATA]
```

on page 221

```
CALCulate<Measurement>:LIMit<DirectionalChannel>:LOWer[:DATA]:  
CCDF
```

```
CALCulate<Measurement>:LIMit<DirectionalChannel>:LOWer[:DATA]:  
POWer
```

```
CALCulate<Measurement>:LIMit<DirectionalChannel>:LOWer[:DATA]:  
RATio:RCOefficient
```

```
CALCulate<Measurement>:LIMit<DirectionalChannel>:LOWer[:DATA]:  
RATio:RFRatio
```

```
CALCulate<Measurement>:LIMit<DirectionalChannel>:LOWer[:DATA]:  
RATio:RLOSS
```

```
CALCulate<Measurement>:LIMit<DirectionalChannel>:LOWer[:DATA]:  
RATio:SWR
```

```
CALCulate<Measurement>:LIMit<DirectionalChannel>:LOWer[:DATA]:  
RATio[:VALue]
```

Forward Upper Limit State, Reflection Upper Limit State ← Limit Monitor

Available for NRT measurements.

Enables or disables the monitoring function for the upper limit.

Remote command:

```
CALCulate<Measurement>:LIMit<DirectionalChannel>:UPPer:STATe
```

Forward Upper Limit, Reflection Upper Limit ← Limit Monitor

Available for NRT measurements.

Defines an upper limit.

Remote command:

```
CALCulate<Measurement>:LIMit<DirectionalChannel>:UPPer[:DATA]
```

on page 224

```
CALCulate<Measurement>:LIMit<DirectionalChannel>:UPPer[:DATA]:  
CCDF
```

```
CALCulate<Measurement>:LIMit<DirectionalChannel>:UPPer[:DATA]:  
POWer
```

```
CALCulate<Measurement>:LIMit<DirectionalChannel>:UPPer[:DATA]:  
RATio:RCOefficient
```

```
CALCulate<Measurement>:LIMit<DirectionalChannel>:UPPer[:DATA]:  
RATio:RFRatio
```

```
CALCulate<Measurement>:LIMit<DirectionalChannel>:UPPer[:DATA]:  
RATio:RLOSS
```

```
CALCulate<Measurement>:LIMit<DirectionalChannel>:UPPer[:DATA]:  
RATio:SWR  
CALCulate<Measurement>:LIMit<DirectionalChannel>:UPPer[:DATA]:  
RATio[:VALue]
```

6.1.2 Controlling the measurement

The power sensor offers a bunch of possibilities to control the measurement:

- Do you want to start the measurement immediately after the initiate command or do you want to wait for a trigger event?
- Do you want to start a single measurement cycle or a sequence of measurement cycles?
- Do you want to output each new average value as a measurement result or do you want to bundle more measured values into one result?

Further information:

- [Chapter 6.1.3, "Triggering"](#), on page 63
- See the power sensor user manual for examples on the interplay of the controlling mechanisms.

6.1.2.1 Controlling the measurement results

The R&S NRX can cope with the wide range of measurement scenarios with the help of the so-called "termination control". Depending on how fast your measurement results change, you can define, how the measurement results are output.

Repeating termination control

Outputs a measurement result when the entire measurement has been completed. This means that the number of measurement cycle repetitions is equal to the set average count. If the average count is large, the measurement time can be very long.

Useful if you expect slow changes in the results, and you want to avoid outputting redundant data.

Moving termination control

Outputs intermediate values to facilitate early detection of changes in the measured quantity. This means that for each partial measurement, a new average value is output as a measurement result. Thus, the measurement result is a moving average of the last partial measurements. How many of the partial measurements are averaged is defined by the average count.

Useful if you want to detect trends in the result during the measurement.

6.1.3 Triggering

In a basic continuous measurement, the measurement is started immediately after the initiate command. However, sometimes you want that the measurement starts only if a specific condition is fulfilled. For example, if a signal level is exceeded, or in certain time intervals. For these cases, you can define a trigger for the measurement.

6.1.3.1 Trigger states

The power sensor has trigger states to define the exact start and stop time of a measurement and the sequence of a measurement cycle. The following states are defined:

- **Idle**
The power sensor performs no measurement. After powered on, the power sensor is in the idle state.
- **Waiting for trigger**
The power sensor waits for a trigger event that is defined by the trigger source. When the trigger event occurs, the power sensor enters the measuring state.
- **Measuring**
The power sensor is measuring data. It remains in this state during the measurement. When the measurement is completed, it exits this state immediately.

6.1.3.2 Trigger sources

The possible trigger conditions and the execution of a trigger depend on the selected trigger mode and trigger source.

If the signal power exceeds or falls below a reference level set by the trigger level, the measurement is started after the defined delay time. Waiting for a trigger event can be skipped.

Trigger source	Description	Remote commands to initiate the measurement
"Hold"	Waits for a trigger event. Press [1Trig] to trigger the measurement. Depending on the sensor type, the trigger is executed by the trigger bus or by remote command. See the user manual of the power sensor for details.	TRIGger<Measurement>[:IMMediate]
"Immediate"	Measures immediately, does not wait for trigger condition.	-
"Internal"	Uses the input signal as trigger signal.	TRIGger<Measurement>[:IMMediate]
"Internal A" , "Internal B" , "Internal C" , "Internal D"	Receives the trigger signal from the trigger sender. The trigger sender is the sensor connected to port A, B, C, or D. See "Trigger Sender State" on page 68.	TRIGger<Measurement>[:IMMediate]
"External"	Uses the external trigger signal that is supplied at the Trig In / Out 2 connector. See Chapter 3.2.2.1, "Trig In / Out 2 and Out 1 / Trig Out connectors" , on page 30.	TRIGger<Measurement>[:IMMediate]

Trigger source	Description	Remote commands to initiate the measurement
"External 2"	Requires a power sensor with a trigger input/output. Uses the external trigger signal that is supplied at the trigger input/output of the power sensor.	<code>TRIGger<Measurement>[:IMMediate]</code>
"Sensor Check Source"	Requires the sensor check source (R&S NRX-B1) option. If enabled, the sensor check source (R&S NRX-B1) sends trigger signals using the internal trigger bus. See " Sensor Check Source tab " on page 146.	<code>*TRG</code> <code>TRIGger<Measurement>[:IMMediate]</code>
"Bus (*TRG)"	Waits for a trigger event. Press [1Trig] to trigger the measurement. Depending on the sensor type, the trigger is executed by the trigger bus or by remote command. See the user manual of the power sensor for details.	<code>*TRG</code> <code>TRIGger<Measurement>[:IMMediate]</code>

6.1.3.3 Dropout time

The dropout time is useful when dealing with signals with several active slots, for example GSM signals, see [Figure 6-2](#). When measuring in sync with the signal, a trigger event is to be produced at A, but not at B or C.

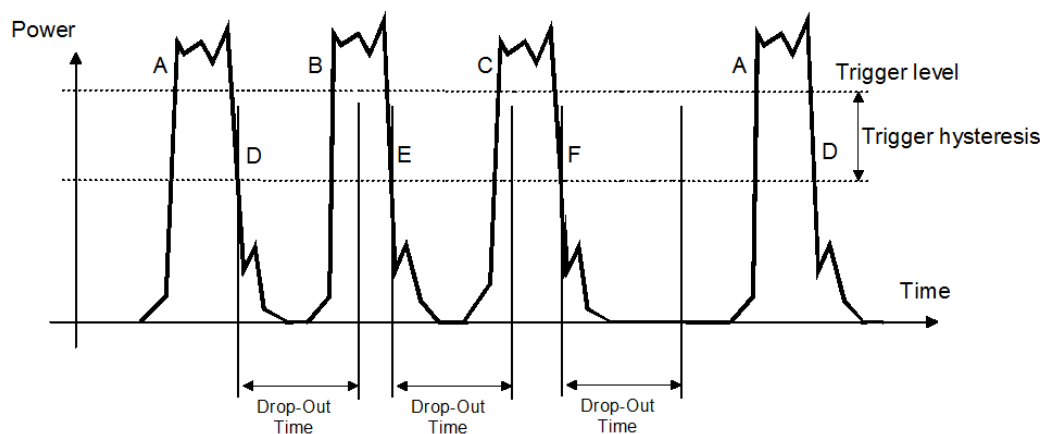

Figure 6-2: Significance of the dropout time

The RF power between the slots is below the threshold defined by the trigger level and the trigger hysteresis. Therefore, the trigger hysteresis alone cannot prevent triggering at B or at C. Therefore, set the dropout time greater than the time elapsed between points D and B and between E and C, but smaller than the time elapsed between F and A. Thus, you ensure that triggering takes place at A.

Because the mechanism associated with the dropout time is reactivated whenever the trigger threshold is crossed, you can obtain also unambiguous triggering for many complex signals.

If you use a hold-off time instead of a dropout time, you can obtain stable triggering conditions - regular triggering at the same point. But you cannot achieve exclusive triggering at A.

6.1.3.4 Hold-off time

During the hold-off time, a period after a trigger event, all trigger events are ignored.

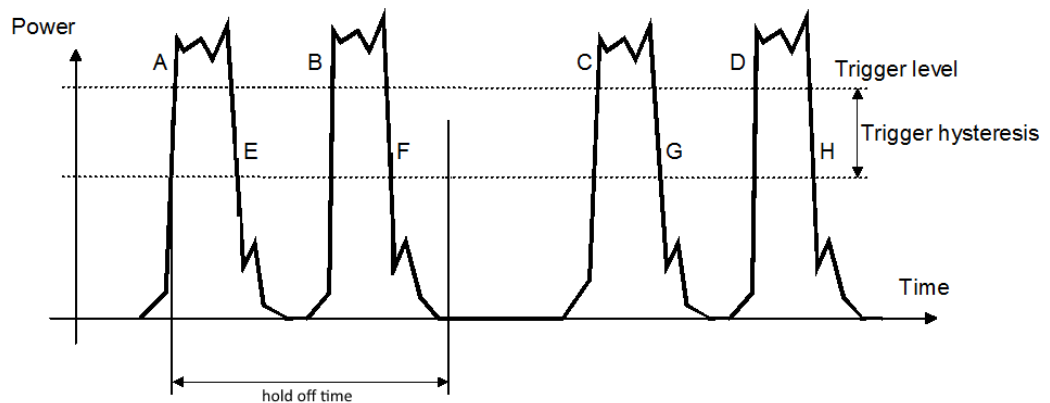

6.1.3.5 Trigger settings

Access: Main measurement dialog > "Trigger"

For trace or pulse analysis measurements, the access is: Main measurement dialog > "Trigger" > "Sensor Trigger"

Trigger Mode.....	66
Trigger Source.....	66
Trigger Level.....	66
Trigger Advanced.....	66
L Source.....	66
L Slope.....	66
L Level.....	67
L Delay.....	67
L Dropout.....	67
L Holdoff.....	67
L Hysteresis.....	67
Specific Trigger.....	67
L Jitter Suppression.....	67
L Trigger Sender State.....	68
L Trigger Sender Port.....	68
L Trigger Synchronize State.....	68
L Trigger Synchronize Port.....	68
L Trigger 2 Input Impedance.....	68

Trigger Mode

Controls the trigger execution depending on the settings under ["Trigger Source"](#) on page 66.

"Normal"	Continuous triggering with regular trigger events.
"Freerun"	Enables a continuous measurement. The power sensor executes one measurement cycle after the other.
"Single"	Disables continuous triggering so that only one trigger event at a time is executed. To enable triggering again, press [1Trig].
"Auto"	Automatically starts a measurement if no trigger event has occurred after 300 ms.

Remote command:

```
TRIGger<undef>:ALL:MODE
```

```
TRIGger<Measurement>:MODE
```

Trigger Source

For primary and secondary power sensors.

Sets the source for the trigger event. See [Chapter 6.1.3.2, "Trigger sources"](#), on page 63.

Remote command:

```
TRIGger<undef>:ALL:SOURce
```

```
TRIGger<Measurement>[:CHANnel<Channel>]:SOURce
```

Trigger Level

For primary and secondary power sensors.

Sets the trigger threshold for internal triggering derived from the test signal.

The trigger level is displayed as dotted red line. The trigger time is displayed as small rhomb on the trigger level line.

Remote command:

```
TRIGger<undef>:ALL:LEVel
```

```
TRIGger<Measurement>[:CHANnel<Channel>]:LEVel
```

Trigger Advanced

For primary and secondary power sensors.

Groups further trigger settings.

Source ← Trigger Advanced

See ["Trigger Source"](#) on page 66.

Slope ← Trigger Advanced

Determines which edge of the envelope power (internal triggering) or increasing voltage (external triggering) is used for triggering.

"Positive" Rising edge

"Negative" Falling edge

Remote command:

```
TRIGger<undef>:ALL:SLOPe
```

```
TRIGger<Measurement>[:CHANnel<Channel>]:SLOPe
```

Level ← Trigger Advanced

See "Trigger Level" on page 66-

Delay ← Trigger Advanced

Sets the delay between the trigger event and the beginning of the actual measurement.

Remote command:

```
TRIGger<undef>:ALL:DELay[:VALue]
```

```
TRIGger<Measurement>[:CHANnel<Channel>]:DELay[:VALue]
```

Dropout ← Trigger Advanced

If the trigger level has been underrun with internal triggering, it is sometimes useful to wait some time (drop-out time) before retriggering. The measurement of unwanted signal components can thus be suppressed. See [Chapter 6.1.3.3, "Dropout time"](#), on page 64.

Remote command:

```
TRIGger<undef>:ALL:DTIME
```

```
TRIGger<Measurement>[:CHANnel<Channel>]:DTIME
```

Holdoff ← Trigger Advanced

Sets the hold-off time, see [Chapter 6.1.3.4, "Hold-off time"](#), on page 65.

Remote command:

```
TRIGger<undef>:ALL:HOLDoff
```

```
TRIGger<Measurement>[:CHANnel<Channel>]:HOLDoff
```

Hysteresis ← Trigger Advanced

Sets the hysteresis. A trigger event occurs, if the trigger level:

- Falls below the set value on a rising slope.
- Rises above the set value on a falling slope.

Thus, you can use this setting to eliminate the effects of noise in the signal for the edge detector of the trigger system.

Remote command:

```
TRIGger<undef>:ALL:HYSTeresis
```

```
TRIGger<Measurement>[:CHANnel<Channel>]:HYSTeresis
```

Specific Trigger

Not available for each sensor type. Groups the specific trigger settings.

Jitter Suppression ← Specific Trigger

Defines the method how to cope with the misalignment between the trigger event and the sample point.

"Compensate" Compensation means resampling of trace result.

"Measure" Does not perform resampling, but stores the measured trigger jitter.

Remote command:

```
TRIGger<Measurement>[:CHANnel<Channel>]:JITTer:METhod
```

Trigger Sender State ← Specific Trigger

Enables or disables the power sensor as trigger sender. If enabled, the power sensor outputs a digital trigger signal in sync with its own trigger event. The trigger signal is output at the port selected under "[Trigger Sender Port](#)" on page 68.

The trigger sender has to use its internal trigger source. Set the trigger source for the trigger receivers to "Internal [A to D]", where [A to D] is the port to which the trigger sender is connected. The trigger signal generated by the trigger sender is routed to the R&S NRX and from there it is distributed to the trigger receivers and, if [Trigger Source for Trigger Output](#) is set to "Sensor [A to D]", also to the trigger output.

Remote command:

```
TRIGger<Measurement>[:CHANnel<Channel>]:SENDER[:STATe]
```

Trigger Sender Port ← Specific Trigger

Sets the port where the trigger sender sensor outputs a digital trigger signal.

Remote command:

```
TRIGger<Measurement>[:CHANnel<Channel>]:SENDER:PORT
```

Trigger Synchronize State ← Specific Trigger

Usually used if "On" is set under "[Trigger Sender State](#)" on page 68.

If enabled, blocks the external trigger bus as long as the power sensor remains in the measurement state. Thus, ensures that a new measurement is only started after all power sensors have completed their measurements.

Make sure that the number of repetitions is the same for all power sensors involved in the measurement. Otherwise, the trigger bus is blocked by any power sensor that has completed its measurements before the others and has returned to the idle state.

Remote command:

```
TRIGger<undef>:ALL:SYNChronize[:STATe]
```

```
TRIGger<Measurement>[:CHANnel<Channel>]:SYNChronize[:STATe]
```

Trigger Synchronize Port ← Specific Trigger

Sets the internal or external connection for the sync output of the sensor. For more information, see "[Trigger Synchronize State](#)" on page 68.

Remote command:

```
TRIGger<Measurement>[:CHANnel<Channel>]:SYNChronize:PORT
```

Trigger 2 Input Impedance ← Specific Trigger

Requires a power sensor with a trigger input.

Sets the termination resistance of the external trigger signal that is supplied at the trigger input/output of the power sensor. Choose a setting that fits the impedance of the trigger source to minimize reflections on the trigger signals.

Remote command:

```
TRIGger<Measurement>[:CHANnel<Channel>]:EXTErnal<Port>:IMPedance
```

6.1.4 Measurement settings dialog

Access: In the main measurement dialog, tap the *displayed measurement value or graphic*. See also "[Layout of the main measurement dialog](#)" on page 35.

In this dialog, you select the measurement type and the channel calculation function. Based on the selected measurement and function, you can assign one or two sensors. The assigned sensors are called primary sensor and secondary sensor.

The functions described here apply to the continuous average, burst average, trace, pulse analysis, time gate, timeslot. For the other measurements, see:

- Statistics: [Chapter 6.8.3, "Measurement Settings dialog"](#), on page 104
- NRT: [Chapter 6.9.3, "Measurement Main Configuration dialog"](#), on page 113

For configuring the assigned power sensors, see:

- [Quick Setup](#)
- [Chapter 7, "Sensor configuration"](#), on page 115

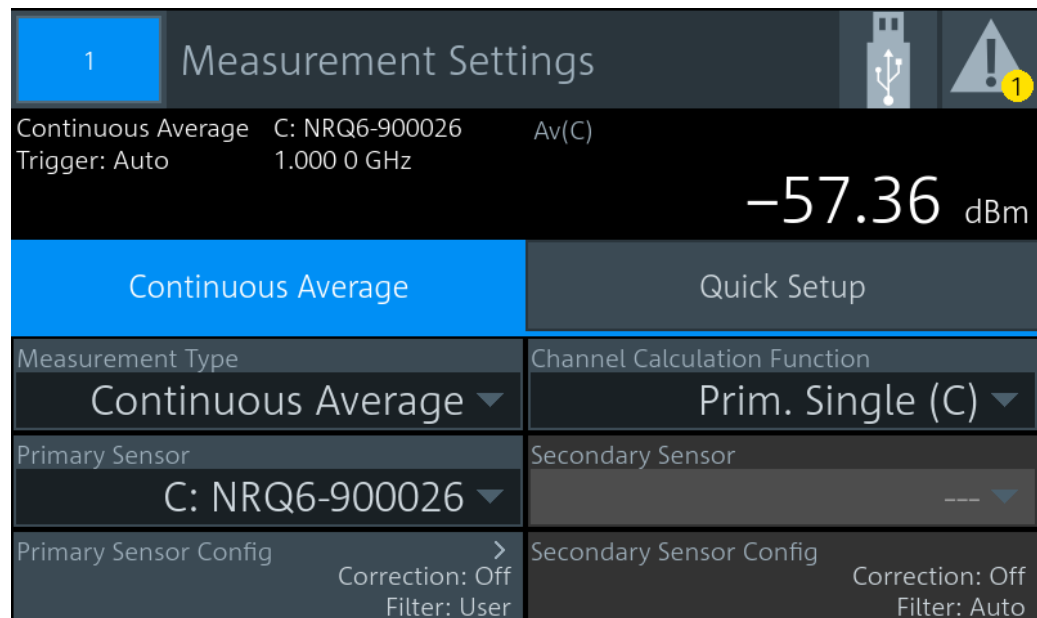

Figure 6-3: Example: continuous average

Measurement Type.....	69
Primary Sensor, Secondary Sensor.....	70
Primary Sensor Config, Secondary Sensor Config.....	70
Channel Calculation Function.....	70
Quick Setup.....	71
L Parameter Set.....	71
L Auto Set.....	71
L Preserve Window Settings.....	71
L Recall Parameter Set.....	72

Measurement Type

Sets the measurement type.

Remote command:

[CALCulate<Measurement>:TYPE](#) on page 241

Primary Sensor, Secondary Sensor

Available for continuous average, burst average, trace, pulse analysis, time gate, time-slot measurements.

Assigns the primary or secondary sensor. You can choose any of the sensors that are connected to a sensor port of the R&S NRX. The port letter, to which the sensor is connected, is displayed in front of the hostname of the sensor.

Example: C: NRP33SN-104711; C is the port, NRP33SN-104711 is the sensor name.

If "Prim. Single" is set under [Channel Calculation Function](#), the secondary sensor is disabled.

If a power sensor does not support the selected [Measurement Type](#), a settings conflict is displayed. See also [Chapter 5.5, "Settings conflict"](#), on page 50.

Remote command:

[CALCulate<Measurement>\[:CHANnel<Channel>\]:SENSe:INDeX](#) on page 242

[\[SENSe<Sensor>:\]CATalog?](#) on page 242

Primary Sensor Config, Secondary Sensor Config

Available for continuous average, burst average, trace, pulse analysis, time gate, time-slot measurements.

For configuring the primary and secondary sensors, assigned under [Primary Sensor, Secondary Sensor](#).

See [Chapter 7, "Sensor configuration"](#), on page 115.

Channel Calculation Function

Available for continuous average, burst average, trace, pulse analysis, time gate, time-slot measurements.

You can combine the measured values from the primary and secondary sensor using a mathematical function. The primary and secondary sensors are assigned under [Primary Sensor, Secondary Sensor](#).

Apart from the "Prim. Single" function, all functions require values measured by two sensors.

Channel Calculation Function	
Prim. Single (C)	Ratio (C / A)
<input checked="" type="checkbox"/> SWR (C,A)	Refl. Coefficient (C,A)
Return Loss (C,A)	Refl. Ratio (C,A)
Sum (C + A)	Diff (C - A)
Off	

The letters in brackets indicate the port to which the primary or secondary sensor is connected. In this example, the primary sensor is connected to port C, and the secondary sensor is connected to port A.

Remote command:

[CALCulate<Measurement>:MATH\[:EXPRession\]](#) on page 328

[CALCulate<Measurement>:MATH\[:EXPRession\]:CATalog?](#) on page 329

Quick Setup

Available for continuous average, burst average, trace, pulse analysis, time gate, time-slot measurements.

Groups the settings for quick sensor configuration. Alternatively, you can use [Primary Sensor Config](#), [Secondary Sensor Config](#).

Parameter Set ← Quick Setup

Selects a parameter set to preconfigure the power sensor. Tap [Recall Parameter Set](#) to load the selected set.

See [Chapter 13.8.6.2, "Preconfigured settings"](#), on page 353.

Remote command:

[SYSTem:STANdard:PRESet](#) on page 351

Auto Set ← Quick Setup

Configures the power sensor automatically.

Preserve Window Settings ← Quick Setup

Specifies whether the display settings are kept unchanged when tapping [Recall Parameter Set](#).

Off Configures the power sensor and the display settings of the R&S NRX. See [Chapter 13.8.6.3, "Display configuration"](#), on page 363.

On Only configures the power sensor.

Remote command:

`SYSTem:STANdard:PWSettings` on page 352

Recall Parameter Set ← Quick Setup

Loads the parameters set selected under [Parameter Set](#).

Remote command:

`SYSTem:STANdard:PRESet` on page 351

6.2 Continuous average

The power sensor measures the signal average power asynchronously within a defined time interval, the so-called aperture or sampling window. After a trigger event, the power is integrated over the time interval.

The continuous average measurement type is the preferred measurement method if the measurement is not to be, or cannot be, synchronized with a specific signal event. It is the only available measurement type for thermal power sensors because they are too slow for the other measurement types.

6.2.1 Continuous average result display

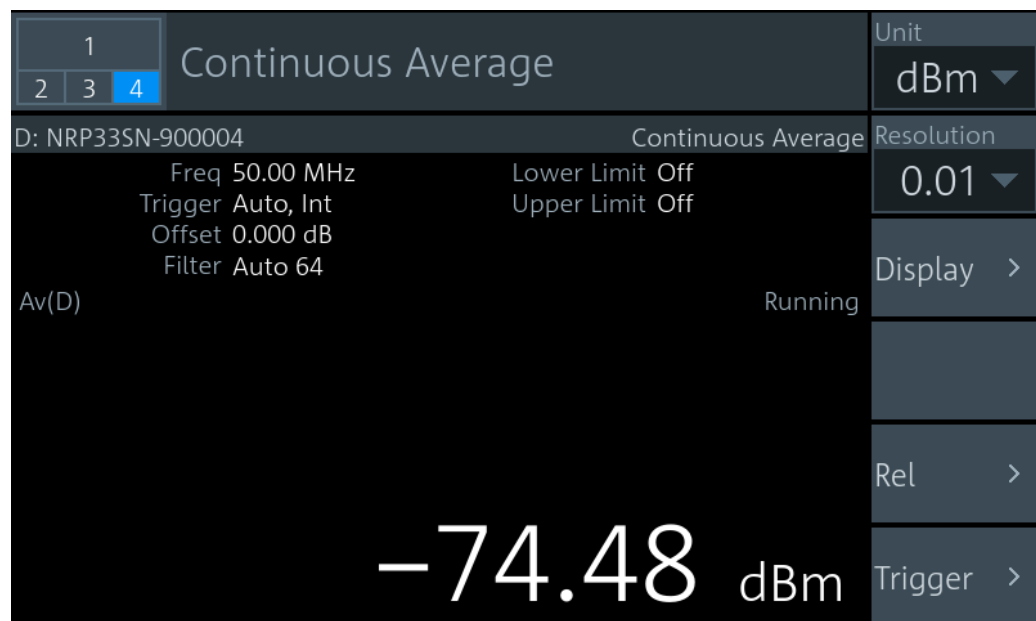

The measurement result is a single scalar value, either an absolute value or related to a reference value.

6.2.2 Continuous average settings

Access: "Measurement Settings" > "Measurement Type" > "Continuous Average"

Unit.....	73
Resolution.....	73
Display.....	73
Rel.....	73
L Reference Value.....	73
L Relative Measurements.....	74
Trigger.....	74

Unit

See "Unit" on page 54.

Resolution

See "Resolution" on page 54.

Display

See Chapter 6.1.1, "Display settings", on page 52.

Rel

Groups the settings for relative measurements.

Reference Value ← Rel

Available if [Relative Measurements](#) is set to "On" or "Set".

Sets the reference value.

Remote command:

`CALCulate<Measurement>:RELative<DirectionalChannel>[:MAGNitude]`
on page 243

`CALCulate<Measurement>:RELative<DirectionalChannel>:CCDF`
on page 320

`CALCulate<Measurement>:RELative<DirectionalChannel>:POWER[:MAGNitude]` on page 320

`CALCulate<Measurement>:RELative<DirectionalChannel>:RATio:RCOefficient` on page 321

`CALCulate<Measurement>:RELative<DirectionalChannel>:RATio:RFRatio` on page 321

`CALCulate<Measurement>:RELative<DirectionalChannel>:RATio:RLOSS`
on page 321

`CALCulate<Measurement>:RELative<DirectionalChannel>:RATio:SWR`
on page 322

`CALCulate<Measurement>:RELative<DirectionalChannel>:RATio[:MAGNitude]` on page 322

`[SENSe<Sensor>:] POWER:REFerence` on page 245

Relative Measurements ← Rel

Allows you to relate measured power or a power ratio to a reference value. Whether the power is measured by one power sensor or whether it is a combined value measured by two power sensors, is set by "[Channel Calculation Function](#)" on page 70.

Off	Absolute power or power ratio
On	Relative power or power ratio. As reference value, the value specified under Reference Value is used.
Set	Uses the current measurement result as reference value and enables the relative measurement.

Remote command:

`CALCulate<Measurement>:RELative<DirectionalChannel>:STATE`

on page 244

`CALCulate<Measurement>:RELative<DirectionalChannel>[:MAGNitude]:`

`AUTO` on page 243

Trigger

See [Chapter 6.1.3, "Triggering"](#), on page 63.

6.3 Burst average

The power sensor measures the average burst power of pulsed signals. The burst average measurement is available with multipath and wideband power sensors.

No external trigger signal is required, because the power sensor detects the start and end of the burst itself. The time interval in which the average power is measured starts when the power exceeds the trigger level and ends when the trigger logic detects the end of the pulse.

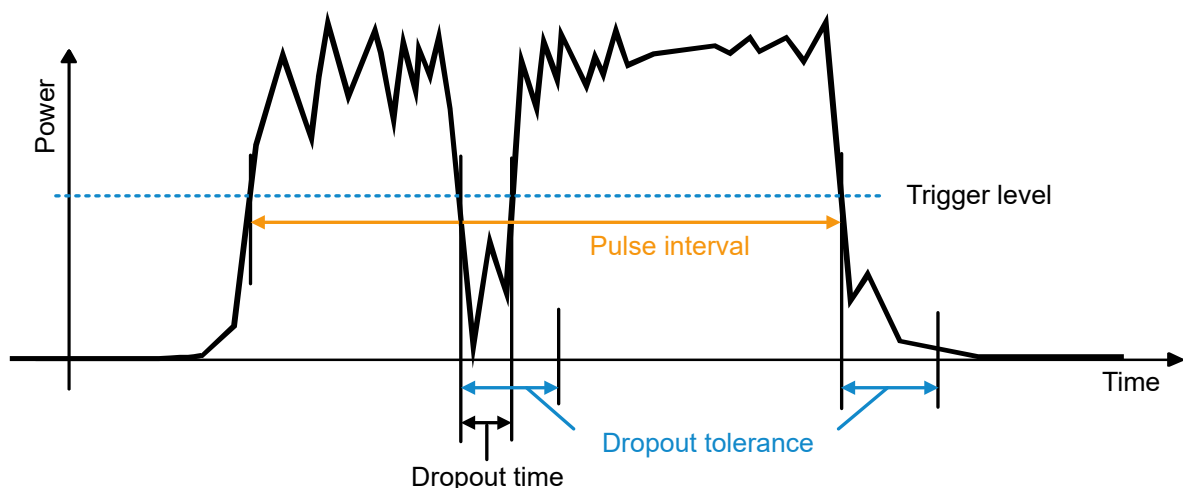

Figure 6-4: Burst average measurement parameters

To prevent power drops due to modulation from being erroneously interpreted as the end of a pulse, you must define the dropout tolerance. The dropout tolerance is a time

interval in which the pulse end is only recognized if the signal level no longer exceeds the trigger level.

Useful parameters:

- "Trigger Level" on page 66
- "Dropout" on page 67
- "Dropout Tolerance" on page 118
- "Exclude from Start, Exclude from End" on page 118

6.3.1 Burst average result display

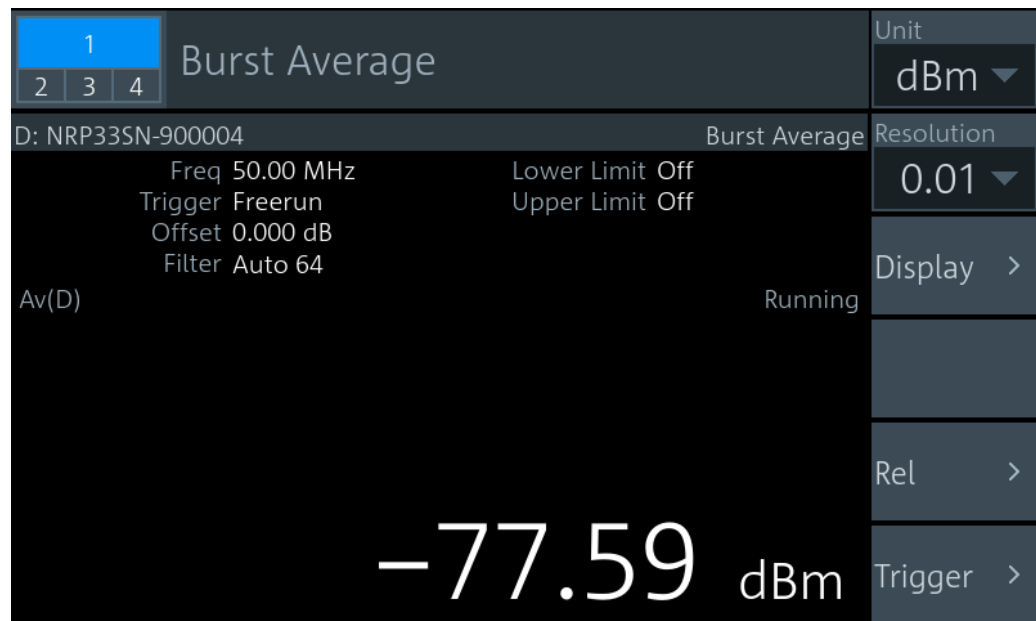

The measurement result is a single scalar value, either an absolute value or related to a reference value.

6.3.2 Burst average settings

Access: "Measurement Settings" > "Measurement Type" > "Burst Average"

Unit.....	75
Resolution.....	75
Display.....	76
Rel.....	76
Trigger.....	76

Unit

See "Unit" on page 54.

Resolution

See "Resolution" on page 54.

Display

See [Chapter 6.1.1, "Display settings"](#), on page 52.

Rel

See ["Rel"](#) on page 73.

Trigger

See [Chapter 6.1.3, "Triggering"](#), on page 63.

6.4 Trace

The power sensor measures power over time. Define the number of measurement points and the measurement time. The length of an individual measurement is determined from the ratio of total time and the defined number of measurement points. The entire result is called a "trace". Each trace must be triggered separately.

- [Trace result display](#)..... 76
- [Trace settings](#).....77
- [Trace Marker dialog](#)..... 78

6.4.1 Trace result display

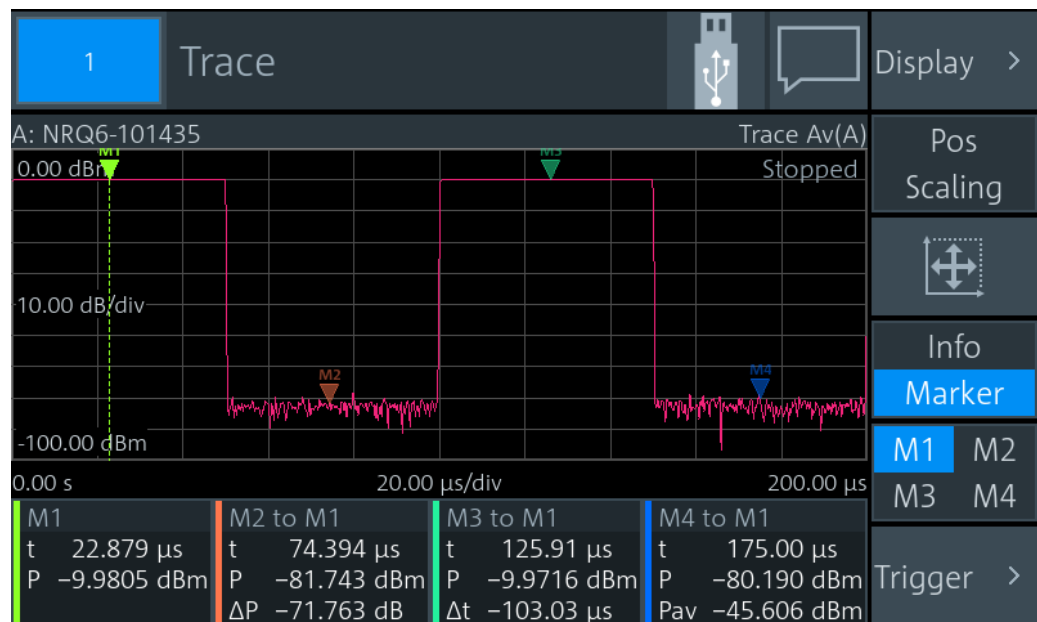

Displays the waveform. Use the markers to determine exact x- and y-values. In sum, 4 markers are provided for the 2 traces. See also ["Info / Marker"](#) on page 77.

6.4.2 Trace settings

Access: "Measurement Settings" > "Measurement Type" > "Trace"

Display.....	77
Pos / Scaling.....	77
Autoscale.....	77
Info / Marker.....	77
M1 / M2 / M3 / M4.....	77
Trigger.....	78
L Display.....	78
L Trig Mode.....	78
L Trig Source.....	78
L Trig Slope.....	78
L Level.....	78
L Sensor Trigger.....	78

Display

See [Chapter 6.1.1, "Display settings"](#), on page 52.

Pos / Scaling

Defines the effect of the cursor keys on the displayed trace.

"Pos"	Shifts the position. Press one of the cursor keys to shift the trace in x- and y-direction.
"Scaling"	Changes the scaling. Press one of the cursor keys to expand or compress the trace.



Autoscale

Adapts the scaling of the power axis to the trace. The scaling of the time axis is adapted only if the power sensor supports it.

Info / Marker

Shows or hides additional information below the graph.

"Info"	Displays measurement settings.
"Marker"	Displays the marker results according to the set measurement, see "Measurement Mode" on page 81. If you tap here, the "Trace Marker" dialog opens, see Chapter 6.4.3, "Trace Marker dialog" , on page 78. Shows buttons to select a marker, see "M1 / M2 / M3 / M4" on page 77.

Remote command:

`CALCulate<Measurement>:DMODE` on page 198

M1 / M2 / M3 / M4

Shows the selected marker in the trace.

Remote command:

`DISPlay[:WINDow<Window>]:TRACe:MARKer<Undef>:SELection` on page 278

Trigger

Gives quick access to selected trigger settings.

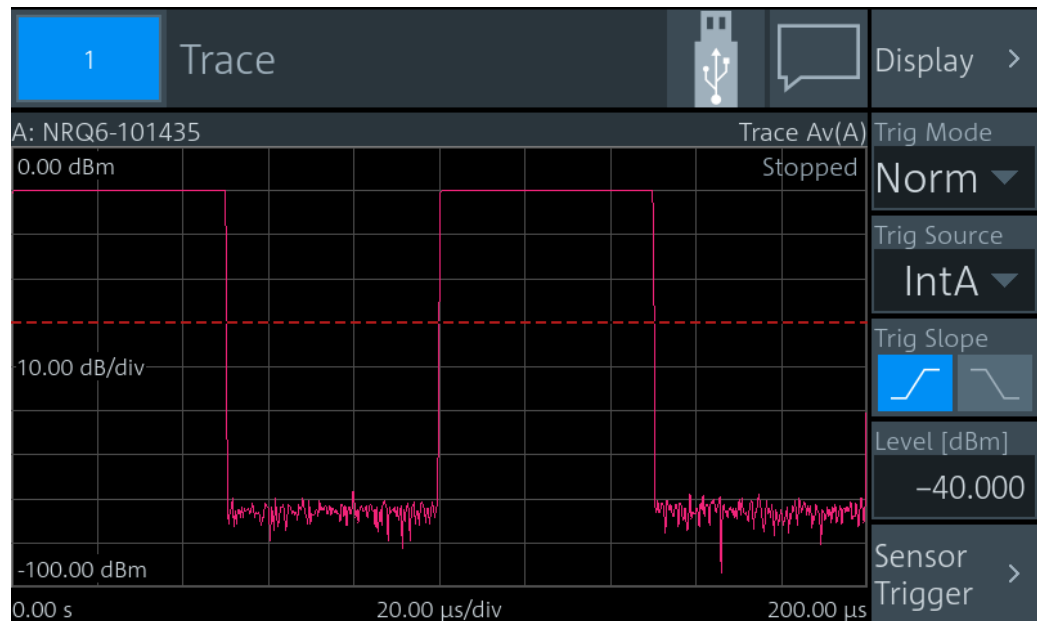

Shows the trace. The trigger level is indicated as dotted red line.

Display ← Trigger

See [Chapter 6.1.1, "Display settings"](#), on page 52.

Trig Mode ← Trigger

See ["Trigger Mode"](#) on page 66.

Trig Source ← Trigger

See ["Trigger Source"](#) on page 66.

Trig Slope ← Trigger

See ["Slope"](#) on page 66.

Level ← Trigger

See ["Trigger Level"](#) on page 66.

Sensor Trigger ← Trigger

See [Chapter 6.1.3, "Triggering"](#), on page 63.

6.4.3 Trace Marker dialog

Access: Select [Marker](#) and tap the marker results that are displayed below the trace.

Used for configuring markers. Each marker is configured individually. Select the marker you want to configure.

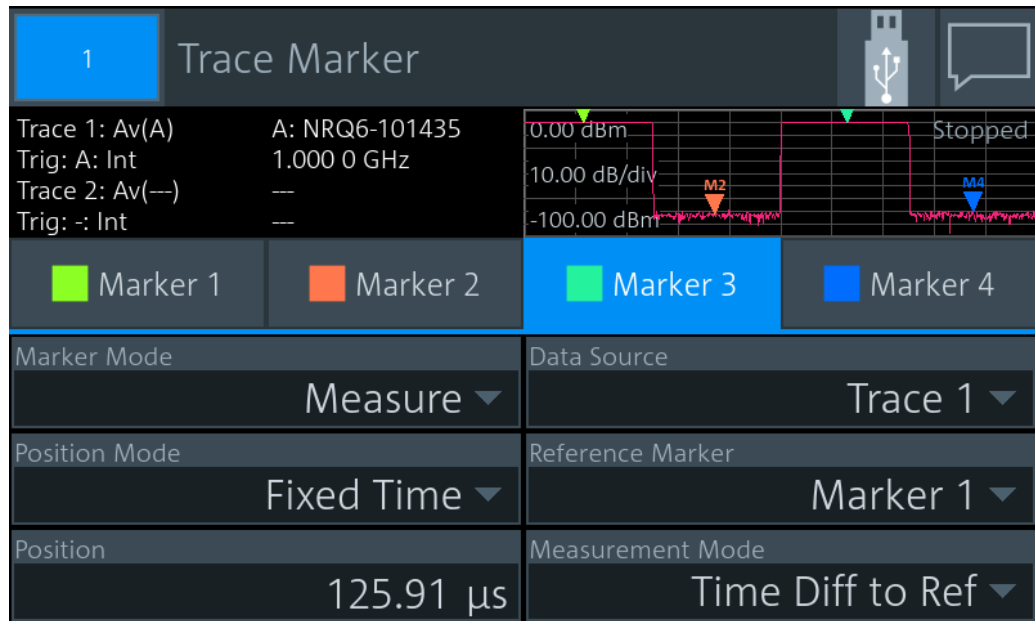

Marker Mode.....	79
Position Mode.....	79
Position.....	80
Data Source.....	81
Reference Marker.....	81
Measurement Mode.....	81

Marker Mode

Enables or disables the marker. Also defines the appearance of the marker.

- "Off" Disables the marker.
- "Ruler" Shows a line at the marker position. Useful if you use the marker as [Reference Marker](#).
- "Measure" Shows a triangle at the marker position.

Remote command:

`DISPlay[:WINDow<Window>]:TRACe:MARKer<Marker>:MODE` on page 274

Position Mode

Defines where the marker is placed.

- "Fixed Time" At a fixed time, set by [Position](#).
- "Fixed Power" At a fixed power value, set by [Position](#).
- "Relative to Ref Position"
 - At a time difference of [Position](#) to the x-position of the [Reference Marker](#).
- "Relative to Ref Power"
 - At a power difference of [Position](#) to the y-position of the [Reference Marker](#).

"From Ref Power <-"

Starting from the right border, at a power difference of **Position** to the y-position of the **Reference Marker**.

"From Ref Power ->"

Starting from the left border, at a power difference of **Position** to the y-position of the **Reference Marker**.

"Peak Search" Measured maximum power

"Min Search" Measured minimum power

"Peak Search from Ref <-", "Min Search from Ref <-"

Maximum or minimum power measured left from the **Reference Marker**.

"Peak Search from Ref ->", "Min Search from Ref ->"

Maximum or minimum power measured right from the **Reference Marker**.

Remote command:

`DISPlay[:WINDow<Window>]:TRACe:MARKer<Marker>:POSition:MODE`
on page 274

Position

Sets an absolute or relative time or power value for the marker position defined under **Position Mode**.

Remote command:

`DISPlay[:WINDow<Window>]:TRACe:MARKer<Marker>:POSition:TIME`
on page 278

`DISPlay[:WINDow<Window>]:TRACe:MARKer<Marker>:POSition:RELative:TIME` on page 278

`DISPlay[:WINDow<Window>]:TRACe:MARKer<Marker>:POSition:POWer:DBM`
on page 275

`DISPlay[:WINDow<Window>]:TRACe:MARKer<Marker>:POSition:POWer:DBUV` on page 275

`DISPlay[:WINDow<Window>]:TRACe:MARKer<Marker>:POSition:POWer:WATT` on page 277

`DISPlay[:WINDow<Window>]:TRACe:MARKer<Marker>:POSition:RELative:POWer:DB` on page 276

`DISPlay[:WINDow<Window>]:TRACe:MARKer<Marker>:POSition:RELative:POWer:DPCT` on page 276

`DISPlay[:WINDow<Window>]:TRACe:MARKer<Marker>:POSition:RELative:POWer:O` on page 277

`DISPlay[:WINDow<Window>]:TRACe:MARKer<Marker>:POSition:RELative:POWer:WATT` on page 277

`DISPlay[:WINDow<Window>]:TRACe:MARKer<Marker>:POSition:POWer:RATio:DB` on page 276

`DISPlay[:WINDow<Window>]:TRACe:MARKer<Marker>:POSition:POWer:RATio:DPCT` on page 276

`DISPlay[:WINDow<Window>]:TRACe:MARKer<Marker>:POSition:POWer:RATio:O` on page 277

Data Source

Available if "Measure" is set under [Marker Mode](#).

Selects the trace.

Remote command:

`DISPlay[:WINDow<Window>]:TRACe:MARKer<Marker>:FEED:INDEX`
on page 272

Reference Marker

Defines a marker as reference marker.

Remote command:

`DISPlay[:WINDow<Window>]:TRACe:MARKer<Marker>:REFerence`
on page 278

Measurement Mode

Available if "Measure" is set under [Marker Mode](#).

Defines the measurement. The marker result is displayed under [Info / Marker](#).

"Trace Value " Measures the power of the trace.
Marker result is "p".

"Power Ratio to Ref"
Measures the power ratio in relation to the reference marker.
Marker result is " Δp ".

"Time Diff to Ref"
Measures the time difference in relation to the reference marker.
Marker result is " Δt ".

"Average Power to Ref"
Measures the average power between time positions of the marker
and its reference marker.
Marker result is "Pav".

Remote command:

`DISPlay[:WINDow<Window>]:TRACe:MARKer<Marker>:FUNction` on page 273

6.5 Pulse analysis

Supported by wideband power sensors. Use this measurement type for automatic analysis of pulsed signals. You can measure either power over time over the whole trace, or restrict the measurement to a defined portion of the pulse signal. Trigger each trace separately.

- [Pulse analysis result display](#)..... 82
- [Pulse analysis settings](#)..... 82
- [Pulse Analysis dialog](#)..... 83

6.5.1 Pulse analysis result display

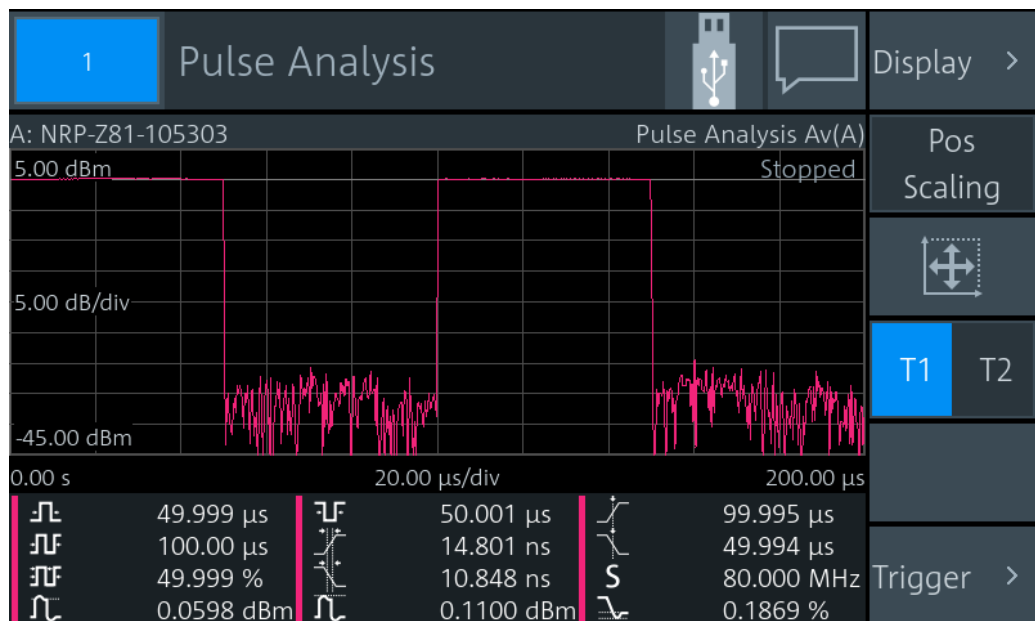

Shows a pulse signal in trace presentation. 2 traces are available. The measurement results are displayed below the trace. Each measurement result is represented by a symbol that is also used to select the result. You can choose which results you want to display, see [Chapter 6.5.3, "Pulse Analysis dialog"](#), on page 83.

6.5.2 Pulse analysis settings

Access: "Measurement Settings" > "Measurement Type" > "Pulse Analysis"

Display.....	82
Pos / Scaling.....	82
Autoscale.....	82
T1 / T2.....	82
Trigger.....	83

Display

See [Chapter 6.1.1, "Display settings"](#), on page 52.

Pos / Scaling

See ["Pos / Scaling"](#) on page 77.



Autoscale

See ["Autoscale"](#) on page 77.

T1 / T2

Selects the displayed trace.

Remote command:

`DISPlay[:WINDow<Window>]:TRACe:MEASurement:SELECTION` on page 292

Trigger

Gives quick access to selected trigger settings. See ["Trigger"](#) on page 78.

6.5.3 Pulse Analysis dialog

Access: Tap the measurement results that are displayed below the trace.

On the "Time" and "Power" tabs, select the measurement results that are displayed below the trace. The R&S NRX can display a maximum of 12 measurement results. If you select more, a warning is displayed.

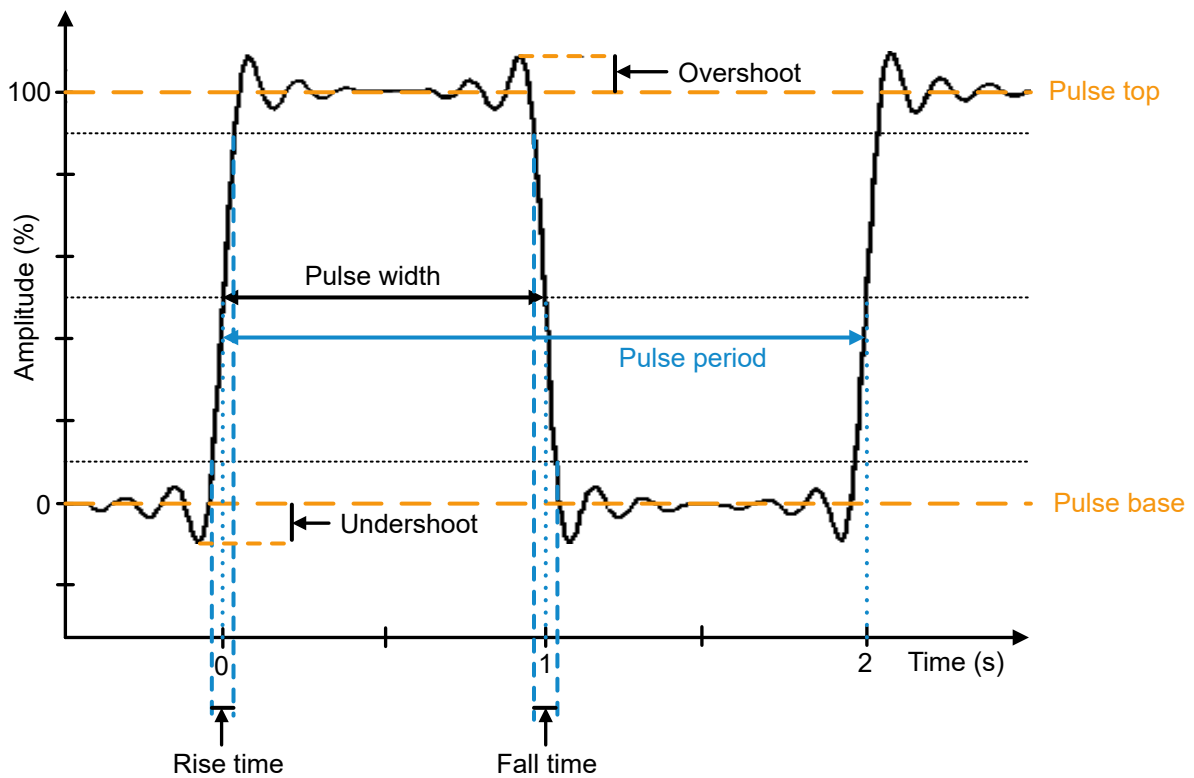

Figure 6-5: Main pulse analysis parameters and characteristic values

Time tab.....	84
L Pulse Width.....	84
L Pulse Period.....	85
L Duty Cycle.....	85
L Pulse Off Time.....	85
L Rise Time.....	85
L Fall Time.....	85
L Start Time.....	86
L Stop Time.....	86
L Sampling Rate.....	86
Power tab.....	86
L Pulse Top.....	87
L Trace Peak.....	87

L Neg. Overshoot.....	87
L Pulse Base.....	88
L Trace Min.....	88
L High Ref.....	88
L Trace Avg.....	88
L Pos. Overshoot.....	88
L Low Ref.....	89
Configuration tab.....	89
L Reference Levels relate to.....	89
L Algorithm.....	89
L High Reference Level.....	90
L Reference Level.....	90
L Low Reference Level.....	90
L Reset to Defaults.....	90

Time tab

Selects the time-related measurement results that are displayed below the trace. The selections on this tab apply to all traces.

The screenshot shows the 'Pulse Analysis (all Traces)' window. At the top, there is a title bar with a '1' icon and a USB icon. Below the title bar, there is a table of measurement parameters:

Pulse 1: Av(A)	A: NRP-Z81-105303	5.00 dBm	Stopped
Trig: A: Int	1.000 0 GHz	5.00 dB/div	
Pulse 2: Av(---)	---	-45.00 dBm	
Trig: -: Int	---		

Below the table, there are several measurement parameters with icons indicating their status:

Pulse Width	Pulse Off Time	Start Time
Pulse Period	Rise Time	Stop Time
Duty Cycle	Fall Time	Sampling Rate

At the bottom, there are three tabs: 'Time' (selected), 'Power', and 'Configuration'.



Pulse Width ← Time tab

Time between the first positive edge and the subsequent negative edge of the pulse, where the edges occur at crossings of the mid threshold.

Remote command:

`DISPlay[:WINDow<Window>]:TRACe:MEASurement:PULSe:DURation[:STATE]` on page 291

`CALCulate<Measurement>:TRACe:MEASurement:PULSe:DURation?` on page 285

**Pulse Period ← Time tab**

Time between two consecutive edges of the same polarity in seconds. During this time, the pulse signal completes one cycle.

Remote command:

`DISPlay[:WINDow<Window>]:TRACe:MEASurement:PULSe:PERiod[:STATe]`
on page 291

`CALCulate<Measurement>:TRACe:MEASurement:PULSe:PERiod?` on page 285

**Duty Cycle ← Time tab**

$$\text{Duty cycle} = \frac{\text{Pulse width}}{\text{Pulse period}}$$

The ratio is expressed as a value between 0 and 1.

Remote command:

`DISPlay[:WINDow<Window>]:TRACe:MEASurement:PULSe:DCYClE[:STATe]`
on page 290

`CALCulate<Measurement>:TRACe:MEASurement:PULSe:DCYClE?` on page 285

**Pulse Off Time ← Time tab**

Time between the first negative edge and the subsequent positive edge of the pulse in seconds, where the edges occur at crossings of the mid threshold. During this time, the pulse remains at the pulse base level.

Remote command:

`DISPlay[:WINDow<Window>]:TRACe:MEASurement:PULSe:SEParation[:STATe]`
on page 292

`CALCulate<Measurement>:TRACe:MEASurement:PULSe:SEParation?`
on page 286

**Rise Time ← Time tab**

Time the pulse requires to transition from the pulse base level to the pulse top level.

Remote command:

`DISPlay[:WINDow<Window>]:TRACe:MEASurement:TRANSition:POSitive:DUration[:STATe]`
on page 294

`CALCulate<Measurement>:TRACe:MEASurement:TRANSition:POSitive:DUration?`
on page 287

**Fall Time ← Time tab**

Time the pulse requires to transition from the pulse top level to the pulse base level.

Remote command:

`DISPlay[:WINDow<Window>]:TRACe:MEASurement:TRANSition:NEGative:DUration[:STATe]`
on page 293

`CALCulate<Measurement>:TRACe:MEASurement:TRANSition:NEGative:DUration?`
on page 286

**Start Time ← Time tab**

Time when the signal passes through the medial reference power level with rising edge, referenced to the delayed trigger event. Indicates the start point of the first power pulse within the analysis window.

Remote command:

`DISPlay[:WINDow<Window>]:TRACe:MEASurement:TRANSition:POSitive:OCCurrence[:STATe]` on page 294

`CALCulate<Measurement>:TRACe:MEASurement:TRANSition:POSitive:OCCurrence?` on page 287

**Stop Time ← Time tab**

Time when the signal passes through the medial reference power level with falling edge, referenced to the delayed trigger event. Indicates the stop point of the first power pulse within the analysis window.

Remote command:

`DISPlay[:WINDow<Window>]:TRACe:MEASurement:TRANSition:NEGative:OCCurrence[:STATe]` on page 293

`CALCulate<Measurement>:TRACe:MEASurement:TRANSition:NEGative:OCCurrence?` on page 286

S**Sampling Rate ← Time tab**

Number of samples per second.

Remote command:

`DISPlay[:WINDow<Window>]:TRACe:MEASurement:PULSe:RESolution[:STATe]` on page 291

`CALCulate<Measurement>:TRACe:MEASurement:TRANSition:SPERiod?` on page 288

Power tab

Selects the power-related measurement results that are displayed below the trace. The selections on this tab apply to all traces.

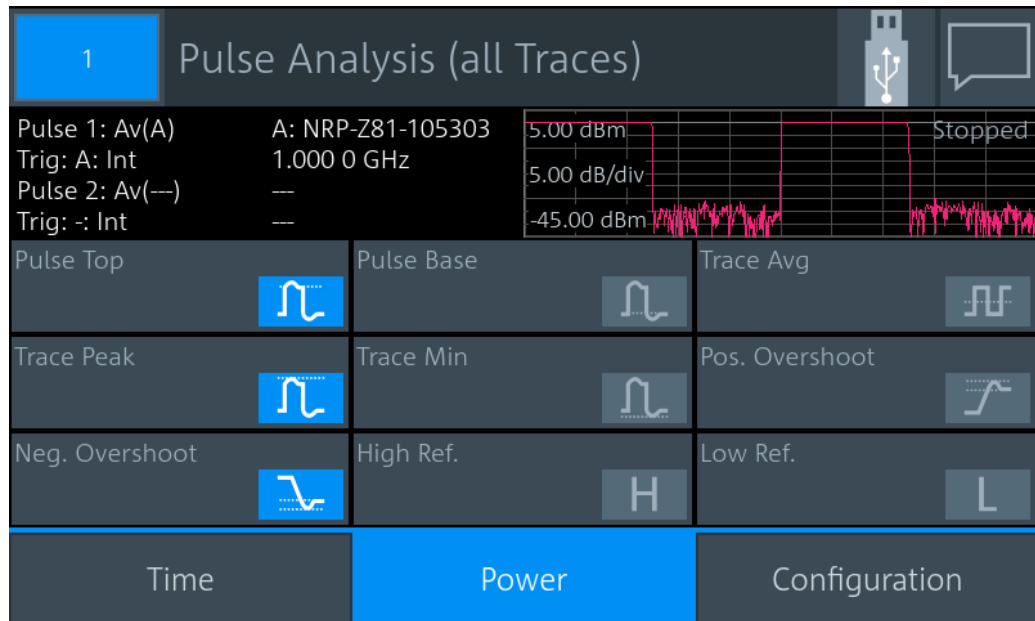

Pulse Top ← Power tab

Pulse top power level detected by the selected [Algorithm](#). This value is used as a reference (100 %) to determine other parameter values such as the rising or falling thresholds.

Remote command:

`DISPlay[:WINDow<Window>]:TRACe:MEASurement:POWer:PULSe:TOP[:STATE]` on page 290

`CALCulate<Measurement>:TRACe:MEASurement:POWer:PULSe:TOP?` on page 284



Trace Peak ← Power tab

Maximum power measured within the analysis window.

Remote command:

`DISPlay[:WINDow<Window>]:TRACe:MEASurement:POWer:MAXimum[:STATE]` on page 288

`CALCulate<Measurement>:TRACe:MEASurement:POWer:MAX?` on page 283



Neg. Overshoot ← Power tab

Height of the local minimum before a rising edge, divided by the pulse amplitude:

$$\text{Negative overshoot} = 100 \% \times \frac{\text{Pulse base power} - \text{minimum power}}{\text{Pulse amplitude}}$$

Depends on the setting under [Reference Levels relate to](#).

Remote command:

`DISPlay[:WINDow<Window>]:TRACe:MEASurement:TRANSition:NEGative:OVERshoot[:STATE]` on page 293

`CALCulate<Measurement>:TRACe:MEASurement:TRANSition:NEGative:OVERshoot?` on page 286

**Pulse Base ← Power tab**

Pulse base power level detected by the selected [Algorithm](#). This value is used as a reference (0 %) to determine other parameter values such as the rising or falling thresholds.

Remote command:

`DISPlay[:WINDow<Window>]:TRACe:MEASurement:POWer:PULSe:BASE[:STATe]` on page 289

`CALCulate<Measurement>:TRACe:MEASurement:POWer:PULSe:BASE?` on page 284

**Trace Min ← Power tab**

Minimum power measured within the analysis window.

Remote command:

`DISPlay[:WINDow<Window>]:TRACe:MEASurement:POWer:MINimum[:STATe]` on page 289

`CALCulate<Measurement>:TRACe:MEASurement:POWer:MIN?` on page 284

**High Ref. ← Power tab**

Power level at [High Reference Level](#).

Remote command:

`DISPlay[:WINDow<Window>]:TRACe:MEASurement:POWer:PULSe:HREFerence[:STATe]` on page 289

`CALCulate<Measurement>:TRACe:MEASurement:POWer:HREFerence?` on page 283

**Trace Avg ← Power tab**

Average power during the time the pulse is active.

Remote command:

`DISPlay[:WINDow<Window>]:TRACe:MEASurement:POWer:AVG[:STATe]` on page 288

`CALCulate<Measurement>:TRACe:MEASurement:POWer:AVG?` on page 283

**Pos. Overshoot ← Power tab**

Height of the local maximum before a falling edge, divided by the pulse amplitude:

$$\text{Positive overshoot} = 100 \% \times \frac{\text{Max. power} - \text{pulse top power}}{\text{Pulse amplitude}}$$

Depends on the setting under [Reference Levels relate to](#).

Remote command:

`DISPlay[:WINDow<Window>]:TRACe:MEASurement:TRANSition:POSitive:OVERshoot[:STATe]` on page 294

`CALCulate<Measurement>:TRACe:MEASurement:TRANSition:POSitive:OVERshoot?` on page 287

**Low Ref. ← Power tab**

Power level at [Low Reference Level](#).

Remote command:

`DISPlay[:WINDow<Window>]:TRACe:MEASurement:POWer:PULSe:`

`LREFerence[:STATe]` on page 290

`CALCulate<Measurement>:TRACe:MEASurement:POWer:LREFerence?`

on page 283

Configuration tab

Defines the reference levels for the pulse timing. All values are specified in percent of the pulse amplitude. The settings on this tab are trace-specific.

The screenshot shows the 'Pulse Analysis (Trace 1)' configuration window. It includes a waveform display at the top right showing a pulse signal with a 'Stopped' status. The main configuration area is divided into several sections:

- Pulse 1:** Av(A) A: NRP-Z81-105303, Trig: A: Int 1.000 0 GHz
- Pulse 2:** Av(---) ---, Trig: -: Int ---
- Reference Levels relate to:** Power (dropdown menu)
- Algorithm:** Histogram (dropdown menu)
- High Reference Level:** 90.000 %
- Reference Level:** 50.000 %
- Low Reference Level:** 10.000 %
- Buttons:** Reset to Defaults (with a download icon), Time, Power, and Configuration (highlighted in blue).

Reference Levels relate to ← Configuration tab

Selects whether the reference levels are voltage-related or power-related.

Remote command:

`DISPlay[:WINDow<Window>]:TRACe:MEASurement:RRELation` on page 292

Algorithm ← Configuration tab

Selects the analysis algorithm for detecting the pulse top and the pulse base power of a pulsed signal. From these power levels, the reference levels are derived.

"Histogram" Analyzes the histogram of the trace data. The average of all points representing the pulse top is taken as pulse top power. Similarly, the pulse base is determined. This algorithm is suitable for most pulse signals.

"Integration" Fits a rectangle pulse of the same energy into the pulse signal as a reference and thus determines the pulse top power.

This algorithm is recommended for:

- Pulse signals with modulation
- If the pulse energy is considered

For example, if you compare the measurement result to a measurement result of a thermal power sensor.

"Peak" Assigns the pulse peak power to the pulse top power.

Remote command:

[CALCulate<Measurement>:TRACe:MEASurement:ALGorithm](#) on page 281

High Reference Level ← Configuration tab

Defines the end of the rising edge and the start of the falling edge of the pulse. Used for the measurement of the rise or fall time.

Remote command:

[CALCulate<Measurement>:TRACe:MEASurement:DEFine:TRANSition:HREFerence](#) on page 282

Reference Level ← Configuration tab

Defines the pulse width, pulse start time and pulse stop time.

Remote command:

[CALCulate<Measurement>:TRACe:MEASurement:DEFine:DURation:REFerence](#) on page 282

Low Reference Level ← Configuration tab

Defines the start of the rising edge and the end of the falling edge of the pulse. Used for the measurement of the rise or fall time.

Remote command:

[CALCulate<Measurement>:TRACe:MEASurement:DEFine:TRANSition:LREFerence](#) on page 282

Reset to Defaults ← Configuration tab

Resets all parameters on the [Configuration tab](#)

6.6 Time gate

In combination with the R&S NRX, all power sensors that support the timeslot measurement, can use also this measurement type. The power sensor measures the average power in time intervals chosen by you. These time intervals are called time gates. You can configure up to 4 different gates, but use only one at a time for measuring. The time resolution is determined by the sampling rate of the power sensor. An external trigger signal or internal signal triggering is required for synchronization.

- [Time gate result display](#)..... 91
- [Time gate settings](#)..... 92
- [Gate Configuration dialog](#)..... 94

6.6.1 Time gate result display

You can choose between a scalar or graphical result display.

To change the display format

1. Select the time gate measurement type:
"Measurement Settings" > "Measurement Type" > "Time Gate"
2. Select the display format:
"Display" > "Display Format"

Scalar display

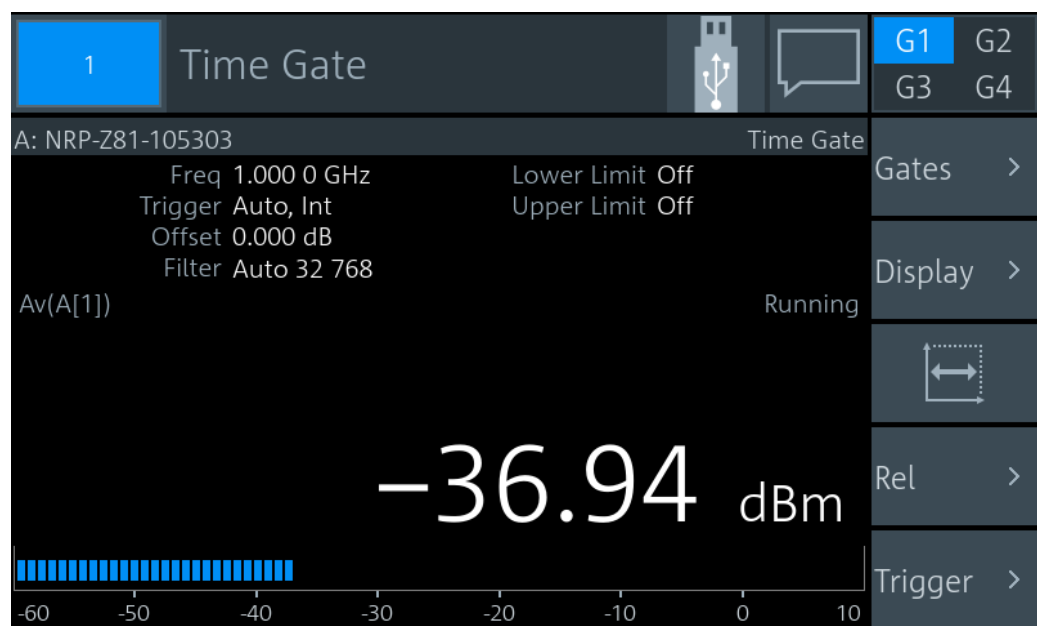

Figure 6-6: Time gate, scalar digital display

The measurement result is a single scalar value. It refers to the selected time gate. If "Scalar Analog" is set as [Display Format](#), a bar chart visualizes the measurement result.

Graphical display

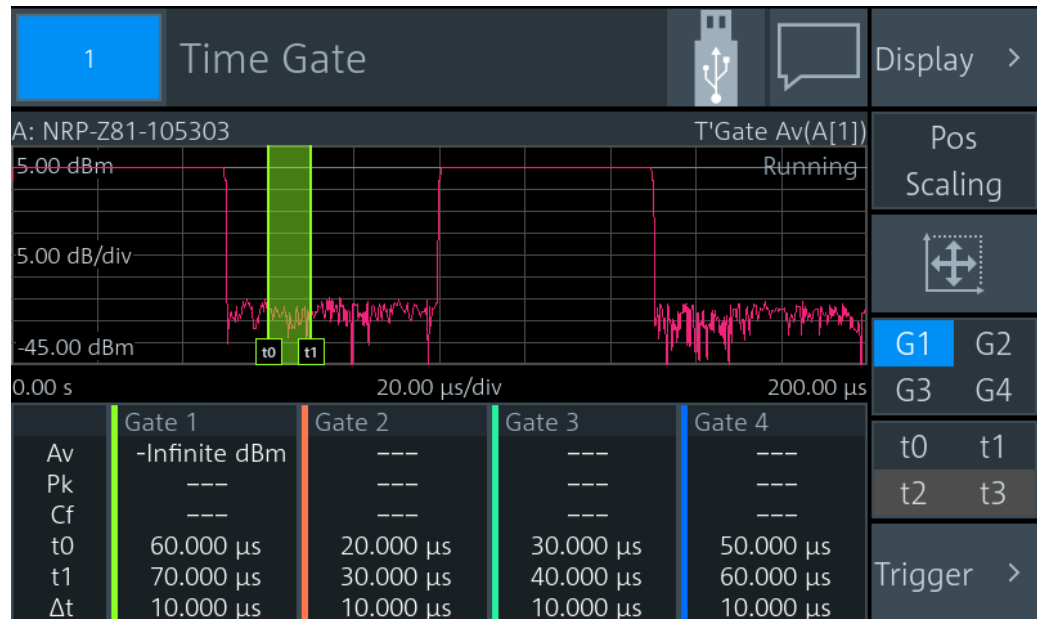

Figure 6-7: Time gate, graphical display

In the upper pane, the measurement result is shown as a single trace measurement of the primary sensor. The active gate is indicated as colored area. The color is matching the color assigned to the gate. You can change the gate configuration directly by using touch gestures. If you have a channel calculation function running that involves 2 power sensors, a legend in the upper right corner shows the assignment of curve to measurement channel.

In the lower pane, the 4 gates are displayed with:

- Assigned color
- Measurement values:
 - "Av"
Average power within gate
 - "Pk"
Peak power within gate
 - "Cf"
Crest factor
- Borders, see [t0 / t1 / t2 / t3](#).
- Length Δt

If you tap the lower pane, the [Gate Configuration dialog](#) opens.

6.6.2 Time gate settings

Access: "Measurement Settings" > "Measurement Type" > "Time Gate"

The available settings depend on the selected result display.

G1 / G2 / G3 / G4.....	93
Gates.....	93
Display.....	93
Resolution.....	93
Pos / Scaling.....	93
Autoscale.....	93
t0 / t1 / t2 / t3.....	93
Rel.....	94
Trigger.....	94

G1 / G2 / G3 / G4

Selects the active gate for the measurement.

Remote command:

`CALCulate<Measurement>[:POWER]:TGATE<Undef>[:AVG]:SElection`
on page 297

Gates

Available for the scalar displays.

Opens the "Gate Configuration" dialog, see [Chapter 6.6.3, "Gate Configuration dialog"](#), on page 94.

Display

See [Chapter 6.1.1, "Display settings"](#), on page 52.

Resolution

Available for the scalar displays.

See ["Resolution"](#) on page 54.

Pos / Scaling

Available for the graphical display.

Defines the effect of the cursor keys on the displayed trace.

"Pos"	Shifts the position. Press one of the cursor keys to shift the trace in x- and y-direction.
"Scaling"	Changes the scaling. Press one of the cursor keys to expand or compress the trace.



Autoscale

Available for the graphical display.

Adapts the scaling of the power axis to the trace. The scaling of the time axis is adapted only if the power sensor supports it.

t0 / t1 / t2 / t3

Available if:

- Graphical display is enabled.
- [Pos / Scaling](#) is disabled.

Selects a gate or fence border so that you can change the start time or length. The selected border is displayed as dashed line.

"t0"	Start of Gate
"t1"	Length of Gate
"t2"	Start of Fence. Only available if Fence is enabled.
"t3"	Length of Fence. Only available if Fence is enabled.

Rel

Available for the scalar displays.

See "Rel" on page 73.

Trigger

See Chapter 6.1.3, "Triggering", on page 63.

6.6.3 Gate Configuration dialog

Access depends on the selected measurement type and display format:

- Time gate, scalar display: "Time Gate" > "Gates"
- Time gate, graphical display: Tap the lower pane where the gate information is displayed.
- Statistics: "Statistics" > "Evaluate" > "Statistics Timing", tap the lower pane where the gate information is displayed.

Used for configuring gates. The gates are used in the time gate and statistics measurements. Each gate is configured individually. Select the gate you want to configure.

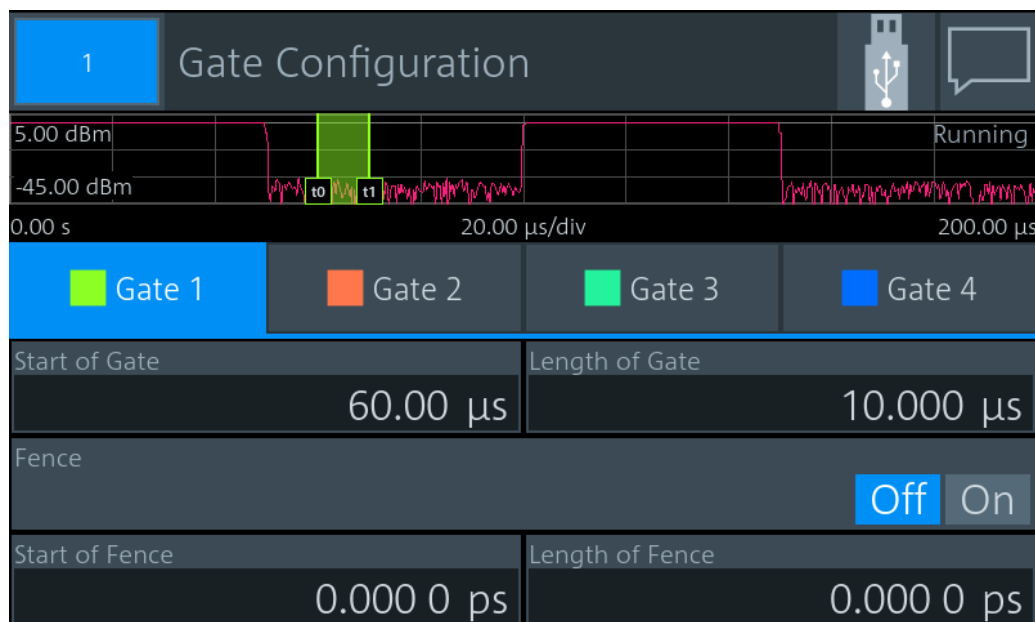

Figure 6-8: Example for time gate measurement type

Start of Gate.....	95
Length of Gate.....	95
Fence.....	95
Start of Fence.....	95
Length of Fence.....	95

Start of Gate

Sets the start time of the gate.

Remote command:

`CALCulate<Measurement>[:POWer]:TGATe<Gate>[:AVG]:TIME` on page 295

Length of Gate

Sets the length of the gate.

Remote command:

`CALCulate<Measurement>[:POWer]:TGATe<Gate>[:AVG]:OFFSet[:TIME]`
on page 295

Fence

Enables or disables an exclusion interval for the selected gate. This exclusion interval is called fence. The interval where the fence overlaps with the gate is excluded from the measurement.

Like a gate, a fence is defined by its start time and its length.

Remote command:

`CALCulate<Measurement>[:POWer]:TGATe<Gate>[:AVG][:EXCLude]:MID[:STATe]` on page 296

Start of Fence

Sets the start time of the fence. The start time refers to the start of the gate.

Remote command:

`CALCulate<Measurement>[:POWer]:TGATe<Gate>[:AVG][:EXCLude]:MID:TIME` on page 296

Length of Fence

Sets the length of the fence.

Remote command:

`CALCulate<Measurement>[:POWer]:TGATe<Gate>[:AVG][:EXCLude]:MID:OFFSet[:TIME]` on page 295

6.7 Timeslot

Supported by multipath and wideband power sensors. The power sensor measures the average power in successive timeslots. You can define the number and characteristics of the timeslots. But different to time gate measurements, where each gate is defined individually, the timeslots all share the characteristics. Thus, the timeslots are arranged in a frame structure with equal spacing and are suitable for periodic signals. The time

resolution is determined by the sampling rate of the power sensor. An external trigger signal or internal signal triggering is required for synchronization.

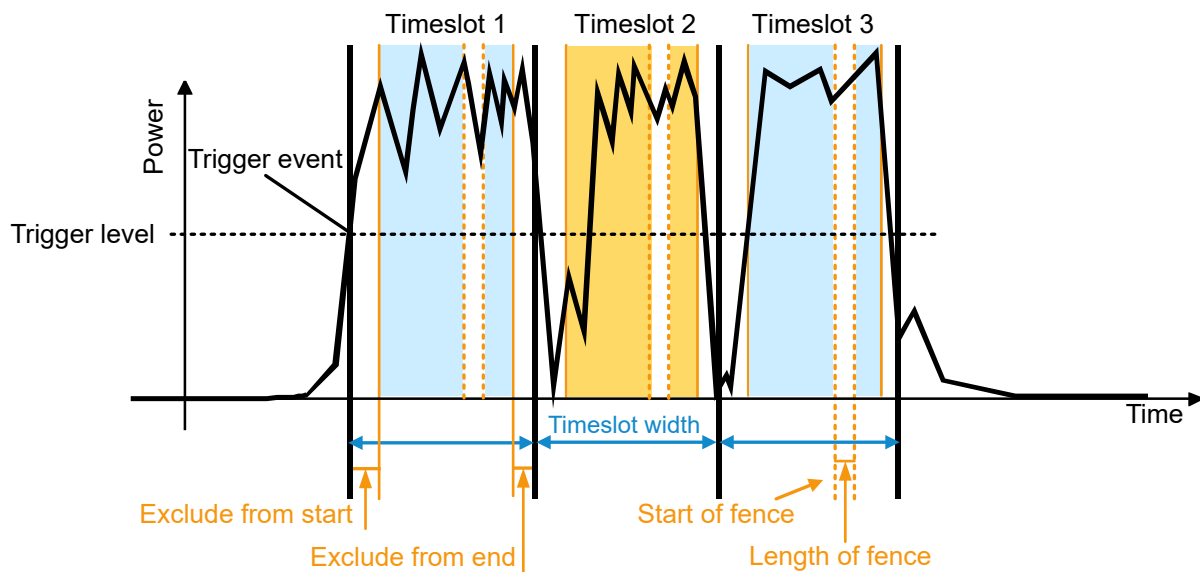

Figure 6-9: Timeslot measurement parameters

Adopt the timeslot width to the test signal. You can restrict the measurement to the relevant part of a timeslot by excluding intervals at the start and the end of the timeslot. Also, you can define an exclusion interval, a so-called fence, within the timeslot.

- [Timeslot result display](#).....96
- [Timeslot settings](#)..... 98
- [Timeslot Configuration dialog](#).....99

6.7.1 Timeslot result display

You can choose between a scalar or graphical result display.

To change the display format

1. Select the timeslot measurement type:
"Measurement Settings" > "Measurement Type" > "Timeslot"
2. Select the display format:
"Display" > "Display Format"

Scalar display

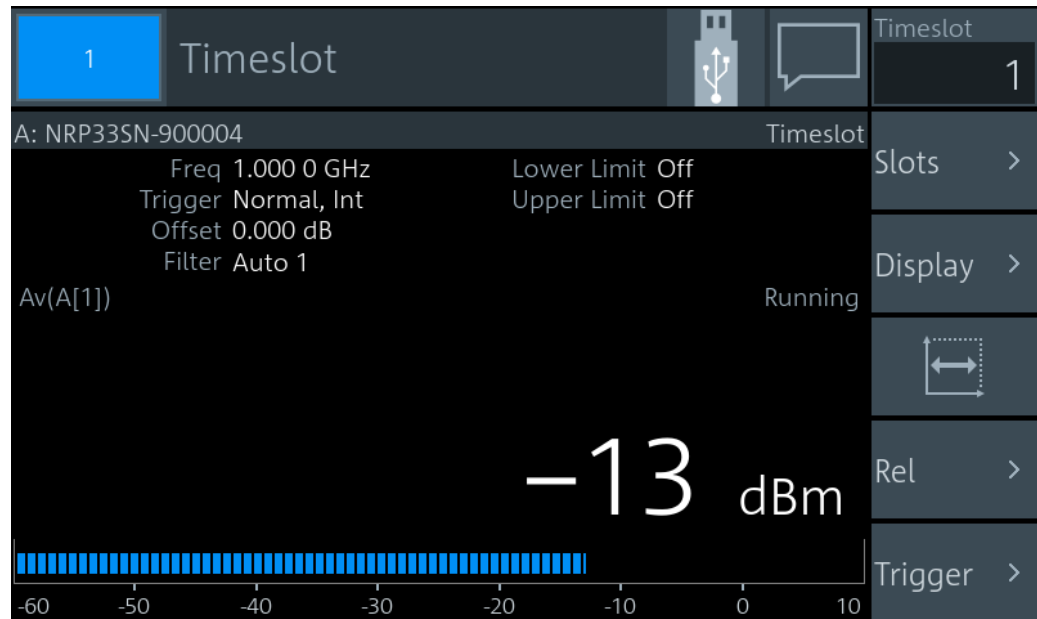

Figure 6-10: Timeslot, scalar digital display

The measurement result is a single scalar value. It refers to the selected timeslot. If "Scalar Analog" is set as [Display Format](#), a bar chart visualizes the measurement result.

Graphical display

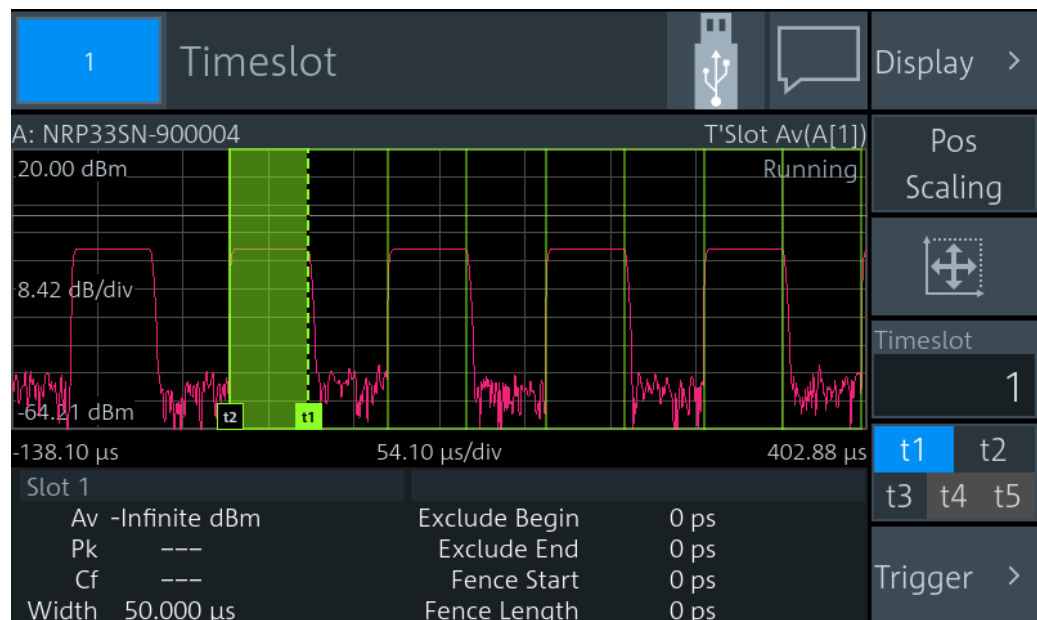

Figure 6-11: Timeslot, graphical display

In the upper pane, the measurement result is shown as a single trace measurement of the primary sensor. The timeslots are indicated as rectangles. The selected timeslot is indicated as colored area. You can change the timeslot configuration directly by using touch gestures. If you have a channel calculation function running that involves 2 power sensors, a legend in the upper right corner shows the assignment of curve to measurement channel.

In the lower pane, the selected timeslot is displayed with:

- Measurement values:
 - "Av"
Average power within gate
 - "Pk"
Peak power within gate
 - "Cf"
- Width
- Borders, see [t1](#), [t2](#), [t3](#), [t4](#), [t5](#).

If you tap the lower pane, the [Timeslot Configuration dialog](#) opens.

6.7.2 Timeslot settings

Access: "Measurement Settings" > "Measurement Type" > "Timeslot"

The available settings depend on the selected result display.

Timeslot	98
Slots	98
Display	98
Resolution	99
Pos / Scaling	99
Autoscale	99
t1, t2, t3, t4, t5	99
Rel	99
Trigger	99

Timeslot

Selects a timeslot for the measurement.

Remote command:

[CALCulate<Measurement>\[:POWER\]:TSlot\[:AVG\]:SElection](#) on page 307

Slots

Available for the scalar displays.

Opens the "Timeslot Configuration" dialog, see [Chapter 6.7.3, "Timeslot Configuration dialog"](#), on page 99.

Display

See [Chapter 6.1.1, "Display settings"](#), on page 52.

Resolution

Available for the scalar displays.

See ["Resolution"](#) on page 54.

Pos / Scaling

Available if:

- Graphical display is enabled.
- [t1, t2, t3, t4, t5](#) is disabled.

Scales or moves the graph.

**Autoscale**

Available for the graphical display.

Adapts the scaling of the power axis to the trace. The scaling of the time axis is adapted only if the power sensor supports it.

t1, t2, t3, t4, t5

Available if:

- Graphical display is selected.
- [Pos / Scaling](#) is disabled.

Selects a border so that you can change the timeslot length and included/excluded intervals. The selected border is displayed as dashed line.

"t1"	Nominal Width
"t2"	Exclude from Start
"t3"	Exclude from End
"t4"	Start of Fence . Only available if Fence is enabled.
"t5"	Length of Fence . Only available if Fence is enabled.

Rel

Available for the scalar displays.

See ["Rel"](#) on page 73.

Trigger

See [Chapter 6.1.3, "Triggering"](#), on page 63.

6.7.3 Timeslot Configuration dialog

Access depends on the selected display format:

- Scalar display: "Timeslot" > "Slots"
- Graphical display: Tap the lower pane where the gate information is displayed.

Used for configuring the characteristics of the timeslots.

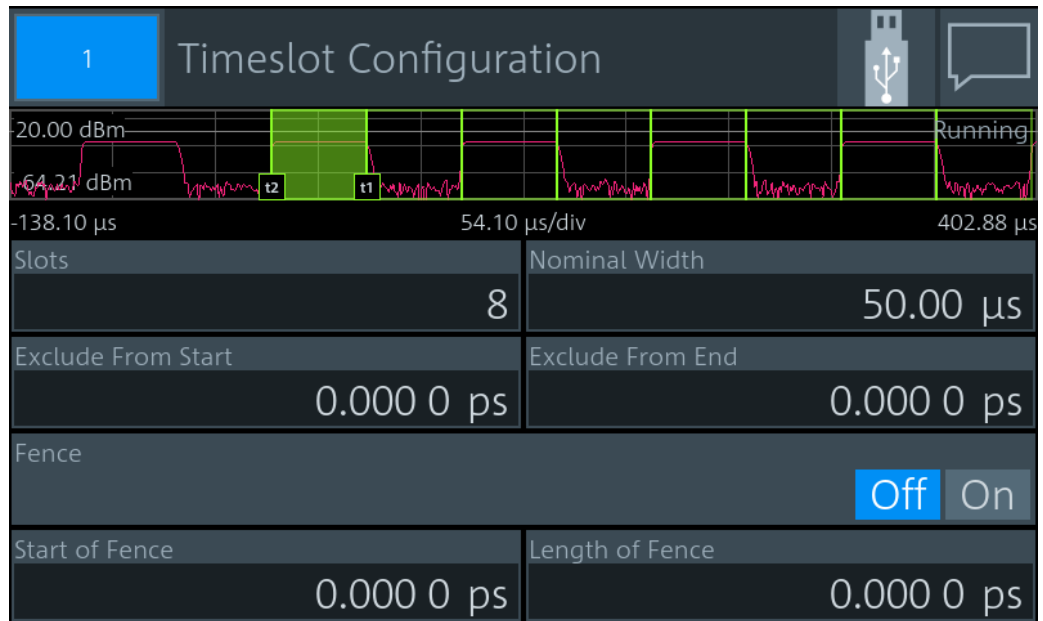

Slots.....	100
Nominal Width.....	100
Exclude from Start.....	100
Exclude from End.....	100
Fence.....	101
Start of Fence.....	101
Length of Fence.....	101

Slots

Sets the number of simultaneously measured timeslots.

Remote command:

[CALCulate<Measurement>\[:POWER\]:TSLot\[:AVG\]:COUNT](#) on page 307

Nominal Width

Sets the length of the timeslot.

Remote command:

[CALCulate<Measurement>\[:POWER\]:TSLot\[:AVG\]:WIDTH](#) on page 307

Exclude from Start

Defines an interval at the start of the timeslot that is excluded from the measurement.

Remote command:

[CALCulate<Measurement>:TSLot:TIMing:EXCLude:START](#) on page 306

Exclude from End

Defines an interval at the end of the timeslot that is excluded from the measurement.

Remote command:

[CALCulate<Measurement>:TSLot:TIMing:EXCLude:STOP](#) on page 307

Fence

Enables or disables an exclusion interval in the timeslots. This exclusion interval is called fence. The fence is defined by its start time and its length.

Remote command:

`CALCulate<Measurement>[:POWER]:TSLot[:AVG][:EXCLude]:MID[:STATe]`
on page 308

Start of Fence

Sets the start time of the fence. The start time refers to the start of the timeslots.

Remote command:

`CALCulate<Measurement>[:POWER]:TSLot[:AVG][:EXCLude]:MID:TIME`
on page 308

Length of Fence

Sets the length of the fence.

Remote command:

`CALCulate<Measurement>[:POWER]:TSLot[:AVG][:EXCLude]:MID:OFFSet[:TIME]` on page 308

6.8 Statistics

Supported by wideband power sensors. The power sensor measures power over time. Using the statistics measurement type, you can analyze the statistical distribution of the envelope power. The duration of the sampling window is either defined by the chosen gate or a set aperture time. The measurement is repeated until the minimum number of samples is collected.

- [Statistics result display](#)..... 101
- [Statistics settings](#)..... 103
- [Measurement Settings dialog](#)..... 104
- [Scale Configuration dialog](#)..... 105
- [Statistics Timing dialog](#)..... 107

6.8.1 Statistics result display

You can choose between a tabular or graphical result display.

In the lower pane, the following measurement results are provided for the 2 traces:

- "Peak"
Peak power
- "Avg"
Average power
- Measurement result at the x-marker position. The marker is set using [\[dBm\] / \[dB\] marker](#).
-

Power value at the y-marker position. The marker is set using [%] marker.

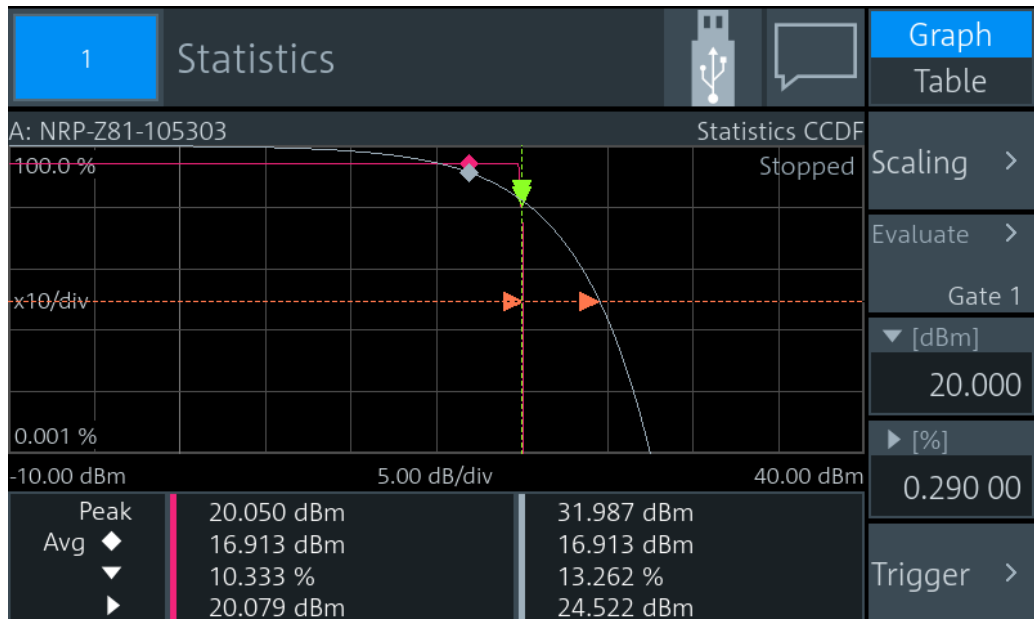

Figure 6-12: Statistics, graphical display

The graph displays the waveform of the selected trace.

Tap **Table** to display the measurement results in tabular format. The table contains the measurement results for 2 traces. The second trace is measured by a second power sensor or generated by an internal AWGN source.

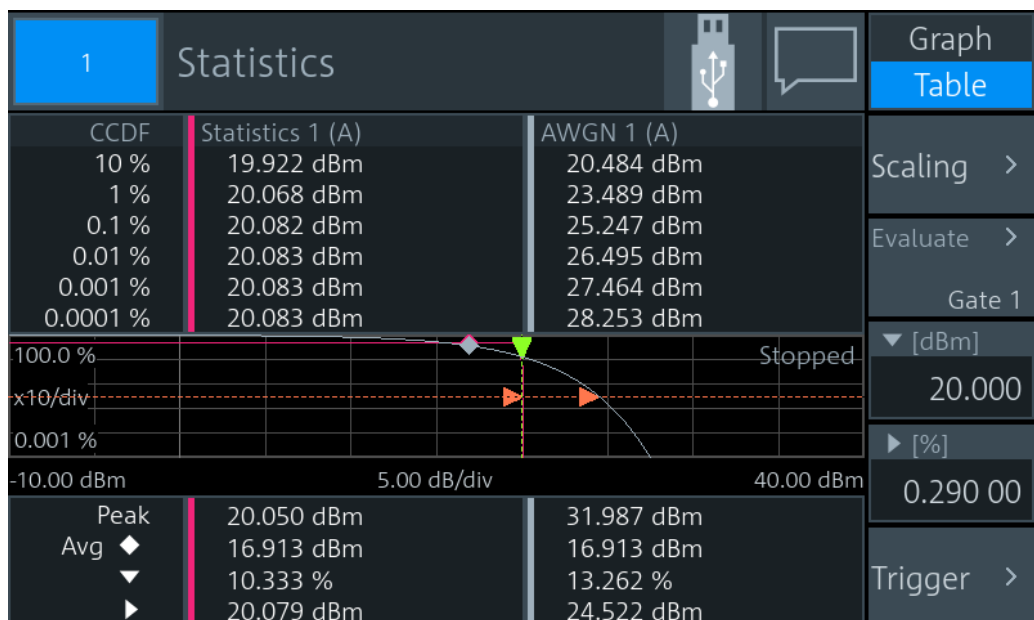

Figure 6-13: Statistics, tabular display

6.8.2 Statistics settings

Access: "Measurement Settings" > "Measurement Type" > "Statistics"

Graph / Table.....	103
Scaling.....	103
Evaluate.....	103
[dBm] / [dB] marker.....	103
[%] marker.....	103
Trigger.....	103

Graph / Table

Available if "CCDF" or "CDF" is set under [Statistics Function](#).

Shows or hides the measurement results table.

Remote command:

`CALCulate<Measurement>:DMODE` on page 198

Scaling

Opens the "Scale Configuration" dialog, see [Chapter 6.8.4, "Scale Configuration dialog"](#), on page 105.

Evaluate

Opens the "Statistics Timing" dialog, see [Chapter 6.8.5, "Statistics Timing dialog"](#), on page 107.

[dBm] / [dB] marker

Positions the x-marker to a power value. The associated measurement result is displayed in the lower pane, see [Figure 6-13](#).

Remote command:

`CALCulate<Measurement>:STATistics:MARKer:X:POSition:RELative`
on page 318

`CALCulate<Measurement>:STATistics:MARKer:X:POSition[:ABSolute]`
on page 318

[%] marker

Positions the y-marker to a measurement value. The associated power value is displayed in the lower pane, see [Figure 6-13](#).

Remote command:

`CALCulate<Measurement>:STATistics:PDF:MARKer:Y:POSition`
on page 319

`CALCulate<Measurement>:STATistics[:CDF]:MARKer:Y:POSition`
on page 317

Trigger

See [Chapter 6.1.3, "Triggering"](#), on page 63.

6.8.3 Measurement Settings dialog

Access: In the "Statistics" dialog, tap the *displayed table or graph*.

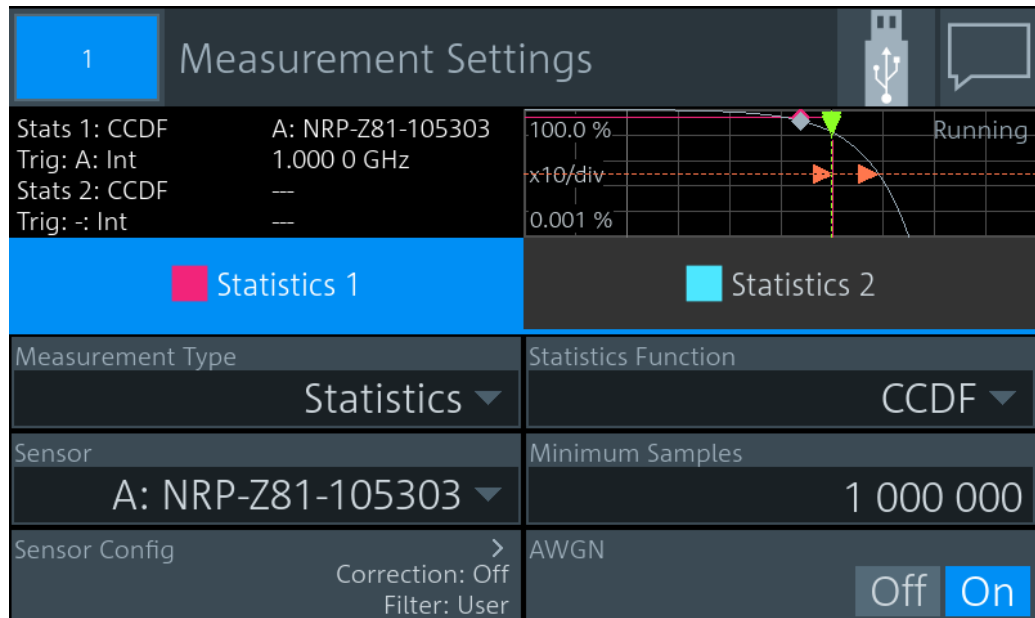

The settings in the left column are the same as for the other measurement types:

- "Measurement Type", see ["Measurement Type"](#) on page 69.
- "Sensor", see ["Primary Sensor, Secondary Sensor"](#) on page 70.
- "Sensor Config" > "Aperture"
See ["Aperture"](#) on page 117.

The settings in the right column are specific for statistics measurements.

Statistics Function	104
Minimum Samples	105
AWGN	105

Statistics Function

Sets the function used for analyzing the statistical distribution of the envelope power.

"CCDF"	Complementary cumulative distribution function Probability that the envelope power is higher than the corresponding x-axis power value. Linear or logarithmic scale.
"CDF"	Cumulative distribution function Probability that the envelope power is lower than the corresponding x-axis power value. Linear or logarithmic scale.
"PDF"	Probability density function Normalized distribution density of the envelope power. The measurement results are dimensionless and independent of the magnitude of the average power value (A_v). Only linear scale is available.

Remote command:

`CALCulate<Measurement>[:CHANnel<Channel>]:FEED<Channel>`

on page 239

Minimum Samples

Sets the minimum number of samples.

Remote command:

`CALCulate<Measurement>:STATistics:SAMPles[:MINimum]` on page 312

AWGN

Enables or disables the internal, additional white Gaussian noise (AWGN) source. If enabled, you cannot measure with a second power sensor.

Remote command:

`CALCulate<Measurement>:STATistics:AWGN[:STATE]` on page 312

6.8.4 Scale Configuration dialog

Access: "Statistics" > "Scaling"

Used for configuring the axes of the display.

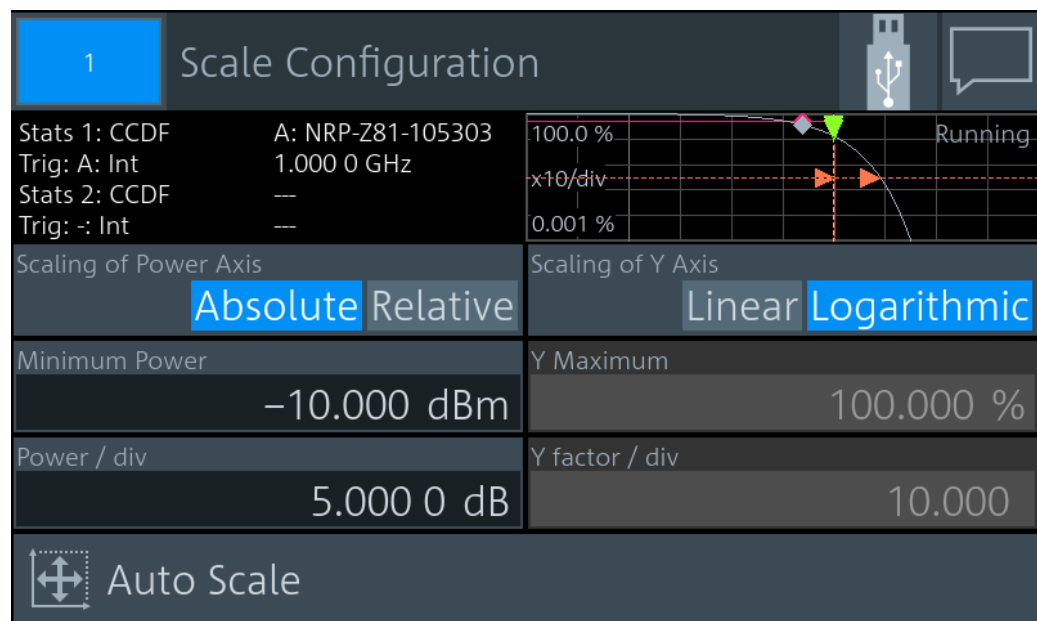

Scaling of Power Axis.....	106
Minimum Power.....	106
Power / div.....	106
Scaling of Y Axis.....	106
Y Maximum.....	106
Y / div.....	106
Auto Scale.....	106

Scaling of Power Axis

Sets relative or absolute scaling for the x-axis.

"Absolute" Absolute power in dBm.

"Relative" Relative power in dB, referenced to the average power.

Remote command:

`CALCulate<Measurement>:STATistics[:SCALE]:X:MODE` on page 315

Minimum Power

Sets the lower limit of the level range as reference for the graphical display.

Remote command:

`CALCulate<Measurement>:STATistics[:SCALE]:X:RLEVel[:ABSolute]`
on page 316

`CALCulate<Measurement>:STATistics[:SCALE]:X:RLEVel:RELative`
on page 316

Power / div

Sets the scaling of the power axis.

Remote command:

`CALCulate<Measurement>:STATistics[:SCALE]:X:POINts` on page 315

`CALCulate<Measurement>:STATistics[:SCALE]:X:RANGe` on page 316

Scaling of Y Axis

Sets linear or logarithmic scaling for the y-axis.

Remote command:

`CALCulate<Measurement>:STATistics[:SCALE]:Y:SPACing` on page 317

Y Maximum

Available if "Linear" is set under [Scaling of Y Axis](#).

Sets the maximum value of the y-axis.

Remote command:

`CALCulate<Measurement>:STATistics:PDF[:SCALE]:Y:TOP` on page 314

`CALCulate<Measurement>:STATistics[:CDF][:SCALE]:Y[:LINear]:TOP`
on page 314

Y / div

Available if "Linear" is set under [Scaling of Y Axis](#).

Sets the scaling of the y-axis.

Remote command:

`CALCulate<Measurement>:STATistics:PDF[:SCALE]:Y:PDIVision`
on page 313

`CALCulate<Measurement>:STATistics[:CDF][:SCALE]:Y[:LINear]:
PDIVision` on page 314



Auto Scale

Adapts the scaling of the power axis to the trace.

6.8.5 Statistics Timing dialog

Access: "Statistics" > "Evaluate"

Configures the sampling window of the measurement.

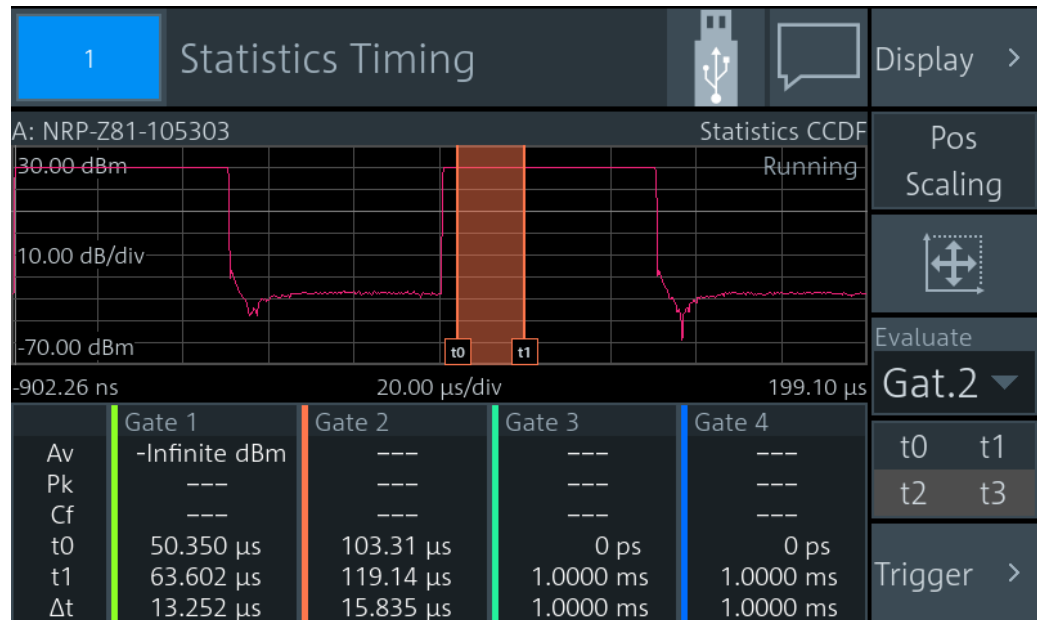

If you tap the lower pane, the "Gate Configuration" dialog opens, see [Chapter 6.6.3, "Gate Configuration dialog"](#), on page 94.

Display	107
Pos / Scaling	107
Autoscale	107
Evaluate	108
t0 / t1 / t2 / t3	108

Display

Opens the "Trace Configuration" dialog that contains the scaling functions:

- "Start Time" on page 57
- "Time / Div" on page 57
- "Power Reference" on page 57
- "Power / Div" on page 57
- "Unit" on page 58

Pos / Scaling

Defines the effect of the cursor keys on the displayed trace.

- "Pos" Shifts the position. Press one of the cursor keys to shift the trace in x- and y-direction.
- "Scaling" Changes the scaling. Press one of the cursor keys to expand or compress the trace.



Autoscale

Adapts the scaling of the power axis to the trace.

Evaluate

Opens the "Evaluate" dialog to configure the sampling window.

"Gate 1" / "Gate 2" / "Gate 3" / "Gate 4"

Select the gate that you want to configure and use for the measurement.

Continuous Sets unsynchronized acquisition. Set the duration of the sampling window using [Aperture](#).

Remote command:

[CALCulate<Measurement>:STATistics:TGATe:SElection](#) on page 312

t0 / t1 / t2 / t3

Available if [Pos / Scaling](#) is disabled.

The same gates are used in the time gate and statistics measurements. See "[t0 / t1 / t2 / t3](#)" on page 93.

6.9 NRT

Requires the interface for R&S NRT-Z sensors (R&S NRX-B9), see [Chapter 3.2.1.2, "Module bay"](#), on page 26.

Used for power reflection measurements with the R&S NRT-Zxx directional power sensor.

The R&S NRT-Zxx directional power sensor measures the forward and reverse power. The forward power is the power flux from the source to the load.

To observe during the power reflection measurement

- ▶ **CAUTION!** Risk of electric shock and severe skin burns. During the measurement, the RF power flow can be high.



After switching on the RF power, do not touch the RF ports.

Never exceed permissible continuous power that is shown in the diagram on the back of the power sensor.

Further information:

- [Chapter 7.5, "NRT measurement type"](#), on page 128
- Setup see [Chapter 3.1.8.2, "Optional interface for R&S NRT-Z sensors \(R&S NRX-B9\)"](#), on page 22.

6.9.1 NRT result display

The R&S NRX displays the forward and reverse power simultaneously.

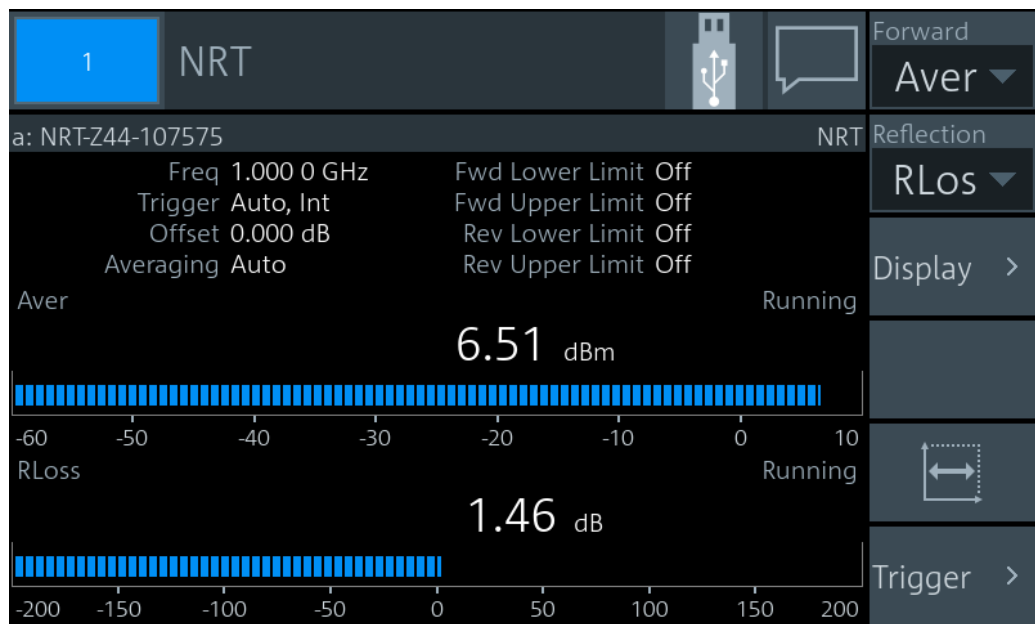

Displays two scalar values, one for the selected **Forward** measurement and one for the **Reflection** measurement. In this example, **Average** ("Aver") and **Return Loss** ("RLos") are selected.

6.9.2 NRT settings

Access: "Measurement Settings" > "Measurement Type" > "NRT"

Forward.....	109
L Average.....	110
L CCDF.....	110
L Peak Envelope Power (PEP).....	110
L Absorption Average.....	110
L Crest Factor (CF).....	111
L Absorption PEP.....	111
L Burst Average.....	111
L Absorption Burst.....	111
Reflection.....	112
L Off.....	112
L Reverse Power.....	112
L Standing Wave Ratio (SWR).....	112
L Return Loss.....	112
L Reflection Coefficient.....	112
L Reflection Ratio.....	113
Display.....	113
Autoscale.....	113
Trigger.....	113

Forward

Opens a dialog to measure power, power differences and envelope parameters.

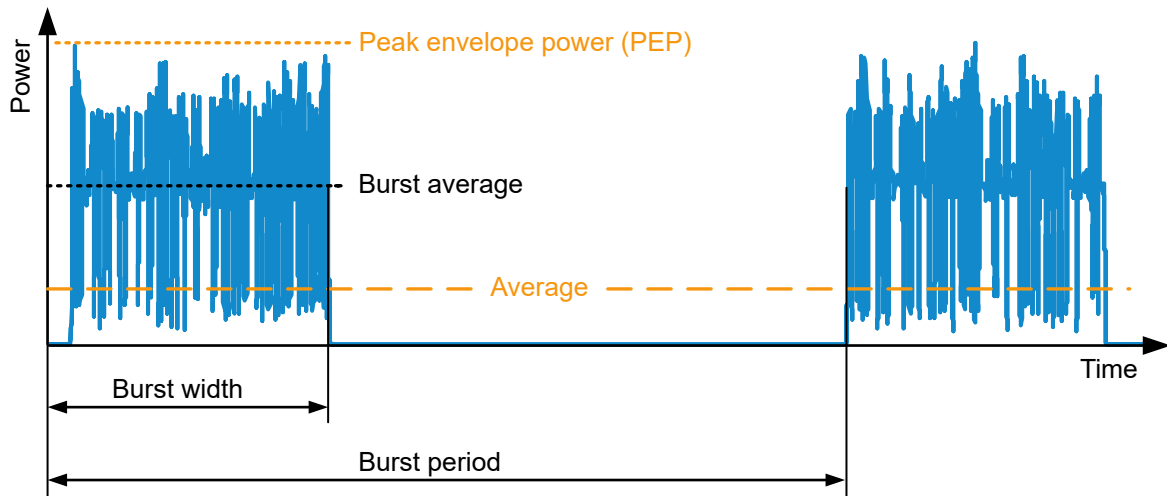

Figure 6-14: Forward power measurement parameters

Average ← Forward

Average power

Remote command:

```
CALCulate<Measurement>[:CHANnel<Channel>]:FEED<Channel>
"POWer:FORWard:AVERAge"
```

CCDF ← Forward

Complementary cumulative distribution function. Probability that the envelope power is higher than the threshold set under "[CCDF Threshold](#)" on page 130.

Suitable for assessing the power distribution of spread-spectrum signals, for example CDMA.

Remote command:

```
CALCulate<Measurement>[:CHANnel<Channel>]:FEED<Channel>
"POWer:FORWard:CCDFunction"
```

Peak Envelope Power (PEP) ← Forward

Peak power of an amplitude-modulated signal. Depending on the selected [Video Bandwidth](#), this parameter allows detecting short-time overshoots at the beginning of a burst.

The peak envelope power (PEP) is an important parameter for describing the modulation characteristics of transmitter output stages.

Remote command:

```
CALCulate<Measurement>[:CHANnel<Channel>]:FEED<Channel>
"POWer:FORWard:PEP"
```

Absorption Average ← Forward

Absorbed average power. Difference between the forward and reverse [Average](#) measurement.

This parameter measures the effective power transmitted to the load. With good matching, the difference between forward power and absorbed power is less than one percent.

Remote command:

```
CALCulate<Measurement>[:CHANnel<Channel>]:FEED<Channel>
"POWer:ABSorption:AVERAge"
```

Crest Factor (CF) ← Forward

Level difference between the peak envelope power and the average power in dB.

$$\text{Crest factor} = 10 \text{ dB} \times \log \frac{\text{Peak envelope power}}{\text{Average power}}$$

Allows recognizing larger modulation distortions quickly.

Remote command:

```
CALCulate<Measurement>[:CHANnel<Channel>]:FEED<Channel>
"POWer:CFACTOR"
```

Absorption PEP ← Forward

Absorbed peak envelope power (PEP). Difference of [Peak Envelope Power \(PEP\)](#) between forward and reverse power measurement.

Remote command:

```
CALCulate<Measurement>[:CHANnel<Channel>]:FEED<Channel>
"POWer:ABSorption:PEP"
```

Burst Average ← Forward

Average power within a burst. The R&S NRX determines the average burst power by multiplying the average power with the ratio of burst period to burst width:

$$\text{Burst average} = \text{Average} \frac{\text{Burst period}}{\text{Burst width}}$$

Burst period and burst width are derived depending on the setting of "[Burst Mode](#)" on page 129.

For pulsed RF signals, the burst average defines the average carrier power within the burst. If the burst is unmodulated and has no overshoots, the average burst is equal to the [Peak Envelope Power \(PEP\)](#).

Remote command:

```
CALCulate<Measurement>[:CHANnel<Channel>]:FEED<Channel>
"POWer:FORWARD:AVERAge:BURSt"
```

Absorption Burst ← Forward

Absorbed burst average. Difference of [Burst Average](#) between forward and reverse power measurement.

Remote command:

```
CALCulate<Measurement>[:CHANnel<Channel>]:FEED<Channel>
"POWer:ABSorption:AVERAge:BURSt"
```

Reflection

Opens a dialog to measure reflection parameters.

The ratio of forward and reverse power is a measure for the matching of the load that can be expressed as standing wave ratio (SWR), return loss or reflection coefficient.

Off ← Reflection

Disabled.

Remote command:

```
CALCulate<Measurement>[:CHANnel<Channel>]:FEED<Channel>
"POWer:OFF"
```

Reverse Power ← Reflection

Reverse power in W or dBm.

Remote command:

```
CALCulate<Measurement>[:CHANnel<Channel>]:FEED<Channel>
"POWer:REVerse"
```

Standing Wave Ratio (SWR) ← Reflection

$$\text{Standing wave ratio} = \frac{1 + \text{Reflection coefficient}}{1 - \text{Reflection coefficient}}$$

See also "[Reflection Coefficient](#)" on page 112.

Remote command:

```
CALCulate<Measurement>[:CHANnel<Channel>]:FEED<Channel>
"POWer:SWRatio"
UNIT<Measurement>:POWer:REFlection
```

Return Loss ← Reflection

$$\text{Return loss} = 10 \times \log \frac{\text{Forward power}}{\text{Reverse power}}$$

Remote command:

```
CALCulate<Measurement>[:CHANnel<Channel>]:FEED<Channel>
"POWer:RLOSs"
UNIT<Measurement>:POWer:REFlection
```

Reflection Coefficient ← Reflection

$$\text{Reflection coefficient} = \sqrt{\frac{\text{Reverse power}}{\text{Forward power}}}$$

Remote command:

```
CALCulate<Measurement>[:CHANnel<Channel>]:FEED<Channel>
"POWer:RCoefficient"
UNIT<Measurement>:POWer:REFlection
```

Reflection Ratio ← Reflection

$$\text{Reflection ratio} = 100 \frac{\text{Reverse power}}{\text{Forward power}}$$

Remote command:

```
CALCulate<Measurement>[:CHANnel<Channel>]:FEED<Channel>
"POWer:RFRatio"
UNIT<Measurement>:POWer:REFLection
```

Display

See [Chapter 6.1.1, "Display settings"](#), on page 52.

**Autoscale**

Adapts the scaling of the graphical display.

Remote command:

```
[SENSe<Sensor>:]POWer:REFLection:RANGe:AUTO
[SENSe<Sensor>:]POWer[:POWer]:RANGe:AUTO
```

Trigger

Opens the "Measurement Trigger Configuration" dialog:

- ["Trigger Mode"](#) on page 66
- ["Trigger Source"](#) on page 66

6.9.3 Measurement Main Configuration dialog

Access: In the "NRT" dialog, tap the *displayed table or graph*.

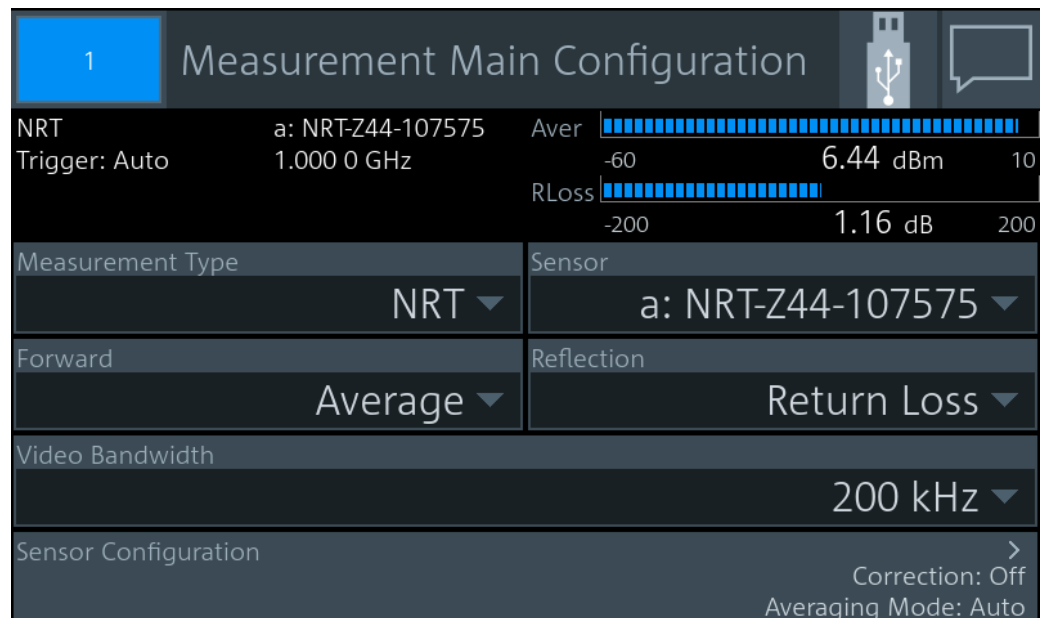

Figure 6-15: Measurement Main Configuration dialog

Measurement Type

See ["Measurement Type"](#) on page 69.

Sensor

Assigns the power sensor to the NRT measurement. Suitable are R&S NRT-Zxx directional power sensors connected to the interface for R&S NRT-Z sensors (R&S NRX-B9).

See also ["Primary Sensor, Secondary Sensor"](#) on page 70.

Trigger Mode

See ["Trigger Mode"](#) on page 66.

Trigger Source

See ["Trigger Source"](#) on page 66.

Forward

See ["Forward"](#) on page 109.

Reflection

See ["Reflection"](#) on page 112.

Video Bandwidth

See ["Video Bandwidth"](#) on page 133.

Sensor Configuration

See [Chapter 7.5, "NRT measurement type"](#), on page 128.

7 Sensor configuration

Access: "Measurement Settings" > "Primary Sensor Config" or "Secondary Sensor Config"

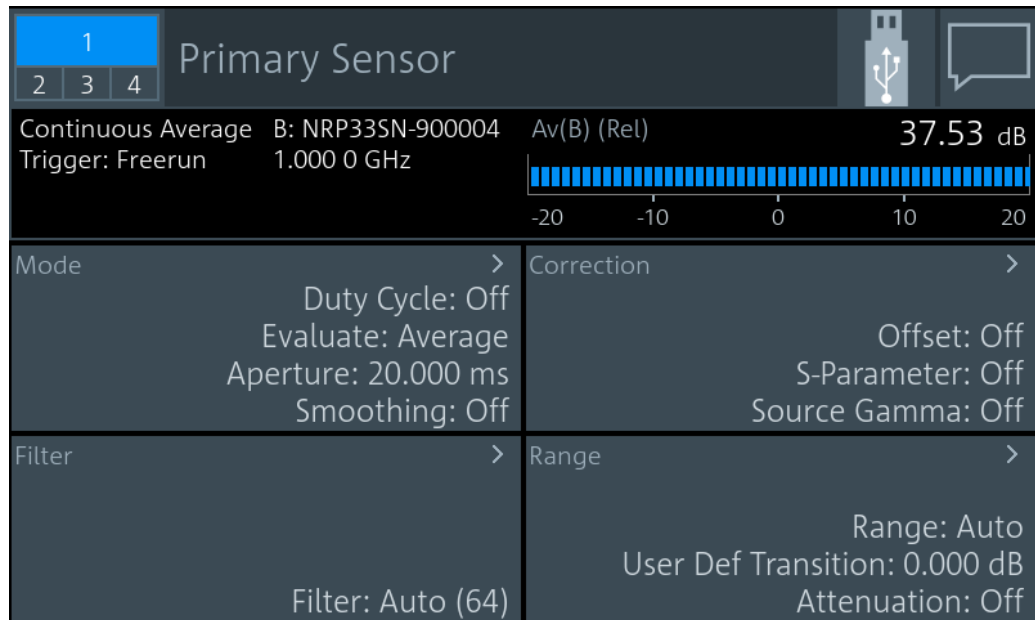

You can define two sensor configurations in parallel, a primary and a secondary sensor configuration. To these configurations, you can assign a sensor that is connected to one of the sensor ports of the R&S NRX. These sensors are called primary sensor and secondary sensor.

Further information:

- ["Primary Sensor, Secondary Sensor"](#) on page 70
- [Chapter 6, "Measurement and display configuration"](#), on page 52
- [Chapter 13.8.6, "Standardized signals"](#), on page 351
- [Mode settings](#)..... 115
- [Correction settings](#)..... 119
- [Filter settings](#)..... 122
- [Range settings](#)..... 126
- [NRT measurement type](#)..... 128

7.1 Mode settings

Access:

"Measurement Settings" > "Primary Sensor Config" > "Mode"

"Measurement Settings" > "Secondary Sensor Config" > "Mode"

Available for all measurement types.

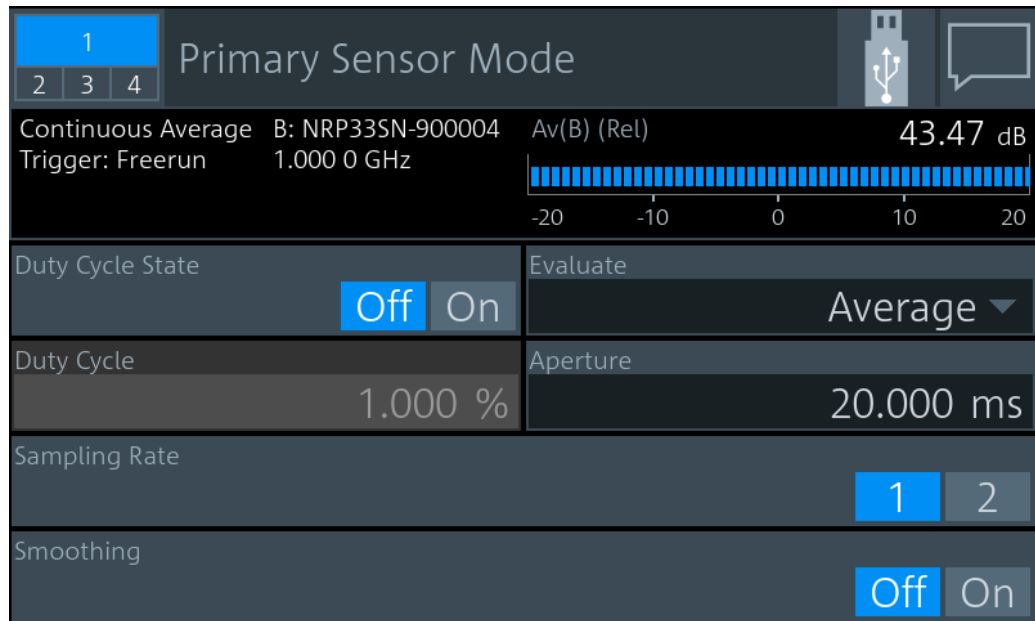

Duty Cycle State.....	116
Duty Cycle.....	116
Equivalent Time Sampling.....	117
Evaluate.....	117
Aperture.....	117
Sampling Rate.....	117
Smoothing.....	118
Dropout Tolerance.....	118
Exclude from Start, Exclude from End.....	118

Duty Cycle State

Available for continuous average measurements.

Enables or disables the duty cycle correction.

Remote command:

`CALCulate<Measurement>[:CHANnel<Channel>]:CORRection:DCYClE:STATE` on page 332

Duty Cycle

Available for continuous average measurements.

Sets the duty cycle for measuring pulse-modulated signals. The duty cycle defines the percentage of one period during which the signal is active. If the duty cycle is enabled, the R&S NRX takes this percentage into account when calculating the signal pulse power from the average power.

For thermal power sensors or multipath power sensors, the duty cycle correction is the only way to determine the power of pulsed signals.

Remote command:

`CALCulate<Measurement>[:CHANnel<Channel>]:CORRection:DCYClE[:VALue]` on page 332

Equivalent Time Sampling

Available for trace, pulse analysis measurements.

Enables or disables the automatic equivalent sampling that allows for high-resolution measurements.

Remote command:

`CALCulate<Measurement>[:CHANnel<Channel>]:TRACe:ESAMpling`

on page 333

`CALCulate<Measurement>:TRACe:MEASurement:TRANSition:ESAMpling:`

`AUTO[:STATe]` on page 335

Evaluate

Available for continuous average, burst average, trace, pulse analysis, time gate, time-slot measurements.

Sets the display type.

"Average" Average power value, resulting in a flicker-free display and smooth trace.

"Random" Power of a randomly selected sample, i.e. a realistic display with signal details.

"Peak" Highest power measured (peak power).

Remote command:

`CALCulate<Measurement>[:CHANnel<Channel>]:FEED<Channel>`

on page 239

Aperture

Available for continuous average, statistics measurements.

Sets the width of the sampling window. The usage depends on the measurement type.

- Continuous average measurement
When measuring modulated signals, the measurement can show fluctuation due to the modulation. If that is the case, adapt the size of the sampling window exactly to the modulation period to get an optimally stable display. If the modulation period varies or is not precisely known, you can also enable [Smoothing](#).
- Statistics measurement
Applies for unsynchronized acquisition, that is if [Evaluate](#) is set to "Continuous".

Remote command:

`CALCulate<Measurement>[:CHANnel<Channel>][:POWer][:AVG]:`

`APERture[:VALue]` on page 334

`CALCulate<Measurement>:STATistics:APERture` on page 312

Sampling Rate

Available for continuous average measurements.

Sets the sampling rate.

If the sampling frequency is located within the video bandwidth, aliasing can occur, that is when spectral components near the sampling frequency cause beating effects. If you change the sampling rate, the beating effects usually disappear.

"1" Normal sampling rate

"2" Lower sampling rate
Recommended to avoid measurement errors caused due to aliasing effects. However, this setting extends the measurement time.

Remote command:

[CALCulate<Measurement>\[:CHANnel<Channel>\]:SAMPLing](#) on page 333

Smoothing

Available for continuous average measurements.

Enables or disables the smoothing filter, a steep-edge digital lowpass filter. The filter reduces result fluctuations caused by modulation.

"Off" If the modulation frequency is known, set the [Aperture](#) time exactly to an integer multiple of the modulation period and disable smoothing. Otherwise, the modulation can have a considerable influence, even if the sampling window is much larger than the modulation period. 300 to 3000 periods are required to obtain the same effect as with smoothing enabled. The sampling values are considered equivalent and are averaged in a sampling window, which yields an integrating behavior of the measuring instrument.

"On" If the modulation period varies or is not precisely known, enable smoothing. The selected sampling window has to be 5 to 9 times larger than the modulation period so that the fluctuations caused by modulation are sufficiently reduced. The sampling values are subjected to weighting (raised-von-Hann window), which corresponds to video filtering.

Remote command:

[CALCulate<Measurement>\[:CHANnel<Channel>\]\[:POWer\]\[:AVG\]:SMOothing\[:STATe\]](#) on page 335

Dropout Tolerance

Available for burst average measurements.

Detects the falling edge of a burst. If the power keeps low for at least the set time, the end of the burst is assumed. Modulation-specific power drops that are shorter than the set value are ignored.

Remote command:

[CALCulate<Measurement>\[:CHANnel<Channel>\]\[:POWer\]:BURSt:DTOLerance](#) on page 334

Exclude from Start, Exclude from End

Available for burst average measurements.

Sets the time interval at the beginning or end of bursts that is excluded from the measurement. Thus, signal overshoots are omitted.

Remote command:

[CALCulate<Measurement>\[:CHANnel<Channel>\]:BURSt:TIMing:EXCLude:START](#) on page 331

[CALCulate<Measurement>\[:CHANnel<Channel>\]:BURSt:TIMing:EXCLude:STOP](#) on page 332

7.2 Correction settings

Access:

"Measurement Settings" > "Primary Sensor Config" > "Correction"

"Measurement Settings" > "Secondary Sensor Config" > "Correction"

Available for all measurement types.

Offset corrections

Add a fixed level offset in dB to compensate for external losses or gains. If you take the attenuation of an attenuator located ahead of the power sensor or the coupling attenuation of a directional coupler into account, use a positive offset. That means the power sensor calculates the power at the input of the attenuator or the directional coupler. If you want to correct the influence of an amplifier connected ahead, use a negative offset.

S-Parameter corrections

Used to compensate for losses and reflections introduced by a two-port component that is attached to a power sensor, such as an attenuator, directional coupler, or matching pad. Using S-parameters instead of a fixed offset increases the measurement accuracy, because the interaction between the power sensor and the component is considered. For information on how to proceed, see the user manual of the power sensor.

S-Gamma corrections

Using the complex reflection coefficient, you can determine the power delivered by the signal source with considerably greater accuracy. For information on how to proceed, see the user manual of the power sensor.

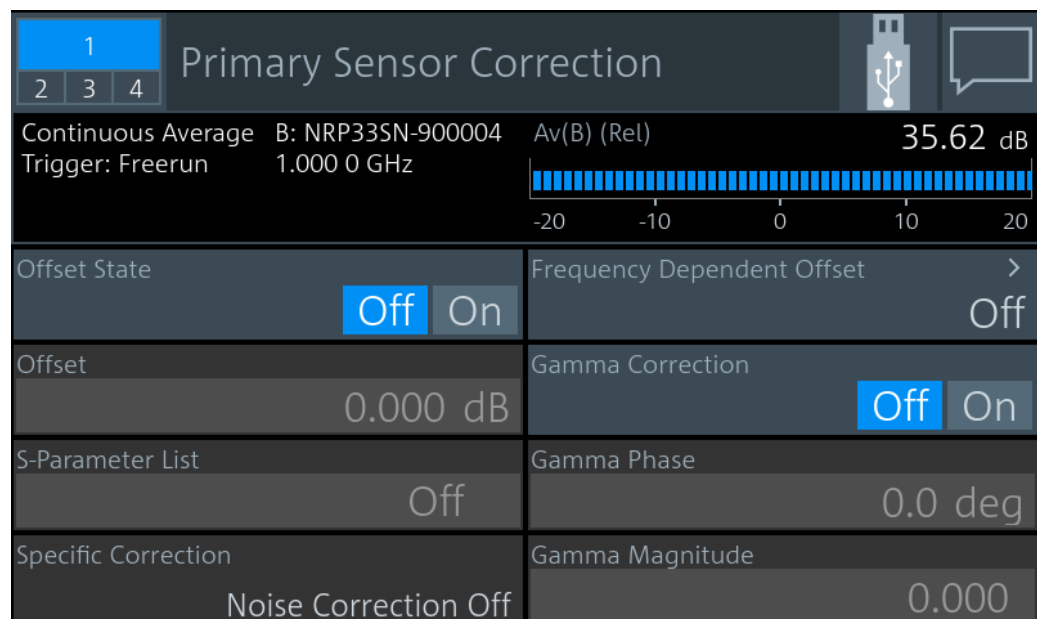

Primary Sensor Correction	
Continuous Average	B: NRP33SN-900004 Av(B) (Rel) 35.62 dB
Trigger: Freerun	1.000 0 GHz
Offset State	Off On
Offset	0.000 dB
S-Parameter List	Off
Specific Correction	Noise Correction Off
Frequency Dependent Offset	Off
Gamma Correction	Off On
Gamma Phase	0.0 deg
Gamma Magnitude	0.000

Offset State.....	120
Offset.....	120
S-Parameter List.....	120
Frequency Dependent Offset.....	120
L Primary Sensor Offsets, Secondary Sensor Offsets dialogs.....	120
L Frequency dependent offset active.....	121
L Frequency dependent offset table.....	121
L Edit table name.....	121
L Edit table "<table name>".....	121
L Export file name, Import file name.....	121
L Export table to file, Import table from file.....	121
Gamma Correction.....	121
Gamma Phase.....	122
Gamma Magnitude.....	122

Offset State

Enables or disables the offset entered under [Offset](#).

Remote command:

`CALCulate<Measurement>[:CHANnel<Channel>]:CORRection:OFFSet:STATE` on page 337

Offset

Sets a fixed offset for compensating external signal losses or gains. See also "[Offset corrections](#)" on page 119.

Remote command:

`CALCulate<Measurement>[:CHANnel<Channel>]:CORRection:OFFSet[:MAGNitude]` on page 339

S-Parameter List

Enables or disables the S-parameter data set stored in the calibration data of the power sensor. See also "[S-Parameter corrections](#)" on page 119.

Remote command:

`[SENSe<Sensor>:]CORRection:SPDevice:STATE` on page 336
`[SENSe<Sensor>:]CORRection:SPDevice:SELEct` on page 336
`[SENSe<Sensor>:]CORRection:SPDevice:LIST?` on page 336

Frequency Dependent Offset

Opens the [Primary Sensor Offsets, Secondary Sensor Offsets dialogs](#).

Primary Sensor Offsets, Secondary Sensor Offsets dialogs ← Frequency Dependent Offset

Configures the power sensor offsets.

Remote command:

`MEMory:TABLE:...`, see [Chapter 13.13, "Managing setups and correction tables"](#), on page 392.

Frequency dependent offset active ← **Primary Sensor Offsets, Secondary Sensor Offsets dialogs** ← **Frequency Dependent Offset**

Enables or disables the selected table.

If enabled, the measurement results are corrected using the specified offset. If the exact frequency value is not available in the table, the values of the table are interpolated. If the selected frequency is outside the specified frequency range, the first or last offset value of the table is used.

Remote command:

`CALCulate<Measurement>[:CHANnel<Channel>]:CORRection:OFFSet:TABLE[:STATe]` on page 338

Frequency dependent offset table ← **Primary Sensor Offsets, Secondary Sensor Offsets dialogs** ← **Frequency Dependent Offset**

Selects one of the available offset tables.

Remote command:

`CALCulate<Measurement>[:CHANnel<Channel>]:CORRection:OFFSet:TABLE:INDEX` on page 338
`MEMory:TABLE:SElect` on page 398

Edit table name ← **Primary Sensor Offsets, Secondary Sensor Offsets dialogs** ← **Frequency Dependent Offset**

Enter the table name.

Remote command:

`MEMory:TABLE:MAP` on page 397

Edit table "<table name>" ← **Primary Sensor Offsets, Secondary Sensor Offsets dialogs** ← **Frequency Dependent Offset**

Opens a dialog to edit the selected table.

Remote command:

`MEMory:TABLE:FREQuency` on page 396
`MEMory:TABLE:FREQuency:POINTs?` on page 397
`MEMory:TABLE:GAIN:POINTs?` on page 397
`MEMory:TABLE:GAIN[:MAGNitude]` on page 397

Export file name, Import file name ← **Primary Sensor Offsets, Secondary Sensor Offsets dialogs** ← **Frequency Dependent Offset**

Edits the filename for export/import.

Export table to file, Import table from file ← **Primary Sensor Offsets, Secondary Sensor Offsets dialogs** ← **Frequency Dependent Offset**

Exports or imports the table specified under [Export file name](#), [Import file name](#).

Gamma Correction

Enables or disables the gamma correction. See also ["S-Gamma corrections"](#) on page 119.

Remote command:

`CALCulate<Measurement>[:CHANnel<Channel>]:SGAMma:CORRection:STATE` on page 339

Gamma Phase

Available if [Gamma Correction](#) is enabled.

Sets the phase angle of the complex reflection coefficient of the source.

Remote command:

`CALCulate<Measurement>[:CHANnel<Channel>]:SGAMma:PHASe` on page 339

Gamma Magnitude

Available if [Gamma Correction](#) is enabled.

Sets the magnitude of the complex reflection coefficient of the source.

Remote command:

`CALCulate<Measurement>[:CHANnel<Channel>]:SGAMma[:MAGNitude]` on page 340

7.3 Filter settings

Access:

"Measurement Settings" > "Primary Sensor Config" > "Filter"

"Measurement Settings" > "Secondary Sensor Config" > "Filter"

Available for all measurement types.

Use the averaging filter to reduce fluctuations in the measurement results. Such fluctuations can be caused by inherent noise of the power sensor, modulation of the measurement signal or beats from the superposition of adjacent carriers. A more stable display is traded off against longer measurement times, caused by longer settling times when the power changes. As a starting point, always use automatic filtering. If the automatically selected filter setting proves to be not adequate, you can increase or decrease the averaging number manually.

If you want to learn more about methods how to control the measurement, see the user manual of the power sensor.

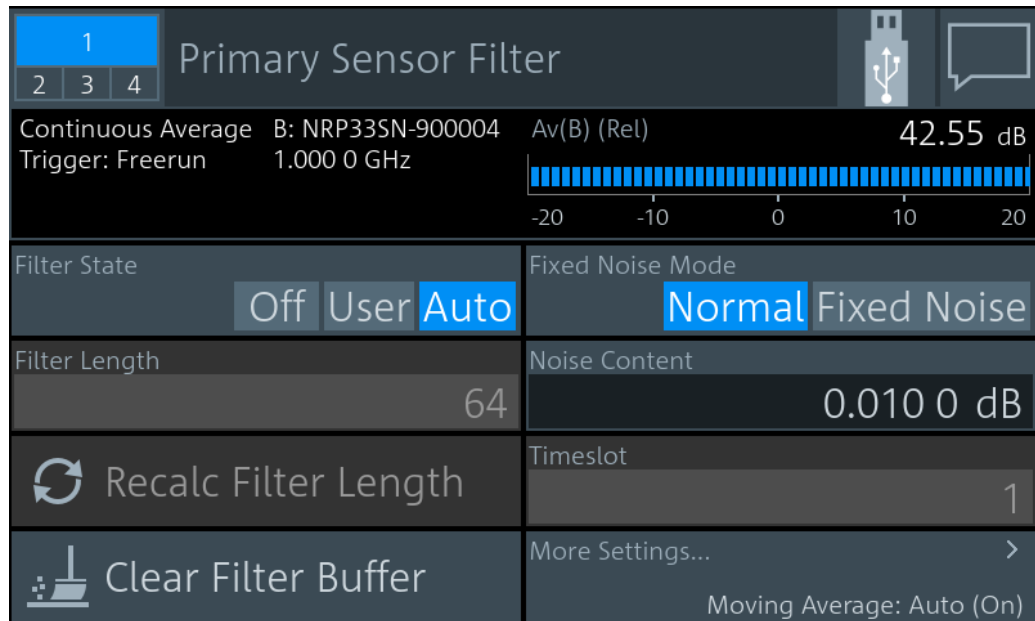

Filter State.....	123
Filter Length.....	123
Recalc Filter Length.....	124
Clear Filter Buffer.....	124
Fixed Noise Mode.....	124
Noise Content.....	124
Maximum Settling Time.....	124
Timeslot.....	125
Moving Average State.....	125
Moving Average.....	125
Averaging Domain.....	125
Video Bandwidth.....	126

Filter State

Enables or disables the averaging filter. If enabled, the number of measured values is averaged. Averaging reduces the effect of noise so that more reliable results are obtained.

Remote command:

`CALCulate<Measurement>[:CHANnel<Channel>]:AVERage[:STATe]`

on page 345

`CALCulate<Measurement>[:CHANnel<Channel>]:TRACe:AVERage[:STATe]`

on page 347

Filter Length

Sets the number of readings that are averaged for one measured value. The higher the count, the lower the noise, and the longer it takes to obtain a measured value.

If [Filter State](#) is set to "Auto", this parameter is read-only.

Remote command:

`CALCulate<Measurement>[:CHANnel<Channel>]:AVERage:COUNT[:VALue]`
on page 374

`CALCulate<Measurement>[:CHANnel<Channel>]:TRACe:AVERage:COUNT[:VALue]` on page 345

Recalc Filter Length

Available for continuous average, burst average, time gate measurements.

Recalculates the number of readings that are averaged for one measured value.

Remote command:

`CALCulate<Measurement>[:CHANnel<Channel>]:AVERage:COUNT:AUTO[:STATE]` on page 373

Clear Filter Buffer

Available for continuous average, burst average, time gate measurements.

Clears the filter buffer.

Remote command:

`[SENSe<Sensor>:]AVERage:RESet` on page 341

Fixed Noise Mode

Available for continuous average, burst average measurements.

Sets the autofilter.

"Normal" Sets the averaging number so that the intrinsic noise of the power sensor, 2 standard deviations, does not exceed the specified "Noise Content" on page 124.

"Fixed Noise" Limits the averaging number as specified in [Maximum Settling Time](#) to avoid very long settling times.

Remote command:

`CALCulate<Measurement>[:CHANnel<Channel>]:AVERage:COUNT:AUTO:TYPE` on page 343

Noise Content

If [Fixed Noise Mode](#) is set to "Normal", available for continuous average, burst average measurements.

Sets the averaging number so that the intrinsic noise of the power sensor does not exceed the specified value.

Remote command:

`CALCulate<Measurement>[:CHANnel<Channel>]:AVERage:COUNT:AUTO:NSRatio` on page 342

Maximum Settling Time

If [Fixed Noise Mode](#) is set to "Fixed Noise", available for continuous average, burst average measurements.

Sets an upper time limit, a maximum time, that is never exceeded.

Remote command:

`CALCulate<Measurement>[:CHANnel<Channel>]:AVERage:COUNT:AUTO:MTIME` on page 342

Timeslot

Available for continuous average, burst average measurements.

Sets a timeslot from which the measured value is used to determine the filter length automatically. The timeslot number must not exceed the number of the currently set timeslots.

Remote command:

`CALCulate<Measurement>[:CHANnel<Channel>]:AVERage:COUNT:AUTO:SLOT` on page 342

Moving Average State

Available for continuous average, burst average, trace, pulse analysis, timeslot, statistics measurements.

Enables or disables the automatic termination control.

Remote command:

`CALCulate<Measurement>[:CHANnel<Channel>]:AVERage:TCONtrol:AUTO` on page 343

`CALCulate<Measurement>[:CHANnel<Channel>]:TRACe:AVERage:TCONtrol:AUTO` on page 346

Moving Average

Available for continuous average, burst average, trace, pulse analysis, timeslot, statistics measurements.

Defines how the measurement results are output. This is called termination control.

- | | |
|-----|---|
| On | Outputs intermediate values to facilitate early detection of changes in the measured quantity. In the settled state, that means when the number of measurements specified by the average count has been performed, a moving average is output. |
| Off | Specifies that a measurement result is not output until the entire measurement has been completed. This means that the number of measurement cycle repetitions is equal to the set average count. If the average count is large, the measurement time can be very long. |

Remote command:

`CALCulate<Measurement>[:CHANnel<Channel>]:AVERage:TCONtrol[:ENUM]` on page 344

`CALCulate<Measurement>[:CHANnel<Channel>]:TRACe:AVERage:TCONtrol[:ENUM]` on page 346

Averaging Domain

Requires an R&S frequency selective power sensor.

Sets the averaging method. See also the user manual of the power sensor.

- | | |
|---------|-----------------------|
| "Power" | Power averaging |
| "Video" | Logarithmic averaging |

"Linear" Amplitude averaging

Remote command:

`CALCulate<Measurement>[:CHANnel<Channel>]:AVERage:TYPE` on page 345

Video Bandwidth

Requires a wideband power sensor.

Sets the video filter bandwidth. Reducing the video bandwidth also increases the trigger sensitivity.

Note: The video bandwidth must never be smaller than the RF bandwidth of the signal.

Remote command:

`CALCulate<Measurement>[:CHANnel<Channel>][:POWer]:VBWidth:ENUM`
on page 348

7.4 Range settings

Access:

"Measurement Settings" > "Primary Sensor Config" > "Range"

"Measurement Settings" > "Secondary Sensor Config" > "Range"

Available for continuous average, burst average, trace, pulse analysis, time gate, time-slot, statistics measurements.

Some power sensors have only one measurement range, others have two or three measurement ranges. For details, see the data sheet of the power sensor.

The measurement ranges are also called measurement paths. All available paths are continuously and simultaneously measured. Adjacent paths overlap by about 6 dB, and the final measurement result is achieved by appropriately weighting the measurement results of all paths.

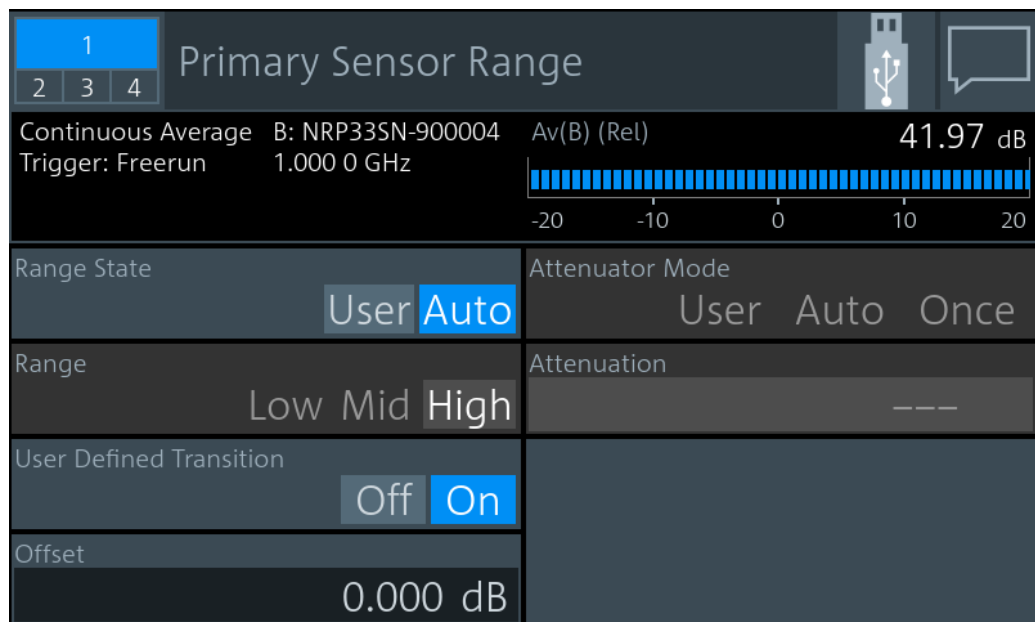

Range State.....	127
Range.....	127
User Defined Transition.....	127
Offset.....	128
Attenuator Mode.....	128
Attenuation.....	128

Range State

Enables or disables the automatic measurement path selection.

Remote command:

`CALCulate<Measurement>[:CHANnel<Channel>][:POWer][:AVG]:RANGe:
AUTO` on page 349

Range

Available if [Range State](#) is set to "User".

Sets the active measurement path in which the power sensor is measuring.

Remote command:

`CALCulate<Measurement>[:CHANnel<Channel>][:POWer][:AVG]:RANGe[:
VALue]` on page 350

User Defined Transition

Available if [Range State](#) is set to "Auto".

Enables or disables the reduction of the transition range between the measurement paths, entered under [Offset](#).

Remote command:

`CALCulate<Measurement>[:CHANnel<Channel>][:POWer][:AVG]:RANGe:
CLEVel:STATe` on page 350

Offset

Reduces the transition range between the measurement paths, 0 -> 1 and 1 -> 2, by the set value, the so-called cross-over level. Thus, you can improve the measurement accuracy for signals with a high peak-to-average ratio, since the headroom for modulation peaks becomes larger. However, the S/N ratio is reduced at the lower limits of the transition ranges.

Remote command:

```
CALCulate<Measurement>[:CHANnel<Channel>][:POWer][:AVG]:RANGe:CLEVel[:VALue] on page 350
```

Attenuator Mode

Requires an R&S frequency selective power sensor.

"User"	Disables the automatic setting of the input attenuation.
"Auto"	Enables the automatic setting of the input attenuation.
"Once"	Adjusts the input attenuation one time, then disables the automatic setting.

Remote command:

```
CALCulate<Measurement>[:CHANnel<Channel>]:INPut:ATTenuation:AUTO on page 348
```

Attenuation

Requires an R&S frequency selective power sensor.

Available if [Attenuator Mode](#) is set to "User".

Sets the input attenuation. Only two values are possible, 0.0 dB and 30.0 dB. The entered value is rounded to the next value.

Remote command:

```
CALCulate<Measurement>[:CHANnel<Channel>]:INPut:ATTenuation[:VALue] on page 349
```

7.5 NRT measurement type

Requirements:

- "Measurement Settings" > "Measurement Type" > "NRT"
- Interface for R&S NRT-Z sensors (R&S NRX-B9), see [Chapter 3.2.1.2, "Module bay"](#), on page 26.
- R&S directional power sensors

Further information:

- [Chapter 6.9, "NRT"](#), on page 108
- [NRT mode settings](#)..... 129
- [NRT correction settings](#)..... 130
- [NRT filter settings](#)..... 132

7.5.1 NRT mode settings

Access: "Measurement Main Configuration" > "Sensor Configuration" > "Mode"

Channel Mode Configuration		Aver	-60		4.04 dBm	10
NRT	NRT-Z44-107050					
Trigger: Normal	1.000 0 GHz					
Trigger: Normal		RLoss	-200		10.90 dB	200
Burst Mode	Auto User	Direction	Auto		1 > 2	2 > 1
Burst Period	10.000 ms	CCDF Threshold			10.000 W	
Burst Width	1.000 0 ms	PEP Hold Time			60.00 ms	

Burst Mode.....	129
Burst Period.....	129
Burst Width.....	130
Direction.....	130
CCDF Threshold.....	130
PEP Hold Time.....	130

Burst Mode

Defines how the average burst power is determined.

"Auto" Not supported by all power sensors.
The power sensor automatically recognizes the duty cycle of the burst series and calculates the average burst power from this duty cycle and the average power. Set an appropriate [Video Bandwidth](#).

"User" Define the duty cycle by:

- [Burst Period](#)
- [Burst Width](#)

The R&S NRX calculates the average burst power from these values.

Remote command:

```
CALCulate<Measurement>[:CHANnel<Channel>]:NRT:BURSt:MODE
```

Burst Period

Available if "User" is set under "[Burst Mode](#)" on page 129.

Sets the burst period.

Remote command:

```
CALCulate<Measurement>[:CHANnel<Channel>]:NRT:BURSt:PERIOD
```

Burst Width

Available if "User" is set under "[Burst Mode](#)" on page 129.

Sets the burst width.

Remote command:

```
CALCulate<Measurement>[:CHANnel<Channel>]:NRT:BURSt:WIDTh
```

Direction

Defines how the forward power is determined.

"Auto" Determines the power flow direction automatically. The greater value of two measured values is automatically assigned as forward power.

"1 > 2", "2 > 1" Sets a fixed direction of the forward power, either from port 1 to port 2, or from port 2 to port 1.
The two ports are indicated on the directional power sensor.

Remote command:

```
CALCulate<Measurement>[:CHANnel<Channel>]:NRT:DIRection
INPut<Sensor>:PORT:SOURce:AUTO
INPut<Sensor>:PORT:SOURce[:VALue]
```

CCDF Threshold

Sets the threshold for the complementary cumulative distribution function, [CCDF](#).

Remote command:

```
CALCulate<Measurement>[:CHANnel<Channel>]:NRT:CCDF:THReshold
```

PEP Hold Time

Sets the hold time of the peak hold circuit of the power sensor. See also [Peak Envelope Power \(PEP\)](#).

Remote command:

```
CALCulate<Measurement>[:CHANnel<Channel>]:NRT:PEP:HOLD:TIME
```

7.5.2 NRT correction settings

Access: "Measurement Main Configuration" > "Sensor Configuration" > "Correction"

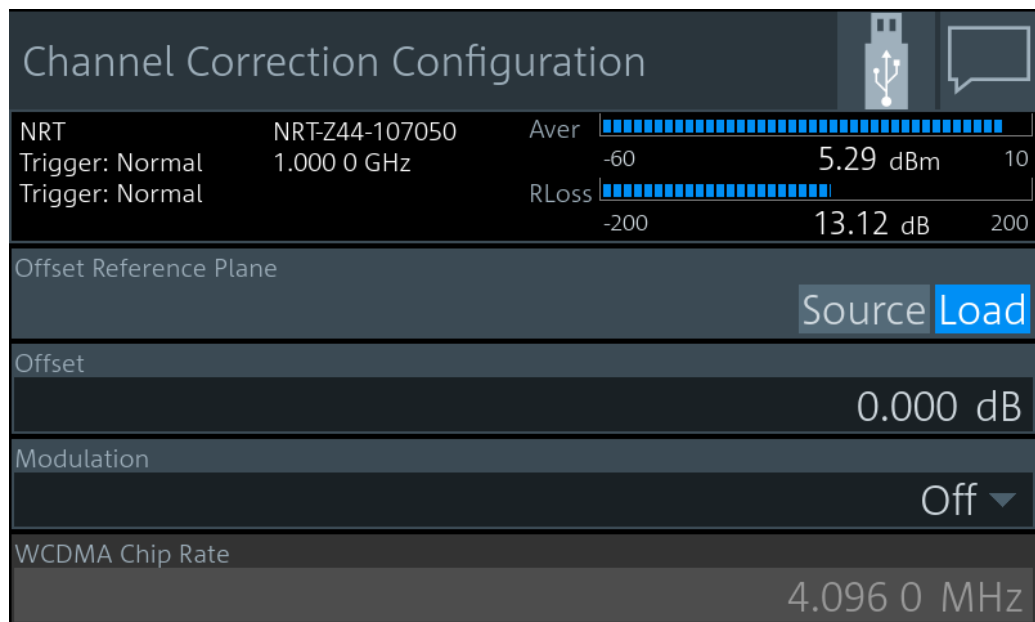

Offset Reference Plane.....	131
Offset.....	131
Modulation.....	131
WCDMA Chip Rate.....	132

Offset Reference Plane

Selects the power sensor port to which the measurement results are referred to.

"Source" Source connector of the R&S NRT-Zxx power sensor

"Load" Load connector of the R&S NRT-Zxx power sensor

Remote command:

```
CALCulate<Measurement>[:CHANnel<Channel>]:CORRection:OFFSet:
RPLane
INPut<Sensor>:PORT:POSition
```

Offset

Considers the transmission loss in a cable that connects the desired measurement point, set by [Offset Reference Plane](#), and the power sensor.

Remote command:

```
CALCulate<Measurement>[:CHANnel<Channel>]:CORRection:OFFSet:
STATe
CALCulate<Measurement>[:CHANnel<Channel>]:CORRection:OFFSet[:
MAGNitude]
INPut<Sensor>:PORT:OFFSet
```

Modulation

Sets a communication standard for the modulation correction to reduce systematic deviations occurring in power measurements.

"Off" Disabled.

- "IS95" IS- 95 CDMA standard for base stations.
- "WCDMA" WCDMA standard for base stations.
- "DVB-T" DVB-T standard for terrestrial DVB TV transmitters.
- "DAB" DAB standard for radio transmitters.

Remote command:

```
CALCulate<Measurement>[:CHANnel<Channel>]:NRT:DMODulation[:
VALue]
[SENSe<Sensor>:]DM:STATe
[SENSe<Sensor>:]DM:STANdard
```

WCDMA Chip Rate

Available if "WCDMA" is set under [Modulation](#).

Sets the chip rate for the WCDMA communication standard.

Remote command:

```
CALCulate<Measurement>[:CHANnel<Channel>]:NRT:DMODulation:WCDMa:
CRATe
```

7.5.3 NRT filter settings

Access: "Measurement Main Configuration" > "Sensor Configuration" > "Filter"

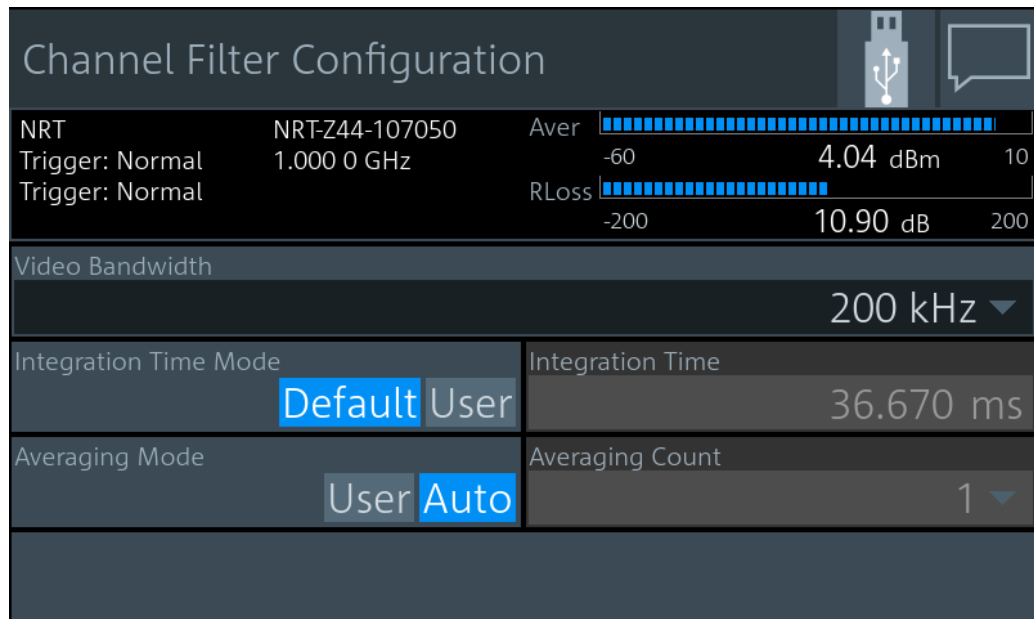

[Video Bandwidth](#)..... 133

[Integration Time Mode](#)..... 133

[Integration Time](#)..... 133

[Averaging Mode](#)..... 133

[Averaging Count](#)..... 133

Video Bandwidth

For measuring the peak envelope power, specify the video bandwidth that the power sensor uses for measuring the detected RF signal.

"4 kHz" | "200 kHz" | "Full"

"Full" means that the maximum bandwidth of the power sensor is used.

Remote command:

```
CALCulate<Measurement>[:CHANnel<Channel>]:NRT:VBWidth[:VALue]
[SENSe<Sensor>:]BANDwidth:VIDeo:FNUMber
[SENSe<Sensor>:]BWIDth:VIDeo:FNUMber
```

Integration Time Mode

Specifies which integration time is used for a single measurement.

"Default" Uses the default settings.

"User" Define a value under [Integration Time](#).

Remote command:

```
CALCulate<Measurement>[:CHANnel<Channel>]:NRT:APERture:MODE
```

Integration Time

Available if [Integration Time Mode](#) is set to "User".

Defines the integration time for a single measurement.

Remote command:

```
CALCulate<Measurement>[:CHANnel<Channel>]:NRT:APERture[:VALue]
```

Averaging Mode

Sets the averaging mode.

"User" Define the value under [Averaging Count](#).

"Auto" Determines the average count automatically from the level of the input signal.

Remote command:

```
CALCulate<Measurement>[:CHANnel<Channel>]:AVERage:COUNT:AUTO[:
STATE]
```

Averaging Count

Available if [Averaging Mode](#) is set to "User".

Sets the number of readings that are averaged for one measured value. The higher the count, the lower the noise, and the longer it takes to obtain a measured value.

Remote command:

```
CALCulate<Measurement>[:CHANnel<Channel>]:AVERage:COUNT[:VALue]
```

8 Saving and recalling settings

When shutting down, the R&S NRX saves the measurement settings. When booting the next time, the R&S NRX uses the settings from the last session. See also [Chapter 3.1.10, "Switching on or off"](#), on page 24.

If you want to return to a defined initial state, perform a preset. See "[Preset](#)" on page 135.

If you want to save specific measurement settings to reuse at another time, save the setup in a file. The R&S NRX offers 20 setup files for this purpose.

Access: [Preset] > "Save / Recall / Preset" dialog

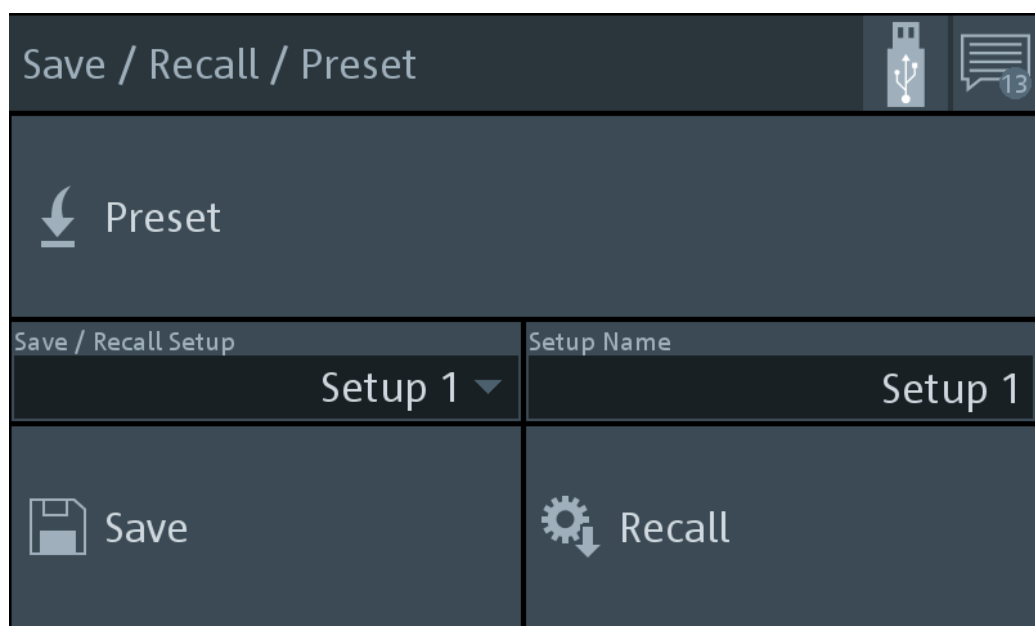

Figure 8-1: Save / Recall / Preset dialog

To save settings

1. Press [Preset].
2. Under "Save / Recall Setup", select a setup, for example "Setup 2".
3. If you want to give the setup a meaningful name, enter a new name under "Setup Name".
4. Tap "Save".

To recall settings

1. Press [Preset].
2. Under "Save / Recall Setup", select the setup you want to load, for example "Setup 2".

3. Tap "Recall".

Preset.....	135
Save / Recall Setup.....	135
Save.....	135
Setup Name.....	135
Recall.....	135

Preset

Sets the R&S NRX and the connected R&S power sensors to a defined initial state. Thus, you can change parameter values from a well defined starting point.

If the default setting of the R&S NRX is not compatible with the power sensor, either the default settings are adapted for the power sensor or a setting conflict results. See also [Chapter 5.5, "Settings conflict"](#), on page 50.

For details on sensor settings, see the user manual of the R&S power sensor.

Remote command:

```
SYSTEM:PRESet
*RST
```

Save / Recall Setup

Selects the setup file in which the instrument settings are saved.

Remote command:

```
MEMORY:STATe:DEFine
MEMORY:STATe:MAP
```

Save

Saves the current instrument settings in the selected setup file.

Remote command:

```
*SAV
```

Setup Name

Selects the setup file from which to load the instrument settings.

Remote command:

```
MEMORY:STATe:DEFine
MEMORY:STATe:MAP
```

Recall

Restores the selected instrument settings.

Remote command:

```
*RCL
```

9 Zeroing sensors

Zeroing removes offset voltages from the analog circuitry of the sensors, so that there are only low powers displayed when there is no power applied.

Zeroing is recommended if:

- The temperature has varied by more than 5 K.
- The sensor has been replaced.
- No zeroing was performed in the last 24 hours.
- Signals of very low power are to be measured, for instance, if the expected measured value is less than 10 dB above the lower measurement range limit.

Access: [Zero] > "Zeroing Sensors" dialog

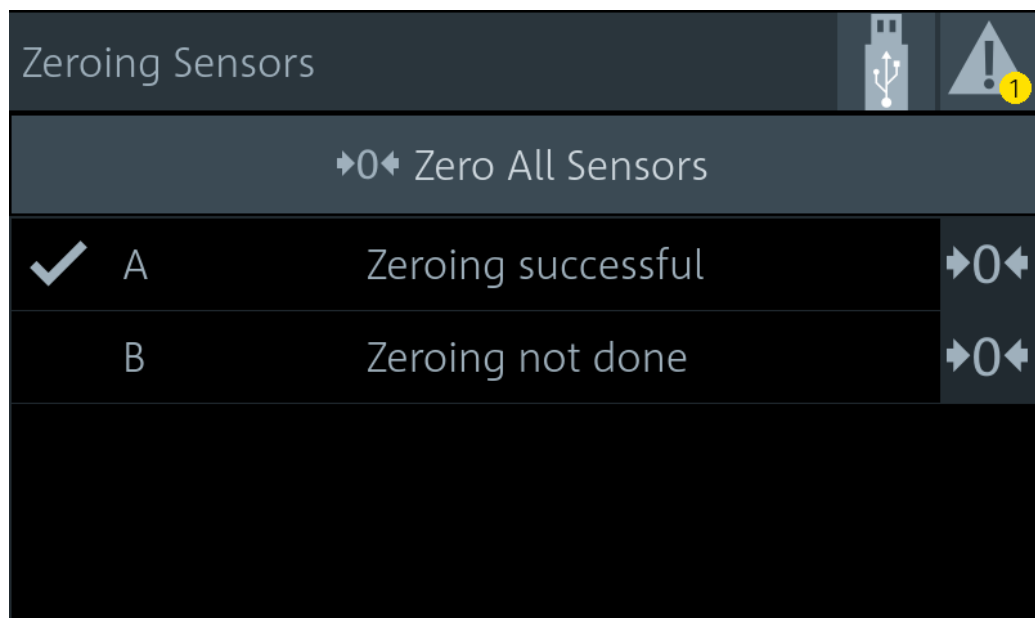

Figure 9-1: Zeroing Sensors dialog

The table below "Zero All Sensors" shows all connected sensors with:

- Port name, A to D
- Zeroing status: not done, in progress, successful

Sensors zeroed successful are also checked:

To zero sensors

1. Disconnect the sensors you want to zero from all power sources. Any signal present at the RF input of a sensor is taken into account. You can either switch off the RF output of a DUT or disconnect the sensor physically from any power source.

Note: An active test signal during zeroing causes an error.

2. Press [Zero].

3. You can zero an individual sensor or all sensors at once:
 - Tap "Zero All Sensors".
 - Tap  in the row of the sensor you want to zero.

The status changes from in progress to successful.

Remote command:

- See [Chapter 13.11, "Zeroing"](#), on page 387.

10 System settings

The system settings do not affect the measurements directly.

Access: [System]

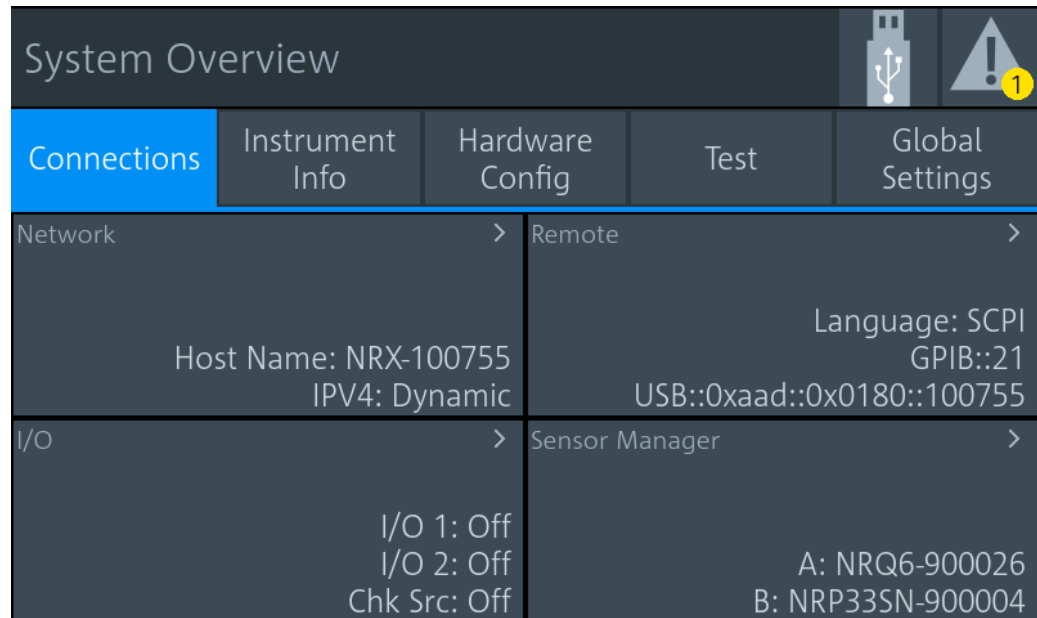

Figure 10-1: System Overview dialog

The "System Overview" dialog is divided into the following tabs:

- [Connections](#)..... 138
- [Instrument info](#)..... 154
- [Hardware configuration](#)..... 166
- [Test](#)..... 167
- [Global settings](#)..... 168

10.1 Connections

Access: [System] > "Connections"

See [Figure 10-1](#).

On this tab, you display and configure the following settings:

- [Network settings](#)..... 139
- [Remote settings](#)..... 142
- [Input/output settings \(I/O\)](#)..... 145
- [Sensor manager](#)..... 151

10.1.1 Network settings

Access: [System] > "Connections" > "Network"

Contains the settings for integrating the R&S NRX in a network. There are two methods to establish a network connection between R&S NRX and computer:

- ▶ Connect both to a common network (infrastructure network).
- ▶ Connect R&S NRX and computer only over the switch (peer-to-peer network).
In this case, the use of a static IP address is recommended.

Connection errors can affect the entire network. If your network does not support DHCP, or if you choose to disable dynamic TCP/IP configuration, assign a valid address information before connecting the R&S NRX to the LAN. Contact your network administrator to obtain valid IP addresses.

After integrating the R&S NRX into a network, you can set up the following connections:

- Remote control connection to control the R&S NRX using SCPI commands.
See [Chapter 4.3, "Remote control"](#), on page 44.
- Remote desktop connection for remote operation or file transfer.
See [Chapter 4.2, "Remote operation"](#), on page 43.

The "Network" dialog is divided into the following tabs:

Overview tab.....	140
L Host Name.....	140
L IP Address.....	140
L Default Gateway.....	141
L DNS Server.....	141
IPv4 tab.....	141
L Address Mode.....	141
L DNS Suffix.....	141
L IPv4 Address.....	142
L Subnet Mask.....	142
L Default Gateway.....	142
L DNS Server.....	142

Overview tab

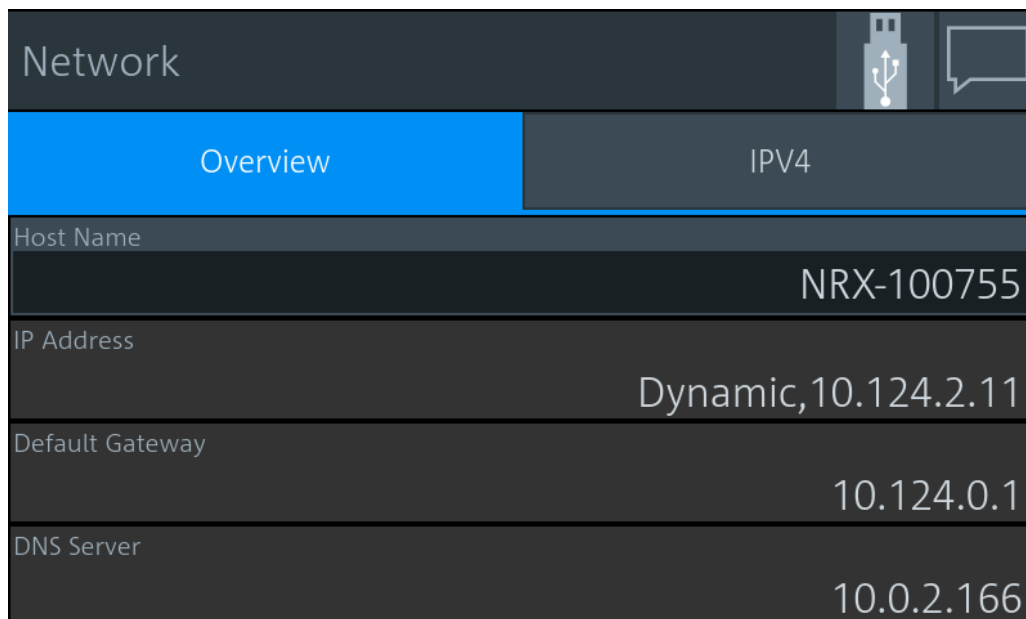

Network	
Overview	IPv4
Host Name	NRX-100755
IP Address	Dynamic, 10.124.2.11
Default Gateway	10.124.0.1
DNS Server	10.0.2.166

Apart from the [Host Name](#), the other parameters are only displayed here. Configure them on the ["IPv4 tab"](#) on page 141.

Host Name ← Overview tab

Sets the individual hostname of the R&S NRX.

In a LAN that uses a domain name system server (DNS server), you can access each connected instrument using a unique hostname instead of its IP address. The DNS server translates the hostname to the IP address. Using a hostname is especially useful if a DHCP server is used, as a new IP address can be assigned each time the R&S NRX is restarted.

For the default hostname, see [Chapter 3.2.2.7, "Name plate"](#), on page 31.

When you change the hostname, the R&S NRX restarts its connection to the network, which can take several seconds. During this time, you cannot address the R&S NRX. After the restart, you can only address the R&S NRX using the newly set hostname.

Note: It is recommended that you do not change the default hostname to avoid problems with the network connection. However, if you change the hostname, be sure to use a unique name.

Remote command:

```
SYSTem:COMMunicate:NETWork[:COMMon]:HOSTname
```

IP Address ← Overview tab

Displays the IP address, and whether it is static or dynamic.

Set the parameters under:

- ["Address Mode"](#) on page 141
- ["IPv4 Address"](#) on page 142

Default Gateway ← Overview tab

Displays the IP address of the default gateway of the local subnet. Set the parameter under "[Default Gateway](#)" on page 142.

DNS Server ← Overview tab

Displays the IP address of the DNS server of the local subnet. Set the parameter under "[DNS Server](#)" on page 142.

IPv4 tab

Network	
Overview	IPv4
Address Mode	DNS Suffix
Dynamic Static	rsint.net
IPv4 Address	
10.124.2.11	
Subnet Mask	Default Gateway
255.255.252.0	10.124.0.1
DNS Server	
10.0.2.166	

Addresses consist of 4 number blocks separated by dots. In maximum, each block contains 3 digits, for example *100.100.100.100*. Fewer digits in a block are also allowed.

Address Mode ← IPv4 tab

Sets how the IP address is assigned.

"Dynamic" Assigns the IP address automatically, provided the network supports the dynamic host configuration protocol (DHCP).

"Static" Enables assigning the IP address manually.

Remote command:

```
SYSTEM:COMMunicate:NETWork[:IPAddress]:MODE
```

```
SYSTEM:COMMunicate:INET[:SELF]:MODE
```

DNS Suffix ← IPv4 tab

Sets the primary DNS suffix, that means the domain name. DNS uses the suffix for registration and name resolution to identify the R&S NRX uniquely in the entire network.

Remote command:

```
SYSTEM:COMMunicate:NETWork[:COMMON]:DOMAIN
```

```
SYSTEM:COMMunicate:INET[:SELF]:DNS:SUFFIX
```

IPv4 Address ← IPv4 tab

Available if "Static" is set under [Address Mode](#).

Sets the IP address of the R&S NRX.

Remote command:

```
SYSTem:COMMunicate:NETWork[:IPAddress][:Address]
SYSTem:COMMunicate:INET[:SELF]:ADDRESS
```

Subnet Mask ← IPv4 tab

Available if "Static" is set under [Address Mode](#).

Sets the subnet mask of your local subnet.

Remote command:

```
SYSTem:COMMunicate:NETWork[:IPAddress]:SUBNet:MASK
SYSTem:COMMunicate:INET[:SELF]:SUBNetmask:ADDRESS
```

Default Gateway ← IPv4 tab

Available if "Static" is set under [Address Mode](#).

Sets the IP address of the default gateway.

Remote command:

```
SYSTem:COMMunicate:NETWork[:IPAddress]:GATeway
SYSTem:COMMunicate:INET[:SELF]:GATeway:ADDRESS
```

DNS Server ← IPv4 tab

Available if "Static" is set under [Address Mode](#).

Sets the DNS server address of your local subnet.

Remote command:

```
SYSTem:COMMunicate:NETWork[:IPAddress]:DNS
SYSTem:COMMunicate:INET[:SELF]:DNS:ADDRESS
```

10.1.2 Remote settings

Access: [System] > "Connections" > "Remote"

Contains the settings for remote control.

The "Remote" dialog is divided into the following tabs:

VISA Resource tab.....	143
L Interface - VISA Resource table.....	143
Settings tab.....	143
L GPIB Address.....	144
Emulations tab.....	144
L Language.....	144
L Customization of *IDN?.....	144
L Customization of *OPT?.....	145
L Custom IDN String.....	145
L Custom OPT String.....	145

VISA Resource tab

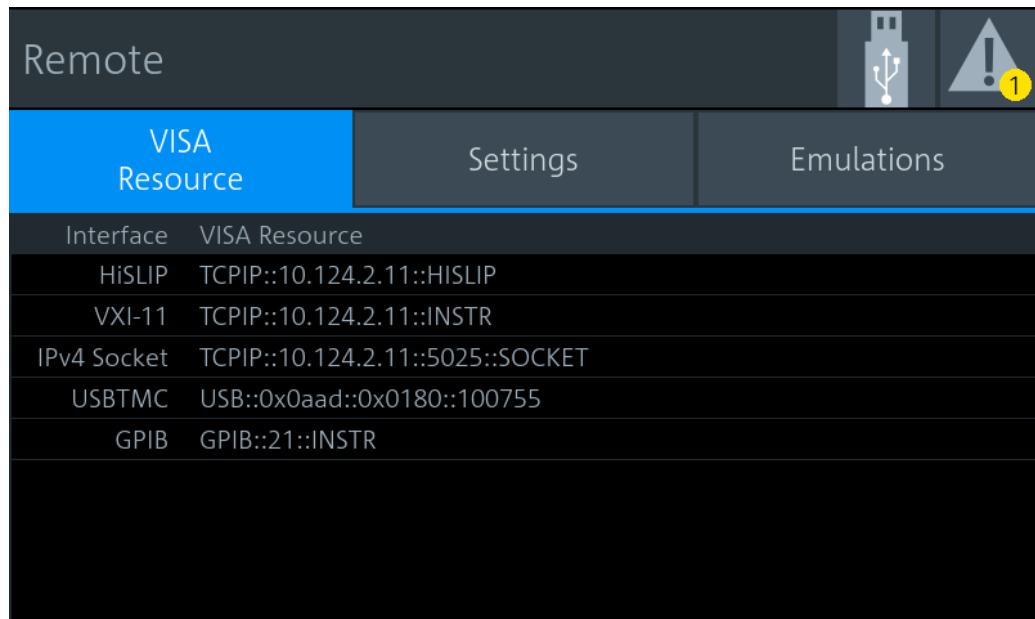

Interface	VISA Resource
HiSLIP	TCPIP::10.124.2.11::HISLIP
VXI-11	TCPIP::10.124.2.11::INSTR
IPv4 Socket	TCPIP::10.124.2.11::5025::SOCKET
USBTMC	USB::0x0aad::0x0180::100755
GPIB	GPIB::21::INSTR

Interface - VISA Resource table ← VISA Resource tab

Displays the VISA resource strings of the interfaces available for remote control.

In a LAN, the VISA resource string is required to establish a communication session between the controller and the R&S NRX. The resource string is a unique identifier, composed of the specific IP address of the instrument and some network and VISA-specific keywords. The resource string depends on the interface used for remote control.

See also [Table 14-1](#).

Settings tab

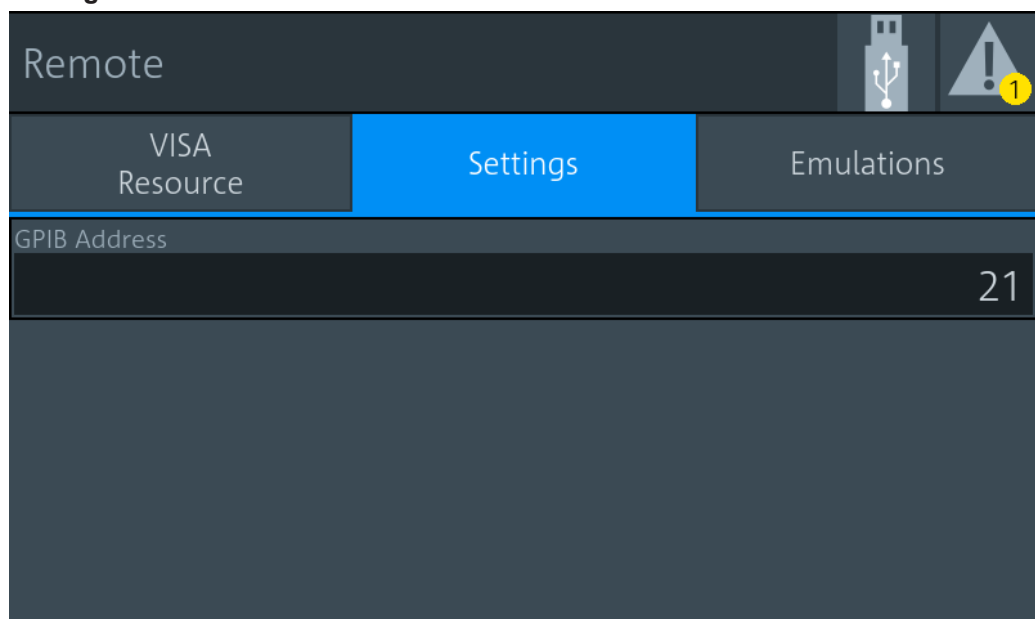

GPIB Address
21

GPIB Address ← Settings tab

Sets the GPIB address.

See also [Chapter 14.1.3, "GPIB interface"](#), on page 468.

"1" to "30" Channel address

Remote command:

`SYSTem:COMMunicate:GPIB[:SELF]:ADDRESS`

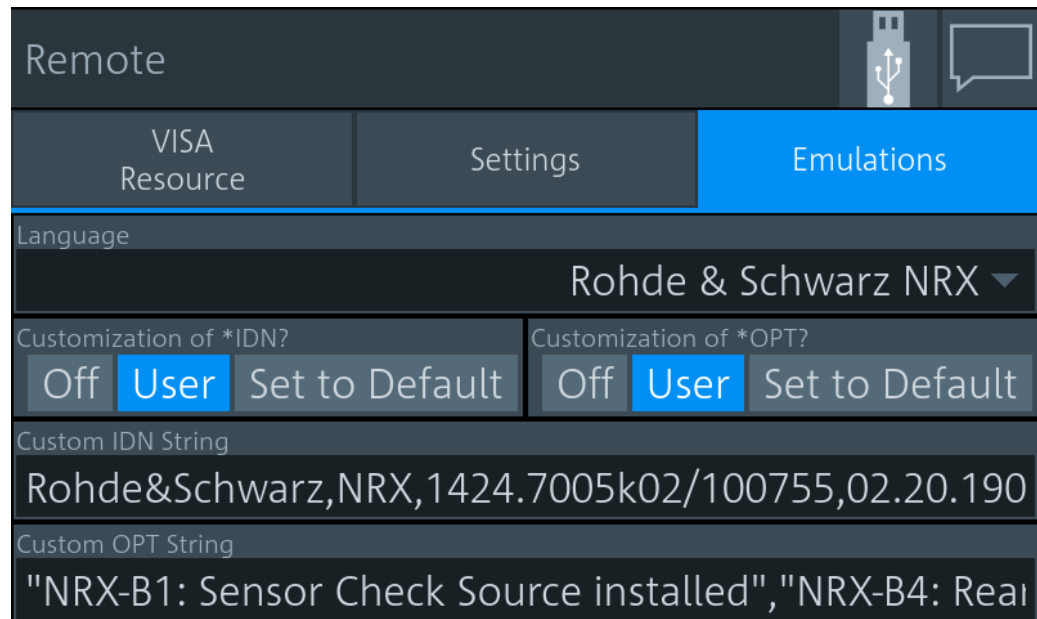
Emulations tab**Language ← Emulations tab**

Sets the language for the remote commands. See also [Chapter 13.16, "Remote emulation"](#), on page 423.

"Rohde & Schwarz NRX"

Native remote command set of the R&S NRX, based on the standard commands for programmable instruments (SCPI-99).

"Rohde & Schwarz NRP2", "Rohde & Schwarz NRP"

Emulation for a predecessor

"Keysight N432A", "Keysight 1911A", "Keysight N1912A", "Keysight E4418B", "Keysight E4419B"

Requires the NRX KS emulation mode (R&S NRX-K301) option.
Emulation of a Keysight power meter.

Remote command:

`SYSTem:LANGuage`

Customization of *IDN? ← Emulations tab

Sets which identification string is used.

"Off" Default identification string

"User" Customized identification string. Enter the customized instrument identification string under [Custom IDN String](#).

"Set to Default" Sets the content of [Custom IDN String](#) to the default identification string.

Remote command:

`SYSTem:IDN:MODE`

`SYSTem:IDN:AUTO`

Customization of *OPT? ← Emulations tab

Sets which option string is used.

"Off" Default option string

"User" Customized option string. Enter the customized option string under [Custom OPT String](#).

"Set to Default" Sets the content of [Custom OPT String](#) to the default identification string.

Remote command:

`SYSTem:OPT:MODE`

`SYSTem:OPT:AUTO`

Custom IDN String ← Emulations tab

Available if [Customization of *IDN?](#) is set to "User".

Sets the customized instrument identification string so that you can identify each R&S NRX individually.

Remote command:

`SYSTem:IDN:ANSWer`

Custom OPT String ← Emulations tab

Available if [Customization of *OPT?](#) is set to "User".

Sets the customized option identification string.

Remote command:

`SYSTem:OPT:ANSWer`

10.1.3 Input/output settings (I/O)

Access: [System] > "Connections" > "I/O"

The "I/O" dialog is divided into the following tabs:

Sensor Check Source tab	146
L Signal Output	146
L Frequency	146
L Measurement for Preview	147
L Power Level	147
L Sensor Check Source Info	147
I/O 1, I/O 2 tabs	147
L Mode	148

L Measurement for Recorder Output.....	149
L 0 V Equivalent.....	149
L 2.5 V Equivalent.....	149
L Measurement for Limit Output.....	150
L Fail Voltage.....	150
L Trigger Source for Trigger Output.....	150
L Impedance for Trigger Input.....	150

Sensor Check Source tab

Requires the sensor check source (R&S NRX-B1). If the option is installed, this tab is displayed as first tab.

Configures the sensor check source (R&S NRX-B1) that is installed in the module bay. See "[Sensor check source \(R&S NRX-B1\)](#)" on page 26.

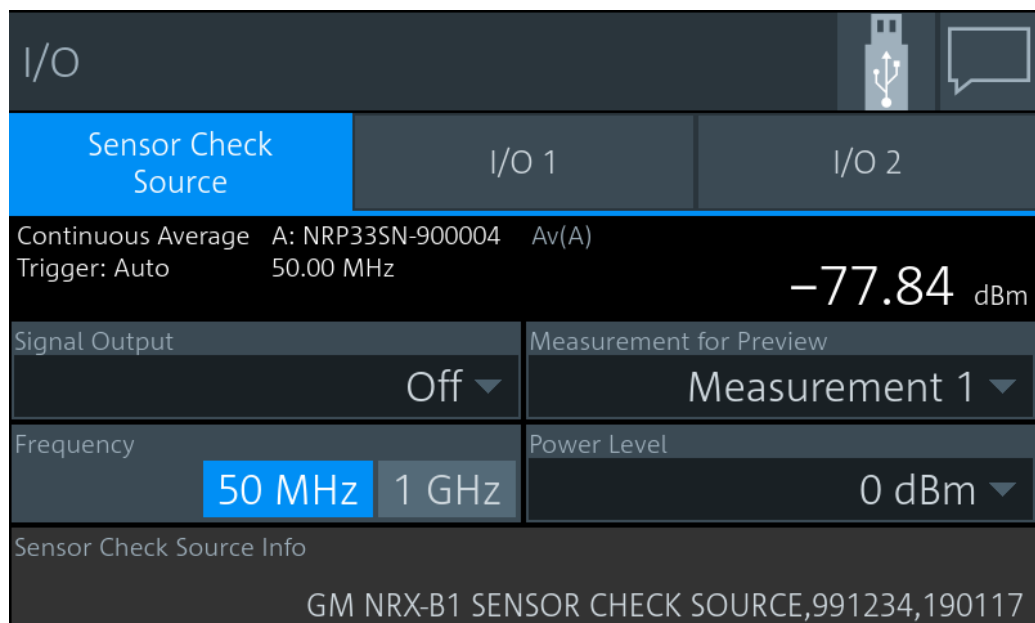

Figure 10-2: Sensor Check Source tab

In the upper pane, the result display shows the effect of parameter changes on the measurement.

Signal Output ← Sensor Check Source tab

Disables the output or sets the signal type, continuous wave or pulses.

Remote command:

`SOURce:OUTPut:STATe`

`OUTPut:SOURce:STATe`

`SOURce:PULM:STATe`

Frequency ← Sensor Check Source tab

Sets the frequency of the output signal.

Remote command:

`SOURce[:RF]:FREQuency[:VALue]`

Measurement for Preview ← Sensor Check Source tab

Selects the measurement that is displayed in the upper right corner.

Power Level ← Sensor Check Source tab

Sets the power level for the output signal.

Remote command:

`SOURce:POWer[:VALue]`

`SOURce:UNIT:POWer`

Sensor Check Source Info ← Sensor Check Source tab

The firmware of the R&S NRX includes a package for the sensor check source (R&S NRX-B1), but the sensor check source (R&S NRX-B1) is not updated automatically. If a new version is available, a warning message is displayed in the notification center and the new version is displayed here as shown in [Figure 10-3](#). Tap the info field to update the sensor check source (R&S NRX-B1).

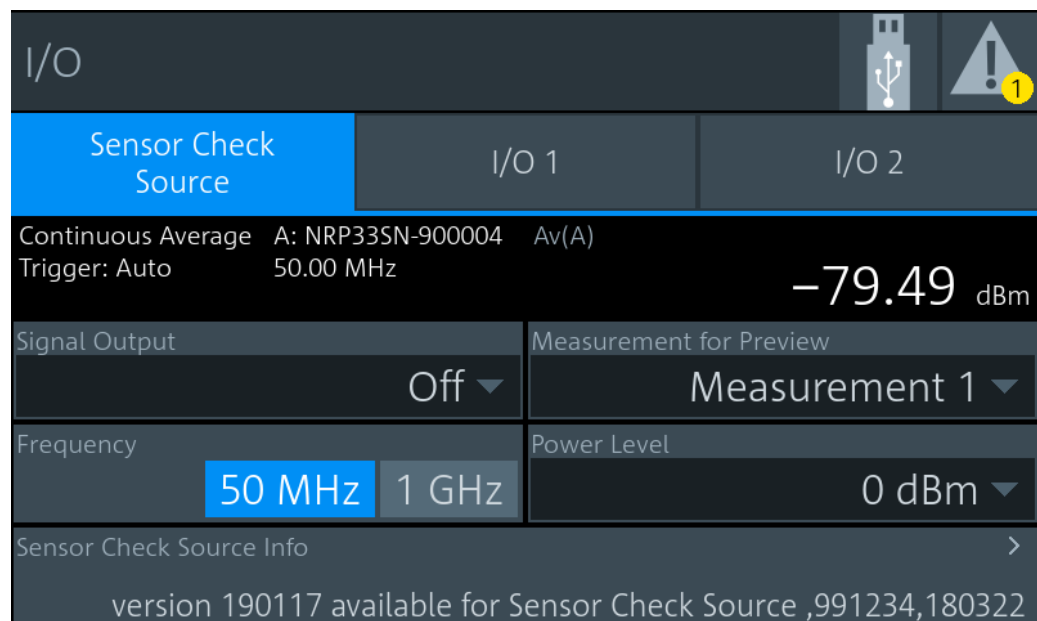

Figure 10-3: New version available for installation

I/O 1, I/O 2 tabs

Configures the two multifunctional BNC connectors at the rear of the R&S NRX, see [Chapter 3.2.2.1, "Trig In / Out 2 and Out 1 / Trig Out connectors"](#), on page 30.

- Use the "I/O 1" tab for Out 1 / Trig Out connector.
- Use the "I/O 2" tab for Trig In / Out 2 connector.

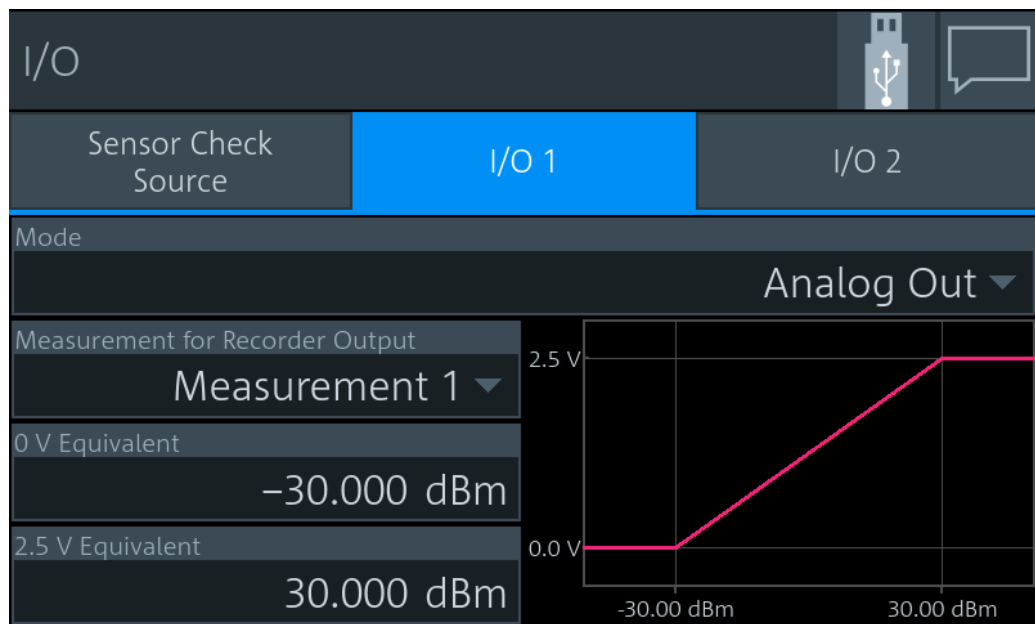

Figure 10-4: Example

Mode ← I/O 1, I/O 2 tabs

Sets the functionality of the Out 1 / Trig Out and Trig In / Out 2 connectors.

"Off" Disables the connector.

"Analog Out" Available for continuous average, burst average, time gate, timeslot measurements.
Provides an analog voltage that is proportional to the displayed value.

"Forw Analog Out", "Refl Analog Out"
Available for NRT measurements.
Provides an analog voltage that is proportional to the displayed value.

"Limit Violation"

Available for:

- continuous average, burst average, time gate, timeslot measurements
- Out 1 / Trig Out BNC connector ("I/O 1" tab)

Sets the fail voltage that is output if a measured value causes a limit violation.

"Forw Limit Violation"

Available for:

- NRT measurements
- Out 1 / Trig Out BNC connector ("I/O 1" tab)

Sets the fail voltage that is output if a value of the forward measurement causes a limit violation.

"Refl Limit Violation"

Available for the Out 1 / Trig Out BNC connector ("I/O 1" tab).

Sets the fail voltage that is output if a value of the reflection measurement causes a limit violation.

"Trigger Out" Available for the Out 1 / Trig Out BNC connector "I/O 1" tab.
Provides a trigger signal at the Out 1 / Trig Out connector. Select the trigger source under [Trigger Source for Trigger Output](#).

"Trigger In" Available for the Trig In / Out 2 BNC connector ("I/O 2" tab).
Apply an external trigger signal at the Trig In / Out 2 connector. Set the termination resistance under [Impedance for Trigger Input](#).

Remote command:

```
[SENSe<Sensor>:] POWer:REFLection:RANGe:LIMit[:STATe]
[SENSe<Sensor>:] POWer[:POWer]:RANGe:LIMit[:STATe]
OUTPut:MODE<output>
```

Measurement for Recorder Output ← I/O 1, I/O 2 tabs

Available if [Mode](#) is set to:

- "Analog Out"
- "Forw Analog Out"
- "Refl Analog Out"

Sets the measurement of which the results are output.

Remote command:

```
OUTPut:REcorder<output>:FEED:INDEX
```

0 V Equivalent ← I/O 1, I/O 2 tabs

Available if [Mode](#) is set to:

- "Analog Out"
- "Forw Analog Out"
- "Refl Analog Out"

Enter the measurement value that corresponds to 0 V output voltage.

Remote command:

```
OUTPut:REcorder<output>:LIMit:LOWer:CCDF
OUTPut:REcorder<output>:LIMit:LOWer:POWer
OUTPut:REcorder<output>:LIMit:LOWer:RATio:RCoefficient
OUTPut:REcorder<output>:LIMit:LOWer:RATio:RFRatio
OUTPut:REcorder<output>:LIMit:LOWer:RATio:RLOSs
OUTPut:REcorder<output>:LIMit:LOWer:RATio:SWR
OUTPut:REcorder<output>:LIMit:LOWer:RATio[:VALue]
OUTPut:REcorder<output>:LIMit:LOWer[:VALue]
```

2.5 V Equivalent ← I/O 1, I/O 2 tabs

Available if [Mode](#) is set to:

- "Analog Out"
- "Forw Analog Out"
- "Refl Analog Out"

Enter the measurement value that corresponds to 2.5 V output voltage.

Remote command:

```
OUTPut:REcorder<output>:LIMit:UPPer:CCDF
OUTPut:REcorder<output>:LIMit:UPPer:POWer
OUTPut:REcorder<output>:LIMit:UPPer:RATio:RCoefficient
OUTPut:REcorder<output>:LIMit:UPPer:RATio:RFRatio
```

```

OUTPut:REcorder<output>:LIMit:UPPer:RATio:RLOSs
OUTPut:REcorder<output>:LIMit:UPPer:RATio:SWR
OUTPut:REcorder<output>:LIMit:UPPer:RATio[:VALue]
OUTPut:REcorder<output>:LIMit:UPPer[:VALue]

```

Measurement for Limit Output ← I/O 1, I/O 2 tabs

Available if **Mode** is set to:

- "Limit Violation"
- "Forw Limit Violation"
- "Refl Limit Violation"

Sets the measurement that is monitored.

Remote command:

```

[SENSe<Sensor>:] POWer:REFLection:RANGe:LOWer
[SENSe<Sensor>:] POWer[:POWer]:RANGe:LOWer
[SENSe<Sensor>:] POWer:REFLection:RANGe[:UPPer]
[SENSe<Sensor>:] POWer[:POWer]:RANGe[:UPPer]
OUTPut:LIMit:FEED:INDEX

```

Fail Voltage ← I/O 1, I/O 2 tabs

Available if **Mode** is set to:

- "Limit Violation"
- "Forw Limit Violation"
- "Refl Limit Violation"

Sets the fail voltage that is output if a measured value causes a limit violation.

"Low"	0 V
"High"	3.3 V

Remote command:

```

[SENSe<Sensor>:] POWer:REFLection:RANGe:AUTO
[SENSe<Sensor>:] POWer[:POWer]:RANGe:LIMit:DETECT
OUTPut:LIMit:FAIL

```

Trigger Source for Trigger Output ← I/O 1, I/O 2 tabs

Available if **Mode** is set to "Trigger Out".

Sets the trigger source.

Remote command:

```

OUTPut:TRIGger:SOURce

```

Impedance for Trigger Input ← I/O 1, I/O 2 tabs

Available if **Mode** is set to "Trigger In".

Sets the termination resistance of the external trigger signal that is supplied at the Trig In / Out 2 connector. Choose a setting that fits the impedance of the trigger source to minimize reflections on the trigger signals.

Remote command:

```

INPut<undef>:TRIGger:IMPedance

```

10.1.4 Sensor manager

Access: [System] > "Connections" > "Sensor Manager"

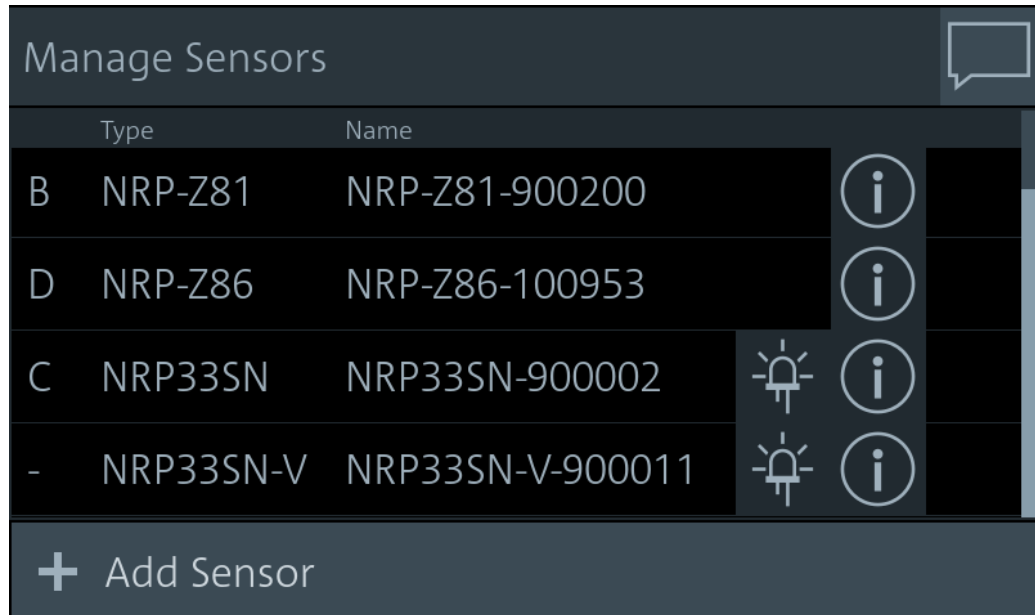

Helps you to manage power sensors, for example, if more than 4 power sensors are connected, or if you want to connect a LAN power sensor.



The R&S NRX recognizes and adds the following power sensors:

- Connected to the ports A to D. They are assigned the letter of the port.
- Connected to one of the USB host interfaces; directly or indirectly, by USB hub. They are assigned the letters E to M.

R&S power sensors that are connected to the LAN interface are not recognized automatically. Add them, see ["To add a LAN power sensor"](#) on page 151.

Symbol	Description
	LED icon Tap to identify a connected power sensor. If the power sensor has a status LED, it flashes yellow for 5 seconds.
	Info icon Tap to open the "Sensor Info" dialog, see "Sensor Info" on page 152.

To add a LAN power sensor

1. In the "Manage Sensors" dialog, tap "Add Sensor".
2. Enter the hostname or IP address of the power sensor.
3. Tap "Check Sensor".
4. Tap "Accept".

The sensor manager gives access to:

Add Sensor	152
Sensor Info	152
L Sensor Test	153

Add Sensor

Adds a LAN power sensor. See "[To add a LAN power sensor](#)" on page 151.

Add Sensor	
ID	Host Name / IP Address
Auto ▼	
Check Sensor	
Type	
Firmware Version	Serial
Accept	Cancel

Remote command:

`[SENSe<Sensor>:]ADD`

Sensor Info

Access: [System] > "Connections" > "Sensor Manager" >

Displays information about the selected power sensor, including calibration data.

Sensor Info			
Connector	ID	Cal. Abs.	2015-07-08
Sensor A	A ▾	Cal. Due Date	2017-07
Type	NRP33SN		
Serial	Firmware Version	Cal. Lin.	not applicable
900004	18.06.14.01	Cal. Misc.	2015-07-08
Sensor Name	NRP33SN-900004		
Sensor Test	>		
		Cal. Refl.	2015-07-08
		Cal. S-Para.	not applicable
		Cal. S-Para. (User)	not applicable
		Cal. Temp.	not applicable
		Coupling	AC
		Function	Power Terminating
		Hostname	nrp33sn-900004
		IP Address	0.0.0.0

Remote command:

`SYSTEM:SENSOR<Sensor>:INFO?`

Sensor Test ← Sensor Info

Tap "Start Test" to start a selftest of the connected power sensor. The selftest provides detailed information that you can use for troubleshooting.

Sensor Test			
Type	Calibration Data:		
NRP33SN	Integrity of Factory Calibration Data Set:		
Serial	Integrity of User Calibration Data Set:		
900004	Operating Voltages:		
Firmware Version	+3V3_VCC_MIO:	PASS	(+3.31 V)
18.06.14.01	+1V8_PS:	PASS	(+1.77 V)
Test Verdict	+1V0_PS:	PASS	(+0.96 V)
FAIL	+3V3_VCC_13:	PASS	(+3.33 V)
Sensor Name	+2V5_VCC_34:	PASS	(+2.42 V)
NRP33SN-900004	+1V8_VCC_35:	PASS	(+1.81 V)
	+1V8_PL:	PASS	(+1.75 V)
	+1V0_PL:	PASS	(+0.98 V)
	+1V0_L_PRRP0_00PE:	PASS	(+1.88 V)
	▶ Start Test		

"Test Verdict" Shows the status of the selftest.

Remote command:

`SYSTEM:SENSOR<Sensor>:TEST?`

`TEST:SENSOR<Sensor>?`

10.2 Instrument info

Access: [System] > "Instrument Info"

For displaying information on a connected power sensor, see "[Sensor Info](#)" on page 152.

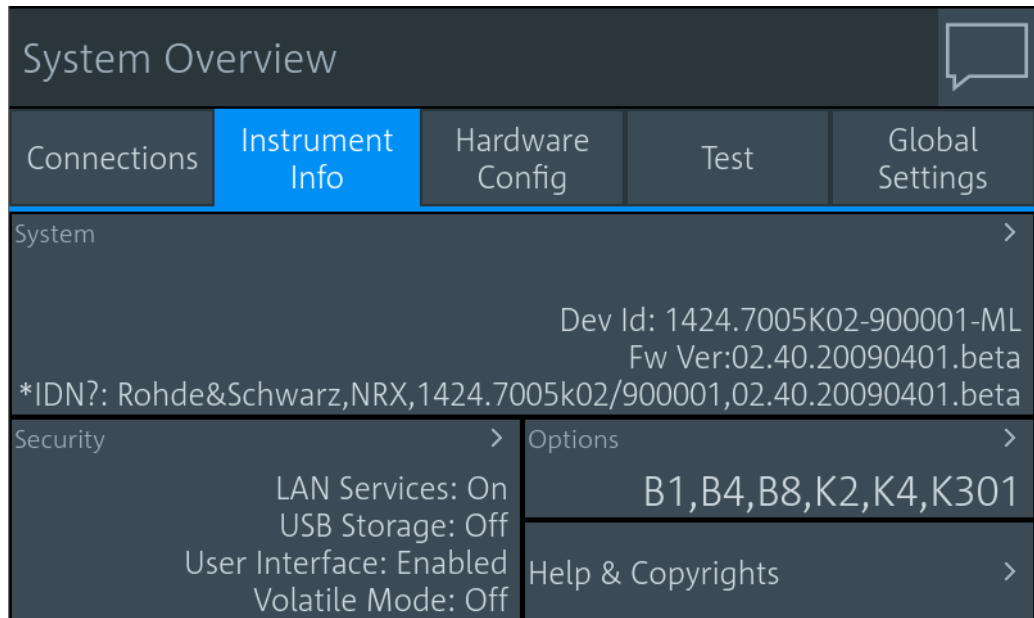

On this tab, you display and configure the following settings:

- [System info](#)..... 154
- [Security settings](#)..... 157
- [Option settings](#)..... 162
- [Help & copyrights](#)..... 165

10.2.1 System info

Access: [System] > "Instrument Info" > "System"

Displays a list of instrument-specific parameters.

System Info	
Manufacturer	Rohde&Schwarz
Type	NRX
Stock Number	1424.7005K02
HW Version	06.00
CPLD Version	2
Serial	100755
Device ID	1424.7005K02-100755-qy
SW Build	02.00.18092001.beta
Options	NRX-K2,NRX-K4,NRX-B4,NRX-B8,NRX-B1

Date and Time Settings >

2018-09-27 / 10:14:53 / Berlin

System Info.....	155
Date and Time Settings.....	156
L Date.....	156
L Time.....	156
L Time Zone Region.....	156
L Time Zone.....	157

System Info

Displays the information on the R&S NRX:

- "Manufacturer"
- "Type"
- "Stock Number"
See [Chapter 3.2.2.7, "Name plate"](#), on page 31.
- "HW Version"
- "CPLD Version"
Complex programmable logic device (CPLD) version
- "Serial"
- "Device ID"
See [Chapter 3.2.2.7, "Name plate"](#), on page 31.
- "SW Build"
Version of software build
- "Options"
Short names of the installed options
- "MAC Address"
Ethernet hardware address
- "Hostname"
See ["Host Name"](#) on page 140.
- "IP Address"
See ["IP Address"](#) on page 140.
- "**IDN?"

Instrument identification string: <manufacturer>,NRX,<serial number>,<firmware version>

- **"*OPT?"**
Option identification string; lists the installed options: <option 1>, <option 2>,
- **"Uptime"**
Operating time of the R&S NRX

Remote command:

`SYSTem:INFO[:INFO]?`

`SYSTem:DID?`

`SYSTem:DEVIce:ID?`

Date and Time Settings

Opens the "Date and Time" dialog.



Date ← Date and Time Settings

Sets the date in the format YYYY-MM-DD.

Remote command:

`SYSTem:DATE`

`SYSTem:DATE:UTC`

`SYSTem:DATE:LOCAl`

Time ← Date and Time Settings

Sets the time in the format HH:MM:SS.

Remote command:

`SYSTem:TIME`

`SYSTem:TIME:UTC`

`SYSTem:TIME:LOCAl`

Time Zone Region ← Date and Time Settings

Sets the time zone region.

Remote command:

`SYSTem:TIME:DSTime:RULE`

`SYSTem:TIME:DSTime:RULE:CATalog?`

Time Zone ← Date and Time Settings

Sets the time zone.

Remote command:

`SYSTem:TIME:DSTime:RULE`

`SYSTem:TIME:DSTime:RULE:CATalog?`

10.2.2 Security settings

Access: [System] > "Instrument Info" > "Security"

Contains the settings for access rights, LAN security and passwords.

The "Security" dialog is divided into the following tabs:

General tab.....	157
L Security Password to Unlock Settings.....	158
L USB Storage.....	158
L Volatile Mode.....	158
L Sanitize.....	158
L User Interface.....	158
LAN Settings tab.....	159
L LAN Services.....	159
L SCPI over LAN.....	159
L Web Server.....	159
L VNC.....	160
L Avahi (Zeroconf).....	160
L SSH.....	160
L Software Update.....	160
Instrument Password tab.....	160
L Old Password.....	160
L New Password.....	160
L Confirm Password.....	161
L Change Password.....	161
Security Password tab.....	161
L Old Password.....	161
L New Password.....	161
L Confirm Password.....	161
L Change Password.....	161

General tab

Configures the access rights for storage devices and restrictions for the user interface.

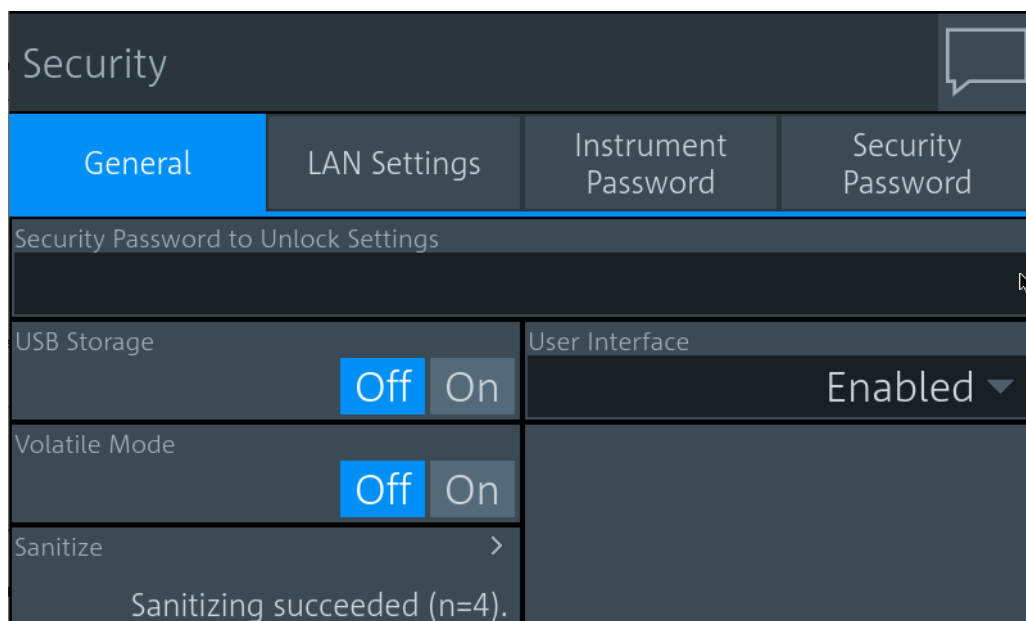

Security Password to Unlock Settings ← General tab

Enter the password that is required to enable the settings protected by a security password. When you leave the "Security" dialog, the settings are disabled automatically.

For preconfigured value and further information, see "[Security Password tab](#)" on page 161.

USB Storage ← General tab

Enables or disables the file transfer via USB storage.

Volatile Mode ← General tab

If enabled, the R&S NRX does not save changed settings in the non-volatile memory. After a reboot, the R&S NRX has the same configuration as at the time when you enabled the volatile mode.

Use the volatile mode if you want to reboot with a defined configuration for a measurement setup, regardless of any settings made manually or by remote control.

Enabling the volatile mode requires the security password. If you change into the volatile mode or back, a reboot is required.

Sanitize ← General tab

Sanitizes the internal memory. Sanitization requires the security password. For details, see the [Chapter 2.1.3, "Instrument security procedures"](#), on page 15.

User Interface ← General tab

Opens a dialog to restrict the manual and remote operation allowed at the R&S NRX. See also [Chapter 4, "Operating concepts"](#), on page 33.

To lift the restrictions indicated by , tap the touchscreen and enter the security password. See also "[Security Password to Unlock Settings](#)" on page 158.

"Enabled" Enables manual operation. The screen and all manual controls are working. Remote operation is also enabled.

"VNC Only"	Disables manual operation. Remote operation remains enabled. The screen remains on; anyone at the R&S NRX can read the screen contents.
"Display Only"	Disables manual and remote operation. Both remain blocked until you enter the security password. The screen remains on; anyone at the R&S NRX can read the screen contents.
"Disabled"	Disables manual and remote operation. Both remain blocked until you enter the security password. The screen only displays a padlock symbol, thus preventing unauthorized reading.

If you use the R&S NRX in a remote operation session, you can set "Display Only" or "Disabled" to make sure that only authorized persons can interrupt the remote session.

LAN Settings tab

Configures the LAN interface in general or all LAN services individually.

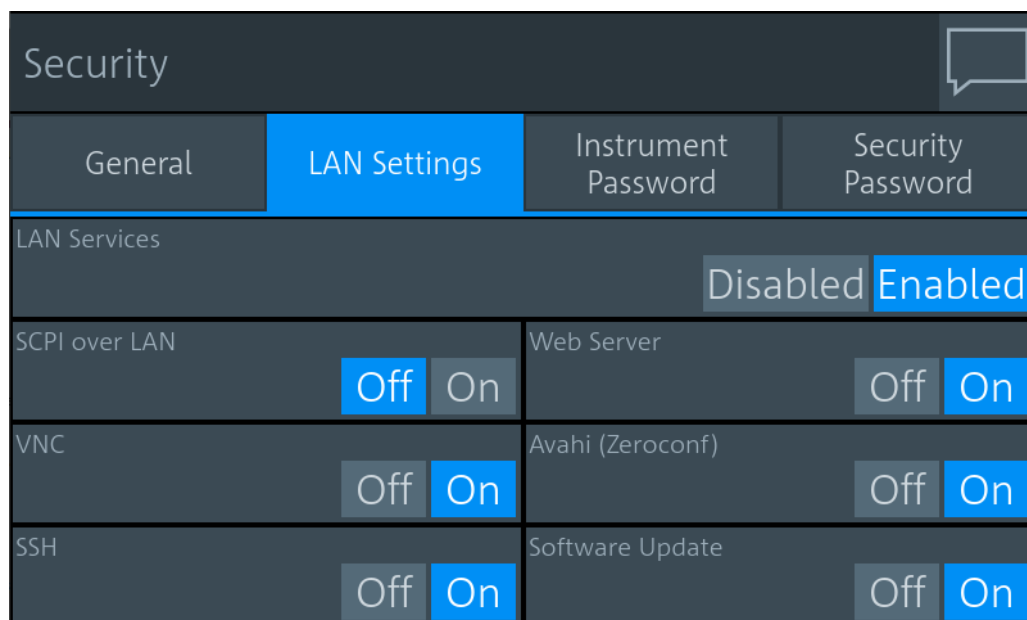

LAN Services ← LAN Settings tab

Enables or disables the LAN services in general. If enabled, it provides remote access via all unlocked services.

SCPI over LAN ← LAN Settings tab

Enables or disables the access over LAN to control the R&S NRX remotely by using SCPI (standard commands for programmable instruments) commands.

Web Server ← LAN Settings tab

Enables or disables a web server that is required to access using a web application.

VNC ← LAN Settings tab

Enables or disables access using a virtual network computing (VNC) interface, a graphical desktop sharing system that uses RFB protocol to control the R&S NRX remotely.

See [Chapter 4.2, "Remote operation"](#), on page 43.

Avahi (Zeroconf) ← LAN Settings tab

Enables or disables Avahi, a service for automatic configuration of the R&S NRX in a network environment.

SSH ← LAN Settings tab

Enables or disables access using a secure shell (SSH), a network protocol for secure data communication.

Software Update ← LAN Settings tab

Enables or disables the software update over LAN.

Instrument Password tab

Used to change the instrument password.

The screenshot shows a 'Security' settings window with four tabs: 'General', 'LAN Settings', 'Instrument Password', and 'Security Password'. The 'Instrument Password' tab is currently selected and highlighted in blue. Below the tabs, there are three input fields labeled 'Old Password', 'New Password', and 'Confirm Password'. At the bottom of the window is a large 'Change Password' button.

Old Password ← Instrument Password tab

Currently used instrument password. The preconfigured password is *instrument*.

Note: We recommend that you change the preconfigured password before connecting the R&S NRX to a network.

The instrument password is required for logon.

New Password ← Instrument Password tab

New instrument password.

Confirm Password ← Instrument Password tab

New instrument password for confirmation.

Note: The new password is not assigned until you tap "Change Password".

Change Password ← Instrument Password tab

Sets the new password as instrument password.

Security Password tab

Used to change the security password.

Old Password ← Security Password tab

Currently used security password. The preconfigured password is 123456.

Note: We recommend that you change the preconfigured password before connecting the R&S NRX to a network.

The security password is required for changing security settings in the "Security" dialog.

New Password ← Security Password tab

New security password.

Confirm Password ← Security Password tab

New security password for confirmation.

Note: The new password is not assigned until you tap "Change Password".

Change Password ← Security Password tab

Sets the new password as security password.

10.2.3 Option settings

Access: [System] > "Instrument Info" > "Options"

Displays installed options and offers an interface to install new options.

The "Options" dialog contains the following parameters:

HW Options tab.....	162
SW Options tab.....	162
Manage License Keys tab.....	163
L Enter License Key.....	164
L Import.....	164
L Export.....	164
Details tab.....	164

HW Options tab

Displays the installed hardware options.

The hardware options on the front panel, you can install yourself. See [Chapter 3.2.1.2, "Module bay"](#), on page 26.

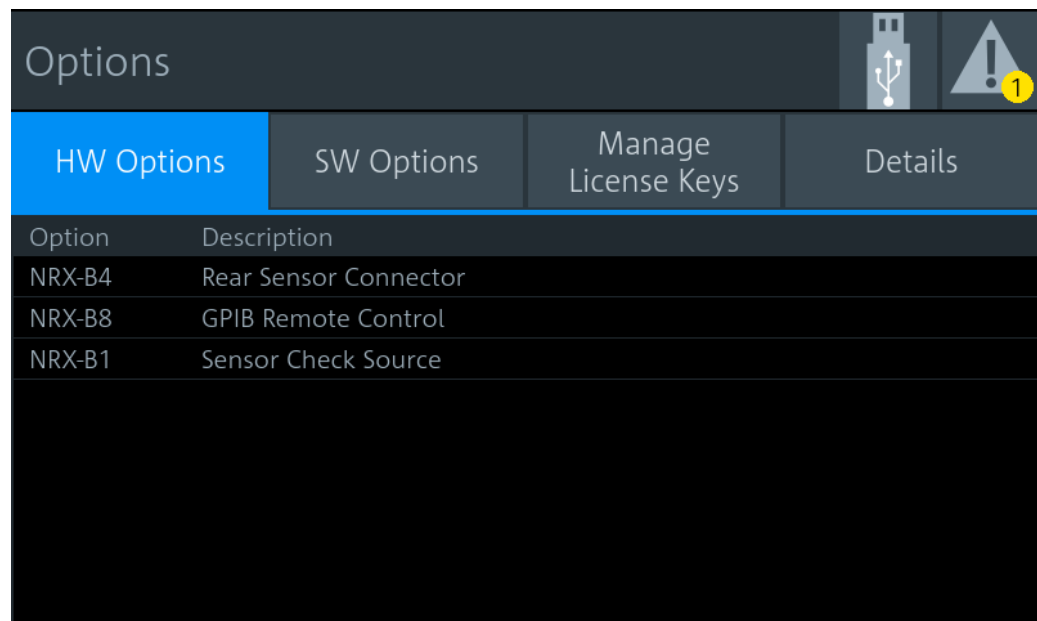

Remote command:

*OPT? on page 183

SW Options tab

Displays all software options and their status. For information on installing options, see [Chapter 11, "Option management"](#), on page 170.

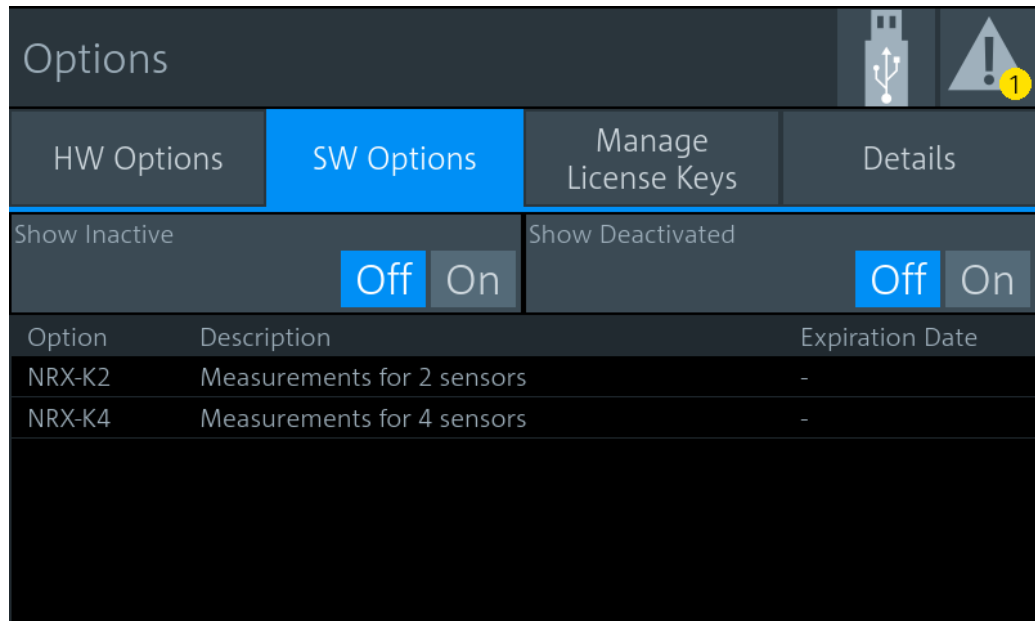

You can filter the displayed list by the following criteria:

"Show Inactive On | Off" Shows or hides inactive software options. These software options are available in the firmware version but are not installed.

"Show Deactivated On | Off" Shows or hides deactivated software options. These software options have been installed but are not active any more, for example because the license key is expired.

Remote command:

*OPT? on page 183

Manage License Keys tab

Used to install or deinstall software options. See also [Chapter 11.1, "Installing a license key"](#), on page 170.

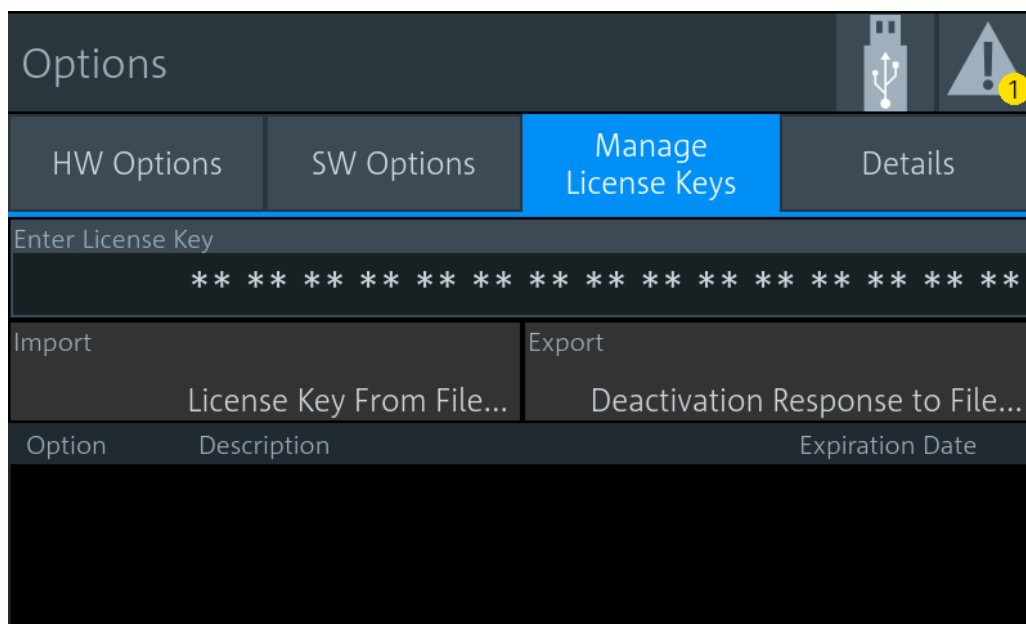

The list gives details on the installed or deinstalled options.

Enter License Key ← Manage License Keys tab

Enter the license key manually.

Import ← Manage License Keys tab

For future use.

Export ← Manage License Keys tab

For future use.

Details tab

Displays a list of all installed hardware and software options.

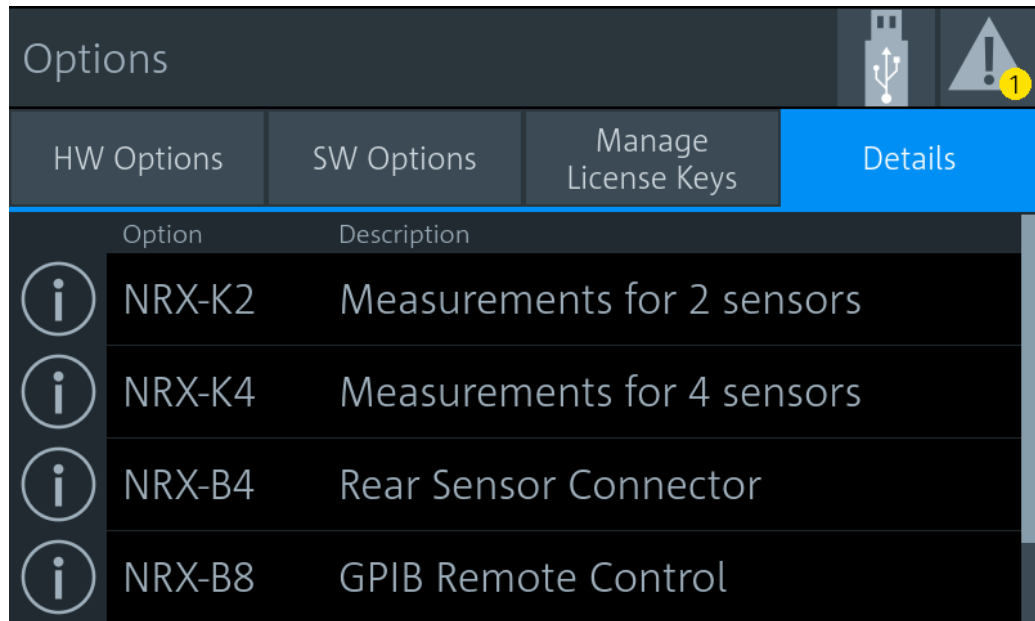

Option	Description
NRX-K2	Measurements for 2 sensors
NRX-K4	Measurements for 4 sensors
NRX-B4	Rear Sensor Connector
NRX-B8	GPIB Remote Control

If you want to see more information on a specific option, tap ⓘ.

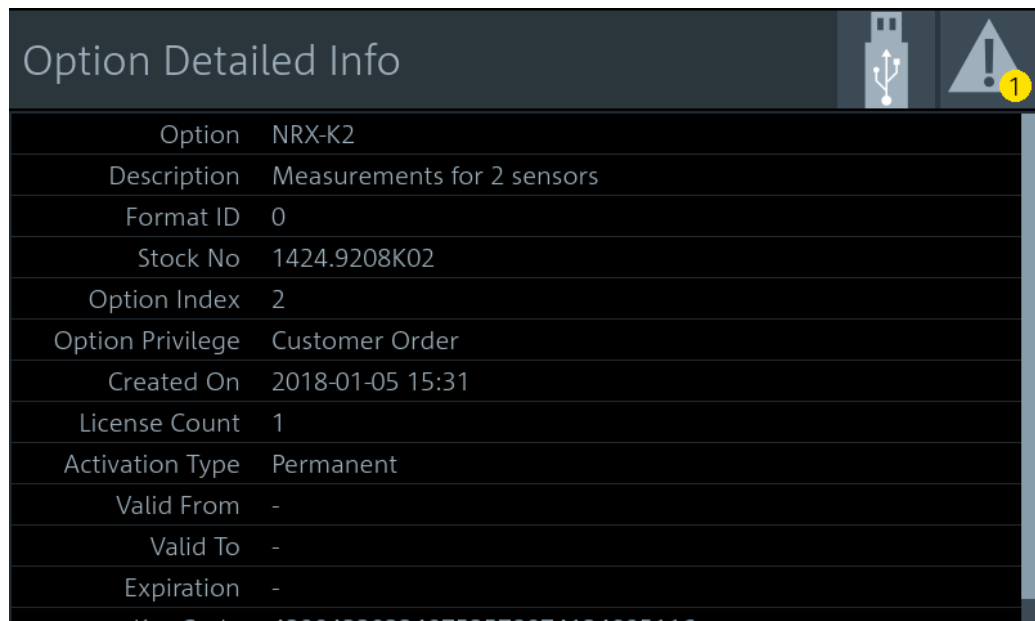

Option	NRX-K2
Description	Measurements for 2 sensors
Format ID	0
Stock No	1424.9208K02
Option Index	2
Option Privilege	Customer Order
Created On	2018-01-05 15:31
License Count	1
Activation Type	Permanent
Valid From	-
Valid To	-
Expiration	-

10.2.4 Help & copyrights

Access: [System] > "Instrument Info" > "Help & Copyrights"

Gives access to the user manual, open source acknowledgement and license information.

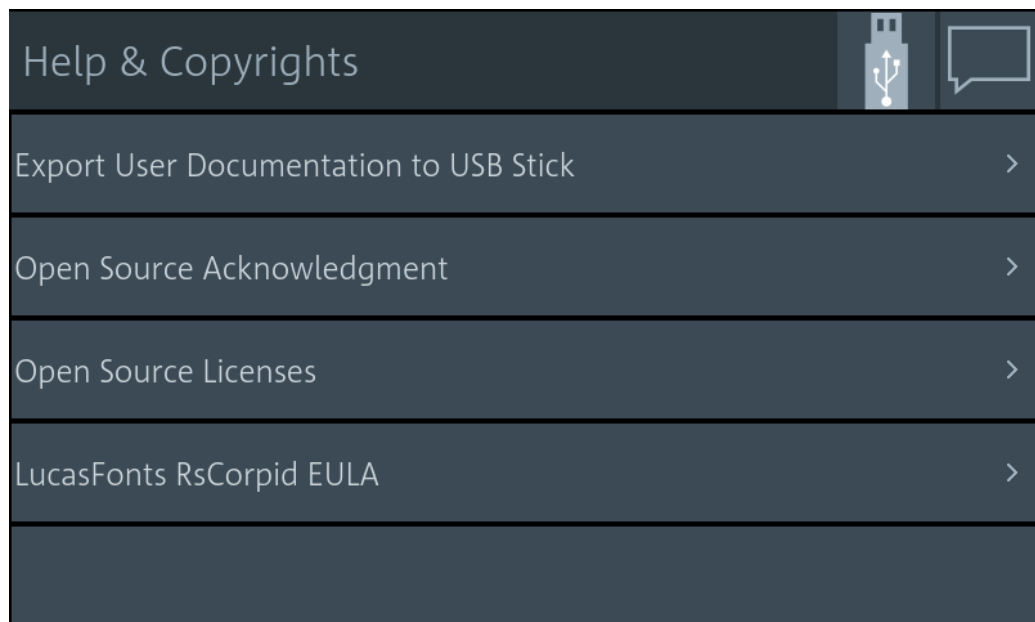

Export User Documentation to USB Stick	166
Open Source Acknowledgment	166
Open Source Licenses	166
LucasFonts RsCorpid EULA	166

Export User Documentation to USB Stick

Downloads the user manual to a connected USB stick. If no USB stick is connected, the file is saved to the volatile directory of the FTP directory. Information to the download is displayed in the "Notification Center". See also [Chapter 4.1.4, "Notification center"](#), on page 37.

Open Source Acknowledgement

Displays the open source acknowledgement.

Open Source Licenses

Displays the license texts of open source software packages used in the R&S NRX software. Under "Component", select the open source software package you want to display the license text of.

LucasFonts RsCorpid EULA

Displays the end-user license agreement (EULA) of LucasFonts.

10.3 Hardware configuration

Access: [System] > "Hardware Config"

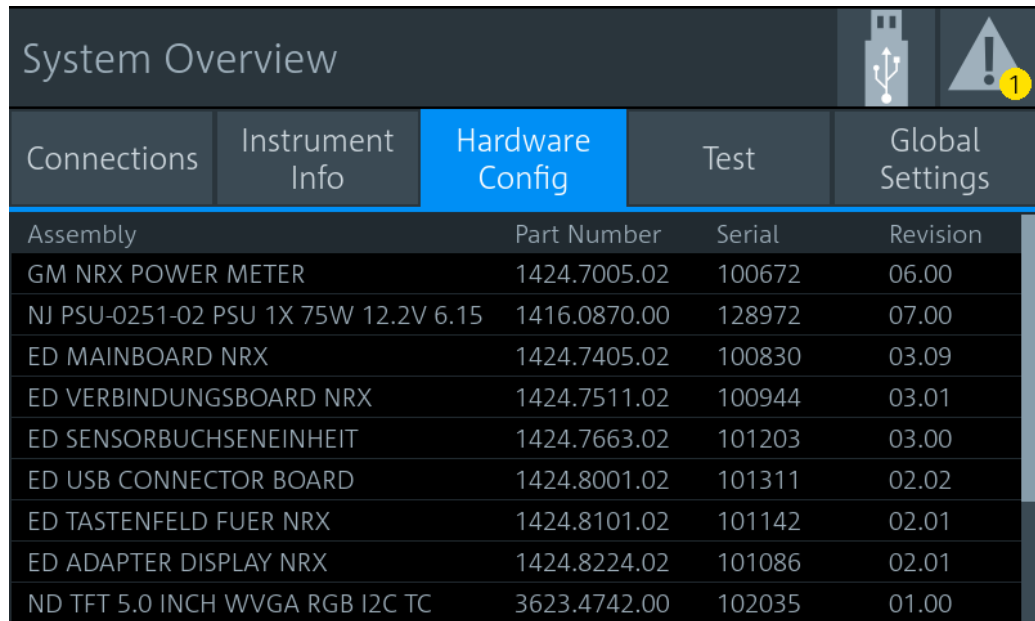

Assembly	Part Number	Serial	Revision
GM NRX POWER METER	1424.7005.02	100672	06.00
NJ PSU-0251-02 PSU 1X 75W 12.2V 6.15	1416.0870.00	128972	07.00
ED MAINBOARD NRX	1424.7405.02	100830	03.09
ED VERBUNDUNGSBOARD NRX	1424.7511.02	100944	03.01
ED SENSORBUCHSENEINHEIT	1424.7663.02	101203	03.00
ED USB CONNECTOR BOARD	1424.8001.02	101311	02.02
ED TASTENFELD FUER NRX	1424.8101.02	101142	02.01
ED ADAPTER DISPLAY NRX	1424.8224.02	101086	02.01
ND TFT 5.0 INCH WVGA RGB I2C TC	3623.4742.00	102035	01.00

Lists the hardware details of the R&S NRX assemblies. This tab can be useful for looking up the revision of hardware, for example when troubleshooting.

10.4 Test

Access: [System] > "Test"

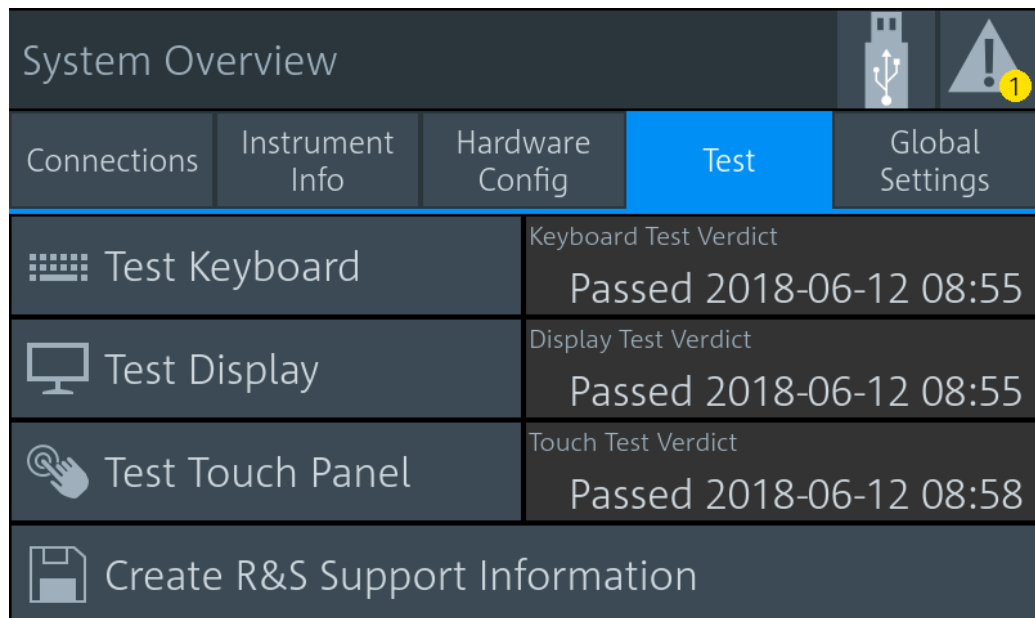

Test Item	Test Verdict
Test Keyboard	Passed 2018-06-12 08:55
Test Display	Passed 2018-06-12 08:55
Test Touch Panel	Passed 2018-06-12 08:58
Create R&S Support Information	

On this tab, you can test whether the user interfaces are in working order and create information useful for troubleshooting.

For testing a connected power sensor, see "[Sensor Test](#)" on page 153.

Testing the user interfaces

1. Tap the test you want to perform.

A dialog with detailed test instructions is displayed.

2. Read and follow the instructions.
3. Exit the test.

Note: "Exit with PASS" only becomes available when the test is finished successfully.

The results, passed or failed, are displayed for each test.

Remote command:

[TEST:DEVIce\[:ALL\]](#) on page 391

[TEST:DEVIce:RESult?](#) on page 391

Creating information for troubleshooting

You can save information for troubleshooting on a memory stick.

1. Connect a memory stick to one of the USB interfaces.
2. Tap "Create R&S Support Information".

The created archive file (*.tar.gz) contains the following information:

- Software errors
- Hardware status
- Current device footprint
- Current device settings

If a memory stick is connected, the archive file is saved there.

Alternatively, you can transfer the information using secure shell (SSH). See "[SSH](#)" on page 160.

Remote command:

[TEST:USB:STORage?](#) on page 391

10.5 Global settings

Access: [System] > "Global Settings"

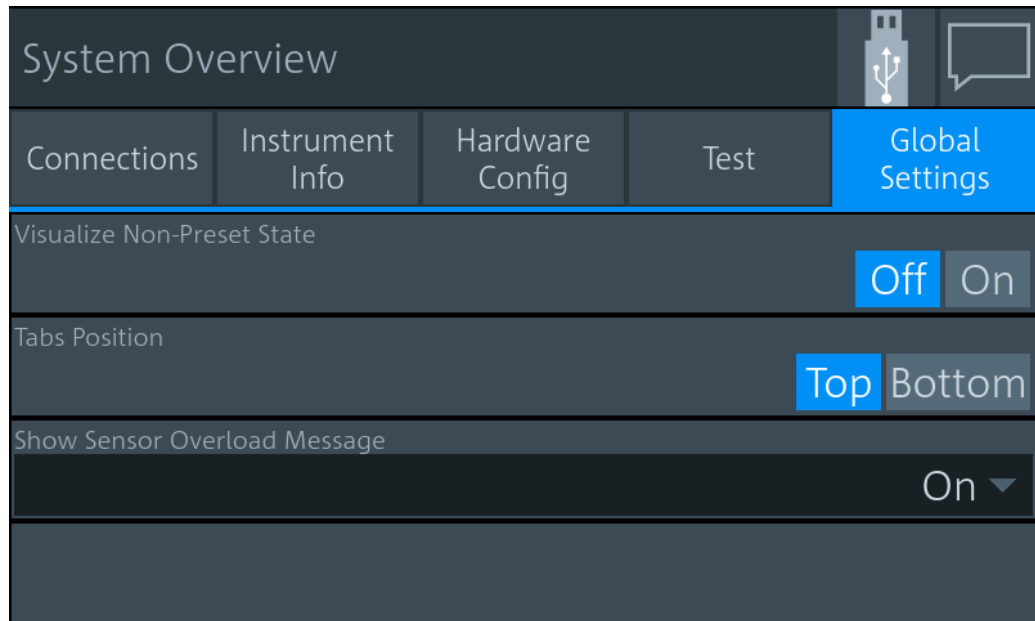

On this tab, you configure the following settings:

Visualize Non-Preset State	169
Tabs Position	169
Hide Sensor Overload Message	169

Visualize Non-Preset State

If enabled, a setting that differs from the preset value is indicated by a pencil symbol.



The control elements in the hierarchies above that are leading to this setting are marked, too. Thus, you can find the setting easily if you want to use a preset value.

Tabs Position

Specifies the position of the tabs in dialogs, top or bottom.

Hide Sensor Overload Message

If enabled, hides the sensor overload message. But be aware that overload can damage the power sensor, depending on the amount of power and the duration of the overload condition. The maximum power is specified in the data sheet of the power sensor.

Or you can query the maximum power using `SYSTEM:SENSOR<Sensor>:INFO?`.

Remote command:

`DISPlay:OVERload[:STATe]` on page 202

11 Option management

Optional features are available as options and are part of the firmware package. If you want to use an optional feature, you buy the option and, in return, receive a license key. Using the license key, you can activate the option as described in [Chapter 11.1, "Installing a license key"](#), on page 170.

You can also use the license key to deactivate the option but keep in mind that you cannot use the same license key to activate the option again. If you want to reactivate an option, contact the Rohde & Schwarz service center to request a new license key.

For detailed information on available options, see the data sheet or visit:

www.rohde-schwarz.com/brochure-datasheet/NRX

11.1 Installing a license key

Preparatory steps

1. Make sure that the most recent firmware version is installed.
2. Check the "License Keys List" whether the license you have purchased is unregistered. If the license is unregistered, you need to register it before installation. See "Supplement A" how to do that.

To install the license key

1. Select [System] > "Instrument Info" > "Options".
The "Options" dialog is displayed.
2. Select the "Manage License Keys" tab.
3. Select "Enter License Key".
The alphanumeric editor is displayed.
4. Enter the 30-digit license key from "License Keys List" or from the registration print-out, if the license was delivered unregistered.
5. Confirm your entry with the checkmark.
6. Switch the R&S NRX off and on again to reboot it.
7. Check whether the option is active:
 - a) Select [System] > "Instrument Info" > "Options".
 - b) Select the "SW Options" tab.
If the option is active, it is displayed in the list.

Further information:

- [Chapter 10.2.3, "Option settings"](#), on page 162

12 Firmware update

This chapter contains information on installing/updating the firmware on the R&S NRX.

The latest firmware update files are available on our Internet site at www.rohde-schwarz.com.

NOTICE

Potential damage to the firmware of the device

Disconnecting the power supply while an update is in progress can lead to missing or faulty firmware.

Special care must be taken on not disconnecting the power supply while the update is in progress. Interrupting the power supply during the firmware update will most likely lead to an unusable device which needs to be sent in for maintenance.

12.1 Firmware update via PC and USB or ethernet connection

This chapter contains information on installing/updating the firmware on the R&S NRX via PC and USB or Ethernet connection.

Use the Firmware Update program (PureFW) to load new firmware for the R&S NRX. It is part of the R&S NRP Toolkit.

12.1.1 Hardware and software requirements

The system requirements to perform a firmware update via PC are as follows:

- PC with free USB port (alternatively: PC and instrument are connected to an Ethernet network)
- USB cable (USB-A plug to USB-B plug) (alternatively: Ethernet cable)
- Operating system Microsoft Windows 7, Microsoft Windows 8 or Microsoft Windows 10
- **VISA software must be installed on your PC.**
- The R&S NRP Toolkit software must be installed on your PC (includes Firmware Update program).
- A Rohde & Schwarz update file (*.rsu) for the sensor must be available.

12.1.2 Preparing an update

To prepare an update via USB connection:

1. Make sure a recent VISA software is installed. Firmware update with PureFW can only be performed with the device recognized as a VISA device.
2. Make sure that the native language for the remote commands is set under:
 - [System] > "Connections" > "Remote" > **Emulations tab** (manual control)
 - **SYSTEM: LANGuage** on page 408 (remote control)
3. Connect the R&S NRX to the PC using a USB cable. If the instrument is off, switch it on.
 Shortly afterwards, the PC should have identified the new USB hardware in case the instrument is connected via USB.
 If no recent VISA software is installed, Windows will try in vain to find a USB driver for the instrument. If this happens, the instrument is highlighted by a yellow exclamation mark in the Windows device manager.
 → Abort the installation process and install a recent VISA software.

To prepare an update via network connection:

1. Make sure a recent VISA software is installed. Firmware update with PureFW can only be performed with the device recognized as a VISA device.
2. Connect the R&S NRX to the network. If the instrument is off, switch it on.
 To check that the instrument is assigned an IP address, press the hardkey [System] on the front of the R&S NRX, choose the "Connections" tab, and check the IPv4 status under "Network":

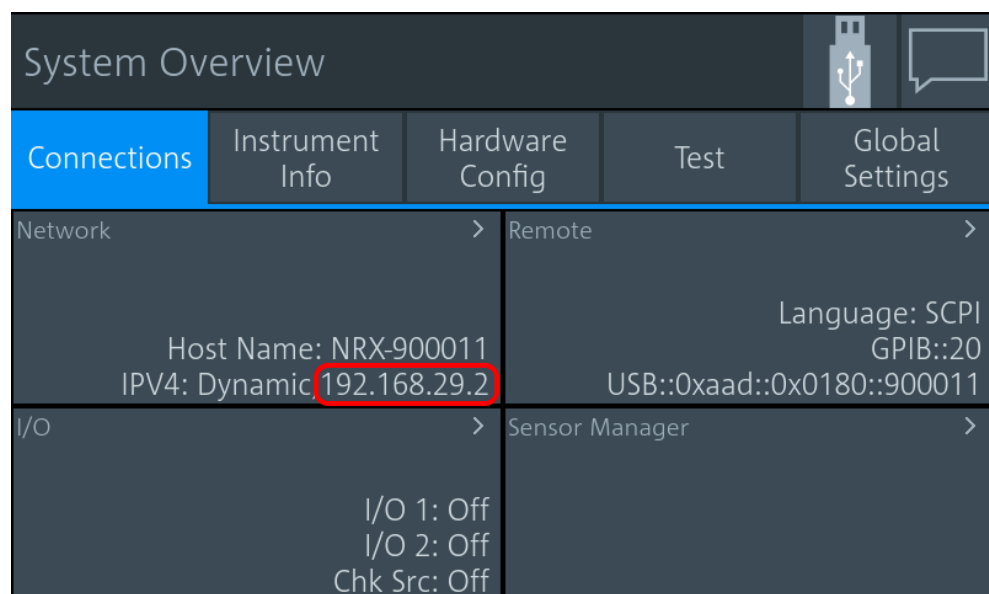

If the instrument is not assigned an IP address, perform the following:

- a) Open the dialog "Network" and check whether the network settings are correct.

- b) Check the cable used to connect the instrument to the network.
3. Register the instrument as a VISA device. Refer to documentation of your VISA software for details.

12.1.3 Updating the application firmware

To perform a firmware update:

1. Start the Firmware Update program (PureFW) via "Start menu > NRP-Toolkit > Firmware Update". The following window should appear:

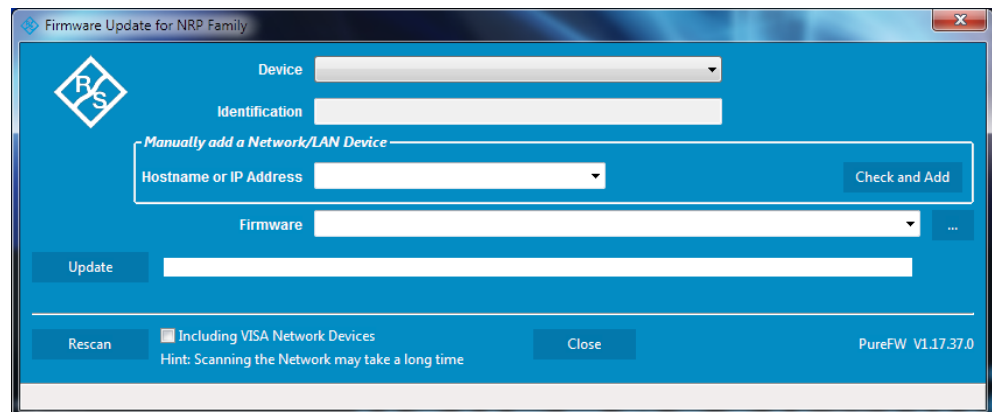

The program automatically starts scanning for R&S power sensors and meters attached via USB. When the scan is completed, all recognized power sensors and meters are listed in the "Device" dropdown control.

2. If the instrument you want to update is not listed in the "Device" dropdown control, perform one of the following:
 - a) If the instrument is connected to the PC via USB, press "Rescan" to search for R&S power sensors and meters attached via USB.

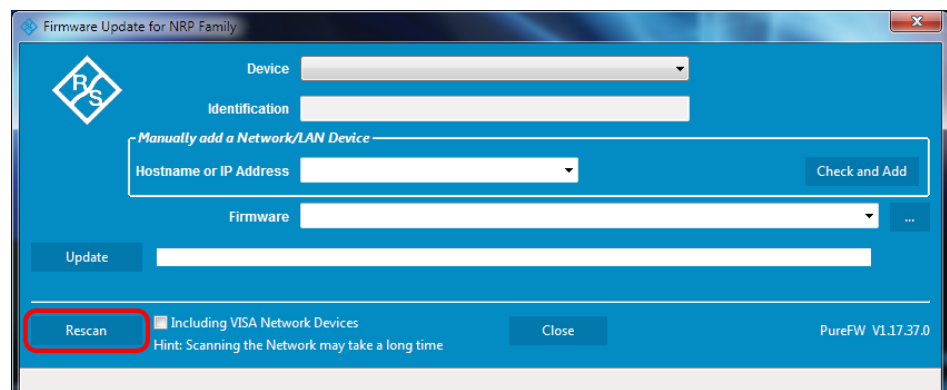

Firmware update via PC and USB or ethernet connection

- b) If the instrument is connected to the network, enter the hostname or the IP address of the instrument in the field "Manually add a Raw SCPI Device" and then press "Check and Add" or **Enter**.

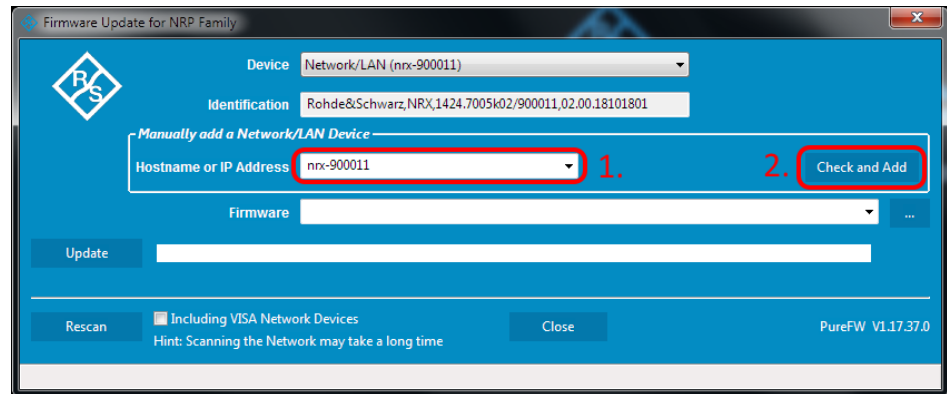

The program searches for the specified instrument on the network and adds it to the "Device" list.

- c) It is also possible to scan the local network for VISA network devices automatically. This can be more time-consuming than adding the device manually as described above. To do this, check the setting "Including VISA Network Devices" before you press "Rescan".

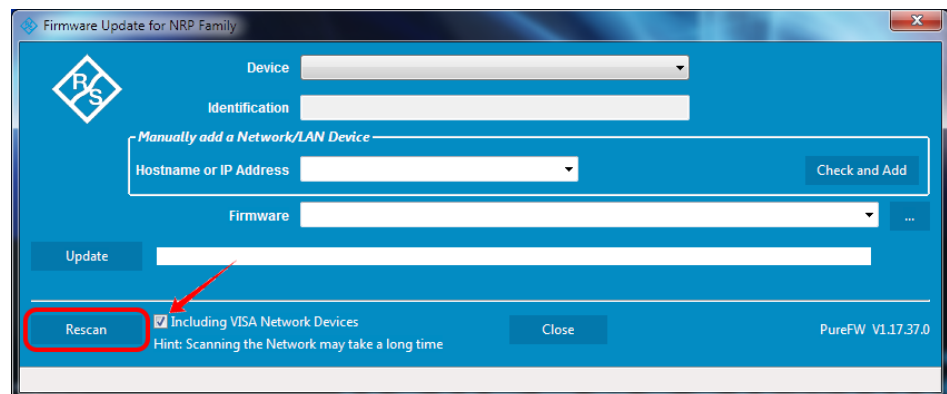

- d) Check whether a VISA library is installed on the computer.
 If no VISA library is installed on the computer, no VISA instrument will be accessible.
 If a network connection is used: Check whether the instrument is registered as a VISA device.
3. In the "Device" line select the instrument you want to update.

Firmware update via PC and USB or ethernet connection

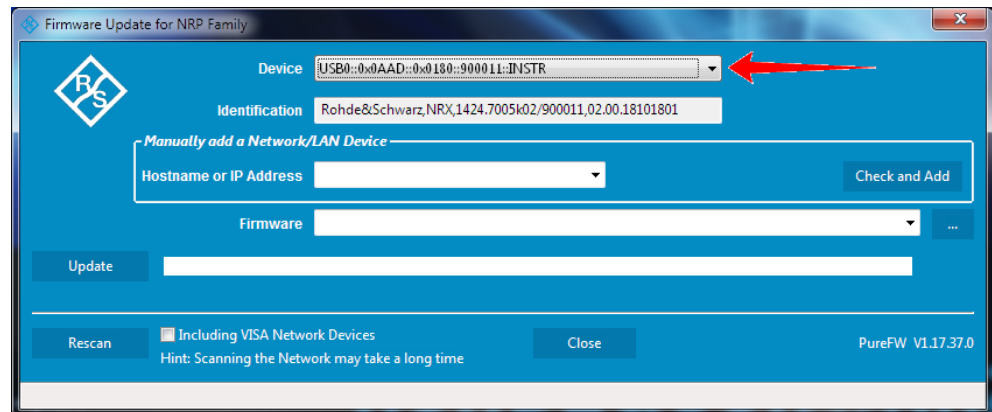

The "Hostname or IP Address" field is not used during this procedure and should therefore be left empty.

- In the "Firmware" field enter the full path and file name of the update file or press the ellipsis button to browse the file system for it. New firmware for the R&S NRX generally has an *.rsu (Rohde & Schwarz Update) extension.

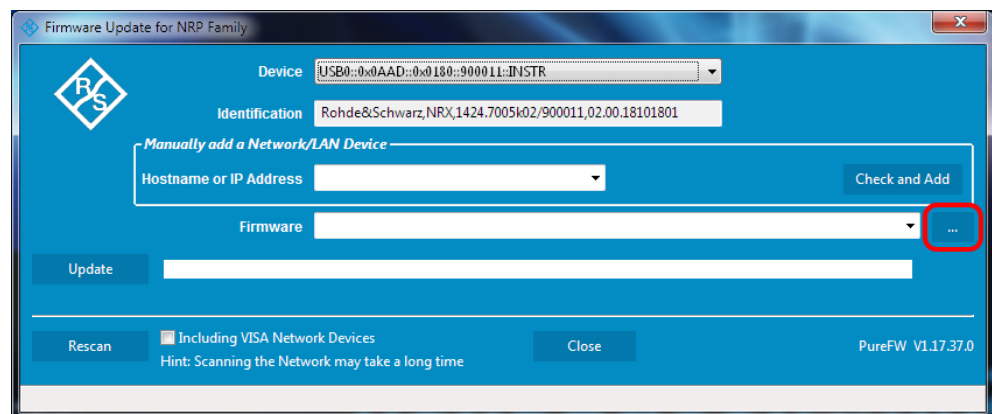

- Select "Update" to download the new firmware and program it into the flash memory of the instrument.

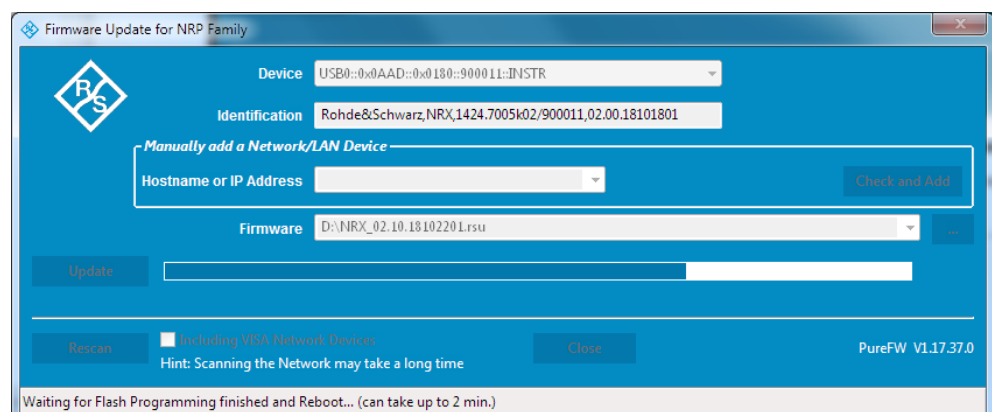

During the update process the progress is shown through a progress bar. The update sequence may take a couple of minutes.

6. Check if the update was successful. This is the case if the firmware version in the "Identification" field is the same as the one you loaded in the "Firmware" field.

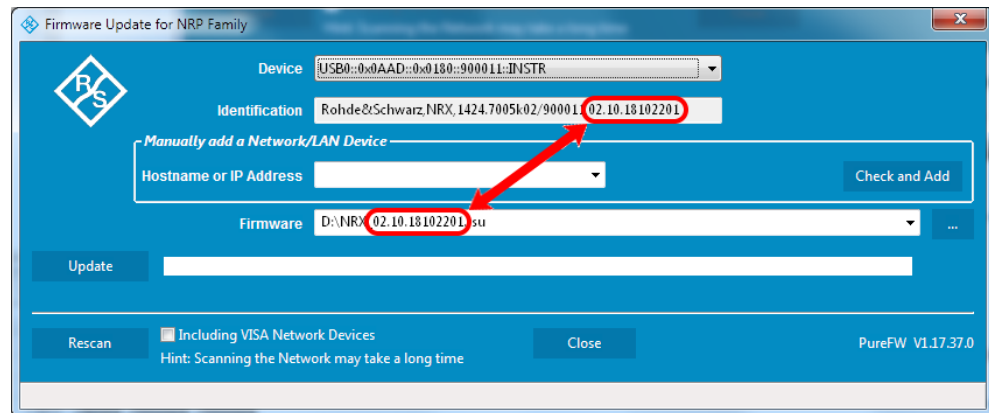

12.2 Firmware update via a USB flash memory stick

This chapter contains information on installing/updating the firmware on the R&S NRX via a USB flash memory stick.

12.2.1 Hardware and software requirements

The system requirements to perform a firmware update via a USB flash memory stick are as follows:

- PC or mobile device with free USB port running any operating system and software that supports copying files to the USB flash memory stick
- USB flash memory stick (USB 2.0 or 3.0, with USB-A plug, FAT32 file system, and sufficient space for the firmware file)
- A Rohde & Schwarz update file (*.rsu) for the sensor must be available.

12.2.2 Preparing an update

To prepare an update via USB flash memory stick:

1. Make sure that the native language for the remote commands is set under:
 - [System] > "Connections" > "Remote" > [Emulations tab](#) (manual control)
 - [SYSTEM: LANGuage](#) on page 408 (remote control)
2. Copy the Rohde & Schwarz update file to the root directory of the USB flash memory stick.
3. Disconnect the USB flash memory stick from the PC or mobile device. If the instrument is off, switch it on.

12.2.3 Updating the application firmware

To perform a firmware update:

1. Connect the USB flash memory stick to the front or rear USB host port of the R&S NRX.

Shortly afterwards, the instrument should have identified the USB flash memory stick. A dialog will appear that allows selection of the Rohde & Schwarz update file (if there is more than one that matches the instrument) and asks for confirmation to start the update.

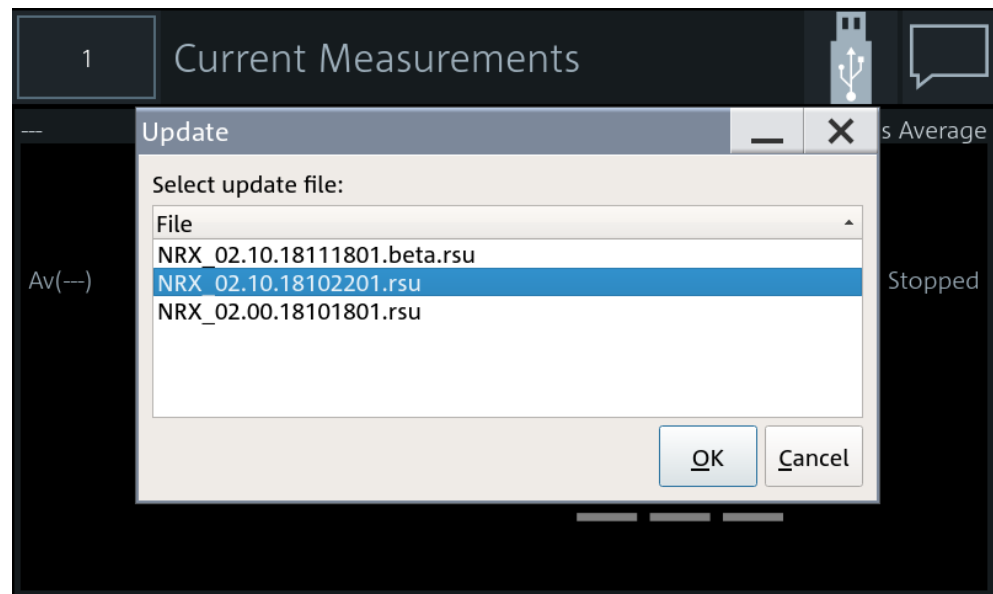

2. If there are more than one matching Rohde & Schwarz update files, select the file you want to use for the update. The latest version is on top. Then, press "Update" to start the update process.
3. After copying the Rohde & Schwarz update file to internal memory, a dialog will appear that asks you to remove the installation medium (USB flash memory stick) and press "OK" to reboot the instrument. Remove the stick and confirm with "OK". (If the stick is not removed at this point of the update process, the firmware update process will start another time after the reboot. In this case, interrupt it by pressing "Cancel" when the selection dialog appears.)

13 Remote control commands

13.1 Conventions used in SCPI command descriptions

The following conventions are used in the remote command descriptions:

- **Command usage**
If not specified otherwise, commands can be used both for setting and for querying parameters.
If a command can be used for setting or querying only, or if it initiates an event, the usage is stated explicitly.
- **Parameter usage**
If not specified otherwise, a parameter can be used to set a value and it is the result of a query.
Parameters required only for setting are indicated as **Setting parameters**.
Parameters required only to refine a query are indicated as **Query parameters**.
Parameters that are only returned as the result of a query are indicated as **Return values**.
- **Conformity**
Commands that are taken from the SCPI standard are indicated as **SCPI confirmed**. All commands used by the R&S NRX follow the SCPI syntax rules.
- **Asynchronous commands**
A command which does not automatically finish executing before the next command starts executing (overlapping command) is indicated as an **Asynchronous command**.
- **Reset values (*RST)**
Default parameter values that are used directly after resetting the instrument (*RST command) are indicated as ***RST** values, if available.
- **Default unit**
The default unit is used for numeric values if no other unit is provided with the parameter.

The standard behavior for default units applies to all values that are expressed in a certain unit. Values that can be expressed in more than one unit, show a more complex behavior that is described in [Chapter 13.6.1.3, "Units"](#), on page 217.

For further information on units, see also ["Units"](#) on page 471.

13.2 Common commands

The common commands are taken from the IEEE 488.2 (IEC 625–2) standard. The headers of these commands consist of an asterisk * followed by three letters.

&ABO	179
&DFC	179
&GET	180

>L.....	180
>M.....	180
>R.....	180
&HFC.....	180
&LLO.....	180
&NREN.....	180
*CLS.....	180
*DEV.....	181
*DMC.....	181
*EMC.....	181
*ESE.....	181
*ESR?.....	181
*GCLS.....	182
*GMC?.....	182
*GOPC?.....	182
*GWAI.....	182
*IDN?.....	182
*IST?.....	182
*LMC?.....	183
*OPC.....	183
*OPT?.....	183
*PMC.....	183
*PRE.....	183
*PSC.....	184
*RCL.....	184
*RMC.....	184
*RST.....	184
*SAV.....	184
*SRE.....	185
*SRQ?.....	185
*STB?.....	185
*TRG.....	185
*TST?.....	185
*WAI.....	186
*XESE.....	186
*XESR?.....	186
*XPRES.....	186
*XSRE.....	186
*XSTB?.....	187

&ABO

Device clear

Usage: Event

&DFC

Disable flow control

Usage: Event

&GET

Group execute trigger

Usage: Event

>L

Go to local

Usage: Event

>M

Go to local with remote state

Usage: Event

>R

Go to remote

Usage: Event

&HFC

Hardware flow control

Usage: Event

&LLO

Local lockout

Usage: Event

&NREN

Not remote enabled (go to local)

Usage: Event

***CLS**

Clear status, resets the following:

- Status byte (STB)
- Standard event register (ESR)

- EVENT part of the QUESTIONABLE and the OPERATION register
- Error/event queue

The command does not change the ENABLE and TRANSITION parts of the registers.

Usage: Event

***DEV** [<instrument_no>]

Fixed value.

Parameters:

<instrument_no> 0

***DMC** <Label>, <Macro>

***DMC?** <Label>

Defines a macro command.

Parameters:

<Macro>

Parameters for setting and query:

<Label>

***EMC** <Enable>

Enables macro command.

Parameters:

<Enable>

***ESE** <register>

Event status enable

Sets the event status enable register to the specified value. The query returns the contents of the event status enable register in decimal form.

Parameters:

<register>	Range:	0 to 255
	*RST:	0

***ESR?**

Event status read

Returns the contents of the event status register in decimal form (0 to 255) and subsequently sets the register to zero.

Usage: Query only

***GCLS**

Clears all status information in all internal "instruments".

Usage: Event

***GMC? <Label>**

Get macro content.

Query parameters:

<Label>

Return values:

<Macro> <dblock>

Usage: Query only

***GOPC?**

Analogue of *OPC? for all instruments in multichannel device.

Return values:

<gopc> "1" is return if all pending operations in all internal "instruments" are finished.

Usage: Query only

***GWAI**

Waits for all pending operations in all internal "instruments".

Usage: Event

***IDN?**

Identification

Returns a string with information on the sensor's identity (device identification code). In addition, the version number of the installed firmware is indicated.

Usage: Query only

***IST?**

Individual status

Returns the current value of the IST flag in decimal form. The IST flag is the status bit which is sent during a parallel poll.

Usage: Query only

***LMC?**

List macro commands.

Return values:

<Label>

Usage: Query only

***OPC**

Operation complete

Sets bit 0 in the event status register when all preceding commands have been executed. Send this command at the end of a program message. It is important that the read timeout is set sufficiently long.

The query always returns 1 because the query waits until all previous commands are executed.

*OPC? basically functions like *WAI, but also returns a response. The response is an advantage, because you can query the execution of commands from a controller program before sending new commands. Thus preventing overflow of the input queue when too many commands are sent that cannot be executed.

***OPT?**

Option identification

Returns a comma-separated list of installed options.

Usage: Query only

Manual operation: See "HW Options tab" on page 162
See "SW Options tab" on page 162

***PMC**

Purge macro command.

Usage: Event

***PRE <register>**

Parallel poll register enable

Sets the parallel poll enable register to the specified value or queries the current value.

Parameters:

<register> Range: 0 to 255
 *RST: 0

***PSC** <psc>

Writes/reads the power on status clear flag (PSC).

Parameters:

<psc> Power on status clear flag.

***RCL** <num>

ReCaLI

Recalls the instrument settings from the specified intermediate memory.

Setting parameters:

<number> Number of the intermediate memory
Range: 0 to 19
*RST: 0

Usage: Setting only

Manual operation: See "[Recall](#)" on page 135

***RMC** <Label>

Remove macro content.

Setting parameters:

<Label>

Usage: Setting only

***RST**

Sets the instrument to a defined initial state, a so-called reset. The default settings are indicated in the description of commands as *RST value.

With the exceptions listed in [Table 13-17](#), this command corresponds to [SYSTEM:PRESet](#).

Usage: Event

Manual operation: See "[Preset](#)" on page 135

***SAV** <num>

SAVe

Saves the current instrument settings in the specified intermediate memory.

Setting parameters:

<number> Number of the intermediate memory
Range: 0 to 19
*RST: 0

Usage: Setting only

Manual operation: See "Save" on page 135

***SRE** <register>

Service request enable

Sets the service request enable register to the specified value. This command determines under which conditions a service request is triggered.

Parameters:

<register>	Range:	0 to 255
	*RST:	0

***SRQ?** [<timeout>]

A generic `srq wait` command to be used without `srq event transport`. It is simply read from the interface.

Query parameters:

<timeout>

Return values:

<srq>

Usage: Query only

***STB?**

Status byte

Returns the contents of the status byte in decimal form.

Usage: Query only

***TRG**

Trigger

Triggers a measurement if the following conditions are met:

- Power sensor is in the waiting for trigger state.
- Trigger source is set to BUS.

See [TRIGger<Measurement>\[:CHANnel<Channel>\]:SOURce](#) on page 237

Usage: Event

***TST?**

Self-test

Triggers a self-test of the R&S NRX and outputs the result. 0 indicates that no errors have occurred.

Usage: Query only

***WAI**

Wait to continue

Prevents the execution of the subsequent commands until all preceding commands have been executed and all signals have settled.

Usage: Event

***XESE <xese>**

Specifies the standard event status enable register (ESE). This register determines which events from the standard event status register (ESR) are summarized in bit 5 (the event summary bit ESB) of the status byte.

Parameters:

<xese> <expr>

***XESR?**

Reads and clears the standard event status register (ESR).

Return values:

<xesr> <expr>

Usage: Query only

***XPRES <xpre>**

Reads or writes the parallel pll enable register (PRE).

Parameters:

<xpre> <expr>

Parallel poll enable register.

***XSRES <xsre>**

Reads or writes the service request enable register. Used to enable service requests.

Parameters:

<xsre> <expr>

Service request enable register (SRE).

Example:

For calculating the standing wave ratio (SWR), you use `CALC1:MATH:EXPR`
`"SWR(SEN3,SEN1)"`.

Thus, the power sensor at port C from the example above is assigned as primary sensor, and the power sensor at port A as secondary sensor.

This behavior saves you assigning the power sensors using
`CALCulate<Measurement>[:CHANnel<Channel>]:SENSe:INDeX`.

Further information:

- ["Primary Sensor, Secondary Sensor"](#) on page 70
- ["Channel Calculation Function"](#) on page 70
- Assigning measurement panes and traces, see [Chapter 13.6, "Measurement settings and results"](#), on page 196.

13.4 Making measurements

Combining commands, also called high-level commands, simplify programming of the R&S NRX for measurements. You can configure the parameters that are part of the parameter list. The other parameters are set to their default values. For details on the command syntax, see [Chapter 13.4.5, "Structure of combining commands"](#), on page 191.

If you need more precise control of the R&S NRX, you can use the commands that configure only one setting, here called lower-level commands, or combining commands that include fewer functions. This way allows you to make specific modifications between the individual steps and configure parameters that are not part of the parameter list. [Figure 13-1](#) shows the relationship of the commands.



Figure 13-1: Relationship

13.4.1 Using MEASure?

The simplest way to program the R&S NRX for measurements is by using `MEASure?`. But this method does not offer much flexibility. You can configure the parameters that are part of the parameter list but nothing else; see also ["<parameter_list>"](#) on page 191.

When you send a `MEASure?` query, the R&S NRX performs the following steps:

1. Configures according to the parameter list.
2. Starts a measurement.
3. Returns the result.

Thus, this command combines `CONFigure` and `READ?`. To make more flexible and accurate measurements, use the `CONFigure` commands. See [Chapter 13.4.2, "Using CONFigure and READ?"](#), on page 189.

Example: Measuring average power with one power sensor

You can set the expected power level, resolution and calculation function, and select the power sensor you want to address, all in one command.

```
MEAS1? -50, 3, (@1)
```

- `MEAS1` specifies the continuous average measurement
- `-50` optimizes the power sensor settings, if applicable
- `3` specifies resolution setting; 0.01
- `(@1)` specifies the power sensor; connected to port A

Querying the parameters transferred previously

```
MEAS1?
```

Returns the parameters that were transferred for measurement 1 the last time.

13.4.2 Using CONFigure and READ?

When you send the `CONFigure` commands, the R&S NRX performs [step 1](#) of the `MEASure?` queries, but does not start the measurement automatically. Thus, you can change the measurement parameters before making measurements.

For [steps 2](#) and [step 3](#), you use the `READ?` queries. They compare the parameter list to the current settings, start a measurement and return the result. If the parameter list does not match, a SCPI error is returned, and the command is aborted.

Example: Measuring average power with one power sensor

```
CONF1 -50, 3, (@1)
```

- CONF1 specifies the continuous average measurement
- -50 optimizes the power sensor settings, if applicable
- 3 specifies resolution setting; 0.01
- (@1) specifies the power sensor; connected to port A

```
FREQ 0.5e9
```

- Sets the carrier frequency of the applied signal as 0.5 GHz. The combining commands do not set the frequency or check its setting.

```
READ1?
```

- Starts a measurement and returns the measured value without checking the current settings.
If you want to have the current settings checked before the measurement, use `READ1? -50, 3, (@1)` instead. But this check only includes the settings made by the combining commands. Other settings, like the frequency setting, are not included.

Querying the parameters transferred previously

```
CONF1?
```

Returns the parameters that were transferred for measurement 1 the last time.

13.4.3 Using CONFigure, INITiate and FETCh?

Instead of the `READ?` queries, you can use the `INITiate` commands and the `FETCh?` queries.

For step [step 2](#), use the `INITiate` commands. See also [Chapter 13.5, "Starting and ending a measurement"](#), on page 193.

For step [step 3](#), use the `FETCh?` queries.

Querying the current measured value

```
FETCh?
```

Returns the current measured value if it is valid. If a measured value is not yet available, processing is suspended until a valid result is available.

13.4.4 Configuring one setting at a time

The lower-level commands give you more precise control of the R&S NRX. You can use them together with combining commands for fine-tuning, as shown in [Example "Measuring average power with one power sensor"](#) on page 190, or configure all settings individually.

13.4.5 Structure of combining commands

SCPI commands consist of a so-called header and, usually, one or more parameters, see also [Chapter 14.2, "SCPI command structure"](#), on page 468. The header of combining commands consists of:

```
<subsystem><meas_type>[<calc_function>][?]
```

The header is followed by the parameter list, so that the following syntax results:

```
<subsystem><meas_type>[<calc_function>][?] <parameter_list>
```

<subsystem>

The header starts with the subsystem, also called root-level command. The subsystems of combining commands are:

- CONFigure<Measurement>
- FETCh<Measurement>
- READ<Measurement>
- MEASure<Measurement>

The <Measurement> suffix selects the measurement, see also [Chapter 13.6, "Measurement settings and results"](#), on page 196.

<meas_type>

This mnemonic selects the measurement type. For example, [:SCALar] [:POWer] [:AVG] selects the continuous average measurement.

<calc_function>

This mnemonic is optional and selects the calculation function. The lower-level command for calculation functions is [CALCulate<Measurement>:MATH\[:EXPRession\]](#) on page 328. If the calculation function is not specified, the measured value of the primary channel is output.

<parameter_list>

The parameter list differs from measurement type to measurement type. Combining commands of the same measurement type have the same parameter list.

Parameters in square brackets can be omitted. If omitted, they are kept unchanged. If you want to make sure that the default values of these parameters are used, perform a reset ([*RST](#)) before sending the high-level command.

Table 13-1: Alphabetical parameter overview

Parameter	Description
<buffered_size>	Mandatory. Number of requested measured values. Corresponds to [SENSe<Sensor>:] [POWer:] [AVG:]BUFFer:SIZE .
<capture_time>	Mandatory. Period within which measured data are captured in the trace measurements. Corresponds to [SENSe<Sensor>:] TRACe:TIME on page 216.

Parameter	Description
<dtolerance>	Mandatory. Length of a time interval during that the power level can drop below the trigger level without being interpreted as end of the power pulse. Corresponds to <code>[SENSe<Sensor>:] [POWer:] BURSt:DTOLerance</code> .
<end_exclude>	Mandatory. Amount of time at the end of a timeslot or integration period that is not evaluated. Corresponds to <code>[SENSe<Sensor>:] TIMing:EXCLude:STOP</code> .
<expected_value>	Optional. Value that is expected for the measurement.
<no_slots>	Mandatory. Number of timeslots to be measured. Corresponds to <code>[SENSe<Sensor>:] [POWer:] TSLot[:AVG]:COUNT</code> on page 447.
<resolution>	Optional. Limit up to which the measurement result probably is free of noise. Corresponds to <code>[SENSe<Sensor>:] AVERage:COUNT:AUTO:RESolution</code> .
<scope_size>	Mandatory. Number of test points on the time axis. Corresponds to <code>[SENSe<Sensor>:] TRACe:POINts</code> on page 462.
<source_list>	Mandatory. Primary and secondary sensor. The number for each sensor is preceded by the character @. The entire expression is enclosed in parentheses. Example: <code>(@3),(@2)</code> Sensor C is the primary sensor, and sensor B is the secondary sensor.
<start_exclude>	Mandatory. Amount of time at the beginning of a timeslot or integration period that is not evaluated. Corresponds to <code>[SENSe<Sensor>:] TIMing:EXCLude:START</code> .
<statistics_size>	Mandatory. Number of test points on the time axis. Corresponds to <code>[SENSe<Sensor>:] STATistics:SCALE:X:POINts</code> on page 452.
<tslot_width>	Mandatory. Width of a timeslot. Corresponds to <code>[SENSe<Sensor>:] [POWer:] TSLot[:AVG]:WIDTh</code> on page 447.

Further information

- [Chapter 13.6.6.1, "Combining commands for continuous average measurements"](#), on page 245
- [Chapter 13.6.6.2, "Combining continuous average commands with buffering"](#), on page 252
- [Chapter 13.6.8.1, "Combining commands for trace measurements"](#), on page 269
- [Chapter 13.6.7, "Burst average measurements"](#), on page 260
- [Chapter 13.6.11.1, "Combining commands for timeslot measurements"](#), on page 297
- [Chapter 13.6.12.1, "Combining commands for statistics measurements"](#), on page 309

13.5 Starting and ending a measurement

In a basic scenario, the measurement is started immediately after the measurement mode is enabled.

If you want to start the measurement only if a specific condition is fulfilled, define a trigger.

Further information:

- [Chapter 6.1.3, "Triggering"](#), on page 63
- [Chapter 13.6.2, "Configuring the trigger"](#), on page 229

ABORt<Measurement>	193
ABORt<undef>:ALL	193
INITiate<Measurement>:CONTInuous	194
INITiate<Undef>:ALL:CONTInuous	194
INITiate<Measurement>:DISable	194
INITiate<Undef>:ALL:DISable	195
INITiate<Measurement>[:IMMediate]	195
INITiate<Undef>:ALL[:IMMediate]	196

ABORt<Measurement>

Immediately interrupts the current measurement. If the measurement has been started as a single measurement ([INITiate<Measurement>\[:IMMediate\]](#)), the power sensor goes into the idle state. However, if a continuous measurement is in progress ([INITiate<Measurement>:CONTInuous ON](#)), the trigger system of the power sensor enters the waiting for trigger state, and if the trigger condition is met, a new measurement is immediately started.

The command is not fully R&S NRP2 compatible. If port 1 is assigned to measurement 1 and so on, the command works. If port 1 is assigned to measurement 2, for example, enable the R&S NRP2 emulation using [SYSTem:LANGuage "NRP2"](#).

Suffix:

<Measurement> 1 to 8
Measurement

Usage: Event

ABORt<undef>:ALL

Applies to all connected power sensors. See [ABORt<Measurement>](#) on page 193.

Suffix:

<undef> 1 to n
No suffix required.

Usage: Event

INITiate<Measurement>:CONTInuous <state>

Enables or disables the continuous measurement mode. In continuous measurement mode, the power sensor does not go into the idle state after a measurement has been completed, but immediately executes another measurement cycle.

The command is not fully R&S NRP2 compatible. If port 1 is assigned to measurement 1 and so on, the command works. If port 1 is assigned to measurement 2, for example, enable the R&S NRP2 emulation using `SYSTem:LANGuage "NRP2"`.

Suffix:

<Measurement> 1 to 8
Measurement

Parameters:

<state> If you use `SYSTem:PRESet` instead of `*RST`, the RST value differs. See [Table 13-17](#).

ON

Measurements are performed continuously. If a measurement is completed, the power sensor does not return to the idle state but enters the waiting for trigger state again.

OFF

Ends the continuous measurement mode, and sets the power sensor to the idle state.

*RST: 0

INITiate<Undef>:ALL:CONTInuous <state>

Applies to all connected power sensors. See [INITiate<Measurement>:CONTInuous](#) on page 194.

Suffix:

<Undef> 1 to n
No suffix required.

Setting parameters:

<state> *RST: 0

Usage: Setting only

INITiate<Measurement>:DISable <state>

Prevents the execution of `INITiate<Measurement>[:IMMediate]`. Thus you can prevent that the specified power sensor starts a measurement if `INITiate<Undef>:ALL[:IMMediate]` is used.

The command is not fully R&S NRP2 compatible. If port 1 is assigned to measurement 1 and so on, the command works. If port 1 is assigned to measurement 2, for example, enable the R&S NRP2 emulation using `SYSTem:LANGuage "NRP2"`.

Suffix:
 <Measurement> 1 to 8
 Measurement

Parameters:
 <state> *RST: 0

INITiate<Undef>:ALL:DISable <state>

Applies to all connected power sensors. See [INITiate<Measurement>:DISable](#) on page 194.

Suffix:
 <Undef> 1 to n
 No suffix required.

Setting parameters:
 <state>

Usage: Setting only

INITiate<Measurement>[:IMMEDIATE]

Starts a single measurement cycle. The power sensor changes from the idle state to the waiting for trigger state. As soon as the trigger condition is fulfilled, the sensor begins the measurement. Depending on the number of trigger events that are required, e.g. for averaging, the power sensor enters the waiting for trigger state several times. Once the entire measurement is completed, a measurement result is available, and the power sensor enters the idle state again.

Use the command only after the continuous measurement mode has been disabled using [INITiate<Measurement>:CONTinuous OFF](#).

The command is not fully R&S NRP2 compatible. If port 1 is assigned to measurement 1 and so on, the command works. If port 1 is assigned to measurement 2, for example, enable the R&S NRP2 emulation using [SYSTem:LANGuage "NRP2"](#).

Suffix:
 <Measurement> 1 to 8
 Measurement

Example: If you work in a sender/receiver setup, you need to trigger the receiver before triggering the sender. To prevent overlapping execution, use *WAI, see also [Chapter 14.3, "Command sequence and synchronization"](#), on page 475. In this example, sensor 2 is the receiver, sensor 1 is the sender:

```
INIT2
*WAI
INIT1
```

Usage: Event

INITiate<Undef>:ALL[:IMMEDIATE]

Applies to all connected power sensors. See [INITiate<Measurement>\[:IMMEDIATE\]](#) on page 195.

Suffix:

<Undef> 1 to n
 No suffix required.

Usage: Event

13.6 Measurement settings and results

The R&S NRX supports up to 4 measurement channels. The number of different measurement results depends on the type of measurement.

If a measurement type provides single measured values, each measurement channel has 1 measurement, adding up to 4 different measurement results.

If a measurement type provides measured values as measurement sequence or function, each measurement channel has 2 separate measurements presented as traces, adding up to 8 different measurement results.

The measurement results are configured using the commands of the `CALCulate<Measurement>` subsystem.

Table 13-2: Assigned measurement panes and traces

Measurement suffix	Assigned measurement panes	Max. number of different measurement results	Supported by
<code>CALCulate<Measurement></code>	<code>WINDow<Window></code>		
<code>CALC1 to CALC4</code>	<code>WIND1 to WIND4</code>	4, see Figure 13-2	all measurements
<code>CALC5 to CALC8</code>	<code>WIND1 to WIND4</code>	8, see Figure 13-3	trace, pulse analysis, statistics measurements only

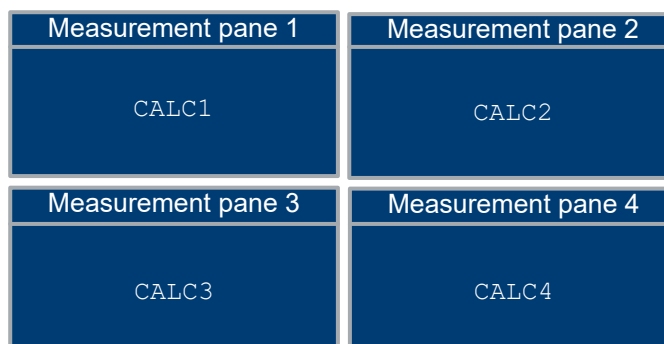

Figure 13-2: Measurement types supporting 4 different measurement results

Measurement pane 1		Measurement pane 2	
Trace 1 CALC1	Trace 2 CALC5	Trace 1 CALC2	Trace 2 CALC6
Measurement pane 3		Measurement pane 4	
Trace 1 CALC3	Trace 2 CALC7	Trace 1 CALC4	Trace 2 CALC8

Figure 13-3: Measurement types supporting 8 different measurement results

Only for measurement functions that support two power sensors, you can define two sensor configurations in parallel, a primary and a secondary sensor configuration. But these separate configurations are rarely necessary.

Further information:

- [Chapter 5.1, "Parallel measurements"](#), on page 46
- [Chapter 13.7, "Calculation functions"](#), on page 328

13.6.1 Configuring display and results

Further information:

- [Chapter 6.1.1, "Display settings"](#), on page 52

13.6.1.1 General settings

CALCulate<Measurement>:AVALue.....	198
CALCulate<Measurement>:DMODE.....	198
CALCulate<Measurement>:EXTRemes:RESet.....	199
CALCulate<Measurement>:HOLD:FUNctIon.....	199
CALCulate<Measurement>:HOLD[:STATe].....	199
CALCulate<Measurement>:LIMit<undef>:TYPE.....	200
CALCulate<Measurement>:LIMit<undef>[:STATe].....	200
CALCulate<Measurement>:RESolution.....	200
DISPlay:BRIGthness.....	201
DISPlay:ERRorlist.....	201
DISPlay:LAYout.....	201
DISPlay:MESSage:TEXT:CLEar.....	201
DISPlay:MESSage:TEXT[:DATA].....	201
DISPlay:MESSage:TYPE.....	202
DISPlay:MESSage[:STATe].....	202
DISPlay:OVERload[:STATe].....	202
DISPlay:PIXMap?.....	203
DISPlay:UPDate.....	203

DISPlay[:WINDow<Window>][:STATe].....	203
DISPlay[:WINDow<Window>]:POSition.....	203
SYSTem:SPEed.....	204

CALCulate<Measurement>:AVALue <value>

Determines which additional information about the measured values is shown in the display.

Suffix:

<Measurement> 1 to 8
Measurement

Parameters:

<value> NONE | EXTRemes | STATistics
*RST: NONE

Manual operation: See "[Auxiliary Values](#)" on page 55

CALCulate<Measurement>:DMODE <mode>

Specifies the display format of the measured values.

Suffix:

<Measurement> 1 to 8
Measurement

Parameters:

<mode> SDIGital | SANalog | GRAPHical | MARKer | GRID | INFO |
STATistics | TABLE

SDIGital | SANalog

For continuous average, burst average, NRT measurements
Numeric format without/with bar chart

SDIGital | SANalog | GRAPHical

For time gate, timeslot measurements
Numeric format without/with bar chart or measured values plotted over time

MARKer | GRID | INFO

For trace measurements
Shows or hides additional information below the graph.

STATistics | TABLE

For statistics measurements
Waveform or tabular format

*RST: SDIGital

Manual operation: See "[Display Format](#)" on page 54
See "[Info / Marker](#)" on page 77
See "[Graph / Table](#)" on page 103

CALCulate<Measurement>:EXTRemes:RESet

Saves the currently measured value as the new minimum and maximum values.

You can query the minimum and maximum values using:

- `CALCulate<Measurement>:MAXimum:DATA?`
- `CALCulate<Measurement>:MINimum:DATA?`

Suffix:

<Measurement> 1 to 8
 Measurement

Usage: Event

CALCulate<Measurement>:HOLD:FUNCTION <function>

For all measurement functions, the R&S NRX stores the maximum and minimum values and the calculated differences between these values.

The selected setting applies to both power and reflection indication. You can change at any time.

Alias: `CALCulate<Measurement>:LIMit<undef>:TYPE`

Suffix:

<Measurement> 1 to 8
 Measurement

Parameters:

<function> MAX | MIN | DIFFerence

MAXimum
 Maximum value

MINimum
 Minimum value

DIFFerence
 Difference between maximum and minimum value

*RST: MAX

Manual operation: See "[Max Hold Function](#)" on page 59

CALCulate<Measurement>:HOLD[:STATe] <state>

If enabled, displays the highest value measured for each point (pixel) of the selected display type.

Alias: `CALCulate<Measurement>:LIMit<undef>[:STATe]`

Suffix:

<Measurement> 1 to 8
 Measurement

Parameters:

<state> OFF | ON | RESet
 *RST: OFF

Manual operation: See "Max Hold" on page 59

CALCulate<Measurement>:LIMit<undef>:TYPE <type>

Alias for [CALCulate<Measurement>:HOLD:FUNction](#) on page 199.

Suffix:

<Measurement> 1 to 8
 Measurement
 <undef> 1 to n
 No suffix required.

Parameters:

<type> MAX | MIN | DIFFerence
 *RST: MAX

CALCulate<Measurement>:LIMit<undef>[:STATe] <state>

Alias for [CALCulate<Measurement>:HOLD\[:STATe\]](#).

Suffix:

<Measurement> 1 to 8
 Measurement
 <undef> 1 to n
 No suffix required.

Parameters:

<state> OFF | ON
 *RST: OFF

CALCulate<Measurement>:RESolution <resolution>

Configures the resolution of the measurement.

Suffix:

<Measurement> 1 to 8
 Measurement

Parameters:

<resolution> I | OI | OOI | OOOI
 I
 No decimal places, e.g. 1 dBm
 OI
 1 decimal place, e.g. 0.1 dBm

OOI

2 decimal places, e.g. 0.01 dBm

OOOI

3 decimal places, e.g. 0.001 dBm

*RST: OOI

Manual operation: See "[Resolution](#)" on page 54**DISPlay:BRIGhtness** <brightness>

Enables or disables the display backlight.

Parameters:

<brightness>	Range:	0.0 to 1.0
	*RST:	1.0

DISPlay:ERRorlist <state>If enabled, displays a dialog containing the SCPI error queue. You can delete the queue using [SYSTem:ERRor:ALL?](#).

pressing the [DEL] key.

Parameters:

<state>

DISPlay:LAYout <layout>Splits the measurement display into panes. A maximum number of 4 panes is possible, one for each measurement. See also [Chapter 4.1.5, "Selecting the display layout"](#), on page 38.**Parameters:**

<layout>	L1 L2 L3 L4
	*RST: L1

DISPlay:MESSage:TEXT:CLEar

Deletes the text for user-defined messages.

Define the message text using [DISPlay:MESSage:TEXT\[:DATA\]](#).**Usage:** Event**DISPlay:MESSage:TEXT[:DATA]** <string>

Defines the text for user-defined messages.

Parameters:

<string>

ASCII characters

String "\n" causes a line break. The max. number of lines depends on the message type: 9 lines for messages and 7 lines for queries.

The length of a line depends on the characters used. Too long lines are cut off.

DISPlay:MESSAge:TYPE <type>

Sets the message type for the user-defined messages.

Parameters:

<type>

QUERy | MESSAge

QUERy

The execution of remote control commands is blocked, until the dialog containing the query is closed.

MESSAge

Remote control command processing is immediately continued. Close the dialog containing the message by pressing [Esc] or using `DISPlay:MESSAge[:STATe] OFF`.

*RST: MESSAge

DISPlay:MESSAge[:STATe] <state>

If enabled, displays a dialog containing a user-defined message.

Define the message text using `DISPlay:MESSAge:TEXT[:DATA]`.

Parameters:

<state>

DISPlay:OVERload[:STATe] <state>

If enabled, hides the sensor overload message. But be aware that overload can damage the power sensor, depending on the amount of power and the duration of the overload condition.

You can query the allowed maximum power using `SYSTem:SENSor<Sensor>:INFO?`, or look it up in the data sheet of the power sensor.

Replaces the following R&S NRP2 command: `SERvice:DISPlay:OVERload`

Parameters:

<state>

OFF | ON | NEVer

*RST: ON; but does not apply if NEVer is set.

Manual operation: See "[Hide Sensor Overload Message](#)" on page 169

DISPlay:PIXMap?

Queries the display content. The return value is a binary block data, for example:

```
#577110xxxxxx...x
```

#577110 = block data header

xxxxxx...x = binary format comprising an 8-bit BMP bitmap of the display content.

Usage: Query only

DISPlay:UPDate <mode>

Sets the update frequency of the measured values in the display.

Parameters:

<mode> NORMAL | SLOW | FREeze

FREeze is useful if discontinuities in the voltage progress at the analog outputs occur. In this state, the display does not consume CPU time.

*RST: NORMAL

DISPlay[:WINDow<Window>][:STATe] <state>

Opens or closes a measurement pane. This action also changes the total number of measurement panes set by [DISPlay:LAYout](#) and vice versa. See also [Chapter 4.1.5, "Selecting the display layout"](#), on page 38.

Suffix:

<Window> 1 to 4
Measurement pane

Parameters:

<state> OFF | ON

DISPlay[:WINDow<Window>]:POSition <position>

Swaps the position of measurement panes in the user interface. The numbering of the panes is not changed. See also [Chapter 4.1.6, "Swapping measurement panes"](#), on page 40.

Suffix:

<Window> 1 to 4
Measurement pane

Parameters:

<position> Range: 0 to 3
*RST: 0

SYSTem:SPEEd <mode>

Changes the data processing speed.

Parameters:

<mode> NORMal | FAST | SLOW | FREeze

FAST

The display is switched off and the measured values are no longer displayed, since the continuous update of the screen content requires computation time.

*RST: NORMal

13.6.1.2 Scaling

CALCulate<Measurement>:METer<DirectionalChannel>:LOWer[:DATA]:CCDF.....	205
CALCulate<Measurement>:METer<DirectionalChannel>:LOWer[:DATA]:RATio:RCOefficient.	205
CALCulate<Measurement>:METer<DirectionalChannel>:LOWer[:DATA]:RATio:RFRatio.....	205
CALCulate<Measurement>:METer<DirectionalChannel>:LOWer[:DATA]:RATio:RLOSs.....	206
CALCulate<Measurement>:METer<DirectionalChannel>:LOWer[:DATA]:RATio:SWR.....	206
CALCulate<Measurement>:METer<DirectionalChannel>:LOWer[:DATA]:RATio[:VALue].....	207
CALCulate<Measurement>:METer<DirectionalChannel>:LOWer[:DATA][:POWER].....	207
CALCulate<Measurement>:METer<DirectionalChannel>:UPPer[:DATA]:CCDF.....	208
CALCulate<Measurement>:METer<DirectionalChannel>:UPPer[:DATA]:RATio:RCOefficient..	208
CALCulate<Measurement>:METer<DirectionalChannel>:UPPer[:DATA]:RATio:RFRatio.....	208
CALCulate<Measurement>:METer<DirectionalChannel>:UPPer[:DATA]:RATio:RLOSs.....	209
CALCulate<Measurement>:METer<DirectionalChannel>:UPPer[:DATA]:RATio:SWR.....	209
CALCulate<Measurement>:METer<DirectionalChannel>:UPPer[:DATA]:RATio[:VALue].....	210
CALCulate<Measurement>:METer<DirectionalChannel>:UPPer[:DATA][:POWER].....	210
CALCulate<Measurement>:TRACe:X[:SCALE]:LEFT.....	211
CALCulate<Measurement>:TRACe:X[:SCALE]:LENGth.....	211
CALCulate<Measurement>:TRACe:Y[:SCALE]:SPAN:DB.....	211
CALCulate<Measurement>:TRACe:Y[:SCALE]:SPAN:DBM.....	212
CALCulate<Measurement>:TRACe:Y[:SCALE]:SPAN:DBUV.....	212
CALCulate<Measurement>:TRACe:Y[:SCALE]:SPAN:DPCT.....	212
CALCulate<Measurement>:TRACe:Y[:SCALE]:SPAN:ONE.....	212
CALCulate<Measurement>:TRACe:Y[:SCALE]:SPAN:WATT.....	213
CALCulate<Measurement>:TRACe:Y[:SCALE]:TOP:DB.....	213
CALCulate<Measurement>:TRACe:Y[:SCALE]:TOP:DBM.....	213
CALCulate<Measurement>:TRACe:Y[:SCALE]:TOP:DBUV.....	214
CALCulate<Measurement>:TRACe:Y[:SCALE]:TOP:DPCT.....	214
CALCulate<Measurement>:TRACe:Y[:SCALE]:TOP:ONE.....	214
CALCulate<Measurement>:TRACe:Y[:SCALE]:TOP:WATT.....	215
DISPlay[:WINDow<Window>]:ANALog:AUTO.....	215
DISPlay[:WINDow<Window>]:METer:AUTO.....	215
DISPlay[:WINDow<Window>]:ANALog:LOWer.....	215
DISPlay[:WINDow<Window>]:METer:LOWer.....	215
DISPlay[:WINDow<Window>]:ANALog:UPPer.....	216

DISPlay[:WINDow<Window>]:METer:UPPer.....	216
[SENSe<Sensor>:]TRACe:OFFSet:TIME.....	216
[SENSe<Sensor>:]TRACe:TIME.....	216

CALCulate<Measurement>:METer<DirectionalChannel>:LOWer[:DATA]:CCDF
 <value>

Sets the lower limit for the CCDF bargraph display.

Suffix:

<Measurement> 1 to 8
 Measurement

<DirectionalChannel> 1 to 2
 1 = primary sensor, 2 = secondary sensor or 1 = forward, 2 = reflection (reverse)

Parameters:

<value> Range: 0.0 to 100.0
 *RST: 0.0
 Default unit: pct

Manual operation: See "[Forward Scale Lower Limit, Reflection Scale Lower Limit](#)" on page 56

CALCulate<Measurement>:METer<DirectionalChannel>:LOWer[:DATA]:RATio:
RCoefficient <value>

Sets the lower limit for the reflection coefficient bargraph display.

Suffix:

<Measurement> 1 to 8
 Measurement

<DirectionalChannel> 1 to 2
 1 = primary sensor, 2 = secondary sensor or 1 = forward, 2 = reflection (reverse)

Parameters:

<value> Range: -1e18 to 1e18
 *RST: 1.0
 Default unit: -

Manual operation: See "[Scale Lower Limit](#)" on page 55
 See "[Forward Scale Lower Limit, Reflection Scale Lower Limit](#)" on page 56

CALCulate<Measurement>:METer<DirectionalChannel>:LOWer[:DATA]:RATio:
RFRatio <value>

Sets the lower limit for the ratio of the forward/reverse power bargraph display.

Suffix:

<Measurement> 1 to 8
Measurement

<DirectionalChannel> 1 to 2
1 = primary sensor, 2 = secondary sensor or 1 = forward, 2 = reflection (reverse)

Parameters:

<value> Range: 0.0 to 100.0
*RST: 0.0
Default unit: pct

Manual operation: See ["Scale Lower Limit"](#) on page 55
See ["Forward Scale Lower Limit, Reflection Scale Lower Limit"](#) on page 56

**CALCulate<Measurement>:METer<DirectionalChannel>:LOWer[:DATA]:RATio:
RLOSs <value>**

Sets the lower limit for the return loss bargraph display.

Suffix:

<Measurement> 1 to 8
Measurement

<DirectionalChannel> 1 to 2
1 = primary sensor, 2 = secondary sensor or 1 = forward, 2 = reflection (reverse)

Parameters:

<value> Range: -200.0 to 200.0
*RST: -200.0
Default unit: dB

Manual operation: See ["Scale Lower Limit"](#) on page 55
See ["Forward Scale Lower Limit, Reflection Scale Lower Limit"](#) on page 56

**CALCulate<Measurement>:METer<DirectionalChannel>:LOWer[:DATA]:RATio:
SWR <value>**

Sets the lower limit for the standing wave ratio (SWR) bargraph display.

Suffix:

<Measurement> 1 to 8
Measurement

<DirectionalChannel> 1 to 2
1 = primary sensor, 2 = secondary sensor or 1 = forward, 2 = reflection (reverse)

Parameters:

<value> Range: 0.0 to 1e18
 *RST: 1.0
 Default unit: -

Manual operation: See ["Scale Lower Limit"](#) on page 55
 See ["Forward Scale Lower Limit, Reflection Scale Lower Limit"](#)
 on page 56

**CALCulate<Measurement>:METer<DirectionalChannel>:LOWer[:DATA]:RATio[:
 VALue] <value>**

Sets the lower limit for the power ratio bargraph display.

If you enter a value without unit, the unit is defined by [UNIT<Measurement>:POWER:RATio](#). For further information, see [Chapter 13.6.1.3, "Units"](#), on page 217.

Suffix:

<Measurement> 1 to 8
 Measurement

<DirectionalChannel> 1 to 2
 1 = primary sensor, 2 = secondary sensor or 1 = forward, 2 =
 reflection (reverse)

Parameters:

<value> Range: -180.0 to +180.0
 *RST: -20.0
 Default unit: dB

Manual operation: See ["Scale Lower Limit"](#) on page 55
 See ["Forward Scale Lower Limit, Reflection Scale Lower Limit"](#)
 on page 56

**CALCulate<Measurement>:METer<DirectionalChannel>:LOWer[:DATA][:POWER]
 <value>**

Sets the lower limit for the power value bargraph display.

If you enter a value without unit, the unit is defined by [UNIT<Measurement>:POWER\[:VALue\]](#). For further information, see [Chapter 13.6.1.3, "Units"](#), on page 217.

Suffix:

<Measurement> 1 to 8
 Measurement

<DirectionalChannel> 1 to 2
 1 = primary sensor, 2 = secondary sensor or 1 = forward, 2 =
 reflection (reverse)

Parameters:

<value> Range: -120.0 to +150.0
 *RST: -60.0
 Default unit: dBm

Manual operation: See ["Scale Lower Limit"](#) on page 55
 See ["Forward Scale Lower Limit, Reflection Scale Lower Limit"](#)
 on page 56

CALCulate<Measurement>:METer<DirectionalChannel>:UPPer[:DATA]:CCDF
 <value>

Sets the upper limit for the CCDF bargraph display.

Suffix:

<Measurement> 1 to 8
 Measurement

<DirectionalChannel> 1 to 2
 1 = primary sensor, 2 = secondary sensor or 1 = forward, 2 =
 reflection (reverse)

Parameters:

<value> Range: 0.0 to 100.0
 *RST: 100.0
 Default unit: pct

Manual operation: See ["Forward Scale Upper Limit, Reflection Scale Upper Limit"](#)
 on page 56

CALCulate<Measurement>:METer<DirectionalChannel>:UPPer[:DATA]:RATio:
RCoefficient <value>

Sets the upper limit for the reflection coefficient bargraph display.

Suffix:

<Measurement> 1 to 8
 Measurement

<DirectionalChannel> 1 to 2
 1 = primary sensor, 2 = secondary sensor or 1 = forward, 2 =
 reflection (reverse)

Parameters:

<value> Range: -1e18 to 1e18
 *RST: 5.0
 Default unit: -

Manual operation: See ["Scale Upper Limit"](#) on page 56
 See ["Forward Scale Upper Limit, Reflection Scale Upper Limit"](#)
 on page 56

CALCulate<Measurement>:METer<DirectionalChannel>:UPPer[:DATA]:RATio:
RFRatio <value>

Sets the upper limit for the ratio of the forward/reverse power bargraph display.

Suffix:

<Measurement> 1 to 8
Measurement

<DirectionalChannel> 1 to 2
1 = primary sensor, 2 = secondary sensor or

Parameters:

<value> Range: 0.0 to 100.0
*RST: 100.0
Default unit: pct

Manual operation: See ["Scale Upper Limit"](#) on page 56
See ["Forward Scale Upper Limit, Reflection Scale Upper Limit"](#)
on page 56

**CALCulate<Measurement>:METer<DirectionalChannel>:UPPer[:DATA]:RATio:
RLOSs <value>**

Sets the upper limit for the return loss bargraph display.

Suffix:

<Measurement> 1 to 8
Measurement

<DirectionalChannel> 1 to 2
1 = primary sensor, 2 = secondary sensor or 1 = forward, 2 =
reflection (reverse)

Parameters:

<value> Range: -200.0 to 200.0
*RST: 200.0
Default unit: dB

Manual operation: See ["Scale Upper Limit"](#) on page 56
See ["Forward Scale Upper Limit, Reflection Scale Upper Limit"](#)
on page 56

**CALCulate<Measurement>:METer<DirectionalChannel>:UPPer[:DATA]:RATio:
SWR <value>**

Sets the upper limit for the standing wave ratio (SWR) bargraph display.

Suffix:

<Measurement> 1 to 8
Measurement

<DirectionalChannel> 1 to 2
1 = primary sensor, 2 = secondary sensor or 1 = forward, 2 =
reflection (reverse)

Parameters:

<value> Range: 0.0 to 1e18
 *RST: 2.0
 Default unit: -

Manual operation: See ["Scale Upper Limit"](#) on page 56
 See ["Forward Scale Upper Limit, Reflection Scale Upper Limit"](#)
 on page 56

**CALCulate<Measurement>:METer<DirectionalChannel>:UPPer[:DATA]:RATio[:
 VALue] <value>**

Sets the upper limit for the power ratio bargraph display.

If you enter a value without unit, the unit is defined by [UNIT<Measurement>:POWER:RATio](#). For further information, see [Chapter 13.6.1.3, "Units"](#), on page 217.

Suffix:

<Measurement> 1 to 8
 Measurement

<DirectionalChannel> 1 to 2
 1 = primary sensor, 2 = secondary sensor or 1 = forward, 2 = reflection (reverse)

Parameters:

<value> Range: -180.0 to +180.0
 *RST: +20.0
 Default unit: dB

Manual operation: See ["Scale Upper Limit"](#) on page 56
 See ["Forward Scale Upper Limit, Reflection Scale Upper Limit"](#)
 on page 56

**CALCulate<Measurement>:METer<DirectionalChannel>:UPPer[:DATA][:POWER]
 <value>**

Sets the upper limit for the power value bargraph display.

If you enter a value without unit, the unit is defined by [UNIT<Measurement>:POWER\[:VALue\]](#). For further information, see [Chapter 13.6.1.3, "Units"](#), on page 217.

Suffix:

<Measurement> 1 to 8
 Measurement

<DirectionalChannel> 1 to 2
 1 = primary sensor, 2 = secondary sensor or 1 = forward, 2 = reflection (reverse)

Parameters:

<value> Range: -120.0 to +150.0
 *RST: +10.0
 Default unit: dBm

Manual operation: See ["Scale Upper Limit"](#) on page 56
 See ["Forward Scale Upper Limit, Reflection Scale Upper Limit"](#)
 on page 56

CALCulate<Measurement>:TRACe:X[:SCALe]:LEFT <value>

Defines the position of the left screen edge relative to the delayed trigger. The value can be negative so that signal components are displayed before the trigger event.

Suffix:

<Measurement> 1 to 8
 Measurement

Parameters:

<value> Range: -15.0 to 15.0
 *RST: 0.0
 Default unit: s

Manual operation: See ["Start Time"](#) on page 57

CALCulate<Measurement>:TRACe:X[:SCALe]:LENGth <value>

Sets the duration of the trace.

Suffix:

<Measurement> 1 to 8
 Measurement

Parameters:

<value> Range: 8.3e-9 to 30.0
 *RST: 0.01
 Default unit: s

Manual operation: See ["Trace Length"](#) on page 57

CALCulate<Measurement>:TRACe:Y[:SCALe]:SPAN:DB <value>

Effective for trace, pulse analysis, time gate, timeslot measurements.

Sets the power level range.

Suffix:

<Measurement> 1 to 8
 Measurement

Parameters:

<value> Range: 0.005 to 400.0
 *RST: 50.0
 Default unit: dB

Manual operation: See ["Power Span"](#) on page 58

CALCulate<Measurement>:TRACe:Y[:SCALE]:SPAN:DBM <value>

Effective for trace, pulse analysis, time gate, timeslot measurements.

Sets the power level range.

Suffix:

<Measurement> 1 to 8
Measurement

Parameters:

<value> Range: 0.005 to 400.0
*RST: 50.0
Default unit: dBm

Manual operation: See "[Power Span](#)" on page 58

CALCulate<Measurement>:TRACe:Y[:SCALE]:SPAN:DBUV <value>

Effective for trace, pulse analysis, time gate, timeslot measurements.

Sets the power level range.

Suffix:

<Measurement> 1 to 8
Measurement

Parameters:

<value> Range: 0.005 to 400.0
*RST: 100.0
Default unit: dB μ V

Manual operation: See "[Power Span](#)" on page 58

CALCulate<Measurement>:TRACe:Y[:SCALE]:SPAN:DPCT <value>

Effective for trace, pulse analysis, time gate, timeslot measurements.

Sets the power level range.

Suffix:

<Measurement> 1 to 8
Measurement

Parameters:

<value> Range: 0.005 to 2e18
*RST: 200.0
Default unit: dpct

Manual operation: See "[Power Span](#)" on page 58

CALCulate<Measurement>:TRACe:Y[:SCALE]:SPAN:ONE <value>

Effective for trace, pulse analysis, time gate, timeslot measurements.

Sets the power level range without unit.

Suffix:

<Measurement> 1 to 8
Measurement

Parameters:

<value> Range: 0.005 to 2e18
*RST: 10.0
Default unit: -

Manual operation: See "[Power Span](#)" on page 58

CALCulate<Measurement>:TRACe:Y[:SCALe]:SPAN:WATT <value>

Effective for trace, pulse analysis, time gate, timeslot measurements.

Sets the power level range.

Suffix:

<Measurement> 1 to 8
Measurement

Parameters:

<value> Range: 1e-12 to 2e9
*RST: 1e-3
Default unit: W

Manual operation: See "[Power Span](#)" on page 58

CALCulate<Measurement>:TRACe:Y[:SCALe]:TOP:DB <value>

Effective for trace, pulse analysis, time gate, timeslot measurements.

Sets the power reference value. The reference value is assigned to the top line of the grid.

Suffix:

<Measurement> 1 to 8
Measurement

Parameters:

<value> Range: -200.0 to 200.0
*RST: 25.0
Default unit: dB

Manual operation: See "[Power Reference](#)" on page 57

CALCulate<Measurement>:TRACe:Y[:SCALe]:TOP:DBM <value>

Effective for trace, pulse analysis, time gate, timeslot measurements.

Sets the power reference value. The reference value is assigned to the top line of the grid.

Suffix:

<Measurement> 1 to 8
Measurement

Parameters:

<value> Range: -200.0 to 200.0
*RST: 0.0
Default unit: dBm

Manual operation: See ["Power Reference"](#) on page 57

CALCulate<Measurement>:TRACe:Y[:SCALe]:TOP:DBUV <value>

Effective for trace, pulse analysis, time gate, timeslot measurements.

Sets the power reference value. The reference value is assigned to the top line of the grid.

Suffix:

<Measurement> 1 to 8
Measurement

Parameters:

<value> Range: -100.0 to 300.0
*RST: 150.0
Default unit: dBuV

Manual operation: See ["Power Reference"](#) on page 57

CALCulate<Measurement>:TRACe:Y[:SCALe]:TOP:DPCT <value>

Effective for trace, pulse analysis, time gate, timeslot measurements.

Sets the power reference value. The reference value is assigned to the top line of the grid.

Suffix:

<Measurement> 1 to 8
Measurement

Parameters:

<value> Range: -1e18 to 1e18
*RST: 100.0
Default unit: dpct

Manual operation: See ["Power Reference"](#) on page 57

CALCulate<Measurement>:TRACe:Y[:SCALe]:TOP:ONE <value>

Effective for trace, pulse analysis, time gate, timeslot measurements.

Sets the power reference value without unit. The reference value is assigned to the top line of the grid.

Suffix:

<Measurement> 1 to 8
Measurement

Parameters:

<value> Range: -1e18 to 1e18
*RST: 10.0
Default unit: -

Manual operation: See "[Power Reference](#)" on page 57

CALCulate<Measurement>:TRACe:Y[:SCALe]:TOP:WATT <value>

Effective for trace, pulse analysis, time gate, timeslot measurements.

Sets the power reference value. The reference value is assigned to the top line of the grid.

Suffix:

<Measurement> 1 to 8
Measurement

Parameters:

<value> Range: -1e9 to 1e9
*RST: 1e-3
Default unit: W

Manual operation: See "[Power Reference](#)" on page 57

DISPlay[:WINDow<Window>]:ANALog:AUTO <state>

DISPlay[:WINDow<Window>]:METer:AUTO <state>

Automatically determines the scaling for the analog display. The upper and the lower limit value are set depending on the current measurement data.

Suffix:

<Window> 1 to 4
Measurement pane

Parameters:

<state> ONCE | OFF
*RST: OFF

DISPlay[:WINDow<Window>]:ANALog:LOWer <value>

DISPlay[:WINDow<Window>]:METer:LOWer <value>

Sets the lower limit value of the analog scale.

Suffix:

<Window> 1 to 4
Measurement pane

Parameters:

<value> Depends on the current output unit of the measured value.
 Range: 1e-18 W to 1e18 W; -150 DBM to 210 DBM; PCT:
 1e-18 PCT to 1e22 PCT; -200 DB to 200 DB

DISPlay[:WINDow<Window>]:ANALog:UPPer <value>

DISPlay[:WINDow<Window>]:METer:UPPer <value>

Sets the upper limit value of the analog scale.

Suffix:

<Window> 1 to 4
 Measurement pane

Parameters:

<value> See [DISPlay\[:WINDow<Window>\]:METer:LOWer](#)
 on page 215.

[SENSe<Sensor>:]TRACe:OFFSet:TIME <time>

Adds an offset to the beginning of the trace sequence. Thus, the trace in the result display is moved in positive or negative x-direction. If you measure with more than one power sensor, you can use this offset to arrange the traces to each other. The start of recording relative to the trigger event is set using [TRIGger<Measurement>\[:CHANnel<Channel>\]:DELay\[:VALue\]](#).

Suffix:

<Sensor> 1 to 128
 Configured sensor connected at: port A = 1, ... , port D = 4, R&S
 NRX-B9 = 101, USB and LAN port = 5 to 100

Parameters:

<time> Range: -15.0 to 15.0
 *RST: 0.0
 Default unit: s

[SENSe<Sensor>:]TRACe:TIME <time>

Sets the duration of the trace.

Suffix:

<Sensor> 1 to 128
 Configured sensor connected at: port A = 1, ... , port D = 4, R&S
 NRX-B9 = 101, USB and LAN port = 5 to 100

Parameters:

<time> Range: 8.3e-9 to 30.0
 *RST: 0.01
 Default unit: s

Manual operation: See "[Power / Div](#)" on page 57

13.6.1.3 Units

If you enter a value that is expressed in a certain unit, for example Hz, you can omit the unit. Then, the default unit provided in the remote command description is used. If you need decimal multiples and submultiples of a unit, you can use SCPI prefixes, see "Units" on page 471.

If you enter a power value or power ratio that can be expressed in more than one unit, you can enter the value together with the unit, and the unit is recognized. If you enter a value without unit, the unit defined by one of the following commands is used:

- `UNIT<Measurement>:POWer[:VALue]`
- `UNIT<Measurement>:POWer:RATio`

After a reset, the default unit is used.

<code>SENSe<Sensor>:UNIT:POWer[:VALue]</code>	217
<code>SOURce:UNIT:POWer</code>	217
<code>UNIT<Measurement>:POWer:RATio</code>	218
<code>UNIT<Measurement>:POWer:REFlection</code>	218
<code>UNIT<Measurement>:POWer:RELative:STATe</code>	218
<code>UNIT<Measurement>:POWer[:VALue]</code>	219

`SENSe<Sensor>:UNIT:POWer[:VALue] <unit>`

Sets the unit for power-related `SENSe` parameters if you enter a value without unit.

Information whether this command applies is given in the description of the affected command.

Suffix:

<Sensor> 1 to 128
Configured sensor connected at: port A = 1, ... , port D = 4, R&S NRX-B9 = 101, USB and LAN port = 5 to 100

Parameters:

<unit> DBM | DBUV | W
Available units.
If the R&S NRP2 emulation is enabled using `SYSTEM:LANGuage`, the unit is fixed to W.
*RST: DBM

`SOURce:UNIT:POWer <power>`

Requires the sensor check source (R&S NRX-B1).

Sets the unit of the power level for the output signal.

Parameters:

<power> DBM | DBUV | W
*RST: DBM

Manual operation: See "Power Level" on page 147

UNIT<Measurement>:POWer:RATio <unit>

Sets the output unit for the measured power ratio values. For NRT measurements, sets the unit of the relative forward power measurement.

Suffix:

<Measurement> 1 to 8
Measurement

Parameters:

<unit> DB | DPCT | O
The character o stands for One (x1).
*RST: DB

Manual operation: See "Unit" on page 54
See "Forward Unit" on page 54

UNIT<Measurement>:POWer:REFLection <unit>

Effective if `CALCulate<Measurement>[:CHANnel<Channel>]:FEED<Channel>`
"POWer:REVerse" is set.

Sets how the ratio of forward and reverse power is expressed.

Suffix:

<Measurement> 1 to 8
Measurement

Parameters:

<unit> RCO | RL | SWR | RFR
RCO
Reflection coefficient; 0 to 1, no unit
RL
Return loss in dB
SWR
Standing wave ratio; 1 to ∞, no unit
RFR
Ratio between forward and reverse power; 0 % to 100 %
*RST: SWR

Manual operation: See "Standing Wave Ratio (SWR)" on page 112
See "Return Loss" on page 112
See "Reflection Coefficient" on page 112
See "Reflection Ratio" on page 113

UNIT<Measurement>:POWer:RELative:STATe <state>

Alias for `CALCulate<Measurement>:RELative<DirectionalChannel>:STATe`
on page 244.

ON corresponds to ON and SET.

Suffix:

<Measurement> 1 to 8
Measurement

Parameters:

<state> OFF | ON
*RST: 0

UNIT<Measurement>:POWer[:VALue] <unit>

Sets the output unit for the measured power values. For NRT measurements, sets the unit of the absolute forward power measurement.

Suffix:

<Measurement> 1 to 8
Measurement

Parameters:

<unit> DBM | DBUV | W
*RST: DBM

Manual operation: See "Unit" on page 54
See "Forward Unit" on page 54

13.6.1.4 Limits

CALCulate<Measurement>:LIMit<undef>:CLEAr:AUTO.....	220
CALCulate<Measurement>:LIMit<undef>:CLEAr[:IMMediate].....	220
CALCulate<Measurement>:LIMit<undef>:FAIL?.....	220
CALCulate<Measurement>:LIMit<undef>:FCOut?.....	221
CALCulate<Measurement>:LIMit<DirectionalChannel>:LOWer[:DATA].....	221
CALCulate<Measurement>:LIMit<DirectionalChannel>:LOWer[:DATA]:CCDF.....	221
CALCulate<Measurement>:LIMit<DirectionalChannel>:LOWer[:DATA]:RATio:RCOefficient....	222
CALCulate<Measurement>:LIMit<DirectionalChannel>:LOWer[:DATA]:RATio:RFRatio.....	222
CALCulate<Measurement>:LIMit<DirectionalChannel>:LOWer[:DATA]:RATio:RLOSs.....	222
CALCulate<Measurement>:LIMit<DirectionalChannel>:LOWer[:DATA]:RATio:SWR.....	223
CALCulate<Measurement>:LIMit<DirectionalChannel>:LOWer[:DATA]:RATio[:VALue].....	223
CALCulate<Measurement>:LIMit<DirectionalChannel>:LOWer[:DATA]:POWer.....	224
CALCulate<Measurement>:LIMit<DirectionalChannel>:LOWer:STATe.....	224
CALCulate<Measurement>:LIMit<DirectionalChannel>:UPPer[:DATA].....	224
CALCulate<Measurement>:LIMit<DirectionalChannel>:UPPer[:DATA]:CCDF.....	225
CALCulate<Measurement>:LIMit<DirectionalChannel>:UPPer[:DATA]:RATio:RCOefficient....	225
CALCulate<Measurement>:LIMit<DirectionalChannel>:UPPer[:DATA]:RATio:RFRatio.....	225
CALCulate<Measurement>:LIMit<DirectionalChannel>:UPPer[:DATA]:RATio:RLOSs.....	226
CALCulate<Measurement>:LIMit<DirectionalChannel>:UPPer[:DATA]:RATio:SWR.....	226
CALCulate<Measurement>:LIMit<DirectionalChannel>:UPPer[:DATA]:RATio[:VALue].....	227
CALCulate<Measurement>:LIMit<DirectionalChannel>:UPPer[:DATA]:POWer.....	227
CALCulate<Measurement>:LIMit<DirectionalChannel>:UPPer:STATe.....	228

CALCulate<Measurement>:LIMit<undef>:CLEar:AUTO <mode>

If enabled, automatically resets the limit monitoring state and the internal counter for limit violations if one of the following commands is executed:

- `INITiate<Measurement>[:IMMEDIATE]`
- `INITiate<Measurement>:CONTinuous ON`
- `MEASure<Measurement>... query`
- `READ<Measurement>... query`

Suffix:

<Measurement> 1 to 8
Measurement

<undef> 1 to n
No suffix required.

Parameters:

<mode> OFF | ON | ONCE

CALCulate<Measurement>:LIMit<undef>:CLEar[:IMMEDIATE]

Resets the limit monitoring state and the internal counter for limit violations.

Suffix:

<Measurement> 1 to 8
Measurement

<undef> 1 to n
No suffix required.

Usage: Event

CALCulate<Measurement>:LIMit<undef>:FAIL?

Queries whether upper or lower limits have been violated. If one of the following events occurs, the status is reset:

- R&S NRX is switched on.
- Reset is performed (`*RST`).
- `CALCulate<Measurement>:LIMit<undef>:CLEar[:IMMEDIATE]` is executed.

Suffix:

<Measurement> 1 to 8
Measurement

<undef> 1 to n
No suffix required.

Usage: Query only

CALCulate<Measurement>:LIMit<undef>:FCOut?

Queries the number of limit violations. The counter is reset if one of the following events occurs:

- R&S NRX is switched on.
- Reset is performed (*RST).
- CALCulate<Measurement>:LIMit<undef>:CLEar[:IMMEDIATE] is executed.

Suffix:

<Measurement> 1 to 8
Measurement

<undef> 1 to n
No suffix required.

Usage: Query only

CALCulate<Measurement>:LIMit<DirectionalChannel>:LOWer[:DATA] <value>

Sets the lower limit for the measured values.

Suffix:

<Measurement> 1 to 8
Measurement

<DirectionalChannel> 1 to 2
1 = forward, 2 = reflection (reverse)

Parameters:

<value>

Manual operation: See "[Lower Limit](#)" on page 59
See "[Forward Lower Limit, Reflection Lower Limit](#)" on page 61

CALCulate<Measurement>:LIMit<DirectionalChannel>:LOWer[:DATA]:CCDF <value>

Sets the lower limit for the complementary cumulative distribution function (CCDF).

Suffix:

<Measurement> 1 to 8
Measurement

<DirectionalChannel> 1 to 2
1 = primary sensor, 2 = secondary sensor or 1 = forward, 2 = reflection (reverse)

Parameters:

<value> Range: 0.0 to 100.0
*RST: 0.0
Default unit: pct

Manual operation: See "[Forward Lower Limit, Reflection Lower Limit](#)" on page 61

**CALCulate<Measurement>:LIMit<DirectionalChannel>:LOWer[:DATA]:RATio:
RCOefficient <value>**

Sets the lower limit for the reflection coefficient.

Suffix:

<Measurement> 1 to 8
Measurement

<DirectionalChannel> 1 to 2
1 = primary sensor, 2 = secondary sensor or 1 = forward, 2 = reflection (reverse)

Parameters:

<value> Range: -1e18 to 1e18
*RST: 1.0
Default unit: -

Manual operation: See "[Lower Limit](#)" on page 59
See "[Forward Lower Limit, Reflection Lower Limit](#)" on page 61

**CALCulate<Measurement>:LIMit<DirectionalChannel>:LOWer[:DATA]:RATio:
RFRatio <value>**

Sets the lower limit for the ratio of forward/reverse power.

Suffix:

<Measurement> 1 to 8
Measurement

<DirectionalChannel> 1 to 2
1 = primary sensor, 2 = secondary sensor or 1 = forward, 2 = reflection (reverse)

Parameters:

<value> Range: 0.0 to 100.0
*RST: 0.0
Default unit: pct

Manual operation: See "[Lower Limit](#)" on page 59
See "[Forward Lower Limit, Reflection Lower Limit](#)" on page 61

**CALCulate<Measurement>:LIMit<DirectionalChannel>:LOWer[:DATA]:RATio:
RLOSS <value>**

Sets the lower limit for the return loss.

Suffix:

<Measurement> 1 to 8
Measurement

<DirectionalChannel> 1 to 2
1 = primary sensor, 2 = secondary sensor or 1 = forward, 2 = reflection (reverse)

Parameters:

<value> Range: -200.0 to 200.0
 *RST: -200.0
 Default unit: dB

Manual operation: See "[Lower Limit](#)" on page 59
 See "[Forward Lower Limit, Reflection Lower Limit](#)" on page 61

**CALCulate<Measurement>:LIMit<DirectionalChannel>:LOWer[:DATA]:RATio:
 SWR <value>**

Sets the lower limit for the standing wave ratio (SWR).

Suffix:

<Measurement> 1 to 8
 Measurement

<DirectionalChannel> 1 to 2
 1 = primary sensor, 2 = secondary sensor or 1 = forward, 2 = reflection (reverse)

Parameters:

<value> Range: 0.0 to 1e18
 *RST: 1.0
 Default unit: -

Manual operation: See "[Lower Limit](#)" on page 59
 See "[Forward Lower Limit, Reflection Lower Limit](#)" on page 61

**CALCulate<Measurement>:LIMit<DirectionalChannel>:LOWer[:DATA]:RATio[:
 VALue] <value>**

Sets the lower limit for the measured power ratios.

If you enter a value without unit, the unit is defined by [UNIT<Measurement>:POWER:RATio](#). For further information, see [Chapter 13.6.1.3, "Units"](#), on page 217.

Suffix:

<Measurement> 1 to 8
 Measurement

<DirectionalChannel> 1 to 2
 1 = primary sensor, 2 = secondary sensor or 1 = forward, 2 = reflection (reverse)

Parameters:

<value> Range: -180.0 to +180.0
 *RST: -20.0
 Default unit: dB

Manual operation: See "[Lower Limit](#)" on page 59
 See "[Forward Lower Limit, Reflection Lower Limit](#)" on page 61

CALCulate<Measurement>:LIMit<DirectionalChannel>:LOWer[:DATA]:POWER
<value>

Sets the lower limit for the measured power values.

If you enter a value without unit, the unit is defined by `UNIT<Measurement>:POWER[:VALue]`. For further information, see [Chapter 13.6.1.3, "Units"](#), on page 217.

Suffix:

<Measurement> 1 to 8
Measurement

<DirectionalChannel> 1 to 2
1 = primary sensor, 2 = secondary sensor or 1 = forward, 2 = reflection (reverse)

Parameters:

<value> Range: -120.0 to +150.0
*RST: -60.0
Default unit: dBm

Manual operation: See ["Lower Limit"](#) on page 59
See ["Forward Lower Limit, Reflection Lower Limit"](#) on page 61

CALCulate<Measurement>:LIMit<DirectionalChannel>:LOWer:STATE <state>

Enables or disables the monitoring function for the lower limit.

Suffix:

<Measurement> 1 to 8
Measurement

<DirectionalChannel> 1 to 2
1 = primary sensor, 2 = secondary sensor or 1 = forward, 2 = reflection (reverse)

Parameters:

<state> *RST: OFF

Manual operation: See ["Lower Limit State"](#) on page 59
See ["Forward Lower Limit State, Reflection Lower Limit State"](#) on page 60

CALCulate<Measurement>:LIMit<DirectionalChannel>:UPPer[:DATA] <value>

Sets the upper limit for the measured values.

Suffix:

<Measurement> 1 to 8
Measurement

<DirectionalChannel> 1 to 2
1 = forward, 2 = reflection (reverse)

Parameters:

<value>

Manual operation: See ["Upper Limit"](#) on page 60
 See ["Forward Upper Limit, Reflection Upper Limit"](#) on page 61

CALCulate<Measurement>:LIMit<DirectionalChannel>:UPPer[:DATA]:CCDF
 <value>

Sets the upper limit for the complementary cumulative distribution function (CCDF).

Suffix:

<Measurement> 1 to 8
 Measurement

<DirectionalChannel> 1 to 2
 1 = primary sensor, 2 = secondary sensor or 1 = forward, 2 = reflection (reverse)

Parameters:

<value> Range: 0.0 to 100.0
 *RST: 100.0
 Default unit: pct

Manual operation: See ["Forward Upper Limit, Reflection Upper Limit"](#) on page 61

CALCulate<Measurement>:LIMit<DirectionalChannel>:UPPer[:DATA]:RATio:
RCoefficient <value>

Sets the upper limit for the reflection coefficient.

Suffix:

<Measurement> 1 to 8
 Measurement

<DirectionalChannel> 1 to 2
 1 = primary sensor, 2 = secondary sensor or 1 = forward, 2 = reflection (reverse)

Parameters:

<value> Range: -1e18 to 1e18
 *RST: 5.0
 Default unit: -

Manual operation: See ["Upper Limit"](#) on page 60
 See ["Forward Upper Limit, Reflection Upper Limit"](#) on page 61

CALCulate<Measurement>:LIMit<DirectionalChannel>:UPPer[:DATA]:RATio:
RFRatio <value>

Sets the upper limit for the ratio of forward/reverse power.

Suffix:

<Measurement> 1 to 8
Measurement

<DirectionalChannel> 1 to 2
1 = primary sensor, 2 = secondary sensor or 1 = forward, 2 = reflection (reverse)

Parameters:

<value> Range: 0.0 to 100.0
*RST: 100.0
Default unit: pct

Manual operation: See ["Upper Limit"](#) on page 60
See ["Forward Upper Limit, Reflection Upper Limit"](#) on page 61

**CALCulate<Measurement>:LIMit<DirectionalChannel>:UPPer[:DATA]:RATio:
RLOs <value>**

Sets the upper limit for the return loss.

Suffix:

<Measurement> 1 to 8
Measurement

<DirectionalChannel> 1 to 2
1 = primary sensor, 2 = secondary sensor or 1 = forward, 2 = reflection (reverse)

Parameters:

<value> Range: -200.0 to 200.0
*RST: 200.0
Default unit: dB

Manual operation: See ["Upper Limit"](#) on page 60
See ["Forward Upper Limit, Reflection Upper Limit"](#) on page 61

**CALCulate<Measurement>:LIMit<DirectionalChannel>:UPPer[:DATA]:RATio:SWR
<value>**

Sets the upper limit for the standing wave ratio (SWR).

Suffix:

<Measurement> 1 to 8
Measurement

<DirectionalChannel> 1 to 2
1 = primary sensor, 2 = secondary sensor or 1 = forward, 2 = reflection (reverse)

Parameters:

<value> Range: 0.0 to 1e18
*RST: 2.0
Default unit: -

Manual operation: See ["Upper Limit"](#) on page 60
See ["Forward Upper Limit, Reflection Upper Limit"](#) on page 61

CALCulate<Measurement>:LIMit<DirectionalChannel>:UPPer[:DATA]:RATio[:VALue] <value>

Sets the upper limit for the measured power ratios.

If you enter a value without unit, the unit is defined by [UNIT<Measurement>:POWER:RATio](#). For further information, see [Chapter 13.6.1.3, "Units"](#), on page 217.

Suffix:

<Measurement> 1 to 8
Measurement

<DirectionalChannel> 1 to 2
1 = primary sensor, 2 = secondary sensor or 1 = forward, 2 = reflection (reverse)

Parameters:

<value> Range: -180.0 to +180.0
*RST: +20.0
Default unit: dB

Manual operation: See ["Upper Limit"](#) on page 60
See ["Forward Upper Limit, Reflection Upper Limit"](#) on page 61

CALCulate<Measurement>:LIMit<DirectionalChannel>:UPPer[:DATA]:POWER <value>

Sets the upper limit for the measured power values.

If you enter a value without unit, the unit is defined by [UNIT<Measurement>:POWER\[:VALue\]](#). For further information, see [Chapter 13.6.1.3, "Units"](#), on page 217.

Suffix:

<Measurement> 1 to 8
Measurement

<DirectionalChannel> 1 to 2
1 = primary sensor, 2 = secondary sensor or 1 = forward, 2 = reflection (reverse)

Parameters:

<value> Range: -120.0 to +150.0
*RST: +10.0
Default unit: dBm

Manual operation: See ["Upper Limit"](#) on page 60
See ["Forward Upper Limit, Reflection Upper Limit"](#) on page 61

CALCulate<Measurement>:LIMit<DirectionalChannel>:UPPer:STATe <state>

Enables or disables the monitoring function for the upper limit.

Suffix:

<Measurement> 1 to 8
Measurement

<DirectionalChannel> 1 to 2
1 = primary sensor, 2 = secondary sensor or

Parameters:

<state> *RST: OFF

Manual operation: See "Upper Limit State" on page 60
See "Forward Upper Limit State, Reflection Upper Limit State" on page 61

13.6.1.5 Result formats and screenshots

FORMat:SREGister.....	228
FORMat[:READings][:DATA].....	228
FORMat[:READings]:BORDER.....	229
SYSTem:HCOPY.....	229

FORMat:SREGister <sregister>

Specifies the format that is used for the return value of *STB?.

Parameters:

<sregister> ASCII | BINary | HEXadecimal | OCTal
*RST: ASCII

FORMat[:READings][:DATA] [<data,length>, <arg1>]

Specifies how the controller expects numeric data from the R&S NRX.

Parameters:

<data,length> <REAL,32 | 64>
Floating point numbers as standardized in IEEE 754, 32-bit or 64-bit. If you omit the length, the R&S NRX uses the last used length.
Example for REAL, 32 format:
#14....<binary float value>....
Example for REAL, 64 format:
#18....<binary float value>....

<arg1> <ASCIi[,0 to 12]>
 Readable value. The digit defines the number of decimal places.
 If more values are output, they are separated by commas.
 Example: -2.279610E+01
 *RST: ASCIi,0
 The reset value 0 does not restrict the number of decimal places.

FORMat[:READings]:BORDER <border>

Selects the order of bytes in 64-bit binary data.

Parameters:

<border> NORMal | SWAPped

NORMal
 The 1st byte is the least significant byte, the 4th/8th byte the most significant byte.
 Fulfills the Little Endian (little end comes first) convention, used by x86/x64 CPUs, for example.

SWAPped
 The 1st byte is the most significant byte, the 4th/8th byte the least significant byte.
 Fulfills the Big Endian (big end comes first) convention.

*RST: NORMal

Example: FORM:BORD NORM

SYSTem:HCOPY [<filename>]

Creates a screenshot of the current display. If you supply a filename with the command, this filename is used for the target file. Otherwise, an internal name is generated that you can query using this command.

See also [Chapter 4.1.8, "Creating and saving screenshots"](#), on page 42.

Parameters:

<filename>

Manual operation: See "[Screenshot](#)" on page 27

13.6.2 Configuring the trigger

Further Information:

- [Chapter 6.1.3, "Triggering"](#), on page 63

TRIGger<undef>:ALL:ATRigger[:STATe].....	230
TRIGger<Measurement>[:CHANnel<Channel>]:ATRigger[:STATe].....	230
TRIGger<undef>:ALL:COUNT.....	231
TRIGger<Measurement>[:CHANnel<Channel>]:COUNT.....	231

TRIGger<undef>:ALL:DELay:AUTO.....	231
TRIGger<Measurement>[:CHANnel<Channel>]:DELay:AUTO.....	231
TRIGger<undef>:ALL:DELay[:VALue].....	232
TRIGger<Measurement>[:CHANnel<Channel>]:DELay[:VALue].....	232
TRIGger<undef>:ALL:DTIME.....	232
TRIGger<Measurement>[:CHANnel<Channel>]:DTIME.....	232
TRIGger<Measurement>[:CHANnel<Channel>]:EXTernal<Port>:IMPedance.....	232
TRIGger<undef>:ALL:HOLDoff.....	233
TRIGger<Measurement>[:CHANnel<Channel>]:HOLDoff.....	233
TRIGger<undef>:ALL:HYSteresis.....	233
TRIGger<Measurement>[:CHANnel<Channel>]:HYSteresis.....	233
TRIGger<Measurement>[:CHANnel<Channel>]:JITTer:METHod.....	234
TRIGger<undef>:ALL:LEVel.....	234
TRIGger<Measurement>[:CHANnel<Channel>]:LEVel.....	234
TRIGger<undef>:ALL:MODE.....	235
TRIGger<Measurement>:MODE.....	235
TRIGger<Measurement>[:CHANnel<Channel>]:SENDer:PORT.....	235
TRIGger<Measurement>[:CHANnel<Channel>]:SENDer[:STATe].....	236
TRIGger<undef>:ALL:SLOPe.....	236
TRIGger<Measurement>[:CHANnel<Channel>]:SLOPe.....	236
TRIGger<undef>:ALL:SOURce.....	237
TRIGger<Measurement>[:CHANnel<Channel>]:SOURce.....	237
TRIGger<Measurement>[:CHANnel<Channel>]:SYNChronize:PORT.....	237
TRIGger<undef>:ALL:SYNChronize[:STATe].....	238
TRIGger<Measurement>[:CHANnel<Channel>]:SYNChronize[:STATe].....	238
TRIGger<undef>:ALL[:IMMEDIATE].....	238
TRIGger<Measurement>[:IMMEDIATE].....	238

TRIGger<undef>:ALL:ATRigger[:STATe] <stat>**TRIGger<Measurement>[:CHANnel<Channel>]:ATRigger[:STATe] <stat>**

Controls the automatic trigger function. If enabled, an artificial trigger is generated if the delay time has elapsed after the measurement start and no trigger event has occurred.

The auto delay is set using `TRIGger<Measurement>[:CHANnel<Channel>]:DELay:AUTO` on page 231.

The command is not fully R&S NRP2 compatible. If port 1 is assigned to measurement 1 and so on, the command works. If port 1 is assigned to measurement 2, for example, enable the R&S NRP2 emulation using `SYSTem:LANGUage "NRP2"`.

Suffix:

<Measurement>	1 to 8 Measurement
<Channel>	1 to 2 1 = primary sensor, 2 = secondary sensor

Parameters:

<stat>	ON OFF
*RST:	ON

TRIGger<undef>:ALL:COUNT <count>

TRIGger<Measurement>[:CHANnel<Channel>]:COUNT <count>

Sets the number of measurement cycles to be performed when the measurement is started using `INITiate<Measurement>[:IMMediate]`.

This number equals the number of results that can be obtained from the sensor after a single measurement. As long as the defined number of measurements is not executed, the sensor automatically initiates another measurement internally when the current result is available.

This command is particularly useful in conjunction with buffered measurements. For example, to fill a buffer with a predefined size with measurements that have been triggered externally or by `*TRG` without having to start the measurement multiple times.

The command is not fully R&S NRP2 compatible. If port 1 is assigned to measurement 1 and so on, the command works. If port 1 is assigned to measurement 2, for example, enable the R&S NRP2 emulation using `SYSTem:LANGuage "NRP2"`.

Suffix:

<Measurement> 1 to 8
 Measurement

<Channel> 1 to 2
 1 = primary sensor, 2 = secondary sensor

Parameters:

<count> Range: Depends on power sensor
 *RST: 1

TRIGger<undef>:ALL:DELAy:AUTO <stat>

TRIGger<Measurement>[:CHANnel<Channel>]:DELAy:AUTO <stat>

If enabled, no measurement is started until the power sensor has settled. For this purpose, the delay value is automatically determined.

If a longer period is set using `TRIGger<Measurement>[:CHANnel<Channel>]:DELAy[:VALue]`, the automatically determined delay is ignored.

The command is not fully R&S NRP2 compatible. If port 1 is assigned to measurement 1 and so on, the command works. If port 1 is assigned to measurement 2, for example, enable the R&S NRP2 emulation using `SYSTem:LANGuage "NRP2"`.

Suffix:

<Measurement> 1 to 8
 Measurement

<Channel> 1 to 2
 1 = primary sensor, 2 = secondary sensor

Parameters:

<stat> ON | OFF
 *RST: OFF

TRIGger<undef>:ALL:DELAy[:VALue] <delay>

TRIGger<Measurement>[:CHANnel<Channel>]:DELAy[:VALue] <delay>

Sets the delay between the trigger event and the beginning of the actual measurement.

The command is not fully R&S NRP2 compatible. If port 1 is assigned to measurement 1 and so on, the command works. If port 1 is assigned to measurement 2, for example, enable the R&S NRP2 emulation using `SYSTem:LANGuage "NRP2"`.

Suffix:

<Measurement> 1 to 8
Measurement

<Channel> 1 to 2
1 = primary sensor, 2 = secondary sensor

Parameters:

<delay> Range: -5.0 to 10.0
 *RST: 0.0
 Default unit: s

Manual operation: See "[Delay](#)" on page 67

TRIGger<undef>:ALL:DTIME <dropout>

TRIGger<Measurement>[:CHANnel<Channel>]:DTIME <dropout>

If the trigger level has been underrun with internal triggering, it is sometimes useful to wait some time (drop-out time) before retriggering. The measurement of unwanted signal components can thus be suppressed. See [Chapter 6.1.3.3, "Dropout time"](#), on page 64.

The command is not fully R&S NRP2 compatible. If port 1 is assigned to measurement 1 and so on, the command works. If port 1 is assigned to measurement 2, for example, enable the R&S NRP2 emulation using `SYSTem:LANGuage "NRP2"`.

Suffix:

<Measurement> Measurement

<Channel> 1 to 2
1 = primary sensor, 2 = secondary sensor

Parameters:

<dropout> Range: 0.0 to 10.0
 *RST: 0.0
 Default unit: s

Manual operation: See "[Dropout](#)" on page 67

TRIGger<Measurement>[:CHANnel<Channel>]:EXTernal<Port>:IMPedance <impedance>

Requires a power sensor with a trigger input.

Sets the termination resistance of the external trigger signal that is supplied at the trigger input/output of the power sensor. Choose a setting that fits the impedance of the trigger source to minimize reflections on the trigger signals.

Suffix:

<Measurement>	1 to 8 Measurement
<Channel>	1 to 2 1 = primary sensor, 2 = secondary sensor
<Port>	1 to 2 Power sensor ports; 1 = USB port, 2 = trigger I/O connector

Parameters:

<impedance>	HIGH LOW
	HIGH ~10 kΩ
	LOW 50 kΩ
	*RST: HIGH

Manual operation: See "[Trigger 2 Input Impedance](#)" on page 68

TRIGger<undef>:ALL:HOLDoff <holdoff>

TRIGger<Measurement>[:CHANnel<Channel>]:HOLDoff <holdoff>

Sets the hold-off time, see [Chapter 6.1.3.4, "Hold-off time"](#), on page 65.

The command is not fully R&S NRP2 compatible. If port 1 is assigned to measurement 1 and so on, the command works. If port 1 is assigned to measurement 2, for example, enable the R&S NRP2 emulation using `SYSTem:LANGuage "NRP2"`.

Suffix:

<Measurement>	1 to 8 Measurement
<Channel>	1 to 2 1 = primary sensor, 2 = secondary sensor

Parameters:

<holdoff>	Range: 0.0 to 10.0
	*RST: 0.0
	Default unit: s

Manual operation: See "[Holdoff](#)" on page 67

TRIGger<undef>:ALL:HYSTeresis <hysteresis>

TRIGger<Measurement>[:CHANnel<Channel>]:HYSTeresis <hysteresis>

Sets the hysteresis. A trigger event occurs, if the trigger level:

- Falls below the set value on a rising slope.
- Rises above the set value on a falling slope.

Thus, you can use this setting to eliminate the effects of noise in the signal for the edge detector of the trigger system.

The command is not fully R&S NRP2 compatible. If port 1 is assigned to measurement 1 and so on, the command works. If port 1 is assigned to measurement 2, for example, enable the R&S NRP2 emulation using `SYSTem:LANGuage "NRP2"`.

Suffix:

<Measurement> 1 to 8
Measurement

<Channel> 1 to 2
1 = primary sensor, 2 = secondary sensor

Parameters:

<hysteresis> Range: 0.0 to 10.0
*RST: 0.0
Default unit: dB

Manual operation: See "[Hysteresis](#)" on page 67

TRIGger<Measurement>[:CHANnel<Channel>]:JITTer:METHod <method>

Defines the method how to cope with the misalignment between the trigger event and the sample point.

Suffix:

<Measurement> 1 to 8
Measurement

<Channel> 1 to 2
1 = primary sensor, 2 = secondary sensor

Parameters:

<method> COMPensate | MEASure | NONE

COMPensate
Compensation means resampling of trace result.

MEASure
Does not perform resampling, but stores the measured trigger jitter.

*RST: COMPensate

Manual operation: See "[Jitter Suppression](#)" on page 67

TRIGger<undef>:ALL:LEVel <level>

TRIGger<Measurement>[:CHANnel<Channel>]:LEVel <level>

Effective only if `TRIGger<Measurement>[:CHANnel<Channel>]:SOURce INTernal`.

Sets the trigger threshold for internal triggering derived from the test signal.

If you enter a value without unit, the unit is defined by `UNIT<Measurement>:POWER[:VALue]`. For further information, see [Chapter 13.6.1.3, "Units"](#), on page 217.

The command is not fully R&S NRP2 compatible. If port 1 is assigned to measurement 1 and so on, the command works. If port 1 is assigned to measurement 2, for example, enable the R&S NRP2 emulation using `SYSTem:LANGuage "NRP2"`.

Suffix:

<Measurement> 1 to 8
Measurement

<Channel> 1 to 2
1 = primary sensor, 2 = secondary sensor

Parameters:

<level> Range: -290.0 to +223.01
*RST: -10.0
Default unit: dBm

Manual operation: See ["Trigger Level"](#) on page 66

TRIGger<undef>:ALL:MODE <mode>

TRIGger<Measurement>:MODE <mode>

Controls the trigger execution depending on the setting of the trigger source, see [TRIGger<Measurement>\[:CHANnel<Channel>\]:SOURce](#).

Suffix:

<Measurement> 1 to 8
Measurement

Parameters:

<mode> NORMal | FREerun | SINGle | AUTO

NORMal

Continuous triggering with regular trigger events.

FREerun

Enables a continuous measurement. The power sensor executes one measurement cycle after the other.

SINGle

Disables continuous triggering so that only one trigger event at a time is executed.

AUTO

Automatically starts a measurement if no trigger event has occurred after 300 ms.

*RST: AUTO

Manual operation: See ["Trigger Mode"](#) on page 66

TRIGger<Measurement>[:CHANnel<Channel>]:SENDER:PORT <port>

Effective only if the connected sensor is trigger sender, see

[TRIGger<Measurement>\[:CHANnel<Channel>\]:SENDER\[:STATE\]](#).

Sets the port where the trigger sender sensor outputs a digital trigger signal.

Suffix:

<Measurement>	1 to 8 Measurement
<Channel>	1 to 2 1 = primary sensor, 2 = secondary sensor

Parameters:

<port>	INTernal EXT2 EXTernal2
*RST:	INTernal

Manual operation: See "[Trigger Sender Port](#)" on page 68

TRIGger<Measurement>[:CHANnel<Channel>]:SENDER[:STATe] <state>

Enables or disables the power sensor as trigger sender. If enabled, the power sensor outputs a digital trigger signal in sync with its own trigger event. The trigger signal is output at the port selected by [TRIGger<Measurement>\[:CHANnel<Channel>\]:SENDER:PORT](#).

The trigger sender has to use its internal trigger source. Set the trigger source for the trigger receivers to [INTA](#) | [INTB](#) | [INTC](#) | [INTD](#), where [A to D] is the port to which the trigger sender is connected. The trigger signal generated by the trigger sender is routed to the R&S NRX and from there it is distributed to the trigger receivers and, if [OUTPut:TRIGger:SOURce SENS1](#) | [SENS2](#) | [SENS3](#) | [SENS4](#) is set, also to the trigger output.

The command is not fully R&S NRP2 compatible. If port 1 is assigned to measurement 1 and so on, the command works. If port 1 is assigned to measurement 2, for example, enable the R&S NRP2 emulation using [SYSTEM:LANGUage "NRP2"](#).

Suffix:

<Measurement>	1 to 8 Measurement
<Channel>	1 to 2 1 = primary sensor, 2 = secondary sensor

Parameters:

<state>	ON OFF
*RST:	OFF

Manual operation: See "[Trigger Sender State](#)" on page 68

TRIGger<undef>:ALL:SLOPe <slope>**TRIGger<Measurement>[:CHANnel<Channel>]:SLOPe <slope>**

Determines which edge of the envelope power (internal triggering) or increasing voltage (external triggering) is used for triggering.

The command is not fully R&S NRP2 compatible. If port 1 is assigned to measurement 1 and so on, the command works. If port 1 is assigned to measurement 2, for example, enable the R&S NRP2 emulation using [SYSTEM:LANGUage "NRP2"](#).

Suffix:

<Measurement> 1 to 8
Measurement

<Channel> 1 to 2
1 = primary sensor, 2 = secondary sensor

Parameters:

<slope> POSitive | NEGative
*RST: POSitive

Manual operation: See "Slope" on page 66

TRIGger<undef>:ALL:SOURce <source>

TRIGger<Measurement>[:CHANnel<Channel>]:SOURce <source>

Sets the source for the trigger event. See [Chapter 6.1.3.2, "Trigger sources"](#), on page 63.

The command is not fully R&S NRP2 compatible. If port 1 is assigned to measurement 1 and so on, the command works. If port 1 is assigned to measurement 2, for example, enable the R&S NRP2 emulation using `SYSTem:LANGuage "NRP2"`.

Suffix:

<Measurement> 1 to 8
Measurement

<Channel> 1 to 2
1 = primary sensor, 2 = secondary sensor

Parameters:

<source> INTernal | INTA | INTB | INTC | INTD | EXTernal | EXT2 |
EXTernal2 | CHKSource | BUS | HOLD | IMMEDIATE
See [Chapter 6.1.3.2, "Trigger sources"](#), on page 63.

IMMEDIATE

Measures immediately, does not wait for trigger condition.

*RST: INTernal

Manual operation: See "Trigger Source" on page 66

TRIGger<Measurement>[:CHANnel<Channel>]:SYNChronize:PORT <port>

Sets the internal or external connection for the sync output of the power sensor. For more information, see [TRIGger<Measurement>\[:CHANnel<Channel>\]:SYNChronize\[:STATe\]](#) on page 238.

Suffix:

<Measurement> 1 to 8
Measurement

<Channel> 1 to 2
1 = primary sensor, 2 = secondary sensor

Parameters:

<port> INTernal | EXT2 | EXTernal2
 *RST: INTernal

Manual operation: See ["Trigger Synchronize Port"](#) on page 68

TRIGger<undef>:ALL:SYNChronize[:STATe] <state>

TRIGger<Measurement>[:CHANnel<Channel>]:SYNChronize[:STATe] <state>

Usually used if [TRIGger<Measurement>\[:CHANnel<Channel>\]:SENDER\[:STATe\]](#) ON is set.

If enabled, blocks the external trigger bus as long as the power sensor remains in the measurement state. Thus, ensures that a new measurement is only started after all power sensors have completed their measurements.

Make sure that the number of repetitions is the same for all power sensors involved in the measurement. Otherwise, the trigger bus is blocked by any power sensor that has completed its measurements before the others and has returned to the idle state.

The command is not fully R&S NRP2 compatible. If port 1 is assigned to measurement 1 and so on, the command works. If port 1 is assigned to measurement 2, for example, enable the R&S NRP2 emulation using [SYSTem:LANGuage "NRP2"](#).

Suffix:

<Measurement> 1 to 8
 Measurement

<Channel> 1 to 2
 1 = primary sensor, 2 = secondary sensor

Parameters:

<state> ON | OFF
 *RST: OFF

Manual operation: See ["Trigger Synchronize State"](#) on page 68

TRIGger<undef>:ALL[:IMMediate]

TRIGger<Measurement>[:IMMediate]

Starts a measurement.

Suffix:

<Measurement> 1 to 8
 Measurement

Usage: Event

13.6.3 Selecting the measurement

Before starting a measurement, select the measurement type.

CALCulate<Measurement>[:CHANnel<Channel>]:FEED<Channel> "<string>"

Determines the data that are processed. The parameters depend on the measurement type.

The power sensor averages every measured value using a series of samples. If a **RANDom** feed is selected, the power sensor takes a random value from the samples and forwards it to the R&S NRX as a measured value. **PEAK** is the maximum of all samples in the measurement interval.

Table 13-3: Parameter to measurement assignment

Measurement type	"<string>"	Measured value
Continuous average	POWER:AVERage POWER:PEAK POWER:RANDom	Average value Peak value Randomly selected value
Burst average	POWER:AVERage POWER:PEAK POWER:RANDom	Average value Peak value Randomly selected value
Trace	POWER:TRACe POWER:PEAK:TRACe POWER:RANDom:TRACe	Measurement sequence Peak value of the samples per test point Randomly selected value
Pulse analysis	POWER:TRACe POWER:PEAK:TRACe POWER:RANDom:TRACe	Measurement sequence Peak value of the samples per test point Randomly selected value
Time gate	POWER:AVERage POWER:PEAK POWER:RANDom	Average value Peak value Randomly selected value
Time gate Graphical display The suffix <1 to 4> selects the time gate.	POWER:AVERage ON SWEEp<1 to 4> POWER:PTAVerage ON SWEEp<1 to 4> POWER:PEAK ON SWEEp<1 to 4>	Average value in time gate 1, 2, 3 or 4 Peak-to-average value in time gate 1, 2, 3 or 4 Peak value in time gate 1, 2, 3 or 4
Timeslot	POWER:AVERage POWER:PEAK POWER:RANDom	Average value Peak value Randomly selected value
Statistics	CCDF:TRACe CDF:TRACe PDF:TRACe	Complementary cumulative distribution function Cumulative distribution function Probability density function

Measurement type	"<string>"	Measured value
NRT, absolute Forward direction	POWER:FORWARD:AVERAGE POWER:FORWARD:PEP POWER:ABSORPTION:AVERAGE POWER:ABSORPTION:PEP POWER:FORWARD:AVERAGE:BURST POWER:ABSORPTION:AVERAGE: BURST	Average power Peak power of an amplitude-modulated signal Absorbed average power Absorbed peak envelope power (PEP) Average power within a burst Absorbed burst average
NRT, absolute Reverse direction	POWER:OFF POWER:REVERSE	Reverse power disabled Reverse power
NRT, relative Forward direction	POWER:FORWARD:CCDFUNCTION POWER:CFACTOR	Complementary cumulative distribution function Crest factor
NRT, relative Reverse direction	POWER:SWRATIO POWER:RLOSS POWER:RCOEFFICIENT POWER:RFRATIO	Standing wave ratio Return loss Reflection coefficient Reflection ratio

Suffix:

<Measurement>

1 to 8
Measurement

<Channel>

1 to 2
1 = primary sensor, 2 = secondary sensor or 1 = forward, 2 = reflection (reverse)

<Channel>

1 to 2
1 for R&S NRX
2 is allowed for R&S NRP2 compatibility, but only if the first channel suffix is set to 1.**Parameters:**

"<string>"

The availability depends on the measurement type, see [Table 13-3](#).

*RST: POWER:AVERAGE

Manual operation: See ["Statistics Function"](#) on page 104
 See ["Average"](#) on page 110
 See ["CCDF"](#) on page 110
 See ["Peak Envelope Power \(PEP\)"](#) on page 110
 See ["Absorption Average"](#) on page 110
 See ["Crest Factor \(CF\)"](#) on page 111
 See ["Absorption PEP"](#) on page 111
 See ["Burst Average"](#) on page 111
 See ["Absorption Burst"](#) on page 111
 See ["Off"](#) on page 112
 See ["Reverse Power"](#) on page 112
 See ["Standing Wave Ratio \(SWR\)"](#) on page 112
 See ["Return Loss"](#) on page 112
 See ["Reflection Coefficient"](#) on page 112
 See ["Reflection Ratio"](#) on page 113
 See ["Evaluate"](#) on page 117

CALCulate<Measurement>:TYPE <type>

Sets the measurement type.

Suffix:

<Measurement> 1 to 8
 Measurement

Parameters:

<type> CONTav | NRT | TRACe | STATistics | TGATe | BURStav |
 TSLot | PULSe
 *RST: CONTav

Manual operation: See ["Measurement Type"](#) on page 69

[SENSe<Sensor>:]AUXiliary <mode>

Enables the measurement of additional measured values that are determined together with the main measured value.

Suffix:

<Sensor> 1 to 128
 Configured sensor connected at: port A = 1, ... , port D = 4, R&S
 NRX-B9 = 101, USB and LAN port = 5 to 100

Parameters:

<mode> NONE | MINMax | RNDMax

NONE

No additional values are measured.

MINMax

Minima and maxima of the trace are transmitted together with the measured value.

Usually, extreme values are lost due to averaging the measured values.

RNDMax

Randomly selected samples are transmitted. All evaluations use these values instead of the average values.

*RST: NONE

13.6.4 Selecting the power sensor

Further information:

- [Chapter 6.1.4, "Measurement settings dialog"](#), on page 69

[SENSe<Sensor>:]CATalog?	242
CALCulate<Measurement>[:CHANnel<Channel>]:SENSe:INDex	242

[SENSe<Sensor>:]CATalog?

Returns a list of all connected power sensors together with the suffix of the port where the power sensor is connected.

Suffix:

<Sensor> 1 to 128
Configured sensor connected at: port A = 1, ... , port D = 4, R&S NRX-B9 = 101, USB and LAN port = 5 to 100

Example:

CAT?
Query
"2:NRP33SN-900004"
Response

Usage: Query only

Manual operation: See "[Primary Sensor, Secondary Sensor](#)" on page 70

CALCulate<Measurement>[:CHANnel<Channel>]:SENSe:INDex <index>

Effective for continuous average, burst average, trace, pulse analysis, time gate, time-slot measurements.

Assigns the primary or secondary sensor. You can choose any of the sensors that are connected to a sensor port of the R&S NRX. You can query the connected power sensors using [\[SENSe<Sensor>:\]CATalog?](#).

Suffix:

<Measurement> 1 to 8
Measurement

<Channel> 1 to 2
1 = primary sensor, 2 = secondary sensor

Parameters:

<index> Selects the power sensor by the R&S NRX port to which it is connected.

1 to 4

Sensor connector A, B, C, D

4 to 100

USB connector

101

Optional connector: interface for R&S NRT-Z sensors (R&S NRX-B9)

102 to 128

LAN interface

Range: 0 to 128

*RST: 0

Manual operation: See ["Primary Sensor, Secondary Sensor"](#) on page 70

13.6.5 Relative measurements

Available for continuous average, burst average, time gate, timeslot measurements.

Further information:

- ["Rel"](#) on page 73

CALCulate<Measurement>:RELative<DirectionalChannel>[:MAGNitude]	243
CALCulate<Measurement>:RELative<DirectionalChannel>[:MAGNitude]:AUTO	243
CALCulate<Measurement>:RELative<DirectionalChannel>:STATE	244
[SENSe<Sensor>:]POWer:REFerence	245

CALCulate<Measurement>:RELative<DirectionalChannel>[:MAGNitude] <value>

Sets the reference value for the measured relative values.

Suffix:

<Measurement> 1 to 8
Measurement

<DirectionalChannel> 1 to 2
1 = forward, 2 = reflection (reverse)

Parameters:

<value>

Manual operation: See ["Forward Reference Value, Reflection Reference Value"](#) on page 58
See ["Reference Value"](#) on page 73

CALCulate<Measurement>:RELative<DirectionalChannel>[:MAGNitude]:AUTO
<state>Alias for [CALCulate<Measurement>:RELative<DirectionalChannel>:STATE](#) on page 244.

ONCE corresponds to SET

Suffix:

<Measurement> 1 to 8
Measurement

<DirectionalChannel> 1 to 2
1 = forward, 2 = reflection (reverse)

Parameters:

<state> OFF | ONCE
*RST: OFF

Manual operation: See ["Relative Measurements"](#) on page 74

CALCulate<Measurement>:RELative<DirectionalChannel>:STATe <state>

Allows you to relate measured power or a power ratio to a reference value. Whether the power is measured by one power sensor or whether it is a combined value measured by two power sensors, is set by:

[CALCulate<Measurement>:MATH\[:EXPRession\]](#) on page 328

[CALCulate<Measurement>\[:CHANnel<Channel>\]:FEED<Channel>](#)
on page 239

Alias:

[UNIT<Measurement>:POWER:RELative:STATe](#)

[CALCulate<Measurement>:RELative<DirectionalChannel>\[:MAGNitude\]:
AUTO](#)

Suffix:

<Measurement> 1 to 8
Measurement

<DirectionalChannel> 1 to 2
1 = primary sensor, 2 = secondary sensor or 1 = forward, 2 =
reflection (reverse)

Parameters:

<state> OFF | ON | SET
OFF
Absolute power or power ratio
ON
Relative power or power ratio, using the specified reference
value.
SET
Uses the current measurement value as reference value and
enables the relative measurement.
*RST: OFF

Manual operation: See ["Forward Relative State, Reflection Relative State"](#)
on page 58
See ["Relative Measurements"](#) on page 74

[SENSe<Sensor>:]POWer:REFerence <ref>

Sets the reference value for the relative power indication.

If you enter a value without unit, the unit is defined by `SENSe<Sensor>:UNIT:POWer[:VALue]`. For further information, see [Chapter 13.6.1.3, "Units"](#), on page 217.

Suffix:

<Sensor> 1 to 128
Configured sensor connected at: port A = 1, ... , port D = 4, R&S NRX-B9 = 101, USB and LAN port = 5 to 100

Parameters:

<ref> Range: -290.0 to +110.0
*RST: +30.0
Default unit: dBm

Manual operation: See ["Forward Reference Value, Reflection Reference Value"](#) on page 58
See ["Reference Value"](#) on page 73

13.6.6 Continuous average measurements

There are several ways to program the R&S NRX for measurements. See [Chapter 13.4, "Making measurements"](#), on page 188.

Further information:

- [Chapter 6.2, "Continuous average"](#), on page 72

13.6.6.1 Combining commands for continuous average measurements

See also [Chapter 13.4, "Making measurements"](#), on page 188.

Parameter list for continuous average measurements

Parameter	Description
<expected_value>	Optional. Value that is expected for the measurement.
<resolution>	Optional. Limit up to which the measurement result probably is free of noise. Corresponds to <code>[SENSe<Sensor>:]AVERAge:COUNT:AUTO:RESolution</code> .
<source_list>	Mandatory. Primary and secondary sensor. The number for each sensor is preceded by the character @. The entire expression is enclosed in parentheses. Example: <code>(@3),(@2)</code> Sensor C is the primary sensor, and sensor B is the secondary sensor.

CONFigure<Measurement>[:SCALar][:POWer][:AVG]?

[<expected_value_or_source_list>, <resolution_or_source_list>, <source_list>...]

FETCh<Measurement>[:SCALar][:POWer][:AVG]?

[<expected_value_or_source_list>, <resolution_or_source_list>, <source_list>...]

READ<Measurement>[:SCALar][:POWer][:AVG]?

[<expected_value_or_source_list>, <resolution_or_source_list>, <source_list>...]

MEASure<Measurement>[:SCALar][:POWer][:AVG]?

[<expected_value_or_source_list>, <resolution_or_source_list>, <source_list>...]

Measured average power measured by one power sensor.

The FETCh? and READ? commands send without parameters have a special meaning.

FETCh? returns the current measured value if it is valid. If a measured value is not yet available, processing is suspended until a valid result is available.

READ? starts a measurement and returns a measured value without checking the current settings.

Suffix:

<Measurement> 1 to 8
 Measurement

Query parameters:

<expected_value_or_source_list>
 <numeric> | <expr>

<resolution_or_source_list>
 <numeric> | <expr>

<source_list> <expr>

For the parameter descriptions, see "[Parameter list for continuous average measurements](#)" on page 245.

Usage: Query only

CONFigure<Measurement>[:SCALar][:POWer][:AVG]:RELative?

[<expected_value_or_source_list>, <resolution_or_source_list>, <source_list>...]

FETCh<Measurement>[:SCALar][:POWer][:AVG]:RELative?

[<expected_value_or_source_list>, <resolution_or_source_list>, <source_list>...]

READ<Measurement>[:SCALar][:POWer][:AVG]:RELative?

[<expected_value_or_source_list>, <resolution_or_source_list>, <source_list>...]

MEASure<Measurement>[:SCALar][:POWer][:AVG]:RELative?

[<expected_value_or_source_list>, <resolution_or_source_list>, <source_list>...]

Relative power measured by one power sensor.

Suffix:

<Measurement> 1 to 8
 Measurement

Query parameters:

<expected_value_or_source_list>
 <numeric> | <expr>

Suffix:

<Measurement> 1 to 8
Measurement

Query parameters:

<expected_value_or_source_list>
 <numeric> | <expr>

<resolution_or_source_list>
 <numeric> | <expr>

<source_list> <expr>

For the parameter descriptions, see "[Parameter list for continuous average measurements](#)" on page 245.

Usage: Query only

CONFigure<Measurement>[:SCALar][:POWER][:AVG]:RATio?

[<expected_value_or_source_list>, <resolution_or_source_list>, <source_list>...]

FETCH<Measurement>[:SCALar][:POWER][:AVG]:RATio?

[<expected_value_or_source_list>, <resolution_or_source_list>, <source_list>...]

READ<Measurement>[:SCALar][:POWER][:AVG]:RATio?

[<expected_value_or_source_list>, <resolution_or_source_list>, <source_list>...]

MEASure<Measurement>[:SCALar][:POWER][:AVG]:RATio?

[<expected_value_or_source_list>, <resolution_or_source_list>, <source_list>...]

Ratio measured by two power sensors.

Suffix:

<Measurement> 1 to 8
Measurement

Query parameters:

<expected_value_or_source_list>
 <numeric> | <expr>

<resolution_or_source_list>
 <numeric> | <expr>

<source_list> <expr>

For the parameter descriptions, see "[Parameter list for continuous average measurements](#)" on page 245.

Usage: Query only

CONFigure<Measurement>[:SCALar][:POWER][:AVG]:RATio:RELative?

[<expected_value_or_source_list>, <resolution_or_source_list>, <source_list>...]

FETCH<Measurement>[:SCALar][:POWER][:AVG]:RATio:RELative?

[<expected_value_or_source_list>, <resolution_or_source_list>, <source_list>...]

READ<Measurement>[:SCALar][:POWer][:AVG]:RATio:RELative?

[<expected_value_or_source_list>, <resolution_or_source_list>, <source_list>...]

MEASure<Measurement>[:SCALar][:POWer][:AVG]:RATio:RELative?

[<expected_value_or_source_list>, <resolution_or_source_list>, <source_list>...]

Relative ratio measured by two power sensor.

Suffix:

<Measurement> 1 to 8
 Measurement

Query parameters:

<expected_value_or_source_list>
 <numeric> | <expr>

<resolution_or_source_list>
 <numeric> | <expr>

<source_list> <expr>

For the parameter descriptions, see "[Parameter list for continuous average measurements](#)" on page 245.

Usage: Query only

CONFigure<Measurement>[:SCALar][:POWer][:AVG]:SWR?

[<expected_value_or_source_list>, <resolution_or_source_list>, <source_list>...]

FETCh<Measurement>[:SCALar][:POWer][:AVG]:SWR?

[<expected_value_or_source_list>, <resolution_or_source_list>, <source_list>...]

READ<Measurement>[:SCALar][:POWer][:AVG]:SWR?

[<expected_value_or_source_list>, <resolution_or_source_list>, <source_list>...]

MEASure<Measurement>[:SCALar][:POWer][:AVG]:SWR?

[<expected_value_or_source_list>, <resolution_or_source_list>, <source_list>...]

Standing wave ratio measurement of two power sensors.

Suffix:

<Measurement> 1 to 8
 Measurement

Query parameters:

<expected_value_or_source_list>
 <numeric> | <expr>

<resolution_or_source_list>
 <numeric> | <expr>

<source_list> <expr>

For the parameter descriptions, see "[Parameter list for continuous average measurements](#)" on page 245.

Usage: Query only

CONFigure<Measurement>[:SCALar][:POWer][:AVG]:REFLection?

[<expected_value_or_source_list>, <resolution_or_source_list>, <source_list>...]

FETCh<Measurement>[:SCALar][:POWer][:AVG]:REFLection?

[<expected_value_or_source_list>, <resolution_or_source_list>, <source_list>...]

READ<Measurement>[:SCALar][:POWer][:AVG]:REFLection?

[<expected_value_or_source_list>, <resolution_or_source_list>, <source_list>...]

MEASure<Measurement>[:SCALar][:POWer][:AVG]:REFLection?

[<expected_value_or_source_list>, <resolution_or_source_list>, <source_list>...]

Reflection coefficient/transmission factor of a DUT, measured by two power sensors.

Suffix:

<Measurement> 1 to 8
 Measurement

Query parameters:

<expected_value_or_source_list>
 <numeric> | <expr>

<resolution_or_source_list>
 <numeric> | <expr>

<source_list> <expr>

For the parameter descriptions, see "[Parameter list for continuous average measurements](#)" on page 245.

Usage: Query only

CONFigure<Measurement>[:SCALar][:POWer][:AVG]:RLOSs?

[<expected_value_or_source_list>, <resolution_or_source_list>, <source_list>...]

FETCh<Measurement>[:SCALar][:POWer][:AVG]:RLOSs?

[<expected_value_or_source_list>, <resolution_or_source_list>, <source_list>...]

READ<Measurement>[:SCALar][:POWer][:AVG]:RLOSs?

[<expected_value_or_source_list>, <resolution_or_source_list>, <source_list>...]

MEASure<Measurement>[:SCALar][:POWer][:AVG]:RLOSs?

[<expected_value_or_source_list>, <resolution_or_source_list>, <source_list>...]

Return loss/transmission loss of a DUT, measured by two power sensors.

Suffix:

<Measurement> 1 to 8
 Measurement

Query parameters:

<expected_value_or_source_list>
 <numeric> | <expr>

<resolution_or_source_list>
 <numeric> | <expr>

<source_list> <expr>

For the parameter descriptions, see "[Parameter list for continuous average measurements](#)" on page 245.

Usage: Query only

13.6.6.2 Combining continuous average commands with buffering

See also [Chapter 13.4, "Making measurements"](#), on page 188.

Parameter list for continuous average measurements with buffering

Parameter	Description
<buffered_size>	Mandatory. Number of requested measured values. Corresponds to <code>[SENSe<Sensor>:] [POWer:] [AVG:]BUFFer:SIZE</code> .
<expected_value>	Optional. Value that is expected for the measurement.
<resolution>	Optional. Limit up to which the measurement result probably is free of noise. Corresponds to <code>[SENSe<Sensor>:] AVERage:COUNT:AUTO:RESolution</code> .
<source_list>	Mandatory. Primary and secondary sensor. The number for each sensor is preceded by the character @. The entire expression is enclosed in parentheses. Example: <code>(@3),(@2)</code> Sensor C is the primary sensor, and sensor B is the secondary sensor.

```

CONFigure<Measurement>:ARRay[:POWer][:AVG]? <buffered_size>[,
    <expected_value_or_source_list>, <resolution_or_source_list>, <source_list>...]
FETCh<Measurement>:ARRay[:POWer][:AVG]? <buffered_size>[,
    <expected_value_or_source_list>, <resolution_or_source_list>, <source_list>...]
READ<Measurement>:ARRay[:POWer][:AVG]? <buffered_size>[,
    <expected_value_or_source_list>, <resolution_or_source_list>, <source_list>...]
MEASure<Measurement>:ARRay[:POWer][:AVG]? <buffered_size>[,
    <expected_value_or_source_list>, <resolution_or_source_list>, <source_list>...]
  
```

Measured average power measured by one power sensor with buffering.

Suffix:

<Measurement> 1 to 8
Measurement

Query parameters:

<buffered_size> <expr>
 <expected_value_or_source_list>
 <numeric> | <expr>
 <resolution_or_source_list>
 <numeric> | <expr>
 <source_list> <expr>

For the parameter descriptions, see ["Parameter list for continuous average measurements with buffering"](#) on page 252.

Usage: Query only

```

CONFigure<Measurement>:ARRay[:POWer][:AVG]:DIFFerence? <buffered_size>[,
    <expected_value_or_source_list>, <resolution_or_source_list>, <source_list>...]
FETCh<Measurement>:ARRay[:POWer][:AVG]:DIFFerence? <buffered_size>[,
    <expected_value_or_source_list>, <resolution_or_source_list>, <source_list>...]
READ<Measurement>:ARRay[:POWer][:AVG]:DIFFerence? <buffered_size>[,
    <expected_value_or_source_list>, <resolution_or_source_list>, <source_list>...]
MEASure<Measurement>:ARRay[:POWer][:AVG]:DIFFerence? <buffered_size>[,
    <expected_value_or_source_list>, <resolution_or_source_list>, <source_list>...]

```

Difference measured by two power sensors with buffering.

Suffix:

<Measurement> 1 to 8
 Measurement

Query parameters:

<buffered_size> <expr>

<expected_value_or_source_list>
 <numeric> | <expr>

<resolution_or_source_list>
 <numeric> | <expr>

<source_list> <expr>

For the parameter descriptions, see "[Parameter list for continuous average measurements with buffering](#)" on page 252.

Usage: Query only

```

CONFigure<Measurement>:ARRay[:POWer][:AVG]:DIFFerence:RELative?
    <buffered_size>[, <expected_value_or_source_list>,
    <resolution_or_source_list>, <source_list>...]
FETCh<Measurement>:ARRay[:POWer][:AVG]:DIFFerence:RELative?
    <buffered_size>[, <expected_value_or_source_list>,
    <resolution_or_source_list>, <source_list>...]
READ<Measurement>:ARRay[:POWer][:AVG]:DIFFerence:RELative?
    <buffered_size>[, <expected_value_or_source_list>,
    <resolution_or_source_list>, <source_list>...]
MEASure<Measurement>:ARRay[:POWer][:AVG]:DIFFerence:RELative?
    <buffered_size>[, <expected_value_or_source_list>,
    <resolution_or_source_list>, <source_list>...]

```

Relative difference measured by two power sensors with buffering.

Suffix:

<Measurement> 1 to 8
 Measurement

Query parameters:

<buffered_size> <expr>

<expected_value_or_source_list>
 <numeric> | <expr>

Suffix:

<Measurement> 1 to 8
Measurement

Query parameters:

<buffered_size> <expr>

<expected_value_or_source_list>
<numeric> | <expr>

<resolution_or_source_list>
<numeric> | <expr>

<source_list> <expr>

For the parameter descriptions, see ["Parameter list for continuous average measurements with buffering"](#) on page 252.

Usage: Query only

CONFigure<Measurement>:ARRAY[:POWER][:AVG]:REFLection? <buffered_size>[,
<expected_value_or_source_list>, <resolution_or_source_list>, <source_list>...]

FETCh<Measurement>:ARRAY[:POWER][:AVG]:REFLection? <buffered_size>[,
<expected_value_or_source_list>, <resolution_or_source_list>, <source_list>...]

READ<Measurement>:ARRAY[:POWER][:AVG]:REFLection? <buffered_size>[,
<expected_value_or_source_list>, <resolution_or_source_list>, <source_list>...]

MEASure<Measurement>:ARRAY[:POWER][:AVG]:REFLection? <buffered_size>[,
<expected_value_or_source_list>, <resolution_or_source_list>, <source_list>...]

Reflection coefficient/transmission factor of a DUT, measured by two power sensors with buffering.

Suffix:

<Measurement> 1 to 8
Measurement

Query parameters:

<buffered_size> <expr>

<expected_value_or_source_list>
<numeric> | <expr>

<resolution_or_source_list>
<numeric> | <expr>

<source_list> <expr>

For the parameter descriptions, see ["Parameter list for continuous average measurements with buffering"](#) on page 252.

Usage: Query only

CONFigure<Measurement>:ARRAY[:POWER][:AVG]:RELative? <buffered_size>[,
<expected_value_or_source_list>, <resolution_or_source_list>, <source_list>...]

FETCh<Measurement>:ARRAY[:POWER][:AVG]:RELative? <buffered_size>[,
<expected_value_or_source_list>, <resolution_or_source_list>, <source_list>...]

READ<Measurement>:ARRay[:POWer][:AVG]:RELative? <buffered_size>[,
 <expected_value_or_source_list>, <resolution_or_source_list>, <source_list>...]

MEASure<Measurement>:ARRay[:POWer][:AVG]:RELative? <buffered_size>[,
 <expected_value_or_source_list>, <resolution_or_source_list>, <source_list>...]

Relative power measured by one power sensor with buffering.

Suffix:

<Measurement> 1 to 8
 Measurement

Query parameters:

<buffered_size> <expr>
 <expected_value_or_source_list>
 <numeric> | <expr>
 <resolution_or_source_list>
 <numeric> | <expr>
 <source_list> <expr>

For the parameter descriptions, see "[Parameter list for continuous average measurements with buffering](#)" on page 252.

Usage: Query only

CONFigure<Measurement>:ARRay[:POWer][:AVG]:RLOSs? <buffered_size>[,
 <expected_value_or_source_list>, <resolution_or_source_list>, <source_list>...]

FETCh<Measurement>:ARRay[:POWer][:AVG]:RLOSs? <buffered_size>[,
 <expected_value_or_source_list>, <resolution_or_source_list>, <source_list>...]

READ<Measurement>:ARRay[:POWer][:AVG]:RLOSs? <buffered_size>[,
 <expected_value_or_source_list>, <resolution_or_source_list>, <source_list>...]

MEASure<Measurement>:ARRay[:POWer][:AVG]:RLOSs? <buffered_size>[,
 <expected_value_or_source_list>, <resolution_or_source_list>, <source_list>...]

Return loss/transmission loss of a DUT, measured by two power sensors with buffering.

Suffix:

<Measurement> 1 to 8
 Measurement

Query parameters:

<buffered_size> <expr>
 <expected_value_or_source_list>
 <numeric> | <expr>
 <resolution_or_source_list>
 <numeric> | <expr>
 <source_list> <expr>

For the parameter descriptions, see "[Parameter list for continuous average measurements with buffering](#)" on page 252.

Usage: Query only

CONFigure<Measurement>:ARRAY[:POWER][:AVG]:SUM? <buffered_size>[,
 <expected_value_or_source_list>, <resolution_or_source_list>, <source_list>...]
FETCh<Measurement>:ARRAY[:POWER][:AVG]:SUM? <buffered_size>[,
 <expected_value_or_source_list>, <resolution_or_source_list>, <source_list>...]
READ<Measurement>:ARRAY[:POWER][:AVG]:SUM? <buffered_size>[,
 <expected_value_or_source_list>, <resolution_or_source_list>, <source_list>...]
MEASure<Measurement>:ARRAY[:POWER][:AVG]:SUM? <buffered_size>[,
 <expected_value_or_source_list>, <resolution_or_source_list>, <source_list>...]

Sum of the values measured by two power sensors with buffering.

Suffix:

<Measurement> 1 to 8
 Measurement

Query parameters:

<buffered_size> <expr>
 <expected_value_or_source_list>
 <numeric> | <expr>
 <resolution_or_source_list>
 <numeric> | <expr>
 <source_list> <expr>

For the parameter descriptions, see ["Parameter list for continuous average measurements with buffering"](#) on page 252.

Usage: Query only

CONFigure<Measurement>:ARRAY[:POWER][:AVG]:SUM:RELative?
 <buffered_size>[, <expected_value_or_source_list>,
 <resolution_or_source_list>, <source_list>...]
FETCh<Measurement>:ARRAY[:POWER][:AVG]:SUM:RELative? <buffered_size>[,
 <expected_value_or_source_list>, <resolution_or_source_list>, <source_list>...]
READ<Measurement>:ARRAY[:POWER][:AVG]:SUM:RELative? <buffered_size>[,
 <expected_value_or_source_list>, <resolution_or_source_list>, <source_list>...]
MEASure<Measurement>:ARRAY[:POWER][:AVG]:SUM:RELative?
 <buffered_size>[, <expected_value_or_source_list>,
 <resolution_or_source_list>, <source_list>...]

Relative sum measured by two power sensors with buffering.

Suffix:

<Measurement> 1 to 8
 Measurement

Query parameters:

<buffered_size> <expr>
 <expected_value_or_source_list>
 <numeric> | <expr>
 <resolution_or_source_list>
 <numeric> | <expr>

<source_list> <expr>

For the parameter descriptions, see "[Parameter list for continuous average measurements with buffering](#)" on page 252.

Usage: Query only

CONFigure<Measurement>:ARRay[:POWer][:AVG]:SWR? <buffered_size>[,
 <expected_value_or_source_list>, <resolution_or_source_list>, <source_list>...]

FETCh<Measurement>:ARRay[:POWer][:AVG]:SWR? <buffered_size>[,
 <expected_value_or_source_list>, <resolution_or_source_list>, <source_list>...]

READ<Measurement>:ARRay[:POWer][:AVG]:SWR? <buffered_size>[,
 <expected_value_or_source_list>, <resolution_or_source_list>, <source_list>...]

MEASure<Measurement>:ARRay[:POWer][:AVG]:SWR? <buffered_size>[,
 <expected_value_or_source_list>, <resolution_or_source_list>, <source_list>...]

Standing wave ratio measurement of two power sensors with buffering.

Suffix:

<Measurement> 1 to 8
 Measurement

Query parameters:

<buffered_size> <expr>

<expected_value_or_source_list>
 <numeric> | <expr>

<resolution_or_source_list>
 <numeric> | <expr>

<source_list> <expr>

For the parameter descriptions, see "[Parameter list for continuous average measurements with buffering](#)" on page 252.

Usage: Query only

13.6.6.3 Lower-level continuous average commands

See also [Chapter 13.4.4, "Configuring one setting at a time"](#), on page 190.

[SENSe<Sensor>:][POWer:][AVG:]BUFFer:CLEar.....	258
[SENSe<Sensor>:][POWer:][AVG:]BUFFer:COUNT?	259
[SENSe<Sensor>:][POWer:][AVG:]BUFFer:INFO?	259
[SENSe<Sensor>:][POWer:][AVG:]BUFFer:SIZE.....	259
[SENSe<Sensor>:][POWer:][AVG:]BUFFer:STATE.....	260

[SENSe<Sensor>:][POWer:][AVG:]BUFFer:CLEar

Effective for continuous average measurements.

Clears the contents of the result buffer.

Suffix:

<Sensor>

1 to 128

Configured sensor connected at: port A = 1, ... , port D = 4, R&S NRX-B9 = 101, USB and LAN port = 5 to 100

Usage:

Event

[SENSe<Sensor>:][POWER:][AVG:]BUFFer:COUNT?

Effective for continuous average measurements.

Queries the number of results that are currently stored in the result buffer.

Suffix:

<Sensor>

1 to 128

Configured sensor connected at: port A = 1, ... , port D = 4, R&S NRX-B9 = 101, USB and LAN port = 5 to 100

Usage:

Query only

[SENSe<Sensor>:][POWER:][AVG:]BUFFer:INFO? [<ITEM>]

Effective for continuous average measurements.

Suffix:

<Sensor>

1 to 128

Configured sensor connected at: port A = 1, ... , port D = 4, R&S NRX-B9 = 101, USB and LAN port = 5 to 100

Query parameters:

<ITEM>

Usage:

Query only

[SENSe<Sensor>:][POWER:][AVG:]BUFFer:SIZE <count>

Effective for continuous average measurements.

Sets the size of the result buffer.

You can enable the buffer using `[SENSe<Sensor>:] [POWER:] [AVG:]BUFFer:STATE`.**Suffix:**

<Sensor>

1 to 128

Configured sensor connected at: port A = 1, ... , port D = 4, R&S NRX-B9 = 101, USB and LAN port = 5 to 100

Parameters:

<count>

Range: 1 to 131072

*RST: 1

[SENSe<Sensor>:][POWer:][AVG:]BUFFer:STATe <state>

Enables or disables the buffered continuous average measurement. If enabled, all results generated by trigger events are collected until the buffer is filled. Thus, a higher data rate is achieved.

You can set the size of the buffer with `[SENSe<Sensor>:] [POWer:] [AVG:] BUFFer:SIZE`.

Suffix:

<Sensor> 1 to 128
Configured sensor connected at: port A = 1, ... , port D = 4, R&S NRX-B9 = 101, USB and LAN port = 5 to 100

Parameters:

<state> ON | OFF
*RST: OFF

13.6.7 Burst average measurements

There are several ways to programm the R&S NRX for measurements. See [Chapter 13.4, "Making measurements"](#), on page 188.

Further information:

- [Chapter 6.3, "Burst average"](#), on page 74

13.6.7.1 Combining commands for burst average measurements

Parameter list for burst average measurements

Parameter	Description
<dtolerance>	Mandatory. Length of a time interval during that the power level can drop below the trigger level without being interpreted as end of the power pulse. Corresponds to <code>[SENSe<Sensor>:] [POWer:] BURSt:DTOLerance</code> .
<start_exclude>	Mandatory. Amount of time at the beginning of a timeslot or integration period that is not evaluated. Corresponds to <code>[SENSe<Sensor>:] TIMing:EXCLude:START</code> .
<end_exclude>	Mandatory. Amount of time at the end of a timeslot or integration period that is not evaluated. Corresponds to <code>[SENSe<Sensor>:] TIMing:EXCLude:STOP</code> .
<expected_value>	Optional. Value that is expected for the measurement.

Parameter	Description
<resolution>	Optional. Limit up to which the measurement result probably is free of noise. Corresponds to <code>[SENSe<Sensor>:]AVERage:COUNT:AUTO:RESolution</code> .
<source_list>	Mandatory. Primary and secondary sensor. The number for each sensor is preceded by the character @. The entire expression is enclosed in parentheses. Example: <code>(@3),(@2)</code> Sensor C is the primary sensor, and sensor B is the secondary sensor.

CONFigure<Measurement>[:SCALar][:POWER]:BURSt? <dtolerance>, <start_exclude>, <end_exclude>[, <expected_value_or_source_list>, <resolution_or_source_list>, <source_list>...]

FETCh<Measurement>[:SCALar][:POWER]:BURSt? <dtolerance>, <start_exclude>, <end_exclude>[, <expected_value_or_source_list>, <resolution_or_source_list>, <source_list>...]

READ<Measurement>[:SCALar][:POWER]:BURSt? <dtolerance>, <start_exclude>, <end_exclude>[, <expected_value_or_source_list>, <resolution_or_source_list>, <source_list>...]

MEASure<Measurement>[:SCALar][:POWER]:BURSt? <dtolerance>, <start_exclude>, <end_exclude>[, <expected_value_or_source_list>, <resolution_or_source_list>, <source_list>...]

Power measured by one power sensor.

Suffix:

<Measurement> 1 to 8
Measurement

Query parameters:

<dtolerance> Default unit: s

<start_exclude> Default unit: s

<end_exclude> Default unit: s

<expected_value_or_source_list>
 <numeric> | <expr>

<resolution_or_source_list>
 <numeric> | <expr>

<source_list> <expr>

For the parameter descriptions, see [Chapter 13.6.7.1, "Combining commands for burst average measurements"](#), on page 260.

Usage: Query only

CONFigure<Measurement>[:SCALar][:POWer]:BURSt:RELative? <dtolerance>, <start_exclude>, <end_exclude>[, <expected_value_or_source_list>, <resolution_or_source_list>, <source_list>...]

FETCh<Measurement>[:SCALar][:POWer]:BURSt:RELative? <dtolerance>, <start_exclude>, <end_exclude>[, <expected_value_or_source_list>, <resolution_or_source_list>, <source_list>...]

READ<Measurement>[:SCALar][:POWer]:BURSt:RELative? <dtolerance>, <start_exclude>, <end_exclude>[, <expected_value_or_source_list>, <resolution_or_source_list>, <source_list>...]

MEASure<Measurement>[:SCALar][:POWer]:BURSt:RELative? <dtolerance>, <start_exclude>, <end_exclude>[, <expected_value_or_source_list>, <resolution_or_source_list>, <source_list>...]

Relative power measured by one power sensors.

Suffix:

<Measurement> 1 to 8
 Measurement

Query parameters:

<dtolerance> Default unit: s

<start_exclude> Default unit: s

<end_exclude> Default unit: s

<expected_value_or_source_list>
 <numeric> | <expr>

<resolution_or_source_list>
 <numeric> | <expr>

<source_list> <expr>

For the parameter descriptions, see [Chapter 13.6.7.1, "Combining commands for burst average measurements"](#), on page 260.

Usage: Query only

CONFigure<Measurement>[:SCALar][:POWer]:BURSt:DIFFerence? <dtolerance>, <start_exclude>, <end_exclude>[, <expected_value_or_source_list>, <resolution_or_source_list>, <source_list>...]

FETCh<Measurement>[:SCALar][:POWer]:BURSt:DIFFerence? <dtolerance>, <start_exclude>, <end_exclude>[, <expected_value_or_source_list>, <resolution_or_source_list>, <source_list>...]

READ<Measurement>[:SCALar][:POWer]:BURSt:DIFFerence? <dtolerance>, <start_exclude>, <end_exclude>[, <expected_value_or_source_list>, <resolution_or_source_list>, <source_list>...]

MEASure<Measurement>[:SCALar][:POWer]:BURSt:DIFFerence? <dtolerance>, <start_exclude>, <end_exclude>[, <expected_value_or_source_list>, <resolution_or_source_list>, <source_list>...]

Difference measured by two power sensors.

Suffix:

<Measurement> 1 to 8
Measurement

Query parameters:

<dtolerance> Default unit: s
 <start_exclude> Default unit: s
 <end_exclude> Default unit: s
 <expected_value_or_source_list>
 <numeric> | <expr>
 <resolution_or_source_list>
 <numeric> | <expr>
 <source_list> <expr>

For the parameter descriptions, see [Chapter 13.6.7.1, "Combining commands for burst average measurements"](#), on page 260.

Usage: Query only

CONFIGure<Measurement>[:SCALar][:POWER]:BURSt:DIFFerence:RELative?

<dtolerance>, <start_exclude>, <end_exclude>[,
 <expected_value_or_source_list>, <resolution_or_source_list>, <source_list>...]

FETCH<Measurement>[:SCALar][:POWER]:BURSt:DIFFerence:RELative?

<dtolerance>, <start_exclude>, <end_exclude>[,
 <expected_value_or_source_list>, <resolution_or_source_list>, <source_list>...]

READ<Measurement>[:SCALar][:POWER]:BURSt:DIFFerence:RELative?

<dtolerance>, <start_exclude>, <end_exclude>[,
 <expected_value_or_source_list>, <resolution_or_source_list>, <source_list>...]

MEASure<Measurement>[:SCALar][:POWER]:BURSt:DIFFerence:RELative?

<dtolerance>, <start_exclude>, <end_exclude>[,
 <expected_value_or_source_list>, <resolution_or_source_list>, <source_list>...]

Relative difference measured by two power sensors.

Suffix:

<Measurement> 1 to 8
Measurement

Query parameters:

<dtolerance> Default unit: s
 <start_exclude> Default unit: s
 <end_exclude> Default unit: s
 <expected_value_or_source_list>
 <numeric> | <expr>
 <resolution_or_source_list>
 <numeric> | <expr>

<source_list> <expr>

For the parameter descriptions, see [Chapter 13.6.7.1, "Combining commands for burst average measurements"](#), on page 260.

Usage: Query only

CONFigure<Measurement>[:SCALar][:POWer]:BURSt:SUM? <dtolerance>, <start_exclude>, <end_exclude>[, <expected_value_or_source_list>, <resolution_or_source_list>, <source_list>...]

FETCh<Measurement>[:SCALar][:POWer]:BURSt:SUM? <dtolerance>, <start_exclude>, <end_exclude>[, <expected_value_or_source_list>, <resolution_or_source_list>, <source_list>...]

READ<Measurement>[:SCALar][:POWer]:BURSt:SUM? <dtolerance>, <start_exclude>, <end_exclude>[, <expected_value_or_source_list>, <resolution_or_source_list>, <source_list>...]

MEASure<Measurement>[:SCALar][:POWer]:BURSt:SUM? <dtolerance>, <start_exclude>, <end_exclude>[, <expected_value_or_source_list>, <resolution_or_source_list>, <source_list>...]

Sum measured by two power sensors.

Suffix:

<Measurement> 1 to 8
Measurement

Query parameters:

<dtolerance> Default unit: s

<start_exclude> Default unit: s

<end_exclude> Default unit: s

<expected_value_or_source_list>
 <numeric> | <expr>

<resolution_or_source_list>
 <numeric> | <expr>

<source_list> <expr>

For the parameter descriptions, see [Chapter 13.6.7.1, "Combining commands for burst average measurements"](#), on page 260.

Usage: Query only

CONFigure<Measurement>[:SCALar][:POWer]:BURSt:SUM:RELative? <dtolerance>, <start_exclude>, <end_exclude>[, <expected_value_or_source_list>, <resolution_or_source_list>, <source_list>...]

FETCh<Measurement>[:SCALar][:POWer]:BURSt:SUM:RELative? <dtolerance>, <start_exclude>, <end_exclude>[, <expected_value_or_source_list>, <resolution_or_source_list>, <source_list>...]

READ<Measurement>[:SCALar][:POWer]:BURSt:SUM:RELative? <dtolerance>, <start_exclude>, <end_exclude>[, <expected_value_or_source_list>, <resolution_or_source_list>, <source_list>...]

MEASure<Measurement>[:SCALar][:POWer]:BURSt:SUM:RELative? <dtolerance>, <start_exclude>, <end_exclude>[, <expected_value_or_source_list>, <resolution_or_source_list>, <source_list>...]

Sum measured by two power sensors.

Suffix:

<Measurement> 1 to 8
Measurement

Query parameters:

<dtolerance> Default unit: s
<start_exclude> Default unit: s
<end_exclude> Default unit: s
<expected_value_or_source_list>
<numeric> | <expr>
<resolution_or_source_list>
<numeric> | <expr>
<source_list> <expr>

For the parameter descriptions, see [Chapter 13.6.7.1, "Combining commands for burst average measurements"](#), on page 260.

Usage: Query only

CONFigure<Measurement>[:SCALar][:POWer]:BURSt:RATio? <dtolerance>, <start_exclude>, <end_exclude>[, <expected_value_or_source_list>, <resolution_or_source_list>, <source_list>...]

FETCh<Measurement>[:SCALar][:POWer]:BURSt:RATio? <dtolerance>, <start_exclude>, <end_exclude>[, <expected_value_or_source_list>, <resolution_or_source_list>, <source_list>...]

READ<Measurement>[:SCALar][:POWer]:BURSt:RATio? <dtolerance>, <start_exclude>, <end_exclude>[, <expected_value_or_source_list>, <resolution_or_source_list>, <source_list>...]

MEASure<Measurement>[:SCALar][:POWer]:BURSt:RATio? <dtolerance>, <start_exclude>, <end_exclude>[, <expected_value_or_source_list>, <resolution_or_source_list>, <source_list>...]

Ratio measured by two power sensors.

Suffix:

<Measurement> 1 to 8
Measurement

Query parameters:

<dtolerance> Default unit: s
<start_exclude> Default unit: s

<end_exclude> Default unit: s

<expected_value_or_source_list>
 <numeric> | <expr>

<resolution_or_source_list>
 <numeric> | <expr>

<source_list> <expr>

For the parameter descriptions, see [Chapter 13.6.7.1, "Combining commands for burst average measurements"](#), on page 260.

Usage: Query only

CONFigure<Measurement>[:SCALar][:POWer]:BURSt:RATio:RELative?
 <dtolerance>, <start_exclude>, <end_exclude>[,
 <expected_value_or_source_list>, <resolution_or_source_list>, <source_list>...]

FETCh<Measurement>[:SCALar][:POWer]:BURSt:RATio:RELative? <dtolerance>,
 <start_exclude>, <end_exclude>[, <expected_value_or_source_list>,
 <resolution_or_source_list>, <source_list>...]

READ<Measurement>[:SCALar][:POWer]:BURSt:RATio:RELative? <dtolerance>,
 <start_exclude>, <end_exclude>[, <expected_value_or_source_list>,
 <resolution_or_source_list>, <source_list>...]

MEASure<Measurement>[:SCALar][:POWer]:BURSt:RATio:RELative?
 <dtolerance>, <start_exclude>, <end_exclude>[,
 <expected_value_or_source_list>, <resolution_or_source_list>, <source_list>...]

Relative ratio measured by two power sensors.

Suffix:

<Measurement> 1 to 8
 Measurement

Query parameters:

<dtolerance> Default unit: s

<start_exclude> Default unit: s

<end_exclude> Default unit: s

<expected_value_or_source_list>
 <numeric> | <expr>

<resolution_or_source_list>
 <numeric> | <expr>

<source_list> <expr>

For the parameter descriptions, see [Chapter 13.6.7.1, "Combining commands for burst average measurements"](#), on page 260.

Usage: Query only

CONFigure<Measurement>[:SCALar][:POWer]:BURSt:SWR? <dtolerance>, <start_exclude>, <end_exclude>[, <expected_value_or_source_list>, <resolution_or_source_list>, <source_list>...]

FETCh<Measurement>[:SCALar][:POWer]:BURSt:SWR? <dtolerance>, <start_exclude>, <end_exclude>[, <expected_value_or_source_list>, <resolution_or_source_list>, <source_list>...]

READ<Measurement>[:SCALar][:POWer]:BURSt:SWR? <dtolerance>, <start_exclude>, <end_exclude>[, <expected_value_or_source_list>, <resolution_or_source_list>, <source_list>...]

MEASure<Measurement>[:SCALar][:POWer]:BURSt:SWR? <dtolerance>, <start_exclude>, <end_exclude>[, <expected_value_or_source_list>, <resolution_or_source_list>, <source_list>...]

Standing wave ratio, measured by two power sensors.

Suffix:

<Measurement> 1 to 8
Measurement

Query parameters:

<dtolerance> Default unit: s

<start_exclude> Default unit: s

<end_exclude> Default unit: s

<expected_value_or_source_list>
 <numeric> | <expr>

<resolution_or_source_list>
 <numeric> | <expr>

<source_list> <expr>

For the parameter descriptions, see [Chapter 13.6.7.1, "Combining commands for burst average measurements"](#), on page 260.

Usage: Query only

CONFigure<Measurement>[:SCALar][:POWer]:BURSt:REFlection? <dtolerance>, <start_exclude>, <end_exclude>[, <expected_value_or_source_list>, <resolution_or_source_list>, <source_list>...]

FETCh<Measurement>[:SCALar][:POWer]:BURSt:REFlection? <dtolerance>, <start_exclude>, <end_exclude>[, <expected_value_or_source_list>, <resolution_or_source_list>, <source_list>...]

READ<Measurement>[:SCALar][:POWer]:BURSt:REFlection? <dtolerance>, <start_exclude>, <end_exclude>[, <expected_value_or_source_list>, <resolution_or_source_list>, <source_list>...]

MEASure<Measurement>[:SCALar][:POWer]:BURSt:REFlection? <dtolerance>, <start_exclude>, <end_exclude>[, <expected_value_or_source_list>, <resolution_or_source_list>, <source_list>...]

Reflection coefficient/transmission factor of a DUT, measured by two power sensors.

Suffix:

<Measurement> 1 to 8
Measurement

Query parameters:

<dtolerance> Default unit: s
 <start_exclude> Default unit: s
 <end_exclude> Default unit: s
 <expected_value_or_source_list>
 <numeric> | <expr>
 <resolution_or_source_list>
 <numeric> | <expr>
 <source_list> <expr>

For the parameter descriptions, see [Chapter 13.6.7.1, "Combining commands for burst average measurements"](#), on page 260.

Usage: Query only

CONFigure<Measurement>[:SCALar][:POWer]:BURSt:RLOSs? <dtolerance>,
 <start_exclude>, <end_exclude>[, <expected_value_or_source_list>,
 <resolution_or_source_list>, <source_list>...]

FETCh<Measurement>[:SCALar][:POWer]:BURSt:RLOSs? <dtolerance>,
 <start_exclude>, <end_exclude>[, <expected_value_or_source_list>,
 <resolution_or_source_list>, <source_list>...]

READ<Measurement>[:SCALar][:POWer]:BURSt:RLOSs? <dtolerance>,
 <start_exclude>, <end_exclude>[, <expected_value_or_source_list>,
 <resolution_or_source_list>, <source_list>...]

MEASure<Measurement>[:SCALar][:POWer]:BURSt:RLOSs? <dtolerance>,
 <start_exclude>, <end_exclude>[, <expected_value_or_source_list>,
 <resolution_or_source_list>, <source_list>...]

Return loss/transmission loss of a DUT, measured by two power sensors.

Suffix:

<Measurement> 1 to 8
Measurement

Query parameters:

<dtolerance> Default unit: s
 <start_exclude> Default unit: s
 <end_exclude> Default unit: s
 <expected_value_or_source_list>
 <numeric> | <expr>
 <resolution_or_source_list>
 <numeric> | <expr>

<source_list> <expr>

For the parameter descriptions, see [Chapter 13.6.7.1, "Combining commands for burst average measurements"](#), on page 260.

Usage: Query only

13.6.8 Trace measurements

There are several ways to program the R&S NRX for measurements. See [Chapter 13.4, "Making measurements"](#), on page 188.

Further information:

- [Chapter 6.4, "Trace"](#), on page 76

13.6.8.1 Combining commands for trace measurements

See also [Chapter 13.4, "Making measurements"](#), on page 188.

Parameter list for trace measurements

Parameter	Description
<scope_size>	Mandatory. Number of test points on the time axis. Corresponds to [SENSe<Sensor>:]TRACe:POINts on page 462.
<capture_time>	Mandatory. Period within which measured data are captured in the trace measurements. Corresponds to [SENSe<Sensor>:]TRACe:TIME on page 216.
<source_list>	Mandatory. Primary and secondary sensor. The number for each sensor is preceded by the character @. The entire expression is enclosed in parentheses. Example: (@3),(@2) Sensor C is the primary sensor, and sensor B is the secondary sensor.

**CONFigure<Measurement>:XTIME[:POWER]? <scope_size>, <capture_time>,
<source_list>**

**FETCh<Measurement>:XTIME[:POWER]? <scope_size>, <capture_time>,
<source_list>**

**READ<Measurement>:XTIME[:POWER]? <scope_size>, <capture_time>,
<source_list>**

**MEASure<Measurement>:XTIME[:POWER]? <scope_size>, <capture_time>,
<source_list>**

Used to measure power over time.

Suffix:

<Measurement> 1 to 8
 Measurement

Query parameters:

<scope_size> <expr>

<capture_time> Default unit: s
 <source_list> <expr>
 For the parameter descriptions, see ["Parameter list for trace measurements"](#) on page 269.

Usage: Query only

CONFigure<Measurement>:XTIME[:POWER]:NONE <scope_size>, <capture_time>, <source_list>

Disables trace 2. In contrast, trace 1 is always active.

Suffix:

<Measurement> 1 to 8
 Measurement

Setting parameters:

<scope_size> <expr>
 <capture_time> Default unit: s
 <source_list> <expr>
 For the parameter descriptions, see ["Parameter list for trace measurements"](#) on page 269.

Usage: Setting only

CONFigure<Measurement>:XTIME[:POWER]:RATio? <scope_size>, <capture_time>, <source_list>

FETCh<Measurement>:XTIME[:POWER]:RATio? <scope_size>, <capture_time>, <source_list>

READ<Measurement>:XTIME[:POWER]:RATio? <scope_size>, <capture_time>, <source_list>

MEASure<Measurement>:XTIME[:POWER]:RATio? <scope_size>, <capture_time>, <source_list>

Power ratio over time measured by two power sensors.

Suffix:

<Measurement> 1 to 8
 Measurement

Query parameters:

<scope_size> <expr>
 <capture_time> Default unit: s
 <source_list> <expr>
 For the parameter descriptions, see ["Parameter list for trace measurements"](#) on page 269.

Usage: Query only

13.6.8.2 Lower-level trace commands

See also [Chapter 13.4.4, "Configuring one setting at a time"](#), on page 190.

CALCulate<Measurement>:TRACe:X:POINts	271
[SENSe<Sensor>:]TRACe:REALtime	271

CALCulate<Measurement>:TRACe:X:POINts <points>

Sets the number of required values per trace sequence.

Suffix:

<Measurement> 1 to 8
Measurement

Parameters:

<points> Range: 1 to 8192
 *RST: 660

[SENSe<Sensor>:]TRACe:REALtime <state>

Effective for trace measurements.

If disabled, each measurement from the power sensor is averaged. If enabled, only one sampling sequence per measurement is recorded, thus increasing the measurement speed. With a higher measurement speed, the measured values of an individual measurement are immediately delivered.

Suffix:

<Sensor> 1 to 128
Configured sensor connected at: port A = 1, ... , port D = 4, R&S
NRX-B9 = 101, USB and LAN port = 5 to 100

Parameters:

<state> ON | OFF
*RST: OFF

13.6.8.3 Using markers

CALCulate<Measurement>:TRACe:MARKer<Marker>:XDELta?	272
CALCulate<Measurement>:TRACe:MARKer<Marker>:YDELta?	272
CALCulate<Measurement>:TRACe:MARKer<Marker>:YPOSition?	272
DISPlay[:WINDow<Window>]:TRACe:MARKer<Marker>:FEED:INDex	272
DISPlay[:WINDow<Window>]:TRACe:MARKer<Marker>:FUNCTion	273
DISPlay[:WINDow<Window>]:TRACe:MARKer<Marker>:MODE	274
DISPlay[:WINDow<Window>]:TRACe:MARKer<Marker>:POSition:MODE	274
DISPlay[:WINDow<Window>]:TRACe:MARKer<Marker>:POSition:POWER:DBM	275
DISPlay[:WINDow<Window>]:TRACe:MARKer<Marker>:POSition:POWER:DBUV	275
DISPlay[:WINDow<Window>]:TRACe:MARKer<Marker>:POSition:RELative:POWER:DB	276
DISPlay[:WINDow<Window>]:TRACe:MARKer<Marker>:POSition:POWER:RATio:DB	276
DISPlay[:WINDow<Window>]:TRACe:MARKer<Marker>:POSition:RELative:POWER:DPCT ..	276
DISPlay[:WINDow<Window>]:TRACe:MARKer<Marker>:POSition:POWER:RATio:DPCT	276

DISPlay[:WINDow<Window>]:TRACe:MARKer<Marker>:POSition:RELative:POWer:O.....	277
DISPlay[:WINDow<Window>]:TRACe:MARKer<Marker>:POSition:POWer:RATio:O.....	277
DISPlay[:WINDow<Window>]:TRACe:MARKer<Marker>:POSition:RELative:POWer:WATT..	277
DISPlay[:WINDow<Window>]:TRACe:MARKer<Marker>:POSition:POWer:WATT.....	277
DISPlay[:WINDow<Window>]:TRACe:MARKer<Marker>:POSition:RELative:TIME.....	278
DISPlay[:WINDow<Window>]:TRACe:MARKer<Marker>:POSition:TIME.....	278
DISPlay[:WINDow<Window>]:TRACe:MARKer<Marker>:REFerence.....	278
DISPlay[:WINDow<Window>]:TRACe:MARKer<Undef>:SELECTION.....	278

CALCulate<Measurement>:TRACe:MARKer<Marker>:XDELta?

Queries the time difference between two markers.

Suffix:

<Measurement>	1 to 8 Measurement
<Marker>	1 to 4 Marker (M1 to M4)

Usage: Query only

CALCulate<Measurement>:TRACe:MARKer<Marker>:YDELta?

Queries the power difference between two markers.

Suffix:

<Measurement>	1 to 8 Measurement
<Marker>	1 to 4 Marker (M1 to M4)

Usage: Query only

CALCulate<Measurement>:TRACe:MARKer<Marker>:YPOSITION?

Queries the position of a marker on the power axis.

Suffix:

<Measurement>	1 to 8 Measurement
<Marker>	1 to 4 Marker (M1 to M4)

Usage: Query only

DISPlay[:WINDow<Window>]:TRACe:MARKer<Marker>:FEED:INDEX <index>

Effective if `DISPlay[:WINDow<Window>]:TRACe:MARKer<Marker>:MODE`
MEASure is set.

Selects the trace.

Suffix:

<Window> 1 to 4
Measurement pane

<Marker> 1 to 4
Marker (M1 to M4)

Parameters:

<index> **0**
No trace selected.

1
Trace 1

2
Trace 2

Range: 0 to 2
*RST: 0

Manual operation: See "[Data Source](#)" on page 81

DISPlay[:WINDow<Window>]:TRACe:MARKer<Marker>:FUNCTion <function>

Effective if `DISPlay[:WINDow<Window>]:TRACe:MARKer<Marker>:MODE`
`MEASure` is set.

Defines the measurement.

Suffix:

<Window> 1 to 4
Measurement pane

<Marker> 1 to 4
Marker (M1 to M4)

Parameters:

<function> POWER | RPOWER | RTIME | RPAverage

POWER

Measures the power of the trace.

RPOWER

Measures the power ratio in relation to the reference marker.

RTIME

Measures the time difference in relation to the reference marker.

RPAverage

Measures the average power between time positions of the
marker and its reference marker.

*RST: POWER

Manual operation: See "[Measurement Mode](#)" on page 81

DISPlay[:WINDow<Window>]:TRACe:MARKer<Marker>:MODE <mode>

Enables or disables the marker. Also defines the appearance of the marker.

Suffix:

<Window>	1 to 4 Measurement pane
<Marker>	1 to 4 Marker (M1 to M4)

Parameters:

<mode> OFF | RULer | MEASure

OFF

Disables the marker.

RULer

Shows a line at the marker position. Useful if you use the marker as reference marker, [DISPlay\[:WINDow<Window>\]:TRACe:MARKer<Marker>:REFerence](#).

MEASure

Shows a triangle at the marker position.

*RST: OFF

Manual operation: See "[Marker Mode](#)" on page 79

DISPlay[:WINDow<Window>]:TRACe:MARKer<Marker>:POSition:MODE <mode>

Defines where the marker is placed.

Suffix:

<Window>	1 to 4 Measurement pane
<Marker>	1 to 4 Marker (M1 to M4)

Parameters:

<mode> FTIME | FPOWer | RPOSition | RPOWer | RPLeft | RPRight | PSEarch | MSEarch | RPSLeft | RPSRight | RMSLeft | RMSRight

FTIME

At a fixed time, set by the marker position.

FPOWer

At a fixed power value, set by the marker position.

RPOSition

At a time difference of the marker position to the x-position of the reference marker.

RPOWer

At a power difference of the marker position to the y-position of the reference marker.

RPLeft

Starting from the left border, at a power difference of the marker position to the y-position of the reference marker.

RPRight

Starting from the right border, at a power difference of the marker position to the y-position of the reference marker.

PSEarch

Measured maximum power

MSEarch

Measured minimum power

RPSLeft

Maximum power measured left from the reference marker.

RPSRight

Maximum power measured right from the reference marker.

RMSLeft

Minimum power measured left from the reference marker.

RMSRight

Minimum power measured right from the reference marker.

*RST: FTIMe

Manual operation: See "[Position Mode](#)" on page 79

DISPlay[:WINDow<Window>]:TRACe:MARKer<Marker>:POSition:POWer:DBM
<power>

Sets an absolute power value for the marker position defined under [DISPlay\[:WINDow<Window>\]:TRACe:MARKer<Marker>:POSition:MODE](#) on page 274.

Suffix:

<Window>	1 to 4 Measurement pane
<Marker>	1 to 4 Measurement pane

Parameters:

<power>	Range: -200.0 to 200.0
	*RST: 0.0
	Default unit: dBm

Manual operation: See "[Position](#)" on page 80

DISPlay[:WINDow<Window>]:TRACe:MARKer<Marker>:POSition:POWer:DBUV
<power>

Sets an absolute power value for the marker position defined under [DISPlay\[:WINDow<Window>\]:TRACe:MARKer<Marker>:POSition:MODE](#) on page 274.

Suffix:

<Window> 1 to 4
Measurement pane

<Marker> 1 to 4
Marker (M1 to M4)

Parameters:

<power> Range: -100.0 to 300.0
*RST: 0.0
Default unit: dBuV

Manual operation: See "[Position](#)" on page 80

**DISPlay[:WINDow<Window>]:TRACe:MARKer<Marker>:POSition:RELative:
POWER:DB <power>**

**DISPlay[:WINDow<Window>]:TRACe:MARKer<Marker>:POSition:POWER:RATio:
DB <power>**

Sets an absolute or relative power value for the marker position defined under [DISPlay\[:WINDow<Window>\]:TRACe:MARKer<Marker>:POSition:MODE](#) on page 274.

Suffix:

<Window> 1 to 4
Measurement pane

<Marker> 1 to 4
Marker (M1 to M4)

Parameters:

<power> Range: -200.0 to 200.0
*RST: 0.0
Default unit: dB

Manual operation: See "[Position](#)" on page 80

**DISPlay[:WINDow<Window>]:TRACe:MARKer<Marker>:POSition:RELative:
POWER:DPCT <power>**

**DISPlay[:WINDow<Window>]:TRACe:MARKer<Marker>:POSition:POWER:RATio:
DPCT <power>**

Sets an absolute or relative value for the marker position defined under [DISPlay\[:WINDow<Window>\]:TRACe:MARKer<Marker>:POSition:MODE](#) on page 274.

Suffix:

<Window> 1 to 4
Measurement pane

<Marker> 1 to 4
Measurement pane

Parameters:

<power> Range: -1e18 to 1e18
 *RST: 0.0
 Default unit: dpct

Manual operation: See "[Position](#)" on page 80

**DISPlay[:WINDow<Window>]:TRACe:MARKer<Marker>:POSition:RELative:
 POWER:O <power>**

**DISPlay[:WINDow<Window>]:TRACe:MARKer<Marker>:POSition:POWER:RATio:
 O <power>**

Sets an absolute or relative value for the marker position defined under [DISPlay\[:WINDow<Window>\]:TRACe:MARKer<Marker>:POSition:MODE](#) on page 274.

Suffix:

<Window> 1 to 4
 Measurement pane

<Marker> 1 to 4
 Marker (M1 to M4)

Parameters:

<power> Range: -1e18 to 1e18
 *RST: 0.0
 Default unit: -

Manual operation: See "[Position](#)" on page 80

**DISPlay[:WINDow<Window>]:TRACe:MARKer<Marker>:POSition:RELative:
 POWER:WATT <power>**

**DISPlay[:WINDow<Window>]:TRACe:MARKer<Marker>:POSition:POWER:WATT
 <power>**

Sets an absolute or relative power value for the marker position defined under [DISPlay\[:WINDow<Window>\]:TRACe:MARKer<Marker>:POSition:MODE](#) on page 274.

Suffix:

<Window> 1 to 4
 Measurement pane

<Marker> 1 to 4
 Marker (M1 to M4)

Parameters:

<power> Range: -100e-3 to 1e12
 *RST: 1e-3
 Default unit: W

Manual operation: See "[Position](#)" on page 80

DISPlay[:WINDow<Window>]:TRACe:MARKer<Marker>:POSition:RELative:TIME
<time>

DISPlay[:WINDow<Window>]:TRACe:MARKer<Marker>:POSition:TIME <time>

Sets an absolute or relative time for the marker position defined under [DISPlay\[:WINDow<Window>\]:TRACe:MARKer<Marker>:POSition:MODE](#) on page 274.

Suffix:

<Window> 1 to 4
Measurement pane

<Marker> 1 to 4
Marker (M1 to M4)

Parameters:

<time> Range: -15.0 to 15.0
 *RST: 0.0
 Default unit: s

Manual operation: See "[Position](#)" on page 80

DISPlay[:WINDow<Window>]:TRACe:MARKer<Marker>:REFerence <reference>

Defines a marker as reference marker.

Suffix:

<Window> 1 to 4
Measurement pane

<Marker> 1 to 4
Marker (M1 to M4)

Parameters:

<reference> Range: 1 to 4
 *RST: 1

Manual operation: See "[Reference Marker](#)" on page 81

DISPlay[:WINDow<Window>]:TRACe:MARKer<Undef>:SELection <markerNo>

Shows the selected marker in the trace.

Suffix:

<Window> 1 to 4
Measurement pane

<Undef> 1 to n
No suffix required.

Parameters:

<markerNo> NONE | M1 | M2 | M3 | M4
 *RST: NONE

Manual operation: See "[M1 / M2 / M3 / M4](#)" on page 77

13.6.9 Pulse analysis measurements

Further information:

- Chapter 6.5, "Pulse analysis", on page 81

[SENSe<Sensor>:]TRACe:MEASurement[:STATe].....	280
[SENSe<Sensor>:]TRACe:MEASurement:AUTO[:STATe].....	280
[SENSe<Sensor>:]TRACe:MEASurement:OFFSet:TIME.....	280
[SENSe<Sensor>:]TRACe:MID:OFFSet:TIME.....	281
[SENSe<Sensor>:]TRACe:MID:TIME.....	281
CALCulate<Measurement>:TRACe:MEASurement:ALGorithm.....	281
CALCulate<Measurement>:TRACe:MEASurement:DEFine:DURation:REFerence.....	282
CALCulate<Measurement>:TRACe:MEASurement:DEFine:TRANSition:HREFerence.....	282
CALCulate<Measurement>:TRACe:MEASurement:DEFine:TRANSition:LREFerence.....	282
CALCulate<Measurement>:TRACe:MEASurement:POWER:AVG?.....	283
CALCulate<Measurement>:TRACe:MEASurement:POWER:HREFerence?.....	283
CALCulate<Measurement>:TRACe:MEASurement:POWER:LREFerence?.....	283
CALCulate<Measurement>:TRACe:MEASurement:POWER:MAX?.....	283
CALCulate<Measurement>:TRACe:MEASurement:POWER:MIN?.....	284
CALCulate<Measurement>:TRACe:MEASurement:POWER:PULSe:BASE?.....	284
CALCulate<Measurement>:TRACe:MEASurement:POWER:PULSe:TOP?.....	284
CALCulate<Measurement>:TRACe:MEASurement:POWER:REFerence?.....	284
CALCulate<Measurement>:TRACe:MEASurement:PULSe:DCYClE?.....	285
CALCulate<Measurement>:TRACe:MEASurement:PULSe:DURation?.....	285
CALCulate<Measurement>:TRACe:MEASurement:PULSe:PERiod?.....	285
CALCulate<Measurement>:TRACe:MEASurement:PULSe:SEPAration?.....	286
CALCulate<Measurement>:TRACe:MEASurement:TRANSition:NEGative:DURation?.....	286
CALCulate<Measurement>:TRACe:MEASurement:TRANSition:NEGative:OCCurrence?.....	286
CALCulate<Measurement>:TRACe:MEASurement:TRANSition:NEGative:OVERshoot?.....	286
CALCulate<Measurement>:TRACe:MEASurement:TRANSition:POSitive:DURation?.....	287
CALCulate<Measurement>:TRACe:MEASurement:TRANSition:POSitive:OCCurrence?.....	287
CALCulate<Measurement>:TRACe:MEASurement:TRANSition:POSitive:OVERshoot?.....	287
CALCulate<Measurement>:TRACe:MEASurement:TRANSition:SPERiod?.....	288
DISPlay[:WINDow<Window>]:TRACe:MEASurement:POWER:AVG[:STATe].....	288
DISPlay[:WINDow<Window>]:TRACe:MEASurement:POWER:MAXimum[:STATe].....	288
DISPlay[:WINDow<Window>]:TRACe:MEASurement:POWER:MINimum[:STATe].....	289
DISPlay[:WINDow<Window>]:TRACe:MEASurement:POWER:PULSe:BASE[:STATe].....	289
DISPlay[:WINDow<Window>]:TRACe:MEASurement:POWER:PULSe:HREFerence[:STATe]..	289
DISPlay[:WINDow<Window>]:TRACe:MEASurement:POWER:PULSe:LREFerence[:STATe]..	290
DISPlay[:WINDow<Window>]:TRACe:MEASurement:POWER:PULSe:TOP[:STATe].....	290
DISPlay[:WINDow<Window>]:TRACe:MEASurement:PULSe:DCYClE[:STATe].....	290
DISPlay[:WINDow<Window>]:TRACe:MEASurement:PULSe:DURation[:STATe].....	291
DISPlay[:WINDow<Window>]:TRACe:MEASurement:PULSe:PERiod[:STATe].....	291
DISPlay[:WINDow<Window>]:TRACe:MEASurement:PULSe:RESolution[:STATe].....	291
DISPlay[:WINDow<Window>]:TRACe:MEASurement:PULSe:SEPAration[:STATe].....	292
DISPlay[:WINDow<Window>]:TRACe:MEASurement:RRELation.....	292
DISPlay[:WINDow<Window>]:TRACe:MEASurement:SELection.....	292
DISPlay[:WINDow<Window>]:TRACe:MEASurement:TRANSition:NEGative:DURation[:STATe].....	293

DISPlay[:WINDow<Window>]:TRACe:MEASurement:TRANSition:NEGative: OCCurrence[:STATe].....	293
DISPlay[:WINDow<Window>]:TRACe:MEASurement:TRANSition:NEGative: OVERshoot[:STATe].....	293
DISPlay[:WINDow<Window>]:TRACe:MEASurement:TRANSition:POSitive:DURation[: STATe].....	294
DISPlay[:WINDow<Window>]:TRACe:MEASurement:TRANSition:POSitive: OCCurrence[:STATe].....	294
DISPlay[:WINDow<Window>]:TRACe:MEASurement:TRANSition:POSitive: OVERshoot[:STATe].....	294

[SENSe<Sensor>]:TRACe:MEASurement[:STATe] <value>

Enables or disables automatic pulse measurement. If enabled, the power sensor automatically determines the pulse parameters for the currently measured trace.

Suffix:

<Sensor> 1 to 128
Configured sensor connected at: port A = 1, ... , port D = 4, R&S
NRX-B9 = 101, USB and LAN port = 5 to 100

Parameters:

<value> ON | OFF
*RST: OFF

[SENSe<Sensor>]:TRACe:MEASurement:AUTO[:STATe] <value>

Enables or disables the automatic transfer of the measured pulse parameters after each trace. If enabled, the trace and pulse data are synchronously displayed in continuous measurement mode.

Suffix:

<Sensor> 1 to 128
Configured sensor connected at: port A = 1, ... , port D = 4, R&S
NRX-B9 = 101, USB and LAN port = 5 to 100

Parameters:

<value> *RST: OFF

[SENSe<Sensor>]:TRACe:MEASurement:OFFSet:TIME <value>

Sets the start time of the pulse analysis, referenced to delay set by
[TRIGger<Measurement>\[:CHANnel<Channel>\]:DElay\[:VALue\]](#).

By default, the parameters of the first detected pulse are determined. Using this command, you can determine parameters of another pulse. Make sure that the pulse analysis does not begin until shortly before this pulse.

Suffix:

<Sensor> 1 to 128
Configured sensor connected at: port A = 1, ... , port D = 4, R&S
NRX-B9 = 101, USB and LAN port = 5 to 100

Parameters:

<value> Default unit: s

[SENSe<Sensor>:]TRACe:MID:OFFSet:TIME <time>

Sets an offset to the start of the gate in which the pulse analysis is performed. See also [\[SENSe<Sensor>:\]TRACe:MID:TIME](#) on page 281.

Suffix:

<Sensor> 1 to 128
Configured sensor connected at: port A = 1, ... , port D = 4, R&S NRX-B9 = 101, USB and LAN port = 5 to 100

Parameters:

<time> Range: 0.0 to 30.0
 *RST: 0.01
 Default unit: s

[SENSe<Sensor>:]TRACe:MID:TIME <time>

Sets the length of the gate in which the pulse analysis is performed. The gate start is referenced to the trigger event.

Used to define a gate on a trace measurement, in which you want to perform a pulse analysis. If the gate length equals the length of the trace measurement, the first detected pulse is analyzed. Using a gate, you can investigate successive pulses.

Suffix:

<Sensor> 1 to 128
Configured sensor connected at: port A = 1, ... , port D = 4, R&S NRX-B9 = 101, USB and LAN port = 5 to 100

Parameters:

<time> Range: 0.0 to 30.0
 *RST: 0.01
 Default unit: s

CALCulate<Measurement>:TRACe:MEASurement:ALGorithm <value>

Effective for pulse analysis measurements.

Sets the analysis algorithm for detecting the pulse top and the pulse base power of a pulsed signal. From these two power levels, the reference levels are derived.

Suffix:

<Measurement> 1 to 8
 Measurement

Parameters:

<value> HISTogram | INTegration | PEAK
 *RST: HISTogram

Manual operation: See "[Algorithm](#)" on page 89

CALCulate<Measurement>:TRACe:MEASurement:DEFine:DURation:REFerence
 <value>

Effective for pulse analysis measurements.

Sets the pulse width, pulse start time and pulse stop time.

Suffix:

<Measurement> 1 to 8
 Measurement

Parameters:

<value> Range: 0.0 to 100.0
 *RST: 50.0
 Default unit: pct

Manual operation: See "[Reference Level](#)" on page 90

CALCulate<Measurement>:TRACe:MEASurement:DEFine:TRANSition:
HREFerence <value>

Effective for pulse analysis measurements.

Defines the end of the rising edge and the start of the falling edge of the pulse. Used for the measurement of the rise or fall time.

Suffix:

<Measurement> 1 to 8
 Measurement

Parameters:

<value> Range: 0.0 to 100.0
 *RST: 90.0
 Default unit: pct

Manual operation: See "[High Reference Level](#)" on page 90

CALCulate<Measurement>:TRACe:MEASurement:DEFine:TRANSition:
LREFerence <value>

Effective for pulse analysis measurements.

Defines the start of the rising edge and the end of the falling edge of the pulse. Used for the measurement of the rise or fall time.

Suffix:

<Measurement> 1 to 8
 Measurement

Parameters:

<value> Range: 0.0 to 100.0
 *RST: 10.0
 Default unit: pct

Manual operation: See "[Low Reference Level](#)" on page 90

CALCulate<Measurement>:TRACe:MEASurement:POWer:AVG?

Effective for pulse analysis measurements.

Queries the average power during the time the pulse is active.

Suffix:

<Measurement> 1 to 8
 Measurement

Usage: Query only

Manual operation: See "[Trace Avg](#)" on page 88

CALCulate<Measurement>:TRACe:MEASurement:POWer:HREFerence?

Effective for pulse analysis measurements.

Queries the power level at high reference level set by [CALCulate<Measurement>:TRACe:MEASurement:DEFine:TRANSition:HREFerence](#).

Suffix:

<Measurement> 1 to 8
 Measurement

Usage: Query only

Manual operation: See "[High Ref.](#)" on page 88

CALCulate<Measurement>:TRACe:MEASurement:POWer:LREFerence?

Effective for pulse analysis measurements.

Queries the power level at low reference level set by [CALCulate<Measurement>:TRACe:MEASurement:DEFine:TRANSition:LREFerence](#).

Suffix:

<Measurement> 1 to 8
 Measurement

Usage: Query only

Manual operation: See "[Low Ref.](#)" on page 88

CALCulate<Measurement>:TRACe:MEASurement:POWer:MAX?

Effective for pulse analysis measurements.

Queries the maximum power measured within the analysis window.

Suffix:

<Measurement> 1 to 8
 Measurement

Usage: Query only

Manual operation: See ["Trace Peak"](#) on page 87

CALCulate<Measurement>:TRACe:MEASurement:POWER:MIN?

Effective for pulse analysis measurements.

Queries the minimum power measured within the analysis window.

Suffix:

<Measurement> 1 to 8
Measurement

Usage: Query only

Manual operation: See ["Trace Min"](#) on page 88

CALCulate<Measurement>:TRACe:MEASurement:POWER:PULSe:BASE?

Effective for pulse analysis measurements.

Queries the pulse base power level detected by the selected [CALCulate<Measurement>:TRACe:MEASurement:ALGorithm](#). This value is used as a reference (0 %) to determine other parameter values such as the rising or falling thresholds.

Suffix:

<Measurement> 1 to 8
Measurement

Usage: Query only

Manual operation: See ["Pulse Base"](#) on page 88

CALCulate<Measurement>:TRACe:MEASurement:POWER:PULSe:TOP?

Effective for pulse analysis measurements.

Queries the pulse top power level detected by the selected [CALCulate<Measurement>:TRACe:MEASurement:ALGorithm](#). This value is used as a reference (100 %) to determine other parameter values such as the rising or falling thresholds.

Suffix:

<Measurement> 1 to 8
Measurement

Usage: Query only

Manual operation: See ["Pulse Top"](#) on page 87

CALCulate<Measurement>:TRACe:MEASurement:POWER:REFerence?

Effective for pulse analysis measurements.

Queries the power level at reference level. See [CALCulate<Measurement>:TRACe:MEASurement:DEFine:DURation:REFerence](#) on page 282.

Suffix:
 <Measurement> 1 to 8
 Measurement

Usage: Query only

CALCulate<Measurement>:TRACe:MEASurement:PULSe:DCYCLE?

Effective for pulse analysis measurements.

Queries the duty cycle of the measured power.

Suffix:
 <Measurement> 1 to 8
 Measurement

Usage: Query only

Manual operation: See ["Duty Cycle"](#) on page 85

CALCulate<Measurement>:TRACe:MEASurement:PULSe:DURation?

Effective for pulse analysis measurements.

Queries the time between the first positive edge and the subsequent negative edge of the pulse, where the edges occur at crossings of the mid threshold.

Suffix:
 <Measurement> 1 to 8
 Measurement

Usage: Query only

Manual operation: See ["Pulse Width"](#) on page 84

CALCulate<Measurement>:TRACe:MEASurement:PULSe:PERiod?

Effective for pulse analysis measurements.

Queries the time between two consecutive edges of the same polarity in seconds. During this time, the pulse signal completes one cycle.

Suffix:
 <Measurement> 1 to 8
 Measurement

Usage: Query only

Manual operation: See ["Pulse Period"](#) on page 84

CALCulate<Measurement>:TRACe:MEASurement:PULSe:SEParation?

Effective for pulse analysis measurements.

Queries the time between the first negative edge and the subsequent positive edge of the pulse in seconds, where the edges occur at crossings of the mid threshold. During this time, the pulse remains at the pulse base level.

Suffix:

<Measurement> 1 to 8
 Measurement

Usage: Query only

Manual operation: See "[Pulse Off Time](#)" on page 85

**CALCulate<Measurement>:TRACe:MEASurement:TRANSition:NEGative:
DURation?**

Effective for pulse analysis measurements.

Queries the time that the pulse requires to transition from the pulse top level to the pulse base level.

Suffix:

<Measurement> 1 to 8
 Measurement

Usage: Query only

Manual operation: See "[Fall Time](#)" on page 85

**CALCulate<Measurement>:TRACe:MEASurement:TRANSition:NEGative:
OCCurrence?**

Effective for pulse analysis measurements.

Queries the time when the signal passes through the medial reference power level with falling edge, referenced to the delayed trigger event. Indicates the stop point of the first power pulse within the analysis window.

Suffix:

<Measurement> 1 to 8
 Measurement

Usage: Query only

Manual operation: See "[Stop Time](#)" on page 86

**CALCulate<Measurement>:TRACe:MEASurement:TRANSition:NEGative:
OVERshoot?**

Effective for pulse analysis measurements.

Queries the height of the local minimum before a rising edge, divided by the pulse amplitude:

$$\text{Negative overshoot} = 100 \% \times \frac{\text{Pulse base power} - \text{minimum power}}{\text{Pulse amplitude}}$$

Depends on the setting under `DISPlay[:WINDow<Window>]:TRACe:MEASurement:RRELation`.

Suffix:

<Measurement> 1 to 8
Measurement

Usage: Query only

Manual operation: See "[Neg. Overshoot](#)" on page 87

CALCulate<Measurement>:TRACe:MEASurement:TRANSition:POSitive:DURation?

Effective for pulse analysis measurements.

Queries the time that the pulse requires to transition from the pulse base level to the pulse top level.

Suffix:

<Measurement> 1 to 8
Measurement

Usage: Query only

Manual operation: See "[Rise Time](#)" on page 85

CALCulate<Measurement>:TRACe:MEASurement:TRANSition:POSitive:OCCurrence?

Effective for pulse analysis measurements.

Queries the time when the signal passes through the medial reference power level with rising edge, referenced to the delayed trigger event. Indicates the start point of the first power pulse within the analysis window.

Suffix:

<Measurement> 1 to 8
Measurement

Usage: Query only

Manual operation: See "[Start Time](#)" on page 85

CALCulate<Measurement>:TRACe:MEASurement:TRANSition:POSitive:OVERshoot?

Effective for pulse analysis measurements.

Queries the height of the local maximum before a falling edge, divided by the pulse amplitude:

$$\text{Positive overshoot} = 100 \% \times \frac{\text{Max. power} - \text{pulse top power}}{\text{Pulse amplitude}}$$

Depends on the setting under [DISPlay\[:WINDow<Window>\]:TRACe:MEASurement:RRELation](#).

Suffix:

<Measurement> 1 to 8
Measurement

Usage: Query only

Manual operation: See "[Pos. Overshoot](#)" on page 88

CALCulate<Measurement>:TRACe:MEASurement:TRANSition:SPERiod?

Effective for pulse analysis measurements.

Queries the number of samples per second.

Suffix:

<Measurement> 1 to 8
Measurement

Usage: Query only

Manual operation: See "[Sampling Rate](#)" on page 86

DISPlay[:WINDow<Window>]:TRACe:MEASurement:POWer:AVG[:STATe] <value>

Effective for pulse analysis measurements.

Enables or disables the display of the average signal power. See [CALCulate<Measurement>:TRACe:MEASurement:POWer:AVG?](#) on page 283.

Suffix:

<Window> 1 to 4
Measurement pane

Parameters:

<value> *RST: OFF

Manual operation: See "[Trace Avg](#)" on page 88

DISPlay[:WINDow<Window>]:TRACe:MEASurement:POWer:MAXimum[:STATe] <value>

Effective for pulse analysis measurements.

Enables or disables the display of the power level at high reference level. See [CALCulate<Measurement>:TRACe:MEASurement:POWer:HREFerence?](#) on page 283.

Suffix:

<Window> 1 to 4
Measurement pane

Parameters:

<value> *RST: OFF

Manual operation: See "[High Ref.](#)" on page 88

**DISPlay[:WINDow<Window>]:TRACe:MEASurement:POWer:PULSe:
LREFerence[:STATe] <value>**

Effective for pulse analysis measurements.

Enables or disables the display of the power level at low reference level. See [CALCulate<Measurement>:TRACe:MEASurement:POWer:LREFerence?](#) on page 283.

Suffix:

<Window> 1 to 4
Measurement pane

Parameters:

<value> *RST: OFF

Manual operation: See "[Low Ref.](#)" on page 88

**DISPlay[:WINDow<Window>]:TRACe:MEASurement:POWer:PULSe:TOP[:STATe]
<value>**

Effective for pulse analysis measurements.

Enables or disables the display of the pulse top power. See [CALCulate<Measurement>:TRACe:MEASurement:POWer:PULSe:TOP?](#) on page 284.

Suffix:

<Window> 1 to 4
Measurement pane

Parameters:

<value> *RST: OFF

Manual operation: See "[Pulse Top](#)" on page 87

**DISPlay[:WINDow<Window>]:TRACe:MEASurement:PULSe:DCYClE[:STATe]
<value>**

Effective for pulse analysis measurements.

Enables or disables the display of the duty cycle of the measured power. See [CALCulate<Measurement>:TRACe:MEASurement:PULSe:DCYClE?](#) on page 285.

Suffix:

<Window> 1 to 4
Measurement pane

Parameters:

<value> *RST: OFF

Manual operation: See "[Duty Cycle](#)" on page 85

DISPlay[:WINDow<Window>]:TRACe:MEASurement:PULSe:DURation[:STATe]
<value>

Effective for pulse analysis measurements.

Enables or disables the display of the pulse width. See [CALCulate<Measurement>:TRACe:MEASurement:PULSe:DURation?](#) on page 285.

Suffix:

<Window> 1 to 4
Measurement pane

Parameters:

<value> *RST: OFF

Manual operation: See "[Pulse Width](#)" on page 84

DISPlay[:WINDow<Window>]:TRACe:MEASurement:PULSe:PERiod[:STATe]
<value>

Effective for pulse analysis measurements.

Enables or disables the display of the time that the pulse signal needs to complete one cycle. See [CALCulate<Measurement>:TRACe:MEASurement:PULSe:PERiod?](#) on page 285.

Suffix:

<Window> 1 to 4
Measurement pane

Parameters:

<value> *RST: OFF

Manual operation: See "[Pulse Period](#)" on page 84

DISPlay[:WINDow<Window>]:TRACe:MEASurement:PULSe:RESolution[:STATe]
<value>

Effective for pulse analysis measurements.

Displays the number of samples per second. See [CALCulate<Measurement>:TRACe:MEASurement:TRANSition:SPERiod?](#) on page 288.

Suffix:

<Window> 1 to 4
Measurement pane

Parameters:

<value> *RST: OFF

Manual operation: See "[Sampling Rate](#)" on page 86

DISPlay[:WINDow<Window>]:TRACe:MEASurement:PULSe:SEParation[:STATe]
<value>

Effective for pulse analysis measurements.

Enables or disables the display of the gap between two pulses. See [CALCulate<Measurement>:TRACe:MEASurement:PULSe:SEParation?](#) on page 286.

Suffix:

<Window> 1 to 4
Measurement pane

Parameters:

<value> *RST: OFF

Manual operation: See "[Pulse Off Time](#)" on page 85

DISPlay[:WINDow<Window>]:TRACe:MEASurement:RRELation <refRelation>

Selects whether the reference levels are voltage-related or power-related.

Suffix:

<Window> 1 to 4
Measurement pane

Parameters:

<refRelation> POWer | VOLTagE
*RST: POWer

Manual operation: See "[Reference Levels relate to](#)" on page 89

DISPlay[:WINDow<Window>]:TRACe:MEASurement:SELECTION <traceNo>

Selects the displayed trace.

Suffix:

<Window> 1 to 4
Measurement pane

Parameters:

<traceNo> Range: 1 to 2
*RST: 1

Manual operation: See "[T1 / T2](#)" on page 82

**DISPlay[:WINDow<Window>]:TRACe:MEASurement:TRANSition:NEGative:
DURation[:STATe] <value>**

Effective for pulse analysis measurements.

Enables or disables the display of the fall time of the first detected pulse. See [CALCulate<Measurement>:TRACe:MEASurement:TRANSition:NEGative:DURation?](#) on page 286.

Suffix:

<Window> 1 to 4
 Measurement pane

Parameters:

<value> *RST: OFF

Manual operation: See "[Fall Time](#)" on page 85

**DISPlay[:WINDow<Window>]:TRACe:MEASurement:TRANSition:NEGative:
OCCurrence[:STATe] <value>**

Effective for pulse analysis measurements.

Enables or disables the display of the time when the signal passes through the medial reference power level with falling edge. See [CALCulate<Measurement>:TRACe:MEASurement:TRANSition:NEGative:OCCurrence?](#) on page 286.

Suffix:

<Window> 1 to 4
 Measurement pane

Parameters:

<value> *RST: OFF

Manual operation: See "[Stop Time](#)" on page 86

**DISPlay[:WINDow<Window>]:TRACe:MEASurement:TRANSition:NEGative:
OVERshoot[:STATe] <value>**

Effective for pulse analysis measurements.

Enables or disables the display of the relative amount of negative overshoot. See [CALCulate<Measurement>:TRACe:MEASurement:TRANSition:NEGative:OVERshoot?](#) on page 286.

Suffix:

<Window> 1 to 4
 Measurement pane

Parameters:

<value> *RST: OFF

Manual operation: See "[Neg. Overshoot](#)" on page 87

**DISPlay[:WINDow<Window>]:TRACe:MEASurement:TRANSition:POSitive:
DURation[:STATe] <value>**

Effective for pulse analysis measurements.

Enables or disables the display of the rise time of the first detected pulse. See [CALCulate<Measurement>:TRACe:MEASurement:TRANSition:POSitive:DURation?](#) on page 287.

Suffix:

<Window> 1 to 4
 Measurement pane

Parameters:

<value> *RST: OFF

Manual operation: See "[Rise Time](#)" on page 85

**DISPlay[:WINDow<Window>]:TRACe:MEASurement:TRANSition:POSitive:
OCCurrence[:STATe] <value>**

Effective for pulse analysis measurements.

Enables or disables the display of the time when the signal passes through the medial reference power level with rising edge. See [CALCulate<Measurement>:TRACe:MEASurement:TRANSition:POSitive:OCCurrence?](#) on page 287.

Suffix:

<Window> 1 to 4
 Measurement pane

Parameters:

<value> *RST: OFF

Manual operation: See "[Start Time](#)" on page 85

**DISPlay[:WINDow<Window>]:TRACe:MEASurement:TRANSition:POSitive:
OVERshoot[:STATe] <value>**

Effective for pulse analysis measurements.

Enables or disables the display of the relative amount of positive overshoot. See [CALCulate<Measurement>:TRACe:MEASurement:TRANSition:POSitive:OVERshoot?](#) on page 287.

Suffix:

<Window> 1 to 4
 Measurement pane

Parameters:

<value> *RST: OFF

Manual operation: See "[Pos. Overshoot](#)" on page 88

13.6.10 Time gate measurements

Further information:

- [Chapter 6.6, "Time gate"](#), on page 90

CALCulate<Measurement>[:POWER]:TGATe<Gate>[:AVG]:OFFSet[:TIME]	295
CALCulate<Measurement>[:POWER]:TGATe<Gate>[:AVG]:TIME	295
CALCulate<Measurement>[:POWER]:TGATe<Gate>[:AVG][:EXCLude]:MID:OFFSet[:TIME] ...	295
CALCulate<Measurement>[:POWER]:TGATe<Gate>[:AVG][:EXCLude]:MID:TIME	296
CALCulate<Measurement>[:POWER]:TGATe<Gate>[:AVG][:EXCLude]:MID[:STATe]	296
CALCulate<Measurement>[:POWER]:TGATe<Undef>[:AVG]:SELEction	297

CALCulate<Measurement>[:POWER]:TGATe<Gate>[:AVG]:OFFSet[:TIME] <value>

Sets the length of the gate.

Suffix:

<Measurement>	1 to 8 Measurement
<Gate>	1 to 4 Time gate

Parameters:

<value>	Range: 0.0 to 15.0
	*RST: 0.0
	Default unit: s

Manual operation: See "[Length of Gate](#)" on page 95

CALCulate<Measurement>[:POWER]:TGATe<Gate>[:AVG]:TIME <value>

Sets the start time of the gate.

Suffix:

<Measurement>	1 to 8 Measurement
<Gate>	1 to 4 Time gate

Parameters:

<value>	Range: 50.0e-9 to 0.1
	*RST: 1.0e-3
	Default unit: s

Manual operation: See "[Start of Gate](#)" on page 95

CALCulate<Measurement>[:POWER]:TGATe<Gate>[:AVG][:EXCLude]:MID:OFFSet[:TIME] <value>

Sets length of the fence.

Suffix:

<Measurement> 1 to 8
Measurement

<Gate> 1 to 4
Time gate

Parameters:

<value> Range: 0.0 to 0.1
*RST: 0.0
Default unit: s

Manual operation: See "[Length of Fence](#)" on page 95

CALCulate<Measurement>[:**POWER**]:TGATe<Gate>[:**AVG**][:**EXCLude**]:MID:TIME
<value>

Sets the start time of the fence. The start time refers to the start of the gate.

Suffix:

<Measurement> 1 to 8
Measurement

<Gate> 1 to 4
Time gate

Parameters:

<value> Range: 0.0 to 0.1
*RST: 0.0
Default unit: s

Manual operation: See "[Start of Fence](#)" on page 95

CALCulate<Measurement>[:**POWER**]:TGATe<Gate>[:**AVG**][:**EXCLude**]:MID[:**STATe**]
<value>

Enables or disables an exclusion interval for the selected gate. This exclusion interval is called fence. The interval where the fence overlaps with the gate is excluded from the measurement.

Like a gate, a fence is defined by its start time and its length.

Suffix:

<Measurement> 1 to 8
Measurement

<Gate> 1 to 4
Time gate

Parameters:

<value> *RST: OFF

Manual operation: See "[Fence](#)" on page 95

CALCulate<Measurement>[:POWER]:TGATe<Undef>[:AVG]:SElection <value>

Selects the active gate for the measurement.

Suffix:

<Measurement> 1 to 8
Measurement

<Undef> 1 to n
No suffix required.

Parameters:

<value> Range: 1 to 4
 *RST: 1

Manual operation: See "[G1 / G2 / G3 / G4](#)" on page 93

13.6.11 Timeslot measurements

There are several ways to program the R&S NRX for measurements. See [Chapter 13.4, "Making measurements"](#), on page 188.

Further information:

- [Chapter 6.7, "Timeslot"](#), on page 95

13.6.11.1 Combining commands for timeslot measurements

See also [Chapter 13.4, "Making measurements"](#), on page 188.

Parameter list for timeslot measurements

Parameter	Description
<tslot_width>	Mandatory. Width of a timeslot. Corresponds to [SENSe<Sensor>:] [POWER:] TSLot [:AVG]:WIDTH on page 447.
<no_slots>	Mandatory. Number of timeslots to be measured. Corresponds to [SENSe<Sensor>:] [POWER:] TSLot [:AVG]:COUNT on page 447.
<start_exclude>	Mandatory. Amount of time at the beginning of a timeslot or integration period that is not evaluated. Corresponds to [SENSe<Sensor>:] TIMing:EXCLude:START .
<end_exclude>	Mandatory. Amount of time at the end of a timeslot or integration period that is not evaluated. Corresponds to [SENSe<Sensor>:] TIMing:EXCLude:STOP .
<expected_value>	Optional. Value that is expected for the measurement.

Parameter	Description
<resolution>	Optional. Limit up to which the measurement result probably is free of noise. Corresponds to <code>[SENSe<Sensor>:]AVERage:COUNT:AUTO:RESolution</code> .
<source_list>	Mandatory. Primary and secondary sensor. The number for each sensor is preceded by the character @. The entire expression is enclosed in parentheses. Example: <code>(@3),(@2)</code> Sensor C is the primary sensor, and sensor B is the secondary sensor.

CONFigure<Measurement>[:SCALar][:POWer]:TSlot? <tslot_width>, <no_slots>, <start_exclude>, <end_exclude>[, <expected_value_or_source_list>, <resolution_or_source_list>, <source_list>...]

FETCh<Measurement>[:SCALar][:POWer]:TSlot? <tslot_width>, <no_slots>, <start_exclude>, <end_exclude>[, <expected_value_or_source_list>, <resolution_or_source_list>, <source_list>...]

READ<Measurement>[:SCALar][:POWer]:TSlot? <tslot_width>, <no_slots>, <start_exclude>, <end_exclude>[, <expected_value_or_source_list>, <resolution_or_source_list>, <source_list>...]

MEASure<Measurement>[:SCALar][:POWer]:TSlot? <tslot_width>, <no_slots>, <start_exclude>, <end_exclude>[, <expected_value_or_source_list>, <resolution_or_source_list>, <source_list>...]

Power measured by one power sensor.

Suffix:

<Measurement> 1 to 8
Measurement

Query parameters:

<tslot_width> Default unit: s
 <no_slots> Default unit: s
 <start_exclude> Default unit: s
 <end_exclude> Default unit: s
 <expected_value_or_source_list>
 <numeric> | <expr>
 <resolution_or_source_list>
 <numeric> | <expr>
 <source_list> <expr>

For the parameter descriptions, see "[Parameter list for timeslot measurements](#)" on page 297.

Usage: Query only

```

CONFigure<Measurement>[:SCALar][:POWer]:TSLot:RELative? <tslot_width>,
    <no_slots>, <start_exclude>, <end_exclude>[,
    <expected_value_or_source_list>, <resolution_or_source_list>, <source_list>...]
FETCh<Measurement>[:SCALar][:POWer]:TSLot:RELative? <tslot_width>,
    <no_slots>, <start_exclude>, <end_exclude>[,
    <expected_value_or_source_list>, <resolution_or_source_list>, <source_list>...]
READ<Measurement>[:SCALar][:POWer]:TSLot:RELative? <tslot_width>,
    <no_slots>, <start_exclude>, <end_exclude>[,
    <expected_value_or_source_list>, <resolution_or_source_list>, <source_list>...]
MEASure<Measurement>[:SCALar][:POWer]:TSLot:RELative? <tslot_width>,
    <no_slots>, <start_exclude>, <end_exclude>[,
    <expected_value_or_source_list>, <resolution_or_source_list>, <source_list>...]

```

Relative power measured by one power sensor.

Suffix:

<Measurement> 1 to 8
 Measurement

Query parameters:

<tslot_width> Default unit: s
 <no_slots> Default unit: s
 <start_exclude> Default unit: s
 <end_exclude> Default unit: s
 <expected_value_or_source_list>
 <numeric> | <expr>
 <resolution_or_source_list>
 <numeric> | <expr>
 <source_list> <expr>

For the parameter descriptions, see "[Parameter list for timeslot measurements](#)" on page 297.

Usage: Query only

```

CONFigure<Measurement>[:SCALar][:POWer]:TSLot:DIFFerence? <tslot_width>,
    <no_slots>, <start_exclude>, <end_exclude>[,
    <expected_value_or_source_list>, <resolution_or_source_list>, <source_list>...]
FETCh<Measurement>[:SCALar][:POWer]:TSLot:DIFFerence? <tslot_width>,
    <no_slots>, <start_exclude>, <end_exclude>[,
    <expected_value_or_source_list>, <resolution_or_source_list>, <source_list>...]
READ<Measurement>[:SCALar][:POWer]:TSLot:DIFFerence? <tslot_width>,
    <no_slots>, <start_exclude>, <end_exclude>[,
    <expected_value_or_source_list>, <resolution_or_source_list>, <source_list>...]
MEASure<Measurement>[:SCALar][:POWer]:TSLot:DIFFerence? <tslot_width>,
    <no_slots>, <start_exclude>, <end_exclude>[,
    <expected_value_or_source_list>, <resolution_or_source_list>, <source_list>...]

```

Power measured by two power sensors.

Suffix:

<Measurement> 1 to 8
Measurement

Query parameters:

<tslot_width> Default unit: s
 <no_slots> Default unit: s
 <start_exclude> Default unit: s
 <end_exclude> Default unit: s
 <expected_value_or_source_list>
 <numeric> | <expr>
 <resolution_or_source_list>
 <numeric> | <expr>
 <source_list> <expr>

For the parameter descriptions, see "[Parameter list for timeslot measurements](#)" on page 297.

Usage: Query only

CONFigure<Measurement>[:SCALar][:POWer]:TSLot:DIFFerence:RELative?

<tslot_width>, <no_slots>, <start_exclude>, <end_exclude>[,
 <expected_value_or_source_list>, <resolution_or_source_list>, <source_list>...]

FETCh<Measurement>[:SCALar][:POWer]:TSLot:DIFFerence:RELative?

<tslot_width>, <no_slots>, <start_exclude>, <end_exclude>[,
 <expected_value_or_source_list>, <resolution_or_source_list>, <source_list>...]

READ<Measurement>[:SCALar][:POWer]:TSLot:DIFFerence:RELative?

<tslot_width>, <no_slots>, <start_exclude>, <end_exclude>[,
 <expected_value_or_source_list>, <resolution_or_source_list>, <source_list>...]

MEASure<Measurement>[:SCALar][:POWer]:TSLot:DIFFerence:RELative?

<tslot_width>, <no_slots>, <start_exclude>, <end_exclude>[,
 <expected_value_or_source_list>, <resolution_or_source_list>, <source_list>...]

Relative difference measured by two power sensors.

Suffix:

<Measurement> 1 to 8
Measurement

Query parameters:

<tslot_width> Default unit: s
 <no_slots> Default unit: s
 <start_exclude> Default unit: s
 <end_exclude> Default unit: s
 <expected_value_or_source_list>
 <numeric> | <expr>

CONFigure<Measurement>[:SCALar][:POWER]:TSLot:SUM:RELative? <tslot_width>, <no_slots>, <start_exclude>, <end_exclude>[, <expected_value_or_source_list>, <resolution_or_source_list>, <source_list>...]
FETCh<Measurement>[:SCALar][:POWER]:TSLot:SUM:RELative? <tslot_width>, <no_slots>, <start_exclude>, <end_exclude>[, <expected_value_or_source_list>, <resolution_or_source_list>, <source_list>...]
READ<Measurement>[:SCALar][:POWER]:TSLot:SUM:RELative? <tslot_width>, <no_slots>, <start_exclude>, <end_exclude>[, <expected_value_or_source_list>, <resolution_or_source_list>, <source_list>...]
MEASure<Measurement>[:SCALar][:POWER]:TSLot:SUM:RELative? <tslot_width>, <no_slots>, <start_exclude>, <end_exclude>[, <expected_value_or_source_list>, <resolution_or_source_list>, <source_list>...]

Relative sum measured by two power sensors.

Suffix:

<Measurement> 1 to 8
 Measurement

Query parameters:

<tslot_width> Default unit: s
 <no_slots> Default unit: s
 <start_exclude> Default unit: s
 <end_exclude> Default unit: s
 <expected_value_or_source_list>
 <numeric> | <expr>
 <resolution_or_source_list>
 <numeric> | <expr>
 <source_list> <expr>

For the parameter descriptions, see "[Parameter list for timeslot measurements](#)" on page 297.

Usage: Query only

CONFigure<Measurement>[:SCALar][:POWER]:TSLot:RATio? <tslot_width>, <no_slots>, <start_exclude>, <end_exclude>[, <expected_value_or_source_list>, <resolution_or_source_list>, <source_list>...]
FETCh<Measurement>[:SCALar][:POWER]:TSLot:RATio? <tslot_width>, <no_slots>, <start_exclude>, <end_exclude>[, <expected_value_or_source_list>, <resolution_or_source_list>, <source_list>...]
READ<Measurement>[:SCALar][:POWER]:TSLot:RATio? <tslot_width>, <no_slots>, <start_exclude>, <end_exclude>[, <expected_value_or_source_list>, <resolution_or_source_list>, <source_list>...]
MEASure<Measurement>[:SCALar][:POWER]:TSLot:RATio? <tslot_width>, <no_slots>, <start_exclude>, <end_exclude>[, <expected_value_or_source_list>, <resolution_or_source_list>, <source_list>...]

Ratio measured by two power sensors.

Suffix:

<Measurement> 1 to 8
Measurement

Query parameters:

<tslot_width> Default unit: s
 <no_slots> Default unit: s
 <start_exclude> Default unit: s
 <end_exclude> Default unit: s
 <expected_value_or_source_list>
 <numeric> | <expr>
 <resolution_or_source_list>
 <numeric> | <expr>
 <source_list> <expr>

For the parameter descriptions, see "[Parameter list for timeslot measurements](#)" on page 297.

Usage: Query only

CONFigure<Measurement>[:SCALar][:POWer]:TSLot:RATio:RELative?

<tslot_width>, <no_slots>, <start_exclude>, <end_exclude>[,
 <expected_value_or_source_list>, <resolution_or_source_list>, <source_list>...]

FETCh<Measurement>[:SCALar][:POWer]:TSLot:RATio:RELative? <tslot_width>

<no_slots>, <start_exclude>, <end_exclude>[,
 <expected_value_or_source_list>, <resolution_or_source_list>, <source_list>...]

READ<Measurement>[:SCALar][:POWer]:TSLot:RATio:RELative? <tslot_width>

<no_slots>, <start_exclude>, <end_exclude>[,
 <expected_value_or_source_list>, <resolution_or_source_list>, <source_list>...]

MEASure<Measurement>[:SCALar][:POWer]:TSLot:RATio:RELative?

<tslot_width>, <no_slots>, <start_exclude>, <end_exclude>[,
 <expected_value_or_source_list>, <resolution_or_source_list>, <source_list>...]

Relative ratio measured by two power sensors.

Suffix:

<Measurement> 1 to 8
Measurement

Query parameters:

<tslot_width> Default unit: s
 <no_slots> Default unit: s
 <start_exclude> Default unit: s
 <end_exclude> Default unit: s
 <expected_value_or_source_list>
 <numeric> | <expr>

CONFigure<Measurement>[:SCALar][:POWer]:TSLot:REFLection? <tslot_width>, <no_slots>, <start_exclude>, <end_exclude>[, <expected_value_or_source_list>, <resolution_or_source_list>, <source_list>...]
FETCh<Measurement>[:SCALar][:POWer]:TSLot:REFLection? <tslot_width>, <no_slots>, <start_exclude>, <end_exclude>[, <expected_value_or_source_list>, <resolution_or_source_list>, <source_list>...]
READ<Measurement>[:SCALar][:POWer]:TSLot:REFLection? <tslot_width>, <no_slots>, <start_exclude>, <end_exclude>[, <expected_value_or_source_list>, <resolution_or_source_list>, <source_list>...]
MEASure<Measurement>[:SCALar][:POWer]:TSLot:REFLection? <tslot_width>, <no_slots>, <start_exclude>, <end_exclude>[, <expected_value_or_source_list>, <resolution_or_source_list>, <source_list>...]

Reflection coefficient/transmission factor of a DUT, measured by two power sensors.

Suffix:

<Measurement> 1 to 8
Measurement

Query parameters:

<tslot_width> Default unit: s
 <no_slots> Default unit: s
 <start_exclude> Default unit: s
 <end_exclude> Default unit: s
 <expected_value_or_source_list>
 <numeric> | <expr>
 <resolution_or_source_list>
 <numeric> | <expr>
 <source_list> <expr>

For the parameter descriptions, see "[Parameter list for timeslot measurements](#)" on page 297.

Usage: Query only

CONFigure<Measurement>[:SCALar][:POWer]:TSLot:RLOSs? <tslot_width>, <no_slots>, <start_exclude>, <end_exclude>[, <expected_value_or_source_list>, <resolution_or_source_list>, <source_list>...]
FETCh<Measurement>[:SCALar][:POWer]:TSLot:RLOSs? <tslot_width>, <no_slots>, <start_exclude>, <end_exclude>[, <expected_value_or_source_list>, <resolution_or_source_list>, <source_list>...]
READ<Measurement>[:SCALar][:POWer]:TSLot:RLOSs? <tslot_width>, <no_slots>, <start_exclude>, <end_exclude>[, <expected_value_or_source_list>, <resolution_or_source_list>, <source_list>...]
MEASure<Measurement>[:SCALar][:POWer]:TSLot:RLOSs? <tslot_width>, <no_slots>, <start_exclude>, <end_exclude>[, <expected_value_or_source_list>, <resolution_or_source_list>, <source_list>...]

Return loss/transmission loss of a DUT, measured by two power sensors.

Suffix:

<Measurement> 1 to 8
Measurement

Query parameters:

<tslot_width> Default unit: s
<no_slots> Default unit: s
<start_exclude> Default unit: s
<end_exclude> Default unit: s
<expected_value_or_source_list>
 <numeric> | <expr>
<resolution_or_source_list>
 <numeric> | <expr>
<source_list> <expr>

For the parameter descriptions, see "[Parameter list for timeslot measurements](#)" on page 297.

Usage: Query only

13.6.11.2 Lower-level timeslot commands

See also [Chapter 13.4.4, "Configuring one setting at a time"](#), on page 190.

CALCulate<Measurement>:TSLot:TIMing:EXCLude:START	306
CALCulate<Measurement>:TSLot:TIMing:EXCLude:STOP	307
CALCulate<Measurement>[:POWer]:TSLot[:AVG]:COUNT	307
CALCulate<Measurement>[:POWer]:TSLot[:AVG]:SELECTION	307
CALCulate<Measurement>[:POWer]:TSLot[:AVG]:WIDTH	307
CALCulate<Measurement>[:POWer]:TSLot[:AVG][:EXCLude]:MID:OFFSet[:TIME]	308
CALCulate<Measurement>[:POWer]:TSLot[:AVG][:EXCLude]:MID:TIME	308
CALCulate<Measurement>[:POWer]:TSLot[:AVG][:EXCLude]:MID[:STATe]	308

CALCulate<Measurement>:TSLot:TIMing:EXCLude:START <value>

Defines an interval at the start of the timeslot that is excluded from the measurement.

Suffix:

<Measurement> 1 to 8
Measurement

Parameters:

<value> Range: 0.0 to 15.0
 *RST: 0.0
 Default unit: s

Manual operation: See "[Exclude from Start](#)" on page 100

CALCulate<Measurement>:TSLot:TIMing:EXCLude:STOP <value>

Defines an interval at the end of the timeslot that is excluded from the measurement.

Suffix:

<Measurement> 1 to 8
Measurement

Parameters:

<value> Range: 0.0 to 15.0
*RST: 0.0
Default unit: s

Manual operation: See "[Exclude from End](#)" on page 100

CALCulate<Measurement>[:POWER]:TSLot[:AVG]:COUNT <value>

Sets the number of simultaneously measured timeslots.

Suffix:

<Measurement> 1 to 8
Measurement

Parameters:

<value> Range: 1 to 128
*RST: 8

Manual operation: See "[Slots](#)" on page 100

CALCulate<Measurement>[:POWER]:TSLot[:AVG]:SELECTION <value>

Selects a timeslot for the measurement.

Suffix:

<Measurement> 1 to 8
Measurement

Parameters:

<value> Range: 1 to 128
*RST: 1

Manual operation: See "[Timeslot](#)" on page 98

CALCulate<Measurement>[:POWER]:TSLot[:AVG]:WIDTH <value>

Sets the length of the timeslot.

Suffix:

<Measurement> 1 to 8
Measurement

Parameters:

<value> Range: 50.0e-9 to 0.1
 *RST: 1.0e-3
 Default unit: s

Manual operation: See "[Nominal Width](#)" on page 100

CALCulate<Measurement>[:POWER]:TSLot[:AVG][:EXCLude]:MID:OFFSet[:TIME]
 <value>

Sets the length of the fence.

Suffix:

<Measurement> 1 to 8
 Measurement

Parameters:

<value> Range: 0.0 to 0.1
 *RST: 0.0
 Default unit: s

Manual operation: See "[Length of Fence](#)" on page 101

CALCulate<Measurement>[:POWER]:TSLot[:AVG][:EXCLude]:MID:TIME <value>

Sets the start time of the fence. The start time refers to the start of the timeslots.

Suffix:

<Measurement> 1 to 8
 Measurement

Parameters:

<value> Range: 0.0 to 0.1
 *RST: 0.0
 Default unit: s

Manual operation: See "[Start of Fence](#)" on page 101

CALCulate<Measurement>[:POWER]:TSLot[:AVG][:EXCLude]:MID[:STATe]
 <value>

Enables or disables an exclusion interval in the timeslots. This exclusion interval is called fence. The fence is defined by its start time and its length.

Suffix:

<Measurement> 1 to 8
 Measurement

Parameters:

<value> *RST: OFF

Manual operation: See "[Fence](#)" on page 101

13.6.12 Statistics measurements

There are several ways to program the R&S NRX for measurements. See [Chapter 13.4, "Making measurements"](#), on page 188.

Further information:

- [Chapter 6.8, "Statistics"](#), on page 101

13.6.12.1 Combining commands for statistics measurements

See also [Chapter 13.4, "Making measurements"](#), on page 188.

Parameter list for the statistics measurement

Parameter	Description
<statistics_size>	Mandatory. Number of test points on the time axis. Corresponds to [SENSe<Sensor>:]STATistics:SCALE:X:POINTS on page 452.
<capture_time>	Mandatory. Period within which measured data are captured in the trace measurements. Corresponds to [SENSe<Sensor>:]TRACe:TIME on page 216.
<source_list>	Mandatory. Primary and secondary sensor. The number for each sensor is preceded by the character @. The entire expression is enclosed in parentheses. Example: (@3),(@2) Sensor C is the primary sensor, and sensor B is the secondary sensor.

CONFigure<Measurement>:STATistics:CCDF? <statistics_size>, <capture_time>, <source_list>

FETCh<Measurement>:STATistics:CCDF? <statistics_size>, <capture_time>, <source_list>

READ<Measurement>:STATistics:CCDF? <statistics_size>, <capture_time>, <source_list>

MEASure<Measurement>:STATistics:CCDF? <statistics_size>, <capture_time>, <source_list>

Measures the power in the defined time interval and performs a statistic evaluation (probability density function, PDF).

Suffix:

<Measurement> 1 to 8
Measurement

Query parameters:

<statistics_size> <expr>

<capture_time> Default unit: s

<source_list> <expr>

For the parameter descriptions, see "[Parameter list for the statistics measurement](#)" on page 309.

Usage: Query only

CONFigure<Measurement>:STATistics:PDF? <statistics_size>, <capture_time>, <source_list>

FETCh<Measurement>:STATistics:PDF? <statistics_size>, <capture_time>, <source_list>

READ<Measurement>:STATistics:PDF? <statistics_size>, <capture_time>, <source_list>

MEASure<Measurement>:STATistics:PDF? <statistics_size>, <capture_time>, <source_list>

Measures the power in the defined time interval and performs a statistic evaluation (complementary cumulative distribution function, CCDF).

Suffix:

<Measurement> 1 to 8
Measurement

Query parameters:

<statistics_size> <expr>

<capture_time> Default unit: s

<source_list> <expr>

For the parameter descriptions, see "[Parameter list for the statistics measurement](#)" on page 309.

Usage: Query only

13.6.12.2 Lower-level statistics commands

See also [Chapter 13.4.4, "Configuring one setting at a time"](#), on page 190.

For time gate settings, see also [Chapter 13.6.10, "Time gate measurements"](#), on page 295.

[SENSe<Sensor>:]STATistics:AVERage?	310
[SENSe<Sensor>:]STATistics:OFFSet[:TIME]	311
[SENSe<Sensor>:]STATistics:PEAK?	311
CALCulate<Measurement>:STATistics:POWer:AVG:DATA?	311
CALCulate<Measurement>:STATistics:APERture	312
CALCulate<Measurement>:STATistics:AWGN[:STATE]	312
CALCulate<Measurement>:STATistics:SAMPles[:MINimum]	312
CALCulate<Measurement>:STATistics:TGATe:SELection	312

[SENSe<Sensor>:]STATistics:AVERage?

Queries the average power value calculated during a statistics measurement.

Suffix:

<Sensor> 1 to 128
Configured sensor connected at: port A = 1, ... , port D = 4, R&S NRX-B9 = 101, USB and LAN port = 5 to 100

Usage:

Query only

[SENSe<Sensor>:]STATistics:OFFSet[:TIME] <time>

Sets the start of the sampling window, referenced to delay set by [TRIGger<Measurement>\[:CHANnel<Channel>\]:DELay\[:VALue\]](#).

Suffix:

<Sensor> 1 to 128
Configured sensor connected at: port A = 1, ... , port D = 4, R&S NRX-B9 = 101, USB and LAN port = 5 to 100

Parameters:

<time> Range: 0.0 to 10.0
*RST: 0.0
Default unit: s

[SENSe<Sensor>:]STATistics:PEAK?

Queries the peak power value calculated during a CCDF or PDF statistics measurement.

Suffix:

<Sensor> 1 to 128
Configured sensor connected at: port A = 1, ... , port D = 4, R&S NRX-B9 = 101, USB and LAN port = 5 to 100

Usage:

Query only

CALCulate<Measurement>:STATistics:POWer:AVG:DATA?

Effective for statistics measurements.

Queries the average power value in the sampling window.

The command is not fully R&S NRP2 compatible. If port 1 is assigned to measurement 1 and so on, the command works. If port 1 is assigned to measurement 2, for example, enable the R&S NRP2 emulation using [SYSTem:LANGuage](#) "NRP2".

Suffix:

<Measurement> 1 to 8
Measurement

Usage:

Query only

CALCulate<Measurement>:STATistics:APERture <value>

Effective for statistics measurements.

Sets the width of the sampling window for unsynchronized acquisition, that is if

[CALCulate<Measurement>:STATistics:TGATe:SElection](#) 0 is set.

Suffix:

<Measurement> 1 to 8
Measurement

Parameters:

<value> Range: 10e-6 to 10.0
 *RST: 0.01
 Default unit: s

Manual operation: See "[Aperture](#)" on page 117

CALCulate<Measurement>:STATistics:AWGN[:STATe] <value>

Effective for statistics measurements.

Enables or disables the internal, additional white Gaussian noise (AWGN) source. If enabled, you cannot measure with a second power sensor.

Suffix:

<Measurement> 1 to 8
Measurement

Parameters:

<value> *RST: OFF

Manual operation: See "[AWGN](#)" on page 105

CALCulate<Measurement>:STATistics:SAMPles[:MINimum] <value>

Effective for statistics measurements.

Sets the minimum number of samples.

Suffix:

<Measurement> 1 to 8
Measurement

Parameters:

<value> Range: 1 to 2147483647
 *RST: 1000000

Manual operation: See "[Minimum Samples](#)" on page 105

CALCulate<Measurement>:STATistics:TGATe:SElection <value>

Effective for statistics measurements.

Configures the sampling window.

Suffix:

<Measurement> 1 to 8
Measurement

Parameters:

<value> 0
Continuous
1 - 4
Gate number
Range: 0 to 4
*RST: 1

Manual operation: See "Evaluate" on page 108

13.6.12.3 Scaling

[SENSe<Sensor>:]STATistics:SCALE:X:MPWidth?	313
CALCulate<Measurement>:STATistics:PDF[:SCALE]:Y:PDIVision	313
CALCulate<Measurement>:STATistics:PDF[:SCALE]:Y:TOP	314
CALCulate<Measurement>:STATistics[:CDF][:SCALE]:Y[:LINear]:PDIVision	314
CALCulate<Measurement>:STATistics[:CDF][:SCALE]:Y[:LINear]:TOP	314
CALCulate<Measurement>:STATistics[:SCALE]:X:MODE	315
CALCulate<Measurement>:STATistics[:SCALE]:X:POINTs	315
CALCulate<Measurement>:STATistics[:SCALE]:X:RANGE	316
CALCulate<Measurement>:STATistics[:SCALE]:X:RLEVel:RELative	316
CALCulate<Measurement>:STATistics[:SCALE]:X:RLEVel[:ABSolute]	316
CALCulate<Measurement>:STATistics[:SCALE]:Y:SPACing	317

[SENSe<Sensor>:]STATistics:SCALE:X:MPWidth?

Queries the greatest level resolution that can be attained. If the value is exceeded, a settings conflict occurs, due to the following reasons:

- Number of pixels that has been selected is too great, see [CALCulate<Measurement>:STATistics\[:SCALE\]:X:POINTs](#) on page 315.
- Width chosen for the level range is too small, see [CALCulate<Measurement>:STATistics\[:SCALE\]:X:RANGE](#) on page 316.

Suffix:

<Sensor> 1 to 128
Configured sensor connected at: port A = 1, ... , port D = 4, R&S NRX-B9 = 101, USB and LAN port = 5 to 100

Usage: Query only

CALCulate<Measurement>:STATistics:PDF[:SCALE]:Y:PDIVision <value>

Effective if [CALCulate<Measurement>:STATistics\[:SCALE\]:Y:SPACing](#) LIN is set.

Sets the scaling of the y-axis for PDF statistics measurements.

Suffix:

<Measurement> 1 to 8
Measurement

Parameters:

<value> Range: 0.01 to 1000.0
*RST: 0.2
Default unit: -

Manual operation: See "Y / div" on page 106

CALCulate<Measurement>:STATistics:PDF[:SCALE]:Y:TOP <value>

Effective if `CALCulate<Measurement>:STATistics[:SCALE]:Y:SPACing` LIN is set.

Sets the maximum value of the y-axis for PDF statistics measurements.

Suffix:

<Measurement> 1 to 8
Measurement

Parameters:

<value> Range: 0.0 to 10000.0
*RST: 1.0
Default unit: -

Manual operation: See "Y Maximum" on page 106

CALCulate<Measurement>:STATistics[:CDF][:SCALE]:Y[:LINear]:PDIVision <value>

Effective if `CALCulate<Measurement>:STATistics[:SCALE]:Y:SPACing` LIN is set.

Sets the scaling of the y-axis for CDF statistics measurements.

Suffix:

<Measurement> 1 to 8
Measurement

Parameters:

<value> Range: 0.001 to 20.0
*RST: 20.0
Default unit: pct

Manual operation: See "Y / div" on page 106

CALCulate<Measurement>:STATistics[:CDF][:SCALE]:Y[:LINear]:TOP <value>

Effective if `CALCulate<Measurement>:STATistics[:SCALE]:Y:SPACing` LIN is set.

Sets the maximum value of the y-axis for CDF statistics measurements.

Suffix:

<Measurement> 1 to 8
Measurement

Parameters:

<value> Range: 0.0 to 100.0
*RST: 100.0
Default unit: pct

Manual operation: See "[Y Maximum](#)" on page 106

CALCulate<Measurement>:STATistics[:SCALe]:X:MODE <value>

Effective for statistics measurements.

Sets relative or absolute scaling for the x-axis.

Suffix:

<Measurement> 1 to 8
Measurement

Parameters:

<value> ABSolute | RELative
*RST: ABSolute

Manual operation: See "[Scaling of Power Axis](#)" on page 106

CALCulate<Measurement>:STATistics[:SCALe]:X:POINTs <value>

Effective for statistics measurements.

Sets the measurement result resolution. It specifies the number of pixels that are assigned to the logarithmic level range for measured value output. The width of the level range divided by N-1, where N is the number of pixels, must not be less than the smallest level resolution.

- Level range: [CALCulate<Measurement>:STATistics\[:SCALe\]:X:RANGe](#) on page 316
- Smallest level resolution: [\[SENSe<Sensor>:\]STATistics:SCALe:X:MPWidth?](#) on page 313

Suffix:

<Measurement> 1 to 8
Measurement

Parameters:

<value> Range: 3 to 8191
*RST: 600

Manual operation: See "[Power / div](#)" on page 106

CALCulate<Measurement>:STATistics[:SCALe]:X:RANGe <value>

Effective for statistics measurements.

Sets the width of the level range for the analysis result.

Lower limit of the level range:

- [CALCulate<Measurement>:STATistics\[:SCALe\]:X:RLEVel:RELative](#) on page 316
- [CALCulate<Measurement>:STATistics\[:SCALe\]:X:RLEVel\[:ABSolute\]](#) on page 316

Suffix:

<Measurement> 1 to 8
Measurement

Parameters:

<value> Range: 0.01 to 100.0
 *RST: 50.0
 Default unit: dB

Manual operation: See "[Power / div](#)" on page 106

CALCulate<Measurement>:STATistics[:SCALe]:X:RLEVel:RELative <value>

Effective for statistics measurements with relative power display.

Sets the lower limit of the level range for the analysis result. This level is assigned to the first pixel. The level assigned to the last pixel is equal to the level of the first pixel plus the level range.

Suffix:

<Measurement> 1 to 8
Measurement

Parameters:

<value> Range: -400.0 to 400.0
 *RST: -25.0
 Default unit: dB

Manual operation: See "[Minimum Power](#)" on page 106

CALCulate<Measurement>:STATistics[:SCALe]:X:RLEVel[:ABSolute] <value>

Effective for statistics measurements with absolute power display.

Sets the lower limit of the level range for the analysis result. This level is assigned to the first pixel. The level assigned to the last pixel is equal to the level of the first pixel plus the level range.

Suffix:

<Measurement> 1 to 8
Measurement

Parameters:

<value> Range: -400.0 to 400.0
 *RST: -30.0
 Default unit: dBm

Manual operation: See "[Minimum Power](#)" on page 106

CALCulate<Measurement>:STATistics[:SCALe]:Y:SPACing <value>

Effective for statistics measurements.

Sets linear or logarithmic scaling for the y-axis.

Suffix:

<Measurement> 1 to 8
 Measurement

Parameters:

<value> LINear | LOGarithmic
 *RST: LOGarithmic

Manual operation: See "[Scaling of Y Axis](#)" on page 106

13.6.12.4 Using markers

CALCulate<Measurement>:STATistics[:CDF]:MARKer:Y:POSition.....	317
CALCulate<Measurement>:STATistics:MARKer:HORIZontal:DATA?.....	317
CALCulate<Measurement>:STATistics:MARKer:VERTical:DATA[:POWER]?.....	318
CALCulate<Measurement>:STATistics:MARKer:X:POSition[:ABSolute].....	318
CALCulate<Measurement>:STATistics:MARKer:X:POSition:RELative.....	318
CALCulate<Measurement>:STATistics:PDF:MARKer:Y:POSition.....	319

CALCulate<Measurement>:STATistics[:CDF]:MARKer:Y:POSition <value>

Positions the y-marker to a measurement value of the CDF statistics measurement.

Suffix:

<Measurement> 1 to 8
 Measurement

Parameters:

<value> Range: 0.0 to 100.0
 *RST: 50.0
 Default unit: pct

Manual operation: See "[\[%\] marker](#)" on page 103

CALCulate<Measurement>:STATistics:MARKer:HORIZontal:DATA?

Effective for statistics measurements.

Queries the measurement result at the x-marker position.

The command is not fully R&S NRP2 compatible. If port 1 is assigned to measurement 1 and so on, the command works. If port 1 is assigned to measurement 2, for example, enable the R&S NRP2 emulation using `SYSTem:LANGuage "NRP2"`.

Suffix:

<Measurement> 1 to 8
Measurement

Usage: Query only

CALCulate<Measurement>:STATistics:MARKer:VERTical:DATA[:POWER]?

Effective for statistics measurements.

Queries the power value at the y-marker position.

The command is not fully R&S NRP2 compatible. If port 1 is assigned to measurement 1 and so on, the command works. If port 1 is assigned to measurement 2, for example, enable the R&S NRP2 emulation using `SYSTem:LANGuage "NRP2"`.

Suffix:

<Measurement> 1 to 8
Measurement

Usage: Query only

CALCulate<Measurement>:STATistics:MARKer:X:POSITION[:ABSolute] <value>

Effective for statistics measurements.

Sets the absolute position of the x-marker.

Suffix:

<Measurement> 1 to 8
Measurement

Parameters:

<value> Range: -200.0 to 200.0
 *RST: 0.0
 Default unit: dBm

Manual operation: See "[dBm] / [dB] marker" on page 103

CALCulate<Measurement>:STATistics:MARKer:X:POSITION:RELative <value>

Effective for statistics measurements.

Sets the x-marker relative to a power value.

Suffix:

<Measurement> 1 to 8
Measurement

Parameters:

<value> Range: -200.0 to 200.0
 *RST: 0.0
 Default unit: dB

Manual operation: See "[dBm] / [dB] marker" on page 103

CALCulate<Measurement>:STATistics:PDF:MARKer:Y:POSITION <value>

Positions the y-marker to a measurement value of the PDF statistics measurement.

Suffix:

<Measurement> 1 to 8
 Measurement

Parameters:

<value> Range: 0.0 to 10000.0
 *RST: 0.0
 Default unit: -

Manual operation: See "[%] marker" on page 103

13.6.13 NRT measurements

Further information:

- [Chapter 6.9, "NRT"](#), on page 108

[CALCulate<Measurement>:RELative<DirectionalChannel>:STATE](#)
 on page 244

CALCulate<Measurement>:RELative<DirectionalChannel>:CCDF	320
CALCulate<Measurement>:RELative<DirectionalChannel>:POWER[:MAGNitude]	320
CALCulate<Measurement>:RELative<DirectionalChannel>:RATio:RCOefficient	321
CALCulate<Measurement>:RELative<DirectionalChannel>:RATio:RFRatio	321
CALCulate<Measurement>:RELative<DirectionalChannel>:RATio:RLOSs	321
CALCulate<Measurement>:RELative<DirectionalChannel>:RATio:SWR	322
CALCulate<Measurement>:RELative<DirectionalChannel>:RATio[:MAGNitude]	322
[SENSe<Sensor>:]FUNCTion:CONCurent	323
[SENSe<Sensor>:]FUNCTion:OFF:ALL<Channel>	323
[SENSe<Sensor>:]FUNCTion:OFF[:FUNC]	323
[SENSe<Sensor>:]FUNCTion:STATE?	324
[SENSe<Sensor>:]POWER:REFLection:RANGE:AUTO	324
[SENSe<Sensor>:]POWER[:POWER]:RANGE:AUTO	324
[SENSe<Sensor>:]POWER:REFLection:RANGE:LIMit:DETECT	324
[SENSe<Sensor>:]POWER[:POWER]:RANGE:LIMit:DETECT	324
[SENSe<Sensor>:]POWER:REFLection:RANGE:LIMit[:STATE]	325
[SENSe<Sensor>:]POWER[:POWER]:RANGE:LIMit[:STATE]	325
[SENSe<Sensor>:]POWER:REFLection:RANGE:LOWER	325
[SENSe<Sensor>:]POWER[:POWER]:RANGE:LOWER	325

[SENSe<Sensor>:]POWer:REFLection:RANGe[:UPPer].....	325
[SENSe<Sensor>:]POWer[:POWer]:RANGe[:UPPer].....	325
[SENSe<Sensor>:]RRESolution.....	326

CALCulate<Measurement>:RELative<DirectionalChannel>:CCDF <value>

Sets the reference value for the cumulative distribution function (CCDF).

Suffix:

<Measurement> 1 to 8
Measurement

<DirectionalChannel> 1 to 2
1 = primary sensor, 2 = secondary sensor or 1 = forward, 2 = reflection (reverse)

Parameters:

<value> Range: 0.0 to 100.0
*RST: 50.0
Default unit: pct

Manual operation: See "[Forward Reference Value, Reflection Reference Value](#)" on page 58
See "[Reference Value](#)" on page 73

CALCulate<Measurement>:RELative<DirectionalChannel>:POWer[:MAGNitude] <value>

Sets the reference value for relative ratio measurements.

If you enter a value without unit, the unit is defined by `UNIT<Measurement>:POWer[:VALue]`. For further information, see [Chapter 13.6.1.3, "Units"](#), on page 217.

Suffix:

<Measurement> 1 to 8
Measurement

<DirectionalChannel> 1 to 2
1 = primary sensor, 2 = secondary sensor or 1 = forward, 2 = reflection (reverse)

Parameters:

<value> Range: -120.0 to +150.0
*RST: +0.0
Default unit: dBm

Manual operation: See "[Forward Reference Value, Reflection Reference Value](#)" on page 58
See "[Reference Value](#)" on page 73

CALCulate<Measurement>:RELative<DirectionalChannel>:RATio:RCOefficient
<value>

Sets the reference value for the reflection coefficient.

Suffix:

<Measurement> 1 to 8
Measurement

<DirectionalChannel> 1 to 2
1 = primary sensor, 2 = secondary sensor or 1 = forward, 2 = reflection (reverse)

Parameters:

<value> Range: 0.0 to 1.0
*RST: 0.5
Default unit: -

Manual operation: See ["Forward Reference Value, Reflection Reference Value"](#) on page 58
See ["Reference Value"](#) on page 73

CALCulate<Measurement>:RELative<DirectionalChannel>:RATio:RFRatio
<value>

Sets the reference value for the ratio of forward/reverse power.

Suffix:

<Measurement> 1 to 8
Measurement

<DirectionalChannel> 1 to 2
1 = primary sensor, 2 = secondary sensor or 1 = forward, 2 = reflection (reverse)

Parameters:

<value> Range: 0.0 to 100.0
*RST: 50.0
Default unit: pct

Manual operation: See ["Forward Reference Value, Reflection Reference Value"](#) on page 58
See ["Reference Value"](#) on page 73

CALCulate<Measurement>:RELative<DirectionalChannel>:RATio:RLOSs <value>

Sets the reference value for the return loss.

Suffix:

<Measurement> 1 to 8
Measurement

<DirectionalChannel> 1 to 2

1 = primary sensor, 2 = secondary sensor or 1 = forward, 2 = reflection (reverse)

Parameters:

<value> Range: -200.0 to 200.0
 *RST: 0.0
 Default unit: dB

Manual operation: See "[Forward Reference Value, Reflection Reference Value](#)" on page 58
 See "[Reference Value](#)" on page 73

CALCulate<Measurement>:RELative<DirectionalChannel>:RATio:SWR <value>

Sets the reference value for the standing wave ratio (SWR).

Suffix:

<Measurement> 1 to 8
 Measurement

<DirectionalChannel> 1 to 2

1 = primary sensor, 2 = secondary sensor or 1 = forward, 2 = reflection (reverse)

Parameters:

<value> Range: 0.0 to 1.0
 *RST: 0.5
 Default unit: -

Manual operation: See "[Forward Reference Value, Reflection Reference Value](#)" on page 58
 See "[Reference Value](#)" on page 73

CALCulate<Measurement>:RELative<DirectionalChannel>:RATio[:MAGNitude] <value>

Sets the reference value for relative ratio measurements.

Suffix:

<Measurement> 1 to 8
 Measurement

<DirectionalChannel> 1 to 2

1 to 2

Parameters:

<value> Default unit: pct

Manual operation: See "[Forward Reference Value, Reflection Reference Value](#)" on page 58
 See "[Reference Value](#)" on page 73

[SENSe<Sensor>:]FUNCTION:CONCurent <concurrent>

Requires the interface for R&S NRT-Z sensors (R&S NRX-B9).

Enables or disables the usage of several measurement functions simultaneously.

Suffix:

<Sensor> 101
R&S NRT directional power sensor

Parameters:

<concurrent> **ON**
Two measurement functions can be enabled simultaneously.
OFF
Only a single function can be enabled. If a new measurement function is enabled, the previously active function is disabled automatically.
*RST: ON

[SENSe<Sensor>:]FUNCTION:OFF:ALL<Channel>

Requires the interface for R&S NRT-Z sensors (R&S NRX-B9).

Disables all measurement functions for the specified channel.

Suffix:

<Sensor> 101
R&S NRT directional power sensor

<Channel> 1 to 2
1 = forward, 2 = reflection (reverse)

Usage: Event

[SENSe<Sensor>:]FUNCTION:OFF[:FUNC] <function>

Requires the interface for R&S NRT-Z sensors (R&S NRX-B9).

Disables the specified measurement function.

The query returns all disabled measurement functions.

Suffix:

<Sensor> 101
R&S NRT directional power sensor

Setting parameters:

<function> See [CALCulate<Measurement>\[:CHANnel<Channel>\]:FEED<Channel>](#) on page 239.

Usage: Setting only

[SENSe<Sensor>:]FUNCTION:STATe? <function>

Requires the interface for R&S NRT-Z sensors (R&S NRX-B9).

Queries whether the measurement function is enabled or disabled.

Suffix:

<Sensor> 101
R&S NRT directional power sensor

Query parameters:

<function> See [CALCulate<Measurement>\[:CHANnel<Channel>\]:FEED<Channel>](#) on page 239.

Usage: Query only

[SENSe<Sensor>:]POWER:REFLection:RANGe:AUTO <state>

[SENSe<Sensor>:]POWER[:POWER]:RANGe:AUTO <state>

If enabled, adapts the scaling of the graphical display once.

Suffix:

<Sensor> 1 to 128
Configured sensor connected at: port A = 1, ... , port D = 4, R&S NRX-B9 = 101, USB and LAN port = 5 to 100

Parameters:

<state> ON | OFF
*RST: ON

Manual operation: See "[Autoscale](#)" on page 113

[SENSe<Sensor>:]POWER:REFLection:RANGe:LIMit:DETECT <value>

[SENSe<Sensor>:]POWER[:POWER]:RANGe:LIMit:DETECT <value>

Effective if the Out 1 / Trig Out connector is configured as monitoring output for the power indication, for example using [\[SENSe<Sensor>:\]POWER\[:POWER\]:RANGe:LIMit\[:STATe\]](#) ON.

Defines when a logic high level (> 2.7 V) is output at the Out 1 / Trig Out connector.

Suffix:

<Sensor> 1 to 128
Configured sensor connected at: port A = 1, ... , port D = 4, R&S NRX-B9 = 101, USB and LAN port = 5 to 100

Parameters:

<value> INBound | OUTBound | HIGH
INBound
Measured power is within the range specified.
OUTBound
Measured power is out of the range defined.

HIGH

Measured power exceeds the upper scale limit.

*RST: HIGH

Manual operation: See "[Fail Voltage](#)" on page 150

[SENSe<Sensor>:]POWer:REFLection:RANGe:LIMit[:STATe] <state>

[SENSe<Sensor>:]POWer[:POWer]:RANGe:LIMit[:STATe] <state>

Enables or disables the Out 1 / Trig Out connector as a monitoring output for the power indication.

If enabled, you cannot use the connector for any other purpose.

Suffix:

<Sensor> 1 to 128

Configured sensor connected at: port A = 1, ... , port D = 4, R&S NRX-B9 = 101, USB and LAN port = 5 to 100

Parameters:

<state> *RST: OFF

Manual operation: See "[Mode](#)" on page 148

[SENSe<Sensor>:]POWer:REFLection:RANGe:LOWer <lower>

[SENSe<Sensor>:]POWer[:POWer]:RANGe:LOWer <lower>

Effective if [\[SENSe<Sensor>:\]POWer:REFLection:RANGe:AUTO](#) is disabled.

Sets the lower scale limit for the power indication.

The entry has no unit. The unit corresponds to the output unit selected by [UNIT<Measurement>:POWer\[:VALue\]](#) or [UNIT<Measurement>:POWer:RATio](#). If you change the unit, the entered value remains the same.

Suffix:

<Sensor> 1 to 128

Configured sensor connected at: port A = 1, ... , port D = 4, R&S NRX-B9 = 101, USB and LAN port = 5 to 100

Parameters:

<lower> Range: -1999.0 to 1999.0

*RST: 0.0

Manual operation: See "[Measurement for Limit Output](#)" on page 150

[SENSe<Sensor>:]POWer:REFLection:RANGe[:UPPer] <upper>

[SENSe<Sensor>:]POWer[:POWer]:RANGe[:UPPer] <upper>

Effective if [\[SENSe<Sensor>:\]POWer:REFLection:RANGe:AUTO](#) is disabled.

Sets the lower scale limit for the power indication. For further details, see [\[SENSe<Sensor>:\]POWer\[:POWer\]:RANGe:LOWer](#) on page 325.

Suffix:

<Sensor> 1 to 128
Configured sensor connected at: port A = 1, ... , port D = 4, R&S NRX-B9 = 101, USB and LAN port = 5 to 100

Parameters:

<upper> Range: -1999.0 to 1999.0
*RST: 1.0

Manual operation: See "[Measurement for Limit Output](#)" on page 150

[SENSe<Sensor>:]RRESolution <rres>

Requires the interface for R&S NRT-Z sensors (R&S NRX-B9).

Configures the resolution of the measurement.

Suffix:

<Sensor> 101
R&S NRT directional power sensor

Parameters:

<rres> LOW | HIGH
HIGH
Equals `CALCulate<Measurement>:RESolution 000I`.
LOW
All other settings.
*RST: LOW

Manual operation: See "[Resolution](#)" on page 54

13.6.14 Querying measurement results

<code>CALCulate<Measurement>:COUNT:DATA?</code>	326
<code>CALCulate<Measurement>:DATA?</code>	327
<code>CALCulate<Measurement>:MAXimum:DATA?</code>	327
<code>CALCulate<Measurement>:MINimum:DATA?</code>	327
<code>CALCulate<Measurement>:MEAN:DATA?</code>	327
<code>CALCulate<Measurement>:PTPeak:DATA?</code>	327
<code>CALCulate<Measurement>:SDEVIation:DATA?</code>	327

CALCulate<Measurement>:COUNT:DATA?

Queries the number of measured values that are included for the calculation of the mean value and standard deviation.

Suffix:

<Measurement> 1 to 8
Measurement

Usage: Query only

CALCulate<Measurement>:DATA?

Queries the measurement result.

Suffix:

<Measurement> 1 to 8
 Measurement

Usage: Query only

CALCulate<Measurement>:MAXimum:DATA?**CALCulate<Measurement>:MINimum:DATA?**

Queries the maximum/minimum of all measured values.

Suffix:

<Measurement> 1 to 8
 Measurement

Usage: Query only

CALCulate<Measurement>:MEAN:DATA?

Queries the mean value of all measured values. The mean value is reset if the auxiliary values are reset.

Suffix:

<Measurement> 1 to 8
 Measurement

Usage: Query only

CALCulate<Measurement>:PTPeak:DATA?

Queries the peak-to-peak distance (maximum to minimum) of the measured values.

Suffix:

<Measurement> 1 to 8
 Measurement

Usage: Query only

CALCulate<Measurement>:SDEVIation:DATA?

Queries the standard deviation of all measured values. The standard deviation is calculated and reset together with the mean value, [CALCulate<Measurement>:MEAN:DATA?](#).

Suffix:

<Measurement> 1 to 8
 Measurement

Usage: Query only

13.7 Calculation functions

Further information:

- "Channel Calculation Function" on page 70
- Chapter 13.3, "Addressing measurements and power sensors", on page 187

13.7.1 Selecting a calculation function

CALCulate<Measurement>:MATH[:EXPRession]..... 328

CALCulate<Measurement>:MATH[:EXPRession]:CATalog?.....329

CALCulate<Measurement>:MATH[:EXPRession] [<expression>]

Selects a channel calculation function that processes the results of one or two power sensors. The result of this calculation is made available as a measured value.

SENS_n is assigned as primary sensor, SENS_m as secondary sensor.

Table 13-4: <expression> parameters for absolute power measurements

Channel calculation function	<expression>	Description
Single measurement	" (SENS _n) "	Measured value of sensor A, B, C or D
Sum	" (SENS _n +SENS _m) "	Sum of the values measured by sensor n and sensor m
Difference	" (SENS _n -SENS _m) "	Difference between the measured values of sensor n and sensor m
With n and m= 1, 2, 3, 4 or A, B, C, D		

Table 13-5: <expression> parameters for relative power measurements

Channel calculation function	<expression>	Description
Ratio	" (SENS _n /SENS _m) "	Quotient of the values measured by sensor n and sensor m
Standing wave ratio	"SWR (SENS _n , SENS _m) "	Standing wave ratio. No output unit. $\frac{1 + \sqrt{\text{SENS}_m / \text{SENS}_n}}{1 - \sqrt{\text{SENS}_m / \text{SENS}_n}}$ Sensor n measures the forward power of a wave. Sensor m measures the reflected power.
With n and m = 1, 2, 3, 4 or A, B, C, D		

Channel calculation function	<expression>	Description
Reflection coefficient	"RCO (SENSn, SENSm) "	Reflection coefficient of a DUT. No output unit. $\sqrt{\text{SENSm}/\text{SENSn}}$ Sensor n measures the forward power of a wave. Sensor m measures the reflected power.
Return loss	"RLOS (SENSn, SENSm) "	Return loss of a DUT. The output unit is dB. $10 \times \log \frac{\text{SENSm}/\text{SENSn}}{\text{SENSm}/\text{SENSn}}$ Sensor n measures the forward power of a wave. Sensor m measures the reflected power.
Reflection ratio	"REFL (SENSn, SENSm) "	Reflection ratio of a DUT. The output unit is percent. $100 \frac{\text{SENSm}}{\text{SENSn}}$ Sensor n measures the forward power of a wave. Sensor m measures the reflected power.
With n and m = 1, 2, 3, 4 or A, B, C, D		

Table 13-6: Additional <expression> parameters for queries

<expression>	Description
OFF	No channel calculation function is selected.
-	For SENSn or SENSm, if no primary or secondary sensor is selected.

Suffix:

<Measurement> 1 to 8
Measurement

Parameters:

<expression> See [Table 13-4](#) and [Table 13-5](#). The unit is set by
 UNIT<Measurement>:POWER[:VALue] or
 UNIT<Measurement>:POWER:RATio.
 The query returns two additional expressions, see [Table 13-6](#).
 *RST: Depends on the selected channel.
 Default unit: Depends on <expression> and the set unit.

Manual operation: See "[Channel Calculation Function](#)" on page 70

CALCulate<Measurement>:MATH[:EXPRession]:CATalog? [<expressions>]

Queries all channel calculation functions supported by CALCulate<Measurement>:MATH[:EXPRession].

Suffix:

<Measurement> 1 to 8
Measurement

Query parameters:

<expressions>

Usage: Query only

Manual operation: See "[Channel Calculation Function](#)" on page 70

13.8 Configuring sensors

- [Setting the frequency](#)..... 330
- [Sensor modes](#)..... 331
- [Sensor corrections](#)..... 335
- [Sensor filters](#)..... 340
- [Sensor ranges](#)..... 348
- [Standardized signals](#)..... 351
- [Frequency selective power sensors](#)..... 364
- [NRT measurement type](#)..... 366

13.8.1 Setting the frequency

- [\[SENSe<Sensor>:\]FREQUency:FIXed](#)..... 330
- [\[SENSe<Sensor>:\]FREQUency\[:CW\]](#)..... 330
- [\[SENSe<Sensor>:\]FREQUency:TRACk](#)..... 330

[SENSe<Sensor>:]FREQUency:FIXed <frequency>

[SENSe<Sensor>:]FREQUency[:CW] <frequency>

Sets the carrier frequency of the applied signal. This value is used for frequency-response correction of the measurement result.

Suffix:

<Sensor> 1 to 128
Configured sensor connected at: port A = 1, ... , port D = 4, R&S NRX-B9 = 101, USB and LAN port = 5 to 100

Parameters:

<frequency> Range: 0.0 to 110.0e9
 *RST: 1.0e9
 Default unit: Hz

Manual operation: See "[\[Freq\]](#)" on page 28

[SENSe<Sensor>:]FREQUency:TRACk <state>

Enables or disables the frequency tracker of the power sensor, if available.

Suffix:

<Sensor> 1 to 128
Configured sensor connected at: port A = 1, ... , port D = 4, R&S NRX-B9 = 101, USB and LAN port = 5 to 100

Parameters:

<state> OFF | ON
*RST: OFF

13.8.2 Sensor modes

Further information:

- [Chapter 7.1, "Mode settings"](#), on page 115
- [Chapter 13.8.8.1, "NRT mode settings"](#), on page 366

CALCulate<Measurement>[:CHANnel<Channel>]:BURSt:TIMing:EXCLude:STARt.....	331
CALCulate<Measurement>[:CHANnel<Channel>]:BURSt:TIMing:EXCLude:STOP.....	332
CALCulate<Measurement>[:CHANnel<Channel>]:CORRection:DCYCLe:STATe.....	332
CALCulate<Measurement>[:CHANnel<Channel>]:CORRection:DCYCLe[:VALue].....	332
CALCulate<Measurement>[:CHANnel<Channel>]:TRACe:ESAMpling.....	333
CALCulate<Measurement>[:CHANnel<Channel>]:SAMPling.....	333
CALCulate<Measurement>[:CHANnel<Channel>][:POWer]:BURSt:DTOLerance.....	334
CALCulate<Measurement>[:CHANnel<Channel>][:POWer][:AVG]:APERture[:VALue].....	334
CALCulate<Measurement>[:CHANnel<Channel>][:POWer][:AVG]:SMOothing[:STATe].....	335
CALCulate<Measurement>:TRACe:MEASurement:TRANSition:ESAMpling:AUTO[:STATe]....	335

CALCulate<Measurement>[:CHANnel<Channel>]:BURSt:TIMing:EXCLude:STARt
<value>

Effective for burst average measurements.

Sets the time interval at the beginning of bursts that is excluded from the measurement. Thus, signal overshoots are omitted.

Suffix:

<Measurement> 1 to 8
Measurement

<Channel> 1 to 2
1 = primary sensor, 2 = secondary sensor

Parameters:

<value> Range: 0.0 to 15.0
*RST: 0.0
Default unit: s

Manual operation: See ["Exclude from Start, Exclude from End"](#) on page 118

CALCulate<Measurement>[:CHANnel<Channel>]:BURSt:TIMing:EXCLude:STOP
<value>

Effective for burst average measurements.

Sets the time interval at the end of bursts that is excluded from the measurement. Thus, signal overshoots are omitted.

Suffix:

<Measurement> 1 to 8
 Measurement

<Channel> 1 to 2
 1 = primary sensor, 2 = secondary sensor

Parameters:

<value> Range: 0.0 to 15.0
 *RST: 0.0
 Default unit: s

Manual operation: See ["Exclude from Start, Exclude from End"](#) on page 118

CALCulate<Measurement>[:CHANnel<Channel>]:CORRection:DCYCLe:STATe
<state>

Effective for continuous average measurements.

Enables or disables the duty cycle correction.

Suffix:

<Measurement> 1 to 8
 Measurement

<Channel> 1 to 2
 1 = primary sensor, 2 = secondary sensor

Parameters:

<state> *RST: OFF

Manual operation: See ["Duty Cycle State"](#) on page 116

CALCulate<Measurement>[:CHANnel<Channel>]:CORRection:DCYCLe[:VALue]
<duty_cycle>

Effective for continuous average measurements.

Sets the duty cycle for measuring pulse-modulated signals. The duty cycle defines the percentage of one period during which the signal is active. If the duty cycle is enabled, the R&S NRX takes this percentage into account when calculating the signal pulse power from the average power.

For thermal power sensors or multipath power sensors, the duty cycle correction is the only way to determine the power of pulsed signals.

Suffix:

<Measurement> 1 to 8
Measurement

<Channel> 1 to 2
1 = primary sensor, 2 = secondary sensor

Parameters:

<duty_cycle> Range: 0.001 to 100.0
*RST: 50.0
Default unit: pct

Manual operation: See "[Duty Cycle](#)" on page 116

CALCulate<Measurement>[:CHANnel<Channel>]:TRACe:ESAMpling <value>

Effective for trace measurements.

Enables or disables the automatic equivalent sampling that allows for high resolution measurements.

Suffix:

<Measurement> 1 to 8
Measurement

<Channel> 1 to 2
1 = primary sensor, 2 = secondary sensor

Parameters:

<value> *RST: ON

Manual operation: See "[Equivalent Time Sampling](#)" on page 117

CALCulate<Measurement>[:CHANnel<Channel>]:SAMPling <value>

Effective for continuous average measurements.

Sets the sampling rate.

If the sampling frequency is located within the video bandwidth, aliasing can occur, that is when spectral components near the sampling frequency cause beating effects. If you change the sampling rate, the beating effects usually disappear.

Suffix:

<Measurement> 1 to 8
Measurement

<Channel> 1 to 2
1 = primary sensor, 2 = secondary sensor

Parameters:

<value> FREQ1 | FREQ2
FREQ1
Normal sampling rate

FREQ2

Lower sampling rate

Recommended to avoid measurement errors caused due to aliasing effects. However, this setting extends the measurement time.

*RST: FREQ1

Manual operation: See "[Sampling Rate](#)" on page 117

CALCulate<Measurement>[:CHANnel<Channel>][:POWer]:BURSt:DTOLerance
 <value>

Effective for burst average measurements.

Detects the falling edge of a burst. If the power keeps low for at least the set time, the end of the burst is assumed. Modulation-specific power drops that are shorter than the set value are ignored.

See also [Chapter 6.3, "Burst average"](#), on page 74.

Suffix:

<Measurement> 1 to 8
 Measurement

<Channel> 1 to 2
 1 = primary sensor, 2 = secondary sensor

Parameters:

<value> Range: 0.0 to 0.3
 *RST: 0.0
 Default unit: s

Manual operation: See "[Dropout Tolerance](#)" on page 118

CALCulate<Measurement>[:CHANnel<Channel>][:POWer][:AVG]:APERTure[:
VALue] <value>

Effective for continuous average measurements.

Sets the width of the sampling window.

When measuring modulated signals, the measurement can show fluctuation due to the modulation. If that is the case, adapt the size of the sampling window exactly to the modulation period to get an optimally stable display. If the modulation period varies or is not precisely known, you can also set `CALCulate<Measurement>[:CHANnel<Channel>][:POWer][:AVG]:SMOothing[:STATe] ON`.

Suffix:

<Measurement> 1 to 8
 Measurement

<Channel> 1 to 2
 1 = primary sensor, 2 = secondary sensor

Parameters:

<value> Range: 8.3e-9 to 30.0
 *RST: 0.01
 Default unit: s

Manual operation: See "[Aperture](#)" on page 117

**CALCulate<Measurement>[:CHANnel<Channel>][:POWer][:AVG]:SMOothing[:
 STATE] <value>**

Effective for continuous average measurements.

Enables or disables the smoothing filter, a steep-edge digital lowpass filter. The filter reduces result fluctuations caused by modulation.

Suffix:

<Measurement> 1 to 8
 Measurement

<Channel> 1 to 2
 1 = primary sensor, 2 = secondary sensor

Parameters:

<value> See "[Smoothing](#)" on page 118.
 *RST: OFF

Manual operation: See "[Smoothing](#)" on page 118

**CALCulate<Measurement>:TRACe:MEASurement:TRANSition:ESAMpling:
 AUTO[:STATE] <value>**

Effective for pulse analysis measurements.

Enables or disables the automatic equivalent sampling that allows for high-resolution measurements.

Suffix:

<Measurement> 1 to 8
 Measurement

Parameters:

<value> *RST: ON

Manual operation: See "[Equivalent Time Sampling](#)" on page 117

13.8.3 Sensor corrections

Further information:

- [Chapter 7.2, "Correction settings"](#), on page 119
- [Chapter 13.13, "Managing setups and correction tables"](#), on page 392
- [Chapter 13.8.8.2, "NRT correction settings"](#), on page 370

[SENSe<Sensor>:]CORRection:SPDevice:LIST?	336
[SENSe<Sensor>:]CORRection:SPDevice:SElect	336
[SENSe<Sensor>:]CORRection:SPDevice:STATe	336
[SENSe<Sensor>:]RGAMma[:MAGNitude]	337
[SENSe<Sensor>:]RGAMma:PHASe	337
CALCulate<Measurement>[:CHANnel<Channel>]:CORRection:OFFSet:STATe	337
CALCulate<Measurement>[:CHANnel<Channel>]:CORRection:OFFSet:TABLE:INDeX	338
CALCulate<Measurement>[:CHANnel<Channel>]:CORRection:OFFSet:TABLE[:STATe]	338
CALCulate<Measurement>[:CHANnel<Channel>]:CORRection:OFFSet[:MAGNitude]	339
CALCulate<Measurement>[:CHANnel<Channel>]:SGAMma:CORRection:STATe	339
CALCulate<Measurement>[:CHANnel<Channel>]:SGAMma:PHASe	339
CALCulate<Measurement>[:CHANnel<Channel>]:SGAMma[:MAGNitude]	340

[SENSe<Sensor>:]CORRection:SPDevice:LIST?

Queries the list of the S-parameter data sets that have been loaded to the power sensor. The result of the query indicates the consecutive number and mnemonic of each data set.

Suffix:

<Sensor> 1 to 128
 Configured sensor connected at: port A = 1, ... , port D = 4, R&S
 NRX-B9 = 101, USB and LAN port = 5 to 100

Usage: Query only

Manual operation: See "[S-Parameter List](#)" on page 120

[SENSe<Sensor>:]CORRection:SPDevice:SElect <num>

Selects a data set for S-parameter correction that has been loaded to the power sensor.

Suffix:

<Sensor> 1 to 128
 Configured sensor connected at: port A = 1, ... , port D = 4, R&S
 NRX-B9 = 101, USB and LAN port = 5 to 100

Parameters:

<num> Range: 1 to 1999
 *RST: 1

Manual operation: See "[S-Parameter List](#)" on page 120

[SENSe<Sensor>:]CORRection:SPDevice:STATe <state>

Enables or disables the S-parameter correction. If enabled, the power sensor uses the S-parameter data set selected by `[SENSe<Sensor>:]CORRection:SPDevice:SElect`.

For some power sensors, the S-parameter correction is always activated. If you try to deactivate the S-parameter correction for such a power sensor, a SCPI error is generated.

Suffix:

<Sensor> 1 to 128
Configured sensor connected at: port A = 1, ... , port D = 4, R&S NRX-B9 = 101, USB and LAN port = 5 to 100

Parameters:

<state> ON | OFF
*RST: OFF

Manual operation: See "[S-Parameter List](#)" on page 120

[SENSe<Sensor>:]RGAMma[:MAGNitude] <magnitude>

Sets the magnitude of the complex reflection coefficient of the source, Γ_{source} .

A value of 0.0 corresponds to an ideal matched source. A value of 1.0 corresponds to total reflection.

Suffix:

<Sensor> 1 to 128
Configured sensor connected at: port A = 1, ... , port D = 4, R&S NRX-B9 = 101, USB and LAN port = 5 to 100

Parameters:

<magnitude> **0.0**
Disables the compensation.
Range: -200.0 to 200.0
*RST: 0.0
Default unit: -

[SENSe<Sensor>:]RGAMma:PHASe <phase_angle>

Sets the phase angle of the complex reflection coefficient of the source, Γ_{source} .

Suffix:

<Sensor> 1 to 128
Configured sensor connected at: port A = 1, ... , port D = 4, R&S NRX-B9 = 101, USB and LAN port = 5 to 100

Parameters:

<phase_angle> Range: 0.0 to 360.0
*RST: 0.0
Default unit: deg

CALCulate<Measurement>[:CHANnel<Channel>]:CORRection:OFFSet:STATe <state>

Enables or disables the offset correction.

Suffix:

<Measurement> 1 to 8
Measurement

<Channel> 1 to 2
1 = primary sensor, 2 = secondary sensor or 1 = forward, 2 = reflection (reverse)

Parameters:

<state> ON | OFF
*RST: OFF

Manual operation: See ["Offset State"](#) on page 120
See ["Offset"](#) on page 131

**CALCulate<Measurement>[:CHANnel<Channel>]:CORRection:OFFSet:TABLE:
INDEX <value>**

Selects one of the available offset tables.

Suffix:

<Measurement> 1 to 8
Measurement

<Channel> 1 to 2
1 = primary sensor, 2 = secondary sensor

Setting parameters:

<value> Range: 1 to 10
*RST: 1

Usage: Setting only

Manual operation: See ["Frequency dependent offset table"](#) on page 121

**CALCulate<Measurement>[:CHANnel<Channel>]:CORRection:OFFSet:TABLE[:
STATE] <state>**

Enables or disables the selected table.

If enabled, the measurement results are corrected using the specified offset. If the exact frequency value is not available in the table, the values of the table are interpolated. If the selected frequency is outside the specified frequency range, the first or last offset value of the table is used.

Suffix:

<Measurement> 1 to 8
Measurement

<Channel> 1 to 2
1 = primary sensor, 2 = secondary sensor

Setting parameters:

<state> *RST: OFF

Usage: Setting only

Manual operation: See "[Frequency dependent offset active](#)" on page 121

**CALCulate<Measurement>[:CHANnel<Channel>]:CORRection:OFFSet[
MAGNitude] <value>**

Effective if [CALCulate<Measurement>\[:CHANnel<Channel>\]:CORRection:OFFSet:STATe](#) ON is set.

Considers the transmission loss in a cable that connects the desired measurement point, set by [INPut<Sensor>:PORT:POSition](#), and the power sensor.

Suffix:

<Measurement> 1 to 8
Measurement

<Channel> 1 to 2
1 = primary sensor, 2 = secondary sensor or 1 = forward, 2 = reflection (reverse)

Parameters:

<value> Range: -200.0 to 200.0
*RST: 0.0
Default unit: dB

Manual operation: See "[Offset](#)" on page 120
See "[Offset](#)" on page 131

**CALCulate<Measurement>[:CHANnel<Channel>]:SGAMma:CORRection:STATe
<value>**

Enables or disables gamma correction. See also "[Gamma Correction](#)" on page 121.

Suffix:

<Measurement> 1 to 8
Measurement

<Channel> 1 to 2
1 = primary sensor, 2 = secondary sensor

Parameters:

<value> *RST: OFF

Manual operation: See "[Gamma Correction](#)" on page 121

CALCulate<Measurement>[:CHANnel<Channel>]:SGAMma:PHASe <value>

Effective if [CALCulate<Measurement>\[:CHANnel<Channel>\]:SGAMma:CORRection:STATe](#) ON is set.

Sets the phase angle of the complex reflection coefficient of the source.

Suffix:

<Measurement>	1 to 8 Measurement
<Channel>	1 to 2 1 = primary sensor, 2 = secondary sensor

Parameters:

<value>	Range: -360.0 to 360.0
	*RST: 0.0
	Default unit: deg

Manual operation: See "[Gamma Phase](#)" on page 122

CALCulate<Measurement>[:CHANnel<Channel>]:SGAMma[:MAGNitude] <value>

Effective if [CALCulate<Measurement>\[:CHANnel<Channel>\]:SGAMma:CORRection:STATe](#) ON is set.

Sets the magnitude of the complex reflection coefficient of the source.

Suffix:

<Measurement>	1 to 8 Measurement
<Channel>	1 to 2 1 = primary sensor, 2 = secondary sensor

Parameters:

<value>	Range: 0.0 to 1.0
	*RST: 0.0
	Default unit: -

Manual operation: See "[Gamma Magnitude](#)" on page 122

13.8.4 Sensor filters

Further information:

- [Chapter 7.3, "Filter settings"](#), on page 122
- [Chapter 13.8.8.3, "NRT filter settings"](#), on page 373

[SENSe<Sensor>:]AVERAge:COUNT:AUTO:RESolution	341
[SENSe<Sensor>:]AVERAge:RESet	341
CALCulate<Measurement>[:CHANnel<Channel>]:AVERAge:COUNT:AUTO:MTIME	342
CALCulate<Measurement>[:CHANnel<Channel>]:AVERAge:COUNT:AUTO:NSRatio	342
CALCulate<Measurement>[:CHANnel<Channel>]:AVERAge:COUNT:AUTO:SLOT	342
CALCulate<Measurement>[:CHANnel<Channel>]:AVERAge:COUNT:AUTO:TYPE	343
CALCulate<Measurement>[:CHANnel<Channel>]:AVERAge:TCONtrol:AUTO	343
CALCulate<Measurement>[:CHANnel<Channel>]:AVERAge:TCONtrol[:ENUM]	344
CALCulate<Measurement>[:CHANnel<Channel>]:AVERAge:TYPE	345
CALCulate<Measurement>[:CHANnel<Channel>]:AVERAge[:STATe]	345
CALCulate<Measurement>[:CHANnel<Channel>]:TRACe:AVERAge:COUNT[:VALue]	345

CALCulate<Measurement>[:CHANnel<Channel>]:TRACe:AVERage:TCONtrol:AUTO.....	346
CALCulate<Measurement>[:CHANnel<Channel>]:TRACe:AVERage:TCONtrol[:ENUM].....	346
CALCulate<Measurement>[:CHANnel<Channel>]:TRACe:AVERage[:STATe].....	347
CALCulate<Measurement>[:CHANnel<Channel>][:POWer]:NCORrection[:STATe].....	347
CALCulate<Measurement>[:CHANnel<Channel>][:POWer]:VBWidth:ENUM.....	348

[SENSe<Sensor>:]AVERage:COUNT:AUTO:RESolution <resolution>

Defines the number of significant places for linear units and the number of decimal places for logarithmic units which should be free of noise in the measurement result.

The setting is only taken into account, if:

- CALCulate<Measurement>[:CHANnel<Channel>]:AVERage:COUNT:AUTO:TYPE RES
- CALCulate<Measurement>[:CHANnel<Channel>]:AVERage:COUNT:AUTO[:STATe] ON

Suffix:

<Sensor> 1 to 128
Configured sensor connected at: port A = 1, ... , port D = 4, R&S NRX-B9 = 101, USB and LAN port = 5 to 100

Parameters:

<resolution> Indicates the number of significant digits.

1	
1	
2	
0.1	
3	
0.01	
4	
0.001	
Range:	1 to 4
*RST:	3

[SENSe<Sensor>:]AVERage:RESet

Effective for continuous average, burst average, time gate measurements.

Clears the filter buffer.

Suffix:

<Sensor> 1 to 128
Configured sensor connected at: port A = 1, ... , port D = 4, R&S NRX-B9 = 101, USB and LAN port = 5 to 100

Usage: Event

Manual operation: See "[Clear Filter Buffer](#)" on page 124

CALCulate<Measurement>[:CHANnel<Channel>]:AVERage:COUNT:AUTO:MTIME
 <value>

Effective for continuous average, burst average measurements, if

`CALCulate<Measurement>[:CHANnel<Channel>]:AVERage:COUNT:AUTO:TYPE RES` is set.

Sets an upper limit for the settling time of the auto-averaging filter that is never exceeded, thus limiting the length of the filter.

Suffix:

<Measurement> 1 to 8
 Measurement

<Channel> 1 to 2
 1 = primary sensor, 2 = secondary sensor

Parameters:

<value> Range: 0.01 to 1000.0
 *RST: 1.0
 Default unit: s

Manual operation: See "[Maximum Settling Time](#)" on page 124

CALCulate<Measurement>[:CHANnel<Channel>]:AVERage:COUNT:AUTO:NSRatio <value>

Effective for continuous average, burst average measurements, if

`CALCulate<Measurement>[:CHANnel<Channel>]:AVERage:COUNT:AUTO:TYPE NSR` is set.

Sets the averaging number so that the intrinsic noise of the power sensor does not exceed the specified value.

Suffix:

<Measurement> 1 to 8
 Measurement

<Channel> 1 to 2
 1 = primary sensor, 2 = secondary sensor

Parameters:

<value> Range: 100e-6 to 1.0
 *RST: 1.0
 Default unit: dB

Manual operation: See "[Noise Content](#)" on page 124

CALCulate<Measurement>[:CHANnel<Channel>]:AVERage:COUNT:AUTO:SLOT
 <value>

Effective for continuous average, burst average measurements.

Sets a timeslot from which the measured value is used to determine the filter length automatically. The timeslot number must not exceed the number of the currently set timeslots.

Suffix:

<Measurement> 1 to 8
Measurement

<Channel> 1 to 2
1 = primary sensor, 2 = secondary sensor

Parameters:

<value> Range: 1 to 128
*RST: 1

Manual operation: See "[Timeslot](#)" on page 125

CALCulate<Measurement>[:CHANnel<Channel>]:AVERage:COUNT:AUTO:TYPE
<value>

Effective for continuous average, burst average measurements.

Sets the autofilter.

Suffix:

<Measurement> 1 to 8
Measurement

<Channel> 1 to 2
1 = primary sensor, 2 = secondary sensor

Parameters:

<value> RESolution | NSRatio

RESolution

Sets the averaging number so that the intrinsic noise of the power sensor does not exceed the value specified by [CALCulate<Measurement>\[:CHANnel<Channel>\]:AVERage:COUNT:AUTO:NSRatio](#).

NSRatio

Limits the averaging number as specified by [CALCulate<Measurement>\[:CHANnel<Channel>\]:AVERage:COUNT:AUTO:MTIME](#).

*RST: RESolution

Manual operation: See "[Fixed Noise Mode](#)" on page 124

CALCulate<Measurement>[:CHANnel<Channel>]:AVERage:TCONtrol:AUTO
<state>

Effective for continuous average, burst average, pulse analysis, timeslot, statistics measurements.

Enables or disables the automatic termination control. See also [CALCulate<Measurement>\[:CHANnel<Channel>\]:AVERage:TCONtrol\[:ENUM\]](#) on page 344.

Suffix:

<Measurement> 1 to 8
Measurement

<Channel> 1 to 2
1 = primary sensor, 2 = secondary sensor

Parameters:

<state> *RST: ON

Manual operation: See "[Moving Average State](#)" on page 125

CALCulate<Measurement>[:CHANnel<Channel>]:AVERage:TCONtrol[:ENUM]
<mode>

Effective for continuous average, burst average, pulse analysis, timeslot, statistics measurements.

Defines how the measurement results are output. This is called termination control.

Suffix:

<Measurement> 1 to 8
Measurement

<Channel> 1 to 2
1 = primary sensor, 2 = secondary sensor

Parameters:

<mode> MOVing | REPeat

If you use [SYSTem:PRESet](#) instead of *RST, the RST value differs. See [Table 13-17](#).

MOVing

Outputs intermediate values to facilitate early detection of changes in the measured quantity. In the settled state, that means when the number of measurements specified by the average count has been performed, a moving average is output.

REPeat

Specifies that a measurement result is not output until the entire measurement has been completed. This means that the number of measurement cycle repetitions is equal to the set average count. If the average count is large, the measurement time can be very long.

The average count is set using [CALCulate<Measurement>\[:CHANnel<Channel>\]:AVERage:COUNT\[:VALue\]](#) on page 374.

*RST: MOVing

Manual operation: See "[Moving Average](#)" on page 125

CALCulate<Measurement>[:CHANnel<Channel>]:AVERAge:TYPE <type>

Requires an R&S frequency selective power sensor.

Sets the averaging method. See also the user manual of the power sensor.

Suffix:

<Measurement> 1 to 8
 Measurement

<Channel> 1 to 2
 1 = primary sensor, 2 = secondary sensor

Parameters:

<type> POWer | VIDeo | LINear
 *RST: POWer

Manual operation: See "[Averaging Domain](#)" on page 125

CALCulate<Measurement>[:CHANnel<Channel>]:AVERAge[:STATe] <value>

Enables or disables the averaging filter. If enabled, the number of measured values is averaged. Averaging reduces the effect of noise so that more reliable results are obtained.

Suffix:

<Measurement> 1 to 8
 Measurement

<Channel> 1 to 2
 1 = primary sensor, 2 = secondary sensor

Parameters:

<value> *RST: ON

Manual operation: See "[Filter State](#)" on page 123

CALCulate<Measurement>[:CHANnel<Channel>]:TRACe:AVERAge:COUNT[:VALue] <value>

Effective for trace measurements.

Sets the number of readings that are averaged for one measured value. The higher the count, the lower the noise, and the longer it takes to obtain a measured value.

Suffix:

<Measurement> 1 to 8
 Measurement

<Channel> 1 to 2
 1 = primary sensor, 2 = secondary sensor

Parameters:

<value> If the entered filter length is not a 2ⁿ value, the value is rounded to the next 2ⁿ value without an error message.

Range: 1 to 65536

*RST: 4

Manual operation: See "[Filter Length](#)" on page 123

**CALCulate<Measurement>[:CHANnel<Channel>]:TRACe:AVERAge:TCONtrol:
AUTO <state>**

Effective for trace measurements.

Enables or disables the automatic termination control. See also

[CALCulate<Measurement>\[:CHANnel<Channel>\]:TRACe:AVERAge:TCONtrol\[:ENUM\]](#) on page 346.

Suffix:

<Measurement> 1 to 8
Measurement

<Channel> 1 to 2
1 = primary sensor, 2 = secondary sensor

Parameters:

<state> *RST: ON

Manual operation: See "[Moving Average State](#)" on page 125

**CALCulate<Measurement>[:CHANnel<Channel>]:TRACe:AVERAge:TCONtrol[:
ENUM] <mode>**

Effective for trace measurements.

Defines how the measurement results are output. This is called termination control.

Suffix:

<Measurement> 1 to 8
Measurement

<Channel> 1 to 2
1 = primary sensor, 2 = secondary sensor

Parameters:

<mode> MOVing | REPEAT

If you use [SYSTem:PRESet](#) instead of *RST, the RST value differs. See [Table 13-17](#).

MOVing

Outputs intermediate values to facilitate early detection of changes in the measured quantity. In the settled state, that means when the number of measurements specified by the average count has been performed, a moving average is output.

REPeat

Specifies that a measurement result is not output until the entire measurement has been completed. This means that the number of measurement cycle repetitions is equal to the set average count. If the average count is large, the measurement time can be very long.

The average count is set using `CALCulate<Measurement>[:CHANnel<Channel>]:TRACe:AVERAge:COUNT[:VALue]`.

*RST: MOVing

Manual operation: See "[Moving Average](#)" on page 125

CALCulate<Measurement>[:CHANnel<Channel>]:TRACe:AVERAge[:STATe]
<value>

Effective for trace measurements.

Enables or disables the averaging filter. If enabled, the number of measured values is averaged. Averaging reduces the effect of noise so that more reliable results are obtained.

Suffix:

<Measurement> 1 to 8
Measurement

<Channel> 1 to 2
1 = primary sensor, 2 = secondary sensor

Parameters:

<value> *RST: ON

Manual operation: See "[Filter State](#)" on page 123

CALCulate<Measurement>[:CHANnel<Channel>][:POWER]:NCORrection[:STATe]
<state>

Effective for R&S frequency selective power sensors.

Enables or disables the noise cancellation.

Suffix:

<Measurement> 1 to 8
Measurement

<Channel> 1 to 2
1 = primary sensor, 2 = secondary sensor

Parameters:

<state> *RST: OFF

CALCulate<Measurement>[:CHANnel<Channel>][:POWer]:VBWidth:ENUM
<value>

Requires a wideband power sensor.

Sets the video filter bandwidth. Reducing the video bandwidth also increases the trigger sensitivity.

Suffix:

<Measurement> 1 to 8
 Measurement

<Channel> 1 to 2
 1 = forward, 2 = reflection (reverse)

Parameters:

<value> EFULI | E5M | E1M5 | E0M3

EFULI

Full

E5M

5 MHz

E1M5

1.5 MHz

E0M3

300 kHz

*RST: EFULI

Manual operation: See "Video Bandwidth" on page 126

13.8.5 Sensor ranges

Further information:

- [Chapter 7.4, "Range settings"](#), on page 126

CALCulate<Measurement>[:CHANnel<Channel>]:INPut:ATTenuation:AUTO.....	348
CALCulate<Measurement>[:CHANnel<Channel>]:INPut:ATTenuation[:VALue].....	349
CALCulate<Measurement>[:CHANnel<Channel>][:POWer][:AVG]:RANGe:AUTO.....	349
CALCulate<Measurement>[:CHANnel<Channel>][:POWer][:AVG]:RANGe:CLEVel:STATe....	350
CALCulate<Measurement>[:CHANnel<Channel>][:POWer][:AVG]:RANGe:CLEVel[:VALue]..	350
CALCulate<Measurement>[:CHANnel<Channel>][:POWer][:AVG]:RANGe[:VALue].....	350

CALCulate<Measurement>[:CHANnel<Channel>]:INPut:ATTenuation:AUTO
<auto>

Requires an R&S frequency selective power sensor.

Enables or disables the automatic setting of the input attenuation.

Suffix:

<Measurement> 1 to 8
 Measurement

<Channel> 1 to 2
1 = primary sensor, 2 = secondary sensor

Parameters:

<auto> OFF | ON | ONCE
ONCE
Adjusts the input attenuation one time, then disables the automatic setting.
*RST: OFF

Manual operation: See "[Attenuator Mode](#)" on page 128

CALCulate<Measurement>[:CHANnel<Channel>]:INPut:ATTenuation[:VALue]
<value>

Requires an R&S frequency selective power sensor.

Effective if [CALCulate<Measurement>\[:CHANnel<Channel>\]:INPut:ATTenuation:AUTO](#) OFF is set.

Sets the input attenuation.

Suffix:

<Measurement> 1 to 8
Measurement

<Channel> 1 to 2
1 = primary sensor, 2 = secondary sensor

Parameters:

<value> Only two values are possible, 0.0 dB and 30.0 dB. The entered value is rounded to the next value.
Range: 0.0 to 30.0
*RST: 30.0
Default unit: dB

Manual operation: See "[Attenuation](#)" on page 128

CALCulate<Measurement>[:CHANnel<Channel>][:POWer][:AVG]:RANGe:AUTO
<value>

Enables or disables the automatic measurement path selection.

Suffix:

<Measurement> 1 to 8
Measurement

<Channel> 1 to 2
1 = primary sensor, 2 = secondary sensor

Parameters:

<value> *RST: ON

Manual operation: See "[Range State](#)" on page 127

CALCulate<Measurement>[:CHANnel<Channel>][:POWer][:AVG]:RANGe:CLEVel:STATE <value>

Effective if `CALCulate<Measurement>[:CHANnel<Channel>][:POWer][:AVG]:RANGe:AUTO` ON is set.

Enables or disables the reduction of the transition range between the measurement paths, set by `CALCulate<Measurement>[:CHANnel<Channel>][:POWer][:AVG]:RANGe:CLEVel[:VALue]`.

Suffix:

<Measurement> 1 to 8
Measurement

<Channel> 1 to 2
1 = primary sensor, 2 = secondary sensor

Parameters:

<value> *RST: OFF

Manual operation: See "[User Defined Transition](#)" on page 127

CALCulate<Measurement>[:CHANnel<Channel>][:POWer][:AVG]:RANGe:CLEVel[:VALue] <value>

Reduces the transition range between the measurement paths, 0 -> 1 and 1 -> 2, by the set value, the so-called cross-over level. Thus, you can improve the measurement accuracy for signals with a high peak-to-average ratio, since the headroom for modulation peaks becomes larger. However, the S/N ratio is reduced at the lower limits of the transition ranges.

Suffix:

<Measurement> 1 to 8
Measurement

<Channel> 1 to 2
1 = primary sensor, 2 = secondary sensor

Parameters:

<value> Range: -20.0 to 0.0
 *RST: 0.0
 Default unit: dB

Manual operation: See "[Offset](#)" on page 128

CALCulate<Measurement>[:CHANnel<Channel>][:POWer][:AVG]:RANGe[:VALue] <value>

Effective if `CALCulate<Measurement>[:CHANnel<Channel>][:POWer][:AVG]:RANGe:AUTO` OFF is set.

Sets the active measurement path in which the power sensor is measuring.

Suffix:

<Measurement> 1 to 8
Measurement

<Channel> 1 to 2
1 = primary sensor, 2 = secondary sensor

Parameters:

<value> LOW | MID | HIGH
*RST: MID

Manual operation: See "Range" on page 127

13.8.6 Standardized signals

For a set of standards, you can preconfigure settings.

13.8.6.1 Commands

SYSTem:STANdard:CATalog?	351
SYSTem:STANdard:PRESet	351
SYSTem:STANdard:PWSettings	352
SYSTem:STANdard:TRIGger:SOURce	352

SYSTem:STANdard:CATalog?

Queries the supported standards. Use the returned strings for [SYSTem:STANdard:PRESet](#).

Usage: Query only

SYSTem:STANdard:PRESet <string>

Configures the power sensor and trigger settings for the selected standard. Query the supported standards using [SYSTem:STANdard:CATalog?](#).

If [SYSTem:STANdard:PWSettings](#) OFF is set, also configures the R&S NRX display settings.

Use [SYSTem:STANdard:TRIGger:SOURce](#) to set the trigger source.

Setting parameters:

<string> "<standard name>"

Available standards. For the corresponding power sensor configuration, follow the link.

GSM/EDGE

[Table 13-7](#)

DECT

[Table 13-8](#)

WCDMA/3GPP FDD

Table 13-9

WCDMA/3GPP TDD DL

Table 13-10

WCDMA/3GPP TDD UL

Table 13-11

TD-SCDMA

Table 13-12

Bluetooth DH1

Table 13-13

Bluetooth DH3

Table 13-14

Bluetooth DH5

Table 13-15

CDMA2000

Table 13-16

- Usage:** Setting only
- Manual operation:** See "Parameter Set" on page 71
See "Recall Parameter Set" on page 72

SYSTem:STANdard:PWSettings <state>

Specifies whether the display settings are kept unchanged when using `SYSTem:STANdard:PRESet`.

Parameters:

<state>

ON

Only configures the power sensor.

OFF

Configures the power sensor and the display settings of the R&S NRX. See Chapter 13.8.6.3, "Display configuration", on page 363.

*RST: OFF

- Manual operation:** See "Preserve Window Settings" on page 71

SYSTem:STANdard:TRIGger:SOURce <source>

Sets the trigger source for `SYSTem:STANdard:PRESet`.

Parameters:

<source>

INTernal | EXTernal

INTernal

Internal triggering

EXTernal

External triggering

*RST: INTERNAL

13.8.6.2 Preconfigured settings

For the following standards, you can preconfigure the power sensor using:

- [Parameter Set](#)
- `SYSTEM:STANDARD:PRESet`

Table 13-7: GSM/EDGE

Sensor parameter	Remote control command	Value
Sensor mode	<code>CALCulate<Measurement>:TYPE</code>	TRACe
Aperture time	<code>CALCulate<Measurement>[:CHANnel<Channel>][:POWer][:AVG]:APERture[:VALue]</code>	4.615 ms
Duty cycle	<code>CALCulate<Measurement>[:CHANnel<Channel>]:CORRection:DCYCLE[:VALue]</code>	11.762 %
Duty cycle correction	<code>CALCulate<Measurement>[:CHANnel<Channel>]:CORRection:DCYCLE:STATE</code>	ON
Smoothing	<code>CALCulate<Measurement>[:CHANnel<Channel>][:POWer][:AVG]:SMOothing[:STATE]</code>	OFF
Dropout tolerance	<code>CALCulate<Measurement>[:CHANnel<Channel>][:POWer]:BURSt:DTOLerance</code>	577 µs
Exclude time start	<code>CALCulate<Measurement>:TSLot:TIMing:EXCLude:START</code>	20 µs
Exclude time end	<code>CALCulate<Measurement>:TSLot:TIMing:EXCLude:STOP</code>	30 µs
Timeslot count	<code>CALCulate<Measurement>[:POWer]:TSLot[:AVG]:COUNT</code>	8
Timeslot fence	<code>CALCulate<Measurement>[:POWer]:TSLot[:AVG][:EXCLude]:MID[:STATE]</code>	OFF
Timeslot width	<code>CALCulate<Measurement>[:POWer]:TSLot[:AVG]:WIDTH</code>	577 µs
Timegate offset	<code>CALCulate<Measurement>[:POWer]:TGATE<Gate>[:AVG]:OFFSet[:TIME]</code>	1: 20 µs 2: 2.328 ms
Timegate length	<code>CALCulate<Measurement>[:POWer]:TGATE<Gate>[:AVG]:TIME</code>	1: 527 µs 2: 527 µs
Timegate fence	<code>CALCulate<Measurement>[:POWer]:TGATE<Gate>[:AVG][:EXCLude]:MID[:STATE]</code>	OFF
Trace offset time	<code>CALCulate<Measurement>:TRACe:X[:SCALE]:LEFT</code>	-50 µs
Trace capture time	<code>CALCulate<Measurement>:TRACe:X[:SCALE]:LENGTh</code>	5 ms
Trace number of points	<code>CALCulate<Measurement>:TRACe:X:POINTs</code>	261
Trace realtime	<code>[SENSe<Sensor>:]TRACe:REALtime</code>	OFF

Sensor parameter	Remote control command	Value
Trigger delay	TRIGger<Measurement>[:CHANnel<Channel>]:DELay[:VALue]	0 s
Trigger level	TRIGger<Measurement>[:CHANnel<Channel>]:LEVel	-20 dBm
Trigger source	TRIGger<Measurement>[:CHANnel<Channel>]:SOURce	INT
Trigger slope	TRIGger<Measurement>[:CHANnel<Channel>]:SLOPe	POS
Trigger holdoff	TRIGger<Measurement>[:CHANnel<Channel>]:HOLDoff	27 ms
Trigger dropout time	TRIGger<Measurement>[:CHANnel<Channel>]:DTIME	0 s
Trigger hysteresis	TRIGger<Measurement>[:CHANnel<Channel>]:HYSTeresis	3 dB

Table 13-8: DECT

Sensor parameter	Remote control command	Value
Sensor mode	CALCulate<Measurement>:TYPE	TRACe
Aperture time	CALCulate<Measurement>[:CHANnel<Channel>][:POWer][:AVG]:APERture[:VALue]	10 ms
Duty cycle	CALCulate<Measurement>[:CHANnel<Channel>]:CORRection:DCYCLE[:VALue]	3.7 %
Duty cycle correction	CALCulate<Measurement>[:CHANnel<Channel>]:CORRection:DCYCLE:STATE	ON
Smoothing	CALCulate<Measurement>[:CHANnel<Channel>][:POWer][:AVG]:SMOothing[:STATE]	OFF
Dropout tolerance	CALCulate<Measurement>[:CHANnel<Channel>][:POWer]:BURSt:DTOLerance	416.7 µs
Exclude time start	CALCulate<Measurement>:TSLot:TIMing:EXCLude:START	15 µs
Exclude time end	CALCulate<Measurement>:TSLot:TIMing:EXCLude:STOP	25 µs
Timeslot count	CALCulate<Measurement>[:POWer]:TSLot[:AVG]:COUNT	24
Timeslot fence	CALCulate<Measurement>[:POWer]:TSLot[:AVG][:EXCLude]:MID[:STATE]	OFF
Timeslot width	CALCulate<Measurement>[:POWer]:TSLot[:AVG]:WIDTh	416.667 µs
Timegate offset	CALCulate<Measurement>[:POWer]:TGATE<Gate>[:AVG]:OFFSet[:TIME]	1: 15 µs 2: 5.015 ms
Timegate length	CALCulate<Measurement>[:POWer]:TGATE<Gate>[:AVG]:TIME	1: 348.055 µs 2: 348.0 µs

Sensor parameter	Remote control command	Value
Timegate fence	CALCulate<Measurement>[:POWER]:TGATE<Gate>[:AVG][:EXCLude]:MID[:STATE]	OFF
Trace offset time	CALCulate<Measurement>:TRACe:X[:SCALE]:LEFT	-200 µs
Trace capture time	CALCulate<Measurement>:TRACe:X[:SCALE]:LENGth	10.250 ms
Trace number of points	CALCulate<Measurement>:TRACe:X:POINts	261
Trace realtime	[SENSE<Sensor>:]TRACe:REALtime	OFF
Trigger delay	TRIGger<Measurement>[:CHANnel<Channel>]:DELay[:VALue]	0 s
Trigger level	TRIGger<Measurement>[:CHANnel<Channel>]:LEVel	-30 dBm
Trigger source	TRIGger<Measurement>[:CHANnel<Channel>]:SOURce	INT
Trigger slope	TRIGger<Measurement>[:CHANnel<Channel>]:SLOPe	POS
Trigger holdoff	TRIGger<Measurement>[:CHANnel<Channel>]:HOLDoff	39.9 ms
Trigger dropout time	TRIGger<Measurement>[:CHANnel<Channel>]:DTIME	0 s
Trigger hysteresis	TRIGger<Measurement>[:CHANnel<Channel>]:HYSTeresis	3 dB

Table 13-9: WCDMA/3GPP FDD

Sensor parameter	Remote control command	Value
Sensor mode	CALCulate<Measurement>:TYPE	CONTAv
Aperture time	CALCulate<Measurement>[:CHANnel<Channel>][:POWER][:AVG]:APERture[:VALue]	10 ms
Duty cycle correction	CALCulate<Measurement>[:CHANnel<Channel>]:CORRection:DCYCLE:STATE	OFF
Smoothing	CALCulate<Measurement>[:CHANnel<Channel>][:POWER][:AVG]:SMOothing[:STATE]	OFF
Filter auto	CALCulate<Measurement>[:CHANnel<Channel>]:AVERage:COUNT:AUTO[:STATE]	OFF
Filter length	CALCulate<Measurement>[:CHANnel<Channel>]:AVERage:COUNT[:VALue]	16
Trigger source	TRIGger<Measurement>[:CHANnel<Channel>]:SOURce	EXT

Table 13-10: WCDMA/3GPP TDD DL

Sensor parameter	Remote control command	Value
Sensor mode	CALCulate<Measurement>:TYPE	TRACe
Aperture time	CALCulate<Measurement>[:CHANnel<Channel>][:POWer][:AVG]:APERture[:VALue]	10 ms
Duty cycle	CALCulate<Measurement>[:CHANnel<Channel>]:CORRection:DCYCLE[:VALue]	6.667 %
Duty cycle correction	CALCulate<Measurement>[:CHANnel<Channel>]:CORRection:DCYCLE:STATe	ON
Smoothing	CALCulate<Measurement>[:CHANnel<Channel>][:POWer][:AVG]:SMOothing[:STATe]	OFF
Dropout tolerance	CALCulate<Measurement>[:CHANnel<Channel>][:POWer]:BURSt:DTOLerance	666.667 µs
Exclude time start	CALCulate<Measurement>:TSLot:TIMing:EXCLude:START	25 µs
Exclude time end	CALCulate<Measurement>:TSLot:TIMing:EXCLude:STOP	40 µs
Timeslot count	CALCulate<Measurement>[:POWer]:TSLot[:AVG]:COUNT	15
Timeslot fence	CALCulate<Measurement>[:POWer]:TSLot[:AVG][:EXCLude]:MID[:STATe]	OFF
Timeslot width	CALCulate<Measurement>[:POWer]:TSLot[:AVG]:WIDTh	666.667 µs
Timegate offset	CALCulate<Measurement>[:POWer]:TGATE<Gate>[:AVG]:OFFSet[:TIME]	1: 25 µs 2: 5.358 ms
Timegate length	CALCulate<Measurement>[:POWer]:TGATE<Gate>[:AVG]:TIME	1: 601.667 µs 2: 602 µs
Timegate fence	CALCulate<Measurement>[:POWer]:TGATE<Gate>[:AVG][:EXCLude]:MID[:STATe]	OFF
Trace offset time	CALCulate<Measurement>:TRACe:X[:SCALe]:LEFT	-200 µs
Trace capture time	CALCulate<Measurement>:TRACe:X[:SCALe]:LENGTh	10.250 ms
Trace number of points	CALCulate<Measurement>:TRACe:X:POINTs	261
Trace realtime	[SENSe<Sensor>:]TRACe:REALtime	OFF
Trigger delay	TRIGger<Measurement>[:CHANnel<Channel>]:DELay[:VALue]	0 s
Trigger level	TRIGger<Measurement>[:CHANnel<Channel>]:LEVel	-30 dBm
Trigger source	TRIGger<Measurement>[:CHANnel<Channel>]:SOURce	INT
Trigger slope	TRIGger<Measurement>[:CHANnel<Channel>]:SLOPe	POS

Sensor parameter	Remote control command	Value
Trigger holdoff	TRIGger<Measurement>[:CHANnel<Channel>]: HOLDoff	19.9 ms
Trigger dropout time	TRIGger<Measurement>[:CHANnel<Channel>]:DTIME	0 s
Trigger hysteresis	TRIGger<Measurement>[:CHANnel<Channel>]: HYSTeresis	3 dB

Table 13-11: WCDMA/3GPP TDD UL

Sensor parameter	Remote control command	Value
Sensor mode	CALCulate<Measurement>:TYPE	TRACe
Aperture time	CALCulate<Measurement>[:CHANnel<Channel>][: POWer][:AVG]:APERture[:VALue]	10 ms
Duty cycle	CALCulate<Measurement>[:CHANnel<Channel>]: CORRection:DCYCLE[:VALue]	6.420 %
Duty cycle correction	CALCulate<Measurement>[:CHANnel<Channel>]: CORRection:DCYCLE:STATE	ON
Smoothing	CALCulate<Measurement>[:CHANnel<Channel>][: POWer][:AVG]:SMOothing[:STATE]	OFF
Dropout tolerance	CALCulate<Measurement>[:CHANnel<Channel>][: POWer]:BURSt:DTOLerance	666.667 µs
Exclude time start	CALCulate<Measurement>:TSLot:TIMing:EXCLude: START	15 µs
Exclude time end	CALCulate<Measurement>:TSLot:TIMing:EXCLude: STOP	40 µs
Timeslot count	CALCulate<Measurement>[:POWer]:TSLot[:AVG]: COUNT	15
Timeslot fence	CALCulate<Measurement>[:POWer]:TSLot[:AVG][: EXCLude]:MID[:STATE]	OFF
Timeslot width	CALCulate<Measurement>[:POWer]:TSLot[:AVG]: WIDTh	666.667 µs
Timegate offset	CALCulate<Measurement>[:POWer]:TGATE<Gate>[: AVG]:OFFSet[:TIME]	1: 15 µs 2: 5.348 ms
Timegate length	CALCulate<Measurement>[:POWer]:TGATE<Gate>[: AVG]:TIME	1: 611.667 µs 2: 612 µs
Timegate fence	CALCulate<Measurement>[:POWer]:TGATE<Gate>[: AVG][:EXCLude]:MID[:STATE]	OFF
Trace offset time	CALCulate<Measurement>:TRACe:X[:SCALe]:LEFT	-200 µs
Trace capture time	CALCulate<Measurement>:TRACe:X[:SCALe]:LENGTh	10.250 ms
Trace number of points	CALCulate<Measurement>:TRACe:X:POINTs	261
Trace realtime	[SENSe<Sensor>:]TRACe:REALtime	OFF

Sensor parameter	Remote control command	Value
Trigger delay	TRIGger<Measurement>[:CHANnel<Channel>]: DELay[:VALue]	0 s
Trigger level	TRIGger<Measurement>[:CHANnel<Channel>]:LEVel	-30 dBm
Trigger source	TRIGger<Measurement>[:CHANnel<Channel>]: SOURce	INT
Trigger slope	TRIGger<Measurement>[:CHANnel<Channel>]:SLOPe	POS
Trigger holdoff	TRIGger<Measurement>[:CHANnel<Channel>]: HOLDoff	19.9 ms
Trigger dropout time	TRIGger<Measurement>[:CHANnel<Channel>]:DTIME	0 s
Trigger hysteresis	TRIGger<Measurement>[:CHANnel<Channel>]: HYSTeresis	3 dB

Table 13-12: TD-SCDMA

Sensor parameter	Remote control command	Value
Sensor mode	CALCulate<Measurement>:TYPE	TRACe
Aperture time	CALCulate<Measurement>[:CHANnel<Channel>][: POWer][:AVG]:APERture[:VALue]	5 ms
Duty cycle	CALCulate<Measurement>[:CHANnel<Channel>]: CORRection:DCYCLe[:VALue]	13.250 %
Duty cycle correction	CALCulate<Measurement>[:CHANnel<Channel>]: CORRection:DCYCLe:STATE	ON
Smoothing	CALCulate<Measurement>[:CHANnel<Channel>][: POWer][:AVG]:SMOothing[:STATE]	OFF
Dropout tolerance	CALCulate<Measurement>[:CHANnel<Channel>][: POWer]:BURSt:DTOLerance	366 µs
Exclude time start	CALCulate<Measurement>:TSLot:TIMing:EXCLude: START	10 µs
Exclude time end	CALCulate<Measurement>:TSLot:TIMing:EXCLude: STOP	15 µs
Timegate offset	CALCulate<Measurement>[:POWer]:TGATe<Gate>[: AVG]:OFFSet[:TIME]	1: 20 µs 2: 710 µs 3: 835 µs 4: 5.970 ms
Timegate length	CALCulate<Measurement>[:POWer]:TGATe<Gate>[: AVG]:TIME	1: 620 µs 2: 30 µs 3: 85 µs 4: 620 µs
Timegate fence	CALCulate<Measurement>[:POWer]:TGATe<Gate>[: AVG][:EXCLude]:MID[:STATE]	OFF
Trace offset time	CALCulate<Measurement>:TRACe:X[:SCALE]:LEFT	-200 µs

Sensor parameter	Remote control command	Value
Trace capture time	CALCulate<Measurement>:TRACe:X[:SCALE]:LENGth	10.250 ms
Trace number of points	CALCulate<Measurement>:TRACe:X:POINts	261
Trace realtime	[SENSe<Sensor>:]TRACe:REALtime	OFF
Trigger delay	TRIGger<Measurement>[:CHANnel<Channel>]:DELay[:VALue]	0 s
Trigger level	TRIGger<Measurement>[:CHANnel<Channel>]:LEVel	-30 dBm
Trigger source	TRIGger<Measurement>[:CHANnel<Channel>]:SOURce	INT
Trigger slope	TRIGger<Measurement>[:CHANnel<Channel>]:SLOPe	POS
Trigger holdoff	TRIGger<Measurement>[:CHANnel<Channel>]:HOLDoff	19.9 ms
Trigger dropout time	TRIGger<Measurement>[:CHANnel<Channel>]:DTIME	0 s
Trigger hysteresis	TRIGger<Measurement>[:CHANnel<Channel>]:HYSTeresis	3 dB

Table 13-13: Bluetooth DH1

Sensor parameter	Remote control command	Value
Sensor mode	CALCulate<Measurement>:TYPE	TRACe
Aperture time	CALCulate<Measurement>[:CHANnel<Channel>][:POWER][:AVG]:APERture[:VALue]	1.25 ms
Duty cycle	CALCulate<Measurement>[:CHANnel<Channel>]:CORRection:DCYCLE[:VALue]	29.28 %
Duty cycle correction	CALCulate<Measurement>[:CHANnel<Channel>]:CORRection:DCYCLE:STATE	ON
Smoothing	CALCulate<Measurement>[:CHANnel<Channel>][:POWER][:AVG]:SMOothing[:STATE]	OFF
Dropout tolerance	CALCulate<Measurement>[:CHANnel<Channel>][:POWER]:BURSt:DTOLerance	366 µs
Exclude time start	CALCulate<Measurement>:TSLot:TIMing:EXCLude:START	10 µs
Exclude time end	CALCulate<Measurement>:TSLot:TIMing:EXCLude:STOP	15 µs
Timegate offset	CALCulate<Measurement>[:POWER]:TGATe<Gate>[:AVG]:OFFSet[:TIME]	1: 10 µs 2: 660 µs
Timegate length	CALCulate<Measurement>[:POWER]:TGATe<Gate>[:AVG]:TIME	1: 341 µs 2: 341 µs
Timegate fence	CALCulate<Measurement>[:POWER]:TGATe<Gate>[:AVG][:EXCLude]:MID[:STATE]	OFF

Sensor parameter	Remote control command	Value
Trace offset time	CALCulate<Measurement>:TRACe:X[:SCALE]:LEFT	-30 µs
Trace capture time	CALCulate<Measurement>:TRACe:X[:SCALE]:LENGTh	1.28 ms
Trace number of points	CALCulate<Measurement>:TRACe:X:POINts	261
Trace realtime	[SENSe<Sensor>:]TRACe:REALtime	OFF
Trigger delay	TRIGger<Measurement>[:CHANnel<Channel>]:DELay[:VALue]	0 s
Trigger level	TRIGger<Measurement>[:CHANnel<Channel>]:LEVel	-30 dBm
Trigger source	TRIGger<Measurement>[:CHANnel<Channel>]:SOURce	INT
Trigger slope	TRIGger<Measurement>[:CHANnel<Channel>]:SLOPe	POS
Trigger holdoff	TRIGger<Measurement>[:CHANnel<Channel>]:HOLDoff	2.480 ms
Trigger dropout time	TRIGger<Measurement>[:CHANnel<Channel>]:DTIME	0 s
Trigger hysteresis	TRIGger<Measurement>[:CHANnel<Channel>]:HYSTeresis	3 dB

Table 13-14: Bluetooth DH3

Sensor parameter	Remote control command	Value
Sensor mode	CALCulate<Measurement>:TYPE	TRACe
Aperture time	CALCulate<Measurement>[:CHANnel<Channel>][:POWER][:AVG]:APERture[:VALue]	2.50 ms
Duty cycle	CALCulate<Measurement>[:CHANnel<Channel>]:CORRection:DCYCLE[:VALue]	64.88 %
Duty cycle correction	CALCulate<Measurement>[:CHANnel<Channel>]:CORRection:DCYCLE:STATe	ON
Smoothing	CALCulate<Measurement>[:CHANnel<Channel>][:POWER][:AVG]:SMOothing[:STATe]	OFF
Dropout tolerance	CALCulate<Measurement>[:CHANnel<Channel>][:POWER]:BURSt:DTOLerance	1.622 ms
Exclude time start	CALCulate<Measurement>:TSLot:TIMing:EXCLude:START	10 µs
Exclude time end	CALCulate<Measurement>:TSLot:TIMing:EXCLude:STOP	15 µs
Timegate offset	CALCulate<Measurement>[:POWER]:TGATe<Gate>[:AVG]:OFFSet[:TIME]	1: 10 µs 2: 1.885 ms
Timegate length	CALCulate<Measurement>[:POWER]:TGATe<Gate>[:AVG]:TIME	1: 1.597 ms 2: 351 µs

Sensor parameter	Remote control command	Value
Timegate fence	CALCulate<Measurement>[:POWER]:TGATE<Gate>[:AVG][:EXCLude]:MID[:STATE]	OFF
Trace offset time	CALCulate<Measurement>:TRACe:X[:SCALE]:LEFT	-30 µs
Trace capture time	CALCulate<Measurement>:TRACe:X[:SCALE]:LENGTh	2.530 ms
Trace number of points	CALCulate<Measurement>:TRACe:X:POINts	261
Trace realtime	[SENSe<Sensor>:]TRACe:REALtime	OFF
Trigger delay	TRIGger<Measurement>[:CHANnel<Channel>]:DELay[:VALue]	0 s
Trigger level	TRIGger<Measurement>[:CHANnel<Channel>]:LEVel	-30 dBm
Trigger source	TRIGger<Measurement>[:CHANnel<Channel>]:SOURce	INT
Trigger slope	TRIGger<Measurement>[:CHANnel<Channel>]:SLOPe	POS
Trigger holdoff	TRIGger<Measurement>[:CHANnel<Channel>]:HOLDoff	4.980 ms
Trigger dropout time	TRIGger<Measurement>[:CHANnel<Channel>]:DTIME	0 s
Trigger hysteresis	TRIGger<Measurement>[:CHANnel<Channel>]:HYSTeresis	3 dB

Table 13-15: Bluetooth DH5

Sensor parameter	Remote control command	Value
Sensor mode	CALCulate<Measurement>:TYPE	TRACe
Aperture time	CALCulate<Measurement>[:CHANnel<Channel>][:POWER][:AVG]:APERture[:VALue]	3.75 ms
Duty cycle	CALCulate<Measurement>[:CHANnel<Channel>]:CORRection:DCYCLe[:VALue]	76.533 %
Duty cycle correction	CALCulate<Measurement>[:CHANnel<Channel>]:CORRection:DCYCLe:STATE	ON
Smoothing	CALCulate<Measurement>[:CHANnel<Channel>][:POWER][:AVG]:SMOothing[:STATE]	OFF
Dropout tolerance	CALCulate<Measurement>[:CHANnel<Channel>][:POWER]:BURSt:DTOLerance	2.870 ms
Exclude time start	CALCulate<Measurement>:TSLot:TIMing:EXCLude:START	10 µs
Exclude time end	CALCulate<Measurement>:TSLot:TIMing:EXCLude:STOP	15 µs
Timegate offset	CALCulate<Measurement>[:POWER]:TGATE<Gate>[:AVG]:OFFSet[:TIME]	1: 10 µs 2: 3.135 ms

Sensor parameter	Remote control command	Value
Timegate length	CALCulate<Measurement>[:POWER]:TGATE<Gate>[:AVG]:TIME	1: 2.845 ms 2: 351 µs
Timegate fence	CALCulate<Measurement>[:POWER]:TGATE<Gate>[:AVG][:EXCLUDE]:MID[:STATE]	OFF
Trace offset time	CALCulate<Measurement>:TRACE:X[:SCALE]:LEFT	-30 µs
Trace capture time	CALCulate<Measurement>:TRACE:X[:SCALE]:LENGTH	3.780 ms
Trace number of points	CALCulate<Measurement>:TRACE:X:POINTS	261
Trace realtime	[SENSE<Sensor>:]TRACE:REALtime	OFF
Trigger delay	TRIGger<Measurement>[:CHANNEL<Channel>]:DELAY[:VALUE]	0 s
Trigger level	TRIGger<Measurement>[:CHANNEL<Channel>]:LEVEL	-30 dBm
Trigger source	TRIGger<Measurement>[:CHANNEL<Channel>]:SOURCE	INT
Trigger slope	TRIGger<Measurement>[:CHANNEL<Channel>]:SLOPE	POS
Trigger holdoff	TRIGger<Measurement>[:CHANNEL<Channel>]:HOLDoff	7.480 ms
Trigger dropout time	TRIGger<Measurement>[:CHANNEL<Channel>]:DTIME	0 s
Trigger hysteresis	TRIGger<Measurement>[:CHANNEL<Channel>]:HYSTERESIS	3 dB

Table 13-16: CDMA2000

Sensor parameter	Remote control command	Value
Sensor mode	CALCulate<Measurement>:TYPE	CONTAv
Aperture time	CALCulate<Measurement>[:CHANNEL<Channel>][:POWER][:AVG]:APERture[:VALUE]	80 ms
Duty cycle correction	CALCulate<Measurement>[:CHANNEL<Channel>]:CORREction:DCYCLE:STATE	OFF
Smoothing	CALCulate<Measurement>[:CHANNEL<Channel>][:POWER][:AVG]:SMOothing[:STATE]	OFF
Filter auto	CALCulate<Measurement>[:CHANNEL<Channel>]:AVERAge:COUNT:AUTO[:STATE]	OFF
Filter length	CALCulate<Measurement>[:CHANNEL<Channel>]:AVERAge:COUNT[:VALUE]	16
Trigger source	TRIGger<Measurement>[:CHANNEL<Channel>]:SOURCE	EXT

13.8.6.3 Display configuration

You can choose whether you want to preserve the display settings when loading the parameter set using:

- [Preserve Window Settings](#)
- `SYSTem:STANdard:PWSettings`

If you do not preserve the display settings, they are changed as follows for all standards.

R&S NRX parameter	Remote control command	Value
Result resolution	<code>CALCulate<Measurement>:RESolution</code>	OOI
Lower power limit	<code>CALCulate<Measurement>: METer<DirectionalChannel>:LOWer[:DATA][: POWER]</code>	-90 dBm
Upper power limit	<code>CALCulate<Measurement>: METer<DirectionalChannel>:UPPer[:DATA][: POWER]</code>	30 dBm
Lower power ratio limit	<code>CALCulate<Measurement>: METer<DirectionalChannel>:LOWer[:DATA]: RATio[:VALue]</code>	-120 dB
Upper power ratio limit	<code>CALCulate<Measurement>: METer<DirectionalChannel>:UPPer[:DATA]: RATio[:VALue]</code>	60 dB
Relative measurement status	<code>CALCulate<Measurement>: RELative<DirectionalChannel>:STATe</code>	OFF
NRT measurement reference value	<code>CALCulate<Measurement>: RELative<DirectionalChannel>:POWER[: MAGNitude]</code>	1.0 dBm
NRT measurement reference value (ratio)	<code>CALCulate<Measurement>: RELative<DirectionalChannel>:RATio[: MAGNitude]</code>	1.0 dBm
Measurement function	<code>CALCulate<Measurement>:MATH[:EXPReSSion]</code>	Depends on suffix: 1: "(SENS1)" 2: "(SENS2)" ...
Measurement type	<code>CALCulate<Measurement>[:CHANnel<Channel>]: FEED<Channel></code>	"POWER: AVERAge"
Output unit	<code>UNIT<Measurement>:POWER[:VALue]</code>	DBM
Output unit (ratio)	<code>UNIT<Measurement>:POWER:RATio</code>	DB
Upper limit check	<code>CALCulate<Measurement>: LIMit<DirectionalChannel>:UPPer:STATe</code>	OFF
Lower limit check	<code>CALCulate<Measurement>: LIMit<DirectionalChannel>:LOWer:STATe</code>	OFF

R&S NRX parameter	Remote control command	Value
Upper power limit	<code>CALCulate<Measurement>: LIMit<DirectionalChannel>:UPPer[:DATA]:POWer</code>	0 dBm
Lower power limit	<code>CALCulate<Measurement>: LIMit<DirectionalChannel>:LOWer[:DATA]:POWer</code>	0 dBm
Upper power ratio limit	<code>CALCulate<Measurement>: LIMit<DirectionalChannel>:UPPer[:DATA]: RATio[:VALue]</code>	1.0 dB
Lower power ratio limit	<code>CALCulate<Measurement>: LIMit<DirectionalChannel>:LOWer[:DATA]: RATio[:VALue]</code>	1.0 dB

13.8.7 Frequency selective power sensors

<code>CALCulate<Measurement>[:CHANnel<Channel>]:ROSCillator:REFio:FREQUency</code>	364
<code>CALCulate<Measurement>[:CHANnel<Channel>]:ROSCillator:REFio:OUTPut[:STATe]</code>	364
<code>CALCulate<Measurement>[:CHANnel<Channel>]:ROSCillator:SOURce</code>	365
<code>[SENSe<Sensor>:]BANDwidth[:RESolution]:TYPE:AUTO[:STATe]</code>	365
<code>[SENSe<Sensor>:]BANDwidth[:RESolution]:TYPE[:VALue]</code>	365
<code>[SENSe<Sensor>:]BANDwidth[:RESolution][:VALue]</code>	366

`CALCulate<Measurement>[:CHANnel<Channel>]:ROSCillator:REFio:FREQUency` <freq>

Effective for:

- R&S frequency selective power sensors
- `CALCulate<Measurement>[:CHANnel<Channel>]:ROSCillator:SOURce` on page 365 `REFio` is set.

Sets the frequency of the reference clock signal that is supplied at the REF connector of the power sensor.

Suffix:

<Measurement>	1 to 8 Measurement
<Channel>	1 to 2 1 = primary sensor, 2 = secondary sensor

Parameters:

<freq>	Range: 1.0e+7 to 1.2e+8
	*RST: 1.0e+7

`CALCulate<Measurement>[:CHANnel<Channel>]:ROSCillator:REFio:OUTPut[:STATe]` <state>

Effective for R&S frequency selective power sensors.

If the REF connector of the power sensor is used as an output, enables or disables the output signal.

Suffix:

<Measurement> 1 to 8
Measurement

<Channel> 1 to 2
1 = primary sensor, 2 = secondary sensor

Parameters:

<state> *RST: OFF

CALCulate<Measurement>[:CHANnel<Channel>]:ROSCillator:SOURce <source>

Effective for R&S NRP series power sensors and R&S frequency selective power sensors.

Sets the source of the reference oscillator.

Suffix:

<Measurement> 1 to 8
Measurement

<Channel> 1 to 2
1 = primary sensor, 2 = secondary sensor

Parameters:

<source> HOST | INTernal | REFio
*RST: INTernal

[SENSe<Sensor>:]BANDwidth[:RESolution]:TYPE:AUTO[:STATe] <state>

Effective for R&S frequency selective power sensors.

If enabled, sets the filter type suitable for the currently chosen measurement mode and bandwidth.

You can query the selected filter type using `[SENSe<Sensor>:]BANDwidth[:RESolution]:TYPE[:VALue]`.

Suffix:

<Sensor> 1 to 128
Configured sensor connected at: port A = 1, ... , port D = 4, R&S NRX-B9 = 101, USB and LAN port = 5 to 100

Parameters:

<state> *RST: ON

[SENSe<Sensor>:]BANDwidth[:RESolution]:TYPE[:VALue] <value>

Effective for R&S frequency selective power sensors.

Sets the filter type for resolution bandwidth filter. The filter bandwidth is not affected.

If you want to set the filter type automatically, use `[SENSe<Sensor>:]BANDwidth[:RESolution]:TYPE:AUTO[:STATe]`.

Suffix:

<Sensor> 1 to 128
Configured sensor connected at: port A = 1, ... , port D = 4, R&S NRX-B9 = 101, USB and LAN port = 5 to 100

Parameters:

<value> FLAT | NORMal | LTE | W3GPp
*RST: FLAT

`[SENSe<Sensor>:]BANDwidth[:RESolution][:VALue] <value>`

Effective for R&S frequency selective power sensors.

Sets the resolution bandwidth.

Suffix:

<Sensor> 1 to 128
Configured sensor connected at: port A = 1, ... , port D = 4, R&S NRX-B9 = 101, USB and LAN port = 5 to 100

Parameters:

<value> Range: 10.0 to 400.0e6
*RST: 25.0e6
Default unit: Hz

13.8.8 NRT measurement type

- [NRT mode settings](#)..... 366
- [NRT correction settings](#).....370
- [NRT filter settings](#).....373

13.8.8.1 NRT mode settings

Further information:

- [Chapter 7.5.1, "NRT mode settings"](#), on page 129

<code>CALCulate<Measurement>[:CHANnel<Channel>]:NRT:BURSt:MODE</code>	367
<code>CALCulate<Measurement>[:CHANnel<Channel>]:NRT:BURSt:PERiod</code>	367
<code>CALCulate<Measurement>[:CHANnel<Channel>]:NRT:BURSt:WIDTh</code>	368
<code>CALCulate<Measurement>[:CHANnel<Channel>]:NRT:CCDF:THReshold</code>	368
<code>CALCulate<Measurement>[:CHANnel<Channel>]:NRT:DIRection</code>	368
<code>CALCulate<Measurement>[:CHANnel<Channel>]:NRT:PEP:HOLD:TIME</code>	369
<code>INPut<Sensor>:PORT:SOURce:AUTO</code>	369
<code>INPut<Sensor>:PORT:SOURce[:VALue]</code>	370

CALCulate<Measurement>[:CHANnel<Channel>]:NRT:BURSt:MODE <mode>

Defines how the average burst power is determined.

Suffix:

<Measurement> 1 to 8
Measurement

<Channel> 1 to 2
1 = primary sensor, 2 = secondary sensor or 1 = forward, 2 = reflection (reverse)

Parameters:

<mode> AUTO | USER

AUTO

Not supported by all power sensors.

The power sensor automatically recognizes the duty cycle of the burst series and calculates the average burst power from this duty cycle and the average power. Set an appropriate video bandwidth using `CALCulate<Measurement>[:CHANnel<Channel>]:NRT:VBWidth[:VALue]`.

USER

Define the duty cycle by:

`CALCulate<Measurement>[:CHANnel<Channel>]:NRT:BURSt:PERiod`

`CALCulate<Measurement>[:CHANnel<Channel>]:NRT:BURSt:WIDTh`

The R&S NRX calculates the average burst power from these values.

*RST: AUTO

Manual operation: See "[Burst Mode](#)" on page 129

CALCulate<Measurement>[:CHANnel<Channel>]:NRT:BURSt:PERiod <value>

Effective if `CALCulate<Measurement>[:CHANnel<Channel>]:NRT:BURSt:MODE` USER is set.

Sets the burst period.

Suffix:

<Measurement> 1 to 8
Measurement

<Channel> 1 to 2
1 = primary sensor, 2 = secondary sensor or 1 = forward, 2 = reflection (reverse)

Parameters:

<value> Range: 0.0 to 1.0
*RST: 0.1
Default unit: s

Manual operation: See "[Burst Period](#)" on page 129

CALCulate<Measurement>[:CHANnel<Channel>]:NRT:BURSt:WIDTh <value>

Effective if [CALCulate<Measurement>\[:CHANnel<Channel>\]:NRT:BURSt:MODE](#) USER is set.

Sets the burst width.

Suffix:

<Measurement> 1 to 8
Measurement

<Channel> 1 to 2
1 = primary sensor, 2 = secondary sensor or 1 = forward, 2 = reflection (reverse)

Parameters:

<value> Range: 0.0 to 1.0
 *RST: 0.01
 Default unit: s

Manual operation: See "[Burst Width](#)" on page 130

CALCulate<Measurement>[:CHANnel<Channel>]:NRT:CCDF:THReshold <value>

Sets the threshold for the complementary cumulative distribution function (CCDF).

If you enter a value without unit, the unit is defined by [UNIT<Measurement>:POWER\[:VALue\]](#). For further information, see [Chapter 13.6.1.3, "Units"](#), on page 217.

Suffix:

<Measurement> 1 to 8
Measurement

<Channel> 1 to 2
1 = primary sensor, 2 = secondary sensor or 1 = forward, 2 = reflection (reverse)

Parameters:

<value> Range: -290.0 to +110.0
 *RST: +0.0
 Default unit: dBm

Manual operation: See "[CCDF Threshold](#)" on page 130

CALCulate<Measurement>[:CHANnel<Channel>]:NRT:DIRection <direction>

Defines how the forward power is determined.

Suffix:

<Measurement> 1 to 8
Measurement

<Channel> 1 to 2
1 = primary sensor, 2 = secondary sensor or 1 = forward, 2 = reflection (reverse)

Parameters:

<direction> AUTO | FORWard | REVerse

AUTO

Determines the power flow direction automatically. The greater value of two measured values is automatically assigned as forward power.

FORWard | REVerse

Sets a fixed direction of the forward power, either from port 1 to port 2 (FORWard), or from port 2 to port 1 (REVerse).

*RST: AUTO

Manual operation: See "[Direction](#)" on page 130

CALCulate<Measurement>[:CHANnel<Channel>]:NRT:PEP:HOLD:TIME <value>

Sets the hold time of the peak hold circuit of the power sensor.

Suffix:

<Measurement> 1 to 8
Measurement

<Channel> 1 to 2
1 = primary sensor, 2 = secondary sensor or 1 = forward, 2 = reflection (reverse)

Parameters:

<value> Range: 1e-3 to 1e-1
*RST: 0.01
Default unit: s

Manual operation: See "[PEP Hold Time](#)" on page 130

INPut<Sensor>:PORT:SOURce:AUTO <auto>

Enables or disables the automatic assignment of the forward direction.

Suffix:

<Sensor> 1 to 128
Configured sensor connected at: port A = 1, ... , port D = 4, R&S NRX-B9 = 101, USB and LAN port = 5 to 100

Parameters:

<auto> **ON**
The direction in which the greater power flows is taken as the forward direction.
OFF
The forward direction is defined by [INPut<Sensor>:PORT:SOURce\[:VALue\]](#).

*RST: 0

Manual operation: See ["Direction"](#) on page 130

INPut<Sensor>:PORT:SOURce[:VALue] <val>

Effective if `INPut<Sensor>:PORT:SOURce:AUTO OFF` is set.

Sets a fixed direction of the forward power.

Suffix:

<Sensor> 1 to 128
Configured sensor connected at: port A = 1, ... , port D = 4, R&S NRX-B9 = 101, USB and LAN port = 5 to 100

Parameters:

<val> **1**
Port 1 to port 2
2
Port 2 to port 1
Range: 1 to 2
*RST: 1

Manual operation: See ["Direction"](#) on page 130

13.8.8.2 NRT correction settings

Further information:

- [Chapter 7.5.2, "NRT correction settings"](#), on page 130

<code>[SENSe<Sensor>:]DM:STATe</code>	370
<code>[SENSe<Sensor>:]DM:STANdard</code>	371
<code>CALCulate<Measurement>[:CHANnel<Channel>]:CORRection:OFFSet:RPLane</code>	371
<code>CALCulate<Measurement>[:CHANnel<Channel>]:NRT:DMODulation[:VALue]</code>	371
<code>CALCulate<Measurement>[:CHANnel<Channel>]:NRT:DMODulation:WCDMa:CRATe</code>	372
<code>INPut<Sensor>:PORT:OFFSet</code>	372
<code>INPut<Sensor>:PORT:POSition</code>	372

[SENSe<Sensor>:]DM:STATe <state>

Requires the interface for R&S NRT-Z sensors (R&S NRX-B9).

Enables or disables the modulation correction. Set the communication standard using `[SENSe<Sensor>:]DM:STANdard`.

Suffix:

<Sensor> 101
R&S NRT directional power sensor

Parameters:

<state> OFF | ON
*RST: 0

Manual operation: See "[Modulation](#)" on page 131

[SENSe<Sensor>:]DM:STANdard <standard>

Requires the interface for R&S NRT-Z sensors (R&S NRX-B9).

Sets a communication standard for the modulation correction to reduce systematic deviations occurring in power measurements.

Suffix:

<Sensor> 101
R&S NRT directional power sensor

Parameters:

<standard> IS95 | WCDMa | DVBT | DAB
*RST: IS95

Manual operation: See "[Modulation](#)" on page 131

CALCulate<Measurement>[:CHANnel<Channel>]:CORRection:OFFSet:RPLane
<plane>

Selects the power sensor port to which the measurement results are referred to.

Suffix:

<Measurement> 1 to 8
Measurement

<Channel> 1 to 2
1 = primary sensor, 2 = secondary sensor or 1 = forward, 2 = reflection (reverse)

Parameters:

<plane> SOURce | LOAD
*RST: SOURce

Manual operation: See "[Offset Reference Plane](#)" on page 131

CALCulate<Measurement>[:CHANnel<Channel>]:NRT:DMODulation[:VALue]
<modulation>

Sets a communication standard for the modulation correction to reduce systematic deviations occurring in power measurements.

Suffix:

<Measurement> 1 to 8
Measurement

<Channel> 1 to 2
1 = primary sensor, 2 = secondary sensor or 1 = forward, 2 = reflection (reverse)

Parameters:

<modulation> OFF | IS95 | WCDMA | DVBT | DAB
 *RST: OFF

Manual operation: See "[Modulation](#)" on page 131

**CALCulate<Measurement>[:CHANnel<Channel>]:NRT:DMODulation:WCDMA:
 CRATe <value>**

Effective if [CALCulate<Measurement>\[:CHANnel<Channel>\]:NRT:
 DMODulation\[:VALue\]](#) WCDMA is set.

Sets the chip rate for the WCDMA communication standard.

Suffix:

<Measurement> 1 to 8
 Measurement

<Channel> 1 to 2
 1 = primary sensor, 2 = secondary sensor or 1 = forward, 2 =
 reflection (reverse)

Parameters:

<value> Range: 0.0 to 8.2e6
 *RST: 1.0e6
 Default unit: Hz

Manual operation: See "[WCDMA Chip Rate](#)" on page 132

INPut<Sensor>:PORT:OFFSet <offs>

Considers the transmission loss in a cable that connects the desired measurement point, set by [INPut<Sensor>:PORT:POSition](#), and the power sensor.

Suffix:

<Sensor> 1 to 128
 Configured sensor connected at: port A = 1, ... , port D = 4, R&S
 NRX-B9 = 101, USB and LAN port = 5 to 100

Parameters:

<offs> Range: 0.0 to 100.0
 *RST: 0.0
 Default unit: dB

Manual operation: See "[Offset](#)" on page 131

INPut<Sensor>:PORT:POSition <pos>

Selects the power sensor port to which the measurement results are referred to.

Suffix:

<Sensor> 1 to 128
Configured sensor connected at: port A = 1, ... , port D = 4, R&S NRX-B9 = 101, USB and LAN port = 5 to 100

Parameters:

<pos> SOURce | LOAD
*RST: SOURce

Manual operation: See "[Offset Reference Plane](#)" on page 131

13.8.8.3 NRT filter settings

Further information:

- [Chapter 7.5.3, "NRT filter settings"](#), on page 132

CALCulate<Measurement>[:CHANnel<Channel>]:AVERAge:COUNT:AUTO[:STATE]	373
CALCulate<Measurement>[:CHANnel<Channel>]:AVERAge:COUNT[:VALue]	374
CALCulate<Measurement>[:CHANnel<Channel>]:AVERAge:COUNT:ENUM	374
CALCulate<Measurement>[:CHANnel<Channel>]:NRT:APERture:MODE	374
CALCulate<Measurement>[:CHANnel<Channel>]:NRT:APERture[:VALue]	375
CALCulate<Measurement>[:CHANnel<Channel>]:NRT:VBWidth[:VALue]	375
[SENSe<Sensor>:]BWIDth:VIDeo:FNUMber	376
[SENSe<Sensor>:]BANDwidth:VIDeo:FNUMber	376

CALCulate<Measurement>[:CHANnel<Channel>]:AVERAge:COUNT:AUTO[:STATE] <state>

Sets the averaging mode.

Suffix:

<Measurement> 1 to 8
Measurement

<Channel> 1 to 2
1 = primary sensor, 2 = secondary sensor

Parameters:

<state> **OFF**
Uses the value set by [CALCulate<Measurement>\[:CHANnel<Channel>\]:AVERAge:COUNT\[:VALue\]](#)

ON
Determines the average count automatically from the level of the input signal.

ONCE
Automatically adapts the average count once.

*RST: ON

Manual operation: See "[Recalc Filter Length](#)" on page 124
See "[Averaging Mode](#)" on page 133

<Channel> 1 to 2
1 = primary sensor, 2 = secondary sensor or 1 = forward, 2 = reflection (reverse)

Parameters:

<mode> DEFault | USER
DEFault
Default setting
USER
Value defined by `CALCulate<Measurement>[:CHANnel<Channel>]:NRT:APERture[:VALue]`.
*RST: USER

Manual operation: See "[Integration Time Mode](#)" on page 133

CALCulate<Measurement>[:CHANnel<Channel>]:NRT:APERture[:VALue] <value>

Effective if `CALCulate<Measurement>[:CHANnel<Channel>]:NRT:APERture:MODE` USER is set.

Defines the integration time for a single measurement.

Suffix:

<Measurement> 1 to 8
Measurement

<Channel> 1 to 2
1 = primary sensor, 2 = secondary sensor

Parameters:

<value> Range: 0.005 to 0.111
*RST: 0.037
Default unit: s

Manual operation: See "[Integration Time](#)" on page 133

CALCulate<Measurement>[:CHANnel<Channel>]:NRT:VBWidth[:VALue] <value>

For measuring the peak envelope power, specify the video bandwidth that the power sensor uses for measuring the detected RF signal.

Suffix:

<Measurement> 1 to 8
Measurement

<Channel> 1 to 2
1 = primary sensor, 2 = secondary sensor or 1 = forward, 2 = reflection (reverse)

Parameters:

<value> 0
4 kHz

1
 200 kHz
2
 Maximum bandwidth of the power sensor
 Range: 0 to 2
 *RST: 2

Manual operation: See "[Video Bandwidth](#)" on page 133

[SENSe<Sensor>:]BWiDth:ViDeo:FNUMber <fnum>
[SENSe<Sensor>:]BANDwidth:ViDeo:FNUMber <fnum>

Requires the interface for R&S NRT-Z sensors (R&S NRX-B9).

Sets the video bandwidth for the rectified RF. The setting mainly influences the measurement of the peak envelope power (PEP), determination of the crest factor (CF), the measurement of the average burst power and the complementary cumulative distribution function (CCDF).

Suffix:

<Sensor> 101
 R&S NRT directional power sensor

Parameters:

<numeric_value> **0**
 4 kHz
1
 200 kHz
2
 The full bandwidth depends on the power sensor:
 R&S NRT-Z14: 600 kHz
 R&S NRT-Z43, R&S NRT-Z44: 4 MHz
 Range: 0 to 2
 *RST: 0

Manual operation: See "[Video Bandwidth](#)" on page 133

13.9 Configuring the test generator

If the sensor check source (R&S NRX-B1) is installed, you can use it as a power reference for testing the connected power sensors.

Further Information:

- [Chapter 3.2.1.2, "Module bay"](#), on page 26
- ["Sensor Check Source tab"](#) on page 146

[OUTPut:SOURce:STATe.....](#)377
[SOURce:OUTPut:STATe.....](#)377

SOURce:POWer[:VALue]	377
SOURce:PULM:STATe	377
SOURce[:RF]:FREQuency[:VALue]	378

OUTPut:SOURce:STATe <state>

SOURce:OUTPut:STATe <state>

Requires the sensor check source (R&S NRX-B1)

Enables or disables the signal output.

Parameters:

<state> *RST: 0

Manual operation: See "[Signal Output](#)" on page 146

SOURce:POWer[:VALue] <value>

Requires the sensor check source (R&S NRX-B1)

Sets the power level for the output signal.

If you enter a value without unit, the unit is defined by [SOURce:UNIT:POWer](#). For further information, see [Chapter 13.6.1.3, "Units"](#), on page 217.

Parameters:

<value> Range: -40.0 to +20.0
 *RST: +0.0
 Default unit: dBm

Manual operation: See "[Power Level](#)" on page 147

SOURce:PULM:STATe <state>

Requires the sensor check source (R&S NRX-B1)

Effective if the output signal is enabled, using [SOURce:OUTPut:STATe](#) or [OUTPut:SOURce:STATe](#).

Sets the signal type of the output signal.

Parameters:

<state> OFF | ON
 OFF
 Continuous wave
 ON
 Pulse modulation
 *RST: 0

Manual operation: See "[Signal Output](#)" on page 146

SOURce[:RF]:FREQuency[:VALue] <freq>

Requires the sensor check source (R&S NRX-B1)

Sets the frequency of the output signal.

Parameters:

<freq> Range: 50.0e6 to 1.0e9
 *RST: 50.0e6
 Default unit: Hz

Manual operation: See "Frequency" on page 146

13.10 Configuring the analog signal output and the trigger input/output

Configures the two multifunctional BNC connectors at the rear of the R&S NRX.

Further Information:

- Chapter 3.2.2.1, "Trig In / Out 2 and Out 1 / Trig Out connectors", on page 30
- "I/O 1, I/O 2 tabs" on page 147

INPut<undef>:TRIGger:IMPedance.....	378
OUTPut:LIMit:FAIL.....	379
OUTPut:LIMit:FEED:INDEX.....	379
OUTPut:MODE<output>.....	379
OUTPut:REcorder<output>:FEED:INDEX.....	380
OUTPut:REcorder<output>:LIMit:LOWer:CCDF.....	381
OUTPut:REcorder<output>:LIMit:LOWer[:VALue].....	381
OUTPut:REcorder<output>:LIMit:LOWer:POWer.....	381
OUTPut:REcorder<output>:LIMit:LOWer:RATio:RCOefficient.....	382
OUTPut:REcorder<output>:LIMit:LOWer:RATio:RFRatio.....	382
OUTPut:REcorder<output>:LIMit:LOWer:RATio:RLOSSs.....	382
OUTPut:REcorder<output>:LIMit:LOWer:RATio:SWR.....	383
OUTPut:REcorder<output>:LIMit:LOWer:RATio[:VALue].....	383
OUTPut:REcorder<output>:LIMit:UPPer:CCDF.....	384
OUTPut:REcorder<output>:LIMit:UPPer[:VALue].....	384
OUTPut:REcorder<output>:LIMit:UPPer:POWer.....	384
OUTPut:REcorder<output>:LIMit:UPPer:RATio:RCOefficient.....	385
OUTPut:REcorder<output>:LIMit:UPPer:RATio:RFRatio.....	385
OUTPut:REcorder<output>:LIMit:UPPer:RATio:RLOSSs.....	386
OUTPut:REcorder<output>:LIMit:UPPer:RATio:SWR.....	386
OUTPut:REcorder<output>:LIMit:UPPer:RATio[:VALue].....	386
OUTPut:TRIGger:SOURce.....	387

INPut<undef>:TRIGger:IMPedance <impedance>

Effective if `OUTPut:MODE<output> TIN` is set.

Configuring the analog signal output and the trigger input/output

Sets the termination resistance of the external trigger signal that is supplied at the Trig In / Out 2 connector. Choose a setting that fits the impedance of the trigger source to minimize reflections on the trigger signals.

Suffix:

<undef> 1 to n
No suffix required.

Parameters:

<impedance> HIGH | LOW
*RST: HIGH

Manual operation: See "[Impedance for Trigger Input](#)" on page 150

OUTPut:LIMit:FAIL <mode>

Effective if [OUTPut:MODE<output>](#) is set to:

LIM, FLIMit or RLIMit

Sets the fail voltage that is output if a measured value causes a limit violation.

Parameters:

<mode> LOW | HIGH
HIGH
Output voltage of 5 V.
LOW
Output voltage of 0 V.
*RST: LOW

Manual operation: See "[Fail Voltage](#)" on page 150

OUTPut:LIMit:FEED:INDex <index>

Effective if [OUTPut:MODE<output>](#) LIM or FLIM or RLIM is set.

Sets the measurement that is monitored.

Parameters:

<index>

Manual operation: See "[Measurement for Limit Output](#)" on page 150

OUTPut:MODE<output> <mode>

Sets the functionality of the Out 1 / Trig Out and Trig In / Out 2 connectors.

Configuring the analog signal output and the trigger input/output

Suffix:

<output>

1 to 2

BNC connectors at the rear; 1 = Out 1 / Trig Out,
2 = Trig In / Out 2**Parameters:**

<mode>

OFF | REcorder | FREcorder | RREcorder | LIMit | FLIMit |
RLIMit | TOUT | TIN | OFF | REcorder | FREcorder |
RREcorder | LIMit | FLIMit | RLIMit | TOUT | TIN**OFF**

Disabled

REcorder

Analog output

FREcorder

Forward analog output

RREcorder

Reflection analog output

LIMit

Limit violation

FLIMit

Forward limit violation

RLIMit

Reflection limit violation

TOUT

Trigger output

TIN

Trigger input

*RST: OFF

Manual operation: See "[Mode](#)" on page 148**OUTPut:REcorder<output>:FEED:INDex <index>**Effective if `OUTPut:MODE<output>` REC or FREC or RREC is set.

Sets the measurement of which the results are output.

Suffix:

<output>

1 to 2

BNC connectors at the rear; 1 = Out 1 / Trig Out,
2 = Trig In / Out 2**Parameters:**

<index>

Manual operation: See "[Measurement for Recorder Output](#)" on page 149

Configuring the analog signal output and the trigger input/output

OUTPut:RECOder<output>:LIMit:LOWer:CCDF <value>

Effective if `OUTPut:MODE<output>` is set to:

REC, FREC or RREC

Sets the CCDF measurement value that corresponds to 0 V output voltage.

Suffix:

<output> 1 to 2
 BNC connectors at the rear; 1 = Out 1 / Trig Out,
 2 = Trig In / Out 2

Parameters:

<value> Range: 0.0 to 100.0
 *RST: 0.0
 Default unit: pct

Manual operation: See "[0 V Equivalent](#)" on page 149

OUTPut:RECOder<output>:LIMit:LOWer[:VALue] <value>

Effective if `OUTPut:MODE<output>` is set to REC, FREC or RREC.

Sets the measurement value that corresponds to 0 V output voltage.

If you enter a value without unit, the unit is defined by `UNIT<Measurement>:POWER[:VALue]`. For further information, see [Chapter 13.6.1.3, "Units"](#), on page 217.

Suffix:

<output> 1 to 2
 BNC connectors at the rear; 1 = Out 1 / Trig Out,
 2 = Trig In / Out 2

Parameters:

<value> The range depends on the measurement.

Manual operation: See "[0 V Equivalent](#)" on page 149

OUTPut:RECOder<output>:LIMit:LOWer:POWER <value>

Effective if `OUTPut:MODE<output>` is set to:

REC, FREC or RREC

Sets the power measurement value that corresponds to 0 V output voltage.

If you enter a value without unit, the unit is defined by `UNIT<Measurement>:POWER[:VALue]`. For further information, see [Chapter 13.6.1.3, "Units"](#), on page 217.

Suffix:

<output> 1 to 2
 BNC connectors at the rear; 1 = Out 1 / Trig Out,
 2 = Trig In / Out 2

Configuring the analog signal output and the trigger input/output

Parameters:

<value> Range: -180.0 to +210.0
 *RST: -30.0
 Default unit: dBm

Manual operation: See "[0 V Equivalent](#)" on page 149

OUTPut:RECOOrder<output>:LIMit:LOWer:RATio:RCOefficient <value>

Effective if `OUTPut:MODE<output>` is set to:

REC, FREC or RREC

Sets the reflection coefficient measurement value that corresponds to 0 V output voltage.

Suffix:

<output> 1 to 2
 BNC connectors at the rear; 1 = Out 1 / Trig Out,
 2 = Trig In / Out 2

Parameters:

<value> Range: -1e18 to 1e18
 *RST: 0.0
 Default unit: -

Manual operation: See "[0 V Equivalent](#)" on page 149

OUTPut:RECOOrder<output>:LIMit:LOWer:RATio:RFRatio <value>

Effective if `OUTPut:MODE<output>` is set to:

REC, FREC or RREC

Sets the ratio of forward/reverse power that corresponds to 0 V output voltage.

Suffix:

<output> 1 to 2
 BNC connectors at the rear; 1 = Out 1 / Trig Out,
 2 = Trig In / Out 2

Parameters:

<value> Range: 0.0 to 100.0
 *RST: 0.0
 Default unit: pct

Manual operation: See "[0 V Equivalent](#)" on page 149

OUTPut:RECOOrder<output>:LIMit:LOWer:RATio:RLOSSs <value>

Effective if `OUTPut:MODE<output>` is set to:

REC, FREC or RREC

Configuring the analog signal output and the trigger input/output

Sets the return loss measurement value that corresponds to 0 V output voltage.

Suffix:

<output> 1 to 2
BNC connectors at the rear; 1 = Out 1 / Trig Out,
2 = Trig In / Out 2

Parameters:

<value> Range: -180.0 to 180.0
*RST: 0.0
Default unit: dB

Manual operation: See "[0 V Equivalent](#)" on page 149

OUTPut:RECOder<output>:LIMit:LOWer:RATio:SWR <value>

Effective if `OUTPut:MODE<output>` is set to:

REC, FREC or RREC

Sets the standing wave ration (SWR) measurement value that corresponds to 0 V output voltage.

Suffix:

<output> 1 to 2
BNC connectors at the rear; 1 = Out 1 / Trig Out,
2 = Trig In / Out 2

Parameters:

<value> Range: -1e18 to 1e18
*RST: 1.0
Default unit: -

Manual operation: See "[0 V Equivalent](#)" on page 149

OUTPut:RECOder<output>:LIMit:LOWer:RATio[:VALue] <value>

Effective if `OUTPut:MODE<output>` is set to:

REC, FREC or RREC

Sets the power ratio measurement value that corresponds to 0 V output voltage.

If you enter a value without unit, the unit is defined by `UNIT<Measurement>:POWER:RATio`. For further information, see [Chapter 13.6.1.3, "Units"](#), on page 217.

Suffix:

<output> 1 to 2
BNC connectors at the rear; 1 = Out 1 / Trig Out,
2 = Trig In / Out 2

Parameters:

<value> Range: -180.0 to +180.0
*RST: +0.0
Default unit: dB

Configuring the analog signal output and the trigger input/output

Manual operation: See ["0 V Equivalent"](#) on page 149

OUTPut:RECOder<output>:LIMit:UPPer:CCDF <value>

Effective if `OUTPut:MODE<output>` is set to:

REC, FREC or RREC

Sets the CCDF measurement value that corresponds to 2.5 V output voltage.

Suffix:

<output> 1 to 2
 BNC connectors at the rear; 1 = Out 1 / Trig Out,
 2 = Trig In / Out 2

Parameters:

<value> Range: 0.0 to 100.0
 *RST: 1.0
 Default unit: pct

Manual operation: See ["2.5 V Equivalent"](#) on page 149

OUTPut:RECOder<output>:LIMit:UPPer[:VALue] <value>

Effective if `OUTPut:MODE<output>` is set to REC, FREC or RREC.

Sets the measurement value that corresponds to 2.5 V output voltage.

If you enter a value without unit, the unit is defined by `UNIT<Measurement>:POWER[:VALue]`. For further information, see [Chapter 13.6.1.3, "Units"](#), on page 217.

Suffix:

<output> 1 to 2
 BNC connectors at the rear; 1 = Out 1 / Trig Out,
 2 = Trig In / Out 2

Parameters:

<value> The range depends on the measurement.

Manual operation: See ["2.5 V Equivalent"](#) on page 149

OUTPut:RECOder<output>:LIMit:UPPer:POWER <value>

Effective if `OUTPut:MODE<output>` is set to:

REC, FREC or RREC

Sets the power measurement value that corresponds to 2.5 V output voltage.

If you enter a value without unit, the unit is defined by `UNIT<Measurement>:POWER[:VALue]`. For further information, see [Chapter 13.6.1.3, "Units"](#), on page 217.

Configuring the analog signal output and the trigger input/output

Suffix:

<output>

1 to 2

BNC connectors at the rear; 1 = Out 1 / Trig Out,
2 = Trig In / Out 2**Parameters:**

<value>

Range: -180.0 to +210.0

*RST: +30.0

Default unit: dBm

Manual operation: See "[2.5 V Equivalent](#)" on page 149**OUTPut:RECOOrder<output>:LIMit:UPPer:RATio:RCOefficient <value>**Effective if `OUTPut:MODE<output>` is set to:

REC, FREC or RREC

Sets the reflection coefficient measurement value that corresponds to 2.5 V output voltage.

Suffix:

<output>

1 to 2

BNC connectors at the rear; 1 = Out 1 / Trig Out,
2 = Trig In / Out 2**Parameters:**

<value>

Range: -1e18 to 1e18

*RST: 1.0

Default unit: -

Manual operation: See "[2.5 V Equivalent](#)" on page 149**OUTPut:RECOOrder<output>:LIMit:UPPer:RATio:RFRatio <value>**Effective if `OUTPut:MODE<output>` is set to:

REC, FREC or RREC

Sets the ratio of forward/reverse power that corresponds to 2.5 V output voltage.

Suffix:

<output>

1 to 2

BNC connectors at the rear; 1 = Out 1 / Trig Out,
2 = Trig In / Out 2**Parameters:**

<value>

Range: 0.0 to 100.0

*RST: 100.0

Default unit: pct

Manual operation: See "[2.5 V Equivalent](#)" on page 149

Configuring the analog signal output and the trigger input/output

OUTPut:RECOder<output>:LIMit:UPPer:RATio:RLOSs <value>

Effective if **OUTPut:MODE<output>** is set to:

REC, FREC or RREC

Sets the return loss measurement value that corresponds to 2.5 V output voltage.

Suffix:

<output> 1 to 2
 BNC connectors at the rear; 1 = Out 1 / Trig Out,
 2 = Trig In / Out 2

Parameters:

<value> Range: -180.0 to 180.0
 *RST: 10.0
 Default unit: dB

Manual operation: See "[2.5 V Equivalent](#)" on page 149

OUTPut:RECOder<output>:LIMit:UPPer:RATio:SWR <value>

Effective if **OUTPut:MODE<output>** is set to:

REC, FREC or RREC

Sets the standing wave ratio (SWR) measurement value that corresponds to 2.5 V output voltage.

Suffix:

<output> 1 to 2
 BNC connectors at the rear; 1 = Out 1 / Trig Out,
 2 = Trig In / Out 2

Parameters:

<value> Range: -1e18 to 1e18
 *RST: 10.0
 Default unit: -

Manual operation: See "[2.5 V Equivalent](#)" on page 149

OUTPut:RECOder<output>:LIMit:UPPer:RATio[:VALue] <value>

Effective if **OUTPut:MODE<output>** is set to:

REC, FREC or RREC

Sets the power ratio measurement value that corresponds to 2.5 V output voltage.

If you enter a value without unit, the unit is defined by **UNIT<Measurement>:POWER:RATio**. For further information, see [Chapter 13.6.1.3, "Units"](#), on page 217.

Suffix:

<output> 1 to 2
 BNC connectors at the rear; 1 = Out 1 / Trig Out,
 2 = Trig In / Out 2

Parameters:

<value> Range: -180.0 to +180.0
 *RST: +10.0
 Default unit: dB

Manual operation: See "2.5 V Equivalent" on page 149

OUTPut:TRIGger:SOURce <source>

Effective if `OUTPut:MODE<output>` TOUT is set.

Sets the trigger source.

Parameters:

<source> SENS1 | SENS2 | SENS3 | SENS4 | EXTernal | CHKSource
 *RST: EXTernal

Manual operation: See "Trigger Source for Trigger Output" on page 150

13.11 Zeroing

Further Information:

- Chapter 9, "Zeroing sensors", on page 136

<code>CALibration<Sensor>:ZERO</code>	387
<code>CALibration<Sensor>:ZERO:AUTO</code>	388
<code>CALibration<undef>:ALL:ZERO:AUTO</code>	388
<code>CALibration<Sensor>:ZERO:FAST:AUTO</code>	389
<code>CALibration<undef>:ALL:ZERO:FAST:AUTO</code>	389

CALibration<Sensor>:ZERO [<auto>]

Performs zeroing for the power sensor connected to selected port.

Turn off all test signals before zeroing. An active test signal during zeroing causes an error.

While zero calibration is in progress, no queries or other setting commands are allowed, since the command is synchronous. Any communication attempt can run into a timeout. Use `*WAI` to recognize the end of a zeroing procedure.

Suffix:

<Sensor>

1 to 128

Configured sensor connected at: port A = 1, ... , port D = 4, R&S NRX-B9 = 101, USB and LAN port = 5 to 100

Parameters:

<auto>

ON | OFF | ONCE | LFR | UFR

ON

Return value if a calibration is in progress.

OFF

Return value if no calibration is in progress.

ONCE

Starts zeroing.

LFR | UFR

Starts zeroing in a lower frequency range (LRF) or upper frequency range (UFR), thus reducing the required time by half. Not accepted by all power sensors. Consult the manual of the power sensor concerned.

CALibration<Sensor>:ZERO:AUTO [<auto>]

Performs zeroing using the signal at the power sensor input.

Turn off all test signals before zeroing. An active test signal during zeroing causes an error.

While zero calibration is in progress, no queries or other setting commands are allowed, since the command is synchronous. Any communication attempt can run into a timeout. Use [*WAI](#) to recognize the end of a zeroing procedure.

The command is not fully R&S NRP2 compatible. If port 1 is assigned to measurement 1 and so on, the command works. If port 1 is assigned to measurement 2, for example, enable the R&S NRP2 emulation using [SYSTem:LANGuage](#) "NRP2".

Suffix:

<Sensor>

1 to 128

Configured sensor connected at: port A = 1, ... , port D = 4, R&S NRX-B9 = 101, USB and LAN port = 5 to 100

Parameters:

<auto>

ON | OFF | ONCE | LFR | UFR

See [CALibration<Sensor>:ZERO](#) on page 387.

CALibration<undef>:ALL:ZERO:AUTO [<auto>]

Applies to all connected power sensors. See [CALibration<Sensor>:ZERO:AUTO](#) on page 388.

Suffix:

<undef>

1 to n

No suffix required.

Parameters:

<auto> ON | OFF | ONCE | LFR | UFR

CALibration<Sensor>:ZERO:FAST:AUTO [<auto>]

Effective for trace measurements.

Performs fast zeroing. Since the commands are processed very quickly, they are not overlapping.

The command is not fully R&S NRP2 compatible. If port 1 is assigned to measurement 1 and so on, the command works. If port 1 is assigned to measurement 2, for example, enable the R&S NRP2 emulation using `SYSTem:LANGuage "NRP2"`.

Suffix:

<Sensor> 1 to 128

Configured sensor connected at: port A = 1, ... , port D = 4, R&S NRX-B9 = 101, USB and LAN port = 5 to 100

Parameters:

<auto> ON | OFF | ONCE | LFR | UFR

See `CALibration<Sensor>:ZERO` on page 387.

CALibration<undef>:ALL:ZERO:FAST:AUTO [<auto>]

Applies to all connected power sensors. See `CALibration<Sensor>:ZERO:FAST:AUTO` on page 389.

Suffix:

<undef> 1 to n

No suffix required.

Parameters:

<auto> ON | OFF | ONCE | LFR | UFR

13.12 Running selftests

Used for testing the connected power sensors and the R&S NRX.

Further information:

- [Chapter 10.4, "Test"](#), on page 167

<code>CALibration<Sensor>:TEST?</code>	390
<code>CALibration<Sensor>:TEST:DEViation?</code>	390
<code>CALibration<Sensor>:TEST:REFerence?</code>	390
<code>DIAGnostic:INFO:OTIME?</code>	391
<code>TEST:DEVIce:RESult?</code>	391
<code>TEST:DEVIce[:ALL]</code>	391

TEST:USB:STORage?.....	391
TEST:SENSor<Sensor>?.....	391
SYSTem:SENSor<Sensor>:TEST?.....	392

CALibration<Sensor>:TEST?

Requires a thermal power sensor, equipped with an additional test heater.

Queries the power difference in W when measuring with the external heater enabled and disabled.

Suffix:

<Sensor> 1 to 128
 Configured sensor connected at: port A = 1, ... , port D = 4, R&S
 NRX-B9 = 101, USB and LAN port = 5 to 100

Usage: Query only

CALibration<Sensor>:TEST:DEVIation?

Requires a thermal power sensor, equipped with an additional test heater.

Queries the relative deviation of the current power difference from the reference value stored in the calibration data set. The relative deviation is calculated as follows:

<relative deviation> = (<current power difference> / <reference value>) - 1

with

<current power difference>: CALibration<Sensor>:TEST?

<reference value>: CALibration<Sensor>:TEST:REFerence?

Suffix:

<Sensor> 1 to 128
 Configured sensor connected at: port A = 1, ... , port D = 4, R&S
 NRX-B9 = 101, USB and LAN port = 5 to 100

Usage: Query only

CALibration<Sensor>:TEST:REFerence?

Requires a thermal power sensor, equipped with an additional test heater.

Queries the reference value of the power difference in W when measuring with the external heater enabled and disabled. The reference value is determined during the calibration process and stored in the calibration data set.

Suffix:

<Sensor> 1 to 128
 Configured sensor connected at: port A = 1, ... , port D = 4, R&S
 NRX-B9 = 101, USB and LAN port = 5 to 100

Usage: Query only

DIAGnostic:INFO:OTIME?

Queries the count of the built-in elapsed-time meter. The count is always output in hours [h] and cannot be changed.

Usage: Query only

TEST:DEVIce:RESult?

Queries the test results of `TEST:DEVIce[:ALL]`.

Usage: Query only

TEST:DEVIce[:ALL] [<argument>]

Performs tests for the keyboard, display and touch panel.

Parameters:

<argument> The tests can be performed as single tests or as combined test.

"SubSystemGui:KeyboardTest"

Keyboard test

"SubSystemGui:DisplayTest"

Display test

"SubSystemGui:TouchTest"

Touch test

Example:

```
TEST:DEV "SubSystemGui:
KeyboardTest;DisplayTest;TouchTest";*OPC
Performs a combined test.
```

TEST:USB:STORAge? [<argument>]

Checks the connected memory stick.

Query parameters:

<argument>	0	Test passed
	1	Test failed; no memory stick connected or memory stick does not respond.

Usage: Query only

TEST:SENSor<Sensor>?

Starts a selftest of the selected power sensor and returns the result. In contrast to `*TST?`, this command returns detailed information that you can use for troubleshooting.

The response is sensor-dependent. It always contains an identification string for the power sensor with the type name and the firmware version number. If an error has occurred, the response also contains the error message in plain text.

Suffix:

<Sensor> 1 to 128
Configured sensor connected at: port A = 1, ... , port D = 4, R&S NRX-B9 = 101, USB and LAN port = 5 to 100

Usage: Query only

Manual operation: See "[Sensor Test](#)" on page 153

SYSTem:SENSor<Sensor>:TEST?

See [TEST:SENSor<Sensor>?](#) on page 391.

Suffix:

<Sensor> 1 to 128
Configured sensor connected at: port A = 1, ... , port D = 4, R&S NRX-B9 = 101, USB and LAN port = 5 to 100

Usage: Query only

Manual operation: See "[Sensor Test](#)" on page 153

13.13 Managing setups and correction tables

Manages setups and frequency-dependent correction tables.

Further information:

- [Chapter 8, "Saving and recalling settings"](#), on page 134
- ["Frequency Dependent Offset"](#) on page 120

MEMory:CATalog:STATe?	393
MEMory:CATalog:TABLE?	393
MEMory:CATalog[:ALL]?	393
MEMory:CLEar:TABLE	394
MEMory:CLEar[:NAME]	394
MEMory:FREE:STATe?	394
MEMory:FREE:TABLE?	394
MEMory:FREE[:ALL]?	395
MEMory:NStates?	395
MEMory:STATe:CATalog?	395
MEMory:STATe:DEFine	395
MEMory:STATe:MAP	395
MEMory:STATe:RESet	396
MEMory:TABLE:DATA?	396
MEMory:TABLE:DATA:POINts?	396
MEMory:TABLE:FREQuency	396
MEMory:TABLE:FREQuency:POINts?	397

MEMory:TABLE:GAIN:POINts?.....	397
MEMory:TABLE:GAIN[MAGNitude].....	397
MEMory:TABLE:MAP.....	397
MEMory:TABLE:MOVE.....	398
MEMory:TABLE:RESet.....	398
MEMory:TABLE:SElect.....	398

MEMory:CATalog:STATe?

Queries information on the available setups stored on the R&S NRX.

The response consists of:

<used disk space>, <remaining disk space>, "<setup 1>", "<setup 2>", "<setup 3>", ...

Each <setup> consists of:

<name>,<data type>,<required disk space in bytes>

Example: "Setup 1,STAT,1212479"

Usage: Query only

MEMory:CATalog:TABLE?

Queries information on the available frequency-dependent correction tables stored on the R&S NRX.

The response consists of:

<used disk space>, <remaining disk space>, "<table 1>", "<table 2>", "<table 3>", ...

Each <table> consists of:

<name>,<data type>,<required disk space in bytes>

Example: "Table 2,TABL,84"

Usage: Query only

MEMory:CATalog[:ALL]?

Queries information on the available setups and frequency-dependent correction tables stored on the R&S NRX. Combines the information queried by.

- [MEMory:CATalog:STATe?](#)
- [MEMory:CATalog:TABLE?](#)

The response consists of:

<used disk space>, <remaining disk space>, "<setup 1>", "<setup 2>", "<setup 3>", ..., "<table 1>", "<table 2>", "<table 3>", ...

Each <setup> and <table> consists of:

<name>,<data type>,<required disk space in bytes>

Example for <setup>: "Setup 1,STAT,1212479"

Example for <table>: "Table 2, TABL, 84"

Usage: Query only

MEMory:CLEar:TABLE

Deletes the content of the selected correction table.

Use `MEMory:TABLE:SElect` to select the table.

Notice: Once send, you cannot cancel this command. Cleared values are irretrievably lost.

Alternatively, you can use `MEMory:CLEar[:NAME]`.

Example: MEM:CLE:TABL

Usage: Event

MEMory:CLEar[:NAME] <name>>

Deletes the content of the correction table or setup carrying the specified name.

Notice: Once send, you cannot cancel this command. Cleared values are irretrievably lost.

Setting parameters:

<<name>> Name of the correction table or setup

Example: MEM:CLE "Setup 9"

Usage: Setting only

MEMory:FREE:STATe?

Queries the used and remaining disk space for setups.

Example: MEM:FREE:STAT?
Query
1358442496,8337127
Response

Usage: Query only

MEMory:FREE:TABLE?

Queries the used and remaining disk space for frequency-dependent correction tables.

Example: MEM:FREE:TABL?
Query
1358442496,267
Response

Usage: Query only

MEMory:FREE[:ALL]?

Queries the used and remaining disk space for setups and frequency-dependent correction tables. Combines the information queried by:

- [MEMory:FREE:STATe?](#)
- [MEMory:FREE:TABLE?](#)

Example: MEM:FREE?
Query
1358442496,8337394
Response

Usage: Query only

MEMory:NSTates?

Queries the number of available setups.

Example: MEM:NST?
Query
20
Response

Usage: Query only

MEMory:STATe:CATalog?

Queries the names of the available setups stored on the R&S NRX.

Usage: Query only

MEMory:STATe:DEFine <register_name>[, <register_number>]

MEMory:STATe:MAP <register_name>[, <register_number>]

Assigns a name to the setup stored in the memory location.

Take care to use recognizable names. The R&S NRX does not check whether a name is unique. If you want to reset the factory default, use [MEMory:STATe:RESet](#).

The query returns the memory location that is assigned to the setup name.

Parameters:

<register_name> Setup name; allowed are alphanumeric characters and special characters.

<register_number> Memory location of the setup

0

Factory-set setup, cannot be changed

1 to 19

Available memory locations

Example: MEM:STAT:MAP "test",5

Example: MEM:STAT:MAP? "test"

Manual operation: See "Save / Recall Setup" on page 135
See "Setup Name" on page 135

MEMory:STATe:RESet

Resets the setup names to factory default, "Setup 1", "Setup 2" and so on.

Usage: Event

MEMory:TABLE:DATA?

Queries the content of the selected table.

Use `MEMory:TABLE:SElect` to select the table.

The response consists of data pairs (frequency - offset):

<frequency 1>,<offset 1>,<frequency 2>,<offset 2>,<frequency 3>,<offset 3>, ...

Frequency in Hz, offset in dB.

Example: MEM:TABL:DATA?
Query
1.000000E+02,0.000000E+00,2.000000E+03,
0.000000E+00,3.000000E+04,0.000000E+00
Response

Usage: Query only

MEMory:TABLE:DATA:POINTs?

Queries the number of data pairs (frequency - offset) in the selected table.

Use `MEMory:TABLE:SElect` to select the table.

Usage: Query only

MEMory:TABLE:FREQuency <value>...

Defines the frequency values in the selected correction table. Existing data is overwritten. Take care that the number of frequency values matches the number of offset values, defined by `MEMory:TABLE:GAIN[:MAGNitude]`. If the numbers differ, excess values are ignored.

Use `MEMory:TABLE:SElect` to select the table.

Parameters:

<value> Numeric values with a maximum of 2 digits after the decimal point, separated by commas. Values with more than 2 decimal places are rounded.

Default unit: Hz

Example: `MEM:TABL:FREQ 50.00,60,70.3456`
Sets 3 frequency values; 50.00 Hz, 60.00 Hz, 70.35 Hz.

Manual operation: See "Edit table "<table name>" on page 121

MEMory:TABLE:FREQuency:POINts?

Queries the number of frequency values in the selected correction table.

Use `MEMory:TABLE:SElect` to select the table.

Usage: Query only

Manual operation: See "Edit table "<table name>" on page 121

MEMory:TABLE:GAIN:POINts?

Queries the number of offset values in the selected correction table.

Use `MEMory:TABLE:SElect` to select the table.

Usage: Query only

Manual operation: See "Edit table "<table name>" on page 121

MEMory:TABLE:GAIN[:MAGNitude] <value>...

Defines the offset values in the selected correction table. Existing data is overwritten. Take care that the number of frequency values matches the number of offset values, defined by `MEMory:TABLE:FREQuency`. If the numbers differ, excess values are ignored.

Use `MEMory:TABLE:SElect` to select the table.

Parameters:

<value> Numeric values with a maximum of 3 digits after the decimal point, separated by commas. Values with more than 3 decimal places are rounded.
Default unit: dB

Example: `MEM:TABL:GAIN 0,0.0033,0.04`
Sets 3 offset values; 0.000 dB, 0.003 dB, 0.040 dB.

Manual operation: See "Edit table "<table name>" on page 121

MEMory:TABLE:MAP <register_name>[, <register_number>]

Assigns a name to the correction table stored in the memory location.

Take care to use recognizable names. The R&S NRX does not check whether a name is unique. If you want to reset the factory default, use `MEMory:STATe:RESet`.

The query returns the memory location that is assigned to the setup name.

Parameters:

<register_name> Name of the correction table; allowed are alphanumeric characters and special characters.

<register_number> Memory location of the correction table
0
 Factory-set correction table, cannot be changed
1 to 9
 Available memory locations

Example: MEM:TABL:MAP "test5",5

Example: MEM:TABL:MAP? "test5"

Manual operation: See ["Edit table name"](#) on page 121

MEMory:TABLE:MOVE <string>...

Renames of the selected correction table.

Use [MEMory:TABLE:SElect](#) to select the table.

Setting parameters:

<string> "<old name>","<new name>"
 If the old name is incorrect, an error occurs.

Example: MEM:TABLE:MOVE "Test 1","test_5#"

Usage: Setting only

MEMory:TABLE:RESet

Deletes the content of all frequency-dependent correction tables and resets the names to factory default, "Table 1", "Table 2" and so on.

To delete the content of a specific table, use [MEMory:CLEar:TABLE](#).

Usage: Event

MEMory:TABLE:SElect <name>>

Selects one of the available offset tables for the following commands:

- [MEMory:TABLE:GAIN\[:MAGNitude\]](#)
- [MEMory:TABLE:GAIN:POINTs?](#)
- [MEMory:TABLE:FREQuency:POINTs?](#)
- [MEMory:TABLE:FREQuency](#)
- [MEMory:TABLE:DATA?](#)
- [MEMory:TABLE:DATA:POINTs?](#)

Alternatively, you can use [CALCulate<Measurement>\[:CHANnel<Channel>\]:CORRection:OFFSet:TABLE:INDEX](#).

Parameters:

<<name>> "<table name>"
 You can query the table names using `MEMory:CATalog:TABLE?`.

Example: `MEM:TABL:SEL "Table 1"`

Manual operation: See "[Frequency dependent offset table](#)" on page 121

13.14 System information and configuration

The SYSTem subsystem contains a series of commands for general functions that do not directly affect the measurement.

Further information:

- [Chapter 10, "System settings"](#), on page 138

13.14.1 Presetting

<code>SYSTem:PRESet</code>	399
<code>SYSTem:SENSor<Sensor>:RESet</code>	399

SYSTem:PRESet

Sets the R&S NRX to a defined initial state. The default settings are indicated in the description of commands as *RST value.

With the exceptions listed in [Table 13-17](#), this command corresponds to *RST.

*Table 13-17: Differences between *RST and SYSTem:PRESet*

Command	*RST	SYSTem:PRESet
<code>[SENSe<Sensor>:]AVERAge:TCONtrol</code>	REPeat	MOVing
<code>CALCulate<Measurement>[:CHANnel<Channel>]:AVERAge:TCONtrol[:ENUM]</code>	REPeat	MOVing
<code>CALCulate<Measurement>[:CHANnel<Channel>]:TRACe:AVERAge:TCONtrol[:ENUM]</code>	REPeat	MOVing
<code>INITiate<Measurement>:CONTinuous</code>	OFF	ON

Usage: Event

Manual operation: See "[Preset](#)" on page 135

SYSTem:SENSor<Sensor>:RESet

Sets the selected power sensor to a defined initial state.

Suffix:
 <Sensor> 1 to 128
 Configured sensor connected at: port A = 1, ... , port D = 4, R&S NRX-B9 = 101, USB and LAN port = 5 to 100

Usage: Event

13.14.2 Shutdown and reboot

SYSTem:REBoot.....	400
SYSTem:SENSor<Sensor>:REBoot.....	400
SYSTem:SHUTdown.....	400

SYSTem:REBoot

Reboots the R&S NRX.

Usage: Event

SYSTem:SENSor<Sensor>:REBoot

Reboots the selected power sensor.

Suffix:
 <Sensor> 1 to 128
 Configured sensor connected at: port A = 1, ... , port D = 4, R&S NRX-B9 = 101, USB and LAN port = 5 to 100

Usage: Event

SYSTem:SHUTdown

Shuts down the R&S NRX.

Usage: Event

13.14.3 Firmware update

You can integrate a firmware update function in an application.

Example: Integrating a firmware update of the R&S NRX

You want to update your R&S NRX with the `NRX_18.01.22.02.rsu` file. This file has a size of 10242884 bytes.

To send the file to the R&S NRX for updating the firmware, your application has to assemble a memory block containing:

```
SYST:FWUP <block_data>
```

The <block_data> are definite length arbitrary block data as described in [SYSTEM:FWUpdate](#) on page 401.

The size of the file is 10242884. This number has 8 digits. Thus, the <block_data> consist of the following:

- #
How many digits follow to specify the file size.
- 8
Number that specifies the file size.
- <file_contents>
Contents of the *.rsu file, byte-by-byte
- 0x0a
Delimiter

In this example, you write exactly 10242905 bytes to the R&S NRX, for example by using a 'viWrite()' function.

The 10242905 bytes result from the values of the list above:

$$9 + 1 + 1 + 1 + 1 + 8 + 10242884 + 1$$

In a (pseudo) string notation, the memory block looks as follows:

```
SYST:FWUP #810242884<file_contents>0x0a,
```

13.14.3.1 Updating the R&S NRX

SYSTEM:FWUpdate	401
SYSTEM:FWUpdate:STATus?	402

SYSTEM:FWUpdate <fwudata>>

Loads new operating firmware into the R&S NRX. Rohde & Schwarz provides the update file. For further details, see [Chapter 12, "Firmware update"](#), on page 171.

If you want to integrate a firmware update function in an application, see the example given in [Chapter 13.14.3, "Firmware update"](#), on page 400.

Setting parameters:

```
<<fwudata>>      <block_data>
                  Definite length arbitrary block data containing the direct copy of
                  the binary *.rsu file in the following format:
                  #
                  Single digit indicating how many digits follow to specify the size
                  of the binary file.
                  Number that specifies the size of the binary file.
                  Binary data
                  0x0a as appended delimiter for line feed
```

Usage: Setting only

SYSTem:FWUPdate:STATus?

Queries the result of the firmware update, returned as a readable string.

Further information.

- [SYSTem:FWUPdate](#) on page 401
- [Chapter 12, "Firmware update"](#), on page 171

Example: SYST:FWUP:STAT?
Query
"Success"
Response

Usage: Query only

13.14.3.2 Updating a connected power sensor

Prerequisite: The power sensor is connected as described in [Chapter 3.1.8, "Connecting power sensors"](#), on page 21 .

[SENSe<Sensor>:SYSTem:FWUPdate](#)..... 402
[SENSe<Sensor>:SYSTem:FWUPdate:STATus?](#).....402

SENSe<Sensor>:SYSTem:FWUPdate <fwudata>>

Loads new operating firmware into the selected power sensor. Rohde & Schwarz provides the update file. For further details, see [Chapter 12, "Firmware update"](#), on page 171.

If you want to integrate a firmware update function in an application, see the example given in [Chapter 13.14.3, "Firmware update"](#), on page 400.

Suffix:
<Sensor> 1 to 128
Configured sensor connected at: port A = 1, ... , port D = 4, R&S NRX-B9 = 101, USB and LAN port = 5 to 100

Setting parameters:
<<fwudata>> <block_data>
See [SYSTem:FWUPdate](#) on page 401.

Usage: Setting only

SENSe<Sensor>:SYSTem:FWUPdate:STATus?

Queries the result of the firmware update, returned as a readable string.

Further information.

- [SENSe<Sensor>:SYSTem:FWUPdate](#) on page 402
- [Chapter 12, "Firmware update"](#), on page 171

Suffix:	
<Sensor>	1 to 128 Configured sensor connected at: port A = 1, ... , port D = 4, R&S NRX-B9 = 101, USB and LAN port = 5 to 100
Example:	SENS:SYST:FWUP:STAT? Query "Success" Response
Usage:	Query only

13.14.4 Network settings

SYSTem:COMMunicate:INET[:SELF]:ADDRess.....	403
SYSTem:COMMunicate:NETWork[:IPADdress][:ADDRess].....	403
SYSTem:COMMunicate:INET[:SELF]:DNS:ADDRess.....	403
SYSTem:COMMunicate:NETWork[:IPADdress]:DNS.....	403
SYSTem:COMMunicate:INET[:SELF]:DNS:SUFFix.....	404
SYSTem:COMMunicate:NETWork[:COMMOn]:DOMain.....	404
SYSTem:COMMunicate:INET[:SELF]:GATeway:ADDRess.....	404
SYSTem:COMMunicate:NETWork[:IPADdress]:GATeway.....	404
SYSTem:COMMunicate:INET[:SELF]:MODE.....	404
SYSTem:COMMunicate:NETWork[:IPADdress]:MODE.....	404
SYSTem:COMMunicate:INET[:SELF]:SUBNetmask:ADDRess.....	405
SYSTem:COMMunicate:NETWork[:IPADdress]:SUBNet:MASK.....	405
SYSTem:COMMunicate:NETWork[:COMMOn]:HOSTname.....	405
SYSTem:COMMunicate:NETWork[:COMMOn]:WORKgroup.....	405
SYSTem:COMMunicate:NETWork:MACaddress?.....	405
SYSTem:COMMunicate:NETWork:REStart.....	405
SYSTem:COMMunicate:NETWork:STATus?.....	405

SYSTem:COMMunicate:INET[:SELF]:ADDRess <address>

SYSTem:COMMunicate:NETWork[:IPADdress][:ADDRess] <IPaddress>

Effective if `SYSTem:COMMunicate:NETWork[:IPADdress]:MODE` `STATic` is set.

Sets the IP address of the R&S NRX

Parameters:

<IPaddress> Consists of four blocks separated by dots, consisting of up to 3 digits. Example: 108.0.0.255
Range: 0 to 255 for each block

Manual operation: See "[IPv4 Address](#)" on page 142

SYSTem:COMMunicate:INET[:SELF]:DNS:ADDRess <server>

SYSTem:COMMunicate:NETWork[:IPADdress]:DNS <DNS>

Effective if `SYSTem:COMMunicate:NETWork[:IPADdress]:MODE` `STATic` is set.

Sets the DNS server address of your local subnet.

Parameters:

<DNS> Consists of four blocks separated by dots, consisting of up to 3 digits. Example: 123.456.0.1
Range: 0 to 255 for each block

Manual operation: See ["DNS Server"](#) on page 142

SYSTem:COMMunicate:INET[:SELF]:DNS:SUFFix <suffix>

SYSTem:COMMunicate:NETWork[:COMMON]:DOMain <Domain>

Sets the primary DNS suffix, that means the domain name. DNS uses the suffix for registration and name resolution to identify the R&S NRX uniquely in the entire network.

Parameters:

<Domain>

Manual operation: See ["DNS Suffix"](#) on page 141

SYSTem:COMMunicate:INET[:SELF]:GATeway:ADDRess <gateway>

SYSTem:COMMunicate:NETWork[:IPADDRESS]:GATeway <Gateway>

Effective if `SYSTem:COMMunicate:NETWork[:IPADDRESS]:MODE` `STATic` is set.

Sets the IP address of the default gateway.

Parameters:

<Gateway> Consists of four blocks separated by dots, consisting of up to 3 digits. Example: 192.168.10.254
Range: 0 to 255 for each block

Manual operation: See ["Default Gateway"](#) on page 142

SYSTem:COMMunicate:INET[:SELF]:MODE <state>

SYSTem:COMMunicate:NETWork[:IPADDRESS]:MODE <mode>

Sets how the IP address is assigned.

Parameters:

<mode> AUTO | STATic

AUTO

Assigns the IP address automatically, provided the network supports the dynamic host configuration protocol (DHCP).

STATic

Enables assigning the IP address manually.

*RST: AUTO

Manual operation: See ["Address Mode"](#) on page 141

SYSTem:COMMunicate:INET[:SELF]:SUBNetmask:ADDRESS <netmask>

SYSTem:COMMunicate:NETWork[:IPAddress]:SUBNet:MASK <Mask>

Effective if **SYSTem:COMMunicate:NETWork[:IPAddress]:MODE** **STATIC** is set.

Sets the subnet mask of your local subnet.

Parameters:

<Mask> Consists of four blocks separated by dots, consisting of up to 3 digits. Example: 255.255.255.0

Range: 0 to 255 for each block

Manual operation: See "[Subnet Mask](#)" on page 142

SYSTem:COMMunicate:NETWork[:COMMON]:HOSTName <Hostname>

Sets the individual hostname of the R&S NRX.

It is recommended that you do not change the default hostname to avoid problems with the network connection. However, if you change the hostname, be sure to use a unique name.

Parameters:

<Hostname>

Manual operation: See "[Host Name](#)" on page 140

SYSTem:COMMunicate:NETWork[:COMMON]:WORKgroup <Workgroup>

Sets an individual workgroup name for the R&S NRX.

Parameters:

<Workgroup>

SYSTem:COMMunicate:NETWork:MACAddress?

Queries the MAC address of the network adapter.

Usage: Query only

SYSTem:COMMunicate:NETWork:REStart

Restarts the network connection to the R&S NRX, i.e. terminates the connection and sets it up again.

Usage: Event

SYSTem:COMMunicate:NETWork:STATus?

Queries the network configuration state.

Usage: Query only

13.14.5 Remote settings

SYSTem:COMMunicate:GPIB[:SELF]:ADDRess.....	406
SYSTem:HELP:HEADers?.....	406
SYSTem:HELP:SYNTax?.....	406
SYSTem:HELP:SYNTax:ALL?.....	407
SYSTem:IDN:ANSWer.....	407
SYSTem:IDN:AUTO.....	407
SYSTem:IDN:MODE.....	407
SYSTem:LANGuage.....	408
SYSTem:OPT:ANSWer.....	408
SYSTem:OPT:AUTO.....	408
SYSTem:OPT:MODE.....	409
SYSTem:VERSion?.....	409

SYSTem:COMMunicate:GPIB[:SELF]:ADDRess <address>

Sets the GPIB address.

Parameters:

<address>	Range:	1 to 30
	*RST:	20

Manual operation: See "[GPIB Address](#)" on page 144

SYSTem:HELP:HEADers? [<Parser>]

Returns a list of all SCPI commands supported by the R&S NRX.

Query parameters:

<Parser>

Return values:

<Headers>	<dblock>
-----------	----------

Usage: Query only

SYSTem:HELP:SYNTax? <Header>

Returns the relevant parameter information for the specified SCPI command.

Query parameters:

<Header>	Long or short form of the SCPI command. See also Chapter 14.2.2, "Syntax for device-specific commands" , on page 469.
----------	---

Return values:

<Syntax>	<dblock>
----------	----------

Example:

```
SYST:HELP:SYNT? "SYST:KLOC"
Query
"SYSTem:KLOCK[?] <boolean>"
Response
```

Usage: Query only

SYSTem:HELP:SYNTax:ALL?

Queries the implemented SCPI commands and their parameters. Returns the result as a block data.

Return values:

<Syntax> <dblock>

Usage: Query only

SYSTem:IDN:ANSWer <string>

Effective if `SYSTem:IDN:MODE USER` is set.

Sets the customized instrument identification string so that you can identify each R&S NRX individually.

You can query the defined string using `*IDN?`.

Parameters:

<string> Identification string. Maximum string length is 128 characters.

Manual operation: See "[Custom IDN String](#)" on page 145

SYSTem:IDN:AUTO <status>

Enables or disables the automatic instrument identification for `*IDN?`.

Parameters:

<status> ON | OFF
*RST: 1

Manual operation: See "[Customization of *IDN?](#)" on page 144

SYSTem:IDN:MODE <mode>

Sets which identification string is used.

Parameters:

<mode> AUTO | USER
AUTO
Automatic instrument identification.
USER
Customized identification string. Define the string using `SYSTem:IDN:ANSWer`.
*RST: AUTO

Manual operation: See "[Customization of *IDN?](#)" on page 144

SYSTem:LANGUage <language>

Sets the native remote command set or an emulation of a predecessor or a power meter from another manufacturer. See also [Chapter 13.16, "Remote emulation"](#), on page 423.

Setting parameters:

<language> String

SCPI | NRX

Native remote command set of the R&S NRX.

NRP2 | NRP

Emulation of the selected predecessors.

N432A | N1911A | N1912A | E4418B | E4419B

Requires the NRX KS emulation mode (R&S NRX-K301) option.
Emulation of the selected Keysight power meter.

Query parameters:

<language> String

SCPI | NRP2 | NRP | N432A | N1911A | N1912A | E4418B | E4419B

*RST: SCPI

Manual operation: See "[Language](#)" on page 144

SYSTem:OPT:ANSWer <string>

Effective if `SYSTem:OPT:MODE USER` is set.

Sets the customized option identification string.

You can query the defined string using `*OPT?`.

Parameters:

<string> Option string. Maximum string length is 128 characters.

Manual operation: See "[Custom OPT String](#)" on page 145

SYSTem:OPT:AUTO <status>

Enables or disables the automatic instrument identification for `*OPT?`.

Parameters:

<status> ON | OFF

*RST: 1

Manual operation: See "[Customization of *OPT?](#)" on page 145

SYSTem:OPT:MODE <mode>

Sets which option string is used.

Parameters:

<mode> AUTO | USER

AUTO

Automatic option identification string.

USER

Customized option string. Define the string using [SYSTem:OPT:ANSWer](#).

*RST: AUTO

Manual operation: See "[Customization of *OPT?](#)" on page 145

SYSTem:VERSion?

Queries the SCPI version that the command set of the R&S NRX complies with.

Return values:

<version>

Usage: Query only

13.14.6 Managing sensors

[SENSe<Sensor>:]ADD	409
SYSTem:SENSor<Sensor>:INFO?	409

[SENSe<Sensor>:]ADD <sensor>

Adds a LAN power sensor. See "[To add a LAN power sensor](#)" on page 151.

Suffix:

<Sensor> 1 to 128

Configured sensor connected at: port A = 1, ... , port D = 4, R&S NRX-B9 = 101, USB and LAN port = 5 to 100

Setting parameters:

<sensor> Hostname of the power sensor.

Example: ADD "NRQ6-101435"

Usage: Setting only

Manual operation: See "[Add Sensor](#)" on page 152

SYSTem:SENSor<Sensor>:INFO? [<argument>]

Queries information about the selected power sensor, including calibration data.

Suffix:

<Sensor>

1 to 128

Configured sensor connected at: port A = 1, ... , port D = 4, R&S NRX-B9 = 101, USB and LAN port = 5 to 100

Query parameters:

<argument>

Default unit: Impedance in ohm, frequency in Hz, power in watt, resolution in seconds

Example:

SYST:SENS2:INFO?

Query

```
"Cal. Abs.:2015-07-08 ", "Cal. Due Date:
2017-07 ", "Cal. Lin.:
not applicable ", "Cal. Misc.:
2015-07-08 ", "Cal. Refl.:
2015-07-08 ", "Cal. S-Para.:
not applicable ", "Cal. S-Para. (User):
not applicable ", "Cal. Temp.:
not applicable ", "Coupling:AC ", "Function:
Power Terminating ", "Hostname:
nrp33sn-900444 ", "IP Address:
0.0.0.0 ", "Impedance:
50 ", "Manufacturer:Rohde & Schwarz ", "MaxFreq:
3.3e+10 ", "MaxPower:0.2 ", "MinFreq:
1e+07 ", "MinPower:1e-10 ", "Resolution:
5e-07 ", "SPD Mnemonic: ", "SW Build:
18.06.14.01 ", "Sensor Name:
NRP33SN-900004 ", "Serial:
900444 ", "Stock Number:
1419.7777K02 ", "Technology:
3-Path Diode ", "TestLimit:
0.160 dB ", "TestLimit pd:
0.160 dB ", "Type:NRP33SN ", "Uptime:904 "
```

Usage:

Query only

Manual operation: See ["Sensor Info"](#) on page 152See ["Hide Sensor Overload Message"](#) on page 169**13.14.7 Instrument information**

SYSTem:DID?	411
SYSTem:DEVIce:ID?	411
SYSTem:DFPRint	411
SYSTem:DFPRint:HISTory:COUNT?	411
SYSTem:DFPRint:HISTory:ENTRY?	411
SYSTem:INFO:TERMchar	411
SYSTem:INFO[:INFO]?	412

SYSTem:DID?**SYSTem:DEvice:ID?**

Queries the Rohde & Schwarz instrument ID.

Return values:

<DeviceID>

Usage: Query only

Manual operation: See "[System Info](#)" on page 155

SYSTem:DFPRint [<Path>]

Generates the device footprint.

Setting parameters:

<Path>

Return values:

<XMLDeviceFootprint><dblock>

SYSTem:DFPRint:HISTory:COUNT?

Queries the number of device footprints in the history.

Return values:

<Count>

Usage: Query only

SYSTem:DFPRint:HISTory:ENTRY? <index>

Queries a device footprint from the history.

Query parameters:

<index> **0**
Most recent device footprint

Return values:

<XmlDeviceFootprint><dblock>

Usage: Query only

SYSTem:INFO:TERMchar <termination>

Selects the termination characters for information returned by:

- `SYSTem:INFO[:INFO]?`
- `[SENSe<Sensor>:]CATalog?`
- `[SENSe<Sensor>:]INformation?`

Parameters:

<termination> CR | LF | CRLF | STRS
 *RST: STRS

SYSTem:INFO[:INFO]? [<argument>]

Queries information on the R&S NRX. See "[System Info](#)" on page 155.

If queried without parameters, the command returns all available information in the form of a list of strings separated by commas.

If you want to query specific information, add the query parameter:

SYST:INFO? "<string>"

Query parameters:

<argument> 'Manufacturer', 'Type', 'Stock Number', 'Serial', 'SW Build', 'MAC Address', 'Hostname', 'IP Address', 'Domain', 'Subnetmask', 'Gateway', 'Mode', 'Status', 'Sensor Name', 'Technology', 'Function', 'MinPower', 'MaxPower', 'MinFreq', 'MaxFreq', 'Impedance', 'Coupling', 'Uptime', 'Cal. Misc.', 'Cal. Abs.', 'Cal. Refl.', 'Cal. Temp.', 'Cal. Lin.', 'Cal. S-Para.', 'Cal. S-Para. (User)', 'SPD Mnemonic', 'Cal. Due Date', 'Certificate No', 'Limit', 'TestLimit', 'TestLimit pd'

Usage: Query only

Manual operation: See "[System Info](#)" on page 155

13.14.8 Date and time settings

SYSTem:DATE.....	412
SYSTem:DATE:UTC.....	412
SYSTem:DATE:LOCAl.....	413
SYSTem:TIME.....	413
SYSTem:TIME:UTC.....	413
SYSTem:TIME:LOCAl.....	413
SYSTem:TIME:DSTime:MODE.....	414
SYSTem:TIME:DSTime:RULE.....	414
SYSTem:TIME:DSTime:RULE:CATalog?.....	414
SYSTem:TIME:HRTimer:ABSolute:SET.....	414
SYSTem:TZONE.....	415

SYSTem:DATE <year>, <month>, <day>

SYSTem:DATE:UTC <year>, <month>, <day>

Sets the date in coordinated universal time (UTC).

SYSTem:DATE:LOCAl is changed accordingly.

Parameters:

<year> YYYY

<month> Range: 1 to 12

<day> Range: 1 to 31

Manual operation: See "Date" on page 156

SYSTem:DATE:LOCal <year>, <month>, <day>

Sets the local date.

[SYSTem:DATE:UTC](#) is changed accordingly.

Parameters:

<year> YYYY

<month> Range: 1 to 12

<day> Range: 1 to 31

Manual operation: See "Date" on page 156

SYSTem:TIME <hour>, <min>, <sec>

SYSTem:TIME:UTC <hour>, <minute>, <second>

Sets the time in the coordinated universal time (UTC).

[SYSTem:TIME:LOCAl](#) is changed accordingly.

Parameters:

<hour> hh

<minute> mm

<second> ss

Manual operation: See "Time" on page 156

SYSTem:TIME:LOCAl <hour>, <minute>, <second>

Sets the local time.

[SYSTem:TIME:UTC](#) is changed accordingly.

Parameters:

<hour> hh

<minute> mm

<second> ss

Manual operation: See "Time" on page 156

SYSTem:TIME:DSTime:MODE <dst>

Enables or disables the automatic clock adjustment for daylight saving time (DST). The automatic clock adjustment depends on configured time zone, see [SYSTem:TIME:DSTime:RULE](#) on page 414.

If disabled, the local time is calculated as:

Local time = UTC + time zone offset

Parameters:

<dst> OFF | ON

SYSTem:TIME:DSTime:RULE <rule>

Sets the time zone. You can query the list of the available time zones with [SYSTem:TIME:DSTime:RULE:CATalog?](#).

Parameters:

<rule>

Manual operation: See "[Time Zone Region](#)" on page 156
 See "[Time Zone](#)" on page 157

SYSTem:TIME:DSTime:RULE:CATalog?

Queries the list of available time zones.

Return values:

<cat>

Usage: Query only

Manual operation: See "[Time Zone Region](#)" on page 156
 See "[Time Zone](#)" on page 157

SYSTem:TIME:HRTimer:ABSolute:SET

Sets the start time for an absolute timer.

Return values:

<year> YYYY

<month> MM

<day> DD

<hour> hh

<min> mm

<sec> ss

<msec>

SYSTem:TZONE <hour>, <minute>

Sets the offset of the local time to the UTC time, due to the time zone. There can be an additional offset due to daylight saving time (DST).

Parameters:

<hour>	Range:	-12 to 15
<minute>	Range:	-59 to 59

13.14.9 Notifications and errors

The R&S NRX handles events and errors in 2 different queues, depending on their context:

- [System event queue](#)
SYSTem:SERRor commands
- [SCPI communication error queue](#)
SYSTem:ERRor commands

In the following, the expressions "error number" and "error code" are used synonymously.

13.14.9.1 System event queue

This system list contains notices, warnings and static errors that happen in setup.

A static error remains in the queue until you solve it. It prevents the execution of normal measurements. For example, if a power sensor overload occurs, you need to lower the input power to the power sensor. When you have done that, the static error disappears.

Warnings and static errors, you can remove from the queue using [SYSTem:SERRor:REMove](#).

For further information, see [Chapter 15.2.1, "Interpreting notifications and their number"](#), on page 498.

Currently, the event type is not included in the description of the event.

SYSTem:SERRor[:ALL]?.....	415
SYSTem:SERRor:REMove.....	416

SYSTem:SERRor[:ALL]?

Queries all events from the system event queue.

Returns a comma-separated list of unique event numbers.

Usage: Query only

SYSTem:SERRor:REMove <num>

Removes a notice or warning from the system event queue. You identify it by its unique number. To find out the unique number of an event, use [SYSTem:SERRor\[:ALL\]?](#).

Setting parameters:

<num> Unique number of the event
*RST: 0

Example:

```
SYST:SERR:REM 3004
```

Removes the notice that a newer version of the sensor check source (R&S NRX-B1) is available: [#3004 - version <no.> available for sensor check source \(R&S NRX-B1\)](#)

Example:

```
SYST:SERR:REM 2007
```

This number belongs to a static error: [#2007 - sensor overload](#). You cannot remove a static error from the queue, thus a "Parameter not allowed" error condition occurs. See also [Chapter 13.14.9.1, "System event queue"](#), on page 415.

Usage: Setting only

13.14.9.2 Changes in the system event queue

This SCPI list reports change in the system event queue. An entry is created when an event is reported or removed. Thus, deleting an event using [SYSTem:SERRor:REMove](#) also causes an entry in this list.

[SYSTem:SERRor:LIST:ALL?](#)..... 416
[SYSTem:SERRor:LIST:NEXT?](#)..... 416

SYSTem:SERRor:LIST:ALL?

Queries all changes in the system event queue that have not been read yet and removes them from the queue.

Usage: Query only

SYSTem:SERRor:LIST:NEXT?

Queries the list of system event changes for the oldest entry and removes it from the queue.

Returns an error number and a short description of the error. 0 means that no errors have occurred since the error queue was last read out.

Usage: Query only

13.14.9.3 SCPI communication error queue

This list contains errors in SCPI communication, for example, unknown commands or syntax errors. Generally, a single parameter or setting is affected.

SYSTem:ERRor:ALL?	417
SYSTem:ERRor:CODE:ALL?	417
SYSTem:ERRor:CODE[:NEXT]?	417
SYSTem:ERRor:COUNT?	418
SYSTem:ERRor:EXTEnded[:STATE]	418
SYSTem:ERRor[:NEXT]?	418

SYSTem:ERRor:ALL?

Queries all errors in SCPI communication that have not been read yet and removes them from the queue.

Returns a comma-separated list of error numbers and a short error description in the first-in first-out order.

Return values:

<code><ErrorNumber></code>	<code><n></code> Number as defined in the SCPI standard
	0 No errors have occurred since the error queue was last read out.

<code><ErrorText></code>	Short error description
--------------------------------	-------------------------

Usage: Query only

SYSTem:ERRor:CODE:ALL?

Queries all errors in SCPI communication that have not been read yet and removes them from the queue.

Returns a comma-separated list of error numbers, but no error description.

Return values:

<code><ErrorCode></code>	<code><n></code> Number as defined in the SCPI standard
	0 No errors have occurred since the error queue was last read out.

Usage: Query only

SYSTem:ERRor:CODE[:NEXT]?

Queries the SCPI communication error queue for the oldest entry and removes it from the queue.

Returns the error number, but no error description.

Return values:

<Error>	<n>
	Number as defined in the SCPI standard
	0
	No errors have occurred since the error queue was last read out.

Usage: Query only

SYSTem:ERRor:COUNT?

Queries the number of entries in the SCPI communication error queue.

Return values:

<ErrorCount>	Total number of entries
--------------	-------------------------

Example:

SYSTem:ERRor:COUNT

Queries the number of entries in the error queue.

Response: 1

One error has occurred since the error queue was last read out.

Usage: Query only

SYSTem:ERRor:EXTended[:STATe] <state>

Enables or disables the extended error messages that provide more information than [SYSTem:ERRor\[:NEXT\]?](#). The location of errors in the parsed command strings is also shown.

Parameters:

<state>	*RST:	ON
---------	-------	----

SYSTem:ERRor[:NEXT]?

Queries the SCPI communication error queue for the oldest entry and removes it from the queue.

Returns an error number and a short description of the error.

Return values:

<ErrorCode>	<n>
	Number as defined in the SCPI standard
	0
	No errors have occurred since the error queue was last read out.

<ErrorDescription>	Short error description
--------------------	-------------------------

Usage: Query only

13.14.10 Locking

SYSTem:KLOCK <klock>

Disables or enables the front panel keyboard of the instrument including the [LOCAL] key.

Parameters:

<klock> OFF | ON

SYSTem:LOCK:SHARed:STRing?

Queries the lock string assigned to the locking group if shared locking is enabled.

Writes an error in the error queue if shared locking is not enabled.

Return values:

<result>

Usage:

Query only

SYSTem:LOCK:TIMEout <timeout>

Sets the maximum time in milliseconds to wait when processing a command if the device is locked and the sender of the command is not the owner of the lock before the command is discarded and an error is written to the error queue.

Setting parameters:

<timeout>

Return values:

<result>

13.15 Using the status register

Further information:

- [Chapter 14.4.2, "Structure of a SCPI status register"](#), on page 477
- [General status register commands](#)..... 419
- [Reading the CONDition part](#)..... 420
- [Reading the EVENt part](#)..... 421
- [Controlling the ENABle part](#)..... 421
- [Controlling the negative transition part](#)..... 422
- [Controlling the positive transition part](#)..... 423

13.15.1 General status register commands

STATus:PRESet	420
STATus:QUEue[:NEXT]?	420

STATus:PRESet

Resets the edge detectors and `ENABLe` parts of all registers to a defined value.

Usage: Event

STATus:QUEue[:NEXT]?

Queries the most recent error queue entry and deletes it.

Return values:

<ErrorCode>	Numeric value <positive error number> Sensor-specific error <negative error number> SCPI error message 0 Error queue is empty.
<ErrorDescription>	String describing the error, example: "No error" Error queue is empty.

Usage: Query only

13.15.2 Reading the CONDition part

Further information:

- ["CONDition status register part"](#) on page 477
-

STATus:DEVIce:CONDition?**STATus:OPERation:BIT<bitno>:CONDition?****STATus:OPERation:CALibrating[:SUMMary]:CONDition?****STATus:OPERation:CONDition?****STATus:OPERation:LLFail<RegisterIndex>[:SUMMary]:CONDition?****STATus:OPERation:MEASuring[:SUMMary]:CONDition?****STATus:OPERation:MEASuring:EXTension<RegisterIndex>:CONDition?****STATus:OPERation:SENSe[:SUMMary]:CONDition?****STATus:OPERation:TRIGger[:SUMMary]:CONDition?****STATus:OPERation:TRIGger:EXTension<RegisterIndex>:CONDition?****STATus:OPERation:ULFail<RegisterIndex>[:SUMMary]:CONDition?****STATus:QUESTionable:BIT<bitno>:CONDition?****STATus:QUESTionable:CALibration[:SUMMary]:CONDition?****STATus:QUESTionable:CONDition?****STATus:QUESTionable:MEASure<RegisterIndex>:CONDition?**

STATus:QUESTIONable:POWER[:SUMMARY]:CONDITION?
STATus:QUESTIONable:WINDOW<RegisterIndex>:CONDITION?
Suffix:
 <RegisterIndex> 1 to 8
 Register
Usage: Query only

13.15.3 Reading the EVENT part

Further information:

- ["EVENT status register part"](#) on page 478

STATus:DEvice[:EVENT]?
STATus:OPERation[:EVENT]?
STATus:OPERation:BIT<bitno>[:EVENT]?
STATus:OPERation:CALibrating[:SUMMARY][:EVENT]?
STATus:OPERation:LLFail<RegisterIndex>[:SUMMARY][:EVENT]?
STATus:OPERation:MEASuring[:SUMMARY][:EVENT]?
STATus:OPERation:MEASuring:EXTension<RegisterIndex>[:SUMMARY][:EVENT]?
STATus:OPERation:SENSe[:SUMMARY][:EVENT]?
STATus:OPERation:TRIGger[:SUMMARY][:EVENT]?
STATus:OPERation:TRIGger:EXTension<RegisterIndex>[:SUMMARY][:EVENT]?
STATus:OPERation:ULFail<RegisterIndex>[:SUMMARY][:EVENT]?
STATus:QUESTIONable[:EVENT]?
STATus:QUESTIONable:BIT<bitno>[:EVENT]?
STATus:QUESTIONable:CALibration[:SUMMARY][:EVENT]?
STATus:QUESTIONable:MEASure<RegisterIndex>[:SUMMARY][:EVENT]?
STATus:QUESTIONable:POWER[:SUMMARY][:EVENT]?
STATus:QUESTIONable:WINDOW<RegisterIndex>[:SUMMARY][:EVENT]?
Suffix:
 <RegisterIndex> 1 to 8
 Register
Usage: Query only

13.15.4 Controlling the ENABLE part

Further information:

- ["ENABLE status register part"](#) on page 478

STATus:DEvice:ENABLE <value>
STATus:OPERation:BIT<bitno>:ENABLE <RegisterBit>
STATus:OPERation:CALibrating[:SUMMARY]:ENABLE <value>
STATus:OPERation:ENABLE <RegisterValue>
STATus:OPERation:LLFail<RegisterIndex>[:SUMMARY]:ENABLE <value>
STATus:OPERation:MEASuring[:SUMMARY]:ENABLE <value>
STATus:OPERation:MEASuring:EXTension<RegisterIndex>:ENABLE <value>

STATus:OPERation:SENSe[:SUMMARY]:ENABLE <value>
STATus:OPERation:TRIGger[:SUMMARY]:ENABLE <value>
STATus:OPERation:TRIGger:EXTension<RegisterIndex>:ENABLE <value>
STATus:OPERation:ULFail<RegisterIndex>[:SUMMARY]:ENABLE <value>
STATus:QUESTionable:BIT<bitno>:ENABLE <RegisterBit>
STATus:QUESTionable:CALibration[:SUMMARY]:ENABLE <value>
STATus:QUESTionable:ENABLE <RegisterValue>
STATus:QUESTionable:MEASure<RegisterIndex>:ENABLE <value>
STATus:QUESTionable:POWER[:SUMMARY]:ENABLE <value>
STATus:QUESTionable:WINDow<RegisterIndex>:ENABLE <value>

Suffix:

<RegisterIndex> 1 to 8
 Register

Parameters:

<value> *RST: 0

13.15.5 Controlling the negative transition part

Further information:

- ["PTRansition / NTRansition status register part"](#) on page 478

STATus:DEvice:NTRansition <value>
STATus:OPERation:BIT<bitno>:NTRansition <RegisterBit>
STATus:OPERation:CALibrating[:SUMMARY]:NTRansition <value>
STATus:OPERation:LLFail<RegisterIndex>[:SUMMARY]:NTRansition <value>
STATus:OPERation:MEASuring[:SUMMARY]:NTRansition <value>
STATus:OPERation:MEASuring:EXTension<RegisterIndex>:NTRansition <value>
STATus:OPERation:NTRansition <RegisterValue>
STATus:OPERation:SENSe[:SUMMARY]:NTRansition <value>
STATus:OPERation:TRIGger[:SUMMARY]:NTRansition <value>
STATus:OPERation:TRIGger:EXTension<RegisterIndex>:NTRansition <value>
STATus:OPERation:ULFail<RegisterIndex>[:SUMMARY]:NTRansition <value>
STATus:QUESTionable:BIT<bitno>:NTRansition <RegisterBit>
STATus:QUESTionable:CALibration[:SUMMARY]:NTRansition <value>
STATus:QUESTionable:NTRansition <RegisterValue>
STATus:QUESTionable:MEASure<RegisterIndex>:NTRansition <value>
STATus:QUESTionable:POWER[:SUMMARY]:NTRansition <value>
STATus:QUESTionable:WINDow<RegisterIndex>:NTRansition <value>

Suffix:

<RegisterIndex> 1 to 8
 Register

Parameters:

<value> *RST: 0

13.15.6 Controlling the positive transition part

Further information:

- ["PTRansition / NTRansition status register part"](#) on page 478

STATus:DEvIce:PTRansition <value>
STATus:OPERation:BIT<bitno>:PTRansition <RegisterBit>
STATus:OPERation:CALibrating[:SUMMARY]:PTRansition <value>
STATus:OPERation:LLFail<RegisterIndex>[:SUMMARY]:PTRansition <value>
STATus:OPERation:MEASuring[:SUMMARY]:PTRansition <value>
STATus:OPERation:PTRansition <RegisterValue>
STATus:OPERation:MEASuring:EXTension<RegisterIndex>:PTRansition <value>
STATus:OPERation:SENSe[:SUMMARY]:PTRansition <value>
STATus:OPERation:TRIGger[:SUMMARY]:PTRansition <value>
STATus:OPERation:TRIGger:EXTension<RegisterIndex>:PTRansition <value>
STATus:OPERation:ULFail<RegisterIndex>[:SUMMARY]:PTRansition <value>
STATus:QUESTionable:BIT<bitno>:PTRansition <RegisterBit>
STATus:QUESTionable:CALibration[:SUMMARY]:PTRansition <value>
STATus:QUESTionable:MEASure<RegisterIndex>:PTRansition <value>
STATus:QUESTionable:POWER[:SUMMARY]:PTRansition <value>
STATus:QUESTionable:PTRansition <RegisterValue>
STATus:QUESTionable:WINDow<RegisterIndex>:PTRansition <value>
Suffix:
 <RegisterIndex> 1 to 8
 Register
Parameters:
 <value> *RST: 65535

13.16 Remote emulation

The R&S NRX offers a remote emulation feature that makes it possible to control the instrument by commands other than the built-in native SCPI commands. This feature allows you to replace power meters, e.g. power meters from other manufacturers or predecessors, with the R&S NRX without having to change the remote control code.

The supported remote commands of the predecessors are described here:

- [Chapter 13.16.1, "R&S NRP2 compatibility"](#), on page 424

To select an emulation of a different command set

- ▶ [System] > "Connections" > "Remote" > [Emulations tab](#)
- ▶ Remote control: `SYSTem:LANGuage`



For emulating Keysight power meters, you need the NRX KS emulation mode (R&S NRX-K301) option.

13.16.1 R&S NRP2 compatibility

This chapter describes all R&S NRP2 remote commands that are still functional but not recommended to use if you start afresh. If you want to reuse programming from the R&S NRP2, you can use these commands. But if you start with the R&S NRX without inherited liabilities, only use the commands recommended for the R&S NRX.

13.16.1.1 CALCulate commands

CALCulate<Measurement>:LIMit<undef>:BEEP[:STATe].....	424
CALCulate<Measurement>:STATistics:MARKer:HORizontal:POSition[:X][:POWer].....	424
CALCulate<Measurement>:STATistics:MARKer:VERTical:POSition[:Y].....	424
CALCulate<Measurement>:TRACe:MARKer<Marker>:XPOSition.....	425

CALCulate<Measurement>:LIMit<undef>:BEEP[:STATe] <state>

Available for R&S NRP2 compatibility, but the command has no functionality in the R&S NRX.

Suffix:

<Measurement>	1 to 8 Measurement
<undef>	1 to n No suffix required.

Parameters:

<state>	*RST: OFF
---------	-----------

CALCulate<Measurement>:STATistics:MARKer:HORizontal:POSition[:X][:POWer] <value>

Available for compatibility. Recommended R&S NRX command:

`CALCulate<Measurement>:STATistics:MARKer:X:POSition[:ABSolute]`

The command is not fully R&S NRP2 compatible. If port 1 is assigned to measurement 1 and so on, the command works. If port 1 is assigned to measurement 2, for example, enable the R&S NRP2 emulation using `SYSTem:LANGuage "NRP2"`.

Suffix:

<Measurement>	1 to 8 Measurement
---------------	-----------------------

Parameters:

<value>

CALCulate<Measurement>:STATistics:MARKer:VERTical:POSition[:Y] <value>

Available for compatibility. Recommended R&S NRX command:

`CALCulate<Measurement>:STATistics[:CDF]:MARKer:Y:POSition`

`CALCulate<Measurement>:STATistics:PDF:MARKer:Y:POSition`

The command is not fully R&S NRP2 compatible. If port 1 is assigned to measurement 1 and so on, the command works. If port 1 is assigned to measurement 2, for example, enable the R&S NRP2 emulation using `SYSTem:LANGuage "NRP2"`.

Suffix:

<Measurement> 1 to 8
 Measurement

Parameters:

<value>

CALCulate<Measurement>:TRACe:MARKer<Marker>:XPOSITION <value>

Available for compatibility. Recommended R&S NRX command:

`DISPlay[:WINDow<Window>]:TRACe:MARKer<Marker>:POSition:TIME`

Suffix:

<Measurement> 1 to 8
 Measurement

<Marker> 1 to 4
 Marker (M1 to M4)

Parameters:

<value> Default unit: s

13.16.1.2 DISPlay commands

<code>DISPlay:ILLumination</code>	425
<code>DISPlay[:WINDow<Undef>]:SElect</code>	426
<code>DISPlay[:WINDow<Undef>]:SIZE</code>	426
<code>DISPlay[:WINDow<Window>]:ANALog:LOWer:POWer</code>	426
<code>DISPlay[:WINDow<Window>]:ANALog:LOWer:RATio</code>	426
<code>DISPlay[:WINDow<Window>]:ANALog:UPPer:POWer</code>	427
<code>DISPlay[:WINDow<Window>]:ANALog:UPPer:RATio</code>	427
<code>DISPlay[:WINDow<Window>]:AVALue</code>	427
<code>DISPlay[:WINDow<Window>]:FORMat</code>	427
<code>DISPlay[:WINDow<Window>]:METer:LOWer:POWer</code>	428
<code>DISPlay[:WINDow<Window>]:METer:LOWer:RATio</code>	428
<code>DISPlay[:WINDow<Window>]:METer:UPPer:POWer</code>	428
<code>DISPlay[:WINDow<Window>]:METer:UPPer:RATio</code>	429
<code>DISPlay[:WINDow<Window>][:NUMeric<Numeric>]:RESolution</code>	429
<code>DISPlay[:WINDow<Window>]:TRACe:LOWer</code>	429
<code>DISPlay[:WINDow<Window>]:TRACe:UPPer</code>	430
<code>DISPlay[:WINDow<Window>]:TSLot</code>	430

DISPlay:ILLumination <state>

Available for compatibility. Recommended R&S NRX command:

DISPlay:BRIGthness

Parameters:

<state> *RST: ON

DISPlay[:WINDow<Undef>]:SELEct <window>

Available for compatibility. Recommended R&S NRX command:

None. The commands of the DISPlay system conform to the R&S NRX concept.

Suffix:

<Undef> 1 to n
No suffix required.

Parameters:

<window> Range: 1 to 4
*RST: 1

DISPlay[:WINDow<Undef>]:SIZE <size>

Available for compatibility. Recommended R&S NRX command:

None. The commands of the DISPlay system conform to the R&S NRX concept.

Suffix:

<Undef> 1 to n
No suffix required.

Parameters:

<size> NORMal | ZOOMed
*RST: NORMal

DISPlay[:WINDow<Window>]:ANALog:LOWer:POWER <value>

Available for compatibility. Recommended R&S NRX command:

[CALCulate<Measurement>:METer<DirectionalChannel>:LOWer\[:DATA\]\[:POWER\]](#) on page 207

Suffix:

<Window> 1 to 8
Measurement

Parameters:

<value>

DISPlay[:WINDow<Window>]:ANALog:LOWer:RATio <value>

Available for compatibility. Recommended R&S NRX command:

[CALCulate<Measurement>:METer<DirectionalChannel>:LOWer\[:DATA\]:RATio\[:VALue\]](#) on page 207

Suffix:
 <Window> 1 to 8
 Measurement

Parameters:
 <value>

DISPlay[:WINDow<Window>]:ANALog:UPPer:POWer <value>

Available for compatibility. Recommended R&S NRX command:

[CALCulate<Measurement>:METer<DirectionalChannel>:UPPer\[:DATA\]\[:POWer\]](#) on page 210

Suffix:
 <Window> 1 to 8
 Measurement

Parameters:
 <value> <block_data>

DISPlay[:WINDow<Window>]:ANALog:UPPer:RATio <value>

Available for compatibility. Recommended R&S NRX command:

[CALCulate<Measurement>:METer<DirectionalChannel>:UPPer\[:DATA\]:RATio\[:VALue\]](#) on page 210

Suffix:
 <Window> 1 to 8
 Measurement

Parameters:
 <value> <block_data>

DISPlay[:WINDow<Window>]:AVALue <auxiliaries>

Available for compatibility. Recommended R&S NRX command:

[CALCulate<Measurement>:AVALue](#)

Suffix:
 <Window> 1 to 4
 Measurement pane

Parameters:
 <auxiliaries> NONE | NORMAl | EXTRemes | STATistics
 *RST: NONE

DISPlay[:WINDow<Window>]:FORMat <format>

Available for compatibility. Recommended R&S NRX command:

`CALCulate<Measurement>:DMODE`

The command is only fully R&S NRP2 compatible, if `SYSTEM:LANGuage NRP2` is set.

Suffix:

<Window> 1 to 4
Measurement pane

Parameters:

<format> DIGital | ANALog | GRAPhical
*RST: DIGital

DISPlay[:WINDow<Window>]:METer:LOWer:POWer <value>

Available for compatibility. Recommended R&S NRX command:

`CALCulate<Measurement>:METer<DirectionalChannel>:LOWer[:DATA][:POWer]` on page 207

Suffix:

<Window> 1 to 4
Measurement pane

Parameters:

<value>

DISPlay[:WINDow<Window>]:METer:LOWer:RATio <value>

Available for compatibility. Recommended R&S NRX command:

`CALCulate<Measurement>:METer<DirectionalChannel>:LOWer[:DATA]:RATio[:VALue]` on page 207

Suffix:

<Window> 1 to 4
Measurement pane

Parameters:

<value>

DISPlay[:WINDow<Window>]:METer:UPPer:POWer <value>

Available for compatibility. Recommended R&S NRX command:

`CALCulate<Measurement>:METer<DirectionalChannel>:UPPer[:DATA][:POWer]` on page 210

Suffix:

<Window> 1 to 4
Measurement pane

Parameters:

<value>

DISPlay[:WINDow<Window>]:METer:UPPer:RATio <value>

Available for compatibility. Recommended R&S NRX command:

`CALCulate<Measurement>:METer<DirectionalChannel>:UPPer[:DATA]:RATio[:VALue]` on page 210

Suffix:

<Window> 1 to 4
 Measurement pane

Parameters:

<value>

DISPlay[:WINDow<Window>][:NUMeric<Numeric>]:RESolution <resolution>

Available for compatibility. Recommended R&S NRX command:

`CALCulate<Measurement>:RESolution`

Suffix:

<Window> 1 to 4
 Measurement pane

<Numeric> 1 to 2
 No suffix required.

Parameters:

<resolution> Range: 0.001 | 0.01 | 0.1 | 1
 *RST: 0.01

DISPlay[:WINDow<Window>]:TRACe:LOWer <value>

Available for compatibility. Recommended R&S NRX command:

`CALCulate<Measurement>:TRACe:Y[:SCALE]:SPAN:DB`

`CALCulate<Measurement>:TRACe:Y[:SCALE]:SPAN:DBM`

`CALCulate<Measurement>:TRACe:Y[:SCALE]:SPAN:DBUV`

`CALCulate<Measurement>:TRACe:Y[:SCALE]:SPAN:DPCT`

`CALCulate<Measurement>:TRACe:Y[:SCALE]:SPAN:ONE`

`CALCulate<Measurement>:TRACe:Y[:SCALE]:SPAN:WATT`

`CALCulate<Measurement>:TRACe:Y[:SCALE]:TOP:DB`

`CALCulate<Measurement>:TRACe:Y[:SCALE]:TOP:DBM`

`CALCulate<Measurement>:TRACe:Y[:SCALE]:TOP:DBUV`

`CALCulate<Measurement>:TRACe:Y[:SCALE]:TOP:DPCT`

`CALCulate<Measurement>:TRACe:Y[:SCALE]:TOP:ONE`

`CALCulate<Measurement>:TRACe:Y[:SCALE]:TOP:WATT`

Suffix:

<Window> 1 to 4
 Measurement pane

Parameters:

<value>

DISPlay[:WINDow<Window>]:TRACe:UPPer <value>

Available for compatibility. Recommended R&S NRX command:

```
CALCulate<Measurement>:TRACe:Y[:SCALe]:SPAN:DB
CALCulate<Measurement>:TRACe:Y[:SCALe]:SPAN:DBM
CALCulate<Measurement>:TRACe:Y[:SCALe]:SPAN:DBUV
CALCulate<Measurement>:TRACe:Y[:SCALe]:SPAN:DPCT
CALCulate<Measurement>:TRACe:Y[:SCALe]:SPAN:ONE
CALCulate<Measurement>:TRACe:Y[:SCALe]:SPAN:WATT
CALCulate<Measurement>:TRACe:Y[:SCALe]:TOP:DB
CALCulate<Measurement>:TRACe:Y[:SCALe]:TOP:DBM
CALCulate<Measurement>:TRACe:Y[:SCALe]:TOP:DBUV
CALCulate<Measurement>:TRACe:Y[:SCALe]:TOP:DPCT
CALCulate<Measurement>:TRACe:Y[:SCALe]:TOP:ONE
CALCulate<Measurement>:TRACe:Y[:SCALe]:TOP:WATT
```

Suffix:

<Window> 1 to 4
 Measurement pane

Parameters:

<value>

DISPlay[:WINDow<Window>]:TSLot <slot>

Available for compatibility. Recommended R&S NRX command:

```
CALCulate<Measurement>[:POWER]:TSLot[:AVG]:SElection
```

Suffix:

<Window> 1 to 8
 Measurement

Parameters:

<slot> Range: 1 to 4
 *RST: 1

13.16.1.3 OUTPUT commands

OUTPut:RECOder<output>[:STATe].....	431
OUTPut:RECOder<output>:FEED[:VALue].....	431
OUTPut:ROSCillator[:STATe].....	431
OUTPut:TRIGger[:STATe].....	431
OUTPut:TTL<output>:ACTive.....	432
OUTPut:TTL<output>:FAIL.....	432
OUTPut:TTL<output>:FEED.....	432
OUTPut:TTL<output>[:STATe].....	432

OUTPut:RECOder<output>[:STATe] <state>

Available for compatibility. Recommended R&S NRX command:

`OUTPut:MODE<output>`

Suffix:

<output> 1 to 2
 BNC connectors at the rear; 1 = Out 1 / Trig Out,
 2 = Trig In / Out 2

Parameters:

<state>

OUTPut:RECOder<output>:FEED[:VALue] <string>

Available for compatibility. Recommended R&S NRX command:

`OUTPut:RECOder<output>:FEED:INDEX`

Suffix:

<output> 1 to 2
 BNC connectors at the rear; 1 = Out 1 / Trig Out,
 2 = Trig In / Out 2

Parameters:

<string>

OUTPut:ROSCillator[:STATe] <state>

Available for compatibility. Recommended R&S NRX command:

`OUTPut:SOURce:STATe`

Parameters:

<state>

OUTPut:TRIGger[:STATe] <state>

Available for compatibility. Recommended R&S NRX command:

`OUTPut:MODE<output>`

Parameters:

<state>

OUTPut:TTL<output>:ACTive <mode>

Available for compatibility. Recommended R&S NRX command:

`OUTPut:LIMit:FAIL`**Suffix:**

<output>	1...2
	1 to 2

Parameters:

<mode>	LOW HIGH
--------	------------

OUTPut:TTL<output>:FAIL <mode>

Available for compatibility. Recommended R&S NRX command:

`OUTPut:LIMit:FAIL`**Suffix:**

<output>	1...2
	1 to 2

Parameters:

<mode>	LOW HIGH
--------	------------

OUTPut:TTL<output>:FEED <feed>

Available for compatibility. Recommended R&S NRX command:

`OUTPut:LIMit:FEED:INDEX`**Suffix:**

<output>	1...2
	1 to 2

Parameters:

<feed>

OUTPut:TTL<output>[:STATe] <state>

Available for compatibility. Recommended R&S NRX command:

`OUTPut:MODE<output>`**Suffix:**

<output>	1...2
	1 to 2

Parameters:

<state>

13.16.1.4 SENSE commands

[SENSe<Sensor>:]AVERAge:COUNT:AUTO:MTIME.....	435
[SENSe<Sensor>:]AVERAge:COUNT:AUTO:NSRatio.....	435
[SENSe<Sensor>:]AVERAge:COUNT:AUTO:SLOT.....	435
[SENSe<Sensor>:]AVERAge:COUNT:AUTO:TYPE.....	435
[SENSe<Sensor>:]AVERAge:COUNT:AUTO[:STATe].....	436
[SENSe<Sensor>:]AVERAge:COUNT:ENUM.....	436
[SENSe<Sensor>:]AVERAge:COUNT[:VALue].....	436
[SENSe<Sensor>:]AVERAge:TCONtrol.....	437
[SENSe<Sensor>:]AVERAge:TYPE.....	437
[SENSe<Sensor>:]AVERAge[:STATe].....	437
[SENSe<Sensor>:]BWIth:VIDeo.....	438
[SENSe<Sensor>:]BANDwidth:VIDeo.....	438
[SENSe<Sensor>:]BWIth:VIDeo:LIST?.....	438
[SENSe<Sensor>:]BANDwidth:VIDeo:LIST?.....	438
[SENSe<Sensor>:]BURSt:MODE.....	438
[SENSe<Sensor>:]BURSt:PERiod.....	438
[SENSe<Sensor>:]BURSt:WIth.....	439
[SENSe<Sensor>:]CORRection:DCYCl:e:STATe.....	439
[SENSe<Sensor>:]CORRection:DCYCl:e[:INPut][:MAGNitude].....	439
[SENSe<Sensor>:]CORRection:DCYCl:e[:VALue].....	440
[SENSe<Sensor>:]CORRection:FDOFset[:INPut][:MAGNitude]?.....	440
[SENSe<Sensor>:]CORRection:FDOTable:STATe.....	440
[SENSe<Sensor>:]CORRection:FDOTable[:SElect].....	441
[SENSe<Sensor>:]CORRection:OFFSet:STATe.....	441
[SENSe<Sensor>:]CORRection:OFFSet[:VALue].....	441
[SENSe<Sensor>:]DATA?.....	441
[SENSe<Sensor>:]DM:WCDMa:CRATe.....	442
[SENSe<Sensor>:]FUNCTion[:ON].....	442
[SENSe<Sensor>:]INFormation?.....	442
[SENSe<Sensor>:]INPut:ATTenuation:AUTO.....	443
[SENSe<Sensor>:]INPut:ATTenuation[:VALue].....	443
[SENSe<Sensor>:]INternal:TRIGger:JITter:METHod.....	443
[SENSe<Sensor>:][:POWer:][:AVG:][:APERture[:VALue].....	443
[SENSe<Sensor>:][:POWer:][:AVG:][:SMOothing:STATe.....	444
[SENSe<Sensor>:][:POWer:]BURSt:DTOLerance.....	444
[SENSe<Sensor>:][:POWer:]NCORrection[:STATe].....	444
[SENSe<Sensor>:][:POWer:]TGATe:SElect.....	445
[SENSe<Sensor>:][:POWer:]TGATe<Gate>:OFFSet:TIME.....	445
[SENSe<Sensor>:][:POWer:]TGATe<Gate>:TIME.....	445
[SENSe<Sensor>:][:POWer:]TGATe<Gate>[:EXCLude]:MID:OFFSet[:TIME].....	446
[SENSe<Sensor>:][:POWer:]TGATe<Gate>[:EXCLude]:MID:TIME.....	446
[SENSe<Sensor>:][:POWer:]TGATe[:EXCLude]:MID[:STATe].....	446
[SENSe<Sensor>:][:POWer:]TSLot[:AVG]:COUNT.....	447
[SENSe<Sensor>:][:POWer:]TSLot[:AVG]:WIth.....	447
[SENSe<Sensor>:][:POWer:]TSLot[:AVG][:EXCLude]:MID:OFFSet[:TIME].....	447
[SENSe<Sensor>:][:POWer:]TSLot[:AVG][:EXCLude]:MID:TIME.....	447
[SENSe<Sensor>:][:POWer:]TSLot[:AVG][:EXCLude]:MID[:STATe].....	448
[SENSe<Sensor>:]POWer:CCDFunction:REFerence.....	448

[SENSe<Sensor>:]POWer:PEP:HOLD.....	448
[SENSe<Sensor>:]RANGe:AUTO.....	449
[SENSe<Sensor>:]RANGe:CLeVel.....	449
[SENSe<Sensor>:]RANGe[:VALue].....	449
[SENSe<Sensor>:]ROSCillator:REFio:FREQuency.....	450
[SENSe<Sensor>:]ROSCillator:REFio:OUTPut[:STATe].....	450
[SENSe<Sensor>:]ROSCillator:SOURce.....	450
[SENSe<Sensor>:]SAMPling.....	451
[SENSe<Sensor>:]SGAMma:CORRection:STATe.....	451
[SENSe<Sensor>:]SGAMma:PHASe.....	451
[SENSe<Sensor>:]SGAMma[:MAGNitude].....	451
[SENSe<Sensor>:]STATistics:SAMPles[:MINimum].....	452
[SENSe<Sensor>:]STATistics:SCALe:X:POINts.....	452
[SENSe<Sensor>:]STATistics:SCALe:X:RANGe.....	452
[SENSe<Sensor>:]STATistics:SCALe:X:RLeVel.....	453
[SENSe<Sensor>:]STATistics:TIME.....	453
[SENSe<Sensor>:]STATistics[:EXCLude]:MID:OFFSet[:TIME].....	453
[SENSe<Sensor>:]STATistics[:EXCLude]:MID:TIME.....	454
[SENSe<Sensor>:]TIMing:EXCLude:START.....	454
[SENSe<Sensor>:]TIMing:EXCLude:STOP.....	454
[SENSe<Sensor>:]TRACe:AVERAge:COUNT.....	454
[SENSe<Sensor>:]TRACe:AVERAge:TCONtrol.....	455
[SENSe<Sensor>:]TRACe:AVERAge[:STATe].....	455
[SENSe<Sensor>:]TRACe:ESAMpling:AUTO.....	455
[SENSe<Sensor>:]TRACe:MEASurement:ALGorithm.....	456
[SENSe<Sensor>:]TRACe:MEASurement:DEFine:DURation:REFerence.....	456
[SENSe<Sensor>:]TRACe:MEASurement:DEFine:TRANSition:HFerence.....	456
[SENSe<Sensor>:]TRACe:MEASurement:DEFine:TRANSition:LRFerence.....	457
[SENSe<Sensor>:]TRACe:MEASurement:POWer:AVG?.....	457
[SENSe<Sensor>:]TRACe:MEASurement:POWer:HFerence?.....	457
[SENSe<Sensor>:]TRACe:MEASurement:POWer:LRFerence?.....	458
[SENSe<Sensor>:]TRACe:MEASurement:POWer:MAX?.....	458
[SENSe<Sensor>:]TRACe:MEASurement:POWer:MIN?.....	458
[SENSe<Sensor>:]TRACe:MEASurement:POWer:PULSe:BASE?.....	458
[SENSe<Sensor>:]TRACe:MEASurement:POWer:PULSe:TOP?.....	459
[SENSe<Sensor>:]TRACe:MEASurement:POWer:REFerence?.....	459
[SENSe<Sensor>:]TRACe:MEASurement:PULSe:DCYCLe?.....	459
[SENSe<Sensor>:]TRACe:MEASurement:PULSe:DURation?.....	460
[SENSe<Sensor>:]TRACe:MEASurement:PULSe:PERiod?.....	460
[SENSe<Sensor>:]TRACe:MEASurement:PULSe:SEParation?.....	460
[SENSe<Sensor>:]TRACe:MEASurement:TRANSition:ESAMpling:AUTO[:STATe].....	460
[SENSe<Sensor>:]TRACe:MEASurement:TRANSition:NEGative:DURation?.....	461
[SENSe<Sensor>:]TRACe:MEASurement:TRANSition:NEGative:OCCurrence?.....	461
[SENSe<Sensor>:]TRACe:MEASurement:TRANSition:NEGative:OVERshoot?.....	461
[SENSe<Sensor>:]TRACe:MEASurement:TRANSition:POSitive:DURation?.....	461
[SENSe<Sensor>:]TRACe:MEASurement:TRANSition:POSitive:OCCurrence?.....	462
[SENSe<Sensor>:]TRACe:MEASurement:TRANSition:POSitive:OVERshoot?.....	462
[SENSe<Sensor>:]TRACe:MEASurement:TRANSition:SPERiod?.....	462
[SENSe<Sensor>:]TRACe:POINts.....	462

[SENSe<Sensor>:]AVERage:COUNT:AUTO:MTIME <maximum_time>

Available for compatibility. Recommended R&S NRX command:

```
CALCulate<Measurement>[:CHANnel<Channel>]:AVERage:COUNT:AUTO:
MTIME
```

Suffix:

<Sensor> 1 to 128
Configured sensor connected at: port A = 1, ... , port D = 4, R&S
NRX-B9 = 101, USB and LAN port = 5 to 100

Parameters:

<maximum_time> Range: 0.01 to 1000.0
*RST: 4.00
Default unit: s

[SENSe<Sensor>:]AVERage:COUNT:AUTO:NSRatio <nsr>

Available for compatibility. Recommended R&S NRX command:

```
CALCulate<Measurement>[:CHANnel<Channel>]:AVERage:COUNT:AUTO:
NSRatio
```

Suffix:

<Sensor> 1 to 128
Configured sensor connected at: port A = 1, ... , port D = 4, R&S
NRX-B9 = 101, USB and LAN port = 5 to 100

Parameters:

<nsr> Range: 100e-6 to 1.0
*RST: 0.01
Default unit: dB

[SENSe<Sensor>:]AVERage:COUNT:AUTO:SLOT <slot>

Available for compatibility. Recommended R&S NRX command:

```
CALCulate<Measurement>[:CHANnel<Channel>]:AVERage:COUNT:AUTO:
SLOT
```

Suffix:

<Sensor> 1 to 128
Configured sensor connected at: port A = 1, ... , port D = 4, R&S
NRX-B9 = 101, USB and LAN port = 5 to 100

Parameters:

<slot> Range: 1 to 128
*RST: 1

[SENSe<Sensor>:]AVERage:COUNT:AUTO:TYPE <type>

Available for compatibility. Recommended R&S NRX command:

CALCulate<Measurement>[:CHANnel<Channel>]:AVERage:COUNT:AUTO:
TYPE

Suffix:

<Sensor> 1 to 128
Configured sensor connected at: port A = 1, ... , port D = 4, R&S
NRX-B9 = 101, USB and LAN port = 5 to 100

Parameters:

<type> RESolution | NSRatio
*RST: RESolution

[SENSe<Sensor>:]AVERage:COUNT:AUTO[:STATe] <state>

Available for compatibility. Recommended R&S NRX command:

CALCulate<Measurement>[:CHANnel<Channel>]:AVERage:COUNT:AUTO[:
STATe]

Suffix:

<Sensor> 1 to 128
Configured sensor connected at: port A = 1, ... , port D = 4, R&S
NRX-B9 = 101, USB and LAN port = 5 to 100

Parameters:

<state> | OFF | ON | ONCE

[SENSe<Sensor>:]AVERage:COUNT:ENUM <value>

Available for compatibility. Recommended R&S NRX command:

CALCulate<Measurement>[:CHANnel<Channel>]:AVERage:COUNT:ENUM

Suffix:

<Sensor> 1 to 128
Configured sensor connected at: port A = 1, ... , port D = 4, R&S
NRX-B9 = 101, USB and LAN port = 5 to 100

Parameters:

<value> E1 | E2 | E4 | E8 | E16 | E32 | E64 | E128 | E256
*RST: E4

[SENSe<Sensor>:]AVERage:COUNT[:VALue] <count>

Available for compatibility. Recommended R&S NRX command:

CALCulate<Measurement>[:CHANnel<Channel>]:AVERage:COUNT[:VALue]

Suffix:

<Sensor> 1 to 128
Configured sensor connected at: port A = 1, ... , port D = 4, R&S
NRX-B9 = 101, USB and LAN port = 5 to 100

Parameters:

<count> Range: 1 to 1048576
 *RST: 4

[SENSe<Sensor>:]AVERAge:TCONtrol <mode>

Available for compatibility. Recommended R&S NRX command:

`CALCulate<Measurement>[:CHANnel<Channel>]:AVERAge:TCONtrol[:
 ENUM]`

Suffix:

<Sensor> 1 to 128
 Configured sensor connected at: port A = 1, ... , port D = 4, R&S
 NRX-B9 = 101, USB and LAN port = 5 to 100

Parameters:

<mode> MOVing | REPeat
 If you use `SYSTem:PRESet` instead of `*RST`, the RST value dif-
 fers. See [Table 13-17](#).
 *RST: REPeat

[SENSe<Sensor>:]AVERAge:TYPE <type>

Available for compatibility. Recommended R&S NRX command:

`CALCulate<Measurement>[:CHANnel<Channel>]:AVERAge:TYPE`

Suffix:

<Sensor> 1 to 128
 Configured sensor connected at: port A = 1, ... , port D = 4, R&S
 NRX-B9 = 101, USB and LAN port = 5 to 100

Parameters:

<type> POWer | VIDeo | LINear
 *RST: POWer

[SENSe<Sensor>:]AVERAge[:STATe] <state>

Available for compatibility. Recommended R&S NRX command:

`CALCulate<Measurement>[:CHANnel<Channel>]:AVERAge[:STATe]`

Suffix:

<Sensor> 1 to 128
 Configured sensor connected at: port A = 1, ... , port D = 4, R&S
 NRX-B9 = 101, USB and LAN port = 5 to 100

Parameters:

<state> ON | OFF
 *RST: ON

[SENSe<Sensor>:]BWIDth:VIDeo <mode>

[SENSe<Sensor>:]BANDwidth:VIDeo <mode>

Available for compatibility. Recommended R&S NRX command:

`CALCulate<Measurement>[:CHANnel<Channel>][:POWer]:VBWidth:ENUM`

`CALCulate<Measurement>[:CHANnel<Channel>]:NRT:VBWidth[:VALue]`

Suffix:

<Sensor> 1 to 128

Configured sensor connected at: port A = 1, ... , port D = 4, R&S NRX-B9 = 101, USB and LAN port = 5 to 100

Parameters:

<mode>

[SENSe<Sensor>:]BWIDth:VIDeo:LIST?

[SENSe<Sensor>:]BANDwidth:VIDeo:LIST?

Available for compatibility. Queries the parameters available for `[SENSe<Sensor>:]BANDwidth:VIDeo` and `[SENSe<Sensor>:]BWIDth:VIDeo`.

Suffix:

<Sensor> 1 to 128

Configured sensor connected at: port A = 1, ... , port D = 4, R&S NRX-B9 = 101, USB and LAN port = 5 to 100

Usage: Query only

[SENSe<Sensor>:]BURSt:MODE <mode>

Available for compatibility. Recommended R&S NRX command:

`CALCulate<Measurement>[:CHANnel<Channel>]:NRT:BURSt:MODE`

Suffix:

<Sensor> 1 to 128

Configured sensor connected at: port A = 1, ... , port D = 4, R&S NRX-B9 = 101, USB and LAN port = 5 to 100

Parameters:

<mode> AUTO | USER

*RST: AUTO

[SENSe<Sensor>:]BURSt:PERiod <value>

Available for compatibility. Recommended R&S NRX command:

`CALCulate<Measurement>[:CHANnel<Channel>]:NRT:BURSt:PERiod`

Suffix:

<Sensor> 1 to 128
Configured sensor connected at: port A = 1, ... , port D = 4, R&S NRX-B9 = 101, USB and LAN port = 5 to 100

Parameters:

<value> Range: 0.0 to 1.0
*RST: 0.1
Default unit: s

[SENSe<Sensor>:]BURSt:WIDTh <width>

Available for compatibility. Recommended R&S NRX command:

`CALCulate<Measurement>[:CHANnel<Channel>]:NRT:BURSt:WIDTh`

Suffix:

<Sensor> 1 to 128
Configured sensor connected at: port A = 1, ... , port D = 4, R&S NRX-B9 = 101, USB and LAN port = 5 to 100

Parameters:

<width> Range: 0.0 to 1.0
*RST: 0.01
Default unit: s

[SENSe<Sensor>:]CORRection:DCYClE:STATe <state>

Available for compatibility. Recommended R&S NRX command:

`CALCulate<Measurement>[:CHANnel<Channel>]:CORRection:DCYClE:STATe`

Suffix:

<Sensor> 1 to 128
Configured sensor connected at: port A = 1, ... , port D = 4, R&S NRX-B9 = 101, USB and LAN port = 5 to 100

Parameters:

<state> ON | OFF
*RST: OFF

[SENSe<Sensor>:]CORRection:DCYClE[:INPut][:MAGNitude] <duty_cycle>

Available for compatibility. Recommended R&S NRX command:

`CALCulate<Measurement>[:CHANnel<Channel>]:CORRection:DCYClE[:VALue]`

Suffix:

<Sensor>

1 to 128

Configured sensor connected at: port A = 1, ... , port D = 4, R&S NRX-B9 = 101, USB and LAN port = 5 to 100

Parameters:

<duty_cycle>

[SENSe<Sensor>:]CORRection:DCYClE[:VALue] <duty_cycle>

Available for compatibility. Recommended R&S NRX command:

CALCulate<Measurement>[:CHANnel<Channel>]:CORRection:DCYClE[:VALue]

Suffix:

<Sensor>

1 to 128

Configured sensor connected at: port A = 1, ... , port D = 4, R&S NRX-B9 = 101, USB and LAN port = 5 to 100

Parameters:

<duty_cycle>

Range: 0.001 to 100.00

*RST: 50.0

Default unit: pct

[SENSe<Sensor>:]CORRection:FDOFFset[:INPut][:MAGNitude]?

Available for compatibility. Recommended R&S NRX command:

CALCulate<Measurement>[:CHANnel<Channel>]:CORRection:OFFSet[:MAGNitude]

Suffix:

<Sensor>

1 to 128

Configured sensor connected at: port A = 1, ... , port D = 4, R&S NRX-B9 = 101, USB and LAN port = 5 to 100

Usage:

Query only

[SENSe<Sensor>:]CORRection:FDOTable:STATe <state>

Available for compatibility. Recommended R&S NRX command:

CALCulate<Measurement>[:CHANnel<Channel>]:CORRection:OFFSet:TABLE[:STATe]

Suffix:

<Sensor>

1 to 128

Configured sensor connected at: port A = 1, ... , port D = 4, R&S NRX-B9 = 101, USB and LAN port = 5 to 100

Parameters:

<state>

[SENSe<Sensor>:]CORRection:FDOTable[:SELEct] <table_name>

Available for compatibility. Recommended R&S NRX command:

```
CALCulate<Measurement>[:CHANnel<Channel>]:CORRection:OFFSet:
TABLE:INDeX
```

Suffix:

<Sensor> 1 to 128
Configured sensor connected at: port A = 1, ... , port D = 4, R&S
NRX-B9 = 101, USB and LAN port = 5 to 100

Parameters:

<table_name>

[SENSe<Sensor>:]CORRection:OFFSet:STATe <state>

Available for compatibility. Recommended R&S NRX command:

```
CALCulate<Measurement>[:CHANnel<Channel>]:CORRection:OFFSet:
STATe
```

Suffix:

<Sensor> 1 to 128
Configured sensor connected at: port A = 1, ... , port D = 4, R&S
NRX-B9 = 101, USB and LAN port = 5 to 100

Parameters:

<state> *RST: OFF

[SENSe<Sensor>:]CORRection:OFFSet[:VALue] <offset>

Available for compatibility. Recommended R&S NRX command:

```
CALCulate<Measurement>[:CHANnel<Channel>]:CORRection:OFFSet[:
MAGNitude]
```

Suffix:

<Sensor> 1 to 128
Configured sensor connected at: port A = 1, ... , port D = 4, R&S
NRX-B9 = 101, USB and LAN port = 5 to 100

Parameters:

<offset> Range: -200.00 to 200.00
*RST: 0.0
Default unit: dB

[SENSe<Sensor>:]DATA? [<function>]

Available for compatibility. Recommended R&S NRX command:

```
CALCulate<Measurement>:DATA?
```

Suffix:

<Sensor> 1 to 128
Configured sensor connected at: port A = 1, ... , port D = 4, R&S NRX-B9 = 101, USB and LAN port = 5 to 100

Query parameters:

<function>

Usage: Query only

[SENSe<Sensor>:]DM:WCDMa:CRATe <value>

Available for compatibility. Recommended R&S NRX command:

CALCulate<Measurement>[:CHANnel<Channel>]:NRT:DMODulation:WCDMa:CRATe

Suffix:

<Sensor> 1 to 128
Configured sensor connected at: port A = 1, ... , port D = 4, R&S NRX-B9 = 101, USB and LAN port = 5 to 100

Parameters:

<value> Range: 0.0 to 8.2e6
*RST: 1.0e6
Default unit: Hz

[SENSe<Sensor>:]FUNCTION[:ON] <function>

Available for compatibility. Recommended R&S NRX command:

CALCulate<Measurement>[:CHANnel<Channel>]:FEED<Channel>

Suffix:

<Sensor> 1 to 128
Configured sensor connected at: port A = 1, ... , port D = 4, R&S NRX-B9 = 101, USB and LAN port = 5 to 100

Parameters:

<function> *RST: POWER:AVG

[SENSe<Sensor>:]INFormation? [<argument>]

Available for compatibility. Recommended R&S NRX command:

SYSTem:SENSor<Sensor>:INFO?

Suffix:

<Sensor> 1 to 128
Configured sensor connected at: port A = 1, ... , port D = 4, R&S NRX-B9 = 101, USB and LAN port = 5 to 100

Query parameters:

<argument>

Usage: Query only

[SENSe<Sensor>:]INPut:ATTenuation:AUTO <auto>

Available for compatibility. Recommended R&S NRX command:

`CALCulate<Measurement>[:CHANnel<Channel>]:INPut:ATTenuation:AUTO`

Suffix:

<Sensor> 1 to 128
Configured sensor connected at: port A = 1, ... , port D = 4, R&S NRX-B9 = 101, USB and LAN port = 5 to 100

Parameters:

<auto> OFF | ON | ONCE
*RST: OFF

[SENSe<Sensor>:]INPut:ATTenuation[:VALue] <value>

Available for compatibility. Recommended R&S NRX command:

`CALCulate<Measurement>[:CHANnel<Channel>]:INPut:ATTenuation[:VALue]`

Suffix:

<Sensor> 1 to 128
Configured sensor connected at: port A = 1, ... , port D = 4, R&S NRX-B9 = 101, USB and LAN port = 5 to 100

Parameters:

<value> Range: 0.0 to 30.0
*RST: 30.0
Default unit: dB

[SENSe<Sensor>:]INternal:TRIGger:JITTer:METHod <method>

Available for compatibility. Recommended R&S NRX command:

`TRIGger<Measurement>[:CHANnel<Channel>]:JITTer:METHod`

Suffix:

<Sensor> 1 to 128
Configured sensor connected at: port A = 1, ... , port D = 4, R&S NRX-B9 = 101, USB and LAN port = 5 to 100

Parameters:

<method> COMPensate | MEASure | NONE
*RST: COMPensate

[SENSe<Sensor>:][POWER:][AVG:]APERture[:VALue] <integration_time>

Available for compatibility. Recommended R&S NRX command:

```
CALCulate<Measurement>[:CHANnel<Channel>][:POWer][:AVG]:
APERTure[:VALue]
```

Suffix:

<Sensor> 1 to 128
Configured sensor connected at: port A = 1, ... , port D = 4, R&S NRX-B9 = 101, USB and LAN port = 5 to 100

Parameters:

<integration_time> Range: 8.3e-9 to 30.0
*RST: 0.005
Default unit: s

[SENSe<Sensor>][:POWer][:AVG:]SMOothing:STATe <state>

Available for compatibility. Recommended R&S NRX command:

```
CALCulate<Measurement>[:CHANnel<Channel>][:POWer][:AVG]:
SMOothing[:STATe]
```

Suffix:

<Sensor> 1 to 128
Configured sensor connected at: port A = 1, ... , port D = 4, R&S NRX-B9 = 101, USB and LAN port = 5 to 100

Parameters:

<state> ON | OFF
*RST: OFF

[SENSe<Sensor>][:POWer:]BURSt:DTOLerance <tolerance>

Available for compatibility. Recommended R&S NRX command:

```
CALCulate<Measurement>[:CHANnel<Channel>][:POWer]:BURSt:
DTOLerance
```

Suffix:

<Sensor> 1 to 128
Configured sensor connected at: port A = 1, ... , port D = 4, R&S NRX-B9 = 101, USB and LAN port = 5 to 100

Parameters:

<tolerance> Range: 0.00 to 0.30
*RST: 1.000e-6
Default unit: s

[SENSe<Sensor>][:POWer:]NCORrection[:STATe] <state>

Available for compatibility. Recommended R&S NRX command:

```
CALCulate<Measurement>[:CHANnel<Channel>][:POWer]:NCORrection[:
STATe]
```

Suffix:

<Sensor> 1 to 128
Configured sensor connected at: port A = 1, ... , port D = 4, R&S NRX-B9 = 101, USB and LAN port = 5 to 100

Parameters:

<state> *RST: OFF

[SENSe<Sensor>:][POWER:]TGATe:SElect <gate>

Available for compatibility. Recommended R&S NRX command:

[CALCulate<Measurement>\[:POWER\]:TGATe<Undef>\[:AVG\]:SElection](#)

Suffix:

<Sensor> 1 to 128
Configured sensor connected at: port A = 1, ... , port D = 4, R&S NRX-B9 = 101, USB and LAN port = 5 to 100

Parameters:

<gate>

[SENSe<Sensor>:][POWER:]TGATe<Gate>:OFFSet:TIME <time>

Available for compatibility. Recommended R&S NRX command:

[CALCulate<Measurement>\[:POWER\]:TGATe<Gate>\[:AVG\]:OFFSet\[:TIME\]](#)

Suffix:

<Sensor> 1 to 128
Configured sensor connected at: port A = 1, ... , port D = 4, R&S NRX-B9 = 101, USB and LAN port = 5 to 100

<Gate> 1 to 4
Time gate

Parameters:

<time> Default unit: s

[SENSe<Sensor>:][POWER:]TGATe<Gate>:TIME <time>

Available for compatibility. Recommended R&S NRX command:

[CALCulate<Measurement>\[:POWER\]:TGATe<Gate>\[:AVG\]:TIME](#)

Suffix:

<Sensor> 1 to 128
Configured sensor connected at: port A = 1, ... , port D = 4, R&S NRX-B9 = 101, USB and LAN port = 5 to 100

<Gate> 1 to 4
Time gate

Parameters:

<time> Default unit: s

[SENSe<Sensor>:][POWER:]TGATe<Gate>[:EXCLude]:MID:OFFSet[:TIME]
 <time_interval>

Available for compatibility. Recommended R&S NRX command:

`CALCulate<Measurement>[:POWER]:TGATe<Gate>[:AVG][:EXCLude]:MID:OFFSet[:TIME]`

Suffix:

<Sensor> 1 to 128
 Configured sensor connected at: port A = 1, ... , port D = 4, R&S NRX-B9 = 101, USB and LAN port = 5 to 100

<Gate> 1 to 4
 Time gate

Parameters:

<time_interval> Default unit: s

[SENSe<Sensor>:][POWER:]TGATe<Gate>[:EXCLude]:MID:TIME <time_interval>

Available for compatibility. Recommended R&S NRX command:

`CALCulate<Measurement>[:POWER]:TGATe<Gate>[:AVG][:EXCLude]:MID:TIME`

Suffix:

<Sensor> 1 to 128
 Configured sensor connected at: port A = 1, ... , port D = 4, R&S NRX-B9 = 101, USB and LAN port = 5 to 100

<Gate> 1 to 4
 Time gate

Parameters:

<time_interval> Default unit: s

[SENSe<Sensor>:][POWER:]TGATe[:EXCLude]:MID[:STATe] <state>

Available for compatibility. Recommended R&S NRX command:

`CALCulate<Measurement>[:POWER]:TGATe<Gate>[:AVG][:EXCLude]:MID[:STATe]`

Suffix:

<Sensor> 1 to 128
 Configured sensor connected at: port A = 1, ... , port D = 4, R&S NRX-B9 = 101, USB and LAN port = 5 to 100

Parameters:

<state>

[SENSe<Sensor>:][POWER:]TSLot[:AVG]:COUNT <count>

Available for compatibility. Recommended R&S NRX command:

`CALCulate<Measurement>[:POWER]:TSLot[:AVG]:COUNT`

Suffix:

<Sensor> 1 to 128
Configured sensor connected at: port A = 1, ... , port D = 4, R&S NRX-B9 = 101, USB and LAN port = 5 to 100

Parameters:

<count> Range: 1 to 128
*RST: 8

[SENSe<Sensor>:][POWER:]TSLot[:AVG]:WIDTH <width>

Available for compatibility. Recommended R&S NRX command:

`CALCulate<Measurement>[:POWER]:TSLot[:AVG]:WIDTH`

Suffix:

<Sensor> 1 to 128
Configured sensor connected at: port A = 1, ... , port D = 4, R&S NRX-B9 = 101, USB and LAN port = 5 to 100

Parameters:

<width> Range: 50.0e-9 to 0.10
*RST: 1.000e-3
Default unit: s

[SENSe<Sensor>:][POWER:]TSLot[:AVG][:EXCLude]:MID:OFFSet[:TIME] <time>

Available for compatibility. Recommended R&S NRX command:

`CALCulate<Measurement>[:POWER]:TSLot[:AVG][:EXCLude]:MID:OFFSet[:TIME]`

Suffix:

<Sensor> 1 to 128
Configured sensor connected at: port A = 1, ... , port D = 4, R&S NRX-B9 = 101, USB and LAN port = 5 to 100

Parameters:

<time> Range: 0.00 to 0.10
*RST: 0.00
Default unit: s

[SENSe<Sensor>:][POWER:]TSLot[:AVG][:EXCLude]:MID:TIME <time>

Available for compatibility. Recommended R&S NRX command:

`CALCulate<Measurement>[:POWER]:TSLot[:AVG][:EXCLude]:MID:TIME`

Suffix:

<Sensor> 1 to 128
Configured sensor connected at: port A = 1, ... , port D = 4, R&S NRX-B9 = 101, USB and LAN port = 5 to 100

Parameters:

<time> Range: 0.00 to 0.10
*RST: 0.00
Default unit: s

[SENSe<Sensor>:] [POWER:] TSLot[:AVG] [:EXCLude]:MID[:STATe] <state>

Available for compatibility. Recommended R&S NRX command:

`CALCulate<Measurement>[:POWER]:TSLot[:AVG] [:EXCLude]:MID[:STATe]`

Suffix:

<Sensor> 1 to 128
Configured sensor connected at: port A = 1, ... , port D = 4, R&S NRX-B9 = 101, USB and LAN port = 5 to 100

Parameters:

<state> *RST: OFF

[SENSe<Sensor>:] POWER:CCDFunction:REFerence <ref>

Available for compatibility. Recommended R&S NRX command:

`CALCulate<Measurement>[:CHANnel<Channel>]:NRT:CCDF:THReshold`
on page 368

If you enter a value without unit, the unit is defined by `SENSe<Sensor>:UNIT:POWER[:VALue]`. For further information, see [Chapter 13.6.1.3, "Units"](#), on page 217.

Suffix:

<Sensor> 1 to 128
Configured sensor connected at: port A = 1, ... , port D = 4, R&S NRX-B9 = 101, USB and LAN port = 5 to 100

Parameters:

<ref> Range: -290.0 to +110.0
*RST: +0.0
Default unit: dBm

[SENSe<Sensor>:] POWER:PEP:HOLD <time>

Available for compatibility. Recommended R&S NRX command:

`CALCulate<Measurement>[:CHANnel<Channel>]:NRT:PEP:HOLD:TIME`

Suffix:

<Sensor> 1 to 128
Configured sensor connected at: port A = 1, ... , port D = 4, R&S NRX-B9 = 101, USB and LAN port = 5 to 100

Parameters:

<time> Range: 1.0e-3 to 1.0e-1
*RST: 6.0e-2
Default unit: s

[SENSe<Sensor>:]RANGE:AUTO <state>

Available for compatibility. Recommended R&S NRX command:

```
CALCulate<Measurement>[:CHANnel<Channel>][:POWer][:AVG]:RANGE:
AUTO
```

Suffix:

<Sensor> 1 to 128
Configured sensor connected at: port A = 1, ... , port D = 4, R&S NRX-B9 = 101, USB and LAN port = 5 to 100

Parameters:

<state> *RST: ON

[SENSe<Sensor>:]RANGE:CLeVel <level>

Available for compatibility. Recommended R&S NRX command:

```
CALCulate<Measurement>[:CHANnel<Channel>][:POWer][:AVG]:RANGE:
CLeVel[:VALue]
```

Suffix:

<Sensor> 1 to 128
Configured sensor connected at: port A = 1, ... , port D = 4, R&S NRX-B9 = 101, USB and LAN port = 5 to 100

Parameters:

<level> Range: -20.00 to 0.00
*RST: 0.00
Default unit: dB

[SENSe<Sensor>:]RANGE[:VALue] <range>

Available for compatibility. Recommended R&S NRX command:

```
CALCulate<Measurement>[:CHANnel<Channel>][:POWer][:AVG]:RANGE[:
VALue]
```

Suffix:

<Sensor> 1 to 128
Configured sensor connected at: port A = 1, ... , port D = 4, R&S NRX-B9 = 101, USB and LAN port = 5 to 100

Parameters:

<range> Range: 0 to 2
 *RST: 1

[SENSe<Sensor>:]ROSCillator:REFio:FREQuency <value>

Available for compatibility. Recommended R&S NRX command:

`CALCulate<Measurement>[:CHANnel<Channel>]:ROSCillator:REFio:FREQuency`

Suffix:

<Sensor> 1 to 128
 Configured sensor connected at: port A = 1, ... , port D = 4, R&S NRX-B9 = 101, USB and LAN port = 5 to 100

Parameters:

<value> Range: 1.0e+7 to 1.2e+8
 *RST: 1.0e+7
 Default unit: Hz

[SENSe<Sensor>:]ROSCillator:REFio:OUTPut[:STATe] <value>

Available for compatibility. Recommended R&S NRX command:

`CALCulate<Measurement>[:CHANnel<Channel>]:ROSCillator:REFio:OUTPut[:STATe]`

Suffix:

<Sensor> 1 to 128
 Configured sensor connected at: port A = 1, ... , port D = 4, R&S NRX-B9 = 101, USB and LAN port = 5 to 100

Parameters:

<value> *RST: OFF

[SENSe<Sensor>:]ROSCillator:SOURce <value>

Available for compatibility. Recommended R&S NRX command:

`CALCulate<Measurement>[:CHANnel<Channel>]:ROSCillator:SOURce`

Suffix:

<Sensor> 1 to 128
 Configured sensor connected at: port A = 1, ... , port D = 4, R&S NRX-B9 = 101, USB and LAN port = 5 to 100

Parameters:

<value> HOST | INTernal | REFio
 *RST: INTernal

[SENSe<Sensor>:]SAMPLing <sampling_rate>

Available for compatibility. Recommended R&S NRX command:

```
CALCulate<Measurement>[:CHANnel<Channel>]:SAMPLing
```

Suffix:

<Sensor> 1 to 128

Configured sensor connected at: port A = 1, ... , port D = 4, R&S NRX-B9 = 101, USB and LAN port = 5 to 100

Parameters:

<sampling_rate> FREQ1 | FREQ2

*RST: FREQ1

[SENSe<Sensor>:]SGAMma:CORRection:STATe <state>

Available for compatibility. Recommended R&S NRX command:

```
CALCulate<Measurement>[:CHANnel<Channel>]:SGAMma:CORRection:STATe
```

Suffix:

<Sensor> 1 to 128

Configured sensor connected at: port A = 1, ... , port D = 4, R&S NRX-B9 = 101, USB and LAN port = 5 to 100

Parameters:

<state> ON | OFF

*RST: OFF

[SENSe<Sensor>:]SGAMma:PHASe <phase>

Available for compatibility. Recommended R&S NRX command:

```
CALCulate<Measurement>[:CHANnel<Channel>]:SGAMma:PHASe
```

Suffix:

<Sensor> 1 to 128

Configured sensor connected at: port A = 1, ... , port D = 4, R&S NRX-B9 = 101, USB and LAN port = 5 to 100

Parameters:

<phase> Range: -360.0 to 360.0

*RST: 0.0

Default unit: degree

[SENSe<Sensor>:]SGAMma[:MAGNitude] <magnitude>

Available for compatibility. Recommended R&S NRX command:

```
CALCulate<Measurement>[:CHANnel<Channel>]:SGAMma[:MAGNitude]
```

Suffix:

<Sensor> 1 to 128
 Configured sensor connected at: port A = 1, ... , port D = 4, R&S NRX-B9 = 101, USB and LAN port = 5 to 100

Parameters:

<magnitude> Range: 0.0 to 1.0
 *RST: 0.0

[SENSe<Sensor>:]STATistics:SAMPles[:MINimum] <value>

Available for compatibility. Recommended R&S NRX command:

[CALCulate<Measurement>:STATistics:SAMPles\[:MINimum\]](#)

Suffix:

<Sensor> 1 to 128
 Configured sensor connected at: port A = 1, ... , port D = 4, R&S NRX-B9 = 101, USB and LAN port = 5 to 100

Parameters:

<value>

[SENSe<Sensor>:]STATistics:SCALE:X:POINTs <points>

Available for compatibility. Recommended R&S NRX command:

[CALCulate<Measurement>:STATistics\[:SCALE\]:X:POINTs](#)

Suffix:

<Sensor> 1 to 128
 Configured sensor connected at: port A = 1, ... , port D = 4, R&S NRX-B9 = 101, USB and LAN port = 5 to 100

Parameters:

<points> Range: 3 to 8191
 *RST: 200

[SENSe<Sensor>:]STATistics:SCALE:X:RANGe <range>

Available for compatibility. Recommended R&S NRX command:

[CALCulate<Measurement>:STATistics\[:SCALE\]:X:RANGe](#)

Suffix:

<Sensor> 1 to 128
 Configured sensor connected at: port A = 1, ... , port D = 4, R&S NRX-B9 = 101, USB and LAN port = 5 to 100

Parameters:

<range> Range: 0.01 to 100.0
 *RST: 50.0
 Default unit: dB

[SENSe<Sensor>:]STATistics:SCALE:X:RLEVel <rlv>

Available for compatibility. Recommended R&S NRX command:

`CALCulate<Measurement>:STATistics[:SCALE]:X:RLEVel:RELative`

`CALCulate<Measurement>:STATistics[:SCALE]:X:RLEVel[:ABSolute]`

Suffix:

<Sensor> 1 to 128
Configured sensor connected at: port A = 1, ... , port D = 4, R&S NRX-B9 = 101, USB and LAN port = 5 to 100

Parameters:

<rlv> Range: -280.0 to 220.0
*RST: -30.0
Default unit: dBm

[SENSe<Sensor>:]STATistics:TIME <time>

Available for compatibility. Recommended R&S NRX command:

`CALCulate<Measurement>[:POWER]:TGATe<Gate>[:AVG]:TIME` if a gate is set.

`CALCulate<Measurement>:STATistics:APERture` if no gate is set.

Suffix:

<Sensor> 1 to 128
Configured sensor connected at: port A = 1, ... , port D = 4, R&S NRX-B9 = 101, USB and LAN port = 5 to 100

Parameters:

<time> Range: 10.0e-6 to 0.3
*RST: 0.01
Default unit: s

[SENSe<Sensor>:]STATistics[:EXCLude]:MID:OFFSet[:TIME] <time>

Available for compatibility. Recommended R&S NRX command:

`CALCulate<Measurement>[:POWER]:TGATe<Gate>[:AVG][:EXCLude]:MID:OFFSet[:TIME]`

Suffix:

<Sensor> 1 to 128
Configured sensor connected at: port A = 1, ... , port D = 4, R&S NRX-B9 = 101, USB and LAN port = 5 to 100

Parameters:

<time> Range: 0.0 to 0.3
*RST: 0.0
Default unit: s

[SENSe<Sensor>:]STATistics[:EXCLude]:MID:TIME <time>

Available for compatibility. Recommended R&S NRX command:

```
CALCulate<Measurement>[:POWER]:TGATe<Gate>[:AVG][:EXCLude]:MID:TIME
```

Suffix:

<Sensor> 1 to 128
Configured sensor connected at: port A = 1, ... , port D = 4, R&S NRX-B9 = 101, USB and LAN port = 5 to 100

Parameters:

<time> Range: 0.0 to 0.3
*RST: 0.0
Default unit: s

[SENSe<Sensor>:]TIMing:EXCLude:STARt <exclude_start>

Available for compatibility. Recommended R&S NRX command:

```
CALCulate<Measurement>:TSLot:TIMing:EXCLude:STARt
```

Suffix:

<Sensor> 1 to 128
Configured sensor connected at: port A = 1, ... , port D = 4, R&S NRX-B9 = 101, USB and LAN port = 5 to 100

Parameters:

<exclude_start> Range: 0.0 to 15.0
*RST: 0.0
Default unit: s

[SENSe<Sensor>:]TIMing:EXCLude:STOP <exclude_stop>

Available for compatibility. Recommended R&S NRX command:

```
CALCulate<Measurement>:TSLot:TIMing:EXCLude:STOP
```

Suffix:

<Sensor> 1 to 128
Configured sensor connected at: port A = 1, ... , port D = 4, R&S NRX-B9 = 101, USB and LAN port = 5 to 100

Parameters:

<exclude_stop> Range: 0.0 to 15.0
*RST: 0.0
Default unit: s

[SENSe<Sensor>:]TRACe:AVERage:COUNT <filter length>

Available for compatibility. Recommended R&S NRX command:

CALCulate<Measurement>[:CHANnel<Channel>]:TRACe:AVERAge:COUNT[:VALue]

Suffix:

<Sensor> 1 to 128
Configured sensor connected at: port A = 1, ... , port D = 4, R&S NRX-B9 = 101, USB and LAN port = 5 to 100

Parameters:

<count> Range: 1 to 65536
*RST: 4

[SENSe<Sensor>:]TRACe:AVERAge:TCONtrol <mode>

Available for compatibility. Recommended R&S NRX command:

CALCulate<Measurement>[:CHANnel<Channel>]:TRACe:AVERAge:TCONtrol[:ENUM]

Suffix:

<Sensor> 1 to 128
Configured sensor connected at: port A = 1, ... , port D = 4, R&S NRX-B9 = 101, USB and LAN port = 5 to 100

Parameters:

<mode> MOVing | REPeat
*RST: REPeat

[SENSe<Sensor>:]TRACe:AVERAge[:STATe] <state>

Available for compatibility. Recommended R&S NRX command:

CALCulate<Measurement>[:CHANnel<Channel>]:TRACe:AVERAge[:STATe]

Suffix:

<Sensor> 1 to 128
Configured sensor connected at: port A = 1, ... , port D = 4, R&S NRX-B9 = 101, USB and LAN port = 5 to 100

Parameters:

<state> ON | OFF
*RST: ON

[SENSe<Sensor>:]TRACe:ESAMpling:AUTO <auto>

Available for compatibility. Recommended R&S NRX command:

CALCulate<Measurement>[:CHANnel<Channel>]:TRACe:ESAMpling

Suffix:

<Sensor> 1 to 128
Configured sensor connected at: port A = 1, ... , port D = 4, R&S NRX-B9 = 101, USB and LAN port = 5 to 100

Parameters:

<auto> *RST: ON

[SENSe<Sensor>:]TRACe:MEASurement:ALGorithm <value>

Available for compatibility. Recommended R&S NRX command:

[CALCulate<Measurement>:TRACe:MEASurement:ALGorithm](#)

Suffix:

<Sensor> 1 to 128
Configured sensor connected at: port A = 1, ... , port D = 4, R&S NRX-B9 = 101, USB and LAN port = 5 to 100

Parameters:

<value> HISTogram | INTegration | PEAK
*RST: HISTogram

[SENSe<Sensor>:]TRACe:MEASurement:DEFine:DURation:REFerence <value>

Available for compatibility. Recommended R&S NRX command:

[CALCulate<Measurement>:TRACe:MEASurement:DEFine:DURation:REFerence](#)

Suffix:

<Sensor> 1 to 128
Configured sensor connected at: port A = 1, ... , port D = 4, R&S NRX-B9 = 101, USB and LAN port = 5 to 100

Parameters:

<value> Range: Depends on sensor.
*RST: Depends on sensor.
Default unit: pct

[SENSe<Sensor>:]TRACe:MEASurement:DEFine:TRANSition:HREFerence <value>

Available for compatibility. Recommended R&S NRX command:

[CALCulate<Measurement>:TRACe:MEASurement:DEFine:TRANSition:HREFerence](#)

Suffix:

<Sensor> 1 to 128
Configured sensor connected at: port A = 1, ... , port D = 4, R&S NRX-B9 = 101, USB and LAN port = 5 to 100

Parameters:

<value> Range: Depends on the sensor.
*RST: Depends on the sensor.
Default unit: pct

[SENSe<Sensor>:]TRACe:MEASurement:DEFine:TRANSition:LREFerence
 <value>

Available for compatibility. Recommended R&S NRX command:

`CALCulate<Measurement>:TRACe:MEASurement:DEFine:TRANSition:LREFerence`

Suffix:

<Sensor>

1 to 128

Configured sensor connected at: port A = 1, ... , port D = 4, R&S NRX-B9 = 101, USB and LAN port = 5 to 100

Parameters:

<value>

float_value

Range: depending on the sensor

*RST: depending on the sensor

Default unit: PCT

[SENSe<Sensor>:]TRACe:MEASurement:POWer:AVG?

Available for compatibility. Recommended R&S NRX command:

`CALCulate<Measurement>:TRACe:MEASurement:POWer:AVG?`

If you enter a value without unit, the unit is defined by `SENSe<Sensor>:UNIT:POWer[:VALue]`. For further information, see [Chapter 13.6.1.3, "Units"](#), on page 217.

Suffix:

<Sensor>

1 to 128

Configured sensor connected at: port A = 1, ... , port D = 4, R&S NRX-B9 = 101, USB and LAN port = 5 to 100

Usage:

Query only

[SENSe<Sensor>:]TRACe:MEASurement:POWer:HREFerence?

Available for compatibility. Recommended R&S NRX command:

`CALCulate<Measurement>:TRACe:MEASurement:POWer:HREFerence?`

If you enter a value without unit, the unit is defined by `SENSe<Sensor>:UNIT:POWer[:VALue]`. For further information, see [Chapter 13.6.1.3, "Units"](#), on page 217.

Suffix:

<Sensor>

1 to 128

Configured sensor connected at: port A = 1, ... , port D = 4, R&S NRX-B9 = 101, USB and LAN port = 5 to 100

Usage:

Query only

[SENSe<Sensor>:]TRACe:MEASurement:POWer:LREFerence?

Available for compatibility. Recommended R&S NRX command:

`CALCulate<Measurement>:TRACe:MEASurement:POWer:LREFerence?`

If you enter a value without unit, the unit is defined by `SENSe<Sensor>:UNIT:POWer[:VALue]`. For further information, see [Chapter 13.6.1.3, "Units"](#), on page 217.

Suffix:

<Sensor> 1 to 128
Configured sensor connected at: port A = 1, ... , port D = 4, R&S NRX-B9 = 101, USB and LAN port = 5 to 100

Usage: Query only

[SENSe<Sensor>:]TRACe:MEASurement:POWer:MAX?

Available for compatibility. Recommended R&S NRX command:

`CALCulate<Measurement>:TRACe:MEASurement:POWer:MAX?`

If you enter a value without unit, the unit is defined by `SENSe<Sensor>:UNIT:POWer[:VALue]`. For further information, see [Chapter 13.6.1.3, "Units"](#), on page 217.

Suffix:

<Sensor> 1 to 128
Configured sensor connected at: port A = 1, ... , port D = 4, R&S NRX-B9 = 101, USB and LAN port = 5 to 100

Usage: Query only

[SENSe<Sensor>:]TRACe:MEASurement:POWer:MIN?

Available for compatibility. Recommended R&S NRX command:

`CALCulate<Measurement>:TRACe:MEASurement:POWer:MIN?`

If you enter a value without unit, the unit is defined by `SENSe<Sensor>:UNIT:POWer[:VALue]`. For further information, see [Chapter 13.6.1.3, "Units"](#), on page 217.

Suffix:

<Sensor> 1 to 128
Configured sensor connected at: port A = 1, ... , port D = 4, R&S NRX-B9 = 101, USB and LAN port = 5 to 100

Usage: Query only

[SENSe<Sensor>:]TRACe:MEASurement:POWer:PULSe:BASE?

Available for compatibility. Recommended R&S NRX command:

`CALCulate<Measurement>:TRACe:MEASurement:POWer:PULSe:BASE?`

If you enter a value without unit, the unit is defined by `SENSe<Sensor>:UNIT:POWER[:VALue]`. For further information, see [Chapter 13.6.1.3, "Units"](#), on page 217.

Suffix:

<Sensor> 1 to 128
Configured sensor connected at: port A = 1, ... , port D = 4, R&S NRX-B9 = 101, USB and LAN port = 5 to 100

Usage: Query only

[SENSe<Sensor>:]TRACe:MEASurement:POWer:PULSe:TOP?

Available for compatibility. Recommended R&S NRX command:

`CALCulate<Measurement>:TRACe:MEASurement:POWer:PULSe:TOP?`

If you enter a value without unit, the unit is defined by `SENSe<Sensor>:UNIT:POWER[:VALue]`. For further information, see [Chapter 13.6.1.3, "Units"](#), on page 217.

Suffix:

<Sensor> 1 to 128
Configured sensor connected at: port A = 1, ... , port D = 4, R&S NRX-B9 = 101, USB and LAN port = 5 to 100

Usage: Query only

[SENSe<Sensor>:]TRACe:MEASurement:POWer:REFerence?

Available for compatibility. Recommended R&S NRX command:

`CALCulate<Measurement>:TRACe:MEASurement:POWer:REFerence?`

If you enter a value without unit, the unit is defined by `SENSe<Sensor>:UNIT:POWER[:VALue]`. For further information, see [Chapter 13.6.1.3, "Units"](#), on page 217.

Suffix:

<Sensor> 1 to 128
Configured sensor connected at: port A = 1, ... , port D = 4, R&S NRX-B9 = 101, USB and LAN port = 5 to 100

Usage: Query only

[SENSe<Sensor>:]TRACe:MEASurement:PULSe:DCYClE?

Available for compatibility. Recommended R&S NRX command:

`CALCulate<Measurement>:TRACe:MEASurement:PULSe:DCYClE?`

Suffix:

<Sensor> 1 to 128
Configured sensor connected at: port A = 1, ... , port D = 4, R&S NRX-B9 = 101, USB and LAN port = 5 to 100

Usage: Query only

[SENSe<Sensor>:]TRACe:MEASurement:PULSe:DURation?

Available for compatibility. Recommended R&S NRX command:

[CALCulate<Measurement>:TRACe:MEASurement:PULSe:DURation?](#)

Suffix:

<Sensor> 1 to 128

Configured sensor connected at: port A = 1, ... , port D = 4, R&S NRX-B9 = 101, USB and LAN port = 5 to 100

Usage: Query only

[SENSe<Sensor>:]TRACe:MEASurement:PULSe:PERiod?

Available for compatibility. Recommended R&S NRX command:

[CALCulate<Measurement>:TRACe:MEASurement:PULSe:PERiod?](#)

Suffix:

<Sensor> 1 to 128

Configured sensor connected at: port A = 1, ... , port D = 4, R&S NRX-B9 = 101, USB and LAN port = 5 to 100

Usage: Query only

[SENSe<Sensor>:]TRACe:MEASurement:PULSe:SEParation?

Available for compatibility. Recommended R&S NRX command:

[CALCulate<Measurement>:TRACe:MEASurement:PULSe:SEParation?](#)

Suffix:

<Sensor> 1 to 128

Configured sensor connected at: port A = 1, ... , port D = 4, R&S NRX-B9 = 101, USB and LAN port = 5 to 100

Usage: Query only

**[SENSe<Sensor>:]TRACe:MEASurement:TRANSition:ESAMpling:AUTO[:STATe]
<value>**

Available for compatibility. Recommended R&S NRX command:

[CALCulate<Measurement>:TRACe:MEASurement:TRANSition:ESAMpling:
AUTO\[:STATe\]](#) on page 335

Suffix:

<Sensor> 1 to 128

Configured sensor connected at: port A = 1, ... , port D = 4, R&S NRX-B9 = 101, USB and LAN port = 5 to 100

Parameters:

<value> *RST: ON

[SENSe<Sensor>:]TRACe:MEASurement:TRANSition:NEGative:DURation?

Available for compatibility. Recommended R&S NRX command:

`CALCulate<Measurement>:TRACe:MEASurement:TRANSition:NEGative:DURation?`

Suffix:

<Sensor> 1 to 128
Configured sensor connected at: port A = 1, ... , port D = 4, R&S NRX-B9 = 101, USB and LAN port = 5 to 100

Usage: Query only

[SENSe<Sensor>:]TRACe:MEASurement:TRANSition:NEGative:OCCurrence?

Available for compatibility. Recommended R&S NRX command:

`CALCulate<Measurement>:TRACe:MEASurement:TRANSition:NEGative:OCCurrence?`

Suffix:

<Sensor> 1 to 128
Configured sensor connected at: port A = 1, ... , port D = 4, R&S NRX-B9 = 101, USB and LAN port = 5 to 100

Usage: Query only

[SENSe<Sensor>:]TRACe:MEASurement:TRANSition:NEGative:OVERshoot?

Available for compatibility. Recommended R&S NRX command:

`CALCulate<Measurement>:TRACe:MEASurement:TRANSition:NEGative:OVERshoot?`

Suffix:

<Sensor> 1 to 128
Configured sensor connected at: port A = 1, ... , port D = 4, R&S NRX-B9 = 101, USB and LAN port = 5 to 100

Usage: Query only

[SENSe<Sensor>:]TRACe:MEASurement:TRANSition:POSitive:DURation?

Available for compatibility. Recommended R&S NRX command:

`CALCulate<Measurement>:TRACe:MEASurement:TRANSition:POSitive:DURation?`

Suffix:

<Sensor> 1 to 128
Configured sensor connected at: port A = 1, ... , port D = 4, R&S NRX-B9 = 101, USB and LAN port = 5 to 100

Usage: Query only

[SENSe<Sensor>:]TRACe:MEASurement:TRANSition:POSitive:OCCurrence?

Available for compatibility. Recommended R&S NRX command:

`CALCulate<Measurement>:TRACe:MEASurement:TRANSition:POSitive:OCCurrence?`

Suffix:

<Sensor> 1 to 128
Configured sensor connected at: port A = 1, ... , port D = 4, R&S NRX-B9 = 101, USB and LAN port = 5 to 100

Usage: Query only

[SENSe<Sensor>:]TRACe:MEASurement:TRANSition:POSitive:OVERshoot?

Available for compatibility. Recommended R&S NRX command:

`CALCulate<Measurement>:TRACe:MEASurement:TRANSition:POSitive:OVERshoot?`

Suffix:

<Sensor> 1 to 128
Configured sensor connected at: port A = 1, ... , port D = 4, R&S NRX-B9 = 101, USB and LAN port = 5 to 100

Usage: Query only

[SENSe<Sensor>:]TRACe:MEASurement:TRANSition:SPERiod?

Available for compatibility. Recommended R&S NRX command:

`CALCulate<Measurement>:TRACe:MEASurement:TRANSition:SPERiod?`

Suffix:

<Sensor> 1 to 128
Configured sensor connected at: port A = 1, ... , port D = 4, R&S NRX-B9 = 101, USB and LAN port = 5 to 100

Usage: Query only

[SENSe<Sensor>:]TRACe:POINTs <points>

Available for compatibility. Recommended R&S NRX command:

`CALCulate<Measurement>:TRACe:X:POINTs`

Suffix:

<Sensor> 1 to 128
Configured sensor connected at: port A = 1, ... , port D = 4, R&S NRX-B9 = 101, USB and LAN port = 5 to 100

Parameters:

<points>

Range: 1 to 8192

*RST: 260

14 Remote control basics

- [Remote control interfaces and protocols](#).....464
- [SCPI command structure](#).....468
- [Command sequence and synchronization](#).....475
- [Status reporting system](#).....475

14.1 Remote control interfaces and protocols

For remote control, communication between the R&S NRX and the controlling host is established based on the following interfaces and protocols.

Table 14-1: Supported interfaces and protocols

Interface	Protocol	VISA ^{*)} address string	Library	Further information
USB	USBTMC	USB:: <vendor id="">::<product ID>::<serial number="">::[INSTR]</serial></vendor>	VISA	Chapter 14.1.1, "USB interface" , on page 464
Ethernet	VXI-11	TCPIP::host address>::LAN device name>::[INSTR]	VISA	Chapter 14.1.2.2, "VXI-11 protocol" , on page 467
	HiSLIP High-speed LAN instrument protocol (IVI-6.1)	TCPIP::host address>::hislip0>::[INSTR]	VISA	Chapter 14.1.2.3, "HiSLIP protocol" , on page 467
	Socket communication (SCPI raw)	TCPIP::host address>::LAN device name>::<port>::SOCKET		Chapter 14.1.2.4, "Socket communication" , on page 468
GPIB/ IEEE488 interface (R&S NRX-B8)	GPIB/IEEE 488	GPIB:: <primary address="">::INSTR</primary>		Chapter 14.1.3, "GPIB interface" , on page 468
<p>*) VISA is a standardized software interface library providing input and output functions to communicate with instruments. A VISA installation on the controller is a prerequisite for remote control over LAN (when using VXI-11 or HiSLIP protocol) and USBTMC interfaces. See also Chapter 14.1.2.1, "VISA resource strings", on page 466.</p>				

14.1.1 USB interface

Computer requirements

- VISA library
A USB connection requires the VISA library to be installed. VISA detects and configures the R&S NRX automatically when the USB connection is established.
- USBTMC driver

Apart from the USBTMC driver, which comes with the installation of the R&S NRP Toolkit, you do not have to install a separate driver.

Setup

- ▶ Connect the host interface of the R&S NRX and the USB interface of the computer.

USBTMC protocol

USBTMC is a protocol that is built on top of USB for communication with USB devices from the test & measurement category. It defines a dedicated class code that identifies a device's functionality. R&S NRX also uses this class code to identify itself as a member of the test & measurement class. Using a VISA library, such devices support service request, trigger and other operations that are commonly found in GPIB devices.

USB resource string

The VISA resource string for USBTMC device communication represents an addressing scheme that is used to establish a communication session with the sensor. It is based on the sensor address and some instrument- and vendor-specific information. The syntax of the used USB resource string is:

USB::*<vendor ID>*::*<product ID>*::*<serial number>*[::INSTR]

- *<vendor ID>* is the vendor ID for Rohde & Schwarz.
- *<product ID>* is the product ID for the R&S NRX.
- *<serial number>* is the individual serial number of the R&S NRX, printed on the casing.

Example:

USB::0x0AAD::0x015B::100001

0x0AAD is the vendor ID for Rohde & Schwarz.

0x015B is the product ID for the R&S NRX.

100001 is the serial number of the particular R&S NRX.

14.1.2 Ethernet interface

The Ethernet interface of the R&S NRX allows you to integrate it in a local area network (LAN).

Requirements

- TCP/IP network protocol
The local area network must support the TCP/IP network protocol.
The TCP/IP network protocol and the associated network services are preconfigured on the R&S NRX.
- VISA library
Installed on the computer.
- Software for device control
Installed on the computer.

Setup

- ▶ Using the Ethernet interface, connect the computer and the R&S NRX to a local area network.

14.1.2.1 VISA resource strings

The VISA resource string for network device communication is required to establish a communication session between the controller and the power sensor in a LAN. The resource string is a unique identifier, composed of the specific IP address of the sensor and some network and VISA-specific keywords.

TCPIP::*<IP address or hostname>*[:*<LAN device name>*][:INSTR]

- *TCPIP* designates the network protocol used
- *<IP address or hostname>* is the IP address or hostname of the device
- [*<LAN device name>*] defines the protocol and the instance number of a sub-instrument:
- [*INSTR*] indicates the power sensors resource class (optional)

The IP address or hostname is used by the programs to identify and control the sensor. While the hostname is determined by settings in the sensor, the IP address is assigned by a DHCP server when the sensor requests one. Alternatively the IP address is determined with a procedure called Zeroconf.

You can also assign a *LAN device name* which defines the protocol characteristics of the connection. See the description of the VISA resource string below for the corresponding interface protocols. The string of the *LAN device name* is emphasized in italics.

VXI-11

TCPIP::*<IP address or hostname>*[:*inst0*][:INSTR]

- *inst0* is the LAN device name, indicating that the VXI-11 protocol is used (optional)

inst0 currently selects the VXI-11 protocol by default and can be omitted.

For further details, see [Chapter 14.1.2.2, "VXI-11 protocol"](#), on page 467.

HiSLIP

TCPIP::*<IP address or hostname>*::*hislip0*[:INSTR]

- *hislip0* is the HiSLIP device name, designates that the interface protocol HiSLIP is used (mandatory)

hislip0 is composed of [*HiSLIP device name*[,HiSLIP port]] and must be assigned.

For further details, see [Chapter 14.1.2.3, "HiSLIP protocol"](#), on page 467.

Socket communication

TCPIP::*<IP address or hostname>*::*port*::SOCKET

- *port* determines the used port number

- *SOCKET* indicates the raw network socket resource class

Socket communication requires the specification of the port (commonly referred to as port number) and of "SOCKET" to complete the VISA resource string with the associated protocol used.

The default port for socket communication is port 5025.

For further details, see [Chapter 14.1.2.4, "Socket communication"](#), on page 468.

Example:

A power sensor has the IP address *10.111.11.20*; the valid resource string using VXI-11 protocol is:

```
TCPIP::10.111.11.20::INSTR
```

The DNS hostname is *nrx-100001*; the valid resource string is:

```
TCPIP::nrx-100001::hislip0 (HiSLIP)
```

```
TCPIP::nrx-100001::inst0 (VXI-11)
```

A raw socket connection can be established using:

```
TCPIP::10.111.11.20::5025::SOCKET
```

```
TCPIP::nrx-100001::5025::SOCKET
```

14.1.2.2 VXI-11 protocol

The VXI-11 standard is based on the ONC RPC (Open Network Computing Remote Procedure Call) protocol which in turn relies on TCP/IP as the network/transport layer. The TCP/IP network protocol and the associated network services are preconfigured. TCP/IP ensures connection-oriented communication, where the order of the exchanged messages is adhered to and interrupted links are identified. With this protocol, messages cannot be lost.

14.1.2.3 HiSLIP protocol

The HiSLIP (high-speed LAN instrument protocol) is the successor protocol for VXI-11 for TCP-based instruments specified by the IVI foundation. The protocol uses two TCP sockets for a single connection - the first for fast data transfer, the second one for non-sequential control commands (e.g. *Device Clear* or *SRQ*).

HiSLIP has the following characteristics:

- High performance as with raw socket network connections
- Compatible IEEE 488.2 support for Message Exchange Protocol, Device Clear, Serial Poll, Remote/Local, Trigger, and Service Request.
- Uses a single IANA registered port (4880), which simplifies the configuration of firewalls.
- Supports simultaneous access of multiple users by providing versatile locking mechanisms.
- Usable for IPv6 or IPv4 networks.



The HiSLIP data is sent to the device using the "fire and forget" method with immediate return. Opposed to VXI-11, where each operation is blocked until a VXI-11 device handshake returns. Thus, a successful return of a VISA operation such as `viWrite()` does not guarantee that the sensor has finished (or even started) executing the requested command. It just indicates that the command has been delivered to the TCP/IP buffers.

For more information see also the application note at:

<http://www.rohde-schwarz.com/appnote/1MA208>.

14.1.2.4 Socket communication

An alternative way for remote control of the software is to establish a simple TCP/IP connection to the device using the standard network drivers of your operating system. The so-called "socket" on Linux, "winsock" on Windows. The socket communication, also referred to as "raw Ethernet communication", does not necessarily require a VISA installation on the remote controller side.

Socket connections are established on a specially defined port. The socket address is a combination of the IP address or hostname of the sensor and the number of the port configured for remote control. The power sensors use port number 5025 for this purpose.

14.1.3 GPIB interface

Connect the R&S NRX and the controller using a GPIB bus cable. Address the R&S NRX by its GPIB address.

Controller prerequisites

- GPIB bus card
- Card drivers
- Program libraries for the programming language

14.2 SCPI command structure

SCPI commands - messages - are used for remote control. Commands that are not taken from the SCPI standard follow the SCPI syntax rules. The power sensor supports the SCPI version 1999. The SCPI standard is based on standard IEEE 488.2 and aims at the standardization of device-specific commands, error handling and the status registers.

SCPI commands consist of a so-called header and, usually, one or more parameters. The header and the parameters are separated by a "white space" (ASCII code 0 to 9, 11 to 32 decimal, e.g. blank). The headers can consist of several mnemonics (keywords). Queries are formed by appending a question mark directly to the header.

The commands can be either device-specific or device-independent (common commands). Common and device-specific commands differ in their syntax.

14.2.1 Syntax for common commands

Common (=device-independent) commands consist of a header preceded by an asterisk (*) and possibly one or more parameters.

Examples:

*RST	RESET	Resets the instrument.
*ESE	EVENT STATUS ENABLE	Sets the bits of the event status enable registers.
*ESR?	EVENT STATUS QUERY	Queries the contents of the event status register.
*IDN?	IDENTIFICATION QUERY	Queries the instrument identification string.

14.2.2 Syntax for device-specific commands

Long and short form

The mnemonics feature a long form and a short form. The short form is marked by upper case letters here, to distinguish it from the long form, which constitutes the complete word. Either the short form or the long form can be entered; other abbreviations are not permitted.

Example:

`INITiate:CONTinuous` is equivalent to `INIT:CONT` or `init:cont`.



Case-insensitivity

Upper case and lower case notation only serves to distinguish the two forms in the manual, the instrument itself is case-insensitive.

Numeric suffixes

If a command can be applied to multiple instances of an object, e.g. specific channels or sources, the required instances can be specified by a suffix added to the command. Numeric suffixes are indicated by angular brackets (<1...4>, <n>, <i>) and are replaced by a single value in the command. Entries without a suffix are interpreted as having the suffix 1.



Different numbering in remote control

For remote control, the suffix can differ from the number of the corresponding selection used in manual operation. SCPI prescribes that suffix counting starts with 1. Suffix 1 is the default state and used when no specific suffix is specified.

Some standards define a fixed numbering, starting with 0. If the numbering differs in manual operation and remote control, it is indicated for the corresponding command.

Optional mnemonics

Some command systems permit certain mnemonics to be inserted into the header or omitted. These mnemonics are marked by square brackets in the description. The instrument must recognize the long command to comply with the SCPI standard. Some commands are considerably shortened by these optional mnemonics.

Example:

Definition: `INITiate[:IMMEDIATE]`

Command: `INIT:IMM` is equivalent to `INIT`

Parameters

Parameters must be separated from the header by a "white space". If several parameters are specified in a command, they are separated by a comma.

For a description of the parameter types, refer to [Chapter 14.2.3, "SCPI parameters"](#), on page 470.

Special characters

	Parameters A vertical stroke in parameter definitions indicates alternative possibilities in the sense of "or". The effect of the command differs, depending on which parameter is used.
[]	Mnemonics in square brackets are optional and can be inserted into the header or omitted. Example: <code>INITiate[:IMMEDIATE]</code> <code>INIT:IMM</code> is equivalent to <code>INIT</code>
{ }	Parameters in curly brackets are optional and can be inserted once or several times, or omitted.

14.2.3 SCPI parameters

Many commands are supplemented by a parameter or a list of parameters. The parameters must be separated from the header by a "white space" (ASCII code 0 to 9, 11 to 32 decimal, e.g. blank). Allowed parameters are:

- Numeric values
- Special numeric values
- Boolean parameters
- Text

- Character strings
- Block data

The parameters required for each command and the allowed range of values are specified in the command description.

Numeric values

Numeric values can be entered in any form, i.e. with sign, decimal point and exponent. Values exceeding the resolution of the instrument are rounded up or down. The mantissa can comprise up to 255 characters, the exponent must lie inside the value range -32000 to 32000. The exponent is introduced by an "E" or "e". Entry of the exponent alone is not allowed.

Units

For physical quantities, you can enter the unit. Units and prefixes, as defined by the international system of units (SI), are allowed and recognized. If you omit the unit, the default or set unit is used. See also [Chapter 13.6.1.3, "Units"](#), on page 217.

If you need decimal multiples and submultiples of a unit, you can use SCPI prefixes, see [Table 14-2](#). Because SCPI uses only capital letters, it cannot distinguish between upper and lower case characters. Therefore, if SI prefixes use the same letter in upper and lower case, SCPI defines the meaning. An example is milli (m) and mega (M). In SCPI, M means milli for all units except Hz and Ohm - MHz means mega Hz, 10^6 Hz.

Table 14-2: SCPI prefixes

Factor	SI name	SI symbol	SCPI prefix
10^3	kilo	k	K
10^6	mega	M	MA; also allowed are MOHM and MHZ
10^9	giga	G	G
10^{12}	tera	T	T
10^{-3}	milli	m	M Exception: Hz and Ohm
10^{-6}	micro	μ	U
10^{-9}	nano	n	N
10^{-12}	pico	p	P

Special numeric values

The texts listed below are interpreted as special numeric values. For a query, the numeric value is provided.

- **MIN/MAX**
MINimum and MAXimum denote the minimum and maximum value.
- **DEF**

DEFault denotes a preset value which has been stored in the non-variable memory. This value conforms to the default setting, as it is called by the *RST command.

- **UP/DOWN**

UP, DOWN increases or reduces the numeric value by one step. The step width can be specified via an allocated step command for each parameter which can be set via UP, DOWN.

- **INF/NINF**

INFINITY, Negative INFINITY (NINF) represent the numeric values 9.9E37 or -9.9E37, respectively. INF and NINF are only sent as instrument responses.

- **NAN**

Not a number (NAN) represents the value 9.91E37. NAN is only sent as an instrument response. This value is not defined. Possible causes are the division by zero, the subtraction of infinite from infinite and the representation of missing values.

Boolean parameters

Boolean parameters represent two states. The "ON" state (logically true) is represented by "ON" or a numeric value 1. The "OFF" state (logically untrue) is represented by "OFF" or the numeric value 0. The numeric values are provided as the response for a query.

Example:

Setting command: `SENSe:AVERAge:COUNT:AUTO ON`

Query: `SENSe:AVERAge:COUNT:AUTO?`

Response: 1

Text parameters

Text parameters observe the syntactic rules for mnemonics, i.e. they can be entered using a short or long form. Like any parameter, they have to be separated from the header by a white space. For a query, the short form of the text is provided.

Example:

Setting command: `TRIGger:SLOPe POSitive`

Query: `TRIG:SLOP?`

Response: POS

Character strings

Enter strings always in quotation marks (' or ").

Example:

Setting command: `SENSe:FUNCtion "POWeR:AVG"`

Query: `SENS:FUNC?`

Response: `"POWeR:AVG"`

Block data

Block data is a format which is suitable for the transmission of large amounts of data. A command using a block data parameter has the following structure:

Example:

```
SYSTem:HELP:SYNTax:ALL?
```

```
Response: #45168xxxxxxxx
```

The ASCII character # introduces the data block. The next number indicates how many of the following digits describe the length of the data block. In the example, the 4 following digits indicate the length to be 5168 bytes. The data bytes follow. During the transmission of these data bytes all end or other control signs are ignored until all bytes are transmitted.

#0 specifies a data block of indefinite length. The use of the indefinite format requires a NL^END message to terminate the data block. This format is useful when the length of the transmission is not known or if speed or other considerations prevent segmentation of the data into blocks of definite length.

14.2.4 Overview of syntax elements

The following table provides an overview of the syntax elements:

:	The colon separates the mnemonics of a command. In a command line, the separating semicolon marks the uppermost command level.
;	The semicolon separates two commands of a command line. It does not alter the path.
,	The comma separates several parameters of a command.
?	The question mark forms a query.
*	The asterisk marks a common command.
' "	Quotation marks introduce a string and terminate it (both single and double quotation marks are possible).
#	The hash symbol introduces binary, octal, hexadecimal and block data. <ul style="list-style-type: none"> • Binary: #B10110 • Octal: #O7612 • Hex: #HF3A7 • Block: #21312
	A "white space" (ASCII-Code 0 to 9, 11 to 32 decimal, e.g. blank) separates the header from the parameters.

14.2.5 Structure of a command line

A command line can consist of one or several commands. It is terminated by one of the following:

- a <New Line>
- a <New Line> with EOI

- an EOI together with the last data byte

Several commands in a command line must be separated by a semicolon ";". If the next command belongs to a different command system, the semicolon is followed by a colon.

If the successive commands belong to the same system, having one or several levels in common, the command line can be abbreviated. To this end, the second command after the semicolon starts with the level that lies below the common levels. The colon following the semicolon must be omitted in this case.

Example:

```
TRIG:LEV 0.1mW;TRIG:DEL 3E-3
```

This command line contains two commands. Both commands are part of the TRIG command system, i.e. they have one level in common.

When abbreviating the command line, the second command begins with the level below TRIG. The colon after the semicolon is omitted. The abbreviated form of the command line reads as follows:

```
TRIG:LEV 0.1E-3;DEL 3E-3
```

A new command line always begins with the complete path.

Example:

```
TRIG:LEV 0.1E-3
```

```
TRIG:DEL 3E-3
```

14.2.6 Responses to queries

A query is defined for each setting command unless explicitly specified otherwise. It is formed by adding a question mark to the associated setting command. According to SCPI, the responses to queries are partly subject to stricter rules than in standard IEEE 488.2.

- The requested parameter is transmitted without a header.
Example: TRIG:SOUR?, response: INT
- Maximum values, minimum values and all other quantities that are requested via a special text parameter are returned as numeric values.
- Numeric values are output without a unit. Physical quantities are referred to the basic units or to the units set using the Unit command. The response 3.5E9 for example stands for 3.5 GHz.
- Truth values (Boolean values) are returned as 0 (for OFF) and 1 (for ON).

Example:

Setting command: SENS:AVER:COUN:AUTO ON

Query: SENS:AVER:COUN:AUTO?

Response: 1

- Text (character data) is returned in a short form.

Example:

Setting command: TRIGger:SOURce INTernal
 Query: TRIG:SOUR?
 Response: INT

14.3 Command sequence and synchronization

A sequential command finishes the execution before the next command is starting. To make sure that commands are carried out in a certain order, each command must be sent in a separate command line.



As a rule, send commands and queries in different program messages.

14.3.1 Preventing overlapping execution

To prevent an overlapping execution of commands, you can use one of the commands *OPC, *OPC? or *WAI. All three commands cause a certain action only to be carried out after the hardware has been set. The controller can be forced to wait for the corresponding action to occur.

Table 14-3: Synchronization using *OPC, *OPC?, *WAI

Com- mand	Action	Programming the controller
*OPC	Sets the Operation Complete bit in the ESR after all previous commands have been executed.	<ul style="list-style-type: none"> Setting bit 0 in the ESE Setting bit 5 in the SRE Waiting for service request (SRQ)
*OPC?	Stops command processing until 1 is returned. Occurs when all pending operations are completed.	Send *OPC? directly after the command whose processing must be terminated before other commands can be executed.
*WAI	Stops further command processing until all commands sent before *WAI have been executed.	Send *WAI directly after the command whose processing must be terminated before other commands are executed.

Command synchronization using *WAI or *OPC? is a good choice if the overlapped command takes only little time to process. The two synchronization commands simply block overlapped execution of the command. Append the synchronization command to the overlapping command.

Measurements, for example, run concurrent. The order, in which the power sensors trigger, has not to correspond to the order of the remote commands.

14.4 Status reporting system

The status reporting system stores all information on the current operating state of the instrument, and on errors which have occurred. This information is stored in the status

registers and in the error queue. You can query both with the commands of the `STATUS` subsystem.

14.4.1 Hierarchy of the status registers

Figure 14-1 shows the hierarchical structure of information in the status registers.

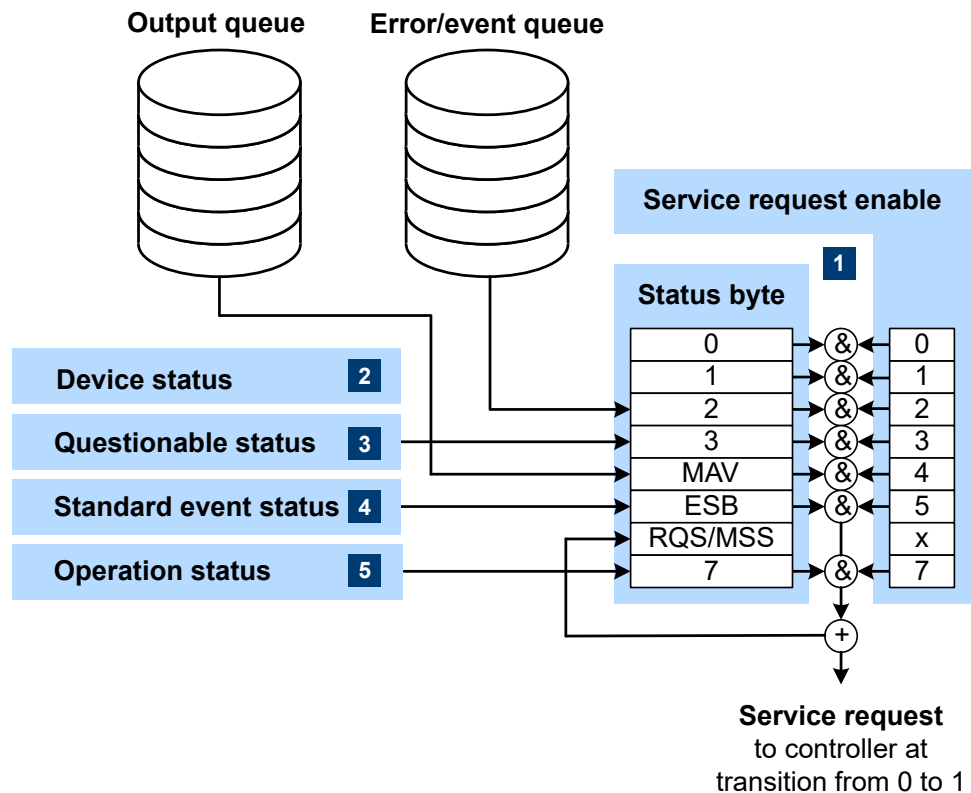

Figure 14-1: Status registers overview

1 = Chapter 14.4.3, "Status byte (STB) and service request enable register (SRE)", on page 479

2 = Chapter 14.4.5, "Device status register", on page 480

3 = Chapter 14.4.6, "Questionable status register", on page 482

4 = Chapter 14.4.7, "Standard event status and enable register (ESR, ESE)", on page 486

5 = Chapter 14.4.8, "Operation status register", on page 487

The highest level is formed by the status byte register (STB) and the associated service request enable (SRE) register.

The status byte register (STB) receives its information from:

- Standard event status register (ESR)
- Associated standard event status enable register (ESE)
- SCPI-defined operation status register
- Questionable status register, which contains detailed information on the device.

The R&S NRX works with several status register levels to support a high number of measurements. 8 measurements are grouped on one status register. The first status register groups the measurements 1 to 8. The next lower status register groups the measurements 9 to 16, and so on. Thus, the suffixes (m+1), (m+2), ... read as follows:

Status register	SCPI suffix	Value of suffix m	Measurement covered (m+1) to (m+8)
First hierarchy	1	0	1 to 8
Second hierarchy	2	8	9 to 16
Third hierarchy	3	16	17 to 24
...
8th hierarchy	8	56	57 to 64

The SCPI suffix of the status register is always (m+1). The suffix of the CALC command corresponds to the measurement channel, (m+x). Bit 0 summarizes the status of the next lower status register.

14.4.2 Structure of a SCPI status register

Each SCPI register consists of five 16-bit registers that have different functions, see Figure 14-2. The individual bits are independent of each other, i.e. each hardware status is assigned a bit number which is the same for all five registers. Bit 15, the most-significant bit, is set to 0 in all registers, thus preventing problems some controllers have with the processing of unsigned integers.

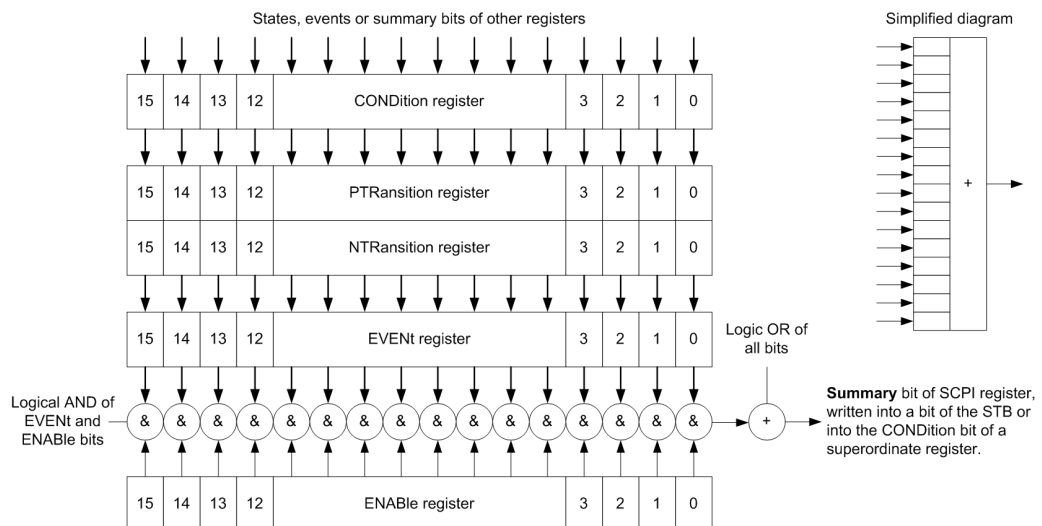

Figure 14-2: Standard SCPI status register

CONDition status register part

The five parts of a SCPI register have different properties and functions:

The `CONDition` part is written into directly by the hardware or the sum bit of the next lower register. Its contents reflect the current instrument status. This register part can only be read, but not written into or cleared. Its contents are not affected by reading.

PTRansition / NTRansition status register part

The two transition register parts define which state transition of the `CONDition` part (none, 0 to 1, 1 to 0 or both) is stored in the `EVENT` part.

The *Positive TRansition* part acts as a transition filter. When a bit of the `CONDition` part is changed from 0 to 1, the associated `PTR` bit decides whether the `EVENT` bit is set to 1.

- `PTR` bit = 1: The `EVENT` bit is set.
- `PTR` bit = 0: The `EVENT` bit is not set.

This part can be written into and read as required. Its contents are not affected by reading.

The *Negative TRansition* part also acts as a transition filter. When a bit of the `CONDition` part is changed from 1 to 0, the associated `NTR` bit decides whether the `EVENT` bit is set to 1.

- `NTR` bit = 1: The `EVENT` bit is set.
- `NTR` bit = 0: The `EVENT` bit is not set.

This part can be written into and read as required. Its contents are not affected by reading.

EVENT status register part

The `EVENT` part indicates whether an event has occurred since the last reading, it is the "memory" of the condition part. It only indicates events passed on by the transition filters. It is permanently updated by the instrument.

You can only read this part. Reading the register clears it. This part is often equated with the entire register.

ENABLE status register part

The `ENABLE` part determines whether the associated `EVENT` bit contributes to the sum bit (see below). Each bit of the `EVENT` part is "ANDed" with the associated `ENABLE` bit (symbol '&'). The results of all logical operations of this part are passed on to the sum bit via an "OR" function (symbol '+').

`ENABLE` bit = 0: The associated `EVENT` bit does not contribute to the sum bit.

`ENABLE` bit = 1: If the associated `EVENT` bit is 1, the sum bit is set to 1 as well.

You can read and write as required. Its contents are not affected by reading.

Sum bit

The sum bit is obtained from the `EVENT` and `ENABLE` part for each register. The result is then entered into a bit of the `CONDition` part of the higher-order register.

The instrument automatically generates the sum bit for each register. Thus an event can lead to a service request throughout all levels of the hierarchy.

14.4.3 Status byte (STB) and service request enable register (SRE)

The status byte register is already defined in IEEE 488.2. It gives a rough overview of the instrument status, collecting information from the lower-level registers. It is comparable with the `CONDition` register of a SCPI defined register and is at the highest level of the SCPI hierarchy. Its special feature is that bit 6 acts as the summary bit of all other bits of the status byte register.

The status byte register is read by `*STB?` or a serial poll. The service request enable register is associated with the status byte register. The function of the service request enable register corresponds to that of the `ENABLE` register of the SCPI registers. Each bit of the status byte register is assigned a bit in the service request enable register. Bit 6 of the service request enable register is ignored. If a bit is set in the service request enable register and the associated bit in the status byte register changes from 0 to 1, a service request (SRQ) is generated on the IEC/IEEE bus. This service request triggers an interrupt in the controller configured for this purpose, and can be further processed by the controller.

Set and read the service request enable register using `*SRE`.

See [Figure 14-1](#).

Table 14-4: Used status byte bits and their meaning

Bit no.	Short description	Bit is set if
1	Device status register summary	A instrument is connected or disconnected or when an error has occurred in a instrument, depending on the configuration of the instrument status register. Chapter 14.4.5, "Device status register" , on page 480
2	Error queue not empty	The error queue has an entry. If this bit is enabled by the service request enable register, each entry of the error queue generates a service request. An error can thus be recognized and specified in detail by querying the error queue. The query yields a conclusive error message. This procedure is recommended since it considerably reduces the problems of IEC/IEEE-bus control.
3	Questionable status register summary	An <code>EVENT</code> bit is set in the <code>QUESTIONable</code> status register and the associated <code>ENABLE</code> bit is set to 1. A set bit denotes a questionable device status which can be specified in greater detail by querying the questionable status register. Chapter 14.4.6, "Questionable status register" , on page 482
4	MAV Message available	A readable message is in the output queue. This bit can be used to automate reading of data from the instrument into the controller.

Bit no.	Short description	Bit is set if
5	ESB Standard event status register summary	One of the bits in the standard event status register is set and enabled in the event status enable register. Setting this bit denotes a serious error which can be specified in greater detail by querying the standard event status register. Chapter 14.4.7, "Standard event status and enable register (ESR, ESE)" , on page 486.
6	MSS Master status summary	The instrument triggers a service request, which happens if one of the other bits of this register is set together with its enable bit in the service request enable register (SRE).
7	Operation status register summary	An <code>EVENT</code> bit is set in the operation status register and the associated <code>ENABLE</code> bit is set to 1. A set bit denotes that an action is being performed by the instrument. Information on the type of action can be obtained by querying the operation status register. Chapter 14.4.8, "Operation status register" , on page 487

14.4.4 IST flag and parallel poll enable register (PPE)

Similar to the service request (SRQ), the IST flag combines the complete status information in a single bit. It can be queried by a parallel poll or by `*IST?`.

The parallel poll enable register (PPE) determines which bits of the STB affect the IST flag. The bits of the STB are ANDed with the corresponding bits of the PPE; bit 6 is also used, in contrast to the service request enable register. The IST flag is obtained by ORing all results together.

Set and read the parallel poll enable register using `*PRE`.

14.4.5 Device status register

Contains information on current instrument states, `CONDition` register, or states that occurred since the last query, `EVENT` register.

0	0	+
Sensor A connected	1	
Sensor B connected	2	
Sensor A error	3	
Sensor B error	4	
Sensor A Front/Rear	5	
Sensor B Front/Rear	6	
Sensor C connected	7	
Sensor D connected	8	
Sensor C error	9	
Sensor D error	10	
Sensor C Front/Rear	11	
Sensor D Front/Rear	12	
NRT Sensor connected	13	
Key pressed	14	
not used	15	

Figure 14-3: Device status register

Querying the register:

- `STATUS:DEVICE:CONDITION?`
- `STATUS:DEVICE[:EVENT]?`

Table 14-5: Used device status bits and their meaning

Bit no.	Short description	Bit is set if
1	Sensor A connected	
2	Sensor B connected	
3	Sensor A error	
4	Sensor B error	
5	Sensor A front/rear	Sensor A connected at the rear.
6	Sensor B front/rear	Sensor B connected at the rear.
7	Sensor C connected	
8	Sensor D connected	
9	Sensor C error	
10	Sensor D error	
11	Sensor C front/rear	Sensor C connected at the rear.
12	Sensor D front/rear	Sensor D connected at the rear.

Bit no.	Short description	Bit is set if
13	NRT sensor connected	
14	Key pressed	Front panel key pressed.

14.4.6 Questionable status register

Contains information on questionable instrument states that occur if the instrument is not operated in compliance with its specifications.

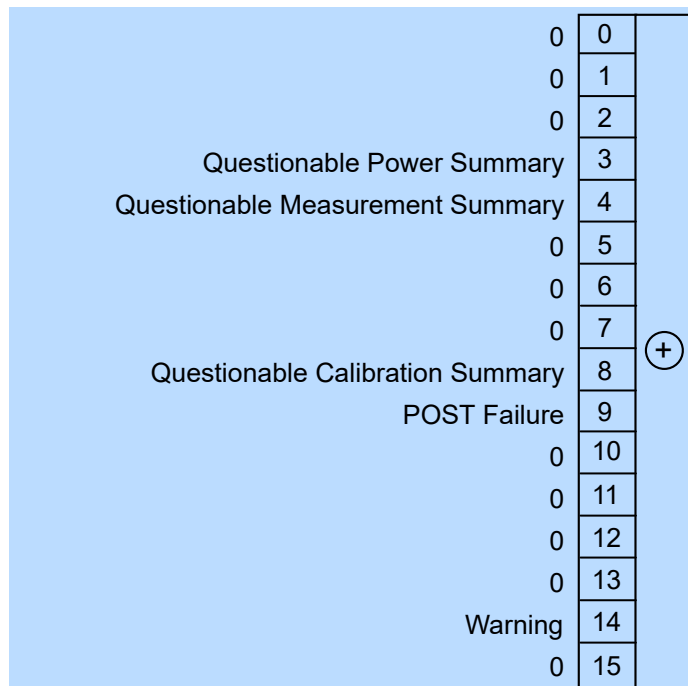

Figure 14-4: Questionable status register

Querying the register:

- `STATUS:QUESTIONable:CONDition?`
- `STATUS:QUESTIONable[:EVENT]?`

Table 14-6: Used questionable status bits and their meaning

Bit no.	Short description	Bit is set if
3	Questionable power summary	Summary of Questionable power status register exists.
4	Questionable measurement summary	Summary of Questionable measurement status registers exists.
8	Questionable calibration summary	Summary of Questionable calibration status register exists.

Bit no.	Short description	Bit is set if
9	POST failure	Built-in test of the R&S NRX that is carried out automatically upon power-up has generated an error.
14	Warning	

14.4.6.1 Questionable power status register

Contains information whether the measured power values are questionable.

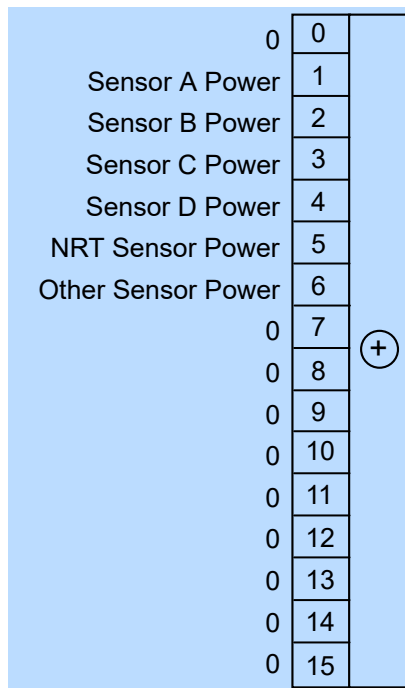

Figure 14-5: Questionable power status register

Querying the register:

- `STATUS:QUESTIONABLE:POWER[:SUMMARY]:CONDITION?`
- `STATUS:QUESTIONABLE:POWER[:SUMMARY][:EVENT]?`

Table 14-7: Used questionable power status bits and their meaning

Bit no.	Short description	Bit is set if measurement data of a sensor are corrupt.
1	Sensor A power	Sensor A
2	Sensor B power	Sensor B
3	Sensor C power	Sensor C
4	Sensor D power	Sensor D
5	NRT sensor power	R&S NRT-Zxx power sensor
6	Other sensor power	USB or LAN power sensor

14.4.6.2 Questionable measurement status registers

Contain information whether the displayed data or the calculated power is questionable.

For information on index *m*, see [Chapter 14.4.1, "Hierarchy of the status registers"](#), on page 476.

Extension Summary	0	+
Measurement m+1 Power	1	
Measurement m+2 Power	2	
Measurement m+3 Power	3	
Measurement m+4 Power	4	
Measurement m+5 Power	5	
Measurement m+6 Power	6	
Measurement m+7 Power	7	
Measurement m+8 Power	8	
0	9	
0	10	
0	11	
0	12	
0	13	
0	14	
0	15	

Figure 14-6: Questionable measurement status registers

Querying the register:

- `STATUS:QUESTIONable:MEASure<RegisterIndex>:CONDition?`
- `STATUS:QUESTIONable:MEASure<RegisterIndex>[:SUMMARY][:EVENT]?`
- `STATUS:QUESTIONable:WINDow<RegisterIndex>:CONDition?`
- `STATUS:QUESTIONable:WINDow<RegisterIndex>[:SUMMARY][:EVENT]?`

Table 14-8: Used questionable measurement status bits and their meaning

Bit no.	Short description	Bit is set if measured values of a measurement channel are corrupt or for the extension summary.
0	Extension summary	Sum bit of the next lower status register.
1	Measurement m+1 power	Channel 1
2	Measurement m+2 power	Channel 2
3	Measurement m+3 power	Channel 3
4	Measurement m+4 power	Channel 4
5	Measurement m+5 power	Channel 5

Bit no.	Short description	Bit is set if measured values of a measurement channel are corrupt or for the extension summary.
6	Measurement m+6 power	Channel 6
7	Measurement m+7 power	Channel 7
8	Measurement m+8 power	Channel 8

14.4.6.3 Questionable calibration status register

Contains information whether the zeroing of a power sensor was successful.

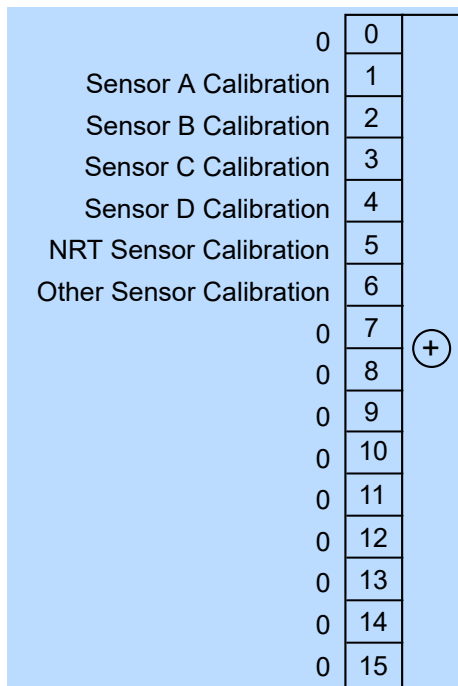

Figure 14-7: Questionable calibration status register

Querying the register:

- `STATUS:QUESTionable:CALibration[:SUMMARY]:CONDition?`
- `STATUS:QUESTionable:CALibration[:SUMMARY][:EVENT]?`

Table 14-9: Used questionable calibration status bits and their meaning

Bit no.	Short description	Bit is set if zeroing of a sensor is not successful.
1	Sensor A calibration	Sensor A
2	Sensor B calibration	Sensor B
3	Sensor C calibration	Sensor C
4	Sensor D calibration	Sensor D

Bit no.	Short description	Bit is set if zeroing of a sensor is not successful.
5	NRT sensor calibration	R&S NRT-Zxx power sensor
6	Other sensor calibration	USB or LAN power sensor

14.4.7 Standard event status and enable register (ESR, ESE)

The `ESR` is already defined in the IEEE 488.2 standard. It is comparable to the `EVENT` register of a SCPI register. The standard event status register can be read out by `*ESR?`.

The `ESE` forms the associated `ENABLE` register. It can be set and read by `*ESE`.

Operation Complete	0	+
0	1	
Query Error	2	
Device-Dependent Error	3	
Execution Error	4	
Command Error	5	
User Request	6	
Power On	7	

Figure 14-8: Standard event status register (ESR)

Table 14-10: Used standard event status bits and their meaning

Bit no.	Short description	Bit is set if
0	Operation complete	All previous commands have been executed and <code>*OPC</code> is received.
2	Query error	The controller wants to read data from the instrument but has not sent a query, or it sends new commands to the instrument before it retrieves existing requested data. A frequent cause is a faulty query which cannot be executed.
3	Device-dependent error	A instrument-dependent error occurs. An error message with a number between -300 and -399 or a positive error number denoting the error in greater detail is entered in the error queue.
4	Execution error	The syntax of a received command is correct but the command cannot be executed due to various marginal conditions. An error message with a number between -200 and -300 denoting the error in greater detail is entered in the error queue.
5	Command error	An undefined command or a command with incorrect syntax is received. An error message with a number between -100 and -200 denoting the error in greater detail is entered in the error queue.
6	User request	The instrument is switched over to manual control.
7	Power on	The instrument is switched on.

14.4.8 Operation status register

Contains information on current operations, `CONDition` register, or operations performed since the last query, `EVENT` register.

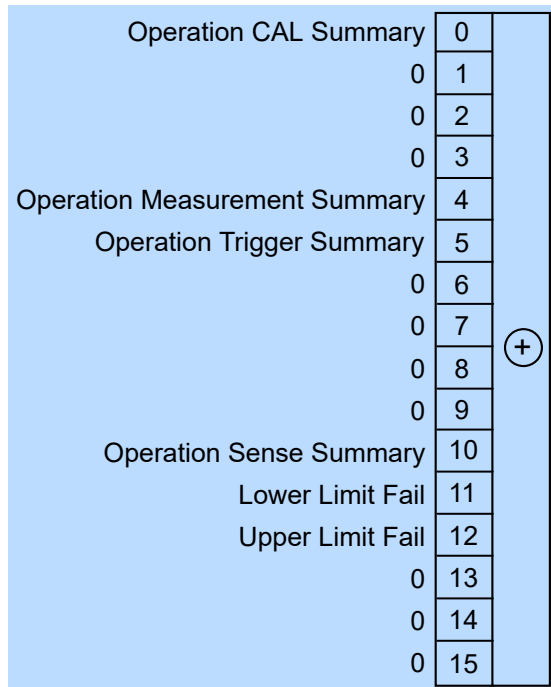

Figure 14-9: Operation status register

Querying the register:

- `STATUS:OPERation:CONDition?`
- `STATUS:OPERation[:EVENT]?`

Table 14-11: Used operation status bits and their meaning

Bit no.	Short description	Bit is set if
0	Operation CAL summary	Summary of Operation calibrating status register exists.
4	Operation measurement summary	Summary of Operation measuring status register exists.
5	Operation trigger summary	Summary of Operation trigger status register exists.
10	Operation sense summary	Summary of Operation sense status register exists.
11	Lower limit fail	Summary of Operation lower limit fail status registers exists.
12	Upper limit fail	Summary of Operation upper limit fail status registers exists.

14.4.8.1 Operation calibrating status register

The `CONDition` register contains information whether a power sensor is being calibrated. The `EVENT` register contains information whether a calibration was started or completed since the last query.

0	0	+
Sensor A calibrating	1	
Sensor B calibrating	2	
Sensor C calibrating	3	
Sensor D calibrating	4	
NRT Sensor calibrating	5	
Other Sensor calibrating	6	
0	7	
0	8	
0	9	
0	10	
0	11	
0	12	
0	13	
0	14	
0	15	

Figure 14-10: Operation calibrating status register

Querying the register:

- `STATUS:OPERation:CALibrating[:SUMMARY]:CONDition?`
- `STATUS:OPERation:CALibrating[:SUMMARY][:EVENT]?`

Table 14-12: Used operation calibrating status bits and their meaning

Bit no.	Short description	Bit is set if a sensor is zeroing.
1	Sensor A calibrating	Sensor A
2	Sensor B calibrating	Sensor B
3	Sensor C calibrating	Sensor C
4	Sensor D calibrating	Sensor D
5	NRT sensor calibrating	R&S NRT-Zxx power sensor
6	Other sensor calibrating	USB or LAN power sensor

14.4.8.2 Operation measuring status register

The `CONDition` register contains information whether a power sensor is measuring. The `EVENT` register contains information whether a measurement was started or completed since the last query.

Extension Summary	0	+
Sensor A measuring	1	
Sensor B measuring	2	
Sensor C measuring	3	
Sensor D measuring	4	
NRT Sensor measuring	5	
Other Sensor measuring	6	
0	7	
0	8	
0	9	
0	10	
0	11	
0	12	
0	13	
0	14	
0	15	

Figure 14-11: Operation measuring status register

Querying the register:

- `STATUS:OPERation:MEASuring[:SUMMARY]:CONDition?`
- `STATUS:OPERation:MEASuring[:SUMMARY][:EVENT]?`

Table 14-13: Used operation measuring status bits and their meaning

Bit no.	Short description	Bit is set if a sensor is measuring or for the extension summary.
0	Extension summary	Summary of Operation measuring extended status registers exists.
1	Sensor A measuring	Sensor A
2	Sensor B measuring	Sensor B
3	Sensor C measuring	Sensor C
4	Sensor D measuring	Sensor D
5	NRT sensor measuring	R&S NRT-Zxx power sensor
6	Other sensor measuring	USB or LAN power sensor

14.4.8.3 Operation measuring extended status registers

The `CONDition` registers contain information whether a measurement channel is used. The `EVENT` registers contain information whether a measurement channel was used since the last query.

For information on index m, see [Chapter 14.4.1, "Hierarchy of the status registers"](#), on page 476.

Extension Summary	0	+
Measurement m+1 measuring	1	
Measurement m+2 measuring	2	
Measurement m+3 measuring	3	
Measurement m+4 measuring	4	
Measurement m+5 measuring	5	
Measurement m+6 measuring	6	
Measurement m+7 measuring	7	
Measurement m+8 measuring	8	
0	9	
0	10	
0	11	
0	12	
0	13	
0	14	
0	15	

Figure 14-12: Operation measuring extended status registers

Querying the register:

- `STATUS:OPERation:MEASuring:EXTension<RegisterIndex>:CONDition?`
- `STATUS:OPERation:MEASuring:EXTension<RegisterIndex>[:SUMMARY] [:EVENT]?`

Table 14-14: Used operation measuring extended status bits and their meaning

Bit no.	Short description	Bit is set if a measurement channel is active or for the extension summary.
0	Extension summary	Sum bit of the next lower status register.
1	Measurement m+1 measuring	Channel 1
2	Measurement m+2 measuring	Channel 2
3	Measurement m+3 measuring	Channel 3
4	Measurement m+4 measuring	Channel 4
5	Measurement m+5 measuring	Channel 5
6	Measurement m+6 measuring	Channel 6
7	Measurement m+7 measuring	Channel 7
8	Measurement m+8 measuring	Channel 8

14.4.8.4 Operation trigger status register

The `CONDition` register contains information whether a power sensor is waiting for a trigger event. The `EVENT` register contains information whether the power sensor has been waiting for a trigger event since the last query.

Extension Summary	0	+
Sensor A wait for trigger	1	
Sensor B wait for trigger	2	
Sensor C wait for trigger	3	
Sensor D wait for trigger	4	
NRT Sensor wait for trigger	5	
Other Sensor wait for trigger	6	
0	7	
0	8	
0	9	
0	10	
0	11	
0	12	
0	13	
0	14	
0	15	

Figure 14-13: Operation trigger status register

Querying the register:

- `STATUS:OPERation:TRIGger[:SUMMARY]:CONDition?`
- `STATUS:OPERation:TRIGger[:SUMMARY][:EVENT]?`

Table 14-15: Used operation trigger status bits and their meaning

Bit no.	Short description	Bit is set if a sensor is waiting for trigger event or for the extension summary.
0	Extension summary	Summary of Operation trigger extended status registers exists.
1	Sensor A wait for trigger	Sensor A
2	Sensor B wait for trigger	Sensor B
3	Sensor C wait for trigger	Sensor C
4	Sensor D wait for trigger	Sensor D
5	NRT sensor wait for trigger	R&S NRT-Zxx power sensor
6	Other sensor wait for trigger	USB or LAN power sensor

14.4.8.5 Operation trigger extended status registers

The `CONDition` registers contain information whether a measurement channel is waiting for a trigger event. The `EVENT` registers contain information whether a measurement channel has been waiting for a trigger event since the last query.

For information on index `m`, see [Chapter 14.4.1, "Hierarchy of the status registers"](#), on page 476.

Extension Summary	0	+
Measurement m+1 wait for trigger	1	
Measurement m+2 wait for trigger	2	
Measurement m+3 wait for trigger	3	
Measurement m+4 wait for trigger	4	
Measurement m+5 wait for trigger	5	
Measurement m+6 wait for trigger	6	
Measurement m+7 wait for trigger	7	
Measurement m+8 wait for trigger	8	
0	9	
0	10	
0	11	
0	12	
0	13	
0	14	
0	15	

Figure 14-14: Operation trigger extended status registers

Querying the register:

- `STATUS:OPERation:TRIGger:EXTension<RegisterIndex>:CONDition?`
- `STATUS:OPERation:TRIGger:EXTension<RegisterIndex>[:SUMMARY][:EVENT]?`

Table 14-16: Used operation trigger extended status bits and their meaning

Bit no.	Short description	Bit is set if a measurement channel is waiting for trigger event or for the extension summary.
0	Extension summary	Sum bit of the next lower status register.
1	Measurement m+1 wait for trigger	Channel 1
2	Measurement m+2 wait for trigger	Channel 2
3	Measurement m+3 wait for trigger	Channel 3
4	Measurement m+4 wait for trigger	Channel 4
5	Measurement m+5 wait for trigger	Channel 5
6	Measurement m+6 wait for trigger	Channel 6

Bit no.	Short description	Bit is set if a measurement channel is waiting for trigger event or for the extension summary.
7	Measurement m+7 wait for trigger	Channel 7
8	Measurement m+8 wait for trigger	Channel 8

14.4.8.6 Operation sense status register

The `CONDition` register contains information whether a power sensor is being initialized. The `EVENTt` register contains information whether an initialization was started or completed since the last query.

A power sensor is initialized if:

- Supply voltage is switched on (power-up).
- Sensor was connected.
- Reset was performed, `*RST` or `SYSTEM:PRESet`.

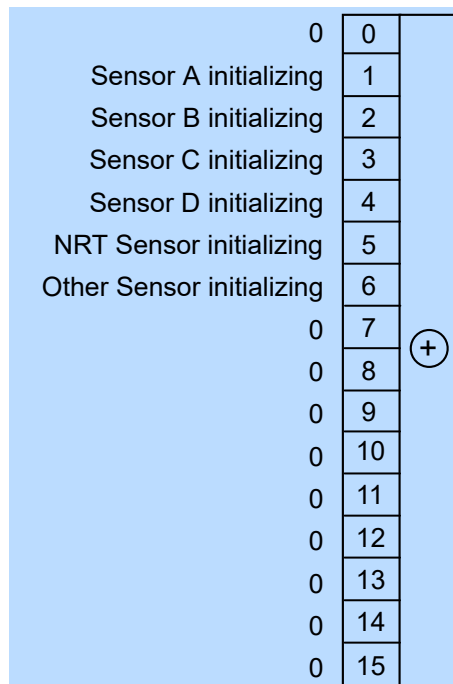

Figure 14-15: Operation sense status register

Querying the register:

- `STATus:OPERation:SENSe[:SUMMARY]:CONDition?`
- `STATus:OPERation:SENSe[:SUMMARY][:EVENT]?`

Table 14-17: Used operation sense status bits and their meaning

Bit no.	Short description	Bit is set if a sensor is initializing.
1	Sensor A initializing	Sensor A
2	Sensor B initializing	Sensor B

Bit no.	Short description	Bit is set if a sensor is initializing.
3	Sensor C initializing	Sensor C
4	Sensor D initializing	Sensor D
5	NRT sensor initializing	R&S NRT-Zxx power sensor
6	Other sensor initializing	USB or LAN power sensor

14.4.8.7 Operation lower limit fail status registers

The `CONDition` registers contain information whether a measured value is below a configured lower limit. The `EVENT` registers contain information whether a measured value dropped below a limit value since the last query.

For information on index `m`, see [Chapter 14.4.1, "Hierarchy of the status registers"](#), on page 476.

Extension Summary	0	
Measurement m+1 Lower Limit Fail	1	+
Measurement m+2 Lower Limit Fail	2	
Measurement m+3 Lower Limit Fail	3	
Measurement m+4 Lower Limit Fail	4	
Measurement m+5 Lower Limit Fail	5	
Measurement m+6 Lower Limit Fail	6	
Measurement m+7 Lower Limit Fail	7	
Measurement m+8 Lower Limit Fail	8	
	0	9
	0	10
	0	11
	0	12
	0	13
	0	14
	0	15

Figure 14-16: Operation lower limit fail status registers

Querying the register:

- `STATUS:OPERation:LLFail<RegisterIndex>[:SUMMARY]:CONDition?`
- `STATUS:OPERation:LLFail<RegisterIndex>[:SUMMARY][:EVENT]?`

Table 14-18: Used operation lower limit fail status bits and their meaning

Bit no.	Short description	Bit is set if measured values of a measurement channel are below the lower limit value or for the summary.
0	Extension summary	Sum bit of the next lower status register.
1	Measurement m+1 lower limit fail	Channel 1
2	Measurement m+2 lower limit fail	Channel 2
3	Measurement m+3 lower limit fail	Channel 3
4	Measurement m+4 lower limit fail	Channel 4
5	Measurement m+5 lower limit fail	Channel 5
6	Measurement m+6 lower limit fail	Channel 6
7	Measurement m+7 lower limit fail	Channel 7
8	Measurement m+8 lower limit fail	Channel 8

14.4.8.8 Operation upper limit fail status registers

The `CONDition` registers contain information whether a measured value currently exceeds a configured upper limit. The `EVENT` registers contain information whether a measured value exceeded an upper limit value since the last query.

For information on index m, see [Chapter 14.4.1, "Hierarchy of the status registers"](#), on page 476.

Extension Summary	0	+
Measurement m+1 Upper Limit Fail	1	
Measurement m+2 Upper Limit Fail	2	
Measurement m+3 Upper Limit Fail	3	
Measurement m+4 Upper Limit Fail	4	
Measurement m+5 Upper Limit Fail	5	
Measurement m+6 Upper Limit Fail	6	
Measurement m+7 Upper Limit Fail	7	
Measurement m+8 Upper Limit Fail	8	
	0	
	0	
	0	
	0	
	0	
	0	
	0	

Figure 14-17: Operation upper limit fail status registers

Querying the register:

- `STATus:OPERation:ULFail<RegisterIndex>[:SUMMARY]:CONDition?`
- `STATus:OPERation:ULFail<RegisterIndex>[:SUMMARY][:EVENT]?`

Table 14-19: Used operation upper limit fail status bits and their meaning

Bit no.	Short description	Bit is set if measured values of a measurement channel exceed the upper limit value or for the summary.
0	Extension summary	Sum bit of the next lower status register.
1	Measurement m+1 upper limit fail	Channel 1
2	Measurement m+2 upper limit fail	Channel 2
3	Measurement m+3 upper limit fail	Channel 3
4	Measurement m+4 upper limit fail	Channel 4
5	Measurement m+5 upper limit fail	Channel 5
6	Measurement m+6 upper limit fail	Channel 6
7	Measurement m+7 upper limit fail	Channel 7
8	Measurement m+8 upper limit fail	Channel 8

15 Troubleshooting

• Displaying information	497
• Notifications	497
• Performing tests	501
• Collecting information for technical support	502
• Contacting customer support	502

15.1 Displaying information

Status information

Status information is displayed in the title bar of the graphical user interface. See [Chapter 4, "Operating concepts"](#), on page 33.

In remote control, the status reporting system stores all information on the current operating state and occurred errors. See:

- [Chapter 13.15, "Using the status register"](#), on page 419
- [Chapter 14.4, "Status reporting system"](#), on page 475

Instrument information

Instrument information, including the installed hardware and software options, is available under [Chapter 10.2, "Instrument info"](#), on page 154.

The hardware configuration is provided separately under [Chapter 10.3, "Hardware configuration"](#), on page 166.

In remote control, use the commands described in [Chapter 13.14.7, "Instrument information"](#), on page 410.

Sensor information

You can display information about one of the connected power sensors. See ["Sensor Info"](#) on page 152.

In remote control, use the commands described in [Chapter 13.14.7, "Instrument information"](#), on page 410.

15.2 Notifications

The graphical user interface has a notification center where all information, warning and error messages are collected. See [Chapter 4.1.4, "Notification center"](#), on page 37.

In remote control, use the commands described in [Chapter 13.14.9, "Notifications and errors"](#), on page 415.

15.2.1 Interpreting notifications and their number

In the following, important notifications and their meaning are explained. For all other notifications, perform tests to find out whether it is a hardware or software problem, and report the problem to the R&S customer support. See [Chapter 15.3, "Performing tests"](#), on page 501.

In remote control, notifications and errors are associated with a unique number. Positive numbers are instrument-dependent. Negative numbers are reserved by the SCPI standard.

The notification types are grouped in number ranges. In the following description, both the number used in remote control and the description is given to help identify the problem.

15.2.1.1 System notifications

Number range: 1000 to 1999. Described notifications:

1004 - firmware update error	498
1005 - settings conflict	498
1007 - target descriptor error	498
1008 - temperature alert	498
1009 - fan failure alert	499

1004 - firmware update error

Firmware update failed.

Possible reasons:

- You have used an *.rsu file that is not designated for the R&S NRX. The name of a suitable *.rsu file starts with "NRX".
- The firmware update was interrupted or otherwise faulty.

Solution: Perform the firmware update again. See [Chapter 12, "Firmware update"](#), on page 171.

1005 - settings conflict

Settings conflict of the R&S NRX occurred.

Reason: Contradictory settings are allowed so that you are not hampered in your workflow.

Solution: See [Chapter 5.5, "Settings conflict"](#), on page 50.

1007 - target descriptor error

Servicing required. You cannot resolve the problem yourself.

Solution: Contact customer support. See [Chapter 15.5, "Contacting customer support"](#), on page 502.

1008 - temperature alert

R&S NRX is overheated. Overheating can damage the R&S NRX.

Possible reasons:

- Insufficient airflow. Follow the instructions in [Chapter 3.1.4, "Setting up the product"](#), on page 18.
- The environmental temperature exceeds the suitable temperature range given in the data sheet under environmental conditions.
- The fan does not work properly. See [Chapter 15.5, "Contacting customer support"](#), on page 502.

1009 - fan failure alert

The fan does not work. Overheating can damage the R&S NRX.

Solution: Switch off the R&S NRX, and contact customer support. See [Chapter 15.5, "Contacting customer support"](#), on page 502.

15.2.1.2 Power sensor notifications

Number range: 2000 to 2999.

The power sensors report their error states to the R&S NRX. The error states depend on the power sensor type. Described notifications:

2001 - sensor maximum allowed count	499
2003 - sensor settings conflict	499
2005 - sensor underrange	499
2006 - sensor overrange	500
2007 - sensor overload	500
2008 - sensor protocol minor mismatch	500
2009 - sensor protocol major mismatch	500

2001 - sensor maximum allowed count

The maximum number of power sensors that you can use simultaneously is reached.

Solution: Install the second measurement channel (R&S NRX-K2) or the 3rd and 4th measurement channel (R&S NRX-K4).

See also:

- [Chapter 5.1, "Parallel measurements"](#), on page 46
- [Chapter 11, "Option management"](#), on page 170

2003 - sensor settings conflict

The current settings of the R&S NRX do not comply with the operating range of the connected power sensor.

Solution: Change the settings of the R&S NRX or use another power sensor that is suitable for the selected settings.

2005 - sensor underrange

Possible reasons:

- The detected signal is below the minimum value that the power sensor can correctly measure.
- The current settings of the R&S NRX undercut the specified operating range of the connected power sensor.

Solution: Change the settings of the R&S NRX or use another power sensor that is suitable for the selected settings.

2006 - sensor overrange

Possible reasons:

- The detected signal is above the maximum value that the power sensor can correctly measure.
- The current settings of the R&S NRX exceed the specified operating range of the connected power sensor.

Solution: Change the settings of the R&S NRX or use another power sensor that is suitable for the selected settings.

2007 - sensor overload

The RF input power exceeds the measurement range by far.

Solution: Immediately disconnect the power sensor from the RF source to avoid damage. Use an attenuator or another power sensor that is suitable for the input level.

2008 - sensor protocol minor mismatch

The firmware version of the connected power sensor is out-of-date.

Solution: An update of the power sensor firmware is recommended.

2009 - sensor protocol major mismatch

The firmware version of the connected power sensor is not supported any more.

Solution: Update the firmware of the connected power sensor.

15.2.1.3 Sensor check source (R&S NRX-B1) notifications

Number range: 3000 to 3999. Described notifications:

3002 - setting not supported	500
3003 - missing calibration data	500
3004 - version <no.> available for sensor check source (R&S NRX-B1)	501

3002 - setting not supported

The sensor check source (R&S NRX-B1) does not support the set frequency or power level.

Solution: Change the frequency or power level setting. See "[Sensor Check Source tab](#)" on page 146.

3003 - missing calibration data

The calibration data of the sensor check source (R&S NRX-B1) are missing for the set power level.

Solution:

- Change the frequency or power level setting. See "[Sensor Check Source tab](#)" on page 146.
- If you cannot work with another power level, servicing is required. Contact customer support. See [Chapter 15.5, "Contacting customer support"](#), on page 502.

3004 - version <no.> available for sensor check source (R&S NRX-B1)

A newer version of the sensor check source (R&S NRX-B1) is available.

Solution: Update the sensor check source (R&S NRX-B1) as described in "[Sensor Check Source Info](#)" on page 147.

15.2.1.4 License key notifications

Number range: 4000 to 4999.

For all notifications not described here, collect information for technical support. See [Chapter 15.4, "Collecting information for technical support"](#), on page 502. Described notifications:

4001 - license key management warning	501
4002 - remote language not allowed, NRX-K301 option missing	501

4001 - license key management warning

Usually caused by:

- Problems with the system time. See "[Date and Time Settings](#)" on page 156.
- Wrong license key for a software option.
See "[SW Options tab](#)" on page 162.

4002 - remote language not allowed, NRX-K301 option missing

For the feature you want to use, the NRX KS emulation mode (R&S NRX-K301) option is required. The option is not installed on your R&S NRX.

Solution: Purchase the NRX KS emulation mode (R&S NRX-K301) option and install it. See also [Chapter 11, "Option management"](#), on page 170.

15.2.1.5 Queue handling notifications

Number range starts from 9000.

9001 - static error queue overflow

The queue of events has reached its maximum number of 1000 notices, warnings and errors. No more entries are created.

Solution: Solve the errors before continuing.

15.3 Performing tests

Using the graphical user interface, you can test the following:

- User interface of the R&S NRX, see [Chapter 10.4, "Test"](#), on page 167.
- Connected power sensors, see "[Sensor Test](#)" on page 153.

In remote control, use the commands described in [Chapter 13.12, "Running selftests"](#), on page 389.

15.4 Collecting information for technical support

If you encounter problems that you cannot solve yourself, contact your Rohde & Schwarz support center, see [Chapter 15.5, "Contacting customer support"](#), on page 502. Our support center staff is optimally trained to assist you in solving problems.

The support center finds solutions more quickly and efficiently if you provide them with information on the instrument and an error description.

Obtaining information from the R&S NRX firmware

1. Select [System] > "Test".
2. Create and save the information for troubleshooting. See ["Creating information for troubleshooting"](#) on page 168.

Attach the archive file to an email in which you describe the problem.

If you need to transport or ship the product, see [Chapter 16, "Transporting"](#), on page 503.

15.5 Contacting customer support

Technical support – where and when you need it

For quick, expert help with any Rohde & Schwarz product, contact our customer support center. A team of highly qualified engineers provides support and works with you to find a solution to your query on any aspect of the operation, programming or applications of Rohde & Schwarz products.

Contact information

Contact our customer support center at www.rohde-schwarz.com/support, or follow this QR code:



Figure 15-1: QR code to the Rohde & Schwarz support page

16 Transporting

Lifting and carrying

See:

- ["Lifting and carrying the product"](#) on page 12
- [Chapter 3.1.1, "Lifting and carrying"](#), on page 17

Packing

Use the original packaging material. It consists of antistatic wrap for electrostatic protection and packing material designed for the product.

If you do not have the original packaging, use similar materials that provide the same level of protection.

Securing

When moving the product in a vehicle or using transporting equipment, make sure that the product is properly secured. Only use items intended for securing objects.

Transport altitude

Unless otherwise specified in the data sheet, the maximum transport altitude without pressure compensation is 4500 m above sea level.

17 Maintenance, storage and disposal

The product does not require regular maintenance. It only requires occasional cleaning. It is however advisable to check the nominal data from time to time.

17.1 Cleaning

How to clean the product is described in "[Cleaning the product](#)" on page 13.

Do not use any liquids for cleaning. Cleaning agents, solvents (thinners, acetone), acids and bases can damage the front panel labeling, plastic parts and display.

17.2 Storage

Protect the product against dust. Ensure that the environmental conditions, e.g. temperature range and climatic load, meet the values specified in the data sheet.

17.3 Disposal

Rohde & Schwarz is committed to making careful, ecologically sound use of natural resources and minimizing the environmental footprint of our products. Help us by disposing of waste in a way that causes minimum environmental impact.

Disposing electrical and electronic equipment

A product that is labeled as follows cannot be disposed of in normal household waste after it has come to the end of its service life. Even disposal via the municipal collection points for waste electrical and electronic equipment is not permitted.



Figure 17-1: Labeling in line with EU directive WEEE

Rohde & Schwarz has developed a disposal concept for the eco-friendly disposal or recycling of waste material. As a manufacturer, Rohde & Schwarz completely fulfills its obligation to take back and dispose of electrical and electronic waste. Contact your local service representative to dispose of the product.

Glossary: List of abbreviations

A

AVG: Average

C

CCDF: Complementary cumulative distribution function

CDMA: Code division multiple access

D

DHCP: Dynamic host control protocol

DNS: Domain name system

E

EMC: Electromagnetic compatibility

EMI: Electromagnetic interference

G

GPIB: General purpose interface bus

H

HiSLIP: High-speed LAN instrument protocol

I

IDN: Instrument identification string

IP: Internet protocol

L

LAN: Local area network

O

OPT: Option identification string

OSA: Open source acknowledgement

P

PEP: Peak envelope power

S

SCPI: Standard commands for programmable instruments

SSH: Secure shell

SWR: Standing wave ratio

U

USB: Universal serial bus

V

VISA: Virtual instrument software architecture

VNC: Virtual network computing

W

WCDMA: Wideband code division multiple access

List of commands

[SENSe<Sensor>:][POWer:][AVG:]APERTure[:VALue].....	443
[SENSe<Sensor>:][POWer:][AVG:]BUFFer:CLEar.....	258
[SENSe<Sensor>:][POWer:][AVG:]BUFFer:COUNT?.....	259
[SENSe<Sensor>:][POWer:][AVG:]BUFFer:INFO?.....	259
[SENSe<Sensor>:][POWer:][AVG:]BUFFer:SIZE.....	259
[SENSe<Sensor>:][POWer:][AVG:]BUFFer:STATe.....	260
[SENSe<Sensor>:][POWer:][AVG:]SMOothing:STATe.....	444
[SENSe<Sensor>:][POWer:]BURSt:DTOLerance.....	444
[SENSe<Sensor>:][POWer:]NCORrection[:STATe].....	444
[SENSe<Sensor>:][POWer:]TGATe:SELect.....	445
[SENSe<Sensor>:][POWer:]TGATe[:EXCLude]:MID[:STATe].....	446
[SENSe<Sensor>:][POWer:]TGATe<Gate>:OFFSet:TIME.....	445
[SENSe<Sensor>:][POWer:]TGATe<Gate>:TIME.....	445
[SENSe<Sensor>:][POWer:]TGATe<Gate>[:EXCLude]:MID:OFFSet[:TIME].....	446
[SENSe<Sensor>:][POWer:]TGATe<Gate>[:EXCLude]:MID:TIME.....	446
[SENSe<Sensor>:][POWer:]TSLot[:AVG]:COUNT.....	447
[SENSe<Sensor>:][POWer:]TSLot[:AVG]:WIDTh.....	447
[SENSe<Sensor>:][POWer:]TSLot[:AVG][:EXCLude]:MID:OFFSet[:TIME].....	447
[SENSe<Sensor>:][POWer:]TSLot[:AVG][:EXCLude]:MID:TIME.....	447
[SENSe<Sensor>:][POWer:]TSLot[:AVG][:EXCLude]:MID[:STATe].....	448
[SENSe<Sensor>:]ADD.....	409
[SENSe<Sensor>:]AUXiliary.....	241
[SENSe<Sensor>:]AVERAge:COUNT:AUTO:MTIME.....	435
[SENSe<Sensor>:]AVERAge:COUNT:AUTO:NSRatio.....	435
[SENSe<Sensor>:]AVERAge:COUNT:AUTO:RESolution.....	341
[SENSe<Sensor>:]AVERAge:COUNT:AUTO:SLOT.....	435
[SENSe<Sensor>:]AVERAge:COUNT:AUTO:TYPE.....	435
[SENSe<Sensor>:]AVERAge:COUNT:AUTO[:STATe].....	436
[SENSe<Sensor>:]AVERAge:COUNT:ENUM.....	436
[SENSe<Sensor>:]AVERAge:COUNT[:VALue].....	436
[SENSe<Sensor>:]AVERAge:RESet.....	341
[SENSe<Sensor>:]AVERAge:TCONtrol.....	437
[SENSe<Sensor>:]AVERAge:TYPE.....	437
[SENSe<Sensor>:]AVERAge[:STATe].....	437
[SENSe<Sensor>:]BANDwidth:VIDeo.....	438
[SENSe<Sensor>:]BANDwidth:VIDeo:FNUMber.....	376
[SENSe<Sensor>:]BANDwidth:VIDeo:LIST?.....	438
[SENSe<Sensor>:]BANDwidth[:RESolution]:TYPE:AUTO[:STATe].....	365
[SENSe<Sensor>:]BANDwidth[:RESolution]:TYPE[:VALue].....	365
[SENSe<Sensor>:]BANDwidth[:RESolution][:VALue].....	366
[SENSe<Sensor>:]BURSt:MODE.....	438
[SENSe<Sensor>:]BURSt:PERiod.....	438
[SENSe<Sensor>:]BURSt:WIDTh.....	439
[SENSe<Sensor>:]BWIDth:VIDeo.....	438
[SENSe<Sensor>:]BWIDth:VIDeo:FNUMber.....	376
[SENSe<Sensor>:]BWIDth:VIDeo:LIST?.....	438
[SENSe<Sensor>:]CATalog?.....	242

[SENSe<Sensor>:]CORRection:DCYClE:STATe.....	439
[SENSe<Sensor>:]CORRection:DCYClE[:INPut][:MAGNitude].....	439
[SENSe<Sensor>:]CORRection:DCYClE[:VALue].....	440
[SENSe<Sensor>:]CORRection:FDOFFset[:INPut][:MAGNitude]?.....	440
[SENSe<Sensor>:]CORRection:FDOTable:STATe.....	440
[SENSe<Sensor>:]CORRection:FDOTable[:SElect].....	441
[SENSe<Sensor>:]CORRection:OFFSet:STATe.....	441
[SENSe<Sensor>:]CORRection:OFFSet[:VALue].....	441
[SENSe<Sensor>:]CORRection:SPDevice:LIST?.....	336
[SENSe<Sensor>:]CORRection:SPDevice:SElect.....	336
[SENSe<Sensor>:]CORRection:SPDevice:STATe.....	336
[SENSe<Sensor>:]DATA?.....	441
[SENSe<Sensor>:]DM:STANdard.....	371
[SENSe<Sensor>:]DM:STATe.....	370
[SENSe<Sensor>:]DM:WCDMa:CRATe.....	442
[SENSe<Sensor>:]FREQuency:FIXed.....	330
[SENSe<Sensor>:]FREQuency:TRACk.....	330
[SENSe<Sensor>:]FREQuency[:CW].....	330
[SENSe<Sensor>:]FUNCTion:CONCurent.....	323
[SENSe<Sensor>:]FUNCTion:OFF:ALL<Channel>.....	323
[SENSe<Sensor>:]FUNCTion:OFF[:FUNC].....	323
[SENSe<Sensor>:]FUNCTion:STATe?.....	324
[SENSe<Sensor>:]FUNCTion[:ON].....	442
[SENSe<Sensor>:]INFormation?.....	442
[SENSe<Sensor>:]INPut:ATTenuation:AUTO.....	443
[SENSe<Sensor>:]INPut:ATTenuation[:VALue].....	443
[SENSe<Sensor>:]INTerMal:TRIGger:JITTer:METHod.....	443
[SENSe<Sensor>:]POWer:CCDFunction:REFerence.....	448
[SENSe<Sensor>:]POWer:PEP:HOLD.....	448
[SENSe<Sensor>:]POWer:REFerence.....	245
[SENSe<Sensor>:]POWer:REFLection:RANGe:AUTO.....	324
[SENSe<Sensor>:]POWer:REFLection:RANGe:LIMit:DETECT.....	324
[SENSe<Sensor>:]POWer:REFLection:RANGe:LIMit[:STATe].....	325
[SENSe<Sensor>:]POWer:REFLection:RANGe:LOWer.....	325
[SENSe<Sensor>:]POWer:REFLection:RANGe[:UPPer].....	325
[SENSe<Sensor>:]POWer[:POWer]:RANGe:AUTO.....	324
[SENSe<Sensor>:]POWer[:POWer]:RANGe:LIMit:DETECT.....	324
[SENSe<Sensor>:]POWer[:POWer]:RANGe:LIMit[:STATe].....	325
[SENSe<Sensor>:]POWer[:POWer]:RANGe:LOWer.....	325
[SENSe<Sensor>:]POWer[:POWer]:RANGe[:UPPer].....	325
[SENSe<Sensor>:]RANGe:AUTO.....	449
[SENSe<Sensor>:]RANGe:CLEVel.....	449
[SENSe<Sensor>:]RANGe[:VALue].....	449
[SENSe<Sensor>:]RGAMma:PHASe.....	337
[SENSe<Sensor>:]RGAMma[:MAGNitude].....	337
[SENSe<Sensor>:]ROSCillator:REFio:FREQuency.....	450
[SENSe<Sensor>:]ROSCillator:REFio:OUTPut[:STATe].....	450
[SENSe<Sensor>:]ROSCillator:SOURce.....	450
[SENSe<Sensor>:]RRResolution.....	326
[SENSe<Sensor>:]SAMPLing.....	451

[SENSe<Sensor>:]SGAMma:CORRection:STATe.....	451
[SENSe<Sensor>:]SGAMma:PHASe.....	451
[SENSe<Sensor>:]SGAMma[:MAGNitude].....	451
[SENSe<Sensor>:]STATistics:AVERage?.....	310
[SENSe<Sensor>:]STATistics:OFFSet[:TIME].....	311
[SENSe<Sensor>:]STATistics:PEAK?.....	311
[SENSe<Sensor>:]STATistics:SAMPLes[:MINimum].....	452
[SENSe<Sensor>:]STATistics:SCALe:X:MPWidth?.....	313
[SENSe<Sensor>:]STATistics:SCALe:X:POINts.....	452
[SENSe<Sensor>:]STATistics:SCALe:X:RANGe.....	452
[SENSe<Sensor>:]STATistics:SCALe:X:RLEVel.....	453
[SENSe<Sensor>:]STATistics:TIME.....	453
[SENSe<Sensor>:]STATistics[:EXCLude]:MID:OFFSet[:TIME].....	453
[SENSe<Sensor>:]STATistics[:EXCLude]:MID:TIME.....	454
[SENSe<Sensor>:]TIMing:EXCLude:START.....	454
[SENSe<Sensor>:]TIMing:EXCLude:STOP.....	454
[SENSe<Sensor>:]TRACe:AVERage:COUNT.....	454
[SENSe<Sensor>:]TRACe:AVERage:TCONtrol.....	455
[SENSe<Sensor>:]TRACe:AVERage[:STATe].....	455
[SENSe<Sensor>:]TRACe:ESAMpling:AUTO.....	455
[SENSe<Sensor>:]TRACe:MEASurement:ALGorithm.....	456
[SENSe<Sensor>:]TRACe:MEASurement:AUTO[:STATe].....	280
[SENSe<Sensor>:]TRACe:MEASurement:DEFine:DURation:REFerence.....	456
[SENSe<Sensor>:]TRACe:MEASurement:DEFine:TRANSition:HREFerence.....	456
[SENSe<Sensor>:]TRACe:MEASurement:DEFine:TRANSition:LREFerence.....	457
[SENSe<Sensor>:]TRACe:MEASurement:OFFSet:TIME.....	280
[SENSe<Sensor>:]TRACe:MEASurement:POWer:AVG?.....	457
[SENSe<Sensor>:]TRACe:MEASurement:POWer:HREFerence?.....	457
[SENSe<Sensor>:]TRACe:MEASurement:POWer:LREFerence?.....	458
[SENSe<Sensor>:]TRACe:MEASurement:POWer:MAX?.....	458
[SENSe<Sensor>:]TRACe:MEASurement:POWer:MIN?.....	458
[SENSe<Sensor>:]TRACe:MEASurement:POWer:PULSe:BASE?.....	458
[SENSe<Sensor>:]TRACe:MEASurement:POWer:PULSe:TOP?.....	459
[SENSe<Sensor>:]TRACe:MEASurement:POWer:REFerence?.....	459
[SENSe<Sensor>:]TRACe:MEASurement:PULSe:DCYCLe?.....	459
[SENSe<Sensor>:]TRACe:MEASurement:PULSe:DURation?.....	460
[SENSe<Sensor>:]TRACe:MEASurement:PULSe:PERiod?.....	460
[SENSe<Sensor>:]TRACe:MEASurement:PULSe:SEPAration?.....	460
[SENSe<Sensor>:]TRACe:MEASurement:TRANSition:ESAMpling:AUTO[:STATe].....	460
[SENSe<Sensor>:]TRACe:MEASurement:TRANSition:NEGative:DURation?.....	461
[SENSe<Sensor>:]TRACe:MEASurement:TRANSition:NEGative:OCCurrence?.....	461
[SENSe<Sensor>:]TRACe:MEASurement:TRANSition:NEGative:OVERshoot?.....	461
[SENSe<Sensor>:]TRACe:MEASurement:TRANSition:POSitive:DURation?.....	461
[SENSe<Sensor>:]TRACe:MEASurement:TRANSition:POSitive:OCCurrence?.....	462
[SENSe<Sensor>:]TRACe:MEASurement:TRANSition:POSitive:OVERshoot?.....	462
[SENSe<Sensor>:]TRACe:MEASurement:TRANSition:SPERiod?.....	462
[SENSe<Sensor>:]TRACe:MEASurement[:STATe].....	280
[SENSe<Sensor>:]TRACe:MID:OFFSet:TIME.....	281
[SENSe<Sensor>:]TRACe:MID:TIME.....	281
[SENSe<Sensor>:]TRACe:OFFSet:TIME.....	216

[SENSe<Sensor>:]TRACe:POINts.....	462
[SENSe<Sensor>:]TRACe:REALtime.....	271
[SENSe<Sensor>:]TRACe:TIME.....	216
*CLS.....	180
*DEV.....	181
*DMC.....	181
*EMC.....	181
*ESE.....	181
*ESR?.....	181
*GCLS.....	182
*GMC?.....	182
*GOPC?.....	182
*GWAI.....	182
*IDN?.....	182
*IST?.....	182
*LMC?.....	183
*OPC.....	183
*OPT?.....	183
*PMC.....	183
*PRE.....	183
*PSC.....	184
*RCL.....	184
*RMC.....	184
*RST.....	184
*SAV.....	184
*SRE.....	185
*SRQ?.....	185
*STB?.....	185
*TRG.....	185
*TST?.....	185
*WAI.....	186
*XESE.....	186
*XESR?.....	186
*XPRES.....	186
*XSRE.....	186
*XSTB?.....	187
&ABO.....	179
&DFC.....	179
&GET.....	180
>L.....	180
>M.....	180
>R.....	180
&HFC.....	180
&LLO.....	180
&NREN.....	180
ABORT<Measurement>.....	193
ABORT<undef>:ALL.....	193
CALCulate<Measurement>:AVALue.....	198
CALCulate<Measurement>:COUNT:DATA?.....	326
CALCulate<Measurement>:DATA?.....	327

CALCulate<Measurement>:DMODE.....	198
CALCulate<Measurement>:EXTRemes:RESet.....	199
CALCulate<Measurement>:HOLD:FUNctIon.....	199
CALCulate<Measurement>:HOLD[:STATe].....	199
CALCulate<Measurement>:LIMit<DirectionalChannel>:LOWer:STATe.....	224
CALCulate<Measurement>:LIMit<DirectionalChannel>:LOWer[:DATA].....	221
CALCulate<Measurement>:LIMit<DirectionalChannel>:LOWer[:DATA]:CCDF.....	221
CALCulate<Measurement>:LIMit<DirectionalChannel>:LOWer[:DATA]:POWER.....	224
CALCulate<Measurement>:LIMit<DirectionalChannel>:LOWer[:DATA]:RATio:RCOefficient.....	222
CALCulate<Measurement>:LIMit<DirectionalChannel>:LOWer[:DATA]:RATio:RFRatio.....	222
CALCulate<Measurement>:LIMit<DirectionalChannel>:LOWer[:DATA]:RATio:RLOSs.....	222
CALCulate<Measurement>:LIMit<DirectionalChannel>:LOWer[:DATA]:RATio:SWR.....	223
CALCulate<Measurement>:LIMit<DirectionalChannel>:LOWer[:DATA]:RATio[:VALue].....	223
CALCulate<Measurement>:LIMit<DirectionalChannel>:UPPer:STATe.....	228
CALCulate<Measurement>:LIMit<DirectionalChannel>:UPPer[:DATA].....	224
CALCulate<Measurement>:LIMit<DirectionalChannel>:UPPer[:DATA]:CCDF.....	225
CALCulate<Measurement>:LIMit<DirectionalChannel>:UPPer[:DATA]:POWER.....	227
CALCulate<Measurement>:LIMit<DirectionalChannel>:UPPer[:DATA]:RATio:RCOefficient.....	225
CALCulate<Measurement>:LIMit<DirectionalChannel>:UPPer[:DATA]:RATio:RFRatio.....	225
CALCulate<Measurement>:LIMit<DirectionalChannel>:UPPer[:DATA]:RATio:RLOSs.....	226
CALCulate<Measurement>:LIMit<DirectionalChannel>:UPPer[:DATA]:RATio:SWR.....	226
CALCulate<Measurement>:LIMit<DirectionalChannel>:UPPer[:DATA]:RATio[:VALue].....	227
CALCulate<Measurement>:LIMit<undef>:BEEP[:STATe].....	424
CALCulate<Measurement>:LIMit<undef>:CLEar:AUTO.....	220
CALCulate<Measurement>:LIMit<undef>:CLEar[:IMMEDIATE].....	220
CALCulate<Measurement>:LIMit<undef>:FAIL?.....	220
CALCulate<Measurement>:LIMit<undef>:FCOunt?.....	221
CALCulate<Measurement>:LIMit<undef>:TYPE.....	200
CALCulate<Measurement>:LIMit<undef>[:STATe].....	200
CALCulate<Measurement>:MATH[:EXPRession].....	328
CALCulate<Measurement>:MATH[:EXPRession]:CATalog?.....	329
CALCulate<Measurement>:MAXimum:DATA?.....	327
CALCulate<Measurement>:MEAN:DATA?.....	327
CALCulate<Measurement>:METer<DirectionalChannel>:LOWer[:DATA]:CCDF.....	205
CALCulate<Measurement>:METer<DirectionalChannel>:LOWer[:DATA]:RATio:RCOefficient.....	205
CALCulate<Measurement>:METer<DirectionalChannel>:LOWer[:DATA]:RATio:RFRatio.....	205
CALCulate<Measurement>:METer<DirectionalChannel>:LOWer[:DATA]:RATio:RLOSs.....	206
CALCulate<Measurement>:METer<DirectionalChannel>:LOWer[:DATA]:RATio:SWR.....	206
CALCulate<Measurement>:METer<DirectionalChannel>:LOWer[:DATA]:RATio[:VALue].....	207
CALCulate<Measurement>:METer<DirectionalChannel>:LOWer[:DATA][:POWER].....	207
CALCulate<Measurement>:METer<DirectionalChannel>:UPPer[:DATA]:CCDF.....	208
CALCulate<Measurement>:METer<DirectionalChannel>:UPPer[:DATA]:RATio:RCOefficient.....	208
CALCulate<Measurement>:METer<DirectionalChannel>:UPPer[:DATA]:RATio:RFRatio.....	208
CALCulate<Measurement>:METer<DirectionalChannel>:UPPer[:DATA]:RATio:RLOSs.....	209
CALCulate<Measurement>:METer<DirectionalChannel>:UPPer[:DATA]:RATio:SWR.....	209
CALCulate<Measurement>:METer<DirectionalChannel>:UPPer[:DATA]:RATio[:VALue].....	210
CALCulate<Measurement>:METer<DirectionalChannel>:UPPer[:DATA][:POWER].....	210
CALCulate<Measurement>:MINimum:DATA?.....	327
CALCulate<Measurement>:PTPeak:DATA?.....	327
CALCulate<Measurement>:RELative<DirectionalChannel>:CCDF.....	320

CALCulate<Measurement>:RELative<DirectionalChannel>:POWer[:MAGNitude]	320
CALCulate<Measurement>:RELative<DirectionalChannel>:RATio:RCoefficient	321
CALCulate<Measurement>:RELative<DirectionalChannel>:RATio:RFRatio	321
CALCulate<Measurement>:RELative<DirectionalChannel>:RATio:RLOSSs	321
CALCulate<Measurement>:RELative<DirectionalChannel>:RATio:SWR	322
CALCulate<Measurement>:RELative<DirectionalChannel>:RATio[:MAGNitude]	322
CALCulate<Measurement>:RELative<DirectionalChannel>:STATe	244
CALCulate<Measurement>:RELative<DirectionalChannel>[:MAGNitude]	243
CALCulate<Measurement>:RELative<DirectionalChannel>[:MAGNitude]:AUTO	243
CALCulate<Measurement>:RESolution	200
CALCulate<Measurement>:SDEViation:DATA?	327
CALCulate<Measurement>:STATistics:APERture	312
CALCulate<Measurement>:STATistics:AWGN[:STATe]	312
CALCulate<Measurement>:STATistics:MARKer:HORizontal:DATA?	317
CALCulate<Measurement>:STATistics:MARKer:HORizontal:POSition[:X][:POWer]	424
CALCulate<Measurement>:STATistics:MARKer:VERTical:DATA[:POWer]?	318
CALCulate<Measurement>:STATistics:MARKer:VERTical:POSition[:Y]	424
CALCulate<Measurement>:STATistics:MARKer:X:POSition:RELative	318
CALCulate<Measurement>:STATistics:MARKer:X:POSition[:ABSolute]	318
CALCulate<Measurement>:STATistics:PDF:MARKer:Y:POSition	319
CALCulate<Measurement>:STATistics:PDF[:SCALE]:Y:PDIVision	313
CALCulate<Measurement>:STATistics:PDF[:SCALE]:Y:TOP	314
CALCulate<Measurement>:STATistics:POWer:AVG:DATA?	311
CALCulate<Measurement>:STATistics:SAMPles[:MINimum]	312
CALCulate<Measurement>:STATistics:TGATe:SElection	312
CALCulate<Measurement>:STATistics[:CDF]:MARKer:Y:POSition	317
CALCulate<Measurement>:STATistics[:CDF][:SCALE]:Y[:LINear]:PDIVision	314
CALCulate<Measurement>:STATistics[:CDF][:SCALE]:Y[:LINear]:TOP	314
CALCulate<Measurement>:STATistics[:SCALE]:X:MODE	315
CALCulate<Measurement>:STATistics[:SCALE]:X:POINts	315
CALCulate<Measurement>:STATistics[:SCALE]:X:RANGe	316
CALCulate<Measurement>:STATistics[:SCALE]:X:RLEVel:RELative	316
CALCulate<Measurement>:STATistics[:SCALE]:X:RLEVel[:ABSolute]	316
CALCulate<Measurement>:STATistics[:SCALE]:Y:SPACing	317
CALCulate<Measurement>:TRACe:MARKer<Marker>:XDELta?	272
CALCulate<Measurement>:TRACe:MARKer<Marker>:XPOSition	425
CALCulate<Measurement>:TRACe:MARKer<Marker>:YDELta?	272
CALCulate<Measurement>:TRACe:MARKer<Marker>:YPOSition?	272
CALCulate<Measurement>:TRACe:MEASurement:ALGorithm	281
CALCulate<Measurement>:TRACe:MEASurement:DEFine:DURation:REFerence	282
CALCulate<Measurement>:TRACe:MEASurement:DEFine:TRANsition:HREFerence	282
CALCulate<Measurement>:TRACe:MEASurement:DEFine:TRANsition:LREFerence	282
CALCulate<Measurement>:TRACe:MEASurement:POWer:AVG?	283
CALCulate<Measurement>:TRACe:MEASurement:POWer:HREFerence?	283
CALCulate<Measurement>:TRACe:MEASurement:POWer:LREFerence?	283
CALCulate<Measurement>:TRACe:MEASurement:POWer:MAX?	283
CALCulate<Measurement>:TRACe:MEASurement:POWer:MIN?	284
CALCulate<Measurement>:TRACe:MEASurement:POWer:PULSe:BASE?	284
CALCulate<Measurement>:TRACe:MEASurement:POWer:PULSe:TOP?	284
CALCulate<Measurement>:TRACe:MEASurement:POWer:REFerence?	284

CALCulate<Measurement>:TRACe:MEASurement:PULSe:DCYClE?	285
CALCulate<Measurement>:TRACe:MEASurement:PULSe:DURation?	285
CALCulate<Measurement>:TRACe:MEASurement:PULSe:PERiod?	285
CALCulate<Measurement>:TRACe:MEASurement:PULSe:SEPARation?	286
CALCulate<Measurement>:TRACe:MEASurement:TRANSition:ESAMpling:AUTO[:STATe]	335
CALCulate<Measurement>:TRACe:MEASurement:TRANSition:NEGative:DURation?	286
CALCulate<Measurement>:TRACe:MEASurement:TRANSition:NEGative:OCCurrence?	286
CALCulate<Measurement>:TRACe:MEASurement:TRANSition:NEGative:OVERshoot?	286
CALCulate<Measurement>:TRACe:MEASurement:TRANSition:POSitive:DURation?	287
CALCulate<Measurement>:TRACe:MEASurement:TRANSition:POSitive:OCCurrence?	287
CALCulate<Measurement>:TRACe:MEASurement:TRANSition:POSitive:OVERshoot?	287
CALCulate<Measurement>:TRACe:MEASurement:TRANSition:SPERiod?	288
CALCulate<Measurement>:TRACe:X:POINts	271
CALCulate<Measurement>:TRACe:X[:SCALE]:LEFT	211
CALCulate<Measurement>:TRACe:X[:SCALE]:LENGth	211
CALCulate<Measurement>:TRACe:Y[:SCALE]:SPAN:DB	211
CALCulate<Measurement>:TRACe:Y[:SCALE]:SPAN:DBM	212
CALCulate<Measurement>:TRACe:Y[:SCALE]:SPAN:DBUV	212
CALCulate<Measurement>:TRACe:Y[:SCALE]:SPAN:DPCT	212
CALCulate<Measurement>:TRACe:Y[:SCALE]:SPAN:ONE	212
CALCulate<Measurement>:TRACe:Y[:SCALE]:SPAN:WATT	213
CALCulate<Measurement>:TRACe:Y[:SCALE]:TOP:DB	213
CALCulate<Measurement>:TRACe:Y[:SCALE]:TOP:DBM	213
CALCulate<Measurement>:TRACe:Y[:SCALE]:TOP:DBUV	214
CALCulate<Measurement>:TRACe:Y[:SCALE]:TOP:DPCT	214
CALCulate<Measurement>:TRACe:Y[:SCALE]:TOP:ONE	214
CALCulate<Measurement>:TRACe:Y[:SCALE]:TOP:WATT	215
CALCulate<Measurement>:TSLot:TIMing:EXCLude:STARt	306
CALCulate<Measurement>:TSLot:TIMing:EXCLude:STOP	307
CALCulate<Measurement>:TYPE	241
CALCulate<Measurement>[:CHANnel<Channel>]:AVERAge:COUNT:AUTO:MTIME	342
CALCulate<Measurement>[:CHANnel<Channel>]:AVERAge:COUNT:AUTO:NSRatIo	342
CALCulate<Measurement>[:CHANnel<Channel>]:AVERAge:COUNT:AUTO:SLOT	342
CALCulate<Measurement>[:CHANnel<Channel>]:AVERAge:COUNT:AUTO:TYPE	343
CALCulate<Measurement>[:CHANnel<Channel>]:AVERAge:COUNT:AUTO[:STATe]	373
CALCulate<Measurement>[:CHANnel<Channel>]:AVERAge:COUNT:ENUM	374
CALCulate<Measurement>[:CHANnel<Channel>]:AVERAge:COUNT[:VALue]	374
CALCulate<Measurement>[:CHANnel<Channel>]:AVERAge:TCONtrol:AUTO	343
CALCulate<Measurement>[:CHANnel<Channel>]:AVERAge:TCONtrol[:ENUM]	344
CALCulate<Measurement>[:CHANnel<Channel>]:AVERAge:TYPE	345
CALCulate<Measurement>[:CHANnel<Channel>]:AVERAge[:STATe]	345
CALCulate<Measurement>[:CHANnel<Channel>]:BURSt:TIMing:EXCLude:STARt	331
CALCulate<Measurement>[:CHANnel<Channel>]:BURSt:TIMing:EXCLude:STOP	332
CALCulate<Measurement>[:CHANnel<Channel>]:CORRection:DCYClE:STATe	332
CALCulate<Measurement>[:CHANnel<Channel>]:CORRection:DCYClE[:VALue]	332
CALCulate<Measurement>[:CHANnel<Channel>]:CORRection:OFFSet:RPLane	371
CALCulate<Measurement>[:CHANnel<Channel>]:CORRection:OFFSet:STATe	337
CALCulate<Measurement>[:CHANnel<Channel>]:CORRection:OFFSet:TABLE:INDEX	338
CALCulate<Measurement>[:CHANnel<Channel>]:CORRection:OFFSet:TABLE[:STATe]	338
CALCulate<Measurement>[:CHANnel<Channel>]:CORRection:OFFSet[:MAGNitude]	339

CALCulate<Measurement>[:CHANnel<Channel>]:FEED<Channel>.....	239
CALCulate<Measurement>[:CHANnel<Channel>]:INPut:ATTenuation:AUTO.....	348
CALCulate<Measurement>[:CHANnel<Channel>]:INPut:ATTenuation[:VALue].....	349
CALCulate<Measurement>[:CHANnel<Channel>]:NRT:APERture:MODE.....	374
CALCulate<Measurement>[:CHANnel<Channel>]:NRT:APERture[:VALue].....	375
CALCulate<Measurement>[:CHANnel<Channel>]:NRT:BURSt:MODE.....	367
CALCulate<Measurement>[:CHANnel<Channel>]:NRT:BURSt:PERiod.....	367
CALCulate<Measurement>[:CHANnel<Channel>]:NRT:BURSt:WIDTh.....	368
CALCulate<Measurement>[:CHANnel<Channel>]:NRT:CCDF:THReshold.....	368
CALCulate<Measurement>[:CHANnel<Channel>]:NRT:DIRectIon.....	368
CALCulate<Measurement>[:CHANnel<Channel>]:NRT:DMODulation:WCDMa:CRATe.....	372
CALCulate<Measurement>[:CHANnel<Channel>]:NRT:DMODulation[:VALue].....	371
CALCulate<Measurement>[:CHANnel<Channel>]:NRT:PEP:HOLD:TIME.....	369
CALCulate<Measurement>[:CHANnel<Channel>]:NRT:VBWidTh[:VALue].....	375
CALCulate<Measurement>[:CHANnel<Channel>]:ROSCillator:REFio:FREQUency.....	364
CALCulate<Measurement>[:CHANnel<Channel>]:ROSCillator:REFio:OUTPut[:STATe].....	364
CALCulate<Measurement>[:CHANnel<Channel>]:ROSCillator:SOURce.....	365
CALCulate<Measurement>[:CHANnel<Channel>]:SAMPling.....	333
CALCulate<Measurement>[:CHANnel<Channel>]:SENSe:INDeX.....	242
CALCulate<Measurement>[:CHANnel<Channel>]:SGAMma:CORRection:STATe.....	339
CALCulate<Measurement>[:CHANnel<Channel>]:SGAMma:PHASe.....	339
CALCulate<Measurement>[:CHANnel<Channel>]:SGAMma[:MAGNitude].....	340
CALCulate<Measurement>[:CHANnel<Channel>]:TRACe:AVERage:COUNT[:VALue].....	345
CALCulate<Measurement>[:CHANnel<Channel>]:TRACe:AVERage:TCONtrol:AUTO.....	346
CALCulate<Measurement>[:CHANnel<Channel>]:TRACe:AVERage:TCONtrol[:ENUM].....	346
CALCulate<Measurement>[:CHANnel<Channel>]:TRACe:AVERage[:STATe].....	347
CALCulate<Measurement>[:CHANnel<Channel>]:TRACe:ESAMPling.....	333
CALCulate<Measurement>[:CHANnel<Channel>][:POWer]:BURSt:DTOLerance.....	334
CALCulate<Measurement>[:CHANnel<Channel>][:POWer]:NCORrection[:STATe].....	347
CALCulate<Measurement>[:CHANnel<Channel>][:POWer]:VBWidTh:ENUM.....	348
CALCulate<Measurement>[:CHANnel<Channel>][:POWer][:AVG]:APERture[:VALue].....	334
CALCulate<Measurement>[:CHANnel<Channel>][:POWer][:AVG]:RANGe:AUTO.....	349
CALCulate<Measurement>[:CHANnel<Channel>][:POWer][:AVG]:RANGe:CLEVel:STATe.....	350
CALCulate<Measurement>[:CHANnel<Channel>][:POWer][:AVG]:RANGe:CLEVel[:VALue].....	350
CALCulate<Measurement>[:CHANnel<Channel>][:POWer][:AVG]:RANGe[:VALue].....	350
CALCulate<Measurement>[:CHANnel<Channel>][:POWer][:AVG]:SMOothing[:STATe].....	335
CALCulate<Measurement>[:POWer]:TGATe<Gate>[:AVG]:OFFSet[:TIME].....	295
CALCulate<Measurement>[:POWer]:TGATe<Gate>[:AVG]:TIME.....	295
CALCulate<Measurement>[:POWer]:TGATe<Gate>[:AVG][:EXCLude]:MID:OFFSet[:TIME].....	295
CALCulate<Measurement>[:POWer]:TGATe<Gate>[:AVG][:EXCLude]:MID:TIME.....	296
CALCulate<Measurement>[:POWer]:TGATe<Gate>[:AVG][:EXCLude]:MID[:STATe].....	296
CALCulate<Measurement>[:POWer]:TGATe<Undef>[:AVG]:SELection.....	297
CALCulate<Measurement>[:POWer]:TSLot[:AVG]:COUNT.....	307
CALCulate<Measurement>[:POWer]:TSLot[:AVG]:SELection.....	307
CALCulate<Measurement>[:POWer]:TSLot[:AVG]:WIDTh.....	307
CALCulate<Measurement>[:POWer]:TSLot[:AVG][:EXCLude]:MID:OFFSet[:TIME].....	308
CALCulate<Measurement>[:POWer]:TSLot[:AVG][:EXCLude]:MID:TIME.....	308
CALCulate<Measurement>[:POWer]:TSLot[:AVG][:EXCLude]:MID[:STATe].....	308
CALibration<Sensor>:TEST:DEVIation?.....	390
CALibration<Sensor>:TEST:REFerence?.....	390

CALibration<Sensor>:TEST?	390
CALibration<Sensor>:ZERO	387
CALibration<Sensor>:ZERO:AUTO	388
CALibration<Sensor>:ZERO:FAST:AUTO	389
CALibration<undef>:ALL:ZERO:AUTO	388
CALibration<undef>:ALL:ZERO:FAST:AUTO	389
CONFigure<Measurement>:ARRay[:POWER][:AVG]:DIFFerence:RELative?	253
CONFigure<Measurement>:ARRay[:POWER][:AVG]:DIFFerence?	253
CONFigure<Measurement>:ARRay[:POWER][:AVG]:RATio:RELative?	254
CONFigure<Measurement>:ARRay[:POWER][:AVG]:RATio?	254
CONFigure<Measurement>:ARRay[:POWER][:AVG]:REFLectioN?	255
CONFigure<Measurement>:ARRay[:POWER][:AVG]:RELative?	255
CONFigure<Measurement>:ARRay[:POWER][:AVG]:RLOSs?	256
CONFigure<Measurement>:ARRay[:POWER][:AVG]:SUM:RELative?	257
CONFigure<Measurement>:ARRay[:POWER][:AVG]:SUM?	257
CONFigure<Measurement>:ARRay[:POWER][:AVG]:SWR?	258
CONFigure<Measurement>:ARRay[:POWER][:AVG]?	252
CONFigure<Measurement>:STATistics:CCDF?	309
CONFigure<Measurement>:STATistics:PDF?	310
CONFigure<Measurement>:XTIME[:POWER]:NONE	270
CONFigure<Measurement>:XTIME[:POWER]:RATio?	270
CONFigure<Measurement>:XTIME[:POWER]?	269
CONFigure<Measurement>[:SCALar][:POWER]:BURSt:DIFFerence:RELative?	263
CONFigure<Measurement>[:SCALar][:POWER]:BURSt:DIFFerence?	262
CONFigure<Measurement>[:SCALar][:POWER]:BURSt:RATio:RELative?	266
CONFigure<Measurement>[:SCALar][:POWER]:BURSt:RATio?	265
CONFigure<Measurement>[:SCALar][:POWER]:BURSt:REFLectioN?	267
CONFigure<Measurement>[:SCALar][:POWER]:BURSt:RELative?	262
CONFigure<Measurement>[:SCALar][:POWER]:BURSt:RLOSs?	268
CONFigure<Measurement>[:SCALar][:POWER]:BURSt:SUM:RELative?	264
CONFigure<Measurement>[:SCALar][:POWER]:BURSt:SUM?	264
CONFigure<Measurement>[:SCALar][:POWER]:BURSt:SWR?	267
CONFigure<Measurement>[:SCALar][:POWER]:BURSt?	261
CONFigure<Measurement>[:SCALar][:POWER]:TSLot:DIFFerence:RELative?	300
CONFigure<Measurement>[:SCALar][:POWER]:TSLot:DIFFerence?	299
CONFigure<Measurement>[:SCALar][:POWER]:TSLot:RATio:RELative?	303
CONFigure<Measurement>[:SCALar][:POWER]:TSLot:RATio?	302
CONFigure<Measurement>[:SCALar][:POWER]:TSLot:REFLectioN?	305
CONFigure<Measurement>[:SCALar][:POWER]:TSLot:RELative?	299
CONFigure<Measurement>[:SCALar][:POWER]:TSLot:RLOSs?	305
CONFigure<Measurement>[:SCALar][:POWER]:TSLot:SUM:RELative?	302
CONFigure<Measurement>[:SCALar][:POWER]:TSLot:SUM?	301
CONFigure<Measurement>[:SCALar][:POWER]:TSLot:SWR?	304
CONFigure<Measurement>[:SCALar][:POWER]:TSLot?	298
CONFigure<Measurement>[:SCALar][:POWER][:AVG]:DIFFerence:RELative?	247
CONFigure<Measurement>[:SCALar][:POWER][:AVG]:DIFFerence?	247
CONFigure<Measurement>[:SCALar][:POWER][:AVG]:RATio:RELative?	249
CONFigure<Measurement>[:SCALar][:POWER][:AVG]:RATio?	249
CONFigure<Measurement>[:SCALar][:POWER][:AVG]:REFLectioN?	251
CONFigure<Measurement>[:SCALar][:POWER][:AVG]:RELative?	246

CONFigure<Measurement>[:SCALar][:POWer][:AVG]:RLOSs?	251
CONFigure<Measurement>[:SCALar][:POWer][:AVG]:SUM:RELative?	248
CONFigure<Measurement>[:SCALar][:POWer][:AVG]:SUM?	248
CONFigure<Measurement>[:SCALar][:POWer][:AVG]:SWR?	250
CONFigure<Measurement>[:SCALar][:POWer][:AVG]?	246
DIAGnostic:INFO:OTIME?	391
DISPlay:BRIGhtness	201
DISPlay:ERRorlist	201
DISPlay:ILLuminatiOn	425
DISPlay:LAYout	201
DISPlay:MESSage:TEXT:CLEar	201
DISPlay:MESSage:TEXT[:DATA]	201
DISPlay:MESSage:TYPE	202
DISPlay:MESSage[:STATe]	202
DISPlay:OVERload[:STATe]	202
DISPlay:PIXMap?	203
DISPlay:UPDate	203
DISPlay[:WINDow<Undef>]:SElect	426
DISPlay[:WINDow<Undef>]:SIZE	426
DISPlay[:WINDow<Window>]:ANALog:AUTO	215
DISPlay[:WINDow<Window>]:ANALog:LOWer	215
DISPlay[:WINDow<Window>]:ANALog:LOWer:POWer	426
DISPlay[:WINDow<Window>]:ANALog:LOWer:RATio	426
DISPlay[:WINDow<Window>]:ANALog:UPPer	216
DISPlay[:WINDow<Window>]:ANALog:UPPer:POWer	427
DISPlay[:WINDow<Window>]:ANALog:UPPer:RATio	427
DISPlay[:WINDow<Window>]:AVALue	427
DISPlay[:WINDow<Window>]:FORMat	427
DISPlay[:WINDow<Window>]:METer:AUTO	215
DISPlay[:WINDow<Window>]:METer:LOWer	215
DISPlay[:WINDow<Window>]:METer:LOWer:POWer	428
DISPlay[:WINDow<Window>]:METer:LOWer:RATio	428
DISPlay[:WINDow<Window>]:METer:UPPer	216
DISPlay[:WINDow<Window>]:METer:UPPer:POWer	428
DISPlay[:WINDow<Window>]:METer:UPPer:RATio	429
DISPlay[:WINDow<Window>]:POSition	203
DISPlay[:WINDow<Window>]:TRACe:LOWer	429
DISPlay[:WINDow<Window>]:TRACe:MARKer<Marker>:FEED:INDex	272
DISPlay[:WINDow<Window>]:TRACe:MARKer<Marker>:FUNCTION	273
DISPlay[:WINDow<Window>]:TRACe:MARKer<Marker>:MODE	274
DISPlay[:WINDow<Window>]:TRACe:MARKer<Marker>:POSition:MODE	274
DISPlay[:WINDow<Window>]:TRACe:MARKer<Marker>:POSition:POWer:DBM	275
DISPlay[:WINDow<Window>]:TRACe:MARKer<Marker>:POSition:POWer:DBUV	275
DISPlay[:WINDow<Window>]:TRACe:MARKer<Marker>:POSition:POWer:RATio:DB	276
DISPlay[:WINDow<Window>]:TRACe:MARKer<Marker>:POSition:POWer:RATio:DPCT	276
DISPlay[:WINDow<Window>]:TRACe:MARKer<Marker>:POSition:POWer:RATio:O	277
DISPlay[:WINDow<Window>]:TRACe:MARKer<Marker>:POSition:POWer:WATT	277
DISPlay[:WINDow<Window>]:TRACe:MARKer<Marker>:POSition:RELative:POWer:DB	276
DISPlay[:WINDow<Window>]:TRACe:MARKer<Marker>:POSition:RELative:POWer:DPCT	276
DISPlay[:WINDow<Window>]:TRACe:MARKer<Marker>:POSition:RELative:POWer:O	277

DISPlay[:WINDow<Window>]:TRACe:MARKer<Marker>:POSition:RELative:POWer:WATT.....	277
DISPlay[:WINDow<Window>]:TRACe:MARKer<Marker>:POSition:RELative:TIME.....	278
DISPlay[:WINDow<Window>]:TRACe:MARKer<Marker>:POSition:TIME.....	278
DISPlay[:WINDow<Window>]:TRACe:MARKer<Marker>:REFerence.....	278
DISPlay[:WINDow<Window>]:TRACe:MARKer<Undef>:SELection.....	278
DISPlay[:WINDow<Window>]:TRACe:MEASurement:POWer:AVG[:STATe].....	288
DISPlay[:WINDow<Window>]:TRACe:MEASurement:POWer:MAXimum[:STATe].....	288
DISPlay[:WINDow<Window>]:TRACe:MEASurement:POWer:MINimum[:STATe].....	289
DISPlay[:WINDow<Window>]:TRACe:MEASurement:POWer:PULSe:BASE[:STATe].....	289
DISPlay[:WINDow<Window>]:TRACe:MEASurement:POWer:PULSe:HREFerence[:STATe].....	289
DISPlay[:WINDow<Window>]:TRACe:MEASurement:POWer:PULSe:LREFerence[:STATe].....	290
DISPlay[:WINDow<Window>]:TRACe:MEASurement:POWer:PULSe:TOP[:STATe].....	290
DISPlay[:WINDow<Window>]:TRACe:MEASurement:PULSe:DCYClE[:STATe].....	290
DISPlay[:WINDow<Window>]:TRACe:MEASurement:PULSe:DURation[:STATe].....	291
DISPlay[:WINDow<Window>]:TRACe:MEASurement:PULSe:PERiod[:STATe].....	291
DISPlay[:WINDow<Window>]:TRACe:MEASurement:PULSe:RESolution[:STATe].....	291
DISPlay[:WINDow<Window>]:TRACe:MEASurement:PULSe:SEPARation[:STATe].....	292
DISPlay[:WINDow<Window>]:TRACe:MEASurement:RRELation.....	292
DISPlay[:WINDow<Window>]:TRACe:MEASurement:SELection.....	292
DISPlay[:WINDow<Window>]:TRACe:MEASurement:TRANSition:NEGative:DURation[:STATe].....	293
DISPlay[:WINDow<Window>]:TRACe:MEASurement:TRANSition:NEGative:OCCurrence[:STATe].....	293
DISPlay[:WINDow<Window>]:TRACe:MEASurement:TRANSition:NEGative:OVERshoot[:STATe].....	293
DISPlay[:WINDow<Window>]:TRACe:MEASurement:TRANSition:POSitive:DURation[:STATe].....	294
DISPlay[:WINDow<Window>]:TRACe:MEASurement:TRANSition:POSitive:OCCurrence[:STATe].....	294
DISPlay[:WINDow<Window>]:TRACe:MEASurement:TRANSition:POSitive:OVERshoot[:STATe].....	294
DISPlay[:WINDow<Window>]:TRACe:UPPer.....	430
DISPlay[:WINDow<Window>]:TSLot.....	430
DISPlay[:WINDow<Window>][:NUMeric<Numeric>]:RESolution.....	429
DISPlay[:WINDow<Window>][:STATe].....	203
FETCh<Measurement>:ARRay[:POWer][:AVG]:DIFFerence:RELative?.....	253
FETCh<Measurement>:ARRay[:POWer][:AVG]:DIFFerence?.....	253
FETCh<Measurement>:ARRay[:POWer][:AVG]:RATio:RELative?.....	254
FETCh<Measurement>:ARRay[:POWer][:AVG]:RATio?.....	254
FETCh<Measurement>:ARRay[:POWer][:AVG]:REFLection?.....	255
FETCh<Measurement>:ARRay[:POWer][:AVG]:RELative?.....	255
FETCh<Measurement>:ARRay[:POWer][:AVG]:RLOSSs?.....	256
FETCh<Measurement>:ARRay[:POWer][:AVG]:SUM:RELative?.....	257
FETCh<Measurement>:ARRay[:POWer][:AVG]:SUM?.....	257
FETCh<Measurement>:ARRay[:POWer][:AVG]:SWR?.....	258
FETCh<Measurement>:ARRay[:POWer][:AVG]?.....	252
FETCh<Measurement>:STATistics:CCDF?.....	309
FETCh<Measurement>:STATistics:PDF?.....	310
FETCh<Measurement>:XTIME[:POWer]:RATio?.....	270
FETCh<Measurement>:XTIME[:POWer]?.....	269
FETCh<Measurement>[:SCALar][:POWer]:BURSt:DIFFerence:RELative?.....	263
FETCh<Measurement>[:SCALar][:POWer]:BURSt:DIFFerence?.....	262
FETCh<Measurement>[:SCALar][:POWer]:BURSt:RATio:RELative?.....	266
FETCh<Measurement>[:SCALar][:POWer]:BURSt:RATio?.....	265
FETCh<Measurement>[:SCALar][:POWer]:BURSt:REFLection?.....	267
FETCh<Measurement>[:SCALar][:POWer]:BURSt:RELative?.....	262

FETCh<Measurement>[:SCALar][:POWer]:BURSt:RLOSs?	268
FETCh<Measurement>[:SCALar][:POWer]:BURSt:SUM:RELative?	264
FETCh<Measurement>[:SCALar][:POWer]:BURSt:SUM?	264
FETCh<Measurement>[:SCALar][:POWer]:BURSt:SWR?	267
FETCh<Measurement>[:SCALar][:POWer]:BURSt?	261
FETCh<Measurement>[:SCALar][:POWer]:TSLot:DIFFerence:RELative?	300
FETCh<Measurement>[:SCALar][:POWer]:TSLot:DIFFerence?	299
FETCh<Measurement>[:SCALar][:POWer]:TSLot:RATio:RELative?	303
FETCh<Measurement>[:SCALar][:POWer]:TSLot:RATio?	302
FETCh<Measurement>[:SCALar][:POWer]:TSLot:REFLectioN?	305
FETCh<Measurement>[:SCALar][:POWer]:TSLot:RELative?	299
FETCh<Measurement>[:SCALar][:POWer]:TSLot:RLOSs?	305
FETCh<Measurement>[:SCALar][:POWer]:TSLot:SUM:RELative?	302
FETCh<Measurement>[:SCALar][:POWer]:TSLot:SUM?	301
FETCh<Measurement>[:SCALar][:POWer]:TSLot:SWR?	304
FETCh<Measurement>[:SCALar][:POWer]:TSLot?	298
FETCh<Measurement>[:SCALar][:POWer][:AVG]:DIFFerence:RELative?	247
FETCh<Measurement>[:SCALar][:POWer][:AVG]:DIFFerence?	247
FETCh<Measurement>[:SCALar][:POWer][:AVG]:RATio:RELative?	249
FETCh<Measurement>[:SCALar][:POWer][:AVG]:RATio?	249
FETCh<Measurement>[:SCALar][:POWer][:AVG]:REFLectioN?	251
FETCh<Measurement>[:SCALar][:POWer][:AVG]:RELative?	246
FETCh<Measurement>[:SCALar][:POWer][:AVG]:RLOSs?	251
FETCh<Measurement>[:SCALar][:POWer][:AVG]:SUM:RELative?	248
FETCh<Measurement>[:SCALar][:POWer][:AVG]:SUM?	248
FETCh<Measurement>[:SCALar][:POWer][:AVG]:SWR?	250
FETCh<Measurement>[:SCALar][:POWer][:AVG]?	246
FORMat:SREGister	228
FORMat[:READings]:BORDer	229
FORMat[:READings][:DATA]	228
INITiate<Measurement>:CONTinuous	194
INITiate<Measurement>:DISable	194
INITiate<Measurement>[:IMMediate]	195
INITiate<Undef>:ALL:CONTinuous	194
INITiate<Undef>:ALL:DISable	195
INITiate<Undef>:ALL[:IMMediate]	196
INPut<Sensor>:PORT:OFFSet	372
INPut<Sensor>:PORT:POSition	372
INPut<Sensor>:PORT:SOURce:AUTO	369
INPut<Sensor>:PORT:SOURce[:VALue]	370
INPut<undef>:TRIGger:IMPedance	378
MEASure<Measurement>:ARRay[:POWer][:AVG]:DIFFerence:RELative?	253
MEASure<Measurement>:ARRay[:POWer][:AVG]:DIFFerence?	253
MEASure<Measurement>:ARRay[:POWer][:AVG]:RATio:RELative?	254
MEASure<Measurement>:ARRay[:POWer][:AVG]:RATio?	254
MEASure<Measurement>:ARRay[:POWer][:AVG]:REFLectioN?	255
MEASure<Measurement>:ARRay[:POWer][:AVG]:RELative?	256
MEASure<Measurement>:ARRay[:POWer][:AVG]:RLOSs?	256
MEASure<Measurement>:ARRay[:POWer][:AVG]:SUM:RELative?	257
MEASure<Measurement>:ARRay[:POWer][:AVG]:SUM?	257

MEASure<Measurement>:ARRay[:POWer][:AVG]:SWR?	258
MEASure<Measurement>:ARRay[:POWer][:AVG]?	252
MEASure<Measurement>:STATistics:CCDF?	309
MEASure<Measurement>:STATistics:PDF?	310
MEASure<Measurement>:XTIME[:POWer]:RATio?	270
MEASure<Measurement>:XTIME[:POWer]?	269
MEASure<Measurement>[:SCALar][:POWer]:BURSt:DIFFerence:RELative?	263
MEASure<Measurement>[:SCALar][:POWer]:BURSt:DIFFerence?	262
MEASure<Measurement>[:SCALar][:POWer]:BURSt:RATio:RELative?	266
MEASure<Measurement>[:SCALar][:POWer]:BURSt:RATio?	265
MEASure<Measurement>[:SCALar][:POWer]:BURSt:REFLectioN?	267
MEASure<Measurement>[:SCALar][:POWer]:BURSt:RELative?	262
MEASure<Measurement>[:SCALar][:POWer]:BURSt:RLOSs?	268
MEASure<Measurement>[:SCALar][:POWer]:BURSt:SUM:RELative?	265
MEASure<Measurement>[:SCALar][:POWer]:BURSt:SUM?	264
MEASure<Measurement>[:SCALar][:POWer]:BURSt:SWR?	267
MEASure<Measurement>[:SCALar][:POWer]:BURSt?	261
MEASure<Measurement>[:SCALar][:POWer]:TSLot:DIFFerence:RELative?	300
MEASure<Measurement>[:SCALar][:POWer]:TSLot:DIFFerence?	299
MEASure<Measurement>[:SCALar][:POWer]:TSLot:RATio:RELative?	303
MEASure<Measurement>[:SCALar][:POWer]:TSLot:RATio?	302
MEASure<Measurement>[:SCALar][:POWer]:TSLot:REFLectioN?	305
MEASure<Measurement>[:SCALar][:POWer]:TSLot:RELative?	299
MEASure<Measurement>[:SCALar][:POWer]:TSLot:RLOSs?	305
MEASure<Measurement>[:SCALar][:POWer]:TSLot:SUM:RELative?	302
MEASure<Measurement>[:SCALar][:POWer]:TSLot:SUM?	301
MEASure<Measurement>[:SCALar][:POWer]:TSLot:SWR?	304
MEASure<Measurement>[:SCALar][:POWer]:TSLot?	298
MEASure<Measurement>[:SCALar][:POWer][:AVG]:DIFFerence:RELative?	247
MEASure<Measurement>[:SCALar][:POWer][:AVG]:DIFFerence?	247
MEASure<Measurement>[:SCALar][:POWer][:AVG]:RATio:RELative?	250
MEASure<Measurement>[:SCALar][:POWer][:AVG]:RATio?	249
MEASure<Measurement>[:SCALar][:POWer][:AVG]:REFLectioN?	251
MEASure<Measurement>[:SCALar][:POWer][:AVG]:RELative?	246
MEASure<Measurement>[:SCALar][:POWer][:AVG]:RLOSs?	251
MEASure<Measurement>[:SCALar][:POWer][:AVG]:SUM:RELative?	248
MEASure<Measurement>[:SCALar][:POWer][:AVG]:SUM?	248
MEASure<Measurement>[:SCALar][:POWer][:AVG]:SWR?	250
MEASure<Measurement>[:SCALar][:POWer][:AVG]?	246
MEMory:CATalog:STATe?	393
MEMory:CATalog:TABLE?	393
MEMory:CATalog[:ALL]?	393
MEMory:CLEar:TABLE	394
MEMory:CLEar[:NAME]	394
MEMory:FREE:STATe?	394
MEMory:FREE:TABLE?	394
MEMory:FREE[:ALL]?	395
MEMory:NSTates?	395
MEMory:STATe:CATalog?	395
MEMory:STATe:DEFine	395

MEMory:STATe:MAP.....	395
MEMory:STATe:RESet.....	396
MEMory:TABLE:DATA:POINts?.....	396
MEMory:TABLE:DATA?.....	396
MEMory:TABLE:FREQuency.....	396
MEMory:TABLE:FREQuency:POINts?.....	397
MEMory:TABLE:GAIN:POINts?.....	397
MEMory:TABLE:GAIN[:MAGNitude].....	397
MEMory:TABLE:MAP.....	397
MEMory:TABLE:MOVE.....	398
MEMory:TABLE:RESet.....	398
MEMory:TABLE:SElect.....	398
OUTPut:LIMit:FAIL.....	379
OUTPut:LIMit:FEED:INDex.....	379
OUTPut:MODE<output>.....	379
OUTPut:REcorder<output>:FEED:INDex.....	380
OUTPut:REcorder<output>:FEED[:VALue].....	431
OUTPut:REcorder<output>:LIMit:LOWer:CCDF.....	381
OUTPut:REcorder<output>:LIMit:LOWer:POWer.....	381
OUTPut:REcorder<output>:LIMit:LOWer:RATio:RCoefficient.....	382
OUTPut:REcorder<output>:LIMit:LOWer:RATio:RFRatio.....	382
OUTPut:REcorder<output>:LIMit:LOWer:RATio:RLOSSs.....	382
OUTPut:REcorder<output>:LIMit:LOWer:RATio:SWR.....	383
OUTPut:REcorder<output>:LIMit:LOWer:RATio[:VALue].....	383
OUTPut:REcorder<output>:LIMit:LOWer[:VALue].....	381
OUTPut:REcorder<output>:LIMit:UPPer:CCDF.....	384
OUTPut:REcorder<output>:LIMit:UPPer:POWer.....	384
OUTPut:REcorder<output>:LIMit:UPPer:RATio:RCoefficient.....	385
OUTPut:REcorder<output>:LIMit:UPPer:RATio:RFRatio.....	385
OUTPut:REcorder<output>:LIMit:UPPer:RATio:RLOSSs.....	386
OUTPut:REcorder<output>:LIMit:UPPer:RATio:SWR.....	386
OUTPut:REcorder<output>:LIMit:UPPer:RATio[:VALue].....	386
OUTPut:REcorder<output>:LIMit:UPPer[:VALue].....	384
OUTPut:REcorder<output>[:STATe].....	431
OUTPut:ROSCillator[:STATe].....	431
OUTPut:SOURce:STATe.....	377
OUTPut:TRIGger:SOURce.....	387
OUTPut:TRIGger[:STATe].....	431
OUTPut:TTL<output>:ACTive.....	432
OUTPut:TTL<output>:FAIL.....	432
OUTPut:TTL<output>:FEED.....	432
OUTPut:TTL<output>[:STATe].....	432
READ<Measurement>:ARRay[:POWer][:AVG]:DIFFerence:RELative?.....	253
READ<Measurement>:ARRay[:POWer][:AVG]:DIFFerence?.....	253
READ<Measurement>:ARRay[:POWer][:AVG]:RATio:RELative?.....	254
READ<Measurement>:ARRay[:POWer][:AVG]:RATio?.....	254
READ<Measurement>:ARRay[:POWer][:AVG]:REFLection?.....	255
READ<Measurement>:ARRay[:POWer][:AVG]:RELative?.....	256
READ<Measurement>:ARRay[:POWer][:AVG]:RLOSSs?.....	256
READ<Measurement>:ARRay[:POWer][:AVG]:SUM:RELative?.....	257

READ<Measurement>:ARRay[:POWer][:AVG]:SUM?	257
READ<Measurement>:ARRay[:POWer][:AVG]:SWR?	258
READ<Measurement>:ARRay[:POWer][:AVG]?	252
READ<Measurement>:STATistics:CCDF?	309
READ<Measurement>:STATistics:PDF?	310
READ<Measurement>:XTIME[:POWer]:RATio?	270
READ<Measurement>:XTIME[:POWer]?	269
READ<Measurement>[:SCALar][:POWer]:BURSt:DIFFerence:RELative?	263
READ<Measurement>[:SCALar][:POWer]:BURSt:DIFFerence?	262
READ<Measurement>[:SCALar][:POWer]:BURSt:RATio:RELative?	266
READ<Measurement>[:SCALar][:POWer]:BURSt:RATio?	265
READ<Measurement>[:SCALar][:POWer]:BURSt:REFLection?	267
READ<Measurement>[:SCALar][:POWer]:BURSt:RELative?	262
READ<Measurement>[:SCALar][:POWer]:BURSt:RLOSs?	268
READ<Measurement>[:SCALar][:POWer]:BURSt:SUM:RELative?	265
READ<Measurement>[:SCALar][:POWer]:BURSt:SUM?	264
READ<Measurement>[:SCALar][:POWer]:BURSt:SWR?	267
READ<Measurement>[:SCALar][:POWer]:BURSt?	261
READ<Measurement>[:SCALar][:POWer]:TSLot:DIFFerence:RELative?	300
READ<Measurement>[:SCALar][:POWer]:TSLot:DIFFerence?	299
READ<Measurement>[:SCALar][:POWer]:TSLot:RATio:RELative?	303
READ<Measurement>[:SCALar][:POWer]:TSLot:RATio?	302
READ<Measurement>[:SCALar][:POWer]:TSLot:REFLection?	305
READ<Measurement>[:SCALar][:POWer]:TSLot:RELative?	299
READ<Measurement>[:SCALar][:POWer]:TSLot:RLOSs?	305
READ<Measurement>[:SCALar][:POWer]:TSLot:SUM:RELative?	302
READ<Measurement>[:SCALar][:POWer]:TSLot:SUM?	301
READ<Measurement>[:SCALar][:POWer]:TSLot:SWR?	304
READ<Measurement>[:SCALar][:POWer]:TSLot?	298
READ<Measurement>[:SCALar][:POWer][:AVG]:DIFFerence:RELative?	247
READ<Measurement>[:SCALar][:POWer][:AVG]:DIFFerence?	247
READ<Measurement>[:SCALar][:POWer][:AVG]:RATio:RELative?	250
READ<Measurement>[:SCALar][:POWer][:AVG]:RATio?	249
READ<Measurement>[:SCALar][:POWer][:AVG]:REFLection?	251
READ<Measurement>[:SCALar][:POWer][:AVG]:RELative?	246
READ<Measurement>[:SCALar][:POWer][:AVG]:RLOSs?	251
READ<Measurement>[:SCALar][:POWer][:AVG]:SUM:RELative?	248
READ<Measurement>[:SCALar][:POWer][:AVG]:SUM?	248
READ<Measurement>[:SCALar][:POWer][:AVG]:SWR?	250
READ<Measurement>[:SCALar][:POWer][:AVG]?	246
SENSe<Sensor>:SYSTem:FWUPdate	402
SENSe<Sensor>:SYSTem:FWUPdate:STATus?	402
SENSe<Sensor>:UNIT:POWer[:VALue]	217
SOURce:OUTPut:STATe	377
SOURce:POWer[:VALue]	377
SOURce:PULM:STATe	377
SOURce:UNIT:POWer	217
SOURce[:RF]:FREQUency[:VALue]	378
STATus:DEVice:CONDition?	420
STATus:DEVice:ENABle	421

STATus:DEVIce:NTRansition.....	422
STATus:DEVIce:PTRansition.....	423
STATus:DEVIce[:EVENT]?.....	421
STATus:OPERation:BIT<bitno>:CONDition?.....	420
STATus:OPERation:BIT<bitno>:ENABle.....	421
STATus:OPERation:BIT<bitno>:NTRansition.....	422
STATus:OPERation:BIT<bitno>:PTRansition.....	423
STATus:OPERation:BIT<bitno>[:EVENT]?.....	421
STATus:OPERation:CALibrating[:SUMMary]:CONDition?.....	420
STATus:OPERation:CALibrating[:SUMMary]:ENABle.....	421
STATus:OPERation:CALibrating[:SUMMary]:NTRansition.....	422
STATus:OPERation:CALibrating[:SUMMary]:PTRansition.....	423
STATus:OPERation:CALibrating[:SUMMary][:EVENT]?.....	421
STATus:OPERation:CONDition?.....	420
STATus:OPERation:ENABle.....	421
STATus:OPERation:LLFail<RegisterIndex>[:SUMMary]:CONDition?.....	420
STATus:OPERation:LLFail<RegisterIndex>[:SUMMary]:ENABle.....	421
STATus:OPERation:LLFail<RegisterIndex>[:SUMMary]:NTRansition.....	422
STATus:OPERation:LLFail<RegisterIndex>[:SUMMary]:PTRansition.....	423
STATus:OPERation:LLFail<RegisterIndex>[:SUMMary][:EVENT]?.....	421
STATus:OPERation:MEASuring:EXTension<RegisterIndex>:CONDition?.....	420
STATus:OPERation:MEASuring:EXTension<RegisterIndex>:ENABle.....	421
STATus:OPERation:MEASuring:EXTension<RegisterIndex>:NTRansition.....	422
STATus:OPERation:MEASuring:EXTension<RegisterIndex>:PTRansition.....	423
STATus:OPERation:MEASuring:EXTension<RegisterIndex>[:SUMMary][:EVENT]?.....	421
STATus:OPERation:MEASuring[:SUMMary]:CONDition?.....	420
STATus:OPERation:MEASuring[:SUMMary]:ENABle.....	421
STATus:OPERation:MEASuring[:SUMMary]:NTRansition.....	422
STATus:OPERation:MEASuring[:SUMMary]:PTRansition.....	423
STATus:OPERation:MEASuring[:SUMMary][:EVENT]?.....	421
STATus:OPERation:NTRansition.....	422
STATus:OPERation:PTRansition.....	423
STATus:OPERation:SENSe[:SUMMary]:CONDition?.....	420
STATus:OPERation:SENSe[:SUMMary]:ENABle.....	422
STATus:OPERation:SENSe[:SUMMary]:NTRansition.....	422
STATus:OPERation:SENSe[:SUMMary]:PTRansition.....	423
STATus:OPERation:SENSe[:SUMMary][:EVENT]?.....	421
STATus:OPERation:TRIGger:EXTension<RegisterIndex>:CONDition?.....	420
STATus:OPERation:TRIGger:EXTension<RegisterIndex>:ENABle.....	422
STATus:OPERation:TRIGger:EXTension<RegisterIndex>:NTRansition.....	422
STATus:OPERation:TRIGger:EXTension<RegisterIndex>:PTRansition.....	423
STATus:OPERation:TRIGger:EXTension<RegisterIndex>[:SUMMary][:EVENT]?.....	421
STATus:OPERation:TRIGger[:SUMMary]:CONDition?.....	420
STATus:OPERation:TRIGger[:SUMMary]:ENABle.....	422
STATus:OPERation:TRIGger[:SUMMary]:NTRansition.....	422
STATus:OPERation:TRIGger[:SUMMary]:PTRansition.....	423
STATus:OPERation:TRIGger[:SUMMary][:EVENT]?.....	421
STATus:OPERation:ULFail<RegisterIndex>[:SUMMary]:CONDition?.....	420
STATus:OPERation:ULFail<RegisterIndex>[:SUMMary]:ENABle.....	422
STATus:OPERation:ULFail<RegisterIndex>[:SUMMary]:NTRansition.....	422

STATus:OPERation:ULFail<RegisterIndex>[:SUMMARY]:PTRansition.....	423
STATus:OPERation:ULFail<RegisterIndex>[:SUMMARY][:EVENT]?	421
STATus:OPERation[:EVENT]?	421
STATus:PRESet.....	420
STATus:QUEStionable:BIT<bitno>:CONDition?	420
STATus:QUEStionable:BIT<bitno>:ENABle.....	422
STATus:QUEStionable:BIT<bitno>:NTRansition.....	422
STATus:QUEStionable:BIT<bitno>:PTRansition.....	423
STATus:QUEStionable:BIT<bitno>[:EVENT]?	421
STATus:QUEStionable:CALibration[:SUMMARY]:CONDition?	420
STATus:QUEStionable:CALibration[:SUMMARY]:ENABle.....	422
STATus:QUEStionable:CALibration[:SUMMARY]:NTRansition.....	422
STATus:QUEStionable:CALibration[:SUMMARY]:PTRansition.....	423
STATus:QUEStionable:CALibration[:SUMMARY][:EVENT]?	421
STATus:QUEStionable:CONDition?	420
STATus:QUEStionable:ENABle.....	422
STATus:QUEStionable:MEASure<RegisterIndex>:CONDition?	420
STATus:QUEStionable:MEASure<RegisterIndex>:ENABle.....	422
STATus:QUEStionable:MEASure<RegisterIndex>:NTRansition.....	422
STATus:QUEStionable:MEASure<RegisterIndex>:PTRansition.....	423
STATus:QUEStionable:MEASure<RegisterIndex>[:SUMMARY][:EVENT]?	421
STATus:QUEStionable:NTRansition.....	422
STATus:QUEStionable:POWer[:SUMMARY]:CONDition?	421
STATus:QUEStionable:POWer[:SUMMARY]:ENABle.....	422
STATus:QUEStionable:POWer[:SUMMARY]:NTRansition.....	422
STATus:QUEStionable:POWer[:SUMMARY]:PTRansition.....	423
STATus:QUEStionable:POWer[:SUMMARY][:EVENT]?	421
STATus:QUEStionable:PTRansition.....	423
STATus:QUEStionable:WINDow<RegisterIndex>:CONDition?	421
STATus:QUEStionable:WINDow<RegisterIndex>:ENABle.....	422
STATus:QUEStionable:WINDow<RegisterIndex>:NTRansition.....	422
STATus:QUEStionable:WINDow<RegisterIndex>:PTRansition.....	423
STATus:QUEStionable:WINDow<RegisterIndex>[:SUMMARY][:EVENT]?	421
STATus:QUEStionable[:EVENT]?	421
STATus:QUEue[:NEXT]?	420
SYSTem:COMMunicate:GPIB[:SELF]:ADDResS.....	406
SYSTem:COMMunicate:INET[:SELF]:ADDResS.....	403
SYSTem:COMMunicate:INET[:SELF]:DNS:ADDResS.....	403
SYSTem:COMMunicate:INET[:SELF]:DNS:SUFFix.....	404
SYSTem:COMMunicate:INET[:SELF]:GATeway:ADDResS.....	404
SYSTem:COMMunicate:INET[:SELF]:MODE.....	404
SYSTem:COMMunicate:INET[:SELF]:SUBNetmask:ADDResS.....	405
SYSTem:COMMunicate:NETWork:MACaddress?	405
SYSTem:COMMunicate:NETWork:REStart.....	405
SYSTem:COMMunicate:NETWork:STATus?	405
SYSTem:COMMunicate:NETWork[:COMMOn]:DOMain.....	404
SYSTem:COMMunicate:NETWork[:COMMOn]:HOSTname.....	405
SYSTem:COMMunicate:NETWork[:COMMOn]:WORKgroup.....	405
SYSTem:COMMunicate:NETWork[:IPADdress]:DNS.....	403
SYSTem:COMMunicate:NETWork[:IPADdress]:GATeway.....	404

SYSTem:COMMunicate:NETWork[:IPADdress]:MODE.....	404
SYSTem:COMMunicate:NETWork[:IPADdress]:SUBNet:MASK.....	405
SYSTem:COMMunicate:NETWork[:IPADdress][:ADDress].....	403
SYSTem:DATE.....	412
SYSTem:DATE:LOCal.....	413
SYSTem:DATE:UTC.....	412
SYSTem:DEvice:ID?.....	411
SYSTem:DFPRint.....	411
SYSTem:DFPRint:HISTory:COUNT?.....	411
SYSTem:DFPRint:HISTory:ENTRY?.....	411
SYSTem:DID?.....	411
SYSTem:ERRor:ALL?.....	417
SYSTem:ERRor:CODE:ALL?.....	417
SYSTem:ERRor:CODE[:NEXT]?.....	417
SYSTem:ERRor:COUNT?.....	418
SYSTem:ERRor:EXTended[:STATe].....	418
SYSTem:ERRor[:NEXT]?.....	418
SYSTem:FWUPdate.....	401
SYSTem:FWUPdate:STATus?.....	402
SYSTem:HCOPY.....	229
SYSTem:HELP:HEADers?.....	406
SYSTem:HELP:SYNTax:ALL?.....	407
SYSTem:HELP:SYNTax?.....	406
SYSTem:IDN:ANSWer.....	407
SYSTem:IDN:AUTO.....	407
SYSTem:IDN:MODE.....	407
SYSTem:INFO:TERMchar.....	411
SYSTem:INFO[:INFO]?.....	412
SYSTem:KLOCK.....	419
SYSTem:LANGuage.....	408
SYSTem:LOCK:SHARed:STRing?.....	419
SYSTem:LOCK:TIMEout.....	419
SYSTem:OPT:ANSWer.....	408
SYSTem:OPT:AUTO.....	408
SYSTem:OPT:MODE.....	409
SYSTem:PRESet.....	399
SYSTem:REBoot.....	400
SYSTem:SENSor<Sensor>:INFO?.....	409
SYSTem:SENSor<Sensor>:REBoot.....	400
SYSTem:SENSor<Sensor>:RESet.....	399
SYSTem:SENSor<Sensor>:TEST?.....	392
SYSTem:SERRor:LIST:ALL?.....	416
SYSTem:SERRor:LIST:NEXT?.....	416
SYSTem:SERRor:REMove.....	416
SYSTem:SERRor[:ALL]?.....	415
SYSTem:SHUTdown.....	400
SYSTem:SPEed.....	204
SYSTem:STANdard:CATalog?.....	351
SYSTem:STANdard:PRESet.....	351
SYSTem:STANdard:PWSettings.....	352

SYSTem:STANdard:TRIGger:SOURce.....	352
SYSTem:TIME.....	413
SYSTem:TIME:DSTime:MODE.....	414
SYSTem:TIME:DSTime:RULE.....	414
SYSTem:TIME:DSTime:RULE:CATalog?.....	414
SYSTem:TIME:HRTimer:ABSolute:SET.....	414
SYSTem:TIME:LOCAl.....	413
SYSTem:TIME:UTC.....	413
SYSTem:TZONE.....	415
SYSTem:VERsion?.....	409
TEST:DEvIce:RESult?.....	391
TEST:DEvIce[:ALL].....	391
TEST:SENsOr<Sensor>?.....	391
TEST:USB:STORage?.....	391
TRIGger<Measurement>:MODE.....	235
TRIGger<Measurement>[:CHANnel<Channel>]:ATRigger[:STATe].....	230
TRIGger<Measurement>[:CHANnel<Channel>]:COUNT.....	231
TRIGger<Measurement>[:CHANnel<Channel>]:DELay:AUTO.....	231
TRIGger<Measurement>[:CHANnel<Channel>]:DELay[:VALue].....	232
TRIGger<Measurement>[:CHANnel<Channel>]:DTIME.....	232
TRIGger<Measurement>[:CHANnel<Channel>]:EXTernal<Port>:IMPedance.....	232
TRIGger<Measurement>[:CHANnel<Channel>]:HOLDoff.....	233
TRIGger<Measurement>[:CHANnel<Channel>]:HYSTeresis.....	233
TRIGger<Measurement>[:CHANnel<Channel>]:JITTer:METHOD.....	234
TRIGger<Measurement>[:CHANnel<Channel>]:LEVel.....	234
TRIGger<Measurement>[:CHANnel<Channel>]:SENDER:PORT.....	235
TRIGger<Measurement>[:CHANnel<Channel>]:SENDER[:STATe].....	236
TRIGger<Measurement>[:CHANnel<Channel>]:SLOPe.....	236
TRIGger<Measurement>[:CHANnel<Channel>]:SOURce.....	237
TRIGger<Measurement>[:CHANnel<Channel>]:SYNChronize:PORT.....	237
TRIGger<Measurement>[:CHANnel<Channel>]:SYNChronize[:STATe].....	238
TRIGger<Measurement>[:IMMEDIATE].....	238
TRIGger<undef>:ALL:ATRigger[:STATe].....	230
TRIGger<undef>:ALL:COUNT.....	231
TRIGger<undef>:ALL:DELay:AUTO.....	231
TRIGger<undef>:ALL:DELay[:VALue].....	232
TRIGger<undef>:ALL:DTIME.....	232
TRIGger<undef>:ALL:HOLDoff.....	233
TRIGger<undef>:ALL:HYSTeresis.....	233
TRIGger<undef>:ALL:LEVel.....	234
TRIGger<undef>:ALL:MODE.....	235
TRIGger<undef>:ALL:SLOPe.....	236
TRIGger<undef>:ALL:SOURce.....	237
TRIGger<undef>:ALL:SYNChronize[:STATe].....	238
TRIGger<undef>:ALL[:IMMEDIATE].....	238
UNIT<Measurement>:POWer:RATio.....	218
UNIT<Measurement>:POWer:REFLection.....	218
UNIT<Measurement>:POWer:RELative:STATe.....	218
UNIT<Measurement>:POWer[:VALue].....	219

Index

Symbols

*OPC	475
*OPC?	475
*WAI	475
1 Trig key	27
3rd and 4th measurement channel (R&S NRX-K4)	46

A

AC power supply	30
Connecting to	20
Add Sensor dialog	152

B

Bench top operation	18
Boolean parameters	472
Brochures	15
Burst average	74
Result display	75
Settings	75

C

Carrying	17
Case-sensitivity	
SCPI	469
Channel	
Correction	130
Filter	132
Mode	129
Channel Filter Configuration dialog	132
Checking	17
Cleaning	504
Combining command	188
Structure	191
Command line	473
Command structure	468
Command syntax	
Common	469
Device-specific	469
Common command	178
Syntax	469
CONDition	477
Connecting	
External devices	23
LAN	21
Power supply	20
Sensor	21
Connections tab	138
Connector	
AC power supply	30
Out 1 / Trig Out	30
Sensor	25, 32
Trig In / Out 2	30
Continuous average	72
Result display	72
Settings	73
Control	
Measurement	62
Cursor keys	28
Customer support	502
Collecting information	502

D

Data sheets	15
Date and Time dialog	156
Default settings	135
Delete key	27
Details tab	164
Device ID	31
Device status register	480
Diagnostics	
Tests	501
Dialog	
Measurement Main Configuration	113
Display	
Configuration	52
Display layout	38
Changing	38
Examples	40
Display settings	52
Disposal	504
Documentation overview	15
Dropout time	
Trigger	64

E

Electromagnetic interference (EMI)	20
Electrostatic discharge (ESD)	20
EMI	20
Emulation	423
Emulations tab	144
ENABLE	478
Enable register	486
Enter key	28
Error message	
Number	498
Errors	
Displaying	37
Esc key	27
ESD	20
ESE	486
ESR	486
Ethernet interface	30
Remote control	465
Evaluate dialog	108
EVENT	478
External devices	23

F

Favorites key	28
Firmware	
update	171
Freq key	28
Front panel	25
Front panel keys	27

G

Gate Configuration dialog	94
General tab	157
Getting started	15
Global Settings tab	168
Going back to the previous level	33

- GPIB interface 468
- H**
- Hardware Config tab 166
- Hardware option 26
- Help 15
- Hierarchy level
- Changing 33
- High-level command 188
- Structure 191
- HiSLIP
- Protocol 467
 - Resource string 466
- Hold-off time
- Trigger 65
- Hostname 140
- Default 31
- HW Options tab 162
- I**
- I/O dialog 145
- IEC 625/IEEE 488 interface 31
- IEC/IEEE bus interface 468
- Initial state
- Preset 135
- Installing
- Option 163
 - Options 170
- Instrument identification string 144
- Instrument info tab 154
- Instrument Password tab 160
- Instrument security procedures 15
- Instrument settings 134
- Instrument test 167
- Intended use 11
- Interface
- Ethernet 30, 465
 - IEC 625/IEEE 488 31
 - Module bay 26
 - USB device 30
 - USB host 30
- K**
- Key 27
- 1 Trig 27
 - Delete 27
 - Enter 28
 - Esc 27
 - Favorites 28
 - Freq 28
 - Local 27
 - On/standby 29
 - Preset 28
 - Screenshot 27
 - System 28
 - Zero 28
- L**
- Labels 13
- LAN
- VXI-11 protocol 467
- LAN connection 21
- LAN Settings tab 159
- License Key 170
- Lifting 17
- Limit violation 49
- Local key 27
- Logon 160
- M**
- Main measurement dialog 34
- Access 34
 - Layout 35
- Maintenance 504
- Cleaning 504
- Manage License Keys tab 163
- Manage Sensors dialog 151
- Manual operation 33
- Returning to 45
- Measured value
- Limit violation 49
- Measurement
- Basics 46
 - Configuration 52
 - Control 62
 - Parallel 46
 - Settings 52
 - Setup 48
 - Starting 48
- Measurement Main Configuration dialog 113
- Measurement panes
- Swapping 40
- Measurement results
- Controlling 62
- Measurement Settings dialog 69
- Statistics 104
- Measurement types
- Burst average 74
 - Continuous average 72
 - NRT 108
 - Pulse analysis 81
 - Statistics 101
 - Time gate 90
 - Timeslot 95
 - Trace 76
- Messages
- Deleting 38
 - Displaying 37
- Mnemonics 468
- Module bay 26
- N**
- Network
- Overview 140
- Network dialog 139
- Notification 497
- Number 498
- Notification center 37
- Symbols 37
- NRT 108
- Result display 108
 - Settings 109
- NTRansition 478
- O**
- On/standby key 29
- Open source acknowledgment (OSA) 16

- Open source license 165
 - Open Source Licenses dialog 165
 - Operating concepts
 - Manual operation 33
 - Remote control 44
 - Remote operation 43
 - Operating conditions 17
 - Operating site 17
 - Operation calibrating status register 487
 - Operation lower limit fail status register 494
 - Operation measuring extended status register 489
 - Operation measuring status register 488
 - Operation sense status register 493
 - Operation status register 487
 - Operation trigger extended status register 492
 - Operation trigger status register 491
 - Operation upper limit fail status register 495
 - Option
 - 3rd and 4th measurement channel (R&S NRX-K4) 46
 - Details 164
 - Hardware 162
 - Installing 163, 170
 - Manage license keys 163
 - Management 170
 - second measurement channel (R&S NRX-K2) 46
 - Software 162
 - Option identification string 145
 - Options dialog 162
 - Out 1 / Trig Out connector 30
 - Overlapping commands
 - Preventing 475
 - Overview tab 140
- P**
- Parallel poll enable register 480
 - Parameter
 - SCPI 470
 - Parameters
 - Block data 473
 - Editing 41
 - Special numeric values 471
 - String 473
 - Text 472
 - Password
 - Instrument 160
 - Security 161
 - Power supply
 - Connecting to 20
 - PPE 480
 - Preparing for use 17
 - Preset 134, 135
 - Preset key 28
 - Primary sensor 115
 - Protocol
 - HiSLIP 467
 - VXI-11 467
 - PTRansition 478
 - Pulse analysis 81
 - Result display 82
 - Settings 82, 83
 - Pulse Analysis dialog 83
- Q**
- Query 474
 - Questionable calibration status register 485
 - Questionable measurement status register 484
 - Questionable power status register 483
 - Questionable status register 482
- R**
- Rack mounting 19
 - Rear panel 29
 - Recall
 - Settings 134
 - Release notes 16
 - Remote control 44
 - Basics 464
 - Changing to 44
 - Combining command 188
 - Command syntax 469
 - Common command 178
 - Emulation 423
 - Ethernet interface 465
 - High-level command 188
 - HiSLIP protocol 467
 - Interfaces 464
 - Leaving 45
 - Protocols 464
 - Query 474
 - Response 474
 - SCPI command structure 468
 - SCPI parameter 470
 - Socket communication 468
 - Structure 473
 - Synchronization 475
 - Syntax elements 473
 - USB interface 464
 - VISA resource strings 466
 - VXI-11 protocol 467
 - Remote dialog 142
 - Remote operation 43
 - Remote settings
 - Emulations 144
 - Settings 143
 - VISA Resource 143
 - Resource string
 - HiSLIP 466
 - Socket 466
 - VISA 466
 - VXI-11 466
 - Response 474
- S**
- Safety information 11
 - Safety instructions 11, 15
 - Sanitization 158
 - Save
 - Settings 134
 - Save and recall 134
 - Scale Configuration dialog 105
 - SCPI parameter 470
 - SCPI status register
 - Structure 477
 - Screenshot key 27
 - Screenshots
 - Creating 42
 - Saving 42
 - second measurement channel (R&S NRX-K2) 46
 - Secondary sensor 115

- Security
 - General settings 157
 - Instrument password 160
 - LAN settings 159
 - Security password 161
 - Security dialog 157
 - Security Password tab 161
 - Security procedures 15
 - Selftest 501
 - Sensor
 - Assignment 46
 - Connecting 21
 - Connector 25, 32
 - Memory 46
 - Zeroing 136
 - Sensor Info dialog 152
 - Sensor Manager 151
 - Sensor range
 - Attenuation 128
 - Attenuator mode 128
 - Offset 128
 - Range 127
 - Range state 127
 - User defined transition 127
 - Sensor settings 134
 - Sensor Test dialog 153
 - Serial number 31
 - Service request enable register 479
 - Setting up 18
 - Settings
 - Burst average 75
 - Display 52
 - Input/Output 145
 - Network 139
 - NRT 109
 - Open source licenses 165
 - Options 162
 - Pulse analysis 82, 83
 - Remote 142
 - Scale configuration 105
 - Security 157
 - Sensor manager 151
 - Statistics 103
 - Statistics Timing 107
 - System 138
 - System info 154
 - Time gate 92, 94
 - Timeslot 98, 99
 - Trace 77, 78
 - Trigger 65
 - Settings conflict 50
 - Settings tab 143
 - Socket
 - Communication 468
 - Resource string 466
 - Software option
 - Installing 170
 - Software update
 - see firmware 171
 - Sources
 - Trigger 63
 - SRE 479
 - Standard event status register 486
 - Start dialog 33
 - Statistics 101
 - Result display 101
 - Scale configuration 105
 - Settings 103
 - Timing 107
 - Statistics Timing dialog 107
 - Status
 - Information 497
 - Status byte register 479
 - Status information 36
 - Status register 477
 - CONDition 477
 - Device status register 480
 - ENABLE 478
 - Enable register 486
 - EVENT 478
 - Hierarchy 476
 - IST flag 480
 - NTRansition 478
 - Operation calibrating status register 487
 - Operation lower limit fail status register 494
 - Operation measuring extended status register 489
 - Operation measuring status register 488
 - Operation sense status register 493
 - Operation status register 487
 - Operation trigger extended status register 492
 - Operation trigger status register 491
 - Operation upper limit fail status register 495
 - Parallel poll enable register 480
 - PTRansition 478
 - Questionable calibration status register 485
 - Questionable measurement status register 484
 - Questionable power status register 483
 - Questionable status register 482
 - Remote control 419
 - Service request enable register 479
 - Standard event status register 486
 - Status byte register 479
 - Sum bit 478
 - Status reporting system 475
 - STB 479
 - Stock number 31
 - Storage 504
 - Suffixes 470
 - Sum bit 478
 - Support information 168
 - SW Options tab 162
 - Switching on 24
 - Symbols
 - Notification center 37
 - Status information 36
 - Syntax elements 473
 - System Info dialog 154
 - System key 28
 - System Overview dialog 138
 - Connections 138
 - Global settings 168
 - Hardware configuration 166
 - Instrument info 154
 - Test 167
 - System settings 138
- ## T
- Tab
 - Instrument info 154
 - Target audience 11
 - Termination control 62
 - Test setup 20
 - Test tab 167

Tests	501
Time gate	90
Result display	91
Settings	92, 94
Timeslot	95
Result display	96
Settings	98, 99
Timeslot Configuration dialog	99
Touchscreen	27
Trace	76
Result display	76
Settings	77, 78
Trace Marker dialog	78
Transporting	503
Trig In / Out 2 connector	30
Trigger	
Dropout time	64
Hold-off time	65
Sources	63
States	63
Trigger settings	65
Troubleshooting	497
Information	168
Notification	497
Status information	497
Tests	501

U

Units	471
Unpacking	17
USB	
Device interface	30
Host interface	29, 30
USB interface	
Remote control	464
USB resource string	465
User Interaction Needed dialog	46
User interface	33
Display layout	38
Going back	33
Main measurement dialog	34
Measurement panes	40
Notification center	37
Parameters	41
Restricting access	42
Screenshots	42
Settings conflict	50
Start dialog	33
Status information	36
User interface test	167
User manual	15

V

VISA	
Resource string	466
VISA Resource tab	143
VXI-11	
Protocol	467
Resource string	466

W

Warning message	14
Number	498

Z

Zero key	28
Zeroing sensor	136
Zeroing Sensors dialog	136