

SWITCHING OUTPUTS OF MULTIPLE DC POWER SUPPLIES R&S®NGL200 / R&S®NGM200

Products:

- ▶ R&S®NGL201
- ▶ R&S®NGL202
- ▶ R&S®NGM201
- ▶ R&S®NGM202
- ▶ R&S®NGL-K103
- ▶ R&S®NGM-K103

Thomas Lechner | 1GP126 | Version 2e | 06.2020

<https://www.rohde-schwarz.com/appnote/1GP126>



Contents

1	Overview	3
2	Background	4
2.1	Prerequisites	4
2.2	Principle of the synchronization.....	4
2.2.1	Switching on.....	4
2.2.2	Switching off.....	4
3	Preparations	4
3.1	Connections between the instruments	4
3.2	Settings	5
3.2.1	Device	5
3.2.2	Channel 1/2.....	7
4	Operation	8
5	Literature	8
6	Ordering Information	8

1 Overview

All channels of DC power supplies R&S®NGL200 and R&S®NGM200 are isolated against the grounding equipment conductor and against the digital ground of the instrument. Therefore, channels can be connected in parallel for increasing the current capability, or in series for achieving higher voltages or dual-voltage supplies. In the case of parallel and serial connections it is usually desired to switch all channels simultaneously on and off for protecting the supplied circuitry and for avoiding overcurrent on other power supply channels.

This application note describes how to connect and configure DC power supplies R&S®NGL200 and R&S®NGM200 for synchronized on and off switching of all channels across multiple power supplies.

2 Background

2.1 Prerequisites

The use of the digital I/O connector requires option "Digital trigger IO" (R&S® NGL-K103 or R&S® NGM-K103, respectively).

The installed software version must be 2.016 or later.

2.2 Principle of the synchronization

All connectors are wired and configured the same way. The connections are made in a bus structure with three wires, one for activating the outputs, another one for switching the outputs off, plus a ground connection.

All outputs are switched simultaneously by manual or remote control of the "Output" button on a one-channel power supply or a "Chx" button on a two-channel power supply. On two-channel power supplies the "Output" must be permanently on.

The connection scheme and the configuration of master and slaves is described in the following sections.

2.2.1 Switching on

If any output is activated, either output "OUT1" or output "OUT2" of the digital I/O sends a negative pulse on the "Output On" bus line. This pulse is received by inputs "Trigger_Ch1" and "Trigger_Ch2" of all instruments, which causes all channels to be activated.

2.2.2 Switching off

If any channel is deactivated, the associated "Output Fault" output sends a negative pulse to the "Output Off" bus line. The deactivation may be caused by switching the output off manually or remotely, or by any protection being blown. This pulse is received by the "Inhibit Ch1" and "Inhibit Ch2" inputs which deactivate the associated outputs.

3 Preparations

3.1 Connections between the instruments

The digital I/O interface of DC power supplies R&S® NGL200 and NGM200 is accessible via a 15 pin D-Sub connector on the backplane.

All outputs of the digital I/O are implemented as switches to ground with "active low" logic. A parallel connection including two or more outputs results in a "wired OR". The bus line goes low (active) when any of the outputs goes low (active).

All inputs have pull-up resistors such that an input which is not connected is permanently inactive.

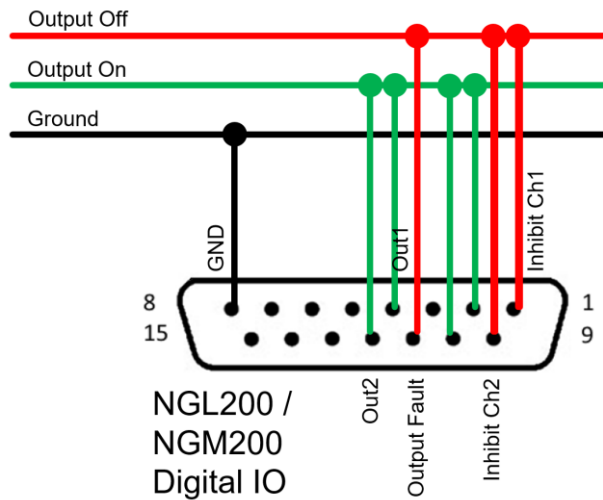

Figure 3-1 Connection schematic of the digital IO connectors

3.2 Settings

Settings are accessed with the menu button "≡" on the front panel of the power supply. The "Device" tab provides access to global settings of the power supply. For each available channel there is a "Channel x" tab with the settings which are individual to each channel.

3.2.1 Device

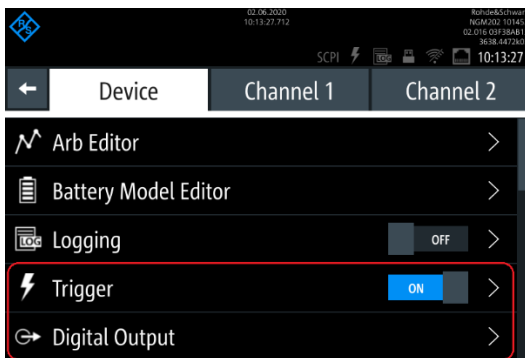

Figure 3-2 Device menu

3.2.1.1 Digital Output

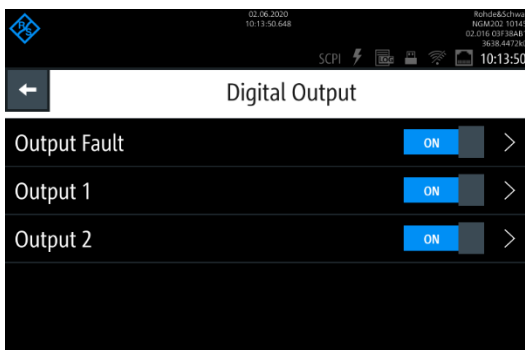

Figure 3-3 Sub-menu for digital outputs

3.2.1.1.1 Output Fault

- Enabled: ON
- Source: Output Off
- Channel: Any (NGL202 / NGM202 only)
- Signal Type: Pulse

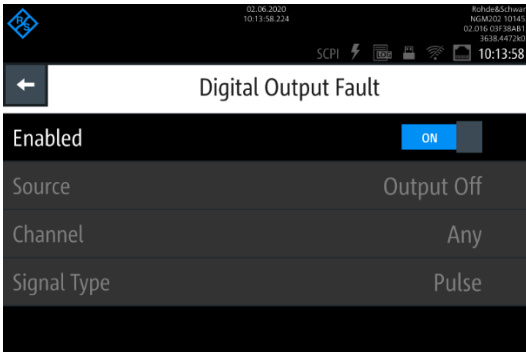

Figure 3-4 Settings for output fault

3.2.1.1.2 Output1

- Enabled: On
- Source: Output On Ch1
- Signal Type: Pulse

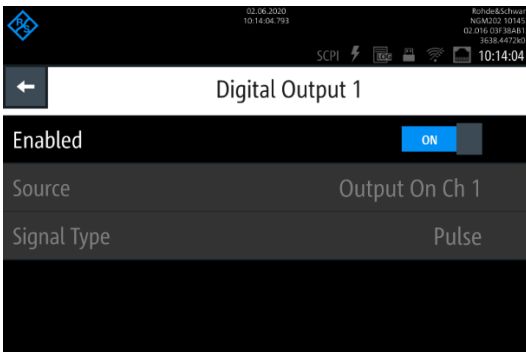

Figure 3-5 Settings for digital output 1

3.2.1.1.3 Output2:

- Enabled: ON (NGx202) / OFF (NGx201)
- Source: Output On Ch2 / -
- Signal Type: Pulse / -

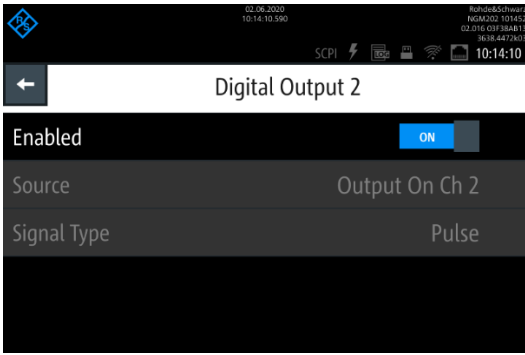

Figure 3-6 Settings for digital output 2

3.2.1.2 Trigger

- Enabled: ON
- Source: Digital I/O
- Digital I/O Pin: Ext. Trigger
- Channel: Any (NGL202 / NGM202 only)

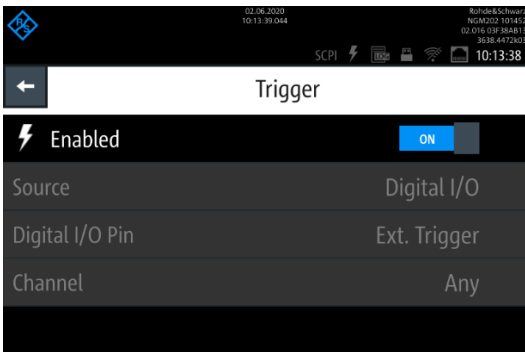

Figure 3-7 Trigger settings

3.2.2 Channel 1/2

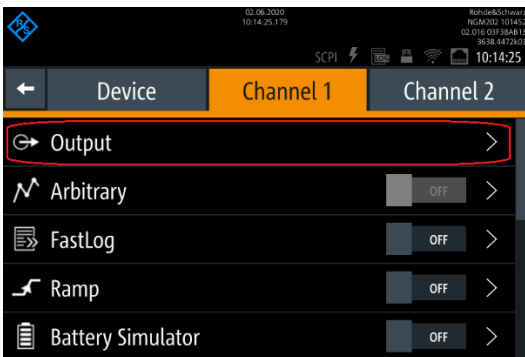

Figure 3-8 Menu for channel 1

3.2.2.1 Output Channel 1/2

- Triggered: ON

– Trigger: Output On

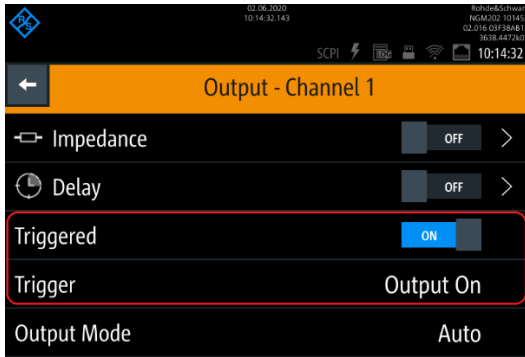

Figure 3-9 Output settings for channel 1

4 Operation

Keep the "Output" button on with NGL202 und NGM202.

Switching on any of the "Ch1" and "Ch2" buttons on a NGL202 or NGM202 or the "Output" button on a NGL201 or NGM201, or activating any channel by remote command "OUTP:SEL 1" causes all channels of the connected instruments to be switched on.

Switching off any of the "Ch1" and "Ch2" buttons on a NGL202 or NGM202 or the "Output" button on a NGL201 or NGM201, or deactivating any channel by remote command "OUTP:SEL 0" causes all channels of the connected instruments to be switched off. All channels will also be switched off if any of the channels is deactivated by over current protection, over voltage protection or over power protection.

5 Literature

[1] Rohde & Schwarz, "R&S®NGL200 Power Supply Series User Manual," 13 April 2020. [Online]. Available: <https://www.rohde-schwarz.com/manual/ngl200/>.

[2] Rohde & Schwarz, "R&S®NGM200 Power Supply Series User Manual," 30 March 2020. [Online]. Available: <https://www.rohde-schwarz.com/manual/ngm200/>.

6 Ordering Information

Designation	Type	Order No.
Single-channel power supply	R&S®NGL201	3638.3376.02

Designation	Type	Order No.
Two-channel power supply	R&S®NGL202	3638.3376.03
Digital trigger I/O	R&S®NGL-K103	3652.6385.02
Single-channel power supply	R&S®NGM201	3638.4472.02
Two-channel power supply	R&S®NGM202	3638.4472.03
Digital trigger I/O	R&S®NGM-K103	3643.9904.02

Rohde & Schwarz

The Rohde & Schwarz electronics group offers innovative solutions in the following business fields: test and measurement, broadcast and media, secure communications, cybersecurity, monitoring and network testing. Founded more than 80 years ago, the independent company which is headquartered in Munich, Germany, has an extensive sales and service network with locations in more than 70 countries.

www.rohde-schwarz.com



Rohde & Schwarz training

www.training.rohde-schwarz.com

Rohde & Schwarz customer support

www.rohde-schwarz.com/support



R&S® is a registered trademark of Rohde & Schwarz GmbH & Co. KG
Trade names are trademarks of the owners.
1GP126 | Version 2e | 06.2020
Application Note | Switching outputs of Multiple DC Power Supplies
R&S@NGL200 / R&S@NGM200
Data without tolerance limits is not binding | Subject to change
© 2020 Rohde & Schwarz GmbH & Co. KG | 81671 Munich, Germany
www.rohde-schwarz.com