

# R&S®NRPxxT(N) Thermal Power Sensors User Manual



1177602302

This manual describes the following thermal power sensors with firmware version FW 02.00 and later:

- R&S®NRP18T (1424.6115.02)
- R&S®NRP18TN (1424.6121.02)
- R&S®NRP33T (1424.6138.02)
- R&S®NRP33TN (1424.6144.02)
- R&S®NRP40T (1424.6150.02)
- R&S®NRP40TN (1424.6167.02)
- R&S®NRP50T (1424.6173.02)
- R&S®NRP50TN (1424.6180.02)
- R&S®NRP67T (1424.6196.02)
- R&S®NRP67TN (1424.6209.02)
- R&S®NRP90T (1424.6473.02)
- R&S®NRP90TN (1424.6480.02)
- R&S®NRP110T (1424.6215.02)

© 2020 Rohde & Schwarz GmbH & Co. KG

Mühlhofstr. 15, 81671 München, Germany

Phone: +49 89 41 29 - 0

Email: [info@rohde-schwarz.com](mailto:info@rohde-schwarz.com)

Internet: [www.rohde-schwarz.com](http://www.rohde-schwarz.com)

Subject to change – Data without tolerance limits is not binding.

R&S® is a registered trademark of Rohde & Schwarz GmbH & Co. KG.

Trade names are trademarks of the owners.

1177.6023.02 | Version 07 | R&S®NRPxxT(N)

Throughout this manual, products from Rohde & Schwarz are indicated without the ® symbol, for example R&S®NRP33TN is abbreviated as R&S NRP33TN.

# Contents

<b>1</b>	<b>Preface</b> .....	<b>9</b>
<b>1.1</b>	<b>Documentation Overview</b> .....	<b>9</b>
1.1.1	Getting Started Manual.....	9
1.1.2	User Manuals.....	9
1.1.3	Tutorials.....	9
1.1.4	Instrument Security Procedures.....	9
1.1.5	Basic Safety Instructions.....	9
1.1.6	Data Sheets and Brochures.....	10
1.1.7	Release Notes and Open Source Acknowledgment (OSA).....	10
1.1.8	Application Notes, Application Cards, White Papers, etc.....	10
<b>1.2</b>	<b>Key Features</b> .....	<b>10</b>
<b>2</b>	<b>Safety Information</b> .....	<b>11</b>
<b>3</b>	<b>Preparing for Use</b> .....	<b>12</b>
<b>3.1</b>	<b>Unpacking and Checking the Power Sensor</b> .....	<b>12</b>
<b>3.2</b>	<b>Operating Conditions</b> .....	<b>12</b>
<b>3.3</b>	<b>Considerations for Test Setup</b> .....	<b>12</b>
<b>3.4</b>	<b>Connecting to a DUT</b> .....	<b>13</b>
<b>3.5</b>	<b>Connecting a Cable to the Host Interface</b> .....	<b>14</b>
<b>3.6</b>	<b>Connecting to a Controlling Host</b> .....	<b>14</b>
3.6.1	Computer.....	15
3.6.1.1	Simple USB Connection.....	15
3.6.1.2	R&S NRP-Z5 Sensor Hub Setup.....	16
3.6.2	Base Unit.....	17
3.6.3	Using a LAN Connection.....	18
3.6.3.1	Connecting a LAN Power Sensor to the LAN.....	18
3.6.3.2	Establishing a Connection to the Network.....	20
3.6.3.3	Using Hostnames.....	21
3.6.3.4	Assigning the IP Address.....	22
<b>4</b>	<b>Power Sensor Tour</b> .....	<b>24</b>
<b>4.1</b>	<b>RF Connector</b> .....	<b>24</b>

4.2	Trigger I/O Connector.....	25
4.3	Host Interface.....	25
4.4	Status LED.....	25
4.5	LAN PoE Interface.....	26
<b>5</b>	<b>Operating Concepts.....</b>	<b>28</b>
5.1	R&S NRP Toolkit.....	28
5.1.1	Versions and Downloads.....	28
5.1.2	System Requirements.....	28
5.1.3	R&S NRP Toolkit for Windows.....	29
5.1.3.1	Components of the R&S NRP Toolkit.....	30
5.2	Browser-Based User Interface.....	31
5.3	Remote Control.....	33
5.4	R&S NRPV.....	33
5.5	R&S Power Viewer.....	35
5.6	R&S Power Viewer Mobile.....	37
5.7	R&S NRX.....	38
5.8	R&S NRP2.....	39
<b>6</b>	<b>Browser-Based User Interface.....</b>	<b>42</b>
6.1	Main Dialog of the Web User Interface.....	42
6.2	Setting the Unit.....	43
6.3	Common Settings.....	44
6.4	Measurement Modes.....	45
6.4.1	Continuous Average Mode.....	45
6.5	Settings.....	46
6.5.1	Sensor Settings.....	46
6.5.2	Averaging Settings.....	48
6.5.3	Trigger Settings.....	50
6.5.4	System Settings.....	52
<b>7</b>	<b>Firmware Update.....</b>	<b>54</b>
7.1	Hardware and Software Requirements.....	54
7.2	Updating the Firmware.....	54
7.2.1	Using the Firmware Update for NRP Family Program.....	55

7.2.2	Using the Web User Interface.....	57
7.2.3	Using Remote Control.....	57
<b>8</b>	<b>Replacing an R&amp;S NRP-Zxx with an R&amp;S NRPxxT(N).....</b>	<b>59</b>
<b>8.1</b>	<b>Most Important Differences.....</b>	<b>59</b>
<b>8.2</b>	<b>Prerequisites.....</b>	<b>59</b>
<b>9</b>	<b>Remote Control Commands.....</b>	<b>61</b>
<b>9.1</b>	<b>Conventions Used in SCPI Command Descriptions.....</b>	<b>61</b>
<b>9.2</b>	<b>Notations.....</b>	<b>61</b>
<b>9.3</b>	<b>Common Commands.....</b>	<b>63</b>
<b>9.4</b>	<b>Preparing for the Measurement.....</b>	<b>67</b>
9.4.1	Selecting the Reference Source.....	67
9.4.2	Selecting a Measurement Mode.....	68
<b>9.5</b>	<b>Controlling the Measurement.....</b>	<b>68</b>
9.5.1	Starting and Ending a Measurement.....	68
9.5.2	Triggering.....	70
9.5.2.1	Trigger States.....	70
9.5.2.2	Waiting for a Trigger Event.....	70
9.5.2.3	Trigger Sources.....	71
9.5.2.4	Dropout Time.....	71
9.5.2.5	Hold-Off Time.....	72
9.5.3	Controlling the Measurement Results.....	72
9.5.4	Interplay of the Controlling Mechanisms.....	73
9.5.4.1	Continuous Average Mode.....	73
9.5.5	Configuring the Trigger.....	74
<b>9.6</b>	<b>Configuring and Retrieving Results.....</b>	<b>80</b>
9.6.1	Setting the Power Unit.....	80
9.6.2	Setting the Result Format.....	81
9.6.3	Retrieving Results.....	82
<b>9.7</b>	<b>Configuring the Measurement Modes.....</b>	<b>83</b>
9.7.1	Continuous Average Measurement.....	83
<b>9.8</b>	<b>Configuring Basic Measurement Parameters.....</b>	<b>86</b>
9.8.1	Configuring Auto Averaging.....	86
9.8.2	Setting the Frequency.....	90

9.8.3	Configuring Corrections.....	90
9.8.3.1	Duty Cycle Corrections.....	90
9.8.3.2	Offset Corrections.....	91
9.8.3.3	S-Parameter Correction.....	92
9.8.3.4	S-Gamma Corrections.....	94
9.8.3.5	Using the S-Parameters Tool.....	96
<b>9.9</b>	<b>Calibrating, Zeroing.....</b>	<b>105</b>
<b>9.10</b>	<b>Testing.....</b>	<b>108</b>
<b>9.11</b>	<b>Configuring the System.....</b>	<b>108</b>
<b>9.12</b>	<b>Using the Status Register.....</b>	<b>121</b>
9.12.1	General Status Register Commands.....	121
9.12.2	Reading Out the CONDition Part.....	122
9.12.3	Reading Out the EVENT Part.....	122
9.12.4	Controlling the ENABLE Part.....	123
9.12.5	Controlling the Negative Transition Part.....	123
9.12.6	Controlling the Positive Transition Part.....	124
<b>10</b>	<b>Performing Measurement Tasks - Programming Examples.....</b>	<b>125</b>
<b>10.1</b>	<b>Performing the Simplest Measurement.....</b>	<b>125</b>
<b>10.2</b>	<b>Performing a Buffered Continuous Average Measurement.....</b>	<b>125</b>
<b>11</b>	<b>Remote Control Basics.....</b>	<b>128</b>
<b>11.1</b>	<b>Remote Control Interfaces and Protocols.....</b>	<b>128</b>
11.1.1	USB Interface.....	128
11.1.2	Ethernet Interface.....	130
11.1.2.1	VISA Resource Strings.....	130
11.1.2.2	VXI-11 Protocol.....	131
11.1.2.3	HiSLIP Protocol.....	131
11.1.2.4	Socket Communication.....	132
<b>11.2</b>	<b>SCPI Command Structure.....</b>	<b>132</b>
11.2.1	Syntax for Common Commands.....	133
11.2.2	Syntax for Device-Specific Commands.....	133
11.2.3	SCPI Parameters.....	134
11.2.4	Overview of Syntax Elements.....	137
11.2.5	Structure of a Command Line.....	137

11.2.6	Responses to Queries.....	138
<b>11.3</b>	<b>Status Reporting System.....</b>	<b>139</b>
11.3.1	Hierarchy of the Status Registers.....	139
11.3.2	Structure of a SCPI Status Register.....	140
11.3.3	Status Byte (STB) and Service Request Enable Register (SRE).....	141
11.3.4	IST Flag and Parallel Poll Enable Register (PPE).....	143
11.3.5	Device Status Register.....	143
11.3.6	Questionable Status Register.....	144
11.3.6.1	Questionable Power Status Register.....	145
11.3.6.2	Questionable Calibration Status Register.....	146
11.3.7	Standard Event Status and Enable Register (ESR, ESE).....	147
11.3.8	Operation Status Register.....	148
11.3.8.1	Operation Calibrating Status Register.....	149
11.3.8.2	Operation Measuring Status Register.....	150
11.3.8.3	Operation Trigger Status Register.....	151
11.3.8.4	Operation Sense Status Register.....	152
11.3.8.5	Operation Lower Limit Fail Status Register.....	153
11.3.8.6	Operation Upper Limit Fail Status Register.....	154
<b>12</b>	<b>Troubleshooting.....</b>	<b>156</b>
<b>12.1</b>	<b>Displaying Status Information.....</b>	<b>156</b>
<b>12.2</b>	<b>Performing a Selftest.....</b>	<b>156</b>
<b>12.3</b>	<b>Problems during a Firmware Update.....</b>	<b>157</b>
<b>12.4</b>	<b>Cannot Establish a LAN Connection.....</b>	<b>157</b>
<b>12.5</b>	<b>Contacting Customer Support.....</b>	<b>157</b>
	<b>List of Commands.....</b>	<b>159</b>
	<b>Index.....</b>	<b>163</b>





# 1 Preface

This chapter provides an overview of the user documentation and an introduction to the R&S NRPxxT(N).

## 1.1 Documentation Overview

This section provides an overview of the R&S NRPxxT(N) user documentation. Unless specified otherwise, you find the documents on the R&S NRPxxT(N) product page at:

[www.rohde-schwarz.com/product/nrp-t-tn](http://www.rohde-schwarz.com/product/nrp-t-tn)

### 1.1.1 Getting Started Manual

Introduces the R&S NRPxxT(N) and describes how to set up and start working with the product. Includes basic operations and general information, e.g. safety instructions, etc. A printed version is delivered with the power sensor.

### 1.1.2 User Manuals

Contains the description of all instrument modes and functions. It also provides an introduction to remote control, a complete description of the remote control commands with programming examples, and information on maintenance and interfaces. Includes the contents of the getting started manual.

### 1.1.3 Tutorials

Tutorials offer guided examples and demonstrations on operating the R&S NRPxxT(N). They are provided on the product page of the internet.

### 1.1.4 Instrument Security Procedures

Deals with security issues when working with the R&S NRPxxT(N) in secure areas. It is available for download on the Internet.

### 1.1.5 Basic Safety Instructions

Contains safety instructions, operating conditions and further important information. The printed document is delivered with the instrument.

### 1.1.6 Data Sheets and Brochures

The data sheet contains the technical specifications of the R&S NRPxxT(N). It also lists the firmware applications and their order numbers, and optional accessories.

The brochure provides an overview of the instrument and deals with the specific characteristics.

[www.rohde-schwarz.com/brochure-datasheet/nrp-t-tn](http://www.rohde-schwarz.com/brochure-datasheet/nrp-t-tn)

### 1.1.7 Release Notes and Open Source Acknowledgment (OSA)

The release notes list new features, improvements and known issues of the current firmware version, and describe the firmware installation.

The "Open Source Acknowledgment" is provided on the user documentation CD-ROM, included in the delivery. It contains verbatim license texts of the used open source software.

[www.rohde-schwarz.com/firmware/nrp-t-tn](http://www.rohde-schwarz.com/firmware/nrp-t-tn)

### 1.1.8 Application Notes, Application Cards, White Papers, etc.

These documents deal with special applications or background information on particular topics.

## 1.2 Key Features

The thermal power sensors are members of the R&S NRP series power sensors from Rohde & Schwarz.

They provide a high-speed USB interface that constitutes both the communication port and the power supply connection.

Also, most sensors are available with an additional Gigabit Ethernet interface with Power-over-Ethernet (PoE) power supply. The power sensors with networking capabilities, the R&S NRP LAN power sensors, are marked with a trailing N in their names:

- R&S NRPxxTN

The R&S NRP series power sensors are compatible with the R&S NRP-Z power sensors in both the interface (USB) and a common command subset. This compatibility makes the replacement of the old power sensors easy.

For a detailed specification, refer to the data sheet.

## 2 Safety Information

The product documentation helps you use the R&S NRPxxT(N) safely and efficiently. Follow the instructions provided here and in the printed "Basic Safety Instructions". Keep the product documentation nearby and offer it to other users.

### **Intended use**

The R&S NRPxxT(N) is intended for the development, production and verification of electronic components and devices in industrial, administrative, and laboratory environments. Use the R&S NRPxxT(N) only for its designated purpose. Observe the operating conditions and performance limits stated in the data sheet.

### **Where do I find safety information?**

Safety information is part of the product documentation. It warns you about the potential dangers and gives instructions how to prevent personal injuries or damage caused by dangerous situations. Safety information is provided as follows:

- The printed "Basic Safety Instructions" provide safety information in many languages and are delivered with the R&S NRPxxT(N).
- Throughout the documentation, safety instructions are provided when you need to take care during setup or operation.

## 3 Preparing for Use

For information on safety, see:

- [Chapter 2, "Safety Information"](#), on page 11
- [Chapter 3.2, "Operating Conditions"](#), on page 12

### 3.1 Unpacking and Checking the Power Sensor

Check the equipment for completeness using the delivery note and the accessory lists for the various items. Check the power sensor for any damage. If there is damage, immediately contact the carrier who delivered the power sensor. Make sure not to discard the box and packing material.



#### Packing material

Retain the original packing material. If the instrument needs to be transported or shipped later, you can use the material to protect the control elements and connectors.

### 3.2 Operating Conditions

Specific operating conditions are required to ensure accurate measurements and to avoid damage to the power sensor and connected devices. Before switching on the power sensor, observe the information on appropriate operating conditions provided in the basic safety instructions and the data sheet of the power sensor.

In particular, ensure the following:

- The power sensor is dry and shows no sign of condensation.
- The ambient temperature does not exceed the range specified in the data sheet.
- Signal levels at the input connectors are all within the specified ranges.
- Signal outputs are connected correctly and are not overloaded.

### 3.3 Considerations for Test Setup

#### Preventing electrostatic discharge (ESD)

ESD is most likely to occur when you connect or disconnect a DUT.

- ▶ **NOTICE!** Risk of electrostatic discharge (ESD). Electrostatic discharge (ESD) can damage the electronic components of the power sensor and the device under test (DUT).

Ground yourself to avoid electrostatic discharge (ESD) damage:

- Using a wrist strap and cord, connect yourself to the ground.
- Use a conductive floor mat and heel strap combination.

### EMI impact on measurement results

Electromagnetic interference (EMI) may affect the measurement results.

To suppress generated electromagnetic interference (EMI):

- Use suitable shielded cables of high quality. For example, use double-shielded RF and LAN cables.
- Always terminate open cable ends.
- Note the EMC classification in the data sheet.

## 3.4 Connecting to a DUT

For connecting the power sensor to a DUT, use the RF connector. See [Chapter 4.1, "RF Connector"](#), on page 24.

### NOTICE

#### Risk of overloading the sensor

Using a power sensor at a level above its upper measuring limit can damage the sensor head. To avoid this risk, make sure not to exceed the test limit.

The test limits specified on the type label are valid only for the supplied attenuator. For operation without attenuator, lower test limits apply, as specified in the data sheet.

#### To connect to the DUT

1. Ensure that the RF connector of your DUT is compatible with the RF connector of the power sensor.
2. Insert the RF connector straight into the RF output of your DUT. Take care not to tilt it.

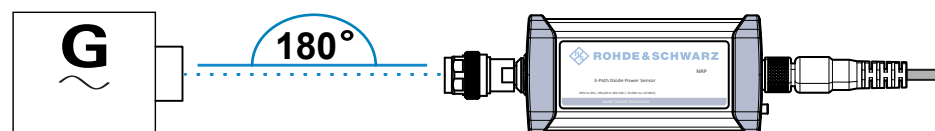

3. **NOTICE!** Risk of damaging the center pin of the RF connector. Always rotate only the hex nut of the RF connector. Never rotate the power sensor itself.  
Tighten the RF connector manually.
4. To ensure maximum measurement accuracy, tighten the RF connector using a torque wrench with the nominal torque recommended in [Chapter 4.1, "RF Connector"](#), on page 24.

**To disconnect from the DUT**

- ▶ **NOTICE!** Risk of damaging the center pin of the RF connector. Always rotate only the hex nut of the RF connector. Never rotate the power sensor itself.  
Carefully loosen the union nut at the front of the RF connector of the sensor and remove the sensor.

### 3.5 Connecting a Cable to the Host Interface

For connecting the power sensor to a USB host, use the host interface. See [Chapter 4.3, "Host Interface"](#), on page 25.

Depending on the USB host, use one of the following cables:

- Computer or R&S NRP-Z5 sensor hub:  
R&S NRP-ZKU cable with a USB connector, R&S order number 1419.0658.xx  
See [Chapter 3.6.1, "Computer"](#), on page 15.
- Base units, R&S NRX or R&S NRP2, or other supported Rohde & Schwarz instruments:  
R&S NRP-ZK6 cable with a push-pull type connector, R&S order number 1419.0664.xx  
See [Chapter 3.6.2, "Base Unit"](#), on page 17.

These cables can be obtained in different lengths up to 5 meters.

**To connect a cable to the host interface of the power sensor**

1. Insert the screw-lock cable connector into the host interface connector of the power sensor.
2. Tighten the union nut manually.

**To disconnect the host interface of the power sensor**

- ▶ Loosen the union nut of the screw-lock cable connector and remove the cable.

### 3.6 Connecting to a Controlling Host

As a controlling host, you can use:

- [Computer](#)
- [Base Unit](#)

For operating the power sensor, you can choose from various possibilities. For details, see [Chapter 5, "Operating Concepts"](#), on page 28.

### 3.6.1 Computer

If the controlling host is a computer, you can operate the power sensor using a supported software, the web user interface or remote control. For details, see [Chapter 5, "Operating Concepts"](#), on page 28.

- ▶ Establish the connection using:
  - Host interface  
See [Chapter 3.6.1.1, "Simple USB Connection"](#), on page 15.  
See [Chapter 3.6.1.2, "R&S NRP-Z5 Sensor Hub Setup"](#), on page 16.
  - LAN interface, if the power sensor is a LAN power sensor  
See [Chapter 3.6.3, "Using a LAN Connection"](#), on page 18.

#### 3.6.1.1 Simple USB Connection

All R&S NRPxxT(N) power sensors can be connected to the USB interface of a computer.

##### Required equipment

- R&S NRPxxT(N) power sensor
- R&S NRP-ZKU cable

##### Setup

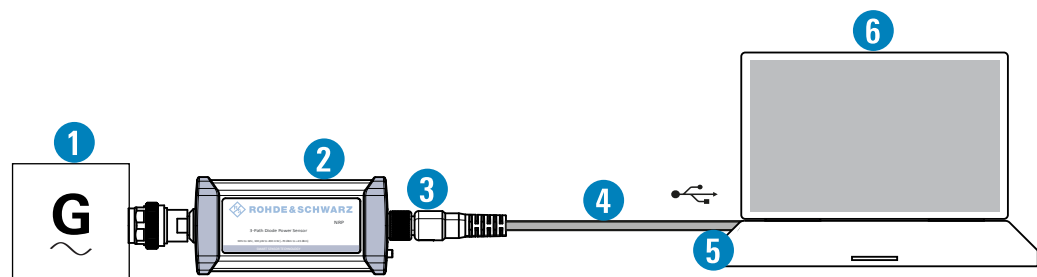

**Figure 3-1: Setup with an R&S NRP-ZKU cable**

- 1 = Signal source
- 2 = R&S NRPxxT(N) power sensor
- 3 = Host interface connector
- 4 = R&S NRP-ZKU cable
- 5 = USB connector
- 6 = Computer with installed VISA driver or R&S NRP Toolkit



Incorrectly connecting/disconnecting the R&S NRPxxT(N) power sensors can damage the power sensors or lead to erroneous results.

Ensure that you connect/disconnect your power sensor as described in [Chapter 3, "Preparing for Use"](#), on page 12.

1. Connect the cables as shown in [Figure 3-1](#) :

- a) Connect the R&S NRP-ZKU cable to the power sensor.  
See ["To connect a cable to the host interface of the power sensor"](#) on page 14.
  - b) Connect the R&S NRP-ZKU cable to the computer.
  - c) Connect the power sensor to the signal source.
2. On the computer, start a software application to view the measurement results.  
See [Chapter 5, "Operating Concepts"](#), on page 28.

### 3.6.1.2 R&S NRP-Z5 Sensor Hub Setup

The R&S NRP-Z5 sensor hub (high-speed USB 2.0) can host up to four R&S NRPxxT(N) power sensors and provides simultaneous external triggering to all connected sensors.

#### Required equipment

- 1 to 4 R&S NRPxxT(N) power sensors
- 1 R&S NRP-ZK6 cable per sensor
- R&S NRP-Z5 sensor hub with external power supply unit and USB cable
- BNC cables to connect the trigger input and trigger output signals (optional)

#### Setup

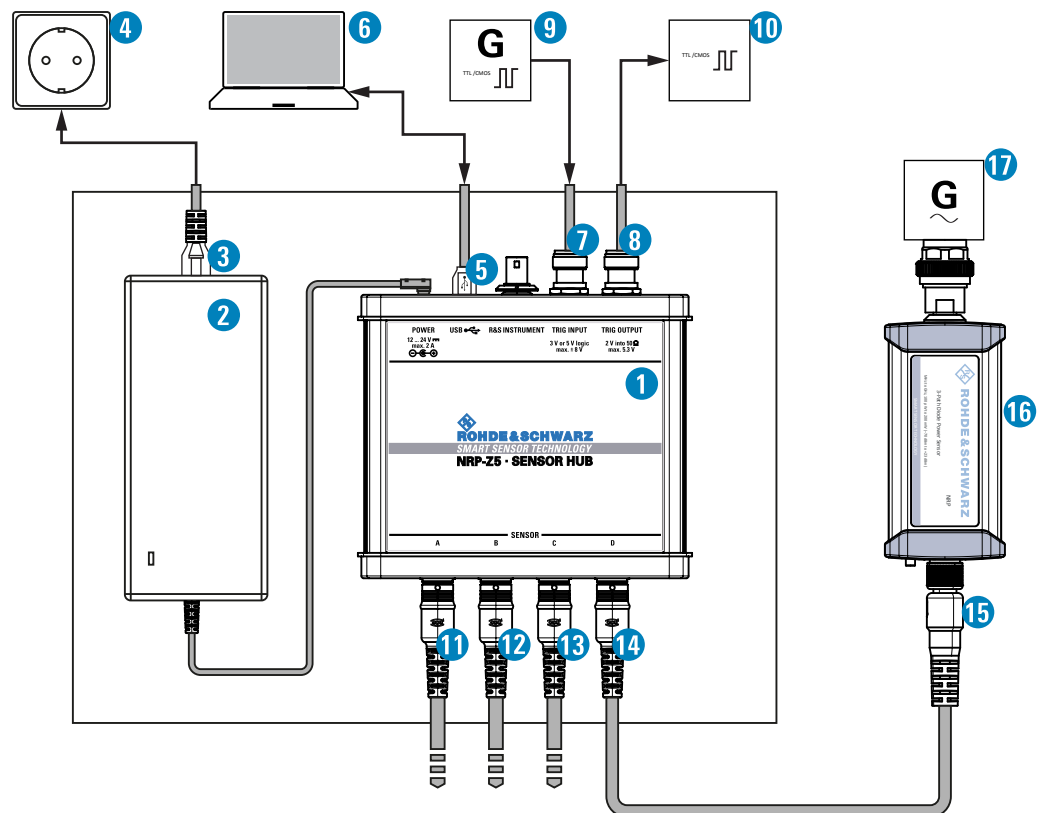

Figure 3-2: Setup with an R&S NRP-Z5 sensor hub



- 1 = R&S NRP-Z5 sensor hub
- 2 = External power supply unit (supplied)
- 3 = Power cable (supplied)
- 4 = AC power supply
- 5 = USB cable (supplied)
- 6 = Computer with USB host interface
- 7, 8 = BNC cable (optional, not supplied)
- 9 = Trigger source (optional)
- 10 = Triggered device (optional)
- 11-14 = R&S NRP-ZK6 cable
- 15 = Host interface connector
- 16 = R&S NRPxxT(N) power sensor
- 17 = Signal source



Incorrectly connecting/disconnecting the R&S NRPxxT(N) power sensors can damage the power sensors or lead to erroneous results.

Ensure that you connect/disconnect your power sensor as described in [Chapter 3, "Preparing for Use"](#), on page 12.

1. Connect the cables as shown in [Figure 3-2](#):
  - a) Connect the R&S NRP-ZK6 cable to the power sensor.  
See ["To connect a cable to the host interface of the power sensor"](#) on page 14
  - b) Connect the power sensors to the R&S NRP-Z5 sensor hub. You can connect up to four sensors.
  - c) Connect the R&S NRP-Z5 to the computer.
  - d) Connect the power sensors to the signal source.
  - e) Connect the delivered external power supply unit to the R&S NRP-Z5 and to an AC supply connector.
  - f) Connect the trigger input of the R&S NRP-Z5 with a BNC cable to the trigger source (optional).
  - g) Connect the trigger output of the R&S NRP-Z5 with a BNC cable to the trigger device (optional).
2. On the computer, start a software application to view the measurement results.  
See [Chapter 5, "Operating Concepts"](#), on page 28.

### 3.6.2 Base Unit

As a controlling host, you can use an R&S NRX or R&S NRP2 base unit. You can also operate the power sensor using other supported Rohde & Schwarz instruments with a sensor connector. For details, see also the user manual of the instrument.

- ▶ Establish the connection with the base unit using:
  - Host interface  
See [Chapter 5.7, "R&S NRX"](#), on page 38  
See [Chapter 5.8, "R&S NRP2"](#), on page 39
  - LAN interface, if:

- Base unit is an R&S NRX
- Power sensor is a LAN power sensor

See [Chapter 3.6.3, "Using a LAN Connection"](#), on page 18.

### 3.6.3 Using a LAN Connection



Requires power sensors with networking capabilities, the R&S NRP LAN power sensors.

#### 3.6.3.1 Connecting a LAN Power Sensor to the LAN

Depending on the available equipment, you can choose from different ways to connect a LAN power sensor to a controlling host.



The Ethernet interface of a LAN power sensor requires PoE (power over Ethernet). See [Chapter 4.5, "LAN PoE Interface"](#), on page 26.

Electromagnetic interference (EMI) can affect the measurement results. To avoid any impact, use category 5 cables or better.

#### Setup with a PoE Ethernet switch

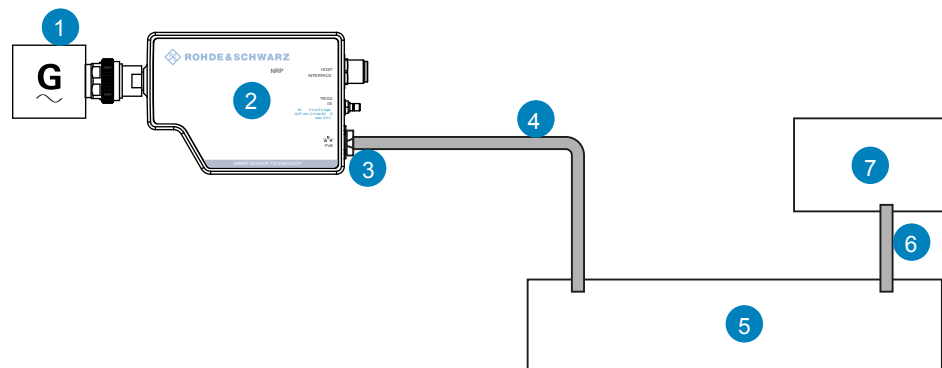

**Figure 3-3: Setup with a PoE Ethernet switch**

- 1 = Signal source
- 2 = LAN power sensor
- 3 = RJ-45 Ethernet connector
- 4, 6 = RJ-45 Ethernet cable
- 5 = Ethernet switch supporting PoE power delivery, e.g. R&S NRP-ZAP1
- 7 = Controlling host

1. Connect the RF connector of the sensor to the DUT.

See [Chapter 3.4, "Connecting to a DUT"](#), on page 13.

2. **NOTICE!** Risk of sensor damage. Use only PoE power sourcing equipment (PSE) according to IEEE standards 802.3af or IEEE 802.3at. Otherwise your power sensor can get damaged.  
Connect the RJ-45 Ethernet connector of the sensor to an Ethernet switch that supports PoE power delivery.
3. Connect the controlling host to the Ethernet switch.
4. Establish a connection between the power sensor and the network.  
See [Chapter 3.6.3.2, "Establishing a Connection to the Network"](#), on page 20.

### Setup with a PoE injector and a non-PoE Ethernet switch

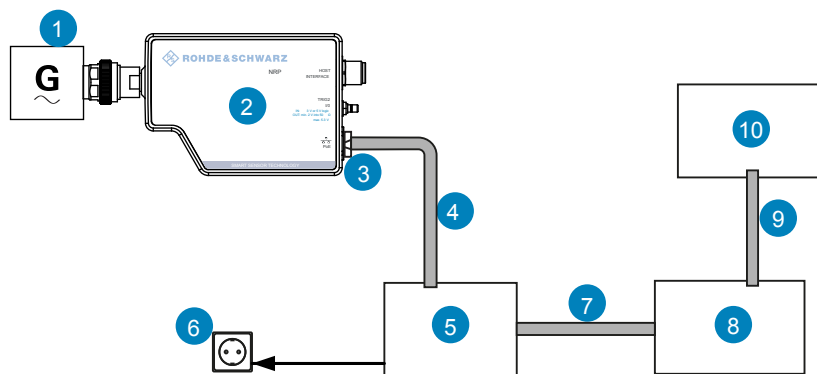

**Figure 3-4: Setup with a PoE injector and a non-PoE Ethernet switch**

- 1 = Signal source
- 2 = LAN power sensor
- 3 = RJ-45 Ethernet connector
- 4, 7, 9 = RJ-45 Ethernet cable
- 5 = PoE injector
- 6 = AC supply
- 8 = Non-PoE Ethernet switch
- 10 = Controlling host

1. Connect the RF connector of the sensor to the DUT.  
See [Chapter 3.4, "Connecting to a DUT"](#), on page 13.
2. **NOTICE!** Risk of sensor damage. Use only PoE power sourcing equipment (PSE) according to IEEE standards 802.3af or IEEE 802.3at. Otherwise your power sensor can get damaged.  
Connect the RJ-45 Ethernet connector of the sensor to the output of the PoE injector.
3. Connect the PoE injector to a power supply.
4. Connect the input of the PoE injector to the non-PoE Ethernet switch.

5. Connect the controlling host to the non-PoE Ethernet switch.
6. Establish a connection between the power sensor and the network.  
See [Chapter 3.6.3.2, "Establishing a Connection to the Network"](#), on page 20.

#### Setup with a PoE injector

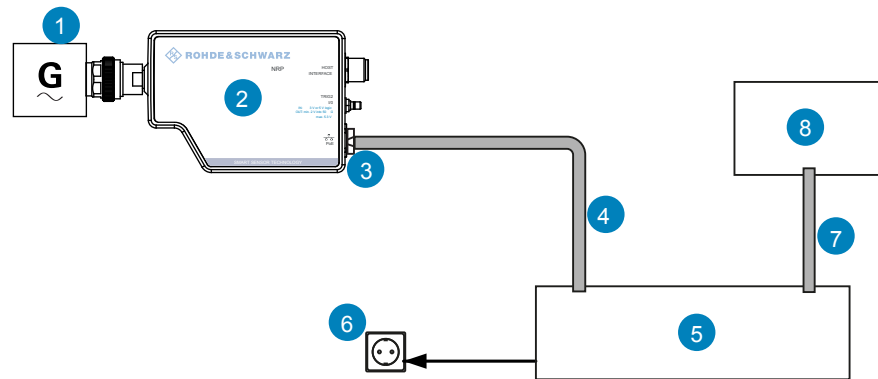

**Figure 3-5: Setup with a PoE injector**

- 1 = Signal source
- 2 = LAN power sensor
- 3 = RJ-45 Ethernet connector
- 4, 7 = RJ-45 Ethernet cable
- 5 = PoE injector
- 6 = AC supply
- 8 = Controlling host

1. Connect the RF connector of the sensor to the DUT.  
See [Chapter 3.4, "Connecting to a DUT"](#), on page 13.
2. **NOTICE!** Risk of sensor damage. Use only PoE power sourcing equipment (PSE) according to IEEE standards 802.3af or IEEE 802.3at.  
Otherwise your power sensor can get damaged.  
Connect the RJ-45 Ethernet connector of the sensor to the output of the PoE injector.
3. Connect the PoE injector to a power supply.
4. Connect the controlling host to the input of the PoE injector.
5. Establish a network connection between the power sensor and the controlling host.

#### 3.6.3.2 Establishing a Connection to the Network

There are two methods to establish a network connection:

- Power sensor and controlling host are connected to a common network (infrastructure network).

- Power sensor and controlling host are connected only over the switch (peer-to-peer network).

In both cases, you can address the LAN power sensor as follows:

- [Chapter 3.6.3.3, "Using Hostnames"](#), on page 21
- [Chapter 3.6.3.4, "Assigning the IP Address"](#), on page 22

#### To set up a network Ethernet connection

1. Connect the power sensor as described in [Chapter 3.6.3.1, "Connecting a LAN Power Sensor to the LAN"](#), on page 18.

By default, the power sensor is configured to use dynamic TCP/IP configuration (DHCP) and to obtain the address information automatically.

If both LAN status LEDs are illuminated in green color, the power sensor is correctly connected to the network.

**Note:** Establishing a connection can take up to 2 minutes per device.

2. If the LAN status LEDs show another state, no connection is possible. For possible solutions, see:
  - ["Network status LED"](#) on page 27
  - ["Troubleshooting for peer-to-peer connections"](#) on page 21

#### Troubleshooting for peer-to-peer connections

1. Allow a waiting time, especially if the computer was used in a network before.
2. Check that only the main network adapter is active on the computer. If the computer has more than one network interfaces, explicitly disable all other network interfaces if you plan to utilize a peer-to-peer connection to the power sensor.
3. Check that the remaining main network adapter has been assigned an IP address starting with 169.254. The IANA (Internet assigned numbers authority) has reserved the range 169.254.0.0 to 169.254.255.255 for the allocation of automatic private IP addresses (APIPA). Addresses from this range are guaranteed to cause no conflicts with any routable IP address.
4. Try to establish a connection to the power sensor with both the default hostname and the hostname extended with `.local`, for example:

```
nrp18tn-101441
nrp18tn-101441.local
```

### 3.6.3.3 Using Hostnames

In a LAN that uses a domain name system (DNS) server, each connected computer or instrument can be accessed via an unambiguous hostname instead of an IP address. The DNS server translates the hostname to the IP address. Using the hostname is especially useful when a DHCP server is used, as a new IP address can be assigned each time the instrument is restarted.

Each power sensor is delivered with a default hostname assigned. You can change the default hostname.

### Default hostname

The default hostname follows the syntax:

<device name>-<serial number>, where:

- <device name> is the short name of your sensor.  
For example, the <device name> of R&S NRP18TN is nrp18tn.
- <serial number> is the individual serial number of the power sensor. The serial number is printed on the name plate at the rear side of the sensor. It is part of the device ID printed above the barcode:

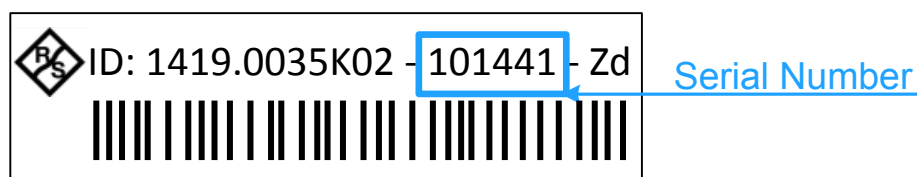

Figure 3-6: Serial number on the name plate

#### Example:

Serial number of the power sensor: 101441

Default hostname: nrp18tn-101441

### Hostname in zero configuration networks, including peer-to-peer networks

The power sensor supports zero configuration networking, used in networks without DHCP server, such as peer-to-peer networks. Thus, you can connect the power sensor to a network without setting up services such as dynamic host configuration protocol (DHCP) and domain name system (DNS), or configuring the network settings manually.

For establishing a connection to the power sensor, try the default hostname and the hostname extended with `.local` as shown in the example below. All communication for resolving names in the top-level-domain (TLD) `.local` are defined to be executed using dedicated local services and ports if no other DNS (domain name server) is available.

#### Example:

Default hostname: nrp18tn-101441

Extended hostname: nrp18tn-101441.local

### 3.6.3.4 Assigning the IP Address

Depending on the network capabilities, the TCP/IP address information for the LAN power sensor can be obtained in different ways:

- If the network supports dynamic TCP/IP configuration using the dynamic host configuration protocol (DHCP), the address information can be assigned automatically.

- If the network does not support DHCP, the LAN power sensor tries to obtain the IP address via the zeroconf (APIA) protocol. If this attempt does not succeed or if the instrument is set to use alternate TCP/IP configuration, the IP address must be set manually.  
For a description on how to set the IP address manually, refer to the user manual.

**Use hostnames to identify the sensor**

In networks using a DHCP server, it is recommended that you address the sensor by its unambiguous hostnames, see [Chapter 3.6.3.3, "Using Hostnames"](#), on page 21.

A *hostname* is a unique identifier of the power sensor that remains permanent as long as it is not explicitly changed. Hence, you can address a power sensor by the same identification, irrespectively if a network or a point-to-point connection is used.

---

## 4 Power Sensor Tour

This chapter provides an overview of the available connectors and LEDs of the power sensor.

In [Figure 4-1](#), the USB power sensor is shown on the left, the LAN power sensor is shown on the right.

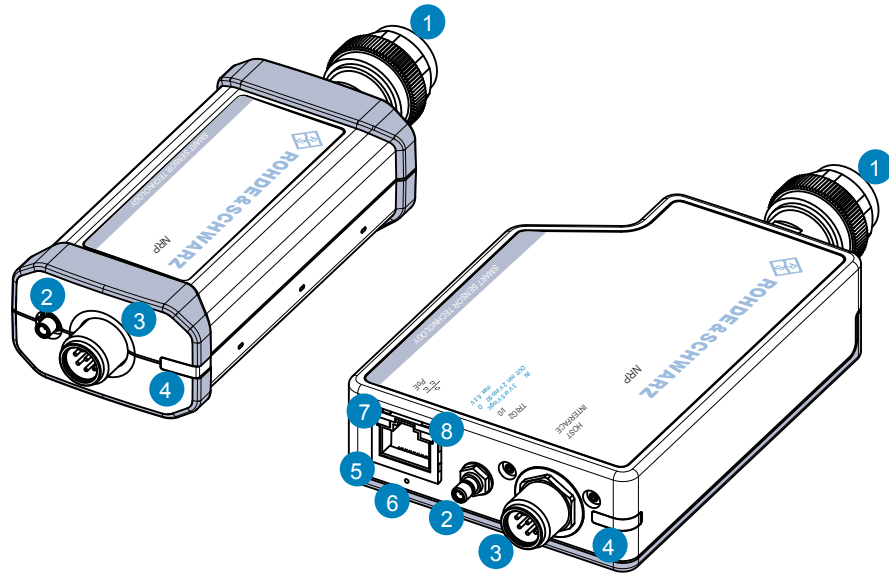

**Figure 4-1: R&S NRP series power sensors (example)**

- 1 = RF connector, see [Chapter 4.1, "RF Connector"](#), on page 24
- 2 = Trigger I/O connector, see [Chapter 4.2, "Trigger I/O Connector"](#), on page 25
- 3 = Host interface connector, see [Chapter 4.3, "Host Interface"](#), on page 25
- 4 = Status LED, see [Chapter 4.4, "Status LED"](#), on page 25
- 5 = LAN connector, see [Chapter 4.5, "LAN PoE Interface"](#), on page 26
- 6 = LAN reset button, see ["LAN reset button"](#) on page 26
- 7 = Power over Ethernet status LED, see ["Power over Ethernet status LED"](#) on page 27
- 8 = Network status LED, see ["Network status LED"](#) on page 27

### 4.1 RF Connector

The RF connector is used for connecting the power sensor to a device under test (DUT) or a signal generator. See [Chapter 3.4, "Connecting to a DUT"](#), on page 13.

For maximum measurement accuracy, tighten the RF connector using a torque wrench with a nominal torque as specified in the following table.



Table 4-1: R&amp;S NRPxxT(N) RF connector characteristics

Power sensor	Male connector	Matching female connector	Tightening torque
R&S NRP18T	N	N	1.36 Nm (12" lbs)
R&S NRP18TN			
R&S NRP33T	3.50 mm	3.50 mm/ 2.92 mm/ SMA	0.90 Nm (8" lbs)
R&S NRP33TN			
R&S NRP40T	2.92 mm		
R&S NRP40TN			
R&S NRP50T	2.4 mm	2.4 mm/ 1.85 mm	
R&S NRP50TN			
R&S NRP67T	1.85 mm		
R&S NRP67TN			
R&S NRP90T	1.35 mm	1.35 mm	
R&S NRP90TN			
R&S NRP110T	1.0 mm	1.0 mm	0.23 Nm (2" lbs)

## 4.2 Trigger I/O Connector

The trigger I/O is a connector of SMB type.

It is used as an input for signals if the trigger source parameter is set to `EXTERNAL2`. It is used as an output for trigger signals if the sensor is operated in the trigger master mode.

Further information:

- [Chapter 9.5.2, "Triggering"](#), on page 70

## 4.3 Host Interface

The host interface is used for establishing a connection between the power sensor and a USB host. For this purpose, an external cable is needed. See [Chapter 3.5, "Connecting a Cable to the Host Interface"](#), on page 14.

## 4.4 Status LED

The status LED gives information about the state of the power sensor. The following states are defined:

Indication		State
○	White	Idle state. The sensor performs no measurement and is ready for use.
○	Flashing white	Firmware update is in progress
○	Slow flashing white	Sanitizing in progress
●	Yellow	Wait for trigger state
●	Green	Measuring state
●	Turquoise blue	Zeroing is in progress
●	Slow flashing red	Static error You can query the error type with <code>SYSTem:SERRor?</code> .
●	Fast flashing red	Critical static error You can query the error type with <code>SYSTem:SERRor?</code> . <b>Note:</b> If this state occurs after a firmware update, the update was not successful. Perform the firmware update again. See also <a href="#">Chapter 12.3, "Problems during a Firmware Update"</a> , on page 157.

## 4.5 LAN PoE Interface

Available only for LAN power sensors.

An RJ-45 connector is used to connect the Ethernet interface of the power sensors to a local area network (LAN).



### Ethernet interface requires PoE (power over Ethernet)

If the Ethernet interface of the LAN power sensors is used, the electrical power has to be provided by power over Ethernet (PoE). In this case, it is *not* possible to provide the power supply via the USB connector instead.

### NOTICE

#### Risk of sensor damage

Use only PoE power sourcing equipment (PSE) according to IEEE standards 802.3af or IEEE 802.3at.

Otherwise your power sensor can get damaged.

#### LAN reset button

The LAN reset button is used for resetting the Ethernet connection parameters of the power sensor to their default values.

**Power over Ethernet status LED**

Available only for LAN power sensor.

The power status LED shows whether the sensor is correctly powered over PoE or not.

Color	State
Green	The sensor is powered over PoE. You can operate it using the Ethernet interface.
No light	No PoE power is present.

**Network status LED**

Available only for LAN power sensor.

The network status LED shows whether the LAN connection to the network is established properly or not.

Color	State
Green	The power sensor is correctly connected to the network. It has been assigned a valid IP address, either manually or via DHCP.
Red	The power sensor is not connected to the network correctly. Either the connection is erroneous or the sensor has not been assigned a valid IP address yet.

## 5 Operating Concepts

For operating the power sensor, you can choose from various possibilities:

- [Chapter 5.2, "Browser-Based User Interface"](#), on page 31
- [Chapter 5.3, "Remote Control"](#), on page 33
- [Chapter 5.4, "R&S NRPV"](#), on page 33
- [Chapter 5.5, "R&S Power Viewer"](#), on page 35
- [Chapter 5.6, "R&S Power Viewer Mobile"](#), on page 37
- [Chapter 5.7, "R&S NRX"](#), on page 38
- [Chapter 5.8, "R&S NRP2"](#), on page 39

### 5.1 R&S NRP Toolkit



Before you start using the power sensor, it is recommended to install the R&S NRP Toolkit.

The R&S NRP Toolkit is the basic software package that supplies low-level drivers and tools for all power sensors. The components of the R&S NRP Toolkit depend on the operating system.

#### 5.1.1 Versions and Downloads

The R&S NRP Toolkit is available for the Microsoft Windows operating systems listed under [Chapter 5.1.2, "System Requirements"](#), on page 28, Linux distributions and MacOSX. Several R&S NRP Toolkit versions are available on your documentation CD-ROM.

The latest version for Windows is available at [www.rohde-schwarz.com/software/nrp-toolkit](http://www.rohde-schwarz.com/software/nrp-toolkit).

To obtain an R&S NRP Toolkit for an operating system other than Microsoft Windows, contact the Rohde & Schwarz customer support: [customersupport@rohde-schwarz.com](mailto:customersupport@rohde-schwarz.com)

#### 5.1.2 System Requirements

Hardware requirements:

- Desktop computer or laptop, or an Intel-based Apple Mac
- LAN interface and equipment for setting up a LAN connection.  
See [Chapter 3.6.3, "Using a LAN Connection"](#), on page 18.

Supported operating systems:

- Microsoft Windows versions
  - Microsoft Windows Vista 32/64-bit
  - Microsoft Windows 7 32/64-bit
  - Microsoft Windows 8/ 8.1 32/64-bit
  - Microsoft Windows 10 32/64-bit
- For information on other operating systems, see [Chapter 5.1.1, "Versions and Downloads"](#), on page 28.

### 5.1.3 R&S NRP Toolkit for Windows

The R&S NRP Toolkit installer for Windows-based systems contains the components described in the release notes available at [www.rohde-schwarz.com/software/nrp-toolkit](http://www.rohde-schwarz.com/software/nrp-toolkit).

#### Installing on a computer

1. Start the R&S NRP Toolkit installer on the Windows-based computer.  
In the "NRP-Toolkit Setup" dialog, the correct R&S NRP Toolkit version for your operating system, 32-bit or 64-bit, is already selected.
2. Enable the components you want to install.
  - "NRP-Toolkit (SDK)"  
The software development kit (SDK) provides programming examples for the R&S power sensors.  
See [Chapter 10, "Performing Measurement Tasks - Programming Examples"](#), on page 125.
  - "IVI Shared Components"  
Installs the USBTMC driver. Enabled by default because the installation is recommended.  
See also [Table 11-1](#).

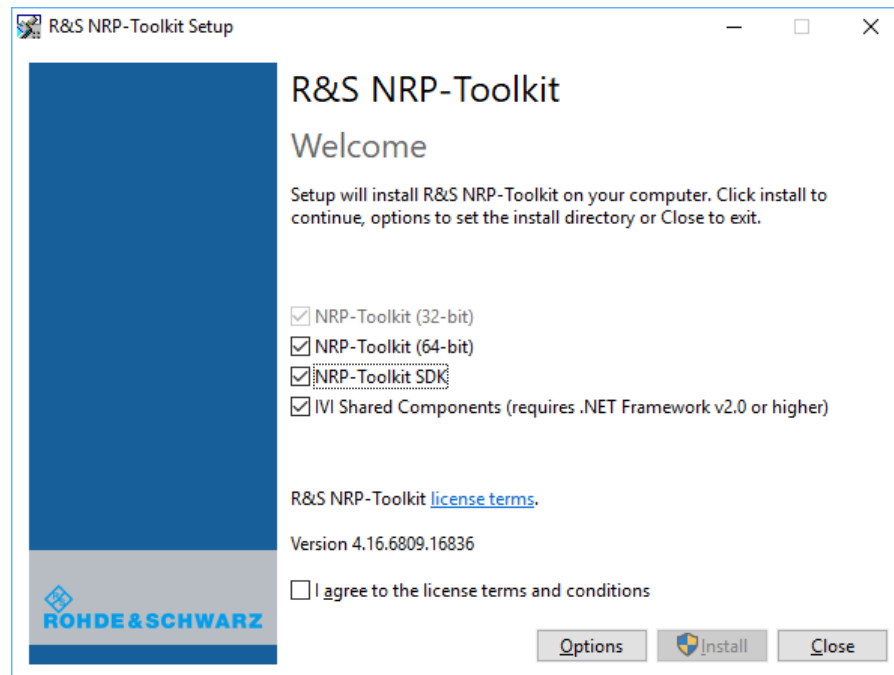

3. Accept the license terms to continue with the installation.
4. Click "Next" and complete the installation process.

### 5.1.3.1 Components of the R&S NRP Toolkit

Access: "Start" > "NRP-Toolkit"

The following tools are part of the R&S NRP Toolkit for Windows.

#### Configure Network Sensor

Useful if you have troubles establishing a LAN connection with an R&S NRP LAN power sensor. The tool provides the following functions:

- Configuring the network settings by (temporary) connecting the selected sensor to the computer using USB.
- Discovering the sensors that have been configured via the Zeroconf (APIA) protocol.

The tool comes with a guide (PDF) that is also available in the "Start" menu. The guide explains the network setup.

#### Firmware Update

You can use the Firmware Update for NRP Family program to load new firmware for the power sensors.

See [Chapter 7, "Firmware Update"](#), on page 54.

**NRP Version Display**

Displays version information of all installed, power measurement-relevant software packages.

**R&S NRP-Z Uncertainty Calculator**

Determines the expanded measurement uncertainty. The tool comes with a manual (PDF) that is also available in the "Start" menu.

**S-Parameter Update Multi**

Helps loading an S-parameter table into the power sensor.

See [Chapter 9.8.3.5, "Using the S-Parameters Tool"](#), on page 96.

**Terminal**

Low-level communication program for sending commands to the power sensor.

## 5.2 Browser-Based User Interface



Requires a power sensor with networking capabilities, a R&S NRP LAN power sensor.

With the integrated, browser-based graphical user interface of the LAN power sensor, you can easily configure the most common settings and measure in the provided measurement modes.

There is no installation required. The web user interface can be used with all devices and operating systems, including tablets and smart phones that are connected to the same network.

**Required equipment**

- R&S NRPxxTN LAN power sensor
- LAN cables
- PoE Ethernet switch or a non-PoE Ethernet switch and a PoE injector
- Device with a supported web browser installed:
  - Mozilla Firefox 33 or later
  - Google Chrome 36 or later
  - Microsoft Internet Explorer 10 or later
  - Safari 5.1 or later

## Setup

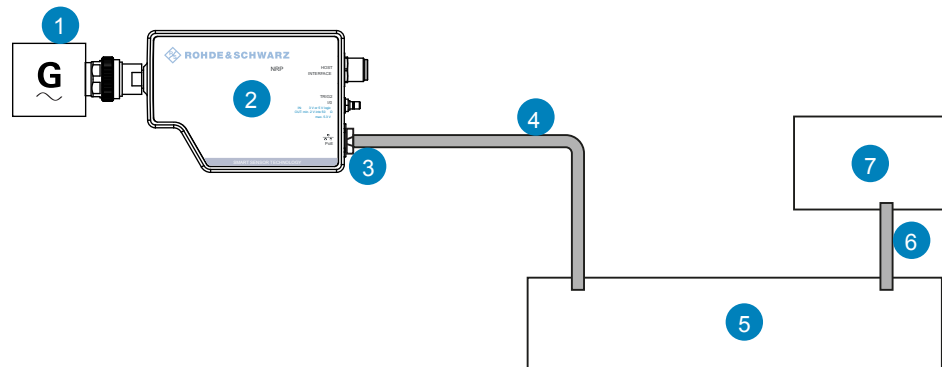

**Figure 5-1: Setup with the web user interface**

- 1 = Signal source
- 2 = LAN power sensor
- 3 = RJ-45 Ethernet connector
- 4, 6 = RJ-45 Ethernet cable
- 5 = Ethernet switch supporting PoE power delivery
- 7 = Computer with a supported web browser installed



Incorrectly connecting/disconnecting the R&S NRPxxT(N) power sensors can damage the power sensors or lead to erroneous results.

Ensure that you connect/disconnect your power sensor as described in [Chapter 3, "Preparing for Use"](#), on page 12.

### Starting a measurement

1. Connect the cables as shown in [Figure 5-1](#).  
For a detailed description, refer to [Chapter 3.6.3, "Using a LAN Connection"](#), on page 18.
2. Open a supported web browser.
3. Enter the instrument name or the IP address of the sensor you want to connect to.  
Example: `http://nrp33tn-123456`  
For details on how to find out the IP address or hostname, refer to [Chapter 3.6.3.4, "Assigning the IP Address"](#), on page 22 and [Chapter 3.6.3.3, "Using Hostnames"](#), on page 21.





The main dialog of the web user interface opens.

4. Select the "Continuous Average" tab and perform any necessary changes.
5. Press "Measurement > ON" to start the measurement.

For a detailed description of the web user interface, refer to [Chapter 6, "Browser-Based User Interface"](#), on page 42.

## 5.3 Remote Control

You can remote control the R&S NRPxxT(N) easily. The change to remote control occurs "on the fly" and has no influence on the manual operation.

Further information:

- [Chapter 9, "Remote Control Commands"](#), on page 61
- [Chapter 11, "Remote Control Basics"](#), on page 128
- [Chapter 11.1, "Remote Control Interfaces and Protocols"](#), on page 128
- [Chapter 3.6.1, "Computer"](#), on page 15

## 5.4 R&S NRPV

The R&S NRPV enables you to measure power in all available measurement modes. Also, you can use up to four power sensors simultaneously.

The R&S NRPV is provided on your documentation CD-ROM and on the Rohde & Schwarz website as a separate standalone installation package.

### Required equipment

- R&S NRPxxT(N) power sensor
- R&S NRP-ZKU cable or an R&S NRP-Z5 sensor hub and an R&S NRP-ZK6 cable to connect the sensor to the computer
- Windows computer with installed:
  - R&S NRP Toolkit V 4.17 or higher
  - R&S NRPV version 3.2 or higher (refer to the operating manual of the R&S NRPV for a description of the installation process)

### Setup

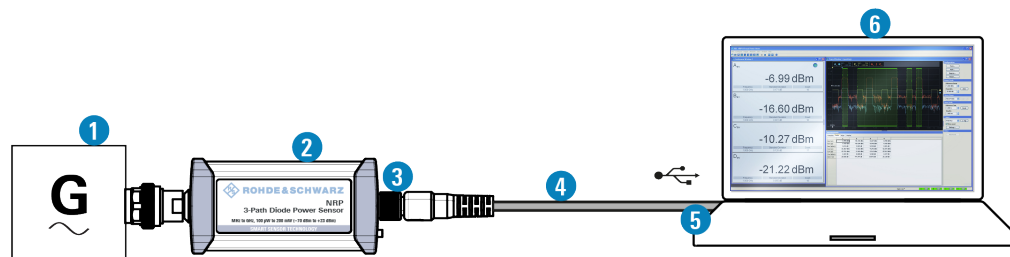

**Figure 5-2: Setup with an R&S NRPV**

- 1 = Signal source
- 2 = R&S NRPxxT(N) power sensor
- 3 = Host interface connector
- 4 = R&S NRP-ZKU cable
- 5 = USB connector
- 6 = Computer with installed R&S NRPV



Incorrectly connecting/disconnecting the R&S NRPxxT(N) power sensors can damage the power sensors or lead to erroneous results.

Ensure that you connect/disconnect your power sensor as described in [Chapter 3, "Preparing for Use"](#), on page 12.

### Starting a measurement

1. Connect the power sensor to the computer as shown in [Figure 5-2](#).  
For a detailed description, refer to [Chapter 3.6.1.1, "Simple USB Connection"](#), on page 15.
2. Start the R&S NRPV.
3. Execute zeroing:
  - Note:** Turn off all measurement signals before zeroing. An active measurement signal during zeroing causes an error.
  - a) Switch off the measurement signal.

- b) Select "Zero > Select > A" (channel short name).

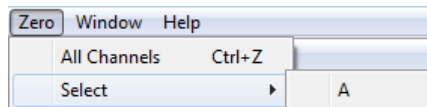

Zeroing takes several seconds. During zeroing, a message shows the progress. After completion, the message reports either success or an error ("Success" / "Failed").

4. Switch on the test signal of the signal source.
5. To start a continuous measurement, select "Measure > Continuous".

The "Continuous" measurement window appears. It shows the measurement results numerically, and the control panel for accessing further dialogs with parameters for measurement, evaluation and display.

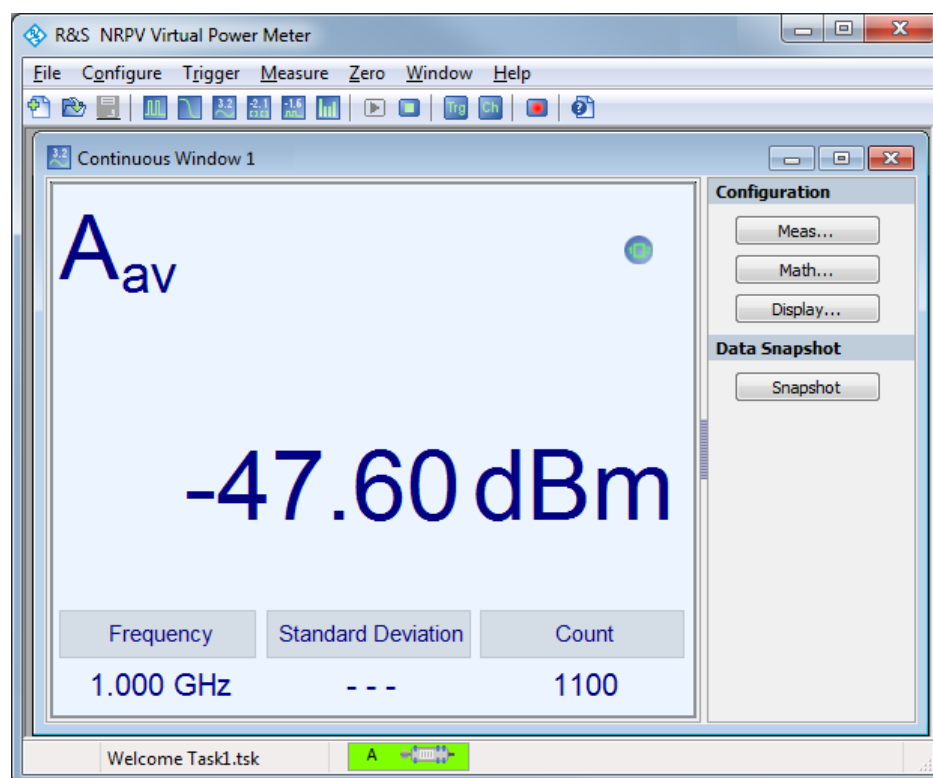

For a detailed description on how to measure in this setup, refer to the operating manual of the R&S NRPV.

## 5.5 R&S Power Viewer

The R&S Power Viewer is software that simplifies many measurement tasks. It is provided on your documentation CD-ROM and on the Rohde & Schwarz website as a separate standalone installation package.

### Required equipment

- R&S NRPxxT(N) power sensor
- R&S NRP-ZKU cable or an R&S NRP-Z5 sensor hub and an R&S NRP-ZK6 cable to connect the sensor to the computer
- Computer with installed:
  - R&S NRP Toolkit V 4.17 or higher
  - R&S Power Viewer version 9.2 or higher (refer to the operating manual of the R&S Power Viewer for a description of the installation process)



If you want to use an android device like a tablet or a smartphone, use the R&S Power Viewer Mobile. For details, see [Chapter 5.6, "R&S Power Viewer Mobile"](#), on page 37.

### Setup

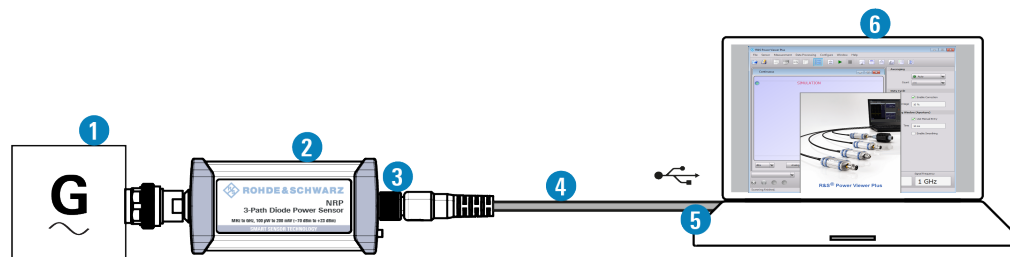

**Figure 5-3: Setup with the R&S Power Viewer**

- 1 = Signal source
- 2 = R&S NRPxxT(N) power sensor
- 3 = Host interface connector
- 4 = R&S NRP-ZKU cable
- 5 = USB connector
- 6 = Computer with installed R&S Power Viewer



Incorrectly connecting/disconnecting the R&S NRPxxT(N) power sensors can damage the power sensors or lead to erroneous results.

Ensure that you connect/disconnect your power sensor as described in [Chapter 3, "Preparing for Use"](#), on page 12.

### Starting a measurement

1. Connect the cables as shown in [Figure 5-3](#).  
For a detailed description, refer to [Chapter 3.6.1.1, "Simple USB Connection"](#), on page 15.
2. Start the R&S Power Viewer.
3. Execute zeroing:
  - Note:** Turn off all measurement power signals before zeroing. An active measurement signal during zeroing causes an error.

- a) Switch off the measurement signal.
- b) Select "Sensor > Zero (Signal off)".

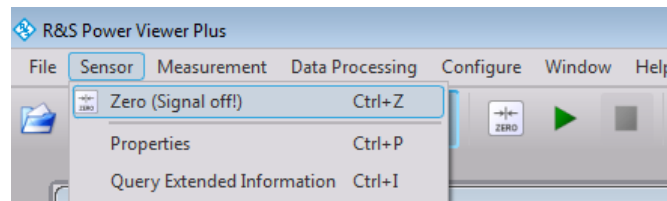

4. Switch on the test signal of the signal source.
5. For a continuous average measurement, select "Measurement" > "Continuous".  
The "Continuous" measurement window appears. It shows the measurement results numerically and some parameters that can be configured.
6. To start the measurement press "Measurement" > "Start".

The measurement result is shown in the "Continuous" measurement window.

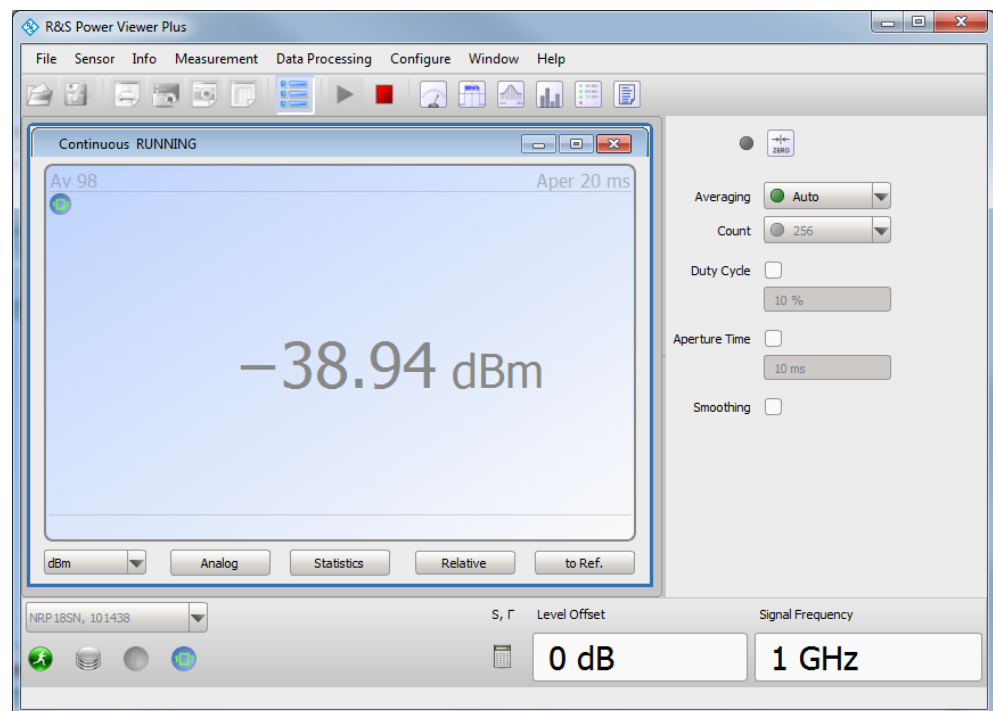

For a detailed description of how to measure in this setup, refer to the operating manual of your R&S Power Viewer. The manual is installed automatically during the installation of the R&S Power Viewer.

## 5.6 R&S Power Viewer Mobile

The R&S Power Viewer Mobile extends the functionality of the R&S Power Viewer to Android-based devices, such as a smartphone and tablets.

You can download the R&S Power Viewer Mobile free of charge from the Google Play Store.

The 1MA215 "Using R&S®NRP Series Power Sensors with Android™ Handheld Devices" application note gives a detailed description on installation and features of the R&S Power Viewer Mobile. The application note is provided on the documentation CD-ROM.

## 5.7 R&S NRX

In a measurement, the R&S NRX uses all sensor-dependent measurement functions and displays the results. Thus, you can configure both the measurement and the power sensor.

### Required equipment

- R&S NRPxxT(N) power sensor
- R&S NRP-ZK8 to connect the sensor to the R&S NRX
- R&S NRX

### Setup

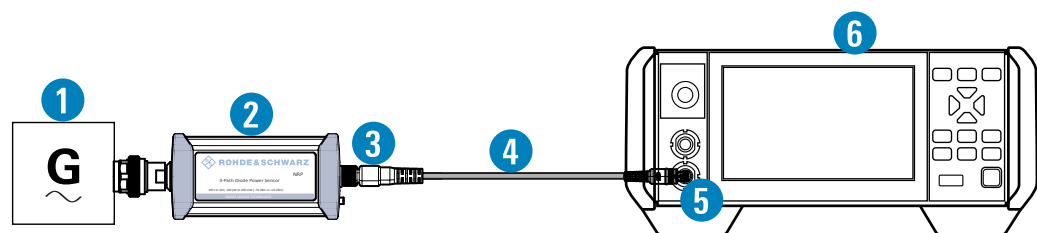

**Figure 5-4: Setup with an R&S NRX base unit**

- 1 = Signal source
- 2 = R&S NRPxxT(N) power sensor
- 3 = Host interface connector
- 4 = R&S NRP-ZK8
- 5 = Sensor input connector of the R&S NRX
- 6 = R&S NRX base unit



Incorrectly connecting/disconnecting the R&S NRPxxT(N) power sensors can damage the power sensors or lead to erroneous results.

Ensure that you connect/disconnect your power sensor as described in [Chapter 3, "Preparing for Use"](#), on page 12.

If the power sensor is a R&S NRP LAN power sensor, you can setup a LAN connection instead of using the sensor input connector of the R&S NRX. See [Chapter 3.6.3, "Using a LAN Connection"](#), on page 18.

### Starting a measurement

1. Preset the R&S NRX and the connected R&S power sensors.
  - a) Press the [Preset] key.
  - b) Tap "Preset".

All parameters are set to their defaults.
2. If measuring in zero-IF mode (RBW > 40 MHz), consider to zero the power sensor:  
**Note:** Turn off all measurement signals before zeroing. An active measurement signal during zeroing causes an error.
  - a) Switch off the power of the signal source.
  - b) Press the [Zero] key of the R&S NRX.
  - c) Tap "Zero All Sensors".
3. Configure the measurement.
  - a) In the "Measurement Settings" dialog, select the "Measurement Type", for example "Continuous Average".
  - b) Tap "Quick Setup" > "Auto Set".
4. Switch on the signal source.

The measurement starts, and the result is displayed in dBm.
5. If necessary, perform further settings.

For a detailed description of how to measure in this setup, refer to the user manual of the R&S NRX.

## 5.8 R&S NRP2

With the R&S NRPxxT(N) power sensors and an R&S NRP2, you can measure power with up to four power sensors simultaneously. All sensor-dependent measurement functions can be used and the results can be displayed in parallel.

### Required equipment

- R&S NRPxxT(N) power sensor
- R&S NRP-ZK6 cable to connect the sensor to the R&S NRP2
- R&S NRP2 base unit with FW version 7.11 or higher

## Setup

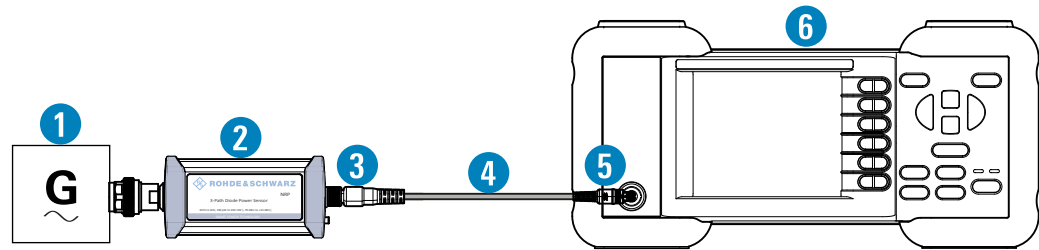

**Figure 5-5: Setup with an R&S NRP2 base unit**

- 1 = Signal source
- 2 = R&S NRPxxT(N) power sensor
- 3 = Host interface connector
- 4 = R&S NRP-ZK6 cable
- 5 = Sensor input connector of the R&S NRP2
- 6 = R&S NRP2 base unit



Incorrectly connecting/disconnecting the R&S NRPxxT(N) power sensors can damage the power sensors or lead to erroneous results.

Ensure that you connect/disconnect your power sensor as described in [Chapter 3, "Preparing for Use"](#), on page 12.

## Starting a measurement

1. Connect the cables as shown in [Figure 5-5](#):
  - a) Connect the R&S NRP-ZK6 cable to the host interface connector of the sensor.
  - b) Connect the R&S NRP-ZK6 cable to a sensor input connector of the R&S NRP2.
  - c) Connect the [RF] connector of the power sensor to the signal source.
2. Preset the R&S NRP2.
  - a) Press the [(PRE)SET] hardkey.  
The "File" menu appears.
  - b) Press the [(PRE)SET] hardkey again or press the "Preset" softkey.  
All parameters are set to their defaults, even when in inactive operating modes.
3. Execute zeroing:
 

**Note:** Turn off all measurement signals before zeroing. An active measurement signal during zeroing causes an error.

  - a) Switch off the power of the signal source.



- b) Press the [ZERO] hardkey of the R&S NRP2.  
The "Zero" dialog box is displayed.

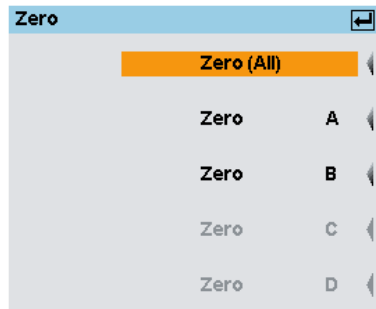

- c) Press the [ZERO] hardkey again to perform zeroing of all connected sensor channels ("Zero (All)") or press the appropriate softkey to select a specific sensor for zeroing.
4. Press the [FREQ] hardkey and enter the carrier frequency of the applied signal if the specified measurement accuracy is to be reached.
5. Switch on the signal source.

The result window indicates the result (in dBm) obtained with sensor A.

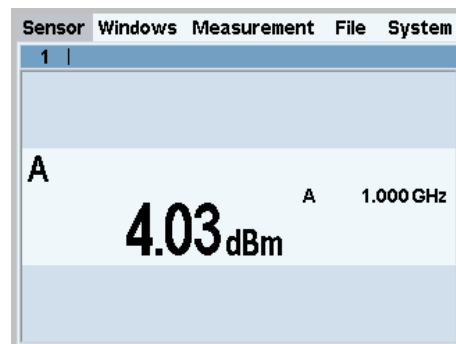

6. If necessary, perform further settings.

For a detailed description of how to measure in this setup, refer to the operating manual of your R&S NRP2.

## 6 Browser-Based User Interface

The web user interface is an alternative way to operate an R&S NRPxxTN LAN power sensor.

This chapter provides a description of the parameters used for setting a power measurement with the web user interface.

For a detailed description of how to connect the sensor to a device and start the web user interface, refer to [Chapter 5.2, "Browser-Based User Interface"](#), on page 31.

### 6.1 Main Dialog of the Web User Interface

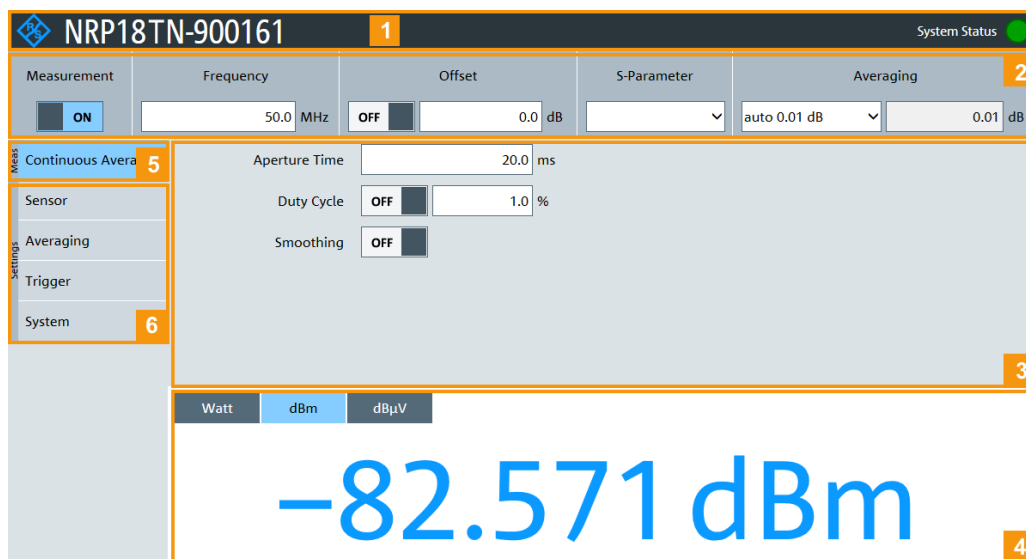

**Figure 6-1: Explanation of the web user interface**

- 1 = Title bar
- 2 = Common settings, see [Chapter 6.3, "Common Settings"](#), on page 44
- 3 = Parameters pane
- 4 = Result pane
- 5 = Navigation pane - "Measurements", see [Chapter 6.4, "Measurement Modes"](#), on page 45
- 6 = Navigation pane - "Settings", see [Chapter 6.5, "Settings"](#), on page 46

The title bar shows the following information:

- Hostname, see also [Chapter 3.6.3.3, "Using Hostnames"](#), on page 21.
- System status, see also [Chapter 4.4, "Status LED"](#), on page 25.

The parameters pane displays the content selected in the navigation pane.

The result pane displays the measurement result for the selected measurement mode. It can display only a value or a graph, depending on the selected measurement mode.

## 6.2 Setting the Unit

You can set the unit for the different parameters by typing the corresponding letter after the entered value.



**Figure 6-2: Parameter**

1 = Parameter name  
 2 = Value  
 3 = Unit

The following abbreviations are available:

Unit	Keyboard key
Decibel	<i>d</i>
Hertz	<i>h</i>
Second	<i>s</i>
Volt	<i>v</i>
Watt	<i>w</i>

Unit multiples	Keyboard key
Giga	<i>g</i>
Mega	<i>m</i>
Kilo	<i>k</i>
milli	<i>m</i>
micro	<i>u</i>
nano	<i>n</i>

**Example:**

To set the unit to 1 GHz, enter *1g*.

For certain units, you can select a different representation, depending on the requirements. For example, for the representation of the "Trigger Level", you can choose Watt, dBm or dB $\mu$ V. To change the unit, you must specify the desired value together with the full new unit once.

**Example:**

To change the representation of a "Trigger Level" of 100µW into dBm, enter *-10dbm* in the "Trigger Level" field. All future entries of solely numbers represent the value in dBm. If you enter *-15* in the field, the "Trigger Level" value is set to -15.00 dBm.

If you want to revert the value to Watt, enter *50uW*. The "Trigger Level" value is set a value of 50.00 µW, thus changing the unit for the further numeric entries.

## 6.3 Common Settings

Describes the common sensor settings that are available for all measurement modes.

Access: main dialog of the web user interface > top pane

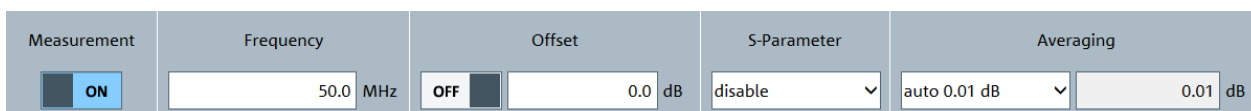

- System Status..... 44
- Measurement..... 44
- Frequency..... 44
- Offset..... 44
  - L <State>..... 45
  - L <Value>..... 45
- S-Parameter..... 45
- Averaging..... 45

**System Status**

Displayed in the title bar. Confirms that there is a connection between the sensor and the remote computer and that the sensor is recognized by the software.

The presentation of this symbolic LED mirrors the physical LED of the sensor. See [Chapter 4.4, "Status LED"](#), on page 25.

**Measurement**

Enables or disables the measurement.

Remote command:

[INITiate:CONTinuous](#) on page 69

**Frequency**

Sets the carrier frequency of the applied signal. This value is used for frequency-response correction of the measurement result.

Remote command:

[\[SENSe<Sensor>:\] FREQuency](#) on page 90

**Offset**

Groups the offset settings.

**<State> ← Offset**

Enables or disables the usage of the level offset.

Remote command:

[SENSe<Sensor>:]CORRection:OFFSet:STATe on page 92

**<Value> ← Offset**

Adds a fixed level offset in dB to account for external losses.

Remote command:

[SENSe<Sensor>:]CORRection:OFFSet on page 91

**S-Parameter**

Selects the mode used for the S-parameters. S-parameters are used to compensate for a component (attenuator, directional coupler) connected ahead of the sensor.

**Averaging**

See "Averaging Mode" on page 49.

## 6.4 Measurement Modes

Describes the parameters for the available measurement modes.

- [Continuous Average Mode](#).....45

### 6.4.1 Continuous Average Mode

Describes the parameters of the continuous average measurement.

Further information:

- [Chapter 9.7.1, "Continuous Average Measurement"](#), on page 83  
Detailed description of the continuous average mode and its remote commands

Access: main dialog of the web user interface > navigation pane > "Continuous Average"

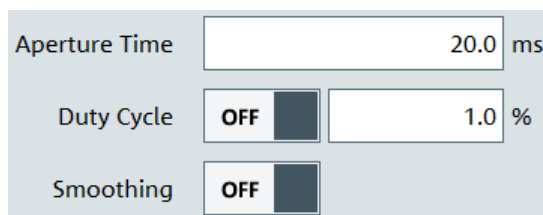

[Aperture Time](#).....45  
[Duty Cycle](#).....46  
[Smoothing](#).....46

**Aperture Time**

Sets the aperture time, the width of the sampling windows.

Remote command:

[SENSe<Sensor>:] [POWer:] [AVG:] APERTure on page 84

**Duty Cycle**

Sets the duty cycle, the percentage of one period during which the signal is active, for pulse modulated signals. If the duty cycle is set, the sensor calculates the signal pulse power from its value and the average power.

Remote command:

[SENSe<Sensor>:] CORRection:DCYCLe:STATe on page 91

[SENSe<Sensor>:] CORRection:DCYCLe on page 91

**Smoothing**

Enables the smoothing filter, a steep-cut off digital lowpass filter. The filter reduces result fluctuations caused by modulation.

Remote command:

[SENSe<Sensor>:] [POWer:] [AVG:] SMOothing:STATe on page 86

## 6.5 Settings

Describes the parameters for general sensor configuration.

- [Sensor Settings](#).....46
- [Averaging Settings](#).....48
- [Trigger Settings](#).....50
- [System Settings](#).....52

### 6.5.1 Sensor Settings

Describes the parameters for optimizing the measurement results for specific measurement requirements.

Further information:

- [Chapter 9.8.3, "Configuring Corrections"](#), on page 90
- [Chapter 9.9, "Calibrating, Zeroing"](#), on page 105
- [Chapter 9.10, "Testing"](#), on page 108

Access: main dialog of the web user interface > navigation pane > "Sensor"

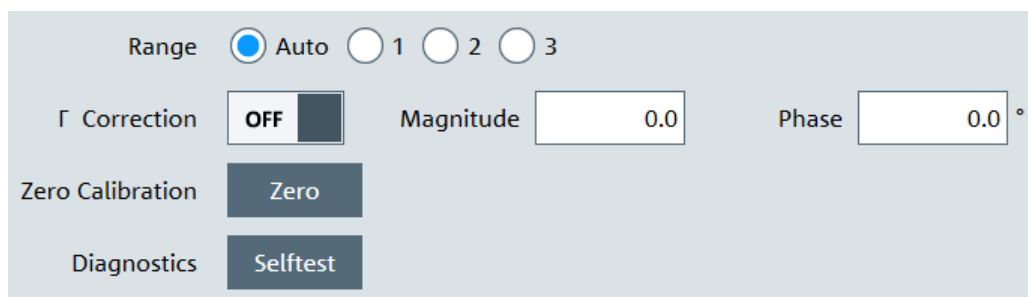

$\Gamma$ Correction.....	47
L <State>.....	47
L Magnitude.....	47
L Phase.....	47
Zero Calibration.....	47
Diagnostics.....	47

### $\Gamma$ Correction

Groups the parameters for the complex reflection coefficient. See also [Chapter 9.8.3.4, "S-Gamma Corrections"](#), on page 94.

#### <State> ← $\Gamma$ Correction

Enables or disables the use of the complex reflection coefficient of the signal source,  $\Gamma_{\text{source}}$ .

Remote command:

[\[SENSe<Sensor>:\] SGAMma:CORRection:STATe](#) on page 95

#### Magnitude ← $\Gamma$ Correction

Sets the magnitude of the complex reflection coefficient of the source,  $\Gamma_{\text{source}}$ .

A value of 0.0 corresponds to an ideal matched source. A value of 1.0 corresponds to total reflection.

Remote command:

[\[SENSe<Sensor>:\] SGAMma:MAGNitude](#) on page 95

#### Phase ← $\Gamma$ Correction

Sets the phase angle of the complex reflection coefficient of the source,  $\Gamma_{\text{source}}$ .

Remote command:

[\[SENSe<Sensor>:\] SGAMma:PHASe](#) on page 95

### Zero Calibration

Performs zeroing using the signal at the sensor input. See [Chapter 9.9, "Calibrating, Zeroing"](#), on page 105.

#### Note:

Turn off all test signals before zeroing. An active test signal during zeroing causes an error.

Remote command:

[CALibration<Channel>:ZERO:AUTO](#) on page 107

### Diagnostics

Triggers a selftest of the sensor.

#### Note:

Do not apply a signal to the sensor while the selftest is running. If the selftest is carried out with a signal being present, error messages can erroneously be output for the test steps *Offset Voltages* and/or *Noise Voltages*.

The results of the selftest are shown in a dialog that is displayed after the test completion.

**Self Test**

Operating Voltages:

+3V3_VCC_MIO:	PASS	(+3.28 V)
+1V8_PS:	PASS	(+1.77 V)
+1V0_PS:	PASS	(+0.98 V)
+3V3_VCC_13:	PASS	(+3.30 V)
+2V5_VCC_34:	PASS	(+2.38 V)
+1V8_VCC_35:	PASS	(+1.80 V)
+1V8_PL:	PASS	(+1.76 V)
+1V0_PL:	PASS	(+1.00 V)
+1V8_LPDDR2_CORE:	PASS	(+1.81 V)
+1V2_LPDDR2:	PASS	(+1.25 V)
+0V6_VREF_LPDDR2:	PASS	(+0.60 V)
+1V25_VREF:	PASS	(+1.25 V)
+1V2_ETHPHY:	PASS	(+1.21 V)
+2V5_ANALOG:	PASS	(+2.54 V)
-2V5_ANALOG:	PASS	(-2.54 V)
VREF_ANALOG:	PASS	(+4.075 V)

Temperatures:

Detector Temperature:	PASS	(+29.9 deg C)
Analog Board Temperature:	PASS	(+29.5 deg C)
Digital Board Temperature:	PASS	(+47.1 deg C)

Offset Voltages: PASS (-0.0034 mV, -0.0034 mV)  
 Noise Voltage: PASS (+0.93 uV)  
 Test Heater Power Drift: PASS (-0.20 %)

**Close**

Remote command:  
[TEST:SENSor?](#) on page 108

### 6.5.2 Averaging Settings

Describes the parameters for automatic averaging.

Further information:

- [Chapter 9.8.1, "Configuring Auto Averaging"](#), on page 86

Access: main dialog of the web user interface > navigation pane > "Averaging"

These settings only apply to continuous average and burst measurements!

Averaging Mode

Filter Terminal Control  Repeating  Moving

Auto Measurement Time  s



Averaging Mode.....	49
L <Mode>.....	49
L <Value>.....	49
Filter Terminal Control.....	49
Auto Measurement Time.....	50

### Averaging Mode

Groups the averaging settings. See also [Chapter 9.8.1, "Configuring Auto Averaging"](#), on page 86.

#### <Mode> ← Averaging Mode

Sets the averaging mode.

- |  |   |
|--|---|
| "manual"   | Disables auto averaging. Enter the average count under " <a href="#">&lt;Value&gt;</a> " on page 49.                                  |
| "auto 1 dB" / "auto 0.1 dB" / "auto 0.01 dB" / "auto 0.001 dB" | Uses an automatic averaging filter with the respective resolution index.  |
| "noise content"  | Predefines the compliance to an exactly defined noise component. Enter this value under " <a href="#">&lt;Value&gt;</a> " on page 49. |

Remote command:

[\[SENSe<Sensor>:\]AVERAge\[:STATe\]](#) on page 90

[\[SENSe<Sensor>:\]AVERAge:COUNT:AUTO](#) on page 87

[\[SENSe<Sensor>:\]AVERAge:COUNT:AUTO:TYPE](#) on page 89

#### <Value> ← Averaging Mode

The content of this field depends on the setting under "[<Mode>](#)" on page 49.

- If "manual" is set:  
Sets the average count, also called averaging factor.
- If "auto xx dB" is set:  
Displays the resolution index.
- If "noise content" is set:  
Sets the maximum noise ratio in the measurement result.

Remote command:

[\[SENSe<Sensor>:\]AVERAge:COUNT](#) on page 87

[\[SENSe<Sensor>:\]AVERAge:COUNT:AUTO:RESolution](#) on page 88

[\[SENSe<Sensor>:\]AVERAge:COUNT:AUTO:NSRatio](#) on page 88

### Filter Terminal Control

Defines how the measurement results are output. This is called termination control.

See also [Chapter 9.5, "Controlling the Measurement"](#), on page 68.

- |             |   |
|-------------|---|
| "Repeating" | Outputs intermediate values to facilitate early detection of changes in the measured quantity. In the settled state, that means when the number of measurements specified by the averaging factor has been performed, a moving average is output. |
|-------------|---|

"Moving" Specifies that a measurement result is not output until the entire measurement has been completed. This means that the number of measurement cycle repetitions is equal to the set averaging factor. If the averaging factor is large, the measurement time can be very long.

Remote command:

[SENSe<Sensor>:]AVERAge:TCONtrol on page 89

**Auto Measurement Time**

Available only if "noise content" is set under "<Mode>" on page 49.

Sets an upper limit for the settling time of the auto-averaging filter, thus limiting the length of the filter.

Remote command:

[SENSe<Sensor>:]AVERAge:COUNT:AUTO:MTIME on page 87

**6.5.3 Trigger Settings**

Describes the trigger parameters. You can define the conditions that have to be fulfilled for a measurement to be triggered.

Further information:

- Chapter 9.5.5, "Configuring the Trigger", on page 74
- Chapter 9.5, "Controlling the Measurement", on page 68

Access: main dialog of the web user interface > navigation pane > "Trigger"

Trigger Source	immediate	
Trigger Level	1.0	µW
Trigger Delay	0.0	s
Dropout	0.0	s
Holdoff	0.0	s
Hysteresis	0.0	dB

Trigger Source.....51

    L <Source>.....51

    L <Slope>.....51

Trigger Level.....51

Trigger Delay.....51

Dropout.....51

Holdoff.....51

Hysteresis.....51

### Trigger Source

Groups the trigger source settings.

#### <Source> ← Trigger Source

Selects the trigger source. See [Chapter 9.5.2.3, "Trigger Sources"](#), on page 71.

Remote command:

[TRIGger:SOURce](#) on page 79

#### <Slope> ← Trigger Source

Sets the polarity of the active slope of the trigger signal that is externally or internally applied.

"Positive"      The rising edge of the trigger signal is used for triggering.

"Negative"      The falling edge of the trigger signal is used for triggering.

Remote command:

[TRIGger:SLOPe](#) on page 79

### Trigger Level

Sets the trigger threshold for internal triggering derived from the test signal.

Remote command:

[TRIGger:LEVel](#) on page 78

[TRIGger:LEVel:UNIT](#) on page 78

### Trigger Delay

Sets the delay between the trigger event and the beginning of the actual measurement.

Remote command:

[TRIGger:DELaY](#) on page 76

### Dropout

With a positive (negative) trigger slope, the dropout time is the minimum time for which the signal must be below (above) the power level defined by "Trigger Level".

Remote command:

[TRIGger:DTIME](#) on page 76

### Holdoff

Sets the hold-off time, a period after a trigger event during which all trigger events are ignored.

Remote command:

[TRIGger:HOLDoff](#) on page 77

### Hysteresis

Sets the hysteresis in dB. A trigger event occurs, if the trigger level:

- Falls below the set value on a rising slope.
- Rises above the set value on a falling slope.

Thus, you can use this setting to eliminate the effects of noise in the signal for the edge detector of the trigger system.

Remote command:  
[TRIGger:HYSTeresis](#) on page 77

### 6.5.4 System Settings

Describes the parameters of the general network environment and specific identification parameters of the power sensor in the network.

Further information:

- [Chapter 9.11, "Configuring the System"](#), on page 108

Access: main dialog of the web user interface > navigation pane > "System"

[IP Address](#).....52  
[Subnet Mask](#).....52  
[Gateway](#).....53  
[DHCP](#).....53  
[Apply Network Settings](#).....53  
[Sensor Name](#).....53  
[Firmware Update](#).....53

#### IP Address

Sets the IP address of the sensor.

Remote command:  
[SYSTem:COMMunicate:NETWork:IPAddress](#) on page 111

#### Subnet Mask

Sets the subnet mask.

The subnet mask consists of four number blocks separated by dots. Every block contains 3 numbers in maximum.

Remote command:  
[SYSTem:COMMunicate:NETWork:IPAddress:SUBNet:MASK](#) on page 112

**Gateway**

Sets the address of the default gateway, that means the router that is used to forward traffic to destinations beyond the local network. This router is on the same network as the instrument.

Remote command:

[SYSTem:COMMunicate:NETWork:IPADdress:GATeway](#) on page 111

**DHCP**

Selects the mode for assigning the IP address.

"Auto" Assigns the IP address automatically, provided the network supports DHCP (dynamic host configuration protocol).

"Static" Enables assigning the IP address manually.

Remote command:

[SYSTem:COMMunicate:NETWork:IPADdress:MODE](#) on page 112

**Apply Network Settings**

After you have made the required network settings changes, apply them to the power sensor by clicking "Apply Network Settings".

**Sensor Name**

Sets the sensor name. The sensor name is displayed in the title bar of the web user interface, see [Figure 6-1](#).

If you do not specify a sensor name, the hostname is used as default. See also [SYSTem:COMMunicate:NETWork\[:COMMON\]:HOSTname](#) on page 110.

Remote command:

[SYSTem\[:SENSor\]:NAME](#) on page 120

**Firmware Update**

Opens a dialog to start the firmware update. For further information, see [Chapter 7.2.2, "Using the Web User Interface"](#), on page 57.

Alternatively, you can the Firmware Update for NRP Family program. See [Chapter 7.2.1, "Using the Firmware Update for NRP Family Program"](#), on page 55.

Remote command:

[SYSTem:FWUPdate](#) on page 114

[SYSTem:FWUPdate:STATus?](#) on page 114

## 7 Firmware Update

- [Hardware and Software Requirements](#)..... 54
- [Updating the Firmware](#)..... 54

### 7.1 Hardware and Software Requirements

For performing a firmware update, the system requirements are as follows:

- Connectors and cables for establishing a connection to the computer  
See [Chapter 3.6.1, "Computer"](#), on page 15.
- Rohde & Schwarz update file (\*.rsu) for the power sensor  
Download the most recent firmware version from the Rohde & Schwarz homepage on the Internet, since the CD-ROM accompanying the power sensor contains the firmware dating from the time of delivery. The latest firmware update files are available at:  
[www.rohde-schwarz.com/en/firmware/nrp\\_t\\_tn/](http://www.rohde-schwarz.com/en/firmware/nrp_t_tn/)  
If the \*.rsu file is packed in a \*.zip archive, extract it before updating.
- If you use the Firmware Update for NRP Family program, further requirements are essential. See ["Checking the prerequisites"](#) on page 55.

### 7.2 Updating the Firmware

#### NOTICE

##### Risk of faulty firmware

Disconnecting the power supply while an update is in progress can lead to missing or faulty firmware.

Take special care not to disconnect the power supply while the update is in progress. Interrupting the power supply during the firmware update most likely leads to an unusable power sensor that needs to be sent in for maintenance.

You can use the following methods to update the firmware installed on the power sensor:

- [Using the Firmware Update for NRP Family Program](#)..... 55
- [Using the Web User Interface](#)..... 57
- [Using Remote Control](#)..... 57

## 7.2.1 Using the Firmware Update for NRP Family Program

Firmware Update for NRP Family is part of the R&S NRP Toolkit. See also [Chapter 5.1, "R&S NRP Toolkit"](#), on page 28.

### Checking the prerequisites

1. Ensure that a recent VISA software is installed on the computer. You can perform a firmware update with Firmware Update for NRP Family only if the power sensor is recognized as a VISA device.
2. Ensure that the R&S NRP Toolkit for Windows is installed on the computer. See [Chapter 5.1, "R&S NRP Toolkit"](#), on page 28.

### Firmware Update for NRP Family

A firmware update can take up to 5 minutes. Ensure that the update is not interrupted.

1. Check the prerequisites, see ["Checking the prerequisites"](#) on page 55.
2. Connect the power sensor to the computer as described in [Chapter 3.6.1, "Computer"](#), on page 15.
3. Start the Firmware Update for NRP Family program:  
"Start" menu > "NRP-Toolkit" > "Firmware Update".

The program automatically starts scanning for Rohde & Schwarz power sensors connected via USB.

When the scan is completed, all recognized power sensors are listed under "Device".

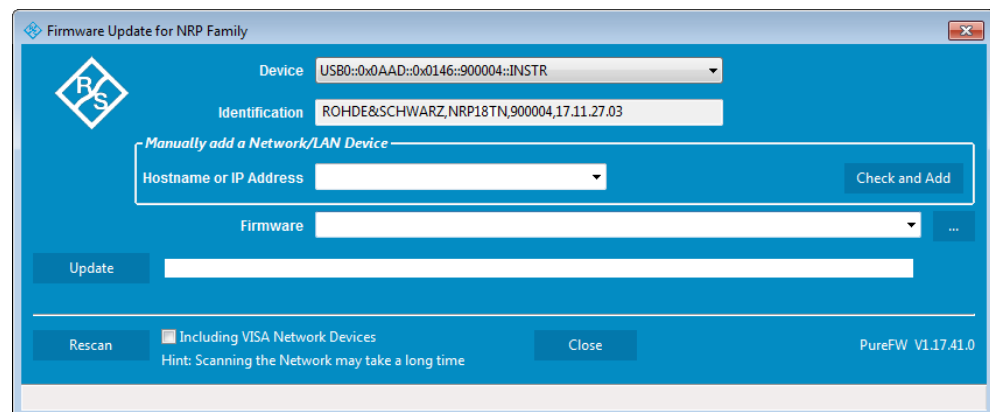

4. If the sensor you want to update is not listed, perform one of the following actions:
  - a) Click "Rescan" to search for attached sensors.
  - b) Check whether all necessary drivers are installed on the computer.  
For example, if the VISA library is not installed on the computer, no VISA power sensor is accessible.  
See also ["Troubleshooting"](#) on page 56.
5. Under "Device", select the sensor you want to update.

**Note:** The "Hostname or IP Address" field is not used during this procedure. Therefore, leave it empty.

6. Under "Firmware", enter the full path and filename of the update file, or press the browse button next to the field. New firmware for the Rohde & Schwarz power sensors generally has an \*.rsu (Rohde & Schwarz update) extension.
7. Click "Update".

During the update process, a progress bar is displayed. The update sequence can take a couple of minutes, depending on the sensor model and the size of the selected file.

8. Check if the update was successful. The firmware version in the "Identification" field must match the version you selected in the "Firmware" field.

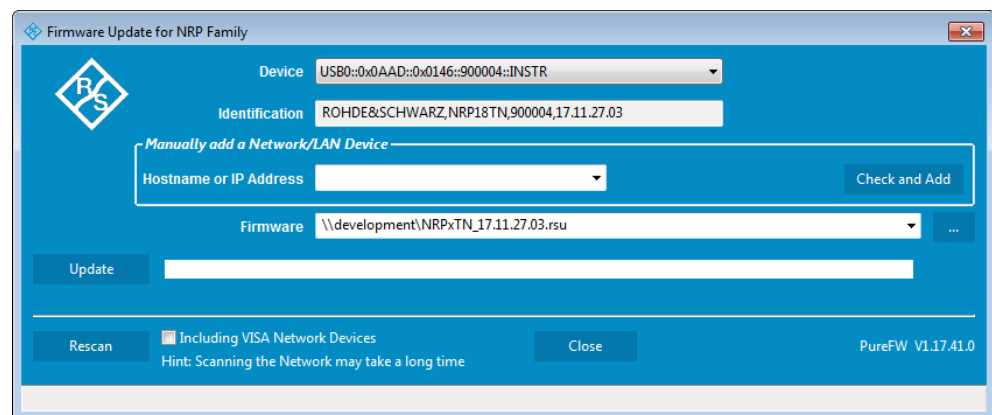

## Troubleshooting

You do not find the sensor in the list of sensors provided by Firmware Update for NRP Family.

The driver assigned to the sensor is the legacy driver.

- ▶ Install a recent VISA software.

The power sensor is highlighted by a yellow exclamation mark in the Windows device manager.

Windows tries in vain to find a USB driver for the power sensor.

- ▶ Install a recent VISA software.

For further information, see [Chapter 12.3, "Problems during a Firmware Update"](#), on page 157.



## 7.2.2 Using the Web User Interface

1. Connect the power sensor to the computer as described in [Chapter 3.6.1, "Computer"](#), on page 15.
2. Open the web user interface as described in [Chapter 5.2, "Browser-Based User Interface"](#), on page 31.
3. In the navigation pane, select "System".
4. Click "Firmware Update".
5. In the "Firmware Update" dialog, click "Select RSU file".
6. In the file browser, select the \*.rsu file for upload.

The selected \*.rsu is displayed, for example NRPxTN\_17.11.27.03.rsu.

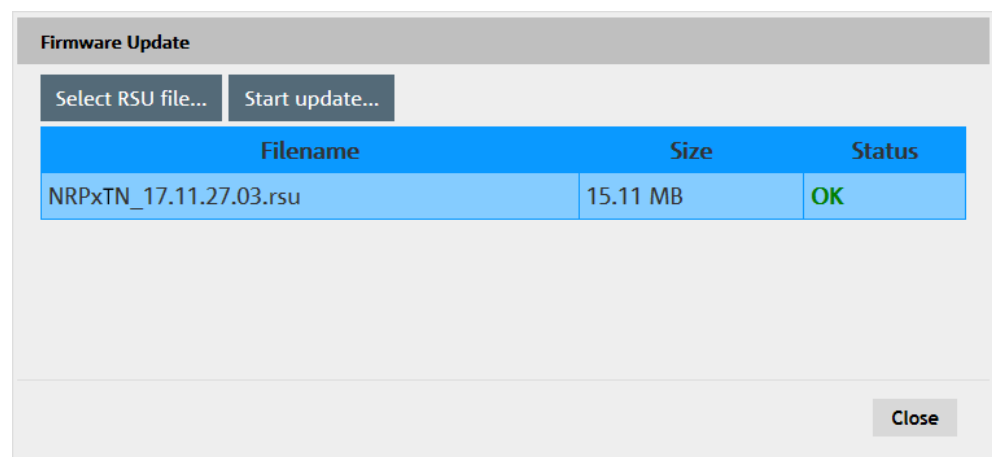

7. Click "Start update".  
The firmware update can take several minutes. During the update process, a progress bar is displayed. When the update is completed, the dialog closes automatically.

## 7.2.3 Using Remote Control

If you want to integrate a firmware update function in an application, use `SYSTEM:FWUPdate` on page 114.

**Example:**

You want to update your R&S NRP18TN with the `nrp18tn_FW_15.02.12.01.rsu` file. This file has a size of 10242884 bytes.

To send the file to the sensor for updating the firmware, your application has to assemble a memory block containing:

```
SYST:FWUP <block_data>
```

The `<block_data>` are definite length arbitrary block data as described in [SYSTem:FWUPdate](#) on page 114.

The size of the file is 10242884. This number has 8 digits. Thus, the `<block_data>` consist of the following:

- #
- 8  
How many digits follow to specify the file size.
- 10242884  
Number that specifies the file size.
- `<file_contents>`  
Contents of the `*.rsu` file, byte-by-byte
- 0x0a  
Delimiter

In this example, you write exactly 10242905 bytes to the power sensor, for example by using a `'viWrite()'` function.

The 10242905 bytes result from the values of the list above:

$$9 + 1 + 1 + 1 + 1 + 8 + 10242884 + 1$$

In a (pseudo) string notation, the memory block looks as follows:

```
SYST:FWUP #810242884<file_contents>0x0a,
```

## 8 Replacing an R&S NRP-Zxx with an R&S NRPxxT(N)

The R&S NRPxxT(N) power sensors are compatible with the R&S NRP-Zxx series of power sensors.

R&S NRPxx power sensor	Replaces R&S NRP-Zxx power sensor
R&S NRP18T / R&S NRP18TN - USB connected	R&S NRP-Z51
R&S NRP33T / R&S NRP33TN - USB connected	R&S NRP-Z52
R&S NRP40T / R&S NRP40TN - USB connected	R&S NRP-Z55 model .03
R&S NRP50T / R&S NRP50TN - USB connected	R&S NRP-Z56
R&S NRP67T / R&S NRP67TN - USB connected	R&S NRP-Z57
R&S NRP90T / R&S NRP90TN - USB connected	-
R&S NRP110T	R&S NRP-Z58



To use the new power sensors, it can be required to update the drivers. For computer-based software applications (R&S NRPV and R&S Power Viewer), install latest R&S NRP Toolkit (V 4.17 or higher).

For using the sensors with R&S NRP2, signal generators, spectrum analyzers or other Rohde & Schwarz instruments, install the latest firmware version.

### 8.1 Most Important Differences

The new and the old sensors are compatible as far as possible. However, there are some differences:

- The state of the sensors is indicated by an LED, see [Chapter 4.4, "Status LED"](#), on page 25.
- After connecting the R&S NRPxxT(N) sensors, the first measurement can be available after 7 seconds (R&S NRP-Zxx: 4 seconds).

### 8.2 Prerequisites

#### R&S NRP Toolkit

Install the R&S NRP Toolkit V 4.17 or higher, see [Chapter 5.1, "R&S NRP Toolkit"](#), on page 28.

The new version of the R&S NRP Toolkit is compatible with both the R&S NRP-Zxx and the R&S NRPxxT(N) so that its installation does not affect the usage of the R&S NRP-Zxx power sensors.

After the new version of the R&S NRP Toolkit is installed, you can connect the R&S NRPxxT(N) to the computer and use it with Rohde & Schwarz software applications or your own programs.

### Software applications and firmware

Software/firmware	Prerequisites
R&S NRPV	See the release notes and the manual of the R&S NRPV.
R&S Power Viewer	See the release notes and the manual of the R&S Power Viewer.
R&S NRP2	Install firmware version 7.11 or higher.
R&S signal generators, spectrum analyzers or other instruments	Install the latest firmware version.

## 9 Remote Control Commands

In the following, all commands implemented in the sensor are listed according to the command system and then described in detail. Mostly, the notation used complies with SCPI specifications.

### 9.1 Conventions Used in SCPI Command Descriptions

Note the following conventions used in the remote command descriptions:

- **Command usage**  
If not specified otherwise, commands can be used both for setting and for querying parameters.  
If a command can be used for setting or querying only, or if it initiates an event, the usage is stated explicitly.
- **Parameter usage**  
If not specified otherwise, a parameter can be used to set a value and it is the result of a query.  
Parameters required only for setting are indicated as **Setting parameters**.  
Parameters required only to refine a query are indicated as **Query parameters**.  
Parameters that are only returned as the result of a query are indicated as **Return values**.
- **Conformity**  
Commands that are taken from the SCPI standard are indicated as **SCPI confirmed**. All commands used by the R&S NRPxxT(N) follow the SCPI syntax rules.
- **Asynchronous commands**  
A command which does not automatically finish executing before the next command starts executing (overlapping command) is indicated as an **Asynchronous command**.
- **Reset values (\*RST)**  
Default parameter values that are used directly after resetting the instrument (\*RST command) are indicated as \*RST values, if available.
- **Default unit**  
The default unit is used for numeric values if no other unit is provided with the parameter.

For further information on units, see also "[Units](#)" on page 135.

### 9.2 Notations

For a detailed description of SCPI notations, see [Chapter 11, "Remote Control Basics"](#), on page 128.

**Numeric suffixes <n>**

If a command can be applied to multiple instances of an object, e.g. specific sensors, the required instances can be specified by a suffix added to the command. Numeric suffixes are indicated by angular brackets (<1...4>, <n>, <l>) and are replaced by a single value in the command. Entries without a suffix are interpreted as having the suffix 1.

**Optional keywords [ ]**

Some command systems permit certain keywords to be inserted into the header or omitted. These keywords are marked by square brackets in the description. The instrument must recognize the long command to comply with the SCPI standard. Some commands are considerably shortened by these optional mnemonics.

Therefore, not only is there a short and a long form for the commands (distinguished here by uppercase and lowercase letters) but also a short form which is created by omitting optional keywords.

**Example:**

Command [SENSe<Sensor>:] [POWer:] [AVG:] SMOothing:STATe 1 can be written as:

```
SENSe1:POWer:AVG:SMOothing:STATe 1
SENS:POW:AVG:SMO:STAT 1
SENSe:POWer:SMOothing:STATe 1
SENSe:SMOothing:STATe 1
SMOothing:STATe 1
SMO:STAT 1
```

**Parameters**

Parameters must be separated from the header by a "white space". If several parameters are specified in a command, they are separated by a comma (.). For a description of the parameter types, refer to [Chapter 11.2.3, "SCPI Parameters"](#), on page 134.

**Example:**

Definition: [SENSe<Sensor>:] AVERage:COUNT:AUtO:NSRatio <nsr>

Command: AVER:COUN:AUtO:NSR 0.01

**Special characters | and { }**

	<p>A vertical bar in parameter definitions indicates alternative possibilities in the sense of "or". The effect of the command differs, depending on which parameter is used.</p> <p><b>Example:</b></p> <p>Definition: INITiate:CONTInuous ON   OFF</p> <p>Command INITiate:CONTInuous ON starts the measurements</p> <p>Command INITiate:CONTInuous OFF stops the measurements</p>
{ }	Parameters in braces may be included in the command once, several times or not at all.

**9.3 Common Commands**

The common commands are taken from the IEEE 488.2 (IEC 625–2) standard. The headers of these commands consist of an asterisk \* followed by three letters.

*CLS.....	63
*ESE.....	64
*ESR?.....	64
*IDN?.....	64
*IST?.....	64
*OPC.....	64
*OPT?.....	65
*PRE.....	65
*RCL.....	65
*RST.....	65
*SAV.....	65
*SRE.....	66
*STB?.....	66
*TRG.....	66
*TST?.....	66
*WAI.....	67

**\*CLS**

CLear Status

Resets the:

- Status byte (STB)
- Standard event register (ESR)
- EVENT part of the QUESTionable and the OPERation register
- Error/event queue

The command does not alter the ENABLE and TRANSition parts of the registers.

**Usage:**                      Event

---

**\*ESE <register>**

Event Status Enable

Sets the event status enable register to the specified value. The query returns the contents of the event status enable register in decimal form.

**Parameters:**

<register>	Range:	0 to 255
	*RST:	0

---

**\*ESR?**

Event Status Read query

Returns the contents of the event status register in decimal form (0 to 255) and subsequently sets the register to zero.

**Usage:** Query only

---

**\*IDN?**

IDeNtification query

Returns a string with information on the sensor's identity (device identification code). In addition, the version number of the installed firmware is indicated.

**Usage:** Query only

---

**\*IST?**

Individual SStatus query

Returns the current value of the IST flag in decimal form. The IST flag is the status bit which is sent during a parallel poll.

**Usage:** Query only

---

**\*OPC**

OPeration Complete

Sets bit 0 in the event status register when all preceding commands have been executed. This bit can be used to initiate a service request. \*OPC must be sent at the end of a program message.

The query form returns a "1" when all previous commands have been processed. It is important that the read timeout is set sufficiently long.

Since \*OPC? waits until all previous commands are executed, "1" is returned in all cases.

\*OPC? basically functions like the \*WAI command, but \*WAI does not return a response.



\*OPC? is preferred to \*WAI because with \*OPC?, the execution of commands can be queried from a controller program before new commands are sent. This prevents overflow of the input queue when too many commands are sent that cannot be executed.

Unlike \*WAI, \*OPC? must be sent at the end of a program message.

### \*OPT?

OPTion identification query

Returns a comma-separated list of installed options.

**Usage:** Query only

### \*PRE <register>

Parallel poll Register Enable

Sets the parallel poll enable register to the specified value or queries the current value.

#### Parameters:

<register>	Range:	0 to 255
	*RST:	0

### \*RCL <number>

ReCaLI

Calls the device state which has been stored with the \*SAV command under the specified number.

#### Setting parameters:

<number>	Range:	0 to 9
	*RST:	0

**Usage:** Setting only

### \*RST

Reset

Sets the instrument to a defined default status. The default settings are indicated in the description of commands.

The command corresponds to the `SYSTem:PRESet` command.

**Usage:** Event

### \*SAV <number>

SAVe

Stores the current device state under the specified number. The storage numbers 0 to 9 are available.

**Setting parameters:**

<number>            Range:     0 to 9  
                          \*RST:     0

**Usage:**             Setting only

---

**\*SRE <register>**

Service Request Enable

Sets the service request enable register to the specified value. This command determines under which conditions a service request is triggered.

**Parameters:**

<register>            Range:     0 to 255  
                          \*RST:     0

---

**\*STB?**

SStatus Byte query

Returns the contents of the status byte in decimal form.

**Usage:**             Query only

---

**\*TRG**

TRiGger

Triggers a measurement. This command is only valid if the power sensor is in the waiting for trigger state and the trigger source is set to `BUS`

See [TRiGger : SOURce](#) `BUS`.

**Usage:**             Event

---

**\*TST?**

Selftest query

Triggers a self test of the instrument and outputs an error code in decimal form. 0 indicates that no errors have occurred.

**Example:**            \*TST?  
                          Query  
                          0  
                          Response: Passed

**Example:**            \*TST?  
                          Query  
                          1  
                          Response: Failed

**Usage:**             Query only

#### \*WAI

WAI to continue

Prevents the execution of the subsequent commands until all preceding commands have been executed and all signals have settled.

**Usage:**             Event

## 9.4 Preparing for the Measurement

Before starting a measurement, you need to do the following:

- [Selecting the Reference Source](#)..... 67
- [Selecting a Measurement Mode](#)..... 68

### 9.4.1 Selecting the Reference Source

The `ROSCillator` subsystem contains commands for configuring the reference source.

**[SENSe<Sensor>:]ROSCillator:SOURce <source>**

Sets the source of the reference oscillator. Refers typically to a precision, stabilized time base.

#### Parameters:

<source>

INTernal | EXTernal | HOST

#### **INTernal**

Internal precision oscillator

#### **EXTernal | HOST**

External signal supplied at the host interface connector.

\*RST:            If the sensor boots or reboots, the source is set to INTernal. If the sensor is reset, the source setting is kept unchanged.

**Example:**            ROSC:SOUR INT

## 9.4.2 Selecting a Measurement Mode

- ▶ Before starting a measurement, select the measurement mode using:

`[SENSe<Sensor>:]FUNction`

The following modes are available:

- Continuous average ("POWER:AVG"): After a trigger event, the power is integrated over a time interval.  
See also [Chapter 9.7.1, "Continuous Average Measurement"](#), on page 83.

---

**[SENSe<Sensor>:]FUNction <function>**

Sets the measurement mode.

**Parameters:**

<function>

**"POWER:AVG"**

Continuous average mode

After a trigger event, the power is integrated over a time interval (averaging) set using:

`[SENSe<Sensor>:] [POWER:] [AVG:] APERTure.`

\*RST: "POWER:AVG"

## 9.5 Controlling the Measurement

The power sensor offers a bunch of possibilities to control the measurement:

- Do you want to start the measurement immediately after the initiate command or do you want to wait for a trigger event?
- Do you want to start a single measurement cycle or a sequence of measurement cycles?
- Do you want to output each new average value as a measurement result or do you want to bundle more measured values into one result?

### 9.5.1 Starting and Ending a Measurement

<a href="#">ABORT</a> .....	69
<a href="#">INITiate:ALL</a> .....	69
<a href="#">INITiate[:IMMediate]</a> .....	69
<a href="#">INITiate:CONTInuous</a> .....	69

**ABORt**

Immediately interrupts the current measurement. If the measurement has been started as a single measurement (`INITiate[:IMMEDIATE]`), the sensor goes into the idle state. However, if a continuous measurement is in progress (`INITiate:CONTInuous ON`), the trigger system of the sensor enters the waiting for trigger state, and if the trigger condition is met, a new measurement is immediately started.

See also [Chapter 9.5, "Controlling the Measurement"](#), on page 68.

**Usage:** Event

**INITiate:ALL****INITiate[:IMMEDIATE]**

Starts a single measurement cycle. The sensor changes from the idle state to the waiting for trigger state. As soon as the trigger condition is fulfilled, the sensor begins the measurement. Depending on the number of trigger events that are required, e.g. for averaging, the sensor enters the waiting for trigger state several times. Once the entire measurement is completed, a measurement result is available, and the sensor enters the idle state again.

Use the command only after the continuous measurement mode has been switched off (`INITiate:CONTInuous OFF`).

See also [Chapter 9.5, "Controlling the Measurement"](#), on page 68.

**Example:** See [Chapter 10.2, "Performing a Buffered Continuous Average Measurement"](#), on page 125.

**Usage:** Event

**INITiate:CONTInuous <state>**

Activates/deactivates the continuous measurement mode. In continuous measurement mode, the power sensor does not go into the idle state after a measurement has been completed, but immediately executes another measurement cycle.

See also [Chapter 9.5.2, "Triggering"](#), on page 70.

**Parameters:**

<state>

**ON**

Measurements are performed continuously. If a measurement is completed, the sensor does not return to the idle state but enters the waiting for trigger state again.

**OFF**

Ends the continuous measurement mode, and sets the sensor to the idle state.

\*RST: OFF

**Example:** See [Chapter 10.2, "Performing a Buffered Continuous Average Measurement"](#), on page 125.

**Manual operation:** See "Measurement" on page 44

## 9.5.2 Triggering

In a basic continuous measurement, the measurement is started immediately after the initiate command, see also [Chapter 9.5.2.2, "Waiting for a Trigger Event"](#), on page 70. However, sometimes you want that the measurement starts only if a specific condition is fulfilled. For example, if a signal level is exceeded, or in certain time intervals. For these cases, you can define a trigger for the measurement.

Further information:

- [Chapter 9.5.5, "Configuring the Trigger"](#), on page 74

### 9.5.2.1 Trigger States

The power sensor has trigger states to define the exact start and stop time of a measurement and the sequence of a measurement cycle. The following states are defined:

- **Idle**  
The power sensor performs no measurement. After powered on, the power sensor is in the idle state.
- **Waiting for trigger**  
The power sensor waits for a trigger event that is defined by the trigger source. When the trigger event occurs, the power sensor enters the measuring state.
- **Measuring**  
The power sensor is measuring data. It remains in this state during the measurement. When the measurement is completed, it exits this state immediately.

### 9.5.2.2 Waiting for a Trigger Event

Before a trigger can be executed, the power sensor has to be set to the waiting for trigger state. Depending on the required number of measurement cycles, you use one of the following commands:

- `INITiate:CONTinuous`  
A new measurement cycle is started automatically after the previous one has been terminated.
- `INITiate[:IMMediate]`  
The number of measurement cycles is restricted.  
If `TRIGger:COUNT 1` is set, the command starts a single measurement cycle that renders one result. Every time you send this command, a new measurement cycle is started.  
Otherwise, as many measurement cycles are performed as determined by the trigger count.

### 9.5.2.3 Trigger Sources

The possible trigger conditions and the execution of a trigger depend on the selected trigger mode and trigger source.

If the signal power exceeds or falls below a reference level set by the trigger level, the measurement is started after the defined delay time. Waiting for a trigger event can be skipped.

Trigger source	Description	Remote commands to initiate the measurement
"Hold"	Triggered by the remote command.	TRIGger:IMMediate
"Immediate"	Measures immediately, does not wait for trigger condition.	-
"Internal"	Uses the input signal as trigger signal.	TRIGger:IMMediate
"External 1"	Uses the digital input signal supplied using a differential pair in the 8-pin sensor cable.	TRIGger:IMMediate
"External 2"	Uses the digital input signal supplied at the SMB connector.	TRIGger:IMMediate
"Bus"	Triggered by the remote command.	*TRG TRIGger:IMMediate

### 9.5.2.4 Dropout Time

The dropout time is useful when dealing with signals with several active slots, for example GSM signals, see [Figure 9-1](#). When measuring in sync with the signal, a trigger event is to be produced at A, but not at B or C.

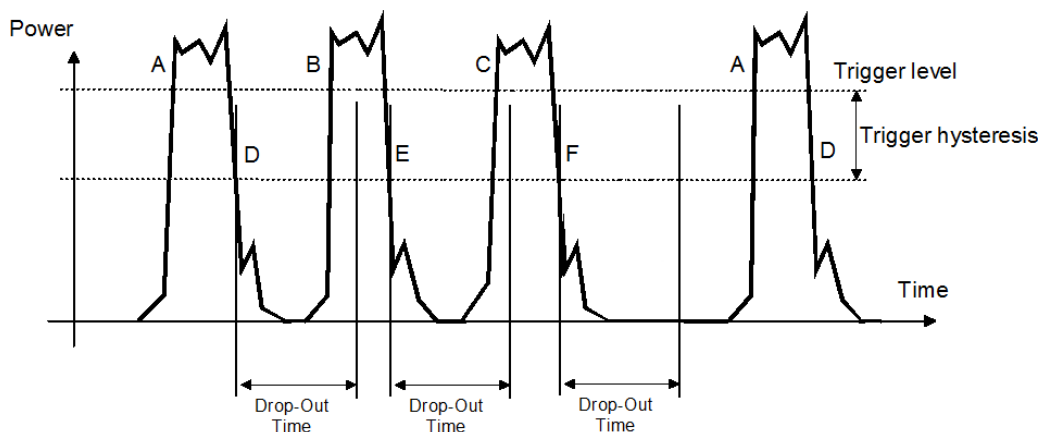

**Figure 9-1: Significance of the dropout time**

The RF power between the slots is below the threshold defined by the trigger level and the trigger hysteresis. Therefore, the trigger hysteresis alone cannot prevent triggering at B or at C. Therefore, set the dropout time greater than the time elapsed between points D and B and between E and C, but smaller than the time elapsed between F and A. Thus, you ensure that triggering takes place at A.

Because the mechanism associated with the dropout time is reactivated whenever the trigger threshold is crossed, you can obtain also unambiguous triggering for many complex signals.

If you use a hold-off time instead of a dropout time, you can obtain stable triggering conditions - regular triggering at the same point. But you cannot achieve exclusive triggering at A.

### 9.5.2.5 Hold-Off Time

During the hold-off time, a period after a trigger event, all trigger events are ignored.

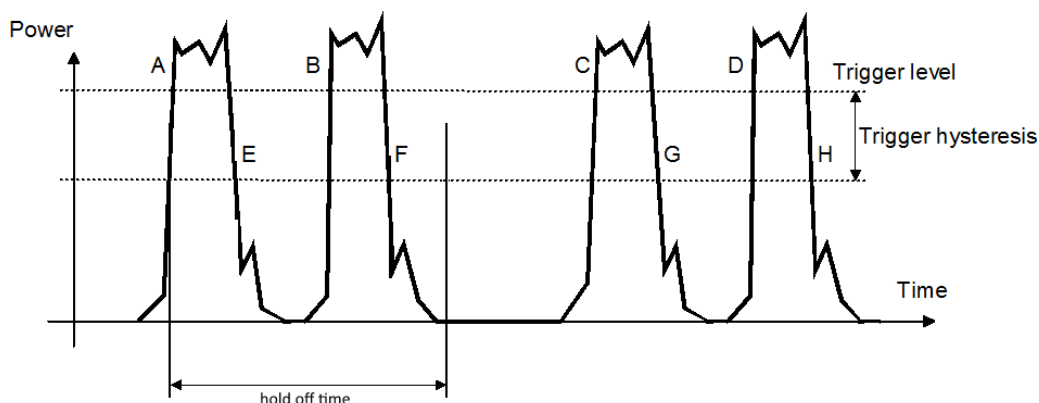

## 9.5.3 Controlling the Measurement Results

The R&S NRPxxT(N) can cope with the wide range of measurement scenarios with the help of the so-called "termination control". Depending on how fast your measurement results change, you can define, how the measurement results are output.

In continuous average mode, use `[SENSe<Sensor>:]AVERage:TCONtrol`.

### Repeating termination control

Outputs a measurement result when the entire measurement has been completed. This means that the number of measurement cycle repetitions is equal to the set average count. If the average count is large, the measurement time can be very long.

Useful if you expect slow changes in the results, and you want to avoid outputting redundant data.

### Moving termination control

Outputs intermediate values to facilitate early detection of changes in the measured quantity. This means that for each partial measurement, a new average value is output as a measurement result. Thus, the measurement result is a moving average of the last partial measurements. How many of the partial measurements are averaged is defined by the average count.



Useful if you want to detect trends in the result during the measurement.

## 9.5.4 Interplay of the Controlling Mechanisms

In the following examples, continuous measurement scenarios are used. But these scenarios apply also to single measurements. The only difference is that a single measurement is not repeated.

### 9.5.4.1 Continuous Average Mode

General settings for these examples:

- `INITiate:CONTinuous ON`
- `[SENSe<Sensor>:]AVERage:COUNT 4`
- `[SENSe<Sensor>:]AVERage:COUNT:AUTO OFF`

#### Example: Repeating termination control

Further settings for this example:

- `[SENSe<Sensor>:]AVERage:TCONTROL REPEAT`

The measurement is started by the trigger event. Due to the chopper phases, one measurement lasts twice the defined aperture time. As defined by the average count, after 4 measurements, the result is averaged and available. During the whole measurement cycle, the trigger synchronization is high (`TRIGger:SYNC:STATE ON`).

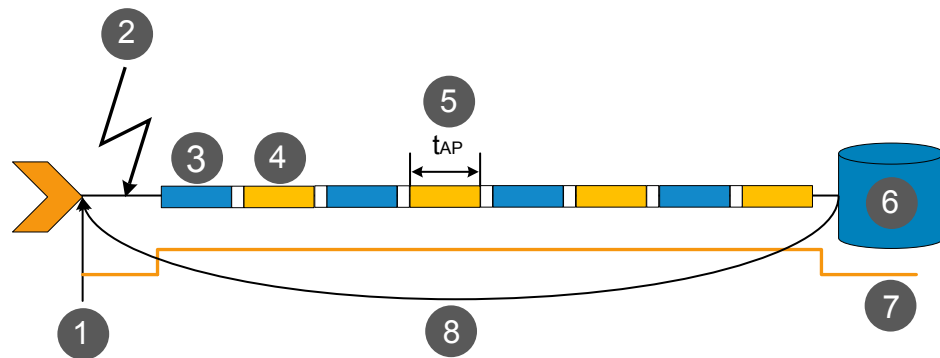

- 1 = Start of the measurement cycle
- 2 = Trigger event
- 3 = Noninverted chopper phase
- 4 = Inverted chopper phase
- 5 = Duration of one aperture time ( $1 \times t_{AP}$ )  $\triangleq$  length of one chopper phase
- 6 = Measurement result
- 7 = Trigger synchronization
- 8 = Return to the start of the measurement cycle

**Example: Moving termination control**

Further settings for this example:

- [SENSe<Sensor>:]AVERAge:TCONtrol MOVing
- TRIGger:COUNt 16

Every measurement is started by a trigger event. Due to the chopper phases, one measurement lasts twice the defined aperture time. During each measurement, the trigger synchronization is high (TRIGger:SYNC:STATe ON). Every measurement provides a result. During the settling phase, the amount of the result is already correct, but the noise is higher. After 4 measurements, when the average count is reached, settled data are available.

When the trigger count is reached (TRIGger:COUNt on page 76), the power sensor returns to the idle state.

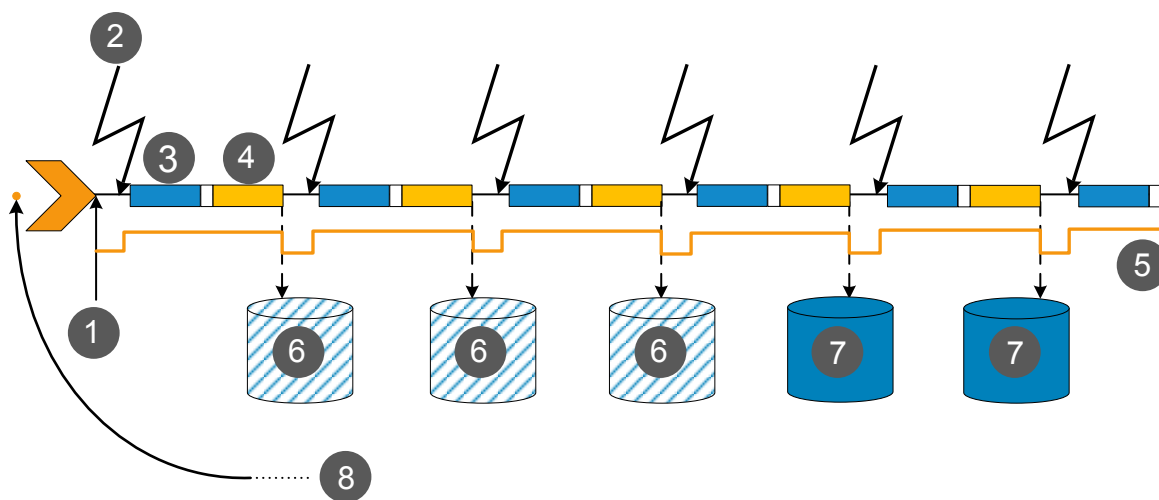

- 1 = Start of the measurement cycle
- 2 = Trigger event
- 3 = Noninverted chopper phase
- 4 = Inverted chopper phase
- 5 = Trigger synchronization
- 6 = Measurement result before average count is reached
- 7 = Averaged measurement result after average count is reached
- 8 = Return to idle state after trigger count (= 16 in this example) is reached

**9.5.5 Configuring the Trigger**

Further information:

- Chapter 9.5, "Controlling the Measurement", on page 68

Remote commands:

TRIGger:ATRigger:DELay.....	75
TRIGger:ATRigger:EXECuted?.....	75
TRIGger:ATRigger[:STATe].....	75
TRIGger:COUNt.....	76

TRIGger:DElay.....	76
TRIGger:DElay:AUTO.....	76
TRIGger:DTIME.....	76
TRIGger:EXternal<2...2>:IMPedance.....	77
TRIGger:HOLDoff.....	77
TRIGger:HYSTeresis.....	77
TRIGger:IMMediate.....	78
TRIGger:LEVel.....	78
TRIGger:LEVel:UNIT.....	78
TRIGger:MASTer:PORT.....	78
TRIGger:MASTer:STATe.....	79
TRIGger:SLOPe.....	79
TRIGger:SOURce.....	79
TRIGger:SYNC:PORT.....	80
TRIGger:SYNC:STATe.....	80

---

### TRIGger:ATRigger:DElay <delay>

Effective only if `TRIGger:ATRigger[:STATe]` is set to ON.

Sets the delay between the artificial trigger event and the beginning of the actual measurement

#### Parameters:

<delay>	Range:	0.1 to 5.0
	*RST:	2.0
	Default unit:	Seconds

---

### TRIGger:ATRigger:EXECuted?

Queries the number of measurements that were triggered automatically since `TRIGger:ATRigger[:STATe]` was set to ON.

In normal scalar measurements, this number can only be 0 or 1. If a buffered measurement was executed, this number indicates how many results in the returned array of measurement data were executed without a real trigger event.

**Usage:** Query only

---

### TRIGger:ATRigger[:STATe] <state>

Controls the automatic trigger function. If enabled, an artificial trigger is generated if the delay time has elapsed after the measurement start and no trigger event has occurred.

The delay time is set using `TRIGger:ATRigger:DElay`.

#### Parameters:

<state>	*RST:	OFF
---------	-------	-----

---

**TRIGger:COUNT** <count>

Sets the number of measurement cycles to be performed when the measurement is started using `INITiate[:IMMEDIATE]`.

This number equals the number of results that can be obtained from the sensor after a single measurement. As long as the defined number of measurements is not executed, the sensor automatically initiates another measurement internally when the current result is available.

This command is particularly useful in conjunction with buffered measurements. For example, to fill a buffer with a predefined size with measurements that have been triggered externally or by `*TRG` without having to start the measurement multiple times.

**Parameters:**

<count>                    Range:     1 to 8192  
                              \*RST:     1

**Example:**                See [Chapter 10.2, "Performing a Buffered Continuous Average Measurement"](#), on page 125.

---

**TRIGger:DELay** <delay>

Sets the delay between the trigger event and the beginning of the actual measurement (integration).

**Parameters:**

<delay>                    Range:     -5.0 to 10.0  
                              \*RST:     0.0  
                              Default unit: s

**Manual operation:**    See ["Trigger Delay"](#) on page 51

---

**TRIGger:DELay:AUTO** <state>

If `TRIGger:DELay:AUTO ON` is set, no measurement is started until the power sensor has settled. For this purpose, the delay value is automatically determined.

If a longer period is set using `TRIGger:DELay`, the automatically determined delay is ignored.

**Parameters:**

<state>                    \*RST:     OFF

---

**TRIGger:DTIME** <dropout\_time>

Sets the dropout time for the internal trigger source. During this time, the signal power must exceed (negative trigger slope) or undercut (positive trigger slope) the level defined by the trigger level and trigger hysteresis. At least, this time must elapse before triggering can occur again.

See [Chapter 9.5.2.4, "Dropout Time"](#), on page 71.

**Parameters:**

<dropout\_time>      Range:      0.00 to 10.00  
                          \*RST:      0.00  
                          Default unit: s

**Manual operation:**    See "[Dropout](#)" on page 51

**TRIGger:EXTernal<2...2>:IMPedance <impedance>**

Effective only if [TRIGger:SOURce EXTernal2](#) is set.

Sets termination resistance of the second external trigger input. Choose the setting that fits the impedance of the trigger source to minimize reflections on the trigger signals.

**Suffix:**

<2...2>                      2

**Parameters:**

<impedance>              HIGH | LOW  
                                  **HIGH**  
                                  ~10 kΩ  
                                  **LOW**  
                                  50 Ω  
                          \*RST:      HIGH

**TRIGger:HOLDoff <holdoff>**

Sets the hold-off time, see [Chapter 9.5.2.5, "Hold-Off Time"](#), on page 72 .

**Parameters:**

<holdoff>                  Range:      0.00 to 10.00  
                                  \*RST:      0.00  
                                  Default unit: Seconds

**Manual operation:**    See "[Holdoff](#)" on page 51

**TRIGger:HYSTeresis <hysteresis>**

Sets the hysteresis. A trigger event occurs, if the trigger level:

- Falls below the set value on a rising slope.
- Rises above the set value on a falling slope

Thus, you can use this setting to eliminate the effects of noise in the signal for the edge detector of the trigger system.

**Parameters:**

<hysteresis>              Range:      0.00 to 10.00  
                                  \*RST:      0.00  
                                  Default unit: DB

**Manual operation:**    See "[Hysteresis](#)" on page 51

**TRIGger:IMMediate**

Causes a generic trigger event. The power sensor leaves the waiting for trigger state immediately, irrespective of the trigger source and the trigger delay, and starts the measurement.

This command is the only way to start a measurement if the trigger source is set to hold (**TRIGger:SOURce** HOLD). Only one measurement cycle is executed, irrespective of the averaging factor.

**Usage:** Event

**TRIGger:LEVel** <level>

Effective only if **TRIGger:SOURce** INTERNAL.

Sets the trigger threshold for internal triggering derived from the test signal.

If you enter a value without unit, the unit is defined by **TRIGger:LEVel:UNIT**.

If an S-parameter device is active and/or if a mounted component with a global offset in front of the sensor is considered, the currently effective trigger threshold and a trigger threshold to be input are referenced to the appropriately shifted sensor data. If the S-parameter device and/or the offset correction are disabled, the trigger threshold and its input limits are adjusted as necessary.

**Parameters:**

<level> Range: 300e-9 to 100.0e-3  
 \*RST: 3.0e-5  
 Default unit: Watts

**Manual operation:** See "Trigger Level" on page 51

**TRIGger:LEVel:UNIT** <unit>

Sets the unit of the trigger level if this value is entered without a unit.

See also **TRIGger:LEVel** on page 78.

**Parameters:**

<unit> DBM | W | DBUV  
 \*RST: W

**Manual operation:** See "Trigger Level" on page 51

**TRIGger:MASTer:PORT** <master\_port>

Selects the port where the sensor outputs its own trigger event in case it is trigger master. See **TRIGger:MASTer:STATe** for more information.

If the sensor is the trigger master, it can output its trigger event either on the **EXTernal<1>** or **EXTernal2**.

If the sensor triggers itself, the trigger source of the sensor must be assigned to the other external port, as shown in the examples.

**Parameters:**

<master\_port> EXT1 | EXTERNAL1 | EXT2 | EXTERNAL2  
 \*RST: EXT1

**Example:**

```
TRIG:MAST:PORT EXT1
TRIG:SOUR EXT2
TRIG:MAST:STAT ON
```

**Example:**

```
TRIG:MAST:PORT EXT2
TRIG:SOUR EXT1
TRIG:MAST:STAT ON
```

**TRIGger:MASTer:STATe** <state>

Enables or disables the trigger master mode of the sensor. In this state, the power sensor can output a digital trigger signal in sync with its own trigger event.

If enabled, select the output port for the trigger signal using [TRIGger:MASTer:PORT](#).

Typically, the trigger master uses its internal trigger source. But you can also trigger the trigger master externally, because the power sensor has got two external trigger connectors. If you trigger the trigger master externally, use [EXTernal1](#) as external trigger input port (trigger source) and [EXTernal2](#) as trigger master output port or vice versa.

**Parameters:**

<state> \*RST: OFF

**TRIGger:SLOPe** <slope>

Effective only if [TRIGger:SOURce](#) is set to [INTernal](#) or [EXTernal](#).

Determines which edge of the envelope power, with internal triggering, or increasing voltage, with external triggering, is used for triggering.

**Parameters:**

<slope> POSitive | NEGative  
**POSitive**  
 Rising edge  
**NEGative**  
 Falling edge  
 \*RST: POSitive

**Manual operation:** See "[<Slope>](#)" on page 51

**TRIGger:SOURce** <source>

Selects the source for the trigger event detector.

**Parameters:**

<source>            HOLD | IMMEDIATE | INTERNAL | BUS | EXTERNAL | EXT1 |  
 EXTERNAL1 | EXT2 | EXTERNAL2

See [Chapter 9.5.2.3, "Trigger Sources"](#), on page 71.

\*RST:            IMMEDIATE

**Manual operation:** See "<Source>" on page 51

**TRIGGER:SYNC:PORT** <sync\_port>

Selects the external connection for the sync output of the sensor. For more information, see [TRIGGER:SYNC:STATE](#).

**Parameters:**

<sync\_port>            EXT1 | EXTERNAL1 | EXT2 | EXTERNAL2

\*RST:            EXT1

**TRIGGER:SYNC:STATE** <state>

Usually used in combination with [TRIGGER:MASTER:STATE](#) ON.

If enabled, blocks the external trigger bus as long as the sensor remains in the measurement state. Thus, ensures that a new measurement is only started after all sensors have completed their measurements.

Make sure that the number of repetitions is the same for all sensors involved in the measurement. Otherwise, the trigger bus is blocked by any sensor that has completed its measurements before the others and has returned to the idle state.

**Parameters:**

<state>                    \*RST:            OFF

## 9.6 Configuring and Retrieving Results

- [Setting the Power Unit](#)..... 80
- [Setting the Result Format](#)..... 81
- [Retrieving Results](#)..... 82

### 9.6.1 Setting the Power Unit

The `UNIT` subsystem contains commands for setting up the power unit.

**UNIT:POWER** <unit>

Sets the output unit for the measured power values.



**Parameters:**

<unit> DBM | W | DBUV  
 \*RST: W

**Example:** UNIT:POW DBM

## 9.6.2 Setting the Result Format

The `FORMat` subsystem sets the format of numeric data (measured values) that is exchanged between the remote control computer and the power sensors if high-level measurement commands are used.

Remote commands:

<code>FORMat:BORDER</code> .....	81
<code>FORMat:SREGister</code> .....	81
<code>FORMat[:DATA]</code> .....	82

---

### **FORMat:BORDER** <border>

Selects the order of bytes in 32-bit or 64-bit binary data.

**Parameters:**

<border> NORMal | SWAPped

**NORMal**

The 1st byte is the least significant byte, the 4th/8th byte the most significant byte.

Fulfills the Little Endian (little end comes first) convention, used by x86/x64 CPUs, for example.

**SWAPped**

The 1st byte is the most significant byte, the 4th/8th byte the least significant byte.

Fulfills the Big Endian (big end comes first) convention.

\*RST: NORMal

**Example:** FORM:BORD NORM

---

### **FORMat:SREGister** <sregister>

Specifies which format is used for the return value of `*STB?`.

**Parameters:**

<sregister> ASCii | HEXadecimal | OCTal | BINary  
 \*RST: ASCii

**Example:** FORM:SREG ASC

**FORMat[:DATA]** [<data,length>, <length>]

Specifies how the R&S NRPxxT(N) sends the numeric data to the controlling host/ computer.

**Parameters:**

<data,length>                   <REAL,32 | 64>

**REAL**

Block of binary values, 32-bit or 64-bit each; so-called "SCPI definite length block"

**32 | 64**

32-bit or 64-bit

If you omit the length, the R&S NRPxxT(N) sets the last used length.

Example for REAL, 32 format:

#6768000....<binary float values>....

Example for REAL, 64 format:

#71536000....<binary float values>....

<data[,length]>               <ASCIi[,0 to 12]>

**ASCIi**

List of comma separated, readable values.

**[,0 to 12]**

Defines the number of decimal places.

The reset value 0 does not restrict the number of decimal places.

Example for ASCIi, 4 format:

1.2938e-06, -4.7269e-11, ...

\*RST:           ASCIi,0

### 9.6.3 Retrieving Results

After performing the measurement, you can query the measurement results with a command from the FETCh subsystem.

Remote commands:

FETCh<Sensor>:ARRay[:POWer][:AVG]?..... 82  
 FETCh<Sensor>[:SCALar][:POWer][:AVG]?.....82

---

**FETCh<Sensor>:ARRay[:POWer][:AVG]?**

Queries the last valid measurement result of a measurement with enabled data buffer mode.

**Usage:**                   Query only

---

**FETCh<Sensor>[:SCALar][:POWer][:AVG]?**

Queries the last valid measurement result.

**Usage:** Query only

## 9.7 Configuring the Measurement Modes

In the following, the settings needed for configuring a measurement mode are described.

Further information:

- [Chapter 9.8, "Configuring Basic Measurement Parameters"](#), on page 86
- [Chapter 9.5, "Controlling the Measurement"](#), on page 68

Contents:

- [Continuous Average Measurement](#).....83

### 9.7.1 Continuous Average Measurement

The continuous average mode measures the signal average power asynchronously within definable time intervals (sampling windows). The aperture (width of the sampling windows) can be defined.

#### Reducing noise and zero offset

The smoothing filter can reduce result fluctuations caused by modulation. But activating it increases the inherent noise of the sensor by approx. 20 %, so do not activate it unless required.

#### Configuring continuous average measurements of modulated signals

When measuring modulated signals in continuous average mode, the measurement can show fluctuation due to the modulation. If that is the case, adapt the size of the sampling window exactly to the modulation period to get an optimally stable display. If the modulation period varies or is not precisely known, you can also activate the smoothing function.

With smoothing activated, the selected sampling window has to be 5 to 9 times larger than the modulation period so that the fluctuations caused by modulation are sufficiently reduced. The sampling values are subjected to weighting (raised-von-Hann window), which corresponds to video filtering.

If you deactivate the smoothing filter, 300 to 3000 periods are required to obtain the same effect. The sampling values are considered equivalent and are averaged in a sampling window, which yields an integrating behavior of the measuring instrument. To obtain optimum suppression of variations in the result, exactly adapt the modulation period to the size of the sampling window. Otherwise, the modulation can have a considerable influence, even if the sampling window is much larger than the modulation period.

### Calculating the measurement time

Normally, the measurement time is calculated as follows:

$$MT = 2 * AC * APER + (2 * AC - 1) * 100 \mu s$$

with:

MT: overall measurement time

AC: average count

APER: aperture time

100  $\mu$ s is the time for switching the chopper phase.

Using `[SENSe<Sensor>:] [POWer:] [AVG:] FAST ON`, you can accelerate the measurement as follows:

- Chopper is disabled.
- Average count is set to 1, no matter which average count you have set.

Thus, the overall measurement time is only defined by the aperture time, and the measurement time for a fast measurement is calculated as follows:

$$MT = APER$$

Remote commands:

<code>[SENSe&lt;Sensor&gt;:] [POWer:] [AVG:] APERture</code> .....	84
<code>[SENSe&lt;Sensor&gt;:] [POWer:] [AVG:] BUFFer:CLEar</code> .....	84
<code>[SENSe&lt;Sensor&gt;:] [POWer:] [AVG:] BUFFer:COUNT?</code> .....	85
<code>[SENSe&lt;Sensor&gt;:] [POWer:] [AVG:] BUFFer:DATA?</code> .....	85
<code>[SENSe&lt;Sensor&gt;:] [POWer:] [AVG:] BUFFer:SIZE</code> .....	85
<code>[SENSe&lt;Sensor&gt;:] [POWer:] [AVG:] BUFFer:STATe</code> .....	85
<code>[SENSe&lt;Sensor&gt;:] [POWer:] [AVG:] FAST</code> .....	86
<code>[SENSe&lt;Sensor&gt;:] [POWer:] [AVG:] SMOothing:STATe</code> .....	86

---

### `[SENSe<Sensor>:] [POWer:] [AVG:] APERture <integration_time>`

Sets the duration of the sampling window in continuous average mode. During this time interval, the average signal power is measured.

#### Parameters:

<integration\_time>    Range:        0.5e-3 to 0.3  
                           \*RST:        0.005  
                           Default unit: Seconds

**Example:**            `APER 0.005`

**Manual operation:**    See "[Aperture Time](#)" on page 45

---

### `[SENSe<Sensor>:] [POWer:] [AVG:] BUFFer:CLEar`

Clears the contents of the result buffer continuous average mode.

**Example:**            `BUFF:CLE`

**Usage:** Event

---

**[SENSe<Sensor>:][POWer:][AVG:]BUFFer:COUNT?**

Available in continuous average mode.

Queries the number of results that are currently stored in the result buffer.

**Example:** BUFF:COUNT?

**Usage:** Query only

---

**[SENSe<Sensor>:][POWer:][AVG:]BUFFer:DATA?**

Queries the results of the continuous average result buffer and returns them even if the buffer is not full.

In contrast, `FETCh<Sensor>[:SCALar][:POWer][:AVG]?` returns a result only if the buffer is full.

**Usage:** Query only

---

**[SENSe<Sensor>:][POWer:][AVG:]BUFFer:SIZE <count>**

Sets the size of the result buffer in continuous average mode.

You can enable the buffer using `[SENSe<Sensor>:][POWer:][AVG:]BUFFer:STATE`.

**Parameters:**

<count>                    Range:     1 to 8192  
                             \*RST:     1

**Example:** BUFF:SIZE 1  
See [Chapter 10.2, "Performing a Buffered Continuous Average Measurement"](#), on page 125.

---

**[SENSe<Sensor>:][POWer:][AVG:]BUFFer:STATe <state>**

Enables or disables the buffered continuous average mode. If the buffer mode is enabled, all results generated by trigger events are collected in the sensor until the buffer is filled.

You can set the size of the buffer using `[SENSe<Sensor>:][POWer:][AVG:]BUFFer:SIZE`.

**Parameters:**

<state>                    ON | OFF  
                             \*RST:     OFF

**Example:** BUFF:STAT OFF

**[SENSe<Sensor>:][POWer:][AVG:]FAST <state>**

Enables or disables a fast unchopped continuous average measurement. If enabled, the average count is enforced to 1, and any setting for average count is silently ignored.

You can increase the measurement accuracy by increasing the duration of the sampling window using `[SENSe<Sensor>:] [POWer:] [AVG:]APERTure`.

See also "[Calculating the measurement time](#)" on page 84.

**Parameters:**

<state>                    \*RST:        OFF

**Example:**                FAST ON

**[SENSe<Sensor>:][POWer:][AVG:]SMOothing:STATe <state>**

Enables or disables the smoothing filter, a steep-edge digital lowpass filter. If you cannot adjust the aperture time exactly to the modulation period, the filter reduces result fluctuations caused by modulation.

**Parameters:**

<state>                    ON | OFF

\*RST:                    OFF

**Example:**                SMO:STAT OFF

**Manual operation:**    See "[Smoothing](#)" on page 46

## 9.8 Configuring Basic Measurement Parameters

The following section describes the settings common for several measurement modes.

### 9.8.1 Configuring Auto Averaging

Describes the commands for automatic averaging in continuous average measurements.

Remote commands:

<code>[SENSe&lt;Sensor&gt;:]AVERage:COUNT</code> .....	87
<code>[SENSe&lt;Sensor&gt;:]AVERage:COUNT:AUTO</code> .....	87
<code>[SENSe&lt;Sensor&gt;:]AVERage:COUNT:AUTO:MTIME</code> .....	87
<code>[SENSe&lt;Sensor&gt;:]AVERage:COUNT:AUTO:NSRatio</code> .....	88
<code>[SENSe&lt;Sensor&gt;:]AVERage:COUNT:AUTO:RESolution</code> .....	88
<code>[SENSe&lt;Sensor&gt;:]AVERage:RESet</code> .....	88
<code>[SENSe&lt;Sensor&gt;:]AVERage:COUNT:AUTO:TYPE</code> .....	89
<code>[SENSe&lt;Sensor&gt;:]AVERage:TCONtrol</code> .....	89
<code>[SENSe&lt;Sensor&gt;:]AVERage[:STATe]</code> .....	90

**[SENSe<Sensor>:]AVERage:COUNT <count>**

Sets the number of readings that are averaged for one measured value. The higher the count, the lower the noise, and the longer it takes to obtain a measured value.

Average count is often also called averaging factor, but it designates the same thing, i.e. the number of measured values that have to be averaged for forming the measurement result.

Averaging is only effective, if `[SENSe<Sensor>:]AVERage[:STATe]` ON is set.

**Parameters:**

<count>                    Range:     1 to 65536  
                              \*RST:     4

**Example:**                AVER:COUN 1

**Manual operation:**    See "<Value>" on page 49

**[SENSe<Sensor>:]AVERage:COUNT:AUTO <state>**

Sets the mode for determining the average count.

**Parameters:**

<state>                    **ON**  
                              Auto averaging: the averaging factor is continuously determined and set depending on the level of power and other parameters.

**OFF**  
                              Fixed filter: the previous, automatically determined averaging factor is used.

**ONCE**  
                              An averaging factor is determined by the filter automatic function under the current measurement conditions and is then used in the fixed filter mode.

                              \*RST:     ON

**Manual operation:**    See "<Mode>" on page 49

**[SENSe<Sensor>:]AVERage:COUNT:AUTO:MTIME <maximum\_time>**

Sets an upper limit for the settling time of the auto-averaging filter if `[SENSe<Sensor>:]AVERage:COUNT:AUTO:TYPE` is set to `NSRatio`. Thus it limits the length of the filter.

**Parameters:**

<maximum\_time>        Range:     0.01 to 999.99  
                              \*RST:     4.00  
                              Default unit: Seconds

**Manual operation:**    See "Auto Measurement Time" on page 50

**[SENSe<Sensor>:]AVERAge:COUNT:AUTO:NSRatio <nsr>**

Determines the relative noise component in the measurement result for the measurement modes with scalar results. These measurement modes are continuous average, burst average and timeslot, provided the particular sensor supports them.

This command is only effective if the auto average calculation is enabled:

- [SENSe<Sensor>:]AVERAge:COUNT:AUTO ON
- [SENSe<Sensor>:]AVERAge:COUNT:AUTO:TYPE NSR

The noise component is defined as the magnitude of the level variation in dB caused by the inherent noise of the sensor (two standard deviations).

The query returns the relative noise component in the measured value.

**Parameters:**

<nsr>                    Range:        100.000e-6 to 1.00  
                           \*RST:        0.01  
                           Default unit: dB

**Manual operation:** See "<Value>" on page 49

**[SENSe<Sensor>:]AVERAge:COUNT:AUTO:RESolution <resolution>**

Defines the number of significant places for linear units and the number of decimal places for logarithmic units which should be free of noise in the measurement result.

The setting is only taken into account, if [SENSe<Sensor>:]AVERAge:COUNT:AUTO ON and [SENSe<Sensor>:]AVERAge:COUNT:AUTO:TYPE RES are set.

**Parameters:**

<resolution>            Range:        1 to 4  
                           \*RST:        3

**Manual operation:** See "<Value>" on page 49

**[SENSe<Sensor>:]AVERAge:RESet**

Deletes all previous measurement results that the averaging filter contains and initializes the averaging filter. The filter length gradually increases from 1 to the set averaging factor. Thus, trends in the measurement result become quickly apparent. Note that the measurement time required for the averaging filter to settle completely remains unchanged.

Use this command if:

- High averaging factor is set.  
   [SENSe<Sensor>:]AVERAge:COUNT
- Intermediate values are output as measurement results.  
   [SENSe<Sensor>:]AVERAge:TCONtrol MOVing
- Power has significantly decreased since the previous measurement, for example by several powers of 10.



In this situation, previous measurement results, which are still contained in the averaging filter, strongly affect the settling of the display. As a result, the advantage of detecting trends in the measurement result while the measurement is still in progress is lost.

**Example:** AVER:RES

**Usage:** Event

**[SENSe<Sensor>:]AVERage:COUNT:AUTO:TYPE <type>**

Sets the automatic averaging filter mode.

**Parameters:**

<type> RESolution | NSRatio

**RESolution**

The usual mode for the power sensors.

**NSRatio**

Predefines the compliance to an exactly defined noise component.

\*RST: RESolution

**Manual operation:** See "<Mode>" on page 49

**[SENSe<Sensor>:]AVERage:TCONTROL <mode>**

Defines how the measurement results are output. This is called termination control.

See also [Chapter 9.5, "Controlling the Measurement"](#), on page 68.

**Parameters:**

<mode> MOVing | REPEAT

**MOVing**

Outputs intermediate values to facilitate early detection of changes in the measured quantity. In the settled state, that means when the number of measurements specified by the average count has been performed, a moving average is output.

**REPEAT**

Specifies that a measurement result is not output until the entire measurement has been completed. This means that the number of measurement cycle repetitions is equal to the set average count. If the average count is large, the measurement time can be very long.

The average count is set using [\[SENSe<Sensor>:\]AVERage:COUNT](#) on page 87.

\*RST: REPEAT

**Example:** AVER:TCON REP

**Manual operation:** See "[Filter Terminal Control](#)" on page 49

---

**[SENSe<Sensor>:]AVERage[:STATe] <state>**

Available in continuous average mode.

Enables or disables the averaging filter.

**Parameters:**

<state>                    \*RST:        ON

**Manual operation:**    See "<Mode>" on page 49

## 9.8.2 Setting the Frequency

The frequency of the signal to be measured is not automatically determined. For achieving better accuracy, the carrier frequency of the applied signal must be set.

---

**[SENSe<Sensor>:]FREQuency <frequency>**

Transfers the carrier frequency of the RF signal to be measured. This frequency is used for the frequency-response correction of the measurement result.

The center frequency is set for broadband signals, e.g. spread-spectrum signals, multi-carrier signals.

**Parameters:**

<frequency>              Range:        0.0 to 110.0e9  
                                  \*RST:        50.0e6  
                                  Default unit: Frequency

**Example:**                `FREQ 10000`

**Manual operation:**    See "Frequency" on page 44

## 9.8.3 Configuring Corrections

It is possible to set some parameters that compensate for a change of the measured signal due to fixed external influences.

- [Duty Cycle Corrections](#)..... 90
- [Offset Corrections](#)..... 91
- [S-Parameter Correction](#)..... 92
- [S-Gamma Corrections](#)..... 94
- [Using the S-Parameters Tool](#)..... 96

### 9.8.3.1 Duty Cycle Corrections

The duty cycle is the percentage of one period during which the signal is active, when pulse-modulated signals are corrected. The duty cycle is only evaluated in the continuous average mode.

Remote commands:

[SENSe<Sensor>:]CORRection:DCYClE..... 91  
 [SENSe<Sensor>:]CORRection:DCYClE:STATe..... 91

**[SENSe<Sensor>:]CORRection:DCYClE <duty\_cycle>**

Available in continuous average mode.

Sets the duty cycle for measuring pulse-modulated signals. The duty cycle defines the percentage of one period during which the signal is active. If the duty cycle is enabled, the R&S NRPxxT(N) takes this percentage into account when calculating the signal pulse power from the average power.

**Parameters:**

<duty\_cycle>            Range:     0.001 to 100.00  
                              \*RST:     1.00  
                              Default unit: Percent

**Manual operation:**    See "Duty Cycle" on page 46

**[SENSe<Sensor>:]CORRection:DCYClE:STATe <state>**

Enables or disables the duty cycle correction for the measured value.

**Parameters:**

<state>                    \*RST:     OFF

**Manual operation:**    See "Duty Cycle" on page 46

**9.8.3.2 Offset Corrections**

The offset accounts for external losses by adding a fixed level offset in dB.

The attenuation of an attenuator located ahead of the sensor (or the coupling attenuation of a directional coupler) is considered with a positive offset. That means the power sensor calculates the power at the input of the attenuator or the directional coupler. A negative offset can be used to correct the influence of an amplifier connected ahead.

Using S-parameters instead of a fixed offset allows more precise measurements, because the interaction between the power sensor and the component can be considered. See also [Chapter 9.8.3.3, "S-Parameter Correction"](#), on page 92.

Remote commands:

[SENSe<Sensor>:]CORRection:OFFSet..... 91  
 [SENSe<Sensor>:]CORRection:OFFSet:STATe..... 92

**[SENSe<Sensor>:]CORRection:OFFSet <offset>**

Sets a fixed offset that is added to correct the measured value.

**Parameters:**

<offset>                    Range:        -200.00 to 200.00  
                                  \*RST:        0  
                                  Default unit: dB

**Manual operation:**    See "<Value>" on page 45

**[SENSe<Sensor>:]CORRection:OFFSet:STATe <state>**

Enables or disables the offset correction.

**Parameters:**

<state>                    \*RST:        OFF

**Example:**                CORR:OFFS:STAT ON

**Manual operation:**    See "<State>" on page 45

**9.8.3.3 S-Parameter Correction**

S-parameter correction compensates for the losses and reflections introduced by a component – such as an attenuator, directional coupler, or matching pad – that is attached to a power sensor. Using S-parameters instead of a fixed offset increases measurement accuracy by accounting for the interaction between the sensor and the component. It shifts the reference plane of the sensor from its RF connector to the input of the device that is being applied externally. For more information on the fundamentals of the S-parameters and for application example, see also [1GP70: Using S-Parameters with R&S®NRP-Z Power Sensors](#).

All R&S NRPxxT(N) power sensors allow compensating for the influence of any 2-port device between the signal source and the sensor input. As a result, the firmware can calculate the power that the signal source actually delivers. Examples of such 2-port devices include attenuators, matching pads, minimum-loss pads and waveguide adapters. One precondition for such compensation is that you provide a complete set of S-parameter data for the 2-port device in the frequency range required by the application.

The S-parameters of the attenuator delivered with the R&S NRPxxT(N) have been measured by Rohde & Schwarz. The results of the factory calibration, including an S-parameter table that matches the delivered attenuator, are stored in the factory calibration data set of the sensor. If you use this attenuator, its effect on the measurement is compensated arithmetically.

**Achieving Maximum Measurement Sensitivity**

For maximum measurement sensitivity, you can choose from the following methods.

**To operate the R&S NRPxxT(N) without an attenuator**

- ▶ Disable the S-parameter correction:
  - Each time after you have put the power sensor into operation.  
    [SENSe<Sensor>:]CORRection:SPDevice:STATe.
  - Permanently, using the S-Parameters tool.

See [Chapter 9.8.3.5, "Using the S-Parameters Tool"](#), on page 96.

**To replace the delivered attenuator with any other 2-port device**

1. Measure the S-parameters of the 2-port device.
2. Load the S-parameters into the power sensor.  
 In the user calibration data set of the power sensor, you can manage the S-parameters of several 2-port devices beside the S-parameters of the attenuator delivered with the power sensor. The sensor can apply the sets of S-parameters individually, depending on which S-parameter device you select as the active device.
3. Make sure that the S-parameter settings - selected S-parameter device, S-parameter correction state - always match the used hardware configuration.

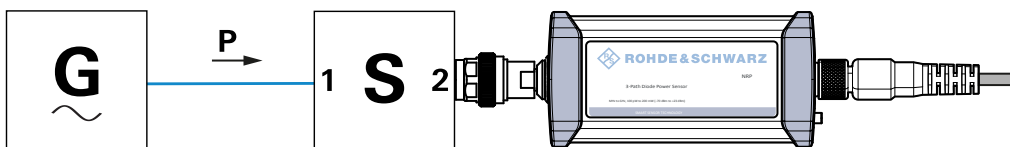

*Figure 9-2: Operation with 2-port device between signal source and sensor input*

**Configuring the S-Parameter Correction**

<a href="#">[SENSe&lt;Sensor&gt;:]CORRection:SPDevice:LIST?</a> .....	93
<a href="#">[SENSe&lt;Sensor&gt;:]CORRection:SPDevice:SElect</a> .....	93
<a href="#">[SENSe&lt;Sensor&gt;:]CORRection:SPDevice:STATe</a> .....	94

**[SENSe<Sensor>:]CORRection:SPDevice:LIST?**

Queries the list of the S-parameter data sets that have been downloaded to the power sensor. The result of the query indicates the consecutive number and mnemonic of each data set.

**Usage:** Query only

**[SENSe<Sensor>:]CORRection:SPDevice:SElect <num>**

Selects a downloaded data set for S-parameter correction.

See also [Chapter 9.8.3.3, "S-Parameter Correction"](#), on page 92.

**Parameters:**

<num> Range: 1 to 1999  
 \*RST: 1; can differ if a calibration set defines another value.

**Manual operation:** See ["S-Parameter Device Locked"](#) on page 99

**[SENSe<Sensor>:]CORRection:SPDevice:STATe <state>**

Activates or deactivates the S-parameter correction. If activated, uses the S-parameter data set selected by [SENSe<Sensor>:]CORRection:SPDevice:SELEct.

See also [Chapter 9.8.3.3, "S-Parameter Correction"](#), on page 92.

**Parameters:**

<state>                    \*RST:            OFF; can differ if a calibration set defines another value.

**Example:**

```
CORR:SPD:SEL 1
Selects an S-parameter correction data set.
CORR:SPD:STAT ON
Activates the S-parameter correction.
```

**Manual operation:** See ["S-Parameter Correction State Locked"](#) on page 98

**9.8.3.4 S-Gamma Corrections**

Using the complex reflection coefficient, you can determine the power  $P$  delivered by the signal source with considerably greater accuracy.

The coefficient of the signal source  $\Gamma_{\text{source}}$  is defined by its magnitude and phase:

- [SENSe<Sensor>:]SGAMma:MAGNitude
- [SENSe<Sensor>:]SGAMma:PHASe

The complex reflection coefficient  $\Gamma_{\text{sensor}}$  of the sensor, which is also required for the correction, is prestored in the calibration data memory for many frequencies.

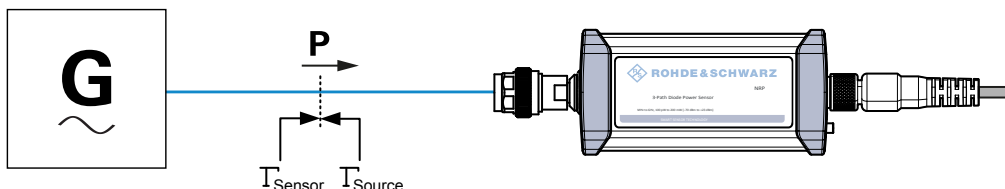

**Figure 9-3: Correction of interactions between the power sensor and the signal source**

If the gamma correction is performed in combination with an S-parameter correction ([SENSe<Sensor>:]CORRection:SPDevice:STATe ON), the following is considered:

- Interaction of the signal source with the S-parameter device
- Input of the power sensor, depending on the transmission, expressed by the term  $S_{12}S_{21}$

If the S-parameter correction is enabled, the interaction between the complex reflection coefficient  $\Gamma_{\text{sensor}}$  of the power sensor and the reflection of port 2, expressed by  $s_{22}$ , is always considered, regardless whether gamma correction is performed or not.

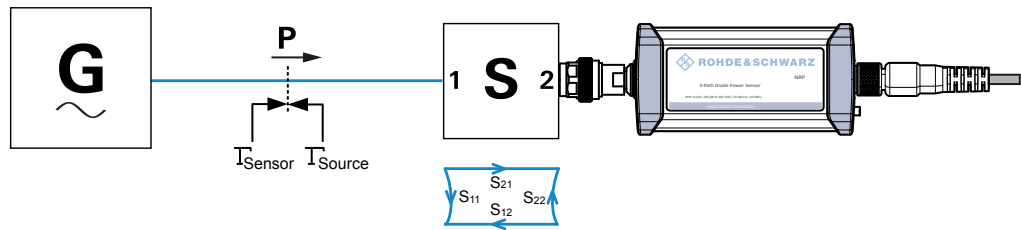

Figure 9-4: Correction of interactions between the power sensor, the signal source, and the S-parameter device

Remote commands:

[SENSe<Sensor>:]SGAMma:CORRection:STATe.....	95
[SENSe<Sensor>:]SGAMma:MAGNitude.....	95
[SENSe<Sensor>:]SGAMma:PHASe.....	95

---

#### [SENSe<Sensor>:]SGAMma:CORRection:STATe <state>

Enables or disables the use of the complex reflection coefficient to correct the interactions of power sensor and signal source.

##### Parameters:

<state>                    \*RST:        OFF

**Manual operation:**    See "<State>" on page 47

---

#### [SENSe<Sensor>:]SGAMma:MAGNitude <magnitude>

Sets the magnitude of the complex reflection coefficient of the source,  $\Gamma_{\text{source}}$ .

##### Parameters:

<magnitude>            0.0  $\triangleq$  ideal matched source  
                                  1.0  $\triangleq$  total reflection  
                                  Range:        0.0 to 1.0  
                                  \*RST:        0.0

**Manual operation:**    See "Magnitude" on page 47

---

#### [SENSe<Sensor>:]SGAMma:PHASe <phase>

Sets the phase angle of the complex reflection coefficient of the source,  $\Gamma_{\text{source}}$ .

##### Parameters:

<phase>                    Range:        -360.0 to 360.0  
                                  \*RST:        0.0

**Manual operation:**    See "Phase" on page 47

### 9.8.3.5 Using the S-Parameters Tool

The S-Parameters tool helps loading an S-parameter table into the power sensor. The S-Parameters tool is part of the R&S NRP Toolkit, see [Chapter 5.1, "R&S NRP Toolkit"](#), on page 28.

#### To start the S-Parameters tool

- ▶ In the Windows start menu, select "NRP Toolkit" > "S-Parameter Update Multi".

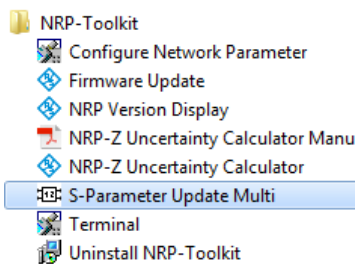

#### User Interface of the S-Parameters Tool

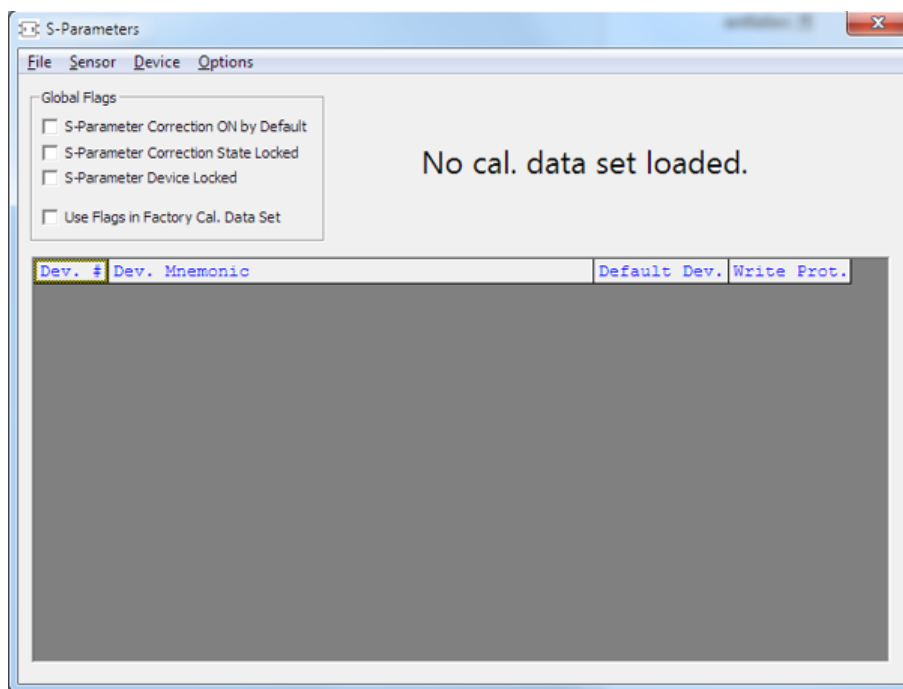

Figure 9-5: S-Parameters dialog

Menu bar.....	97
L File.....	97
L Sensor.....	97
L Device.....	97
L Options.....	97
L User Data.....	97
L Remote.....	97
L Show Cal. Data.....	98



Global Flags..... 98

- L S-Parameter Correction ON by Default..... 98
- L S-Parameter Correction State Locked..... 98
- L S-Parameter Device Locked..... 99
- L Use Flags in Factory Cal. Data Set..... 99

Device table..... 99

**Menu bar**

Contains the following submenus.

**File ← Menu bar**

Provides options for loading and saving calibration data files, see:

- "To change the S-parameter data" on page 101
- "To load an uncertainty parameter file" on page 102

**Sensor ← Menu bar**

Provides options for loading and saving calibration data directly from or to the sensor, see:

- "To load a calibration data set from a power sensor" on page 100
- "To save the calibration data to the sensor" on page 103

**Device ← Menu bar**

Provides functions for editing the table of S-parameter devices.

**Options ← Menu bar**

Provides functions for editing user data, changing remote control timeouts, and displaying calibration data as plain text.

**User Data ← Options ← Menu bar**

Opens the "User Data" dialog.

Here, you can enter the name of the calibration laboratory and the calibration engineer that is stored in the calibration data set if changes are made.

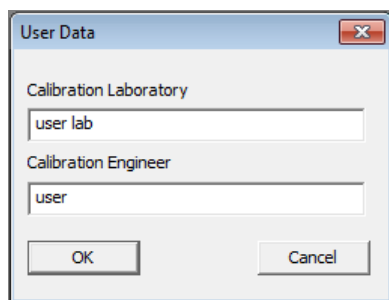

**Remote ← Options ← Menu bar**

Opens the "Remote Control Settings" dialog. It is normally not necessary to change timeouts.

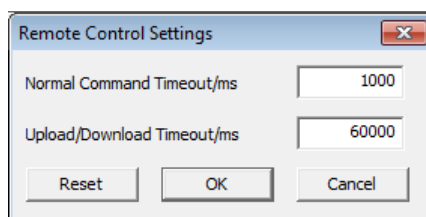

### Show Cal. Data ← Options ← Menu bar

Displays the content of the calibration data set that has been loaded either from a file or directly from a sensor as a plain text.

You can copy the text output to the clipboard by clicking "Copy to Clipboard."

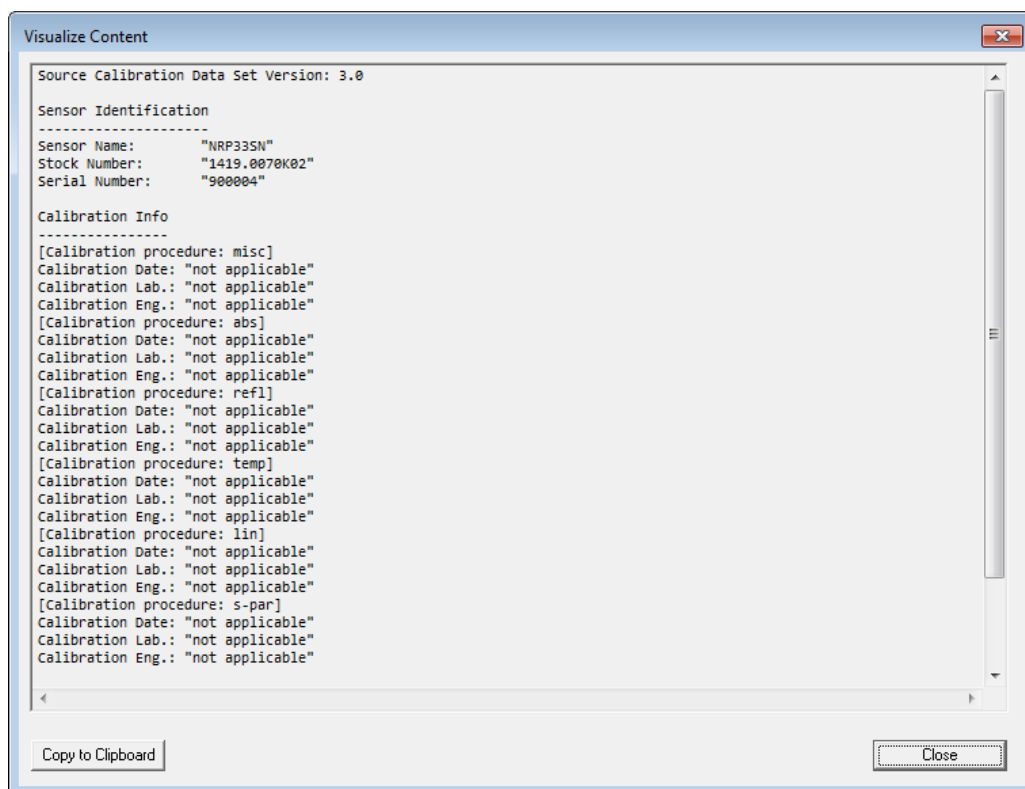

Figure 9-6: Example

### Global Flags

Groups the settings for the power sensor behavior regarding S-parameter corrections.

#### S-Parameter Correction ON by Default ← Global Flags

If this option is enabled, the S-parameter correction is activated automatically when the sensor is started.

#### S-Parameter Correction State Locked ← Global Flags

If enabled, the state that is selected with "S-Parameter Correction ON by Default" is locked and cannot be changed using:

- `[SENSe<Sensor>:]CORRection:SPDevice:STATe`

- R&S NRP2 base unit

**S-Parameter Device Locked ← Global Flags**

If enabled, the S-parameter device that is selected as the default device in the table of S-parameter devices is locked and cannot be changed using:

- [SENSe<Sensor>:]CORRection:SPDevice:SElect
- R&S NRP2 base unit

The default S-parameter device is the S-parameter device that you have selected when the power sensor is started.

**Use Flags in Factory Cal. Data Set ← Global Flags**

Available if the power sensor supports two different calibration data sets:

- Factory calibration data set containing all factory calibration data.
- User calibration data set that contains the S-parameter devices you have loaded.

**Note:** After you have added S-parameter devices and configured the global flags, disable this option. Otherwise, it is not possible to enable S-parameter correction because the flags in the factory calibration data set prevent it.

**Device table**

Shows a list of all S-parameter devices that are available in the calibration data set.

If you double-click an entry, a dialog for the device is opened that allows to import, export, and edit S-parameter data. See "[To change the S-parameter data](#)" on page 101.

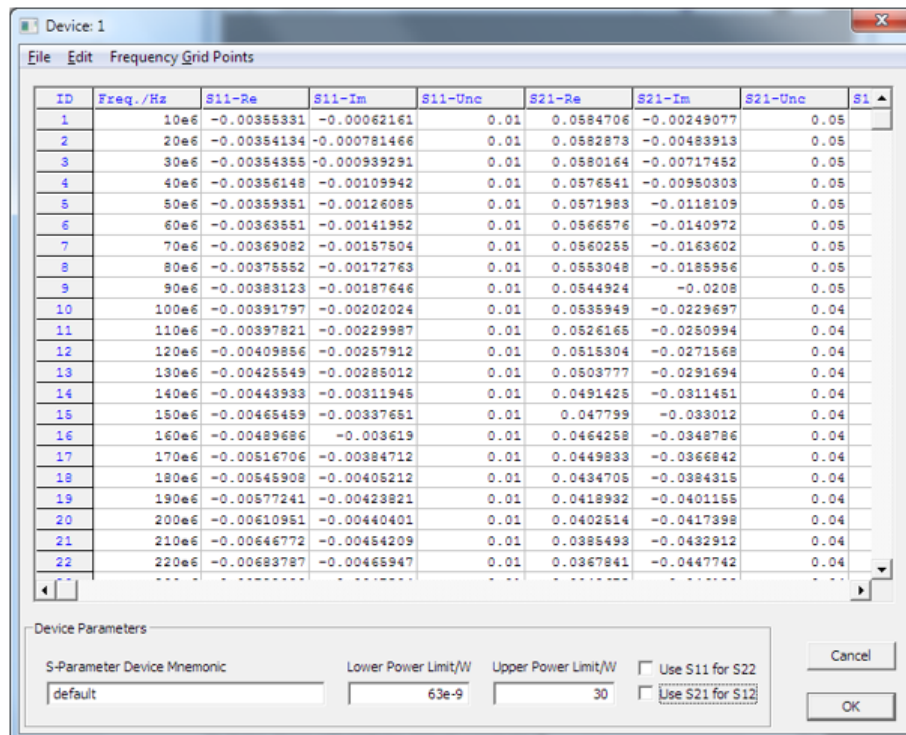

## Performing Configuration Tasks

In this chapter, different configuration tasks performed with the power sensor and the "S-Parameter Update Multi" tool are described.

### To load a calibration data set from a power sensor

Prerequisites: The power sensor is connected to the computer and a connection is established.

1. Open the "S-Parameter Update Multi" program.
2. Select "Sensor" > "Load Calibration Data".

The "Upload Calibration Data" dialog opens. It shows a list of the available sensors.

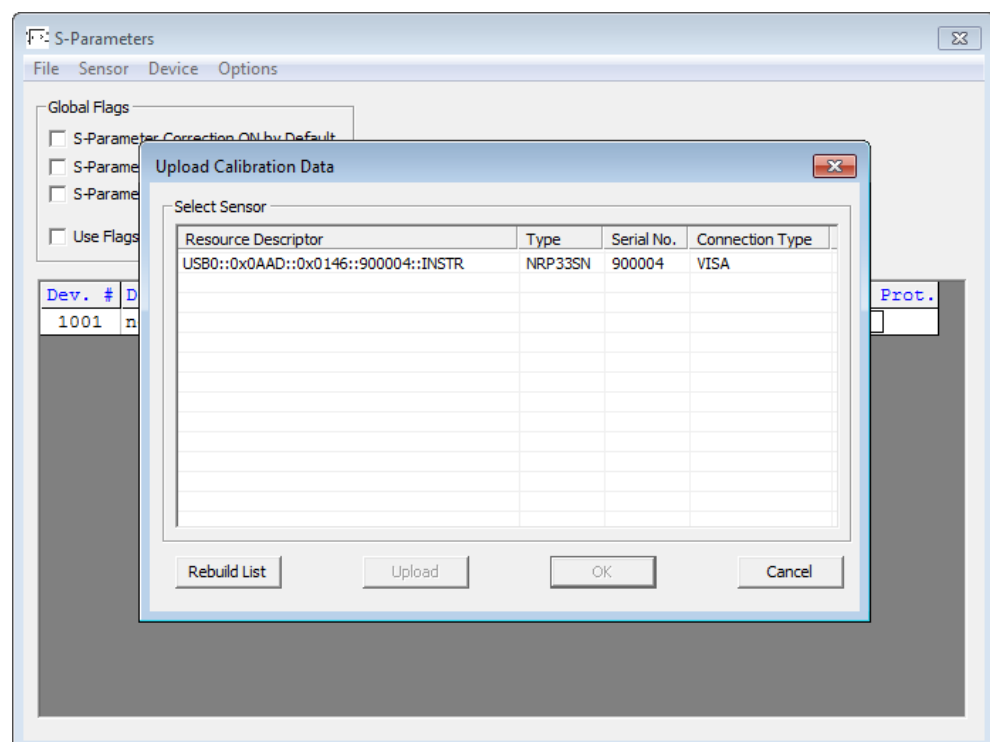

3. If you cannot find your power sensor in the list, for example because of reconnecting the power sensor, you can reload the list by clicking "Rebuild List".
4. Click "Upload" to load calibration data from the power sensor. After the upload is finished, the "OK" button is enabled.
5. Click "OK" to apply the changes. If you want to discard the changes, exit the dialog by clicking "Cancel".

After a successful upload, the name and serial number is shown in the name of the main dialog.

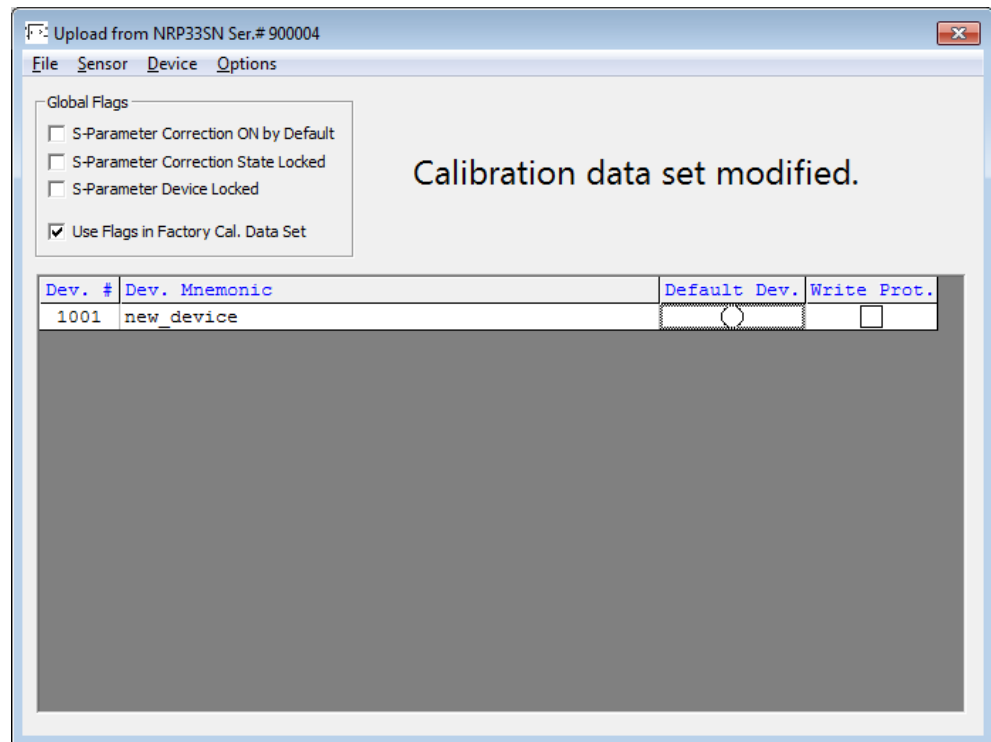

6. Create a backup of the calibration data set before making any changes.  
Select "File" > "Save Calibration Data".  
A dialog opens where you can select the location to save the calibration data.

#### To change the S-parameter data

1. In the device table, double-click an entry. See also "[Device table](#)" on page 99.
2. Select "File" > "Import S2P".
3. Select the \*.S2P file you want to import, and confirm with "Open".

The data from the selected file is loaded in the device table.  
All uncertainties are set to zero.

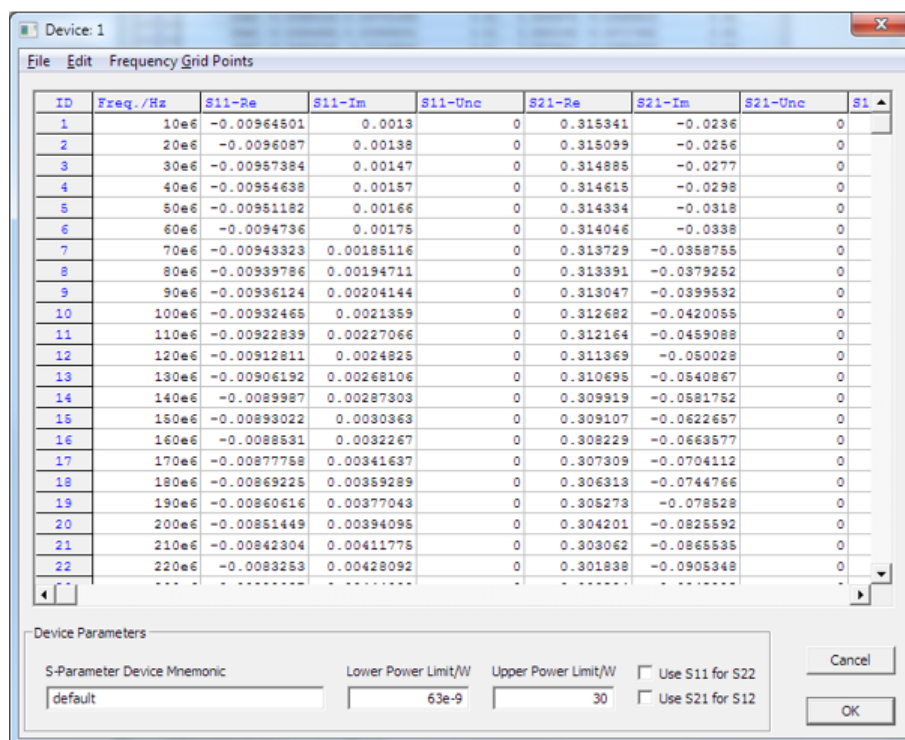

- If needed, load uncertainty data. See ["To load an uncertainty parameter file"](#) on page 102.
- Check the entries in the "S-Parameter Device Mnemonic", "Lower Power Limit/W" and "Upper Power Limit/W" fields and change them, if necessary.  
For example, the lower and upper power limits are deduced from the power limits of the sensor itself and the minimum attenuation of the S-parameter device. If the "Upper Power Limit/W" entry is higher than the power dissipation rating of the attenuator, reduce it accordingly.
- Click "OK" to apply the changes.  
If you want to discard the change, click "Cancel".

#### To load an uncertainty parameter file

- In the device table, double-click an entry. See also ["Device table"](#) on page 99.
- Select "File" > "Import uncertainties".
- Select the file you want to import, and confirm with "Open".  
The data from the selected file is loaded in the device table.

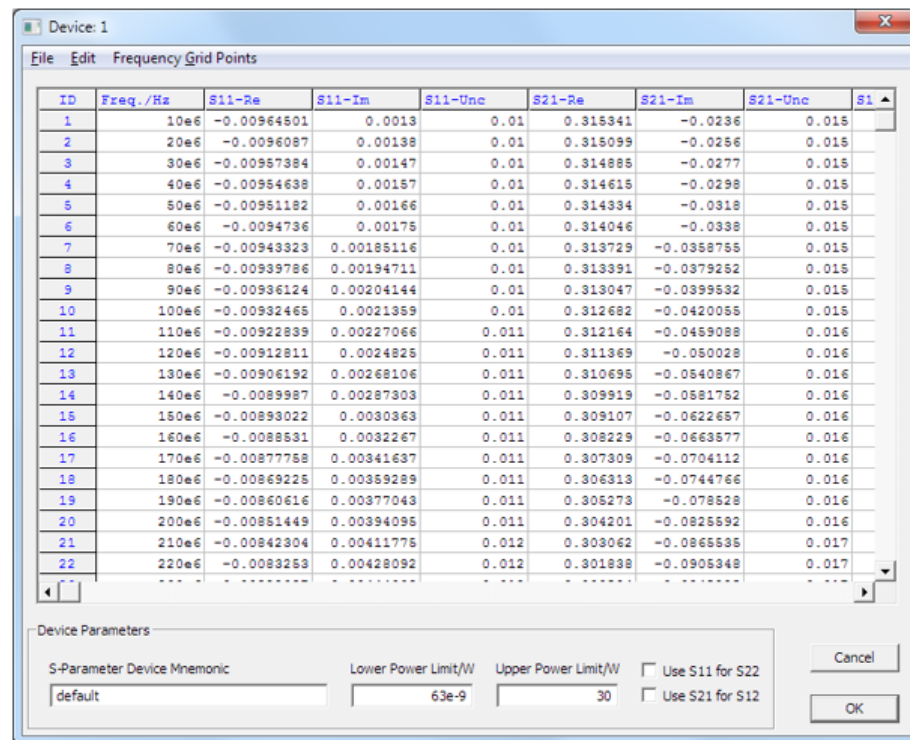

### To save the calibration data to the sensor

1. Select "Sensor" > "Save Calibration Data".

The "Download Calibration Data" dialog opens.

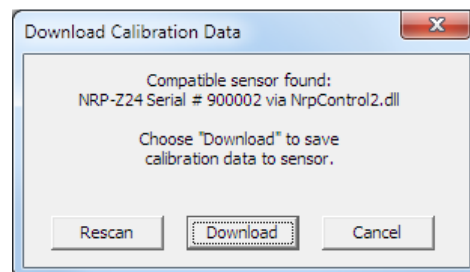

2. Confirm that the correct power sensor is selected by clicking "Download".

After a successful transfer of the data to the power sensor, a confirmation message is displayed.

The sensor can be used with the new S-parameter data.

### S2P Measurement Data Files

S2P files are human-readable text files that contain header information and the complex S-parameters of the device under test in columns. This chapter briefly describes the format of the S2P file.

An S2P measurement data file has the following structure (square brackets indicate that the enclosed content is optional):

- **Option line**

The option line has the format  $\#[<frequency\ unit>][<parameter>][<format>][<R\ n>]$ , where:

- #  
Identifies the option line.
- $<frequency\ unit>$   
Possible values are Hz, kHz, MHz or GHz. If a frequency unit is not specified, GHz is implicitly assumed.
- $<parameter>$  For S-parameter files. If a parameter is not specified, S is implicitly assumed.
- $<format>$   
Possible values are MA (linear magnitude and phase in degree), DB (magnitude in dB, phase in degree) or RI (real and imaginary part). If a format is not specified, MA is implicitly assumed.
- $<R\ n>$   
R is optional and followed by the reference impedance in  $\Omega$ . If no entry is made, R50 is implicitly assumed.

The option line therefore reads:

$\#[HZ | KHZ | MHZ | GHZ] [S] [MA | DB | RI] [R\ 50]$ .

- **Measurement frequencies**

The measurement frequencies are listed in ascending order and are specified as follows:

$f_i\ s_{11}(f_i)\ s_{21}(f_i)\ s_{12}(f_i)\ s_{22}(f_i)$

where  $f_i$  is the  $i$ -th frequency and  $s_{jk}(f_i)$  is the display format as specified in the option line:

- $|s_{jk}(f_i)|\ arg\ s_{jk}(f_i)$   
Display format for linear magnitude and phase in degree (MA)
- $20.lg|s_{jk}(f_i)|\ arg\ s_{jk}(f_i)$   
Display format for magnitude in dB and phase in degree (DB)
- $Re|s_{jk}(f_i)|\ Im|s_{jk}(f_i)|$   
Display format for real and imaginary part (RI)

- **Comments**

Any line starting with an exclamation mark (!) is interpreted as a comment line.

### Uncertainty Data Files

An uncertainty data file has the following structure (square brackets indicate that the enclosed content is optional):

- **Option line**

The option line has the format  $\#[<frequency\ unit>]<parameter>[<format>][<R\ n>]$ , where:

- #  
Identifies the option line.
- $<frequency\ unit>$   
Possible values are Hz, kHz, MHz or GHz. If a frequency unit is not specified, GHz is implicitly assumed.
- $<parameter>$



*U* must be specified for uncertainty data files. If a parameter is not specified, *S* is implicitly assumed and as a result an error message is triggered.

- *<format>*  
This value is ignored in uncertainty measurement files. The entry is therefore irrelevant.
- *<R n>*  
*R* is optional and followed by the reference impedance in  $\Omega$ . If no entry is made, *R50* is implicitly assumed.

The option line therefore reads:  
# [HZ | KHZ | MHZ | GHZ] U [MA | DB | RI] [R 50].

• **Measurement frequencies**

The measurement frequencies are listed in ascending order and are specified as follows:

$$f_i \text{ unc}[s_{11}(f_i)] \text{ unc}[s_{21}(f_i)] \text{ unc}[s_{12}(f_i)] \text{ unc}[s_{22}(f_i)]$$

where  $f_i$  is the *i*-th frequency and  $\text{unc}[s_{jk}(f_i)]$  is the uncertainty of the *S*-parameters that is forwarded as follows:

- As extended absolute uncertainty (  $k = 2$  ) for the magnitude of reflection parameters  $s_{11}$  and  $s_{22}$
- As extended uncertainties (  $k = 2$  ) in dB for the magnitude of transmission parameters  $s_{21}$  and  $s_{12}$

• **Comments**

Any line starting with an exclamation mark (!) is interpreted as a comment line.

## 9.9 Calibrating, Zeroing

Zeroing removes offset voltages from the analog circuitry of the sensors, so that there are only low powers displayed when there is no power applied. The zeroing process can take more than 8 seconds to complete.

Zeroing is recommended if:

- The temperature has varied by more than 5 K.
- The sensor has been replaced.
- No zeroing was performed in the last 24 hours.
- Signals of very low power are to be measured, for instance, if the expected measured value is less than 10 dB above the lower measurement range limit.



Turn off all test signals before zeroing. An active test signal during zeroing causes an error.

Remote commands:

CALibration:DATA.....	106
CALibration:DATA:LENGth?.....	106
CALibration:TEST?.....	106
CALibration:TEST:DEVIation?.....	106

CALibration:TEST:REFeRence?.....	107
CALibration:USER:DATA.....	107
CALibration:USER:DATA:LENGth?.....	107
CALibration<Channel>:ZERO:AUTO.....	107

---

### CALibration:DATA <caldata>

Writes a binary calibration data set in the memory of the sensor.

#### Parameters:

<caldata>                    <block\_data>

---

### CALibration:DATA:LENGth?

Queries the length in bytes of the calibration data set currently stored in the flash memory. Programs that read out the calibration data set can use this information to determine the capacity of the buffer memory required.

**Example:**                    CAL:DATA:LENG?  
                                   Query  
                                   57392  
                                   Response

**Usage:**                      Query only

---

### CALibration:TEST?

The thermal power sensors are equipped with an additional test heater.

Queries the power difference in W when measuring with the external heater enabled and disabled.

**Usage:**                      Query only

---

### CALibration:TEST:DEVIation?

The thermal power sensors are equipped with an additional test heater.

Queries the relative deviation of the current power difference from the reference value stored in the calibration data set. The relative deviation is calculated as follows:

<relative deviation> = (<current power difference> / <reference value>) - 1

with

<current power difference>: CALibration:TEST?

<reference value>: CALibration:TEST:REFeRence?

**Usage:**                      Query only

---

**CALibration:TEST:REFerence?**

The thermal power sensors are equipped with an additional test heater.

Queries the reference value of the power difference in W when measuring with the external heater enabled and disabled. The reference value is determined during the calibration process and stored in the calibration data set.

**Usage:** Query only

---

**CALibration:USER:DATA <caldata>**

Transfers the user calibration data set, which mainly contains S-parameter sets for user-specific devices. The query returns the data as it was downloaded to the power sensor before.

After downloading of a new user calibration data set to the power sensor, the current S-parameter correction settings become invalid. Safe operation of the power sensor is only possible if the `SElect` and `STATe` commands are repeated after download. See also:

- `[SENSe<Sensor>:]CORRection:SPDevice:STATe`
- `[SENSe<Sensor>:]CORRection:SPDevice:SElect`

**Parameters:**

<caldata>                    <block\_data>

---

**CALibration:USER:DATA:LENGth?**

Queries the length of the user calibration data block.

**Usage:** Query only

---

**CALibration<Channel>:ZERO:AUTO <state>**

Performs zero calibration.

Turn off all test signals before zeroing. An active test signal during zeroing causes an error.

While zero calibration is in progress, no queries or other setting commands are allowed, since the command is synchronous. Any communication attempt can run into a timeout.

After zero calibration, query the static error queue (`SYSTem:SERRor?`). The following responses are possible:

- 0  
No error, the zero calibration was successful.
- -240  
Warning, zero calibration failed. See also the example.

<b>Suffix:</b>	
<Channel>	1...4 Measurement channel if more than one channel is available.
<b>Parameters:</b>	
<state>	<b>ONCE</b> Only valid parameter for this command. <b>0</b> Return value if no calibration is in progress. <b>*RST: OFF</b>
<b>Example:</b>	<b>*CLS</b> <b>CAL1:ZERO:AUTO ONCE</b> Performs zeroing. Takes several seconds. <b>SYST:SERR?</b> <b>Query</b> -240 Response: Warning; Zero Calibration failed; Results Degrading.
<b>Manual operation:</b>	See " <a href="#">Zero Calibration</a> " on page 47

## 9.10 Testing

The selftest allows a test of the internal circuitry of the power sensor.



Do not apply a signal to the sensor while the selftest is running. If the selftest is carried out with a signal being present, error messages can erroneously be output for the test steps *Offset Voltages* and/or *Noise Voltages*.

### TEST:SENsOr? [<Item>]

Triggers a selftest of the sensor. In contrast to **\*TST?**, this command returns detailed information that you can use for troubleshooting.

#### Query parameters:

<Item> String

**Usage:** Query only

**Manual operation:** See "[Diagnostics](#)" on page 47

## 9.11 Configuring the System

The **SYSTEM** subsystem contains a series of commands for general functions that do not directly affect the measurement.



The `SYSTem:COMMunicate:NETWork:...` commands are only available for the R&S NRP LAN power sensors.

#### Remote commands:

<code>SYSTem:COMMunicate:NETWork:REStart</code> .....	110
<code>SYSTem:COMMunicate:NETWork:RESet</code> .....	110
<code>SYSTem:COMMunicate:NETWork:STATus?</code> .....	110
<code>SYSTem:COMMunicate:NETWork[:COMMOn]:DOMain</code> .....	110
<code>SYSTem:COMMunicate:NETWork[:COMMOn]:HOSTname</code> .....	110
<code>SYSTem:COMMunicate:NETWork:IPADdress</code> .....	111
<code>SYSTem:COMMunicate:NETWork:IPADdress:GATeway</code> .....	111
<code>SYSTem:COMMunicate:NETWork:IPADdress:INFO?</code> .....	112
<code>SYSTem:COMMunicate:NETWork:IPADdress:MODE</code> .....	112
<code>SYSTem:COMMunicate:NETWork:IPADdress:SUBNet:MASK</code> .....	112
<code>SYSTem:DFPRint&lt;Channel&gt;?</code> .....	112
<code>SYSTem:ERRor:ALL?</code> .....	113
<code>SYSTem:ERRor:CODE:ALL?</code> .....	113
<code>SYSTem:ERRor:CODE[:NEXT]?</code> .....	113
<code>SYSTem:ERRor:COUNT?</code> .....	113
<code>SYSTem:ERRor[:NEXT]?</code> .....	114
<code>SYSTem:FWUPdate</code> .....	114
<code>SYSTem:FWUPdate:STATus?</code> .....	114
<code>SYSTem:HELP:HEADers?</code> .....	115
<code>SYSTem:HELP:SYNTax?</code> .....	115
<code>SYSTem:HELP:SYNTax:ALL?</code> .....	115
<code>SYSTem:INFO?</code> .....	115
<code>SYSTem:INITialize</code> .....	117
<code>SYSTem:LANGuage</code> .....	117
<code>SYSTem:LED:COLor</code> .....	117
<code>SYSTem:LED:MODE</code> .....	117
<code>SYSTem:MINPower?</code> .....	118
<code>SYSTem:PARAmeters?</code> .....	118
<code>SYSTem:PARAmeters:DELTA?</code> .....	118
<code>SYSTem:PRESet</code> .....	118
<code>SYSTem:REBoot</code> .....	118
<code>SYSTem:REStart</code> .....	119
<code>SYSTem:RUTime</code> .....	119
<code>SYSTem:SERRor?</code> .....	119
<code>SYSTem:SERRor:LIST:ALL?</code> .....	119
<code>SYSTem:SERRor:LIST[:NEXT]?</code> .....	119
<code>SYSTem:SUTime</code> .....	120
<code>SYSTem:TLEVels?</code> .....	120
<code>SYSTem:TRANsaction:BEgin</code> .....	120
<code>SYSTem:TRANsaction:END</code> .....	120
<code>SYSTem[:SENSor]:NAME</code> .....	120
<code>SYSTem:VERSion?</code> .....	121

---

**SYSTem:COMMunicate:NETWork:REStart**

Effective only for the R&S NRP LAN power sensors.

Restarts the network connection to the DUT, that means terminates the connection and sets it up again.

**Example:** `SYST:COMM:NETW:REST`

**Usage:** Event

---

**SYSTem:COMMunicate:NETWork:RESet**

Effective only for the R&S NRP LAN power sensors.

Resets the LAN network settings to the default values.

**Usage:** Event

---

**SYSTem:COMMunicate:NETWork:STATus?**

Effective only for the R&S NRP LAN power sensors.

Queries the network configuration state.

**Example:** `SYST:COMM:NETW:STAT?`  
Query  
UP  
Response: The network is active.

**Usage:** Query only

---

**SYSTem:COMMunicate:NETWork[:COMMOn]:DOMain <domain>**

Effective only for the R&S NRP LAN power sensors.

Sets the domain of the network.

**Parameters:**  
<domain>

**Example:** `SYST:COMM:NETW:COMM:DOM 'ABC.DE'`  
Sets *ABC.DE* as domain of the network.

---

**SYSTem:COMMunicate:NETWork[:COMMOn]:HOSTname <hostname>**

Effective only for the R&S NRP LAN power sensors.

Sets the individual hostname of the sensor.

In a LAN that uses a DNS server (domain name system server), you can access each connected instrument using a unique hostname instead of its IP address. The DNS server translates the hostname to the IP address. Using a hostname is especially useful if a DHCP server is used, as a new IP address can be assigned each time the instrument is restarted.

The sensor performs the change of the hostname immediately after the command is sent. For this purpose, the sensor restarts its connection to the network, which can take several seconds. During this time, you cannot address the sensor. After the restart, you can only address the sensor using the newly set hostname.

**Note:** It is recommended that you do not change the default hostname to avoid problems with the network connection. However, if you change the hostname, be sure to use a unique name.

**Parameters:**

<hostname>

**Example:**

```
SYST:COMM:NETW:COMM:HOST
'powersensor-2nd-floor'
Sets powersensor-2nd-floor as new hostname.
```

**Manual operation:** See "[Sensor Name](#)" on page 53

**SYSTem:COMMunicate:NETWork:IPADdress <ipaddress>**

Effective only:

- For the R&S NRP LAN power sensors.
- If `SYSTem:COMMunicate:NETWork:IPADdress:MODE` is set to `STATIC`.

Sets the IP address of the sensor.

**Parameters:**

<ipaddress>

**Example:**

```
SYST:COMM:NETW:IPAD '192.168.10.29'
Sets 192.168.10.29 as IP address.
```

**Manual operation:** See "[IP Address](#)" on page 52

**SYSTem:COMMunicate:NETWork:IPADdress:GATeway <gateway>**

Effective only:

- For the R&S NRP LAN power sensors.
- If `SYSTem:COMMunicate:NETWork:IPADdress:MODE` is set to `STATIC`.

Sets the IP address of the default gateway.

**Parameters:**

<gateway>

**Example:**

```
SYST:COMM:NETW:IPAD:GAT '192.168.10.254'
Sets 192.168.10.254 as IP address of the default gateway.
```

**Manual operation:** See ["Gateway"](#) on page 53

---

#### **SYSTem:COMMunicate:NETWork:IPADdress:INFO?**

Effective only for the R&S NRP LAN power sensors.

Queries the network status information.

**Usage:** Query only

---

#### **SYSTem:COMMunicate:NETWork:IPADdress:MODE <mode>**

Effective only for the R&S NRP LAN power sensors.

Sets whether the IP address is assigned automatically or manually.

**Parameters:**

<mode> AUTO | STATic

**AUTO**

Assigns the IP address automatically, provided the network supports DHCP.

**STATic**

Enables assigning the IP address manually.

\*RST: AUTO

**Example:** SYST:COMM:NETW:IPAD:MODE AUTO  
The IP address is assigned automatically.

**Manual operation:** See ["DHCP"](#) on page 53

---

#### **SYSTem:COMMunicate:NETWork:IPADdress:SUBNet:MASK <netmask>**

Effective only:

- For the R&S NRP LAN power sensors.
- If `SYSTem:COMMunicate:NETWork:IPADdress:MODE` is set to `STATic`.

Sets the subnet mask.

**Parameters:**

<netmask>

**Example:** SYST:COMM:NETW:IPAD:SUBN:MASK '255.255.255.0'  
Sets 255.255.255.0 as subnet mask.

**Manual operation:** See ["Subnet Mask"](#) on page 52

---

#### **SYSTem:DFPRint<Channel>?**

Reads the footprint file of the sensor.



**Suffix:**  
 <Channel> 1...4  
 Measurement channel if more than one channel is available.

**Usage:** Query only

**SYSTem:ERRor:ALL?**

Queries all unread entries in the error/event queue and removes them from the queue.

The response is a comma-separated list in first out order, each entry consisting of the error number and a short description of the error.

Positive error numbers are instrument-dependent. Negative error numbers are reserved by the SCPI standard.

**Example:** SYST:ERR:ALL?  
 Query  
 0, "No error"  
 Response

**Usage:** Query only

**SYSTem:ERRor:CODE:ALL?**

Queries all unread entries in the error/event queue and removes them from the queue. Only the error numbers are returned.

**Example:** SYST:ERR:CODE:ALL?  
 Query  
 0  
 Response: No errors have occurred since the error queue was last read out.

**Usage:** Query only

**SYSTem:ERRor:CODE[:NEXT]?**

Queries the oldest entry in the error queue and then deletes it. Only the error number is returned.

**Example:** SYST:ERR:CODE?  
 Query  
 0  
 Response: No errors have occurred since the error queue was last read out.

**Usage:** Query only

**SYSTem:ERRor:COUNt?**

Queries the number of entries in the error queue.

**Example:**            `SYST:ERR:COUN?`  
                          Query  
                          1  
                          Response: One error has occurred since the error queue was last read out.

**Usage:**             Query only

### **SYSTem:ERRor[:NEXT]?**

Queries the error/event queue for the oldest entry and removes it from the queue. The response consists of an error number and a short description of the error.

Positive error numbers are instrument-dependent. Negative error numbers are reserved by the SCPI standard.

**Example:**            `SYST:ERR?`  
                          Query  
                          0, 'no error'  
                          Response: No errors have occurred since the error queue was last read out.

**Usage:**             Query only

### **SYSTem:FWUPdate <fwudata>**

Loads new operating firmware into the power sensor. Rohde & Schwarz provides the update file. For further details, see [Chapter 7, "Firmware Update"](#), on page 54.

If you want to integrate a firmware update function in an application, see the example given in [Chapter 7.2.3, "Using Remote Control"](#), on page 57.

#### **Setting parameters:**

<code>&lt;fwudata&gt;</code>	<code>&lt;block_data&gt;</code>
	Definite length arbitrary block data containing the direct copy of the binary *.rsu file in the following format:
	#
	Single digit indicating how many digits follow to specify the size of the binary file.
	Number that specifies the size of the binary file.
	Binary data
	0x0a as appended delimiter for line feed

**Usage:**             Setting only

**Manual operation:** See ["Firmware Update"](#) on page 53

### **SYSTem:FWUPdate:STATus?**

Reads the result of the firmware update performed using `SYSTem:FWUPdate` on page 114.

While a firmware update is in progress, the LED of the sensor flashes in bright white color. When the firmware update is completed, you can read the result.

The result of the query is a readable string.

**Example:**                `SYST:FWUP:STAT?`  
                               Query  
                               "Success"  
                               Response

**Usage:**                 Query only

**Manual operation:** See "[Firmware Update](#)" on page 53

#### **SYSTem:HELP:HEADers? [<Item>]**

Returns a list of all SCPI commands supported by the sensor.

**Query parameters:**

<Item>                    <block\_data>

**Usage:**                 Query only

#### **SYSTem:HELP:SYNTax? [<Item>]**

Queries the relevant parameter information for the specified SCPI command.

**Query parameters:**

<Item>

**Example:**                `SYST:HELP:SYNT? 'sens:aver:coun'`

**Usage:**                 Query only

#### **SYSTem:HELP:SYNTax:ALL?**

Queries the implemented SCPI commands and their parameters. Returns the result as a block data.

**Usage:**                 Query only

#### **SYSTem:INFO? [<item>]**

Queries information about the system.

If queried without parameters, the command returns all available information in the form of a list of strings separated by commas.

If you want to query specific information, add a query parameter.

**Query parameters:**

<item>                    "<string>" with the following values:

**Manufacturer**

**Type**

**Stock Number**  
**Serial**  
**SW Build**  
**MAC Address**  
**Hostname**  
**IP Address**  
**Domain**  
**Subnetmask**  
**Gateway**  
**Mode**  
**Status**  
**Sensor Name**  
**Technology**  
**Function**  
**MinPower**  
**MaxPower**  
**MinFreq**  
**MaxFreq**  
**Resolution**  
**Impedance**  
**Coupling**  
**Uptime**  
**Cal. Misc.**  
**Cal. Abs.**  
**Cal. Refl.**  
**Cal. Temp.**  
**Cal. Lin.**  
**Cal. S-Para.**  
**Cal. S-Para. (User)**  
**SPD Mnemonic**  
**Cal. Due Date**  
**Certificate No**  
**Limit**  
**TestLimit**  
**TestLimit pd**

**Usage:**

Query only

---

**SYSTem:INITialize**

Sets the sensor to the standard state, i.e. the default settings for all test parameters are loaded in the same way as with *\*RST*. The sensor then outputs a complete list of all supported commands and parameters. With the command, the remote-control software can automatically adapt to the features of different types of sensors with different functionality.

**Usage:** Event

---

**SYSTem:LANGUage** <language>

Selects an emulation of a different command set.

**Parameters:**

<language> SCPI  
\*RST: SCPI

---

**SYSTem:LED:COLor** <color>

Sets the color and the flash code of the system status LED, if the operating mode of the LED is set to *USER* (*SYSTem:LED:MODE*).

**Parameters:**

<color> Hexadecimal code described as  
0x0krrggbb  
with  
k = 0: steady on; k = 1: slowly flashing; k = 2: fast flashing  
rr = red  
gg = green  
bb = blue  
In NRP legacy communication, the parameter is a standard decimal number, representing the corresponding hexadecimal code.  
Range: 0x00 to 0x02FFFFFF  
\*RST: 0x00A0A0A0

**Example:**

```
SYST:LED:MODE USER
Sets the system status LED operating mode to user.
```

```
SYST:LED:COL #H01a00000
The LED flashes slowly in red.
```

```
SYSTem:LED:MODE SENSOor
Sets the system status LED operating mode back to the sensor internal settings.
```

---

**SYSTem:LED:MODE** <mode>

Sets whether the color of the system status LED is controlled by the sensor firmware or by the user settings.

For more information, see [SYSTem:LED:COLor](#).

**Parameters:**

<mode>           USER | SENSor  
                   \*RST:       SENSor

**SYSTem:MINPower?**

Queries the lower power measurement limit.

This value changes if [\[SENSe<Sensor>:\]CORRection:SPDevice:STATe](#) is set to ON. The lower measurement limit refers to the sensor or to the combination of a sensor and the components connected ahead of it.

Use this query to determine a useful resolution for the result display near the lower measurement limit.

**Usage:**           Query only

**SYSTem:PARAmeters?**

Lists all commands with default values, limits and ranges.

**Usage:**           Query only

**SYSTem:PARAmeters:DELTA?**

Lists all commands that differ from the defined default status set by [\\*RST](#) on page 65.

The commands are output with default values, limits and ranges.

**Usage:**           Query only

**SYSTem:PRESet**

Triggers a sensor reset.

The command essentially corresponds to the [\\*RST](#) command, with the exception that the settings of the following commands are persistently held:

INITiate:CONTInuous  
 SENSe:AVERAge:TCONtrol

**Usage:**           Event

**SYSTem:REBoot**

Reboots the sensor.

**Usage:**           Event

---

**SYSTem:REStart**

Restarts the firmware of the R&S NRPxxT(N).

**Usage:** Event

---

**SYSTem:RUTime <update\_time>**

Effective only in the NRP legacy mode.

Sets the result update time. That is the maximum rate in which the power sensor can output measurement results. Relevant only in continuous measurement mode (**INITiate:CONTInuous ON**).

**Parameters:**

<update\_time> Range: 0.0 to 10.0  
\*RST: 0.1  
Default unit: Seconds

---

**SYSTem:SERRor?**

Queries the next static error, if available. Static errors are more severe than normal error conditions, which can be queried using **SYSTem:ERRor[:NEXT]?**.

Normal errors result from, for example, unknown commands or syntax errors and generally affect a single parameter or setting. Static errors, as a rule, prevent the execution of normal measurements.

**Usage:** Query only

---

**SYSTem:SERRor:LIST:ALL?**

Returns a list of all static errors that have occurred but have already been resolved. For example, an overload of a short duration.

**Example:** `SYST:SERR:LIST:ALL?`  
**Response:** 0,"reported at uptime:2942; notice;  
auto-averaging exceeded maximum time;  
Notification",0,"removed at uptime:2944;  
notice; auto-averaging exceeded maximum time;  
Notification".

**Usage:** Query only

---

**SYSTem:SERRor:LIST[:NEXT]?**

Queries the list of all static errors that have occurred but have already been resolved for the oldest entry and removes it from the queue. The response consists of an error number and a short description of the error.

**Example:**           SYST:SERR:LIST?  
**Query**  
 0,"reported at uptime:2942; notice;  
 auto-averaging exceeded maximum time;  
 Notification"  
**Response**

**Usage:**            Query only

**SYSTem:SUTime <update\_time>**

Effective only in the NRP legacy mode.

Sets the status update time. That is the maximum rate in which the power sensor can output measurement results. Relevant only in continuous measurement mode (**INITiate:CONTinuousON**).

**Parameters:**

<update\_time>       Range:       0.0 to 10.0  
                       \*RST:        10e-3  
                       Default unit: Seconds

**SYSTem:TLEvels?**

Queries the possible power test levels of the sensor.

**Usage:**            Query only

**SYSTem:TRANsaction:BEgIn**

Starts a series of settings.

**Usage:**            Event

**SYSTem:TRANsaction:END**

Ends a series of settings.

**Usage:**            Event

**SYSTem[:SENSor]:NAME <sensorname>**

Sets the name of the sensor according to your requirements. The specified name is displayed in the web user interface of the network sensors.

The sensor name that you specify here is independent from the hostname of the sensor. However, if the sensor name is not specified, it defaults to the hostname.

**Example:**

SYST:NAME "InputModule-X5"



Results in a display as shown in [Figure 9-7](#).

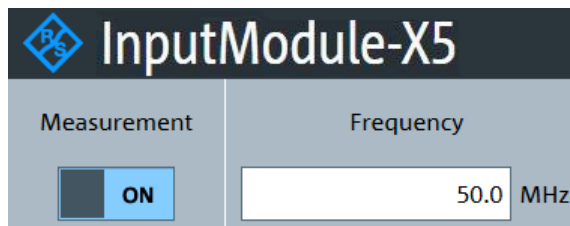

Figure 9-7: Sensor Name

**Parameters:**

<sensorname>

**Manual operation:** See "[Sensor Name](#)" on page 53

**SYSTem:VERSion?**

Queries the SCPI version that the command set of the sensor complies with.

**Example:**           SYST:VERS?  
                   Query  
                   1999.0  
                   Response: SCPI version from 1999.

**Usage:**             Query only

## 9.12 Using the Status Register

Further information:

- [Chapter 11.3, "Status Reporting System"](#), on page 139

Contents:

- [General Status Register Commands](#)..... 121
- [Reading Out the CONDition Part](#)..... 122
- [Reading Out the EVENT Part](#).....122
- [Controlling the ENABLE Part](#).....123
- [Controlling the Negative Transition Part](#)..... 123
- [Controlling the Positive Transition Part](#)..... 124

### 9.12.1 General Status Register Commands

- [STATus:PRESet](#).....122
- [STATus:QUEue\[:NEXT\]?](#)..... 122

---

**STATus:PRESet**

Resets the edge detectors and `ENABLe` parts of all registers to a defined value.

**Usage:** Event

---

**STATus:QUEue[:NEXT]?**

Queries the most recent error queue entry and deletes it.

Positive error numbers indicate sensor specific errors. Negative error numbers are error messages defined by SCPI.

If the error queue is empty, the error number 0, "No error", is returned.

**Usage:** Query only

### 9.12.2 Reading Out the CONDition Part

Further information:

- [Chapter 11.3.2, "Structure of a SCPI Status Register"](#), on page 140
- 

**STATus:DEvice:CONDition?**

**STATus:OPERation:CALibrating:CONDition?**

**STATus:OPERation:CONDition?**

**STATus:OPERation:LLFail:CONDition?**

**STATus:OPERation:MEASuring:CONDition?**

**STATus:OPERation:SENSe:CONDition?**

**STATus:OPERation:TRIGger:CONDition?**

**STATus:OPERation:ULFail:CONDition?**

**STATus:QUEStionable:CALibration:CONDition?**

**STATus:QUEStionable:CONDition?**

**STATus:QUEStionable:POWEr:CONDition?**

**STATus:QUEStionable:WINDow:CONDition?**

**Usage:** Query only

### 9.12.3 Reading Out the EVENT Part

Further information:

- [Chapter 11.3.2, "Structure of a SCPI Status Register"](#), on page 140
- 

**STATus:DEvice[:EVENT]?**

**STATus:OPERation:CALibrating[:SUMMary][:EVENT]?**

**STATus:OPERation[:EVENT]?**

**STATus:OPERation:LLFail[:SUMMary][:EVENT]?**

**STATus:OPERation:MEASuring[:SUMMary][:EVENT]?**

**STATus:OPERation:SENSe[:SUMMary][:EVENT]?**

**STATus:OPERation:TRIGger[:SUMMary][:EVENT]?**

**STATus:OPERation:ULFail[:SUMMary][:EVENT]?**

**STATus:QUESTIONable:CALibration[:SUMMARY][:EVENT]?**  
**STATus:QUESTIONable[:EVENT]?**  
**STATus:QUESTIONable:POWER[:SUMMARY][:EVENT]?**  
**STATus:QUESTIONable:WINDOW[:SUMMARY][:EVENT]?**  
 Usage: Query only

### 9.12.4 Controlling the ENABLE Part

Further information:

- [Chapter 11.3.2, "Structure of a SCPI Status Register"](#), on page 140

---

**STATus:DEvice:ENABLE <value>**  
**STATus:OPERation:CALibrating:ENABLE <value>**  
**STATus:OPERation:ENABLE <value>**  
**STATus:OPERation:LLFail:ENABLE <value>**  
**STATus:OPERation:MEASuring:ENABLE <value>**  
**STATus:OPERation:SENSe:ENABLE <value>**  
**STATus:OPERation:TRIGger:ENABLE <value>**  
**STATus:OPERation:ULFail:ENABLE <value>**  
**STATus:QUESTIONable:CALibration:ENABLE <value>**  
**STATus:QUESTIONable:ENABLE <value>**  
**STATus:QUESTIONable:POWER:ENABLE <value>**  
**STATus:QUESTIONable:WINDOW:ENABLE <value>**  
 Parameters:  
 <value> \*RST: 0

### 9.12.5 Controlling the Negative Transition Part

Further information:

- [Chapter 11.3.2, "Structure of a SCPI Status Register"](#), on page 140

---

**STATus:DEvice:NTRansition <value>**  
**STATus:OPERation:CALibrating:NTRansition <value>**  
**STATus:OPERation:NTRansition <value>**  
**STATus:OPERation:LLFail:NTRansition <value>**  
**STATus:OPERation:MEASuring:NTRansition <value>**  
**STATus:OPERation:SENSe:NTRansition <value>**  
**STATus:OPERation:TRIGger:NTRansition <value>**  
**STATus:OPERation:ULFail:NTRansition <value>**  
**STATus:QUESTIONable:CALibration:NTRansition <value>**  
**STATus:QUESTIONable:NTRansition <value>**  
**STATus:QUESTIONable:POWER:NTRansition <value>**  
**STATus:QUESTIONable:WINDOW:NTRansition <value>**  
 Parameters:  
 <value> \*RST: 0

## 9.12.6 Controlling the Positive Transition Part

Further information:

- [Chapter 11.3.2, "Structure of a SCPI Status Register"](#), on page 140

---

**STATus:DEVIce:PTRansition** <value>  
**STATus:OPERation:CALibrating:PTRansition** <value>  
**STATus:OPERation:PTRansition** <value>  
**STATus:OPERation:LLFail:PTRansition** <value>  
**STATus:OPERation:MEASuring:PTRansition** <value>  
**STATus:OPERation:SENSe:PTRansition** <value>  
**STATus:OPERation:TRIGger:PTRansition** <value>  
**STATus:OPERation:ULFail:PTRansition** <value>  
**STATus:QUESTionable:CALibration:PTRansition** <value>  
**STATus:QUESTionable:PTRansition** <value>  
**STATus:QUESTionable:POWer:PTRansition** <value>  
**STATus:QUESTionable:WINDow:PTRansition** <value>  
**Parameters:**  
<value>                    \*RST:            65535

## 10 Performing Measurement Tasks - Programming Examples

If you install the optional software development kit (SDK) of the R&S NRP Toolkit, programming examples are provided. See [Chapter 5.1, "R&S NRP Toolkit"](#), on page 28.

Under Windows, these examples are installed under:

```
C:\ProgramData\Rohde-Schwarz\NRP-Toolkit-SDK\examples
```

This chapter gives programming examples for measurement tasks performed with the series power sensors.

### 10.1 Performing the Simplest Measurement

The simplest way to obtain a result is to use the following sequence of commands:

```
*RST
INITiate
FETCh?
```

The `*RST` sets the continuous average mode.

`INITiate` initiates the measurement.

After `*RST`, the trigger system is set to `TRIGger:SOURce IMMEDIATE`. That means the power sensor starts measuring when the measurement is started without waiting for a trigger condition.

After the measurement has been completed, `FETCh<Sensor>[:SCALar] [:POWER] [:AVG] ?` delivers the result to the output queue from which it can be fetched.

### 10.2 Performing a Buffered Continuous Average Measurement

This example, written in pseudo code, shows how to set up and execute a buffered continuous average measurement.

```
//Select whether using
//   'BUS Trigger'      --> true
// or 'EXT Trigger'    --> false
bool   bUseBUSTrigger = true;

// Use the first NRP series sensor which is found
if ( VI_SUCCESS == SENSOR.openFirstNrpSensor( "USB?::0X0AAD::?*::INSTR" ) )
{
    //Start with a clean state
    SENSOR.write( "*RST" );
}
```

## Performing a Buffered Continuous Average Measurement

```

// Auto Averaging OFF and set Average Count = 4
SENSOR.write( "SENS:AVER:COUN:AUTO OFF" );
SENSOR.write( "SENS:AVER:COUN 4" );

// Select the trigger source
if ( bUseBUSTrigger )
{
    // We want to use '*TRG' to trigger a single physical measurement
    SENSOR.write( "TRIG:SOUR BUS" );
}
else
{
    // We get trigger pulses on the external input (SMB-type connector)
    SENSOR.write( "TRIG:SOUR EXT2" );
}
// Auto-Trigger OFF
SENSOR.write( "TRIG:ATR:STAT OFF" );

// Configure a buffered measurement
// Buffer size is randomly selected to 17
SENSOR.write( "SENS:BUFF:SIZE 17" );
SENSOR.write( "SENS:BUFF:STAT ON" );
SENSOR.write( "TRIG:COUN 17" );

// Read out all errors / Clear error queue
SENSOR.query( "SYST:ERR:ALL?", szBuf, sizeof( szBuf ) );
printf( szBuf );

// Start a 'single' buffered measurement
// Since 17 trigger-counts have been configured,
// the 'single' buffered measurement, which becomes
// initiated by INIT:IMM, is not over until
// 17 physical measurements have been triggered
SENSOR.write( "INIT:IMM" );

// The end of a physical measurement can be recognized
// by a transistion to 'NOT MEASURING' which is a
// negative transistion on bit 1
SENSOR.write( "STAT:OPER:MEAS:NTR 2" );
SENSOR.write( "STAT:OPER:MEAS:PTR 0" );

// Collect 17 physical measurements
for ( int i = 0; i < 17; i++ )
{
    // As a pre-condition: clear the event register by reading it
    int iDummy;
    SENSOR.query( "STAT:OPER:MEAS:EVEN?", &iDummy );
}

```

## Performing a Buffered Continuous Average Measurement

```
// Trigger a single physical measurement; either by '*TRG'
// command or by an externally supplied pulse on the SMB-type connector
if ( bUseBUSTrigger )
    SENSOR.write( "*TRG" );

// Wait until the measurement is done
int iMeasEvent = 0;
while ( iMeasEvent != 2 )
{
    SENSOR.query( "STAT:OPER:MEAS:EVEN?", &iMeasEvent );
    iMeasEvent &= 2;
}
printf( "Triggered!\n" );
}
// All 17 physical measurement have been executed.
// That means, buffer is full and can be read
SENSOR.query( "FETCH?", szBuf, sizeof( szBuf ) );
printf( szBuf );
}
```

# 11 Remote Control Basics

- [Remote Control Interfaces and Protocols](#)..... 128
- [SCPI Command Structure](#)..... 132
- [Status Reporting System](#)..... 139

## 11.1 Remote Control Interfaces and Protocols

For remote control, communication between the R&S NRPxxT(N) power sensors and the controlling host is established based on various interfaces and protocols.

Depending on the sensor type, the power sensors support different interfaces for remote control.

- R&S NRPxxT USB power sensors are always accessed using USB.
- R&S NRPxxTN LAN power sensors can be accessed using USB or Ethernet.

[Table 11-1](#) describes the protocols that are supported for each interface.

**Table 11-1: Remote control interfaces and protocols**

Interface	Supported by	Protocols, VISA <sup>(*)</sup> address string and Library
USB	All power sensors	<ul style="list-style-type: none"> <li>• <b>USBTMC</b> USB::<code>&lt;vendor ID&gt;</code>::<code>&lt;product ID&gt;</code>::<code>&lt;serial number&gt;</code>[::INSTR] VISA</li> <li>• <b>NRP legacy protocol</b></li> </ul>
Ethernet	R&S NRP LAN power sensors	<ul style="list-style-type: none"> <li>• <b>VXI-11</b> TCPIP::<code>host address</code>[::LAN device name][::INSTR] VISA</li> <li>• <b>HISLIP</b> High-Speed LAN Instrument Protocol (IVI-6.1) TCPIP::<code>host address</code>::hislip0[::INSTR] VISA</li> <li>• <b>Socket communication</b> (LAN Ethernet) TCPIP::<code>host address</code>[::LAN device name]::<code>&lt;port&gt;</code>::SOCKET</li> </ul>

(\*) VISA is a standardized software interface library providing input and output functions to communicate with instruments. A VISA installation on the controller is a prerequisite for remote control over USBTMC and LAN (when using VXI-11 or HiSLIP protocol) interfaces.

### 11.1.1 USB Interface

For remote control using USB connection, the computer and the power sensors must be connected via the USB interface. A USB connection requires the VISA library to be installed. VISA detects and configures the R&S power sensors automatically when the USB connection is established. Apart from the USBTMC driver (which comes with the installation of the R&S NRP Toolkit), you do not have to install a separate driver.

USB Test & Measurement Class Specification (USBTMC) is a protocol that is built on top of USB for communication with USB devices. It defines class code information of the sensor, that identifies its functionality to load the respective device driver. Using VISA library, it supports service request, triggers and other operations that are commonly found in GPIB devices.



Besides USBTMC, the NRP legacy protocol is available to ensure the compatibility of the R&S NRPxxT(N) power sensors with the R&S NRP-Z series of power sensors. The usage of this protocol is not recommended for new applications.

The resource string represents an addressing scheme that is used to establish a communication session with the sensor. It is based on the sensor address and some instrument- and vendor-specific information.

### USB Resource String

The syntax of the used USB resource string is:

```
USB::::<product ID>::<serial number>[::INSTR]
```

where:

- <vendor ID> is the vendor ID for Rohde & Schwarz (0x0AAD)
- <product ID> is the product ID for the Rohde & Schwarz sensor
- <serial number> is the individual serial number on the rear of the sensor

**Table 11-2: R&S NRPxxT(N) USB product IDs**

R&S NRPxxT(N) power sensor	USB product ID
R&S NRP18T	0x0150
R&S NRP18TN	0x0151
R&S NRP33T	0x0152
R&S NRP33TN	0x0153
R&S NRP40T	0x0154
R&S NRP40TN	0x0155
R&S NRP50T	0x0156
R&S NRP50TN	0x0157
R&S NRP67T	0x0158
R&S NRP67TN	0x0159
R&S NRP90T	0x026C
R&S NRP90TN	0x026D
R&S NRP110T	0x015A

### Example:

```
USB::0x0AAD::0x0150::100001
```

0x0AAD is the vendor ID for Rohde & Schwarz.

0x0150 is the product ID for the R&S NRP18T power sensor.

100001 is the serial number of the particular power sensor.

## 11.1.2 Ethernet Interface

The Ethernet interface of the R&S NRP LAN power sensors allows you to integrate them in a local area network (LAN).

For remote control via a network, the computer and the power sensor must be connected via the Ethernet interface to a common network with TCP/IP network protocol. The TCP/IP network protocol and the associated network services are preconfigured on the power sensor. Software for device control and the VISA program library must be installed on the computer.

### 11.1.2.1 VISA Resource Strings

The VISA resource string is required to establish a communication session between the controller and the power sensor in a LAN. The resource string is a unique identifier, composed of the specific IP address of the sensor and some network and VISA-specific keywords.

TCPIP::*<IP address or hostname>*[:*<LAN device name>*][:INSTR]

- *TCPIP* designates the network protocol used
- *<IP address or hostname>* is the IP address or host name of the device
- [*<LAN device name>*] defines the protocol and the instance number of a sub-instrument:
- [*:INSTR*] indicates the power sensors resource class (optional)

The IP address or hostname is used by the programs to identify and control the sensor. While the hostname is determined by settings in the sensor, the IP address is assigned by a DHCP server when the sensor requests one. Alternatively the IP address is determined with a procedure called Zeroconf.

You can also assign a *LAN device name* which defines the protocol characteristics of the connection. See the description of the VISA resource string below for the corresponding interface protocols. The string of the *LAN device name* is emphasized in italics.

#### HiSLIP

TCPIP::*<IP address or hostname>*::*hislip0*[:INSTR]

- *hislip0* is the HiSLIP device name, designates that the interface protocol HiSLIP is used (mandatory)

*hislip0* is composed of [*:HiSLIP device name*[,HiSLIP port]] and must be assigned.

For details of the HiSLIP protocol, refer to [Chapter 11.1.2.3, "HiSLIP Protocol"](#), on page 131 .

#### VXI-11

TCPIP::*<IP address or hostname>*[:*inst0*][:INSTR]

- *inst0* is the LAN device name, indicating that the VXI-11 protocol is used (optional)
- inst0* currently selects the VXI-11 protocol by default and can be omitted.

For details of the VXI-11 protocol, refer to [Chapter 11.1.2.2, "VXI-11 Protocol"](#), on page 131 .

### Socket Communication

TCPIP::*<IP address or hostname>*::*port*::*SOCKET*

- *port* determines the used port number
- *SOCKET* indicates the raw network socket resource class

Socket communication requires the specification of the port (commonly referred to as port number) and of "SOCKET" to complete the VISA resource string with the associated protocol used.

The default port for socket communication is port 5025.

For details of the socket communication, refer to [Chapter 11.1.2.4, "Socket Communication"](#), on page 132.

#### Example:

A power sensor has the IP address *10.111.11.20*; the valid resource string using VXI-11 protocol is:

TCPIP::*10.111.11.20*::INSTR

The DNS host name is *nrp18tn-100001*; the valid resource string is:

TCPIP::*nrp18tn-100001*::hislip0 (HiSLIP)

TCPIP::*nrp18tn-100001*::inst0 (VXI-11)

A raw socket connection can be established using:

TCPIP::*10.111.11.20*::5025::SOCKET

TCPIP::*nrp18tn-100001*::5025::SOCKET

### 11.1.2.2 VXI-11 Protocol

The VXI-11 standard is based on the ONC RPC (Open Network Computing Remote Procedure Call) protocol which in turn relies on TCP/IP as the network/transport layer. The TCP/IP network protocol and the associated network services are preconfigured. TCP/IP ensures connection-oriented communication, where the order of the exchanged messages is adhered to and interrupted links are identified. With this protocol, messages cannot be lost.

### 11.1.2.3 HiSLIP Protocol

The HiSLIP (high-speed LAN instrument protocol) is the successor protocol for VXI-11 for TCP-based instruments specified by the IVI foundation. The protocol uses two TCP sockets for a single connection - the first for fast data transfer, the second one for non-sequential control commands (e.g. `Device Clear` or `SRQ`).

HiSLIP has the following characteristics:

- High performance as with raw socket network connections

- Compatible IEEE 488.2 support for Message Exchange Protocol, Device Clear, Serial Poll, Remote/Local, Trigger, and Service Request
- Uses a single IANA registered port (4880), which simplifies the configuration of fire-walls
- Supports simultaneous access of multiple users by providing versatile locking mechanisms
- Usable for IPv6 or IPv4 networks



The HiSLIP data is sent to the device using the "fire and forget" method with immediate return. Opposed to VXI-11, where each operation is blocked until a VXI-11 device handshake returns. Thus, a successful return of a VISA operation such as `viWrite()` does not guarantee that the sensor has finished (or even started) executing the requested command. It just indicates that the command has been delivered to the TCP/IP buffers.

For more information see also the application note at:

<http://www.rohde-schwarz.com/appnote/1MA208>.

#### 11.1.2.4 Socket Communication

An alternative way for remote control of the software is to establish a simple TCP/IP connection to the device using the standard network drivers of your operating system. The so-called "socket" on Linux, "winsock" on Windows. The socket communication, also referred to as "raw Ethernet communication", does not necessarily require a VISA installation on the remote controller side.

Socket connections are established on a specially defined port. The socket address is a combination of the IP address or hostname of the sensor and the number of the port configured for remote control. The power sensors use port number 5025 for this purpose.

## 11.2 SCPI Command Structure

SCPI commands - messages - are used for remote control. Commands that are not taken from the SCPI standard follow the SCPI syntax rules. The power sensor supports the SCPI version 1999. The SCPI standard is based on standard IEEE 488.2 and aims at the standardization of device-specific commands, error handling and the status registers.

SCPI commands consist of a so-called header and, usually, one or more parameters. The header and the parameters are separated by a "white space" (ASCII code 0 to 9, 11 to 32 decimal, e.g. blank). The headers can consist of several mnemonics (key-words). Queries are formed by appending a question mark directly to the header.

The commands can be either device-specific or device-independent (common commands). Common and device-specific commands differ in their syntax.

## 11.2.1 Syntax for Common Commands

Common (=device-independent) commands consist of a header preceded by an asterisk (\*) and possibly one or more parameters.

### Examples:

*RST	RESET	Resets the instrument.
*ESE	EVENT STATUS ENABLE	Sets the bits of the event status enable registers.
*ESR?	EVENT STATUS QUERY	Queries the contents of the event status register.
*IDN?	IDENTIFICATION QUERY	Queries the instrument identification string.

## 11.2.2 Syntax for Device-Specific Commands

### Long and short form

The mnemonics feature a long form and a short form. The short form is marked by upper case letters here, to distinguish it from the long form, which constitutes the complete word. Either the short form or the long form can be entered; other abbreviations are not permitted.

### Example:

INITiate:CONTinuous is equivalent to INIT:CONT or init:cont.



### Case-insensitivity

Upper case and lower case notation only serves to distinguish the two forms in the manual, the instrument itself is case-insensitive.

### Numeric suffixes

If a command can be applied to multiple instances of an object, e.g. specific channels or sources, the required instances can be specified by a suffix added to the command. Numeric suffixes are indicated by angular brackets (<1...4>, <n>, <i>) and are replaced by a single value in the command. Entries without a suffix are interpreted as having the suffix 1.



### Different numbering in remote control

For remote control, the suffix can differ from the number of the corresponding selection used in manual operation. SCPI prescribes that suffix counting starts with 1. Suffix 1 is the default state and used when no specific suffix is specified.

Some standards define a fixed numbering, starting with 0. If the numbering differs in manual operation and remote control, it is indicated for the corresponding command.

### Optional mnemonics

Some command systems permit certain mnemonics to be inserted into the header or omitted. These mnemonics are marked by square brackets in the description. The instrument must recognize the long command to comply with the SCPI standard. Some commands are considerably shortened by these optional mnemonics.

#### Example:

Definition: `INITiate[:IMMEDIATE]`

Command: `INIT:IMM` is equivalent to `INIT`

### Parameters

Parameters must be separated from the header by a "white space". If several parameters are specified in a command, they are separated by a comma.

For a description of the parameter types, refer to [Chapter 11.2.3, "SCPI Parameters"](#), on page 134.

### Special characters

	<p><b>Parameters</b></p> <p>A vertical stroke in parameter definitions indicates alternative possibilities in the sense of "or". The effect of the command differs, depending on which parameter is used.</p>
[ ]	<p>Mnemonics in square brackets are optional and can be inserted into the header or omitted.</p> <p><b>Example:</b> <code>INITiate[:IMMEDIATE]</code></p> <p><code>INIT:IMM</code> is equivalent to <code>INIT</code></p>
{ }	<p>Parameters in curly brackets are optional and can be inserted once or several times, or omitted.</p>

## 11.2.3 SCPI Parameters

Many commands are supplemented by a parameter or a list of parameters. The parameters must be separated from the header by a "white space" (ASCII code 0 to 9, 11 to 32 decimal, e.g. blank). Allowed parameters are:

- Numeric values
- Special numeric values
- Boolean parameters
- Text
- Character strings
- Block data

The parameters required for each command and the allowed range of values are specified in the command description.

## Numeric values

Numeric values can be entered in any form, i.e. with sign, decimal point and exponent. Values exceeding the resolution of the instrument are rounded up or down. The mantissa can comprise up to 255 characters, the exponent must lie inside the value range -32000 to 32000. The exponent is introduced by an "E" or "e". Entry of the exponent alone is not allowed.

## Units

For physical quantities, you can enter the unit. Only basic units are allowed and recognized, see [Table 11-3](#). If you omit the unit, the basic unit is used.

**Table 11-3: Units**

Noted default unit	Corresponding basic unit
Frequency	Hz
Seconds	s
Watts	W
Angle	degrees
Percent	PCT
DB	dB
DBM	dBm
DBUV	dBuV

## Special numeric values

The texts listed below are interpreted as special numeric values. For a query, the numeric value is provided.

- MIN/MAX**  
 MINimum and MAXimum denote the minimum and maximum value.
- DEF**  
 DEFault denotes a preset value which has been stored in the non-variable memory. This value conforms to the default setting, as it is called by the \*RST command.
- UP/DOWN**  
 UP, DOWN increases or reduces the numeric value by one step. The step width can be specified via an allocated step command for each parameter which can be set via UP, DOWN.
- INF/NINF**  
 INFinity, Negative INFinity (NINF) represent the numeric values 9.9E37 or -9.9E37, respectively. INF and NINF are only sent as instrument responses.
- NAN**  
 Not a number (NAN) represents the value 9.91E37. NAN is only sent as an instrument response. This value is not defined. Possible causes are the division by zero, the subtraction of infinite from infinite and the representation of missing values.

### Boolean parameters

Boolean parameters represent two states. The "ON" state (logically true) is represented by "ON" or a numeric value 1. The "OFF" state (logically untrue) is represented by "OFF" or the numeric value 0. The numeric values are provided as the response for a query.

#### Example:

Setting command: `SENSe:AVERage:COUNT:AUTO ON`

Query: `SENSe:AVERage:COUNT:AUTO?`

Response: 1

### Text parameters

Text parameters observe the syntactic rules for mnemonics, i.e. they can be entered using a short or long form. Like any parameter, they have to be separated from the header by a white space. For a query, the short form of the text is provided.

#### Example:

Setting command: `TRIGger:SLOPe POSitive`

Query: `TRIG:SLOP?`

Response: POS

### Character strings

Enter strings always in quotation marks (' or ").

#### Example:

Setting command: `SENSe:FUNCTion "POWer:AVG"`

Query: `SENS:FUNC?`

Response: `"POWer:AVG"`

### Block data

Block data is a format which is suitable for the transmission of large amounts of data. A command using a block data parameter has the following structure:



**Example:**

```
SYSTem:HELP:SYNTax:ALL?
```

```
Response: #45168xxxxxxxx
```

The ASCII character # introduces the data block. The next number indicates how many of the following digits describe the length of the data block. In the example, the 4 following digits indicate the length to be 5168 bytes. The data bytes follow. During the transmission of these data bytes all end or other control signs are ignored until all bytes are transmitted.

#0 specifies a data block of indefinite length. The use of the indefinite format requires a `NL^END` message to terminate the data block. This format is useful when the length of the transmission is not known or if speed or other considerations prevent segmentation of the data into blocks of definite length.

## 11.2.4 Overview of Syntax Elements

The following table provides an overview of the syntax elements:

:	The colon separates the mnemonics of a command. In a command line, the separating semicolon marks the uppermost command level.
;	The semicolon separates two commands of a command line. It does not alter the path.
,	The comma separates several parameters of a command.
?	The question mark forms a query.
*	The asterisk marks a common command.
' "	Quotation marks introduce a string and terminate it (both single and double quotation marks are possible).
#	The hash symbol introduces binary, octal, hexadecimal and block data. <ul style="list-style-type: none"> <li>• Binary: #B10110</li> <li>• Octal: #O7612</li> <li>• Hex: #HF3A7</li> <li>• Block: #21312</li> </ul>
	A "white space" (ASCII-Code 0 to 9, 11 to 32 decimal, e.g. blank) separates the header from the parameters.

## 11.2.5 Structure of a Command Line

A command line can consist of one or several commands. It is terminated by one of the following:

- a <New Line>
- a <New Line> with EOI
- an EOI together with the last data byte

Several commands in a command line must be separated by a semicolon ";". If the next command belongs to a different command system, the semicolon is followed by a colon.

If the successive commands belong to the same system, having one or several levels in common, the command line can be abbreviated. To this end, the second command after the semicolon starts with the level that lies below the common levels. The colon following the semicolon must be omitted in this case.

**Example:**

```
TRIG:LEV 0.1mW;TRIG:DEL 3E-3
```

This command line contains two commands. Both commands are part of the TRIG command system, i.e. they have one level in common.

When abbreviating the command line, the second command begins with the level below TRIG. The colon after the semicolon is omitted. The abbreviated form of the command line reads as follows:

```
TRIG:LEV 0.1E-3;DEL 3E-3
```

A new command line always begins with the complete path.

**Example:**

```
TRIG:LEV 0.1E-3
```

```
TRIG:DEL 3E-3
```

## 11.2.6 Responses to Queries

A query is defined for each setting command unless explicitly specified otherwise. It is formed by adding a question mark to the associated setting command. According to SCPI, the responses to queries are partly subject to stricter rules than in standard IEEE 488.2.

- The requested parameter is transmitted without a header.  
**Example:** TRIG:SOUR?, response: INT
- Maximum values, minimum values and all other quantities that are requested via a special text parameter are returned as numeric values.
- Numeric values are output without a unit. Physical quantities are referred to the basic units or to the units set using the Unit command. The response 3.5E9 for example stands for 3.5 GHz.
- Truth values (Boolean values) are returned as 0 (for OFF) and 1 (for ON).

**Example:**

Setting command: SENS:AVER:COUN:AUTO ON

Query: SENS:AVER:COUN:AUTO?

Response: 1

- Text (character data) is returned in a short form.

**Example:**

Setting command: TRIGger:SOURce INTernal

Query: TRIG:SOUR?

Response: INT

## 11.3 Status Reporting System

The status reporting system stores all information on the current operating state of the sensor, and on errors which have occurred. This information is stored in the status registers and in the error queue. You can query both with the commands of the `STATUS` subsystem.

### 11.3.1 Hierarchy of the Status Registers

Fig.11-1 shows the hierarchical structure of information in the status registers.

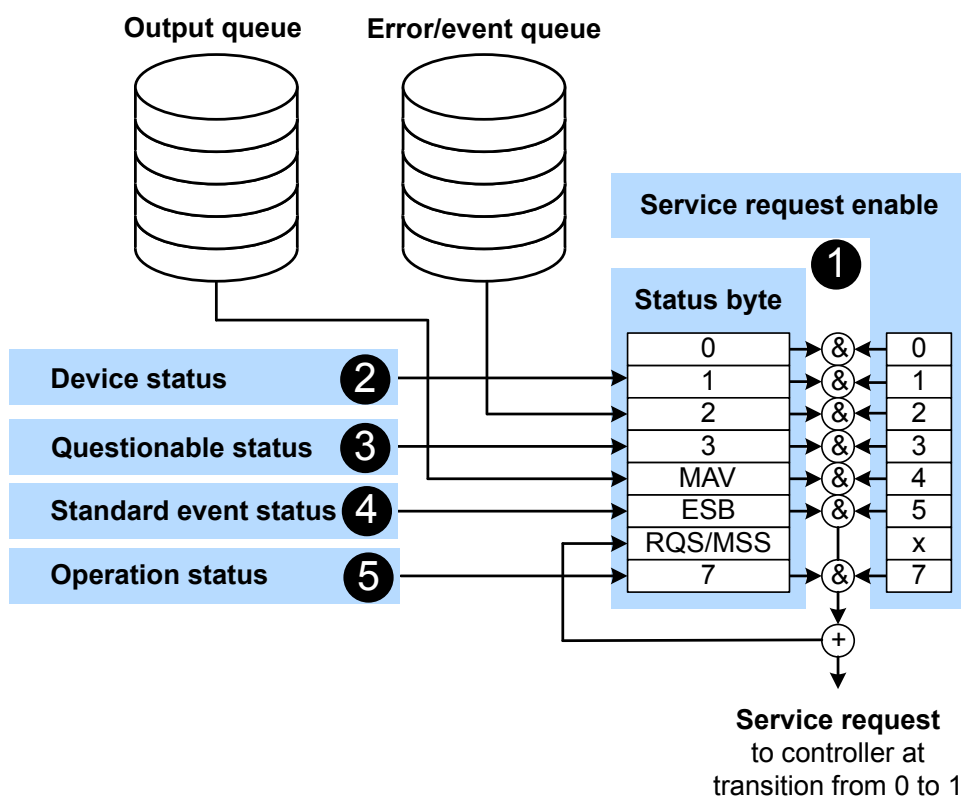

Figure 11-1: Status registers overview

- 1 = Chapter 11.3.3, "Status Byte (STB) and Service Request Enable Register (SRE)", on page 141
- 2 = Chapter 11.3.5, "Device Status Register", on page 143
- 3 = Chapter 11.3.6, "Questionable Status Register", on page 144
- 4 = Chapter 11.3.7, "Standard Event Status and Enable Register (ESR, ESE)", on page 147
- 5 = Chapter 11.3.8, "Operation Status Register", on page 148

The highest level is formed by the status byte register (STB) and the associated service request enable (SRE) register.

The status byte register (STB) receives its information from:

- Standard event status register (ESR)
- Associated standard event status enable register (ESE)
- SCPI-defined operation status register
- Questionable status register, which contains detailed information on the device.

### 11.3.2 Structure of a SCPI Status Register

Each SCPI register consists of five 16-bit registers that have different functions, see [Figure 11-2](#). The individual bits are independent of each other, i.e. each hardware status is assigned a bit number which is the same for all five registers. Bit 15, the most-significant bit, is set to 0 in all registers, thus preventing problems some controllers have with the processing of unsigned integers.

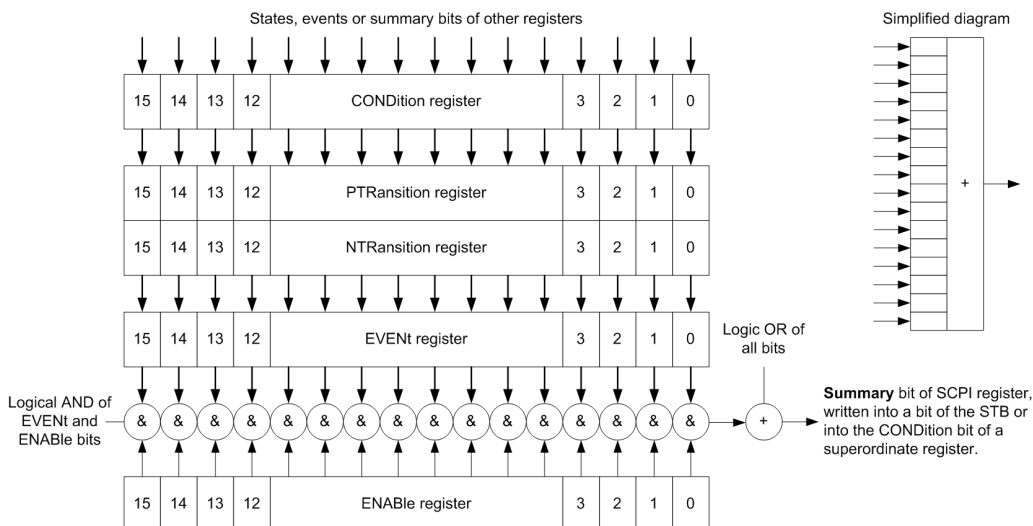

Figure 11-2: Standard SCPI status register

#### CONDition status register part

The five parts of a SCPI register have different properties and functions:

The CONDition part is written into directly by the hardware or the sum bit of the next lower register. Its contents reflect the current instrument status. This register part can only be read, but not written into or cleared. Its contents are not affected by reading.

#### PTRansition / NTRansition status register part

The two transition register parts define which state transition of the CONDition part (none, 0 to 1, 1 to 0 or both) is stored in the EVENT part.

The *Positive TRansition* part acts as a transition filter. When a bit of the `CONDition` part is changed from 0 to 1, the associated `PTR` bit decides whether the `EVENT` bit is set to 1.

- `PTR` bit = 1: The `EVENT` bit is set.
- `PTR` bit = 0: The `EVENT` bit is not set.

This part can be written into and read as required. Its contents are not affected by reading.

The *Negative TRansition* part also acts as a transition filter. When a bit of the `CONDition` part is changed from 1 to 0, the associated `NTR` bit decides whether the `EVENT` bit is set to 1.

- `NTR` bit = 1: The `EVENT` bit is set.
- `NTR` bit = 0: The `EVENT` bit is not set.

This part can be written into and read as required. Its contents are not affected by reading.

#### **EVENT status register part**

The `EVENT` part indicates whether an event has occurred since the last reading, it is the "memory" of the condition part. It only indicates events passed on by the transition filters. It is permanently updated by the instrument.

You can only read this part. Reading the register clears it. This part is often equated with the entire register.

#### **ENABLE status register part**

The `ENABLE` part determines whether the associated `EVENT` bit contributes to the sum bit (see below). Each bit of the `EVENT` part is "ANDed" with the associated `ENABLE` bit (symbol '&'). The results of all logical operations of this part are passed on to the sum bit via an "OR" function (symbol '+').

`ENABLE` bit = 0: The associated `EVENT` bit does not contribute to the sum bit.

`ENABLE` bit = 1: If the associated `EVENT` bit is 1, the sum bit is set to 1 as well.

You can read and write as required. Its contents are not affected by reading.

#### **Sum bit**

The sum bit is obtained from the `EVENT` and `ENABLE` part for each register. The result is then entered into a bit of the `CONDition` part of the higher-order register.

The instrument automatically generates the sum bit for each register. Thus an event can lead to a service request throughout all levels of the hierarchy.

### **11.3.3 Status Byte (STB) and Service Request Enable Register (SRE)**

The status byte register is already defined in IEEE 488.2. It gives a rough overview of the sensor status, collecting information from the lower-level registers. It is comparable

with the `CONDition` register of a SCPI defined register and is at the highest level of the SCPI hierarchy. Its special feature is that bit 6 acts as the summary bit of all other bits of the status byte register.

The status byte register is read by `*STB?` or a serial poll. The service request enable register is associated with the status byte register. The function of the service request enable register corresponds to that of the `ENABLE` register of the SCPI registers. Each bit of the status byte register is assigned a bit in the service request enable register. Bit 6 of the service request enable register is ignored. If a bit is set in the service request enable register and the associated bit in the status byte register changes from 0 to 1, a service request (SRQ) is generated on the IEC/IEEE bus. This service request triggers an interrupt in the controller configured for this purpose, and can be further processed by the controller.

Set and read the service request enable register using `*SRE`.

See [Figure 11-1](#).

**Table 11-4: Used status byte bits and their meaning**

Bit no.	Short description	Bit is set if
1	Device status register summary	A sensor is connected or disconnected or when an error has occurred in a sensor, depending on the configuration of the sensor status register. <a href="#">Chapter 11.3.5, "Device Status Register"</a> , on page 143.
2	Error queue not empty	The error queue has an entry. If this bit is enabled by the service request enable register, each entry of the error queue generates a service request. An error can thus be recognized and specified in detail by querying the error queue. The query yields a conclusive error message. This procedure is recommended since it considerably reduces the problems of IEC/IEEE-bus control.
3	Questionable status register summary	An <code>EVENT</code> bit is set in the <code>QUESTionable</code> status register and the associated <code>ENABLE</code> bit is set to 1. A set bit denotes a questionable device status which can be specified in greater detail by querying the questionable status register. <a href="#">Chapter 11.3.6, "Questionable Status Register"</a> , on page 144.
4	MAV Message available	A readable message is in the output queue. This bit can be used to automate reading of data from the sensor into the controller.
5	ESB Standard event status register summary	One of the bits in the standard event status register is set and enabled in the event status enable register. Setting this bit denotes a serious error which can be specified in greater detail by querying the standard event status register. <a href="#">Chapter 11.3.7, "Standard Event Status and Enable Register (ESR, ESE)"</a> , on page 147.

Bit no.	Short description	Bit is set if
6	MSS Master status summary	The sensor triggers a service request, which happens if one of the other bits of this register is set together with its enable bit in the service request enable register (SRE).
7	Operation status register summary	An <code>EVENT</code> bit is set in the operation status register and the associated <code>ENABLE</code> bit is set to 1. A set bit denotes that an action is being performed by the sensor. Information on the type of action can be obtained by querying the operation status register.  <a href="#">Chapter 11.3.8, "Operation Status Register"</a> , on page 148.

### 11.3.4 IST Flag and Parallel Poll Enable Register (PPE)

Similar to the service request (SRQ), the IST flag combines the complete status information in a single bit. It can be queried by a parallel poll or by `*IST?`.

The parallel poll enable register (PPE) determines which bits of the STB affect the IST flag. The bits of the STB are ANDed with the corresponding bits of the PPE; bit 6 is also used, in contrast to the service request enable register. The IST flag is obtained by ORing all results together.

Set and read the parallel poll enable register using `*PRE`.

### 11.3.5 Device Status Register

Sensor error summary	0
Sensor error	1
Sensor error	2
Sensor error	3
Sensor error	4
0	5
0	6
Legacy locked	7
Reference PLL locked	8
0	9
0	10
0	11
0	12
0	13
0	14
0	15



Figure 11-3: Device status register

Querying the register:

- `STATus:DEVIce:CONDition?`
- `STATus:DEVIce[:EVENT]?`

Querying the static errors:

- `SYSTem:SERRor?`

**Table 11-5: Used device status bits and their meaning**

Bit no.	Short description	Bit is set if
0	Sum of SERR bits	Sum/combination of SERR bits 1 to 4.
1	SERR measurement not possible	Static error (SERR) exists. Certain parameter settings could lead to a situation where subsequent measurements are not possible.
2	SERR erroneous results	Static error exists. The measurement result is possibly incorrect.
3	SERR warning	Static error exists. Status LED of the power sensor is slowly flashing red.
4	SERR critical	Critical static error exists. Status LED of the power sensor is fast flashing red.
7	Legacy locked state	<p>The power sensor is locked in the NRP legacy mode. Via the SCPI channels (USBTMC or TCP/IP), only query commands can be sent, but no setting commands.</p> <p>When the first setting command is sent, the NRP legacy interface takes precedence over all other command channels. This bit is set to 1, and all other channels can only execute query commands. If a setting command is sent via a different channel, the power sensor indicates an error:</p> <p><i>-200, "Execution error; sensor in LEGACY mode"</i></p> <p>To leave this operating mode, close the NRP legacy channel. Either close the application which opened the NRP legacy channel or close at least the connection to the power sensor.</p>
8	Reference PLL locked state	<p>PLL for the clock reference is synchronized. The bit is useful when selecting an external clock source.</p> <p>The following states are possible:</p> <ul style="list-style-type: none"> <li>• Internal clock (<code>[SENSe&lt;Sensor&gt;:]ROSCillator:SOURCE INT</code>): <ul style="list-style-type: none"> <li>– 1 (always)</li> </ul> </li> <li>• External clock (<code>[SENSe&lt;Sensor&gt;:]ROSCillator:SOURCE EXT</code>): <ul style="list-style-type: none"> <li>– 1 if the sensor was able to synchronize with external clock</li> <li>– 0 if the sensor could not synchronize with external clock</li> </ul> </li> </ul>

### 11.3.6 Questionable Status Register

Contains information on questionable sensor states that occur if the power sensor is not operated in compliance with its specifications.



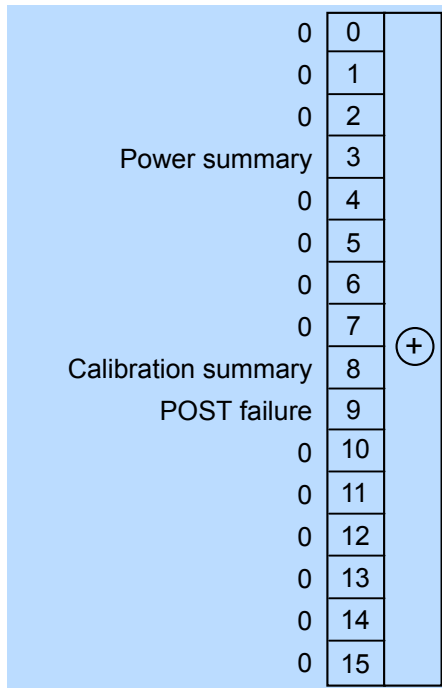

Figure 11-4: Questionable status register

Querying the register:

- `STATUS:QUESTIONABLE:CONDITION?`
- `STATUS:QUESTIONABLE[:EVENT]?`

Table 11-6: Used questionable status bits and their meaning

Bit no.	Short description	Bit is set if
3	Power summary	Summary of <a href="#">Questionable Power Status Register</a> exists.
8	Calibration summary	Summary of <a href="#">Questionable Calibration Status Register</a> exists.
9	POST failure	Built-in test of the R&S NRPxxT(N) that is carried out automatically upon power-up has generated an error.

### 11.3.6.1 Questionable Power Status Register

Contains information whether the measured power values are questionable.

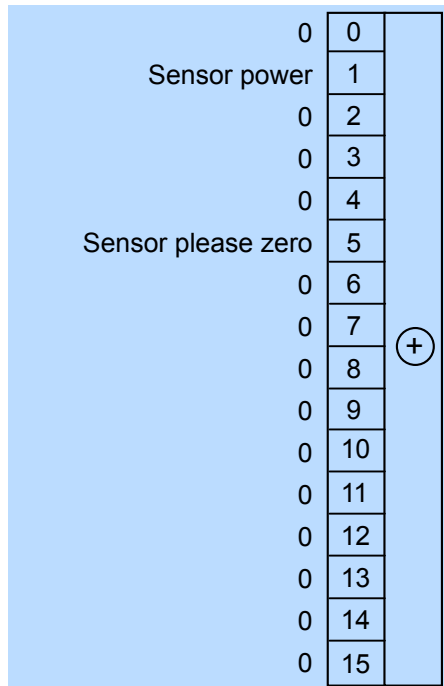

Figure 11-5: Questionable power status register

Querying the register:

- `STATUS:QUESTIONABLE:POWER:CONDITION?`
- `STATUS:QUESTIONABLE:POWER[:SUMMARY][:EVENT]?`

Table 11-7: Used questionable power status bits and their meaning

Bit no.	Short description	Bit is set if
1	Sensor power	Measurement data of the power sensor is corrupt.
5	Sensor please zero	Zero correction for the power sensor is no longer correct. Perform a zero correction.

### 11.3.6.2 Questionable Calibration Status Register

Contains information whether the zeroing of the power sensor was successful.

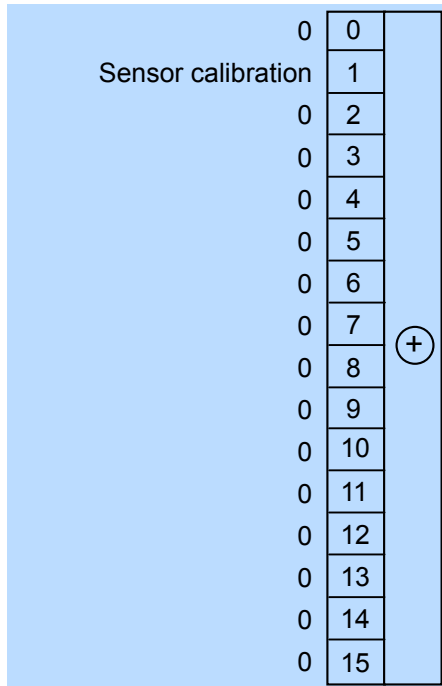

Figure 11-6: Questionable calibration status register

Querying the register:

- `STATUS:QUESTIONABLE:CALIBRATION:CONDITION?`
- `STATUS:QUESTIONABLE:CALIBRATION[:SUMMARY][:EVENT]?`

Table 11-8: Used questionable calibration status bits and their meaning

Bit no.	Short description	Bit is set if
1	Sensor calibration	Zeroing of the power sensor was not successful.

### 11.3.7 Standard Event Status and Enable Register (ESR, ESE)

The `ESR` is already defined in the IEEE 488.2 standard. It is comparable to the `EVENT` register of a SCPI register. The standard event status register can be read out by `*ESR?`.

The `ESE` forms the associated `ENABLE` register. It can be set and read by `*ESE`.

Operation Complete	0	+
0	1	
Query Error	2	
Device-Dependent Error	3	
Execution Error	4	
Command Error	5	
User Request	6	
Power On	7	

Figure 11-7: Standard event status register (ESR)

Table 11-9: Used standard event status bits and their meaning

Bit no.	Short description	Bit is set if
0	Operation complete	All previous commands have been executed and *OPC is received.
2	Query error	The controller wants to read data from the sensor but has not sent a query, or it sends new commands to the sensor before it retrieves existing requested data. A frequent cause is a faulty query which cannot be executed.
3	Device-dependent error	A sensor-dependent error occurs. An error message with a number between -300 and -399 or a positive error number denoting the error in greater detail is entered in the error queue.
4	Execution error	The syntax of a received command is correct but the command cannot be executed due to various marginal conditions. An error message with a number between -200 and -300 denoting the error in greater detail is entered in the error queue.
5	Command error	An undefined command or a command with incorrect syntax is received. An error message with a number between -100 and -200 denoting the error in greater detail is entered in the error queue.
6	User request	The sensor is switched over to manual control.
7	Power on	The sensor is switched on.

### 11.3.8 Operation Status Register

Contains information on current operations, CONDition register, or operations performed since the last query, EVENT register.

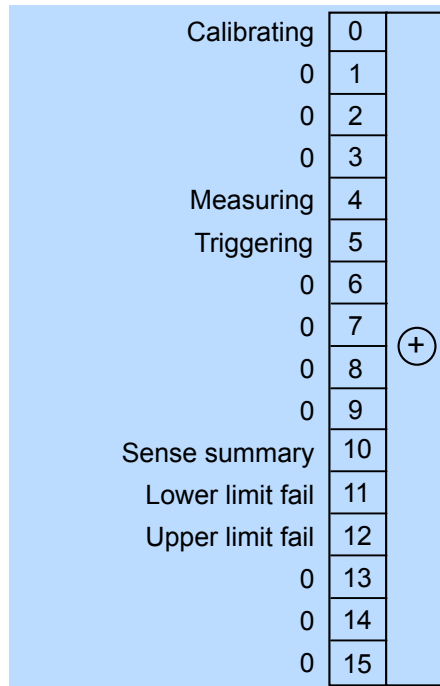

Figure 11-8: Operation status register

Querying the register:

- `STATus:OPERation:CONDition?`
- `STATus:OPERation[:EVENT]?`

Table 11-10: Used operation status bits and their meaning

Bit no.	Short description	Bit is set if
0	Calibrating	Summary of <a href="#">Operation Calibrating Status Register</a> exists.
4	Measuring	Summary of <a href="#">Operation Measuring Status Register</a> exists.
5	Triggering	Summary of <a href="#">Operation Trigger Status Register</a> exists.
10	Sense summary	Summary of <a href="#">Operation Sense Status Register</a> exists.
11	Lower limit fail	Summary of <a href="#">Operation Lower Limit Fail Status Register</a> exists.
12	Upper limit fail	Summary of <a href="#">Operation Upper Limit Fail Status Register</a> exists.

### 11.3.8.1 Operation Calibrating Status Register

The `CONDition` register contains information whether a power sensor is being calibrated. The `EVENT` register contains information whether a calibration was started or completed since the last query.

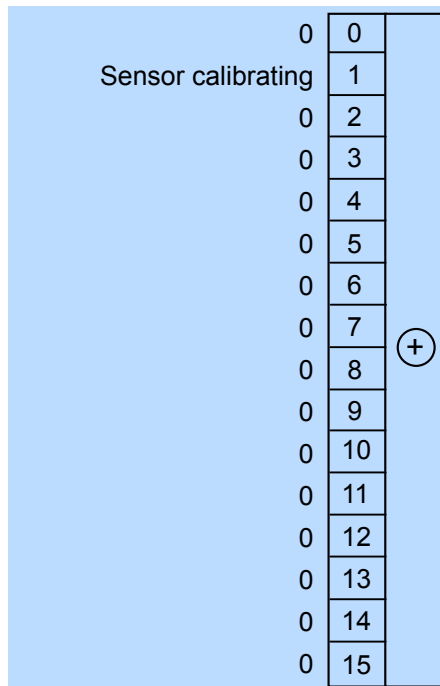

Figure 11-9: Operation calibrating status register

Querying the register:

- `STATUS:OPERation:CALibrating:CONDition?`
- `STATUS:OPERation:CALibrating[:SUMMARY][:EVENT]?`

Table 11-11: Used operation calibrating status bits and their meaning

Bit no.	Short description	Bit is set if
1	Sensor calibrating	Sensor is being calibrated.

### 11.3.8.2 Operation Measuring Status Register

The `CONDition` register contains information whether a power sensor is measuring. The `EVENT` register contains information whether a measurement was started or completed since the last query.

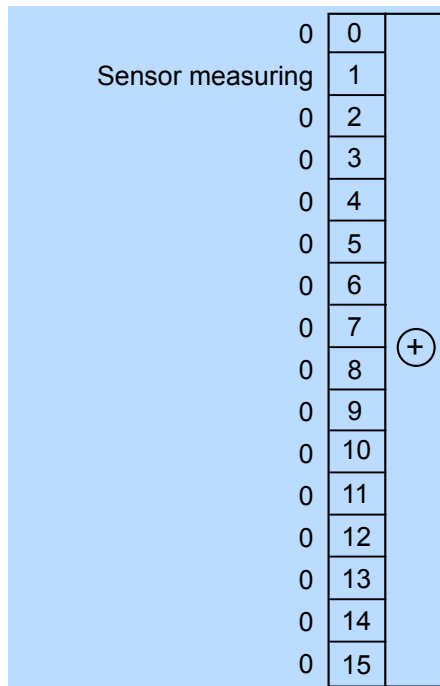

Figure 11-10: Operation measuring status register

Querying the register:

- `STATUS:OPERation:MEASuring:CONDition?`
- `STATUS:OPERation:MEASuring[:SUMMARY][:EVENT]?`

Table 11-12: Used operation measuring status bits and their meaning

Bit no.	Short description	Bit is set if
1	Sensor measuring	Sensor is measuring.

### 11.3.8.3 Operation Trigger Status Register

The `CONDition` register contains information whether a power sensor is waiting for a trigger event. The `EVENT` register contains information whether the power sensor has been waiting for a trigger event since the last query.

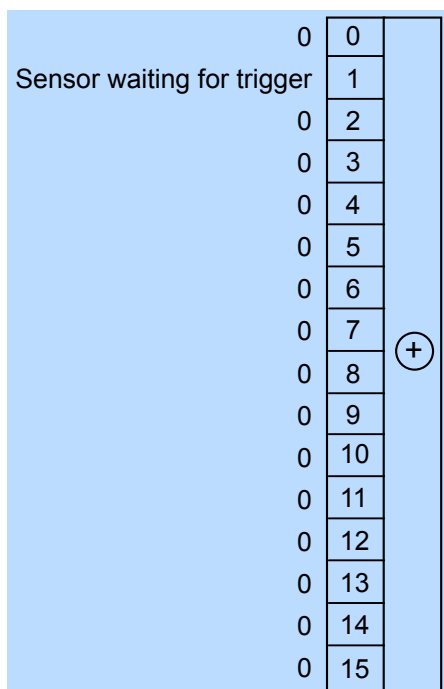

Figure 11-11: Operation trigger status register

Querying the register:

- `STATUS:OPERation:TRIGger:CONDition?`
- `STATUS:OPERation:TRIGger[:SUMMARY][:EVENT]?`

Table 11-13: Used operation trigger status bits and their meaning

Bit no.	Short description	Bit is set if
1	Sensor waiting for trigger	Sensor is waiting for a trigger event. When the trigger event occurs, the sensor changes into the measuring state.

### 11.3.8.4 Operation Sense Status Register

The `CONDition` register contains information whether a power sensor is being initialized. The `EVENT` register contains information whether an initialization was started or completed since the last query.

A power sensor is initialized if:

- Supply voltage is switched on (power-up).
- Sensor was connected.
- Reset was performed using:
  - `*RST`
  - `SYSTEM:PRESet`



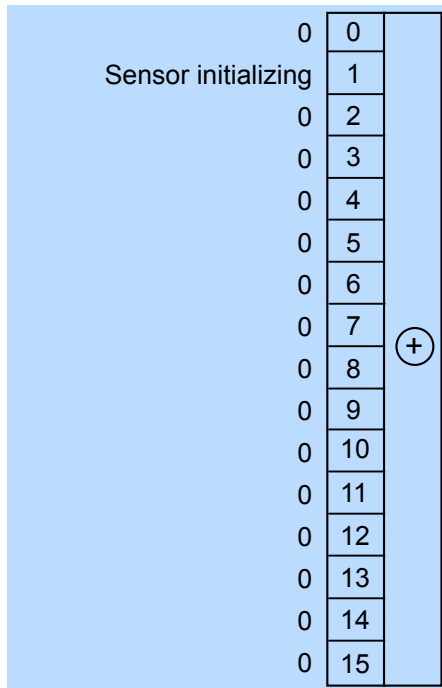

**Figure 11-12: Operation sense status register**

Querying the register:

- `STATUS:OPERation:SENSe:CONDition?`
- `STATUS:OPERation:SENSe[:SUMMARY][:EVENT]?`

**Table 11-14: Used operation sense status bits and their meaning**

Bit no.	Short description	Bit is set if
1	Sensor initializing	Sensor is being initialized.

### 11.3.8.5 Operation Lower Limit Fail Status Register

The `CONDition` registers contain information whether a measured value is below a configured lower limit. The `EVENT` registers contain information whether a measured value dropped below a limit value since the last query.

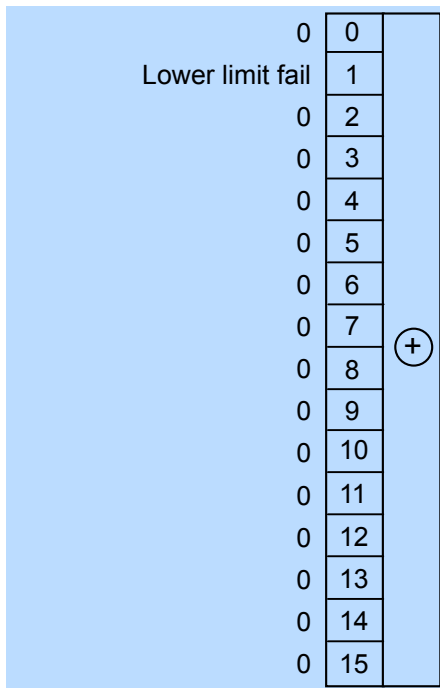

Figure 11-13: Operation lower limit fail status registers

Querying the register:

- `STATUS:OPERation:LLFail:CONDition?`
- `STATUS:OPERation:LLFail[:SUMMary][:EVENT]?`

Table 11-15: Used operation lower limit fail status bits and their meaning

Bit no.	Short description	Bit is set if
1	Lower limit fail	Measured value is below the lower limit value.

### 11.3.8.6 Operation Upper Limit Fail Status Register

The `CONDition` registers contain information whether a measured value currently exceeds a configured upper limit. The `EVENT` registers contain information whether a measured value exceeded an upper limit value since the last query.

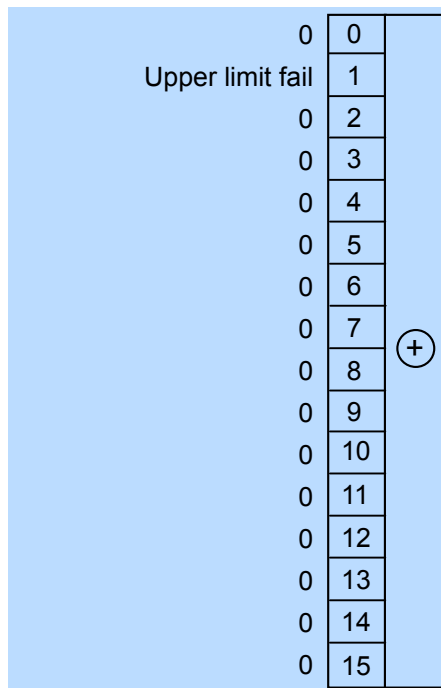

**Figure 11-14: Operation upper limit fail status registers**

Querying the register:

- `STATUS:OPERation:ULFail:CONDition?`
- `STATUS:OPERation:ULFail[:SUMMary][:EVENT]?`

**Table 11-16: Used operation upper limit fail status bits and their meaning**

Bit no.	Short description	Bit is set if
1	Upper limit fail	Measured value exceeds the upper limit value.

## 12 Troubleshooting

- [Displaying Status Information](#)..... 156
- [Performing a Selftest](#)..... 156
- [Problems during a Firmware Update](#)..... 157
- [Cannot Establish a LAN Connection](#)..... 157
- [Contacting Customer Support](#)..... 157

### 12.1 Displaying Status Information

Status information is available in several ways.

#### Status LED of the R&S NRPxxT(N)

The position of the status LED is indicated in [Chapter 4, "Power Sensor Tour"](#), on page 24.

The meaning of the different colors and blinking frequencies is explained in [Chapter 4.4, "Status LED"](#), on page 25.

#### Title bar of the web user interface (LAN power sensors)

Only available for power sensors with networking capabilities, the R&S NRP LAN power sensors.

The position of the status icon is indicated in [Figure 6-1](#). The colors are explained in [Chapter 4.4, "Status LED"](#), on page 25.

### 12.2 Performing a Selftest

The selftest gives you detailed information that you can use for troubleshooting.



Do not apply a signal to the sensor while the selftest is running. If the selftest is carried out with a signal being present, error messages can erroneously be output for the test steps *Offset Voltages* and/or *Noise Voltages*.

#### Using remote control

- ▶ For a quick check, send `TEST:SENSor?`.
- For each test step, PASS or FAIL is listed.

#### Using the web user interface (LAN power sensors)

1. In the navigation pane of the main dialog, select "Sensor".
2. Under "Diagnostics", click "Selftest".

See also ["Diagnostics"](#) on page 47.

## 12.3 Problems during a Firmware Update

The firmware update is described in [Chapter 7, "Firmware Update"](#), on page 54.

Solutions for potential problems that can occur when using the Firmware Update for NRP Family, see ["Troubleshooting"](#) on page 56.

### Firmware update was interrupted

If, for example, a power cut happened during the firmware update, problems can occur.

1. Perform the firmware update again. Sometimes, a further update fixes the problems.
2. If the power sensor is not accessible any more, contact the service.

### Firmware update was aborted

If there is not enough free storage space, the firmware update is aborted. An error message is displayed, and the status LED of the power sensor starts flashing red.

1. Perform a sanitization procedure, as described in the instrument security procedures. This document is available on the product page, see [Chapter 1.1, "Documentation Overview"](#), on page 9, or the CD-ROM delivered with the power sensor.
2. Perform the firmware update again.

## 12.4 Cannot Establish a LAN Connection

If you have problems to establish a LAN connection as described in [Chapter 3.6.3, "Using a LAN Connection"](#), on page 18, try the following measures:

- Use the Configure Network Sensor component of the R&S NRP Toolkit, see ["Configure Network Sensor"](#) on page 30.
- ["Troubleshooting for peer-to-peer connections"](#) on page 21

## 12.5 Contacting Customer Support

### Technical support – where and when you need it

For quick, expert help with any Rohde & Schwarz product, contact our customer support center. A team of highly qualified engineers provides support and works with you to find a solution to your query on any aspect of the operation, programming or applications of Rohde & Schwarz products.

**Contact information**

Contact our customer support center at [www.rohde-schwarz.com/support](http://www.rohde-schwarz.com/support), or follow this QR code:



*Figure 12-1: QR code to the Rohde & Schwarz support page*

## List of Commands

[SENSe<Sensor>:][POWer:][AVG:]APERture.....	84
[SENSe<Sensor>:][POWer:][AVG:]BUFFer:CLEar.....	84
[SENSe<Sensor>:][POWer:][AVG:]BUFFer:COUNT?.....	85
[SENSe<Sensor>:][POWer:][AVG:]BUFFer:DATA?.....	85
[SENSe<Sensor>:][POWer:][AVG:]BUFFer:SIZE.....	85
[SENSe<Sensor>:][POWer:][AVG:]BUFFer:STATe.....	85
[SENSe<Sensor>:][POWer:][AVG:]FAST.....	86
[SENSe<Sensor>:][POWer:][AVG:]SMOothing:STATe.....	86
[SENSe<Sensor>:]AVERage:COUNT.....	87
[SENSe<Sensor>:]AVERage:COUNT:AUTO.....	87
[SENSe<Sensor>:]AVERage:COUNT:AUTO:MTIME.....	87
[SENSe<Sensor>:]AVERage:COUNT:AUTO:NSRatio.....	88
[SENSe<Sensor>:]AVERage:COUNT:AUTO:RESolution.....	88
[SENSe<Sensor>:]AVERage:COUNT:AUTO:TYPE.....	89
[SENSe<Sensor>:]AVERage:RESet.....	88
[SENSe<Sensor>:]AVERage:TCONtrol.....	89
[SENSe<Sensor>:]AVERage[.STATe].....	90
[SENSe<Sensor>:]CORRection:DCYCLE.....	91
[SENSe<Sensor>:]CORRection:DCYCLE:STATe.....	91
[SENSe<Sensor>:]CORRection:OFFSet.....	91
[SENSe<Sensor>:]CORRection:OFFSet:STATe.....	92
[SENSe<Sensor>:]CORRection:SPDevice:LIST?.....	93
[SENSe<Sensor>:]CORRection:SPDevice:SElect.....	93
[SENSe<Sensor>:]CORRection:SPDevice:STATe.....	94
[SENSe<Sensor>:]FREQuency.....	90
[SENSe<Sensor>:]FUNction.....	68
[SENSe<Sensor>:]ROSCillator:SOURce.....	67
[SENSe<Sensor>:]SGAMma:CORRection:STATe.....	95
[SENSe<Sensor>:]SGAMma:MAGNitude.....	95
[SENSe<Sensor>:]SGAMma:PHASe.....	95
*CLS.....	63
*ESE.....	64
*ESR?.....	64
*IDN?.....	64
*IST?.....	64
*OPC.....	64
*OPT?.....	65
*PRE.....	65
*RCL.....	65
*RST.....	65
*SAV.....	65
*SRE.....	66
*STB?.....	66
*TRG.....	66
*TST?.....	66
*WAI.....	67
ABORT.....	69

CALibration:DATA.....	106
CALibration:DATA:LENGth?.....	106
CALibration:TEST:DEVIation?.....	106
CALibration:TEST:REFerence?.....	107
CALibration:TEST?.....	106
CALibration:USER:DATA.....	107
CALibration:USER:DATA:LENGth?.....	107
CALibration<Channel>:ZERO:AUTO.....	107
FETCh<Sensor>:ARRAy[:POWer][:AVG]?.....	82
FETCh<Sensor>[:SCALAr[:POWer][:AVG]?.....	82
FORMat:BORDer.....	81
FORMat:SREGister.....	81
FORMat[:DATA].....	82
INITiate:ALL.....	69
INITiate:CONTInuous.....	69
INITiate[:IMMediate].....	69
STATus:DEVIce:CONDition?.....	122
STATus:DEVIce:ENABle.....	123
STATus:DEVIce:NTRansition.....	123
STATus:DEVIce:PTRansition.....	124
STATus:DEVIce[:EVENT]?.....	122
STATus:OPERation:CALibrating:CONDition?.....	122
STATus:OPERation:CALibrating:ENABle.....	123
STATus:OPERation:CALibrating:NTRansition.....	123
STATus:OPERation:CALibrating:PTRansition.....	124
STATus:OPERation:CALibrating[:SUMMArY][:EVENT]?.....	122
STATus:OPERation:CONDition?.....	122
STATus:OPERation:ENABle.....	123
STATus:OPERation:LLFail:CONDition?.....	122
STATus:OPERation:LLFail:ENABle.....	123
STATus:OPERation:LLFail:NTRansition.....	123
STATus:OPERation:LLFail:PTRansition.....	124
STATus:OPERation:LLFail[:SUMMArY][:EVENT]?.....	122
STATus:OPERation:MEASuring:CONDition?.....	122
STATus:OPERation:MEASuring:ENABle.....	123
STATus:OPERation:MEASuring:NTRansition.....	123
STATus:OPERation:MEASuring:PTRansition.....	124
STATus:OPERation:MEASuring[:SUMMArY][:EVENT]?.....	122
STATus:OPERation:NTRansition.....	123
STATus:OPERation:PTRansition.....	124
STATus:OPERation:SENSe:CONDition?.....	122
STATus:OPERation:SENSe:ENABle.....	123
STATus:OPERation:SENSe:NTRansition.....	123
STATus:OPERation:SENSe:PTRansition.....	124
STATus:OPERation:SENSe[:SUMMArY][:EVENT]?.....	122
STATus:OPERation:TRIGger:CONDition?.....	122
STATus:OPERation:TRIGger:ENABle.....	123
STATus:OPERation:TRIGger:NTRansition.....	123
STATus:OPERation:TRIGger:PTRansition.....	124
STATus:OPERation:TRIGger[:SUMMArY][:EVENT]?.....	122



STATus:OPERation:ULFail:CONDition?	122
STATus:OPERation:ULFail:ENABLE	123
STATus:OPERation:ULFail:NTRansition	123
STATus:OPERation:ULFail:PTRansition	124
STATus:OPERation:ULFail[:SUMMARY][:EVENT]?	122
STATus:OPERation[:EVENT]?	122
STATus:PRESet	122
STATus:QUEStionable:CALibration:CONDition?	122
STATus:QUEStionable:CALibration:ENABLE	123
STATus:QUEStionable:CALibration:NTRansition	123
STATus:QUEStionable:CALibration:PTRansition	124
STATus:QUEStionable:CALibration[:SUMMARY][:EVENT]?	123
STATus:QUEStionable:CONDition?	122
STATus:QUEStionable:ENABLE	123
STATus:QUEStionable:NTRansition	123
STATus:QUEStionable:POWer:CONDition?	122
STATus:QUEStionable:POWer:ENABLE	123
STATus:QUEStionable:POWer:NTRansition	123
STATus:QUEStionable:POWer:PTRansition	124
STATus:QUEStionable:POWer[:SUMMARY][:EVENT]?	123
STATus:QUEStionable:PTRansition	124
STATus:QUEStionable:WINDow:CONDition?	122
STATus:QUEStionable:WINDow:ENABLE	123
STATus:QUEStionable:WINDow:NTRansition	123
STATus:QUEStionable:WINDow:PTRansition	124
STATus:QUEStionable:WINDow[:SUMMARY][:EVENT]?	123
STATus:QUEStionable[:EVENT]?	123
STATus:QUEue[:NEXT]?	122
SYSTem:COMMunicate:NETWork:IPAdDress	111
SYSTem:COMMunicate:NETWork:IPAdDress:GATeway	111
SYSTem:COMMunicate:NETWork:IPAdDress:INFO?	112
SYSTem:COMMunicate:NETWork:IPAdDress:MODE	112
SYSTem:COMMunicate:NETWork:IPAdDress:SUBNet:MASK	112
SYSTem:COMMunicate:NETWork:RESet	110
SYSTem:COMMunicate:NETWork:REStArt	110
SYSTem:COMMunicate:NETWork:STATus?	110
SYSTem:COMMunicate:NETWork[:COMMOn]:DOMain	110
SYSTem:COMMunicate:NETWork[:COMMOn]:HOSTName	110
SYSTem:DFPPrint<Channel>?	112
SYSTem:ERRor:ALL?	113
SYSTem:ERRor:CODE:ALL?	113
SYSTem:ERRor:CODE[:NEXT]?	113
SYSTem:ERRor:COUNT?	113
SYSTem:ERRor[:NEXT]?	114
SYSTem:FWUPdate	114
SYSTem:FWUPdate:STATus?	114
SYSTem:HELP:HEADers?	115
SYSTem:HELP:SYNTax:ALL?	115
SYSTem:HELP:SYNTax?	115
SYSTem:INFO?	115

SYSTem:INITialize.....	117
SYSTem:LANGuage.....	117
SYSTem:LED:COLor.....	117
SYSTem:LED:MODE.....	117
SYSTem:MINPower?.....	118
SYSTem:PARAmeters:DELTA?.....	118
SYSTem:PARAmeters?.....	118
SYSTem:PRESet.....	118
SYSTem:REBoot.....	118
SYSTem:REStart.....	119
SYSTem:RUTime.....	119
SYSTem:SERRor:LIST:ALL?.....	119
SYSTem:SERRor:LIST[:NEXT]?.....	119
SYSTem:SERRor?.....	119
SYSTem:SUTime.....	120
SYSTem:TLEVels?.....	120
SYSTem:TRANsaction:BEgIn.....	120
SYSTem:TRANsaction:END.....	120
SYSTem:VERSion?.....	121
SYSTem[:SENSor]:NAME.....	120
TEST:SENSor?.....	108
TRIGger:ATRigger:DELAy.....	75
TRIGger:ATRigger:EXECuted?.....	75
TRIGger:ATRigger[:STATe].....	75
TRIGger:COUNt.....	76
TRIGger:DELAy.....	76
TRIGger:DELAy:AUTO.....	76
TRIGger:DTIME.....	76
TRIGger:EXTErnal<2...2>:IMPedance.....	77
TRIGger:HOLDoff.....	77
TRIGger:HYSteresis.....	77
TRIGger:IMMediate.....	78
TRIGger:LEVel.....	78
TRIGger:LEVel:UNIT.....	78
TRIGger:MASTer:PORT.....	78
TRIGger:MASTer:STATe.....	79
TRIGger:SLOPe.....	79
TRIGger:SOURce.....	79
TRIGger:SYNC:PORT.....	80
TRIGger:SYNC:STATe.....	80
UNIT:POWer.....	80

# Index

## A

Android device	
R&S Power Viewer Mobile	37
Application cards	10
Application notes	10
Auto averaging	86
Averaging	
Auto	86

## B

Boolean parameters	136
Brochures	10
Browser-based user interface	31
See web user interface	42
Button	
LAN reset	26

## C

Calibrating	105
Case-sensitivity	
SCPI	133
Checking	12
Command line	137
Command structure	132
Command syntax	
Common	133
Device-specific	133
Common command	63
Syntax	133
Computer	
Connection types	15
Simple USB connection	15
USB sensor hub	16
CONDition	140
Configuration	
Averaging	48
Continuous average	45
General	46
Power sensor	46
System	52
Trigger	50
Connecting	
Base unit	17
RF	13
Supported Rohde & Schwarz instrument	17
To a computer	15
USB host	14
Connector	
Host interface	25
LAN	26
Overview	24
RF	24
Trigger I/O	25
Continuous average	
Parameters	45
Continuous average mode	
Buffered measurement	125
Controlling host	
Computer using LAN	18
R&S NRX	18

Correction	90
Duty cycle	90
Offset	91
S-Gamma	94
Customer support	157

## D

Data sheets	10
Device status register	143
Diagnostics	
Selftest	156
Disconnecting	
Host interface	14
RF	14
Documentation overview	9
Download	
R&S NRP Toolkit	28
Dropout time	
Trigger	71
DUT	
Connecting	13
Disconnecting	13
Duty cycle	90

## E

Electromagnetic interference (EMI)	13
Electrostatic discharge (ESD)	12
ENABLE	141
Enable register	147
ESE	147
ESR	147
Ethernet interface	
Remote control	130
EVENT	141

## F

Firmware update	30, 54
Potential risks	54
Problems	157
Remote control	57
Requirements	54
Web user interface	57
Firmware Update for NRP Family	55
Frequency	90

## G

Getting started	9
Graphical user interface	
See web user interface	42

## H

Hardware requirements	54
HiSLIP	
Protocol	131
Resource string	130
Hold-off time	
Trigger	72
Hostname	21

<b>I</b>			
Installation			
Firmware	54		
Instrument security procedures	9		
Intended use	11		
Interface			
Overview	24		
IP address	22		
<b>K</b>			
Key facts	10		
Keywords			
optional	62		
<b>L</b>			
LAN connection			
Configuration	30		
Hostname	21		
IP address	22		
Problems	157		
Setup	18, 20		
LAN reset button	26		
LED			
Network status	27		
Power status	27		
Status	25		
Low-level communication program	31		
<b>M</b>			
Measurement control	68		
Continuous average mode	73		
Trigger	70		
Measurement mode	45, 83		
Continuous average	45		
Remote control	68		
Measurement results			
Controlling	72		
Mnemonics	132		
Mobile measurements	37		
<b>N</b>			
Network status LED	27		
Notation			
Remote control	61		
NTRansition	140		
<b>O</b>			
Offset	91		
Open source acknowledgment (OSA)	10		
Operating concepts	28		
App for Android devices	37		
Browser-based user interface	31		
R&S NRP Toolkit	28		
R&S NRP2	39		
R&S NRPV	33		
R&S NRX	38		
R&S Power Viewer	35		
Remote control	33		
Operating conditions	12		
Operation calibrating status register	149		
Operation lower limit fail status register	153		
Operation measuring status register	150		
Operation sense status register	152		
Operation status register	148		
Operation trigger status register	151		
Operation upper limit fail status register	154		
<b>P</b>			
Parallel poll enable register	143		
Parameter			
Averaging	48		
Common	44		
Continuous average	45		
General	46		
Power sensor	46		
SCPI	134		
System	52		
Trigger	50		
Parameters			
Basic configuration	86		
Block data	137		
Special numeric values	135		
String	136		
Text	136		
Power status LED	27		
PPE	143		
Preparing for use	12		
Programming example	125		
Buffered measurement	125		
Simplest measurement	125		
Protocol			
HiSLIP	131		
VXI-11	131		
PTRansition	140		
<b>Q</b>			
Query	138		
Questionable calibration status register	146		
Questionable power status register	145		
Questionable status register	144		
<b>R</b>			
R&S NRP Toolkit	28		
Communication program	31		
Components for Windows-based systems	29		
Firmware update	30		
Installation under Windows	29		
Network Configuration	30		
S-parameter update	31		
System requirements	28		
Uncertainty calculator	31		
Versions	28		
Versions of R&S NRP software	31		
R&S NRP-Z5	16		
R&S NRP2	39		
R&S NRPV	33		
R&S NRX	38		
R&S Power Viewer	35		
R&S Power Viewer Mobile	37		
Reference source			
Remote control	67		
Release notes	10		
Remote control			
Basic measurement parameters	86		
Basics	128		

Command syntax .....	133
Common commands .....	63
Ethernet interface .....	130
HiSLIP protocol .....	131
Interfaces .....	128
Measurement mode .....	83
Measurement preparation .....	67
Notation .....	61
Protocols .....	128
Query .....	138
Response .....	138
Results .....	80
SCPI command structure .....	132
SCPI parameter .....	134
Socket communication .....	132
Structure .....	137
Syntax elements .....	137
USB interface .....	128
VISA resource strings .....	130
VXI-11 protocol .....	131
Replacement	
power sensor .....	59
Resource string	
HiSLIP .....	130
Socket .....	131
VISA .....	130
VXI-11 .....	130
Response .....	138
Results .....	80
RF connector .....	13, 24
<b>S</b>	
S-Gamma .....	94
S-parameter update .....	31
Safety information .....	11, 12
Safety instructions .....	9
SCPI parameter .....	134
SCPI status register	
Structure .....	140
Security procedures .....	9
Selftest .....	108, 156
Service request enable register .....	141
Setting	
See parameter .....	43
Setup	
LAN connection .....	18
Socket	
Communication .....	132
Resource string .....	131
Software requirements .....	54
Sources	
Trigger .....	71
Special characters	
SCPI .....	63
SRE .....	141
Standard event status register .....	147
Status	
Information .....	156
Status byte register .....	141
Status LED .....	25
Status register .....	121, 140
CONDition .....	140
CONDition part .....	122
Device status register .....	143
ENABLE .....	141
ENABle part .....	123
Enable register .....	147
EVENT .....	141
EVENT part .....	122
General commands .....	121
Hierarchy .....	139
IST flag .....	143
NTRansition .....	140
NTRansition part .....	123
Operation calibrating status register .....	149
Operation lower limit fail status register .....	153
Operation measuring status register .....	150
Operation sense status register .....	152
Operation status register .....	148
Operation trigger status register .....	151
Operation upper limit fail status register .....	154
Parallel poll enable register .....	143
PTRansition .....	140
PTRansition part .....	124
Questionable calibration status register .....	146
Questionable power status register .....	145
Questionable status register .....	144
Remote control .....	121
Service request enable register .....	141
Standard event status register .....	147
Status byte register .....	141
Sum bit .....	141
STB .....	141
Suffixes .....	62, 133
Sum bit .....	141
Syntax elements .....	137
System configuration .....	108
<b>T</b>	
Termination control .....	72
Test setup .....	12
Trigger .....	70
Dropout time .....	71
Event .....	70
Hold-off time .....	72
Sources .....	71
States .....	70
Trigger I/O connector .....	25
Troubleshooting .....	156
Firmware update .....	157
LAN connection problems .....	157
Selftest .....	156
Status information .....	156
Tutorials .....	9
<b>U</b>	
Uncertainty calculator .....	31
Unit .....	43
Units .....	135
Unpacking .....	12
USB connection .....	15
USB interface	
Remote control .....	128
USB product ID .....	129
USB resource string .....	129
USB sensor hub .....	16
User manual .....	9
<b>V</b>	
Versions of R&S NRP software .....	31

VISA	
Resource string .....	130
VXI-11	
Protocol .....	131
Resource string .....	130
<b>W</b>	
Web user interface .....	42
Main dialog .....	42
White papers .....	10
<b>Z</b>	
Zero configuration networking .....	20
Zeroing .....	105