

# RIGOL



## DS8000-R Series Compact Digital Oscilloscope

- Analog channel bandwidth: 350 MHz, 1 GHz, and 2 GHz
- Up to 10 GSa/s real-time sample rate (for DS8104-R/DS8204-R), 5 GSa/s (for DS8034-R)
- 4 analog channels, 1 EXT input channel
- Standard memory depth up to 500 Mpts
- High waveform capture rate (over 600,000 wfm/s)
- Low jitter, multiple-device synchronization (<200 ps<sub>RMS</sub>, typical)
- High-speed data communication interface (10 GE SFP+), ensuring the reliable transmission of massive data
- Integrates 6 independent instruments into 1, including digital oscilloscope, spectrum analyzer, AWG (option), digital voltmeter, 6-digit counter and totalizer, and protocol analyzer (option)
- Available to be extended to 512 channels, supporting synchronous acquisition (with the multi-channel synchronization module)
- Real-time eye diagram and jitter analysis software (option for DS8104-R/DS8204-R, but unavailable for DS8034-R)
- Built-in advanced power analysis software (option)
- Operating temperature low below -40°C, available to be used for signal monitoring in some special conditions
- Multiple interfaces available: USB HOST&DEVICE, LAN(LXI), 10 GE SFP+, HDMI, TRIG OUT, 10 MHz In, and 10 MHz Out
- Web Control remote command
- Compact and thin design, save rack space, 1U rack mount kit (standard)
- Software development kit available for users to meet their customized development according to their specific scenarios
- Easy-to-use on-site multi-channel synchronization calibration kit, enabling you to view multiple channels synchronously

DS8000-R series is a medium and high-end digital oscilloscope with a compact size designed on the basis of the ASIC chip (RIGOL self-owns its intellectual property right) and UltraVision II technical platform developed by RIGOL. It is compact and thin in design. It supports system integration of multiple devices, rack mount installation, and remote system operation to meet the system requirements for industrial automation test system. DS8000-R series oscilloscope has an analog bandwidth of up to 2 GHz, supporting multi-device synchronous triggering, available to be extended to 512 channels. It provides an excellent solution for users to meet their middle and high-speed requirement for the system integration test and synchronization requirement for multi-channel data acquisition.

# DS8000-R Series Compact Digital Oscilloscope

## Thin and Light in Body Design; Compact Design for Rack Mount Installation

- Thin and light in body design: 214 mm (W) × 43 mm (H) × 478 mm (D)

DS8000-R series digital oscilloscope is 1U in height, half-rack in width. A single oscilloscope provides 4 analog input channels, 1 EXE input channels, and 1 AWG output channel. It can be used on the workbench or be installed into the cabinet. When used on the workbench, you can use the stand-alone instrument equipped with a standard configuration of pads and handles. When installed into the cabinet, it is equipped with the rack mount kit. Therefore, it provides customers with friendly user experience wherever you use it, in the lab or in the production and manufacturing environment.



- Compact installation to save room

Multiple DS8000-R series oscilloscopes can be installed into one cabinet, supporting to be extended to 512 channels, capable of realizing real-time synchronous acquisition.



- In the system integration test scenario, multiple oscilloscopes of up to 128 sets can be integrated, with 512 extended channels. The compact installation has saved great room for users while meeting their demands for high-speed and multi-channel parallel data acquisition.
- The oscilloscope has excellent heat dissipation design and has undergone strict reliability test. It can be operated in the working temperature between -40°C and +50°C. Therefore, it can work normally in some extreme environment.
- The standard configuration of rack mount kit helps customers to quickly set up the multi-device integration environment system.

# Low Jitter, Multiple-Device Synchronization

- **Stand-alone with excellent performance**

For a stand-alone DS8000-R, its jitter of the external trigger can be as low as 200 ps<sub>RMS</sub>, delay as low as 150 ps (typ.), greatly improving the measurement accuracy.

- **Multi-device integration with stable performance**

For the assembled instruments being installed into the cabinet, the jitter among them is not greater than 350 ps<sub>RMS</sub> (typ.), with the total delay not greater than 500 ps (extremum). For a maximum of 128 sets working at the same time for synchronous data acquisition and transmission, it can ensure stable system performance and reliable measurement accuracy.

For users who demand for a multi-channel integration solution, it provides easy-to-use on-site multi-channel synchronization calibration kit, meeting their requirement for observing multiple channels synchronously, including but not limited to DS SYNC64, PRSC42 power divider, and phase match cable set.

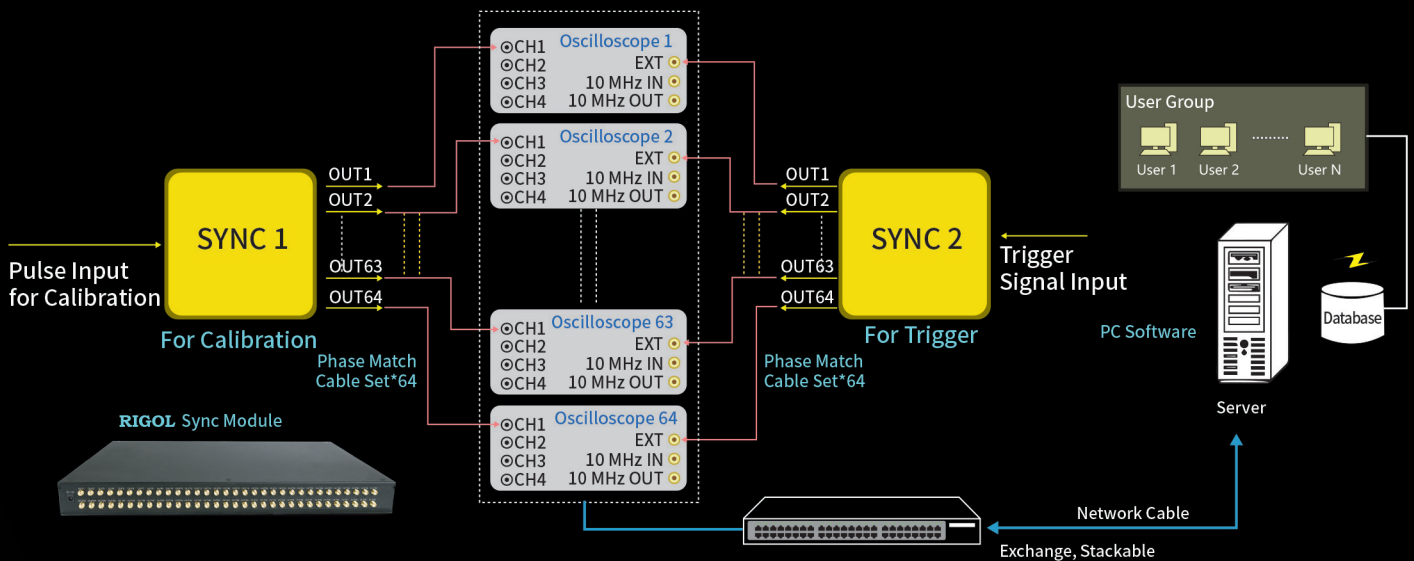

# 10 GE Optical Fiber Communication Technology

The optical fiber communication technology improves the transmission rate by 10 times on the basis of the original Gigabit Ethernet. It has strong electromagnetic interference capability and sound transmission quality, which can effectively support the long-distance transmission of massive data. Featuring light-weighting, compact, environment-friendly and energy-saving, the optical fiber cable is easy to be used in network building and future cable maintenance, being widely used in various fields currently.

The unique SFP+ optical transceiver electrical interface of the DS8000-R series provides 10 Gbit/s data transmission rate. When performing the acquisition of massive data remotely, the DS8000-R series oscilloscope can ensure the real-time and reliable transmission of data to meet the application requirements for industry automation or some special working environment.

Note: This function is only available when you have installed the DS8000-R-HSDC option.

## ► Overview of RIGOL's Medium and High-end Series Products

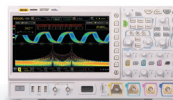

	MSO5000	MSO/DS7000	MSO8000	DS8000-R
Analog Channel	2/4+16	4 + 16	4 + 16	4
Analog Bandwidth	70 MHz to 350 MHz	100 MHz to 500 MHz	600 MHz/1 GHz/2 GHz	350 MHz/1 GHz/2 GHz
Max. Sample Rate	8 GSa/s	10 GSa/s	10 GSa/s	10 GSa/s/5 GSa/s
Max. Memory Depth	200 Mpts(optional)	500 Mpts (optional)	500 Mpts	500 Mpts
Waveform Capture Rate	>500,000 wfms/s	> 600,000 wfms/s	> 600,000 wfms/s	>600,000 wfms/s
Max. Frames of Waveform Recording	450,000	450,000	450,000	450,000
LCD	9" capacitive multi-touch screen	10.1" capacitive multi-touch screen	10.1" capacitive multi-touch screen	N/A
Hardware Template Test	Standard	Standard	Standard	Standard
Built-in Arbitrary Waveform Generator	2 CH, 25 MHz(optional)	2 CH, 25 MHz (optional)	2 CH, 25 MHz (optional)	1 CH, 25 MHz (optional)
Built-in Digital Voltmeter	Standard	Standard	Standard	Standard
Built-in Hardware Counter	6-digit frequency counter + totalizer	6-digit frequency counter + totalizer	6-digit frequency counter + totalizer	6-digit frequency counter + totalizer
Search and Navigation	Standard, supporting table display	Standard, supporting table display	Standard, supporting table display	Standard, supporting table display
Power Analysis	Built-in UPA (optional) + PC	Built-in UPA (optional) + PC	Built-in UPA (optional) + PC	Built-in UPA (optional) + PC
Real-time Eye Diagram	None	None	Optional	Optional/None
Jitter Analysis	None	None	Optional	Optional/None
Serial Protocol Analysis	RS232/UART, I2C, SPI, CAN, LIN, FlexRay, I2S, and MIL-STD-1553	RS232/UART, I2C, SPI, CAN, LIN, FlexRay, I2S, and MIL-STD-1553	RS232/UART, I2C, SPI, CAN, LIN, FlexRay, I2S, and MIL-STD-1553	RS232/UART, I2C, SPI, CAN, LIN, FlexRay, I2S, and MIL-STD-1553
Waveform Color Persistence	Standard	Standard	Standard	Standard
Histogram	Standard	Standard	Standard	Standard
FFT	Enhanced FFT, Standard	Enhanced FFT, Standard	Enhanced FFT, Standard	Enhanced FFT, standard
MATH	Displays 4 functions at the same time	Displays 4 functions at the same time	Displays 4 functions at the same time	Displays 4 functions at the same time
Connectivity	standard: USB, LAN, and HDMI option: USB-GPIB	standard: USB, LAN, and HDMI option: USB-GPIB	standard: USB, LAN, and HDMI option: USB-GPIB	standard: USB, LAN, and HDMI option: USB-GPIB, 10GE SFP+

# Design Features

► Self-developed ASIC and UltraVision II deliver excellent performance at an unprecedented price point



DS8000-R series digital oscilloscope adopts RIGOL's self-developed chipset "Phoenix", which can gain the data acquisition capability of up to 10 GSa/s sample rate, realizing the high integration of all the function modules required for the analog front-end (AFE), and greatly improving the consistency and reliability of the digital oscilloscope. The innovative UltraVision II platform delivers a higher waveform capture rate, full digital trigger technology, and full memory hardware measurement technology. The DS8000-R series digital oscilloscope also integrates other instrument modules, such as AWG, digital voltmeter, 6-digit counter and totalizer, and protocol analyzer, offering extraordinary user experience for users to meet their diversified demands.

- High sample rate (maximum sample rate: 10 GSa/s)
- High memory depth (maximum memory depth of 500 Mpts)
- High waveform capture rate (over 600,000 waveforms per second)
- Real-time waveform recording and playback functions (up to 450,000 frames)
- Full memory hardware measurement technology

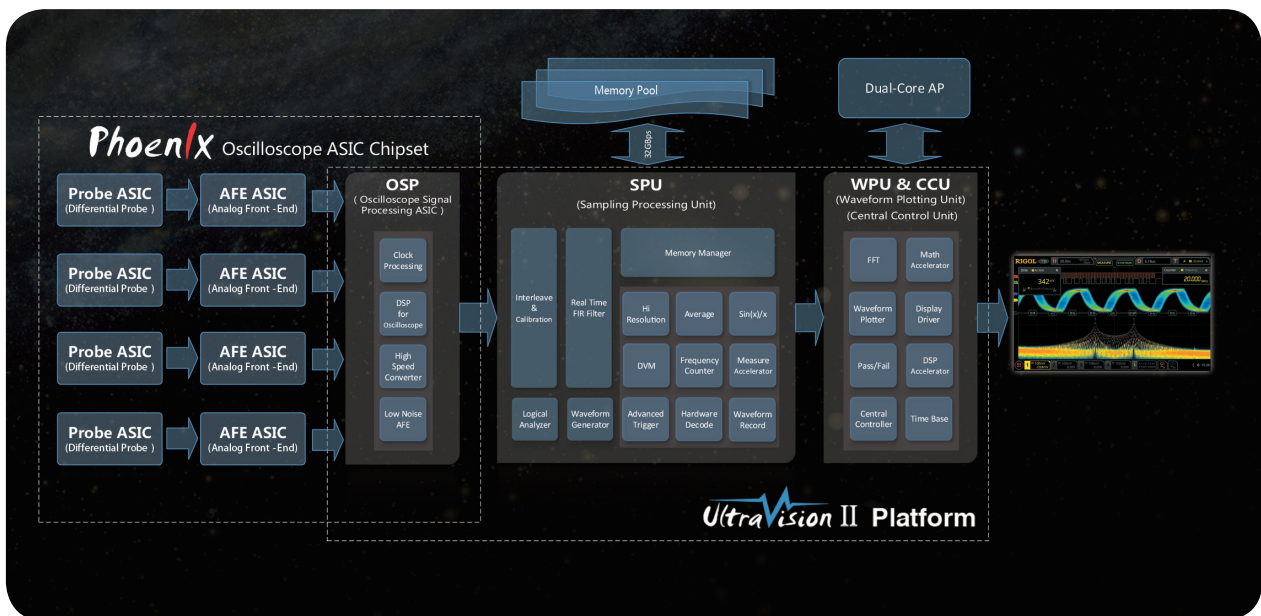

Higher capture rate, full memory test, and full digital trigger

## ► Convenient and Flexible Human-Machine Interaction

DS8000-R series does not have an LCD display or monitor. To set the parameters and view the measurement results, you need to connect it to an external control and display device. You can use the externally connected monitor, mouse, or keyboard to control the DS8000-R series oscilloscope. Also, you can use the standard Web Control software to realize remote control of the oscilloscope.

Through the Web Control method, you can migrate the device control and waveform analysis to the control terminals (e.g. PC, Mobile, iPad, and other smart terminals) to operate the instrument with the externally connected mouse. You can also use the Ultra Sigma software to send commands to control the oscilloscope.

### · To connect to the display and the control device

You can configure the parameters for the function menu, observe acquired waveforms, measurement results, and other information on the user interface through the display device (e.g. LCD, TV, projector, etc.) externally connected via the rear-panel HDMI interface. The keyboard and mouse can be connected to the

oscilloscope via the USB interface. In this way, you can input values or strings with the externally connected keypad and mouse; scroll with the mouse to select the desired parameter and adjust the parameter value; drag the mouse cursor to make dragging operation on the screen.

### · Web Control remote operation for the stand-alone oscilloscope

You only need to input the IP address of the oscilloscope into the address bar of the Web browser to open the Web Control software. The display of the waveform interface and instrument control in the software are consistent with that in the DS8000-R series. You can use the mouse to click the menus in the Web Control interface to complete the waveform control, measurement, and analysis. In the Web Control interface, the basic information of the instrument is displayed, and you can also set or modify the network status.

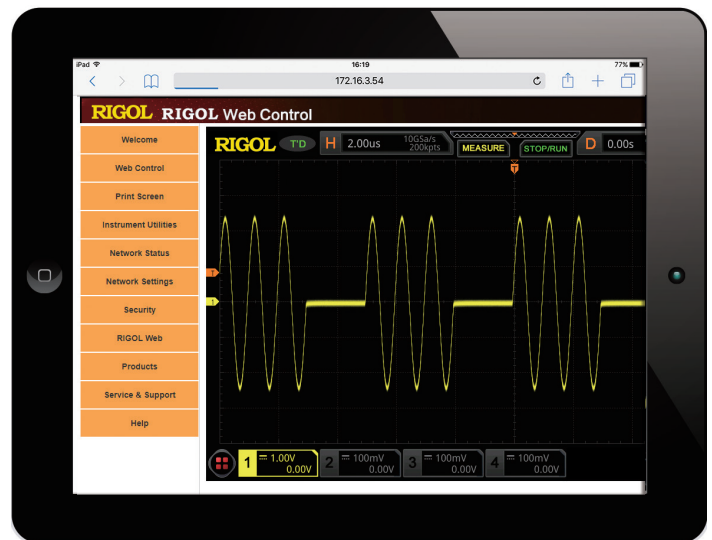

### · Use the Ultra Sigma software to send SCPI commands to control the instrument

Log in to RIGOL official website ([www.rigol.com](http://www.rigol.com)) to download and install Ultra Sigma PC software, then use the USB cable to connect with the PC via the USB DEVICE interface to build data communication between the oscilloscope and the PC. Then you can send commands with Ultra Sigma by inputting the command line manually.

Moreover, you can use the Excel, LabVIEW, Visual Basic, Visual C++, and relevant programming tools to send automatic commands in batches, to meet the demands of customers for automation test scenarios.

## ► Remote Control for Integration Application Scenarios

The powerful data analysis function of the DS8000-R is not limited to its stand-alone instrument, moreover, it can meet the demand of customers for remote control application at the system level in the multi-device

integration scenarios. They can make customization according to their actual situation based on the available open source.



### • UltraDAQ-Lite multi-channel high-speed data acquisition software

DS8000-R series oscilloscope is equipped with a standard configuration of lite version of multi-channel high-speed data acquisition software UltraDAQ-Lite, which enables users to make basic channel configurations and waveform

display in the simple integration system. UltraDAQ-Lite can control at most 4 sets of oscilloscopes to work synchronously to acquire data of 16 channels, and realize high-speed data communication over the 1000M network.

### • Use the open source to make further software development to meet customized demands

DS8000-R series oscilloscope provides the integration control software SDK (open source available for download at the official website of **RIGOL**).

Users can make flexible software development based on the open source according to their actual needs to

realize user-defined function, such as performing the measurement, analysis, history data export, and offline analysis for the acquired waveforms. The software development kit can help them meet their different application demands for different scenarios.

## ► 6-into-1 Integrated Digital Oscilloscope, with Excellent Performance at Unprecedented Price Point



In today's integrated design field, a highly integrated comprehensive digital oscilloscope has become a useful tool for design engineers. The DS8000-R series digital oscilloscope launched by **RIGOL** this time integrates 6 independent instruments into 1, including one digital oscilloscope, one spectrum analyzer, one arbitrary waveform generator, one digital voltmeter, one high-precision frequency counter and totalizer, and one protocol analyzer. The DS8000-R series offers you a flexible and economical solution to address your actual needs.

### 1. Digital Oscilloscope

- Three bandwidth models: 350 MHz, 1 GHz, and 2 GHz
- Up to 10 GSa/s real-time sample rate (for DS8104-R/DS8204-R), 5 GSa/s (for DS8034-R)
- 4 analog channels and 1 EXT channel
- Up to 500 Mpts memory depth
- Maximum waveform capture rate of 600,000 wfms/s



### 2. Spectrum Analyzer

- Standard configuration of enhanced FFT, real-time operation for max. 1 Mpts waveform data
- Max. frequency range: oscilloscope analog bandwidth
- Up to 4 groups of operations can be displayed at the same time
- Independent FFT color persistence view supported
- Up to 15 peaks available for the peak search function; event table available to be exported

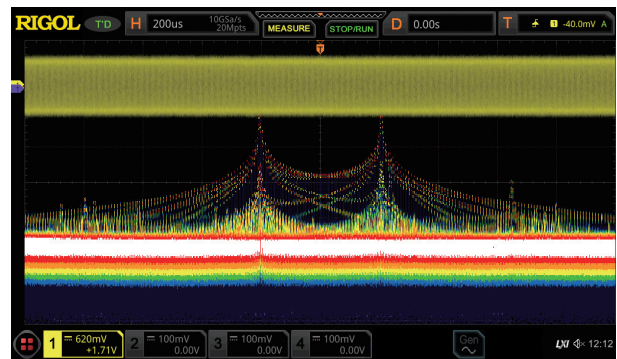

### 3. Arbitrary Waveform Generator (Option)

- Standard configuration of 1 waveform output channel for the hardware, and only AWG option is required to be ordered
- 13 pre-defined waveforms
- Up to 25 MHz frequency
- Up to 200 MSa/s sample rate
- Advanced modulation, sweep, and burst signal output

### 4. Digital Voltmeter

- 3-digit DC, AC RMS, AC+DC RMS voltage measurement
- Sound an alarm for reaching or exceeding the limits
- Display the latest measurement results in the form of a diagram, and display the extrema over the last 3 seconds

### 5. High-precision Frequency Counter and Totalizer

- 3 to 6-digit (selectable) high-precision frequency counter
- Support the statistics on the maximum and minimum values of the frequency
- 48-bit totalizer (standard)

### 6. Protocol Analyzer (Option)

- Support RS232/UART, I2C, SPI, CAN, LIN, I2S, FlexRay, and MIL-STD-1553 serial bus
- Support analog channel trigger and decode
- RS232/UART, I2C, and SPI support waveform search function
- Work with waveform recording, pass/fail, and zone trigger



## ► 600,000 wfms/s Capture Rate

Engineers often have to spend a lot of time and efforts in locating the problem in design and debugging. Therefore, a proper debugging tool will help engineers to work more efficiently. DS8000-R series digital oscilloscope can provide the waveform capture rate of up to 600,000 wfms/s, so that the glitches and infrequent events in waveforms can be quickly identified, greatly improving the debugging efficiency for the engineers.

256-level intensity grading display can reflect the occurrence frequencies of the infrequent events. Its color persistence function can highlight the signal of different probabilities with a different color grading. You can set the persistence time to control the duration time for the waveforms to be displayed on the screen, so that the display capability of the infrequent events can be further enhanced.



Capture occasional exceptional signals in a highly refreshed mode.



Changes of each frame of waveforms of the sweep signal can be clearly observed in the highly refreshed mode.

## ► Multiple External Interfaces





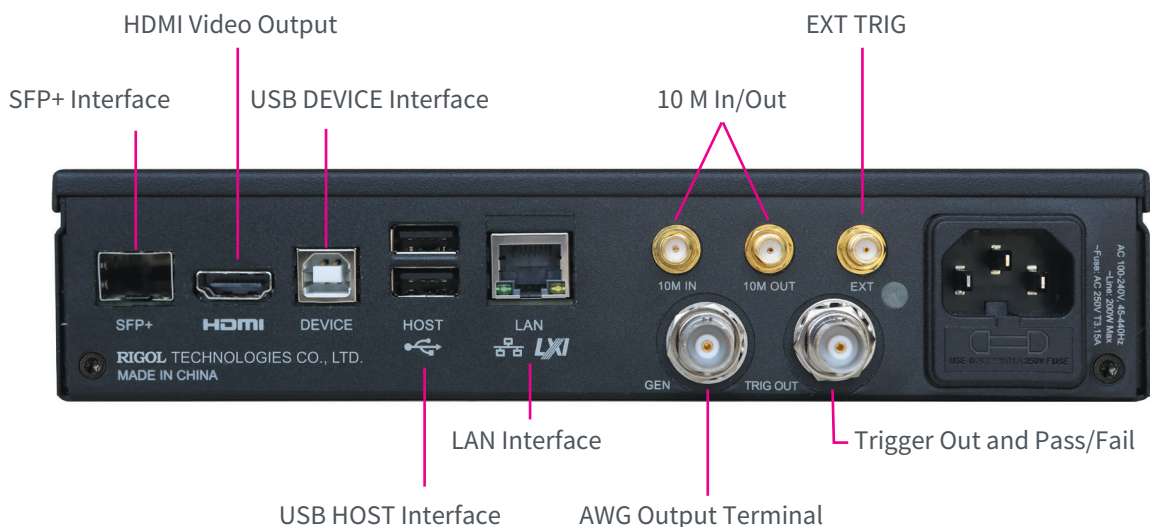





The DS8000-R series provides a variety of external interfaces, including USB HOST&DEVICE, LAN(LXI), HDMI, TRIG OUT, 10 G SFP+, 10 MHz In, 10 MHz Out, and USB-GPIB (option). The oscilloscope is in compliance with the standards specified in LXI Device Specification 2011.

It can access to the LXI webpage via the LAN interface. You can purchase the USB-GPIB interface converter from RIGOL to enjoy the reliable GPIB communication service. It also provides HDMI video output interface.













# RIGOL Probes and Accessories Supported by the DS8000-R Series

## • RIGOL Passive Probes

Model	Type	Description	Model	Type	Description
 <p>PVP2150</p>	High-impedance Probe	1X: DC ~ 35 MHz 10X: DC ~ 150 MHz Compatibility: All models of <b>RIGOL's</b> digital oscilloscopes	 <p>RP1010H</p>	High-voltage Probe	DC ~ 40 MHz DC: 0 ~ 10 kV DC AC: pulse $\leq 20$ kVp-p AC: sine wave $\leq 7$ kV <sub>RMS</sub> Compatibility: All models of <b>RIGOL's</b> digital oscilloscopes
 <p>PVP2350</p>	High-impedance Probe	1X: DC ~ 35 MHz 10X: DC ~ 350 MHz Compatibility: All models of <b>RIGOL's</b> digital oscilloscopes	 <p>RP1018H</p>	High-voltage Probe	DC ~ 150 MHz DC+AC Peak: 18 kV CAT II AC <sub>RMS</sub> : 12 kV CAT II Compatibility: All models of <b>RIGOL's</b> digital oscilloscopes
 <p>RP3500A</p>	High-impedance Probe	DC ~ 500 MHz Compatibility: All models of <b>RIGOL's</b> digital oscilloscopes	 <p>PHA0150</p>	High-voltage Differential Probe	BW: 70 MHz Max. voltage $\leq 1500$ Vpp Compatibility: All models of <b>RIGOL's</b> digital oscilloscopes
 <p>RP5600A</p>	High-impedance Probe	DC~600 MHz Compatibility: MSO/DS4000, DS6000, MSO/DS7000, MSO8000, and DS8000-R series	 <p>PHA1150</p>	High-voltage Differential Probe	BW: 100 MHz Max. voltage $\leq 1500$ Vpp Compatibility: All models of <b>RIGOL's</b> digital oscilloscopes
 <p>RP6150A</p>	Low-impedance Probe	DC~1.5 GHz Compatibility: MSO/DS4000, DS6000, MSO/DS7000, MSO8000, and DS8000-R series			
 <p>RP1300H</p>	High-voltage Probe	DC ~ 300 MHz CAT I 2000 V (DC+AC) CAT II 1500 V (DC+AC) Compatibility: All models of <b>RIGOL's</b> digital oscilloscopes			

• **RIGOL Active and Current Probes**

Model	Type	Description	Model	Type	Description
 PVA7250	Single-ended/ Differential Active Probe	BW: DC~2.5 GHz 30 V <sub>pp</sub> , CAT I Compatibility: MSO/ DS7000, MSO8000, and DS8000-R series	 RP1025D	High-voltage Differential Probe	BW: 25 MHz Max. voltage ≤ 1400 V <sub>pp</sub> Compatibility: All models of <b>RIGOL</b> 's digital oscilloscopes
 RP7150	Single-ended/ Differential Active Probe	BW: DC~1.5 GHz 30 V <sub>pp</sub> , CAT I Compatibility: MSO/ DS4000, DS6000, MSO/ DS7000, MSO8000, and DS8000-R series	 RP1050D	High-voltage Differential Probe	BW: 50 MHz Max. voltage ≤ 7000 V <sub>pp</sub> Compatibility: All models of <b>RIGOL</b> 's digital oscilloscopes
 RP7080	Single-ended/ Differential Active Probe	BW: DC~0.8 GHz 30 V <sub>pp</sub> , CAT I Compatibility: MSO/ DS4000, DS6000, MSO/ DS7000, MSO8000, and DS8000-R series	 RP1100D	High-voltage Differential Probe	BW: 100 MHz Max. voltage ≤ 7000 V <sub>pp</sub> Compatibility: All models of <b>RIGOL</b> 's digital oscilloscopes
 RP7150S	Single-ended Active Probe	BW: DC~1.5 GHz 30 V <sub>pp</sub> , CAT I Compatibility: MSO/ DS4000, DS6000, MSO/ DS7000, MSO8000, and DS8000-R series			
 RP7080S	Single-ended Active Probe	BW: DC~0.8 GHz 30 V <sub>pp</sub> , CAT I Compatibility: MSO/ DS4000, DS6000, MSO/ DS7000, MSO8000, and DS8000-R series			
 RP1001C	Current Probe	BW: DC ~ 300 kHz Maximum Input DC: ±100 A AC P-P: 200 A AC RMS: 70 A Compatibility: All models of <b>RIGOL</b> 's digital oscilloscopes			
 RP1002C	Current Probe	BW: DC ~ 1 MHz Maximum Input DC: ±70 A AC P-P: 140 A AC RMS: 50 A Compatibility: All models of <b>RIGOL</b> 's digital oscilloscopes			

# Specifications

All the specifications are guaranteed except the parameters marked with "Typical" and the oscilloscope needs to operate for more than 30 minutes under the specified operation temperature.

## Overview of the DS8000-R Series Technical Specifications

Model	DS8104-R	DS8204-R	DS8034-R
Analog bandwidth (50 $\Omega$ , -3dB) <sup>[1]</sup>	1 GHz	2 GHz	350 MHz
Analog bandwidth (1 M $\Omega$ , -3dB)	500 MHz	500 MHz	350 MHz
Calculated Rising Time under 50 $\Omega$ (single-channel mode, 10%-90%, typical)	$\leq 350$ ps	$\leq 225$ ps	$\leq 1$ ns
Max. Sample Rate of Analog Channel	10 GSa/s (single-channel), 5 GSa/s (half-channel <sup>[2]</sup> ), 2.5 GSa/s (all channels) Note: When all the channels are enabled, the sample rate is 2.5 GSa/s, and the max. analog bandwidth reaches 1 GHz.		5 GSa/s (single-channel), 5 GSa/s (half-channel), 2.5 GSa/s (all channels)
Peak Detection	capture 400 ps glitches		capture 800 ps glitches
Max. Memory Depth	500 Mpts (single-channel), 250 Mpts (half-channel <sup>[2]</sup> ), 125 Mpts (all channels)		
Hardware real-time waveform recording and playing	$\geq 450,000$ wfms (single-channel)		
Max. Waveform Capture Rate <sup>[3]</sup>	$\geq 600,000$ wfms/s		
No. of Input/Output Channels	4 input analog channels		
	1 input EXT channel		
	Arbitrary waveform generator output (required to purchase the DS8000-R-AWG option)		
Sampling Mode	Real-time sampling		

## Vertical System Analog Channel

Vertical System Analog Channel	
Input Coupling	DC, AC, or GND
Input Impedance	1 M $\Omega$ $\pm$ 1%, 50 $\Omega$ $\pm$ 1%
Input Capacitance	19 pF $\pm$ 3 pF
Probe Attenuation Coefficient	0.0001X, 0.0002X, 0.0005X, 0.001X, 0.002X, 0.005X, 0.01X, 0.02X, 0.05X, 0.1X, 0.2X, 0.5X, 1X, 2X, 5X, 10X, 20X, 50X, 100X, 200X, 500X, 1000X, 2000X, 5000X, 10000X, 20000X, and 50000X
Probe Recognition	Auto-recognized RIGOL probe
Maximum Input Voltage	1 M $\Omega$ CAT I 300 Vrms, 400 Vpk, Transient Overvoltage 1600 Vpk
	50 $\Omega$ 5 V <sub>RMS</sub>
Vertical Resolution	8 bits
Vertical Sensitivity Range <sup>[4]</sup>	1 M $\Omega$ 1 mV/div~10 V/div
	50 $\Omega$ 1 mV/div~1 V/div
Offset Range	1 M $\Omega$ $\pm$ 1 V (1 mV/div~50 mV/div) $\pm$ 30 V (51 mV/div~260 mV/div) $\pm$ 100 V (265 mV/div~10 V/div)
	50 $\Omega$ $\pm$ 1 V (1 mV/div~100 mV/div) $\pm$ 4 V (102 mV/div~1 V/div)
Dynamic Range	$\pm$ 5 div(8 bit)
Bandwidth Limit (Typical) (DS8204-R/DS8104-R)	1 M $\Omega$ 20 MHz, 250 MHz, 500 MHz; selectable for each channel
	50 $\Omega$ 20 MHz
Bandwidth Limit (Typical) (DS8034-R)	20 MHz, 250 MHz; selectable for each channel

DC Gain Accuracy <sup>[4]</sup>	± 2% of full scale
DC Offset Accuracy	>200 mV/div (±0.1 div±2 mV±1.5% of offset value)
Channel-to-Channel Isolation	≥ 100:1 (from DC to 1 GHz), ≥ 30:1 (1 GHz to maximum rated bandwidth)
ESD Tolerance	±8 kV (on input BNCs)

## Horizontal System Analog Channel

Horizontal System Analog Channel		1 GHz	2 GHz	350 MHz
Range of Time Base		200 ps/div~1 ks/div		
		Fine		
Time Base Resolution		2 ps		
Time Base Accuracy		±1 ppm ± 2 ppm/year		
Time Base Delay Range	before triggering	≥ 1/2 screen width		
	after triggering	1 s or 100 div, whichever is greater		
Time Interval ( Δ T) Measurement		±(1 sample interval) ± (2 ppm× readout) ±50 ps		
Inter-channel Offset Correction Range		±100 ns		
Horizontal Mode	YT	Default		
	XY	X = Channel 1, Y = Channel 2		
	SCAN	Time base ≥ 200 ms/div		
	ROLL	Time base ≥ 200 ms/div		

## Acquisition System

Acquisition System			
Max. Sample Rate of Analog Channel	10 GSa/s (single-channel), 5 GSa/s (half-channel <sup>[2]</sup> ), 2.5 GSa/s (all channels) Note: When all the channels are enabled, the sample rate is 2.5 GSa/s, and the max. analog bandwidth reaches 1 GHz.	5 GSa/s (single-channel), 5 GSa/s (half-channel), 2.5 GSa/s (all channels)	
Max. Memory Depth of Analog Channel	500 Mpts (single-channel), 250 Mpts (half-channel <sup>[2]</sup> ), 125 Mpts (all channels)		
Acquisition Mode	Normal	Default	
	Peak Detection	capture 400 ps glitches	capture 800 ps glitches
	Average Mode	2, 4, 8, 16...65536 are available for you to choose, averaging point by point	
	High Resolution	12 bits	

## Trigger System

Trigger System		
Trigger Source	Analog channel (1~4), EXT TRIG, AC Line	
Trigger Mode	Auto, Normal, Single	
Trigger Coupling	DC	DC coupling trigger
	AC	AC coupling trigger
	High Frequency Rejection	High frequency rejection, cut-off frequency~75 kHz (internal only)
	Low Frequency Rejection	Low frequency rejection, cut-off frequency~75 kHz (internal only)
Noise Rejection	increase delay for the trigger circuit (internal only), On/Off	
Holdoff Range	8 ns to 10 s	
Trigger Bandwidth	Internal: analog bandwidth of the oscilloscope External: 200 MHz	

Trigger Sensitivity (Internal)	1 div, < 10 mV/div 0.6 div, 10 mV/div ~ 19.8 mV/div 0.4 div, 20 mV/div ~ 49.5 mV/div 0.35 div, ≥ 50mV/div enable the noise rejection, with trigger sensitivity reducing half	
Trigger Sensitivity (External)	200 mVpp, DC~100 MHz 500 mVpp, 100 MHz~200 MHz	
EXT TRIG	Input Impedance	input impedance 50Ω±1%, SMA connector
	Max. Input	≤ 5 V <sub>RMS</sub>
	Trigger Jitter (Typ.)	<200 ps <sub>RMS</sub> (extremum < 250 ps) Normal acquisition, Edge trigger, trigger level located near 50% of EXT input signal
	Trigger Delay Among Instruments (Typ.)	Typ.: ±100ps <sub>RMS</sub> jitter, 150 ps delay total delay among instruments: ≤ 350 ps <sub>RMS</sub> (extremum ≤ 500ps) sine curve with the input voltage ≥ 500 mV can be improved through calibration
Trigger Level Range	Internal	± 5 div from the center of the screen
	External	±5 V
	AC Line	fixed 50%

## Trigger Type

Trigger Type	
Zone Trigger	Triggers in the rectangle area drawn manually, supporting trigger zone A and trigger zone B. The trigger conditions can be "Intersect" or "Not intersect" Source channel: CH1~CH4; only one analog channel is triggered each time
Trigger Type	Standard: Edge trigger, Pulse trigger, Slope trigger, Video trigger, Pattern trigger, Duration trigger, Timeout trigger, Runt trigger, Window trigger, Delay trigger, Setup/Hold trigger, and Nth Edge trigger Option: RS232/UART, I2C, SPI, CAN, FlexRay, LIN, I2S, and MIL-STD-1553
Edge	Triggers on the threshold of the specified edge of the input signal. The edge types can be Rising, Falling, or Either. Source channel: CH1~CH4, EXT, or AC Line
Pulse	Triggers on the positive or negative pulse with a specified width. The pulse width is greater or smaller than a certain value or within a certain time range. Source channel: CH1~CH4
Slope	Triggers on the positive or negative slope of the specified time. The slew time is greater or smaller than a certain value or within a certain time range (800 ps~10 s). Source channel: CH1~CH4
Video	Triggers on all lines, specified line, add field, or even field that conforms to the video standards. The supported video standards include NTSC, PAL/SECAM, 480p/60Hz, 576p/50Hz, 720p/60Hz, 720p/50Hz, 720p/30Hz, 720p/25Hz, 720p/24Hz, 1080p/60Hz, 1080p/50Hz, 1080p/30Hz, 1080p/25Hz, 1080p/24Hz, 1080i/60Hz, and 1080i/50Hz. Source channel: CH1~CH4
Pattern	Identifies a trigger condition by searching for a specified pattern. The pattern is a combination of multiple selected channel sources. The logic pattern of each channel is H, L, X, Rising, or Falling. Source channel: CH1~CH4
Duration	Triggers when the specified pattern meets the specified duration condition. The pattern is a combination of multiple selected channel sources. The logic pattern of each channel is H, L, X. The duration is greater or smaller than a certain value, or within a certain time range, or outside a certain time range. Source channel: CH1~CH4
Timeout	Triggers when duration of a certain event exceeds the specified time (16 ns~10 s). The event can be specified as Rising, Falling, or Either. Source channel: CH1~CH4
Runt	Triggers when the pulses pass through one threshold but fail to pass through another threshold. Source channel: CH1~CH4
Window	Triggers in a specified window state when the rising edge of the signal crosses the upper threshold or the falling edge crosses the lower threshold. The window state can be Enter, Exit, or Time. Source channel: CH1~CH4
Delay	Triggers when the time difference between the specified edges of Source A and Source B meets the preset time. The duration is greater or smaller than a certain value, or within a certain time range, or outside a certain time range. Source channel: CH1~CH4
Setup/Hold	When the setup time or hold time between the input clock signal and the data signal is smaller than the specified time (8 ns~1 s). Source channel: CH1~CH4

Nth Edge	Triggers on the Nth edge that appears after the specified idle time. The edge can be specified as Rising or Falling. Source channel: CH1~CH4
RS232/UART (Option)	DS8000-R-COMP option Triggers on the Start, Error, Check Error, or Data frame of the RS232/UART bus (up to 20 Mb/s). Source channel: CH1~CH4
I2C (Option)	DS8000-R-EMBD option Triggers on the Start, Stop, Restart, MissedACK, Address (7 bits, 8 bits, or 10 bits), Data, or Address Data of the I2C bus. Source channel: CH1~CH4
SPI (Option)	DS8000-R-EMBD option Triggers on the specified pattern of the specified data width (4~32) of SPI bus. CS and Timeout are supported. Source channel: CH1~CH4
CAN (Option)	DS8000-R-AUTO option Triggers on the start of a frame, end of a frame, Remote ID, Overload, Frame ID, Frame Data, Data&ID, Frame Error, Answer Error, Check Error, Format Error, Bit Fill, and Random of the CAN signal (up to 5Mb/s). The supported CAN bus signal types include CAN_H, CAN_L, TX/RX, and DIFF. Source channel: CH1~CH4
FlexRay (Option)	DS8000-R-FLEX option Triggers on the specified position (TSS End, FSS_BSS End, FES End, DTS End), frame (null, Syn, Start, All), symbol (CAS/MTS and WUS), error (Head CRC Err, Tail CRC Err, Decode Err, and Random Err) of the FlexRay signal (up to 10 Mb/s). Source channel: CH1~CH4
LIN (Option)	DS8000-R-AUTO option Triggers on the Sync, ID, Data (length settable), Data&ID, Wakeup, Sleep, and Error of the LIN bus signal (up to 20 Mb/s). Source channel: CH1~CH4
I2S (Option)	DS8000-R-AUDIO option Triggers on 2's complement data of audio left channel, right channel, or either channel ( = , ≠ , > , < , <> , >< ). The available alignment modes include I2S, LJ, and RJ. Source channel: CH1~CH4
MIL-STD-1553 (Option)	DS8000-R-AERO option Triggers on Sync (Data Sync, Cmd/Status Sync, and All Sync), Data, RTA, RTA+11Bit, and Error (Sync Error and Check Error) of the MIL-STD-1553 bus. Source channel: CH1~CH4

## Search&Navigation

Search, Navigation, and Table	
Type	Edge, Pulse, Runt, Slope, RS232, I2C, and SPI
Source	Any analog channel
Copy	Copy the search settings to the trigger settings, and copy from the trigger settings
Result Display	Event table or navigation. Go to the specific event through the event table index
Navigation	Event navigation: scroll through the event search results.

## Waveform Measurement

Waveform Measurement		
	Number of Cursors	2 pairs of XY cursors
	Manual Mode	Voltage deviation between cursors ( $\Delta Y$ ) Time deviation between cursors ( $\Delta X$ ) Reciprocal of $\Delta X$ (Hz) ( $1/\Delta X$ )
Cursor	Track Mode	Fix Y-axis to track X-axis waveform point's voltage and time values Fix X-axis to track Y-axis waveform point's voltage and time values
	Auto Measurement	Allows to display cursors during auto measurement
	XY Mode	Measures the voltage parameters of the corresponding channel waveforms in XY time base mode. X = Channel 1, Y = Channel 2

Auto Measurement	Number of Measurements	41 auto measurements; and up to 10 measurements can be displayed at a time.
	Measurement Source	CH1-CH4, Math1-Math4
	Measurement Mode	Normal and Precision (full-memory hardware measurement)
	Measurement Range	Main, Zoom, and Cursor
	All Measurement	Display 33 measurement items for the current measurement channel; the measurement results are updated continuously; you can switch the measurement channel.
	Vertical	Vmax, Vmin, Vpp, Vtop, Vbase, Vamp, Vupper, Vmid, Vlower, Vavg, VRMS, Per. VRMS, Overshoot, Preshoot, Area, Period Area, and Std Dev.
	Horizontal	Period, Frequency, Rise Time, Fall Time, +Width, -Width, +Duty, -Duty, Positive Pulse Count, Negative Pulse Count, Rising Edge Count, Falling Edge Count, T <sub>vmax</sub> , T <sub>vmin</sub> , +Slew Rate, and -Slew Rate
	Others	Delay(A ↑ -B ↑ ), Delay(A ↑ -B ↓ ), Delay(A ↓ -B ↑ ), Delay(A ↓ -B ↓ ), Phase(A ↑ -B ↑ ), Phase(A ↑ -B ↓ ), Phase(A ↓ -B ↑ ), and Phase(A ↓ -B ↓ )
	Statistics	Current, Average, Max, Min, Standard Deviation, Count Statistical times settable

## Waveform Calculation

Waveform Calculation		
No. of Math Functions	4; 4 math functions available to be displayed at a time	
Operation	A+B, A-B, A×B, A/B, FFT, A&&B, A  B, A^B, !A, Intg, Diff, Sqrt, Lg, Ln, Exp, Abs, AX+B, LowPass, HighPass, BandPass, and BandStop	
Color Grade	Supporting Math and FFT	
Enhanced FFT	Record Length	Max. 1 Mpts
	Window Type	Rectangular, Blackman-Harris, Hanning (default), Hamming, Flattop, and Triangle.
	Peak Search	A maximum of 15 peaks, confirmed by the settable threshold and offset threshold set by users

## Waveform Analysis

Waveform Analysis		
Waveform Recording		Stores the signal under test in segments according to the trigger events, i.g. save all the sampled waveform data as a segment to the RAM for each trigger event. The maximum number of the sampled segments reaches 450,000.
	Source	All enabled analog channels
PassFail	Analysis	Support playing frame by frame or continuous playing; capable of calculating, measuring, and decoding the played waveforms
	Source	Any analog channel
Histogram		The waveform histogram provides a group of data, showing the number of times a waveform hits within the defined region range on the screen. The waveform histogram not only shows the distribution of hits, but also the ordinary measurement statistics.
	Source	Any analog channel, auto measurement item, or jitter measurement
	Type	Horizontal, vertical, and measure
	Measure	Sum, Peaks, Max, Min, Pk_Pk, Mean, Median, Mode, Bin width, Sigma, and XScale
Color Grade	Mode	Support all modes, except the Zoom, XY, and ROLL modes
		Provide a dimensional view for color grade waveforms
	Source	Any analog channel
	Color Theme	Temperature and intensity
	Mode	Support all modes



Real-time Eye Diagram (JITTER Option) <sup>[5]</sup>		Provide the eye display based on the recovered clock period by acquiring the fixed length of data to make successive and superimposing display in color persistence form.
	Source	Any analog channel
	Clock Recovery	Constant clock, first-order PLL, second-order PLL, and explicit clock
	Data Rate	Fully automatic, semi automatic, and manual
	Eye Measurement Item	One level, zero level, eye height, eye width, eye amplitude, crossing percentage, and Q Factor
Jitter Analysis (JITTER Option) <sup>[5]</sup>		Make measurements for the clock or data signal over time, analyze the variance of the technical specifications.
	Source	Any analog channel
	Clock Recovery	Constant clock, first-order PLL, second-order PLL, and explicit clock
	Data Rate	Fully automatic, semi automatic, and manual
	Jitter Measurement	TIE, Cycle to Cycle, +Width to +Width, and -Width to -Width
	Measurement Display	Meas trend, meas histogram

## Serial Decoding

Serial Decoding	
Number of Decodings	4, four protocol types can be supported at the same time
Decoding Type	Standard: Parallel Option: RS232/UART, I2C, SPI, LIN, CAN, FlexRay, I2S, and MIL-STD-1553
Parallel	Up to 4 bits of Parallel decoding, supporting any analog channel Support user-defined clock and auto clock settings. Source channel: CH1~CH4
RS232/UART	DS8000-R-COMP option Decodes the RS232/UART (up to 20 Mb/s) bus's TX/RX data (5-9 bits), parity (Odd, Even, or None), and stop bits (1-2 bits) Source channel: CH1~CH4
I2C	DS8000-R-EMBD option Decodes the address (with or without the R/W bit) of the I2C bus, data, and ACK. Source channel: CH1~CH4
SPI	DS8000-R-EMBD option Decodes the MISO/MOSI data (4-32 bits) of the SPI bus. The available mode includes "Timeout" and "CS". Source channel: CH1~CH4
LIN	DS8000-R-AUTO option Decodes the protocol version (1.X or 2.X) of the LIN bus (up to 20 Mb/s). The decoding displays sync, ID, data, and check sum. Source channel: CH1~CH4
CAN	DS8000-R-AUTO option Decodes the remote frame (ID, byte number, CRC), overload frame, and data frame (standard/extended ID, control domain, data domain, CRC, and ACK) of the CAN bus (up to 5 Mb/s). The supported CAN bus signal types include CAN_H, CAN_L, TX/RX, and DIFF. Source channel: CH1~CH4
FlexRay	DS8000-R-FLEX option Decodes the frame ID, PL (payload), Header CRC, Cycle Count, Data, Tail CRC, and DTS of the FlexRay bus (up to 10 Mb/s). The supported signal types include BP, BM, and RX/TX. Source channel: CH1~CH4
I2S	DS8000-R-AUDIO option Decodes I2S audio bus left channel data and right channel data, supporting 4-32 bits. The alignment modes include I2S, LJ, and RJ. Source channel: CH1~CH4
MIL-STD-1553	DS8000-R-AERO option Decodes the MIL-STD-1553 bus signal's data word, command word, and status word (address+last 11 bits). Source channel: CH1~CH4

## Auto

Auto	
AutoScale	Min voltage greater than 10 mVpp, duty cycle 1%, frequency over 35 Hz

## Arbitrary Waveform Generator

Arbitrary Waveform Generator (technical specifications are typical values) (option)		
Number of Channels	1	
Output Mode	Single BNC connector	
Sample Rate	200 MSa/s	
Vertical Resolution	14 bits	
Max. Frequency	25 MHz	
Standard Waveform	Sine, Square, Ramp, Pulse, DC, Noise	
Built-in Waveform	Sinc, Exp.Rise, Exp.Fall, ECG, Gauss, Lorentz, Haversine	
Sine	Frequency Range	100 mHz to 25 MHz
	Flatness	$\pm 0.5$ dB (relative to 1 kHz)
	Harmonic Distortion	-40 dBc
	Spurious (non-harmonics)	-40 dBc
	Total Harmonic Distortion	1%
	S/N Ratio	40 dB
Square/Pulse	Frequency Range	Square: 100 mHz to 15 MHz Pulse: 100 mHz to 1 MHz
	Rise/Fall Time	<15 ns
	Overshoot	<5%
	Duty	Square: always be 50% Pulse: 2% to 98%, adjustable
	Duty Cycle Resolution	0.5% or 5 ns (whichever is greater)
	Min. Pulse Width	20 ns
	Pulse Width Resolution	5 ns
	Jitter	5 ns
Ramp	Frequency Range	100 mHz to 100 kHz
	Linearity	1%
	Symmetry	1% to 100%
Noise	Bandwidth	>25 MHz
Built-in Waveform	Frequency Range	100 mHz to 1 MHz
	Frequency Range	100 mHz to 10 MHz
Arbitrary Waveform	Waveform Length	2~16 kpts
	support loading channel waveforms and stored waveforms	
Frequency	Accuracy	100 ppm (<10 kHz), 50 ppm (>10 kHz)
	Resolution	100 mHz or 4 bits (whichever is greater)
Amplitude	Output Range	20 mVpp~5 Vpp (HighZ), 10 mVpp~2.5 Vpp (50 $\Omega$ )
	Resolution	100 $\mu$ V or 3 bits (whichever is greater)
	Accuracy	$\pm$ (2% of setting+1 mV) (Frequency=1 kHz)
DC Offset	Range	$\pm$ 2.5 V (HighZ), $\pm$ 1.25 V (50 $\Omega$ )
	Resolution	100 $\mu$ V or 3 bits (whichever is greater)
	Accuracy	$\pm$ (2% of offset setting+5 mV+0.5% of amplitude)

Modulation	AM, FM, FSK	
	AM	Modulating Waveforms: Sine, Square, Triangle, and Noise.
		Modulation Frequency: 1 Hz to 50 kHz
	FM	Modulation Depth: 0% to 120%
		Modulating Waveforms: Sine, Square, Triangle, and Noise.
		Modulation Frequency: 1 Hz to 50 kHz
FSK	Modulation Offset: 100 mHz to carrier frequency	
	Modulating Waveforms: 50% duty cycle square	
	Modulation Frequency: 1 Hz to 50 kHz	
Hopping Frequency: 100 mHz ~max. carrier frequency		
Sweep	Linear, Log, and Step	
	Sweep Time	1 ms to 500 s
	Start Frequency and End Frequency	any frequencies within the waveform range
Burst	N Cycle, Infinite	
	Cycle Count	1 to 1000000
	Burst Period	1 us to 500 s
	Burst Delay	0 s to 500 s
	Trigger Source	Internal, Manual

## Digital Voltmeter

Digital Voltmeter (technical specifications are typical values)	
Source	Any Analog Channel
Function	DC, AC+DC <sub>RMS</sub> , and AC <sub>RMS</sub>
Resolution	ACV/DCV: 3 bits
Limits Beeper	Sound an alarm when the voltage value is within or outside of the limit range.
Range Measurement	Display the latest measurement results in the form of a diagram, and display the extrema over the last 3 seconds

## High-precision Frequency Counter

High-precision Frequency Counter		
Source	Any analog channel and EXT	
Measure	Frequency, period, totalizer	
Counter	Resolution	Max. 6 bits, user-defined
	Max. Frequency	Max. analog bandwidth or 1.2 GHz (whichever is less)
Totalizer		48-bit totalizer
	Edge	Counts the number of the rising edges
Time Reference	Internal Reference	

## Command Set

Command Set	
Common Commands Support	IEEE488.2 Standard
Error Message Definition	Error messages
Support Status Report Mechanism	Status reporting
Support Syn Mechanism	Synchronization
Communication Mode	Socket and NI-VISA drive

## I/O

I/O	
USB 2.0 Hi-speed Host Port	4 (2 on the front panel and 2 on the rear panel)

USB 2.0 Hi-speed Device Port	1 on the rear panel, compatible with USB Test and Measurement Class (USBTMC)	
LAN	1 on the rear panel, 10/100/1000-port, supporting LXI-C	
GPIB	GPIB-USB adapter (option)	
SFP+ interface	1 on the rear panel, 10 Gbps	
Web Remote Control	Support Web Control interface (input the IP address of the oscilloscope into the Web browser to display the operation interface of the oscilloscope)	
Aux Out	BNC output on the rear panel. Vo (H) $\geq 2.5$ V open circuit, $\geq 1.0$ V 50 $\Omega$ to GND Vo (L) $\leq 0.7$ V to load $\leq 4$ mA; $\leq 0.25$ V 50 $\Omega$ to GND	
	TrigOut	Output a pulse signal when the oscilloscope is triggered.
	Pass/Fail	Output a pulse signal when a pass/fail event occurs. Support user-defined pulse polarity and pulse time (100 ns~10 ms).
	Rise Time	$\leq 1$ ns
10 M In/Out	Input Interface	1, SMA connector on the rear panel
	Output Interface	1, SMA connector on the rear panel
	Input Mode	50 $\Omega$ , with the amplitude 130 mVpp to 4.1 Vpp (-10 dBm, 20 dBm), the input accuracy 10 MHz $\pm 10$ ppm
	Output Mode	50 $\Omega$ , 1.5 Vpp sine waveform
HDMI Video Output	1 on the rear panel, HDMI 1.4b, A plug. used to connect to an external monitor or projector	
Probe Compensation Output	1 kHz, 3 Vpp square waveform	

## Power

Power Supply	
Power Voltage	100 V-240 V, 45 Hz-440 Hz
Power	Max. 200 W (connect to various interfaces, USB, active probes)
Fuse	3.15 A, T degree, 250 V

## Environment

Environmental Stress		
Temperature Range	Operating	-40°C ~+50°C
	Non-operating	-50°C ~+70°C
Humidity Range	Operating	below +30°C : $\leq 90\%$ RH (without condensation)
		+30°C to +40°C , $\leq 75\%$ RH (without condensation)
	Non-operating	+40°C to +50°C , $\leq 45\%$ RH (without condensation)
		below 65°C : $\leq 90\%$ RH (without condensation)
Altitude	Operating	below 3,000 m
	Non-operating	below 15,000 m

## Warranty and Calibration Interval

Warranty and Calibration Interval	
Warranty	Three years for the mainframe, excluding the probes and accessories.
Recommended Calibration Interval	18 months

## Regulations

Regulations		
Electromagnetic Compatibility	Compliant with EMC DIRECTIVE 2014/30/EU, compliant with or higher than the standards specified in IEC 61326-1:2013/EN 61326-1:2013 Group 1 Class A	
	CISPR 11/EN 55011	
	IEC 61000-4-2:2008/EN 61000-4-2	±4.0 kV (contact discharge), ±8.0 kV (air discharge)
	IEC 61000-4-3:2002/EN 61000-4-3	3 V/m (80 MHz to 1 GHz); 3 V/m (1.4 GHz to 2 GHz); 1 V/m (2.0 GHz to 2.7 GHz)
	IEC 61000-4-4:2004/EN 61000-4-4	1 kV power line
	IEC 61000-4-5:2001/EN 61000-4-5	0.5 kV (phase-to-neutral voltage); 1 kV (phase-to-earth voltage); 1 kV (neutral-to-earth voltage)
	IEC 61000-4-6:2003/EN 61000-4-6	3 V, 0.15-80 MHz
	IEC 61000-4-11:2004/EN 61000-4-11	voltage dip: 0% UT during half cycle; 0% UT during 1 cycle; 70% UT during 25 cycles short interruption: 0% UT during 250 cycles
Safety	IEC 61010-1:2010 (Third Edition)/EN 61010-1:2010, UL 61010-1:2012 R4.16 and CAN/CSA-C22.2 NO. 61010-1-12+ G11+ G12	
Vibration	Meets GB/T 6587; class 2 random Meets MIL-PRF-28800F and IEC60068-2-6; class 3 random	
Shock	Meets GB/T 6587-2012; class 2 random Meets MIL-PRF-28800F and IEC60068-2-27; class 3 random (in non-operating conditions: 30 g, half sine, 11 ms duration, 3 shocks along the main axis, a total of 18 vibrations)	

## Mechanical Characteristics

Mechanical Characteristics		
Dimensions	without handles and hanging ears	214 mm (W) × 43 mm (H) × 478 mm (D)
	with handles and hanging ears	268 mm (W) × 43 mm (H) × 499 mm (D)
Weight <sup>[6]</sup>	Package Excluded	<3.6 kg
	Package Included	<7.1 kg
Rack Mount Kit		1U

## Non-volatile Memory

Non-volatile Memory		
Data/File Storage	Setup/Image	setup (*.stp), image (*.png, *.bmp, *.tif, *.jpg)
	Waveform Data	CSV waveform data (*.csv), binary waveform data (*.bin, *.wfm), list data (*.csv), reference waveform data (*.ref, *.csv, *.bin), and arbitrary waveform data (*.arb)
Reference Waveform		Displays 10 internal waveforms, and its storage is limited by the capacity
Setting		storage is limited by the capacity
USB Capacity		Supports the USB storage device that conforms to the industry standard

Note<sup>[1]</sup>: 2 GHz bandwidth is only applicable to single-channel or half-channel mode.

Note<sup>[2]</sup>: Half-channel mode: CH1 and CH2 are considered as a group; CH3 and CH4 are considered as another group. Each group share the sample rate of 5 GSa/s, and either one of the channels in each group is enabled.

Note<sup>[3]</sup>: Maximum value. DS8104-R/DS8204-R: single-channel, memory depth Auto, 10 ns horizontal time base, input amplitude 4 div, sine wave signal with 10 MHz frequency. Others are default settings.

For DS8034-R: single-channel, memory depth Auto, 20 ns/div horizontal time base, input amplitude 4 div, sine wave signal with 10 MHz frequency. Others are default settings.

Note<sup>[4]</sup>: 1 mV/div and 2 mV/div are a magnification of 4 mV/div setting. For vertical accuracy calculations, use full scale of 32 mV for 1 mV/div and 2 mV/div sensitivity setting.

Note<sup>[5]</sup>: Unavailable for DS8034-R.

Note<sup>[6]</sup>: DS8000-R model, standard configuration.

# Order Information

Order Information	Order No.
<b>Model</b>	
DS8204-R (2 GHz, 10 GSa/s, 500 Mpts, 4CH compact digital oscilloscope)	DS8204-R
DS8104-R (1 GHz, 10 GSa/s, 500 Mpts, 4CH compact digital oscilloscope)	DS8104-R
DS8034-R (350 MHz, 5 GSa/s, 500 Mpts, 4CH compact digital oscilloscope)	DS8034-R
<b>Standard Accessories</b>	
USB cable	CB-USBA-USBB-FF-150
Power cord conforming to the standard of the destination country	—
Rack mount kit	RM1011 & RM1012
<b>Recommended Accessories</b>	
Passive high-impedance probe (500 MHz BW)	RP3500A
Passive high-impedance probe (350 MHz BW)	PVP2350
Passive low-impedance probe (1.5 GHz BW)	RP6150A
Active single-ended/differential probe (2.5 GHz BW)	PVA7250
Active differential probe (1.5 GHz BW)	RP7150
Active differential probe (800 MHz BW)	RP7080
Active single-ended probe (1.5 GHz BW)	RP7150S
Active single-ended probe (800 MHz BW)	RP7080S
50 $\Omega$ impedance matching device (2W, 1 GHz)	ADP0150BNC
Power analysis phase difference correction jig	RPA246
64CH synchronization module	DS SYNC64
2-way power splitter (DC to 4 GHz)	PRSC42
<b>10 GE Communication Option</b>	
High-speed data communication option	DS8000-R HSDC
<b>Software Tool</b>	
Software development kit (open source, available to download from RIGOL official website)	—
<b>Bundle Option</b>	
Function and application bundle option, including DS8000-R-COMP, DS8000-R-EMBD, DS8000-R-AUTO, DS8000-R-FLEX, DS8000-R-AUDIO, DS8000-R-AERO, DS8000-R-AWG, DS8000-R-JITTER and DS8000-R-PWR	DS8000-R-BND
<b>Serial Protocol Analysis Option</b>	
PC serial bus trigger and analysis (RS232/UART)	DS8000-R-COMP
Embedded serial bus trigger and analysis (I2C, SPI)	DS8000-R-EMBD
Auto serial bus trigger and analysis (CAN, LIN)	DS8000-R-AUTO
FlexRay serial bus trigger and analysis (FlexRay)	DS8000-R-FLEX
Audio serial bus trigger and analysis (I2S)	DS8000-R-AUDIO
MIL-STD-1553 serial bus trigger and analysis (MIL-STD-1553)	DS8000-R-AERO
<b>Measurement Application Option</b>	
25 MHz arbitrary waveform generator	DS8000-R-AWG
Built-in power analysis (required to purchase the RPA246 phase deviation correction jig)	DS8000-R-PWR
Real-time eye diagram and jitter analysis (option, only available for DS8104-R and DS8204-R)	DS8000-R-JITTER

Note: For all the mainframes, accessories and options, please contact the local office of RIGOL.

## Warranty Period

Three years for the mainframe, excluding the probes and accessories.

# Option Ordering and Installation Process

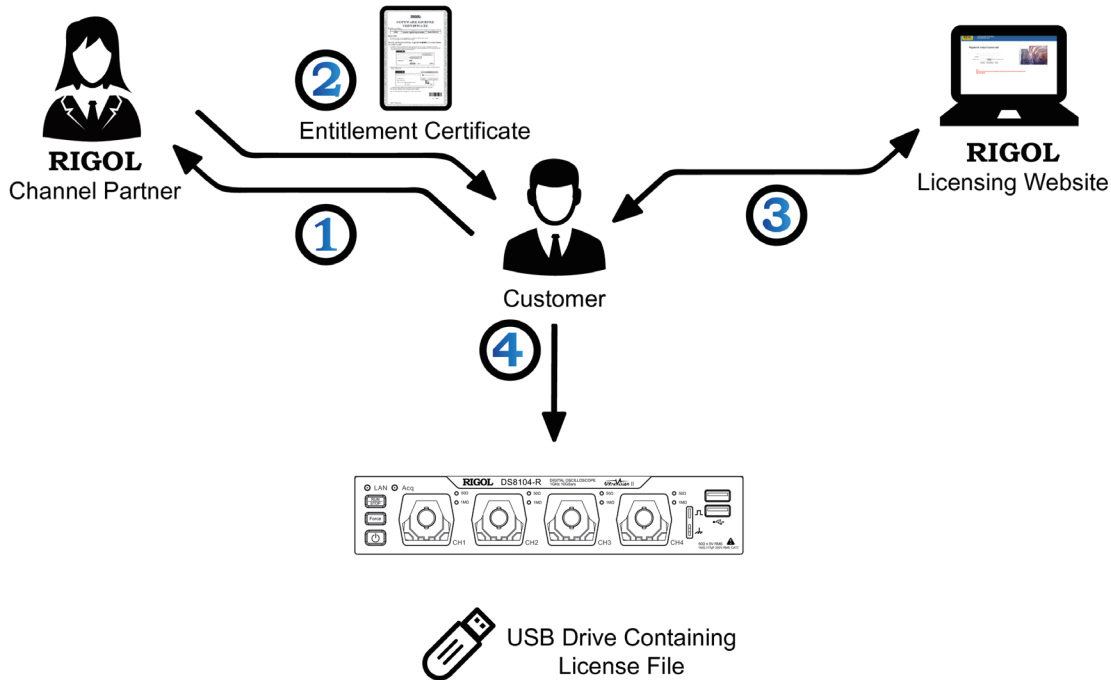

1. Any requirement on the software options, please purchase from our local **RIGOL** Channel Partner, and provide the serial number of the oscilloscope that needs to be installed.
2. After receiving the option order, the **RIGOL** factory will send an e-mail to the address provided in the order, with the software product entitlement certificate as the attachment.
3. Log in **RIGOL** official website ([www.rigol.com](http://www.rigol.com)) for registration. Use the software key and oscilloscope serial number provided in the entitlement certificate to obtain the option license code and the option license file.
4. Download the option license file to the root directory of the USB storage device, and connect the USB storage device to the oscilloscope properly. After the USB storage device is successfully recognized, the **Option install** key is activated. Press this menu key to start installing the option.

## HEADQUARTER

**RIGOL TECHNOLOGIES CO., LTD.**  
No.8 Keling Road, New District, Suzhou,  
JiangSu, P.R.China  
Tel: +86-400620002  
Email: [info@rigol.com](mailto:info@rigol.com)

## EUROPE

**RIGOL TECHNOLOGIES EU GmbH**  
Lindbergh str. 4  
82178 Puchheim  
Germany  
Tel: +49-89/89418950  
Email: [info-europe@rigol.com](mailto:info-europe@rigol.com)

## NORTH AMERICA

**RIGOL TECHNOLOGIES, USA INC.**  
8140 SW Nimbus Ave.  
Beaverton, OR 97008  
Tel: +1-877-4-**RIGOL**-1  
Fax: +1-877-4-**RIGOL**-1  
Email: [info@rigol.com](mailto:info@rigol.com)

## JAPAN

**RIGOL TECHNOLOGIES JAPAN, LLC**  
MJ Bldg. 3F, 1-7-4 Minato, Chuou-ku,  
Tokyo, Japan 104-0043  
Tel: +81-3-6262-8932  
Fax: +81-3-6262-8933  
Email: [info-japan@rigol.com](mailto:info-japan@rigol.com)

**RIGOL**® is the trademark of **RIGOL TECHNOLOGIES CO., LTD.** Product information in this document subject to update without notice. For the latest information about **RIGOL**'s products, applications and services, please contact local **RIGOL** Channel Partners or access **RIGOL** official website: [www.rigol.com](http://www.rigol.com)