

# **RIGOL**

## **User Guide**

# **RSA5000 Series Real-time Spectrum Analyzer**

**Sept. 30, 2018**  
**RIGOL TECHNOLOGIES CO., LTD.**



---

# Guaranty and Declaration

## Copyright

© 2020 **RIGOL** TECHNOLOGIES CO., LTD. All Rights Reserved.

## Trademark Information

**RIGOL**® is the trademark of **RIGOL** TECHNOLOGIES CO., LTD.

## Publication Number

UGD20102-1110

## Software Version

00.01.00

Software upgrade might change or add product features. Please acquire the latest version of the manual from **RIGOL** website or contact **RIGOL** to upgrade the software.

## Notices

- **RIGOL** products are covered by P.R.C. and foreign patents, issued and pending.
- **RIGOL** reserves the right to modify or change parts of or all the specifications and pricing policies at the company's sole decision.
- Information in this publication replaces all previously released materials.
- Information in this publication is subject to change without notice.
- **RIGOL** shall not be liable for either incidental or consequential losses in connection with the furnishing, use, or performance of this manual, as well as any information contained.
- Any part of this document is forbidden to be copied, photocopied, or rearranged without prior written approval of **RIGOL**.

## Product Certification

**RIGOL** guarantees that this product conforms to the national and industrial standards in China as well as the ISO9001:2015 standard and the ISO14001:2015 standard. Other international standard conformance certifications are in progress.

## Contact Us

If you have any problem or requirement when using our products or this manual, please contact **RIGOL**.

E-mail: [service@rigol.com](mailto:service@rigol.com)

Website: [www.rigol.com](http://www.rigol.com)

# Safety Requirement

## General Safety Summary

Please review the following safety precautions carefully before putting the instrument into operation so as to avoid any personal injury or damage to the instrument and any product connected to it. To prevent potential hazards, please follow the instructions specified in this manual to use the instrument properly.

### **Use Proper Power Cord.**

Only the exclusive power cord designed for the instrument and authorized for use within the local country could be used.

### **Ground the Instrument.**

The instrument is grounded through the Protective Earth lead of the power cord. To avoid electric shock, connect the earth terminal of the power cord to the Protective Earth terminal before connecting any input or output terminals.

### **Connect the Probe Correctly.**

If a probe is used, the probe ground lead must be connected to earth ground. Do not connect the ground lead to high voltage. Improper way of connection could result in dangerous voltages being present on the connectors, controls or other surfaces of the oscilloscope and probes, which will cause potential hazards for operators.

### **Observe All Terminal Ratings.**

To avoid fire or shock hazard, observe all ratings and markers on the instrument and check your manual for more information about ratings before connecting the instrument.

### **Use Proper Overvoltage Protection.**

Ensure that no overvoltage (such as that caused by a bolt of lightning) can reach the product. Otherwise, the operator might be exposed to the danger of an electric shock.

### **Do Not Operate Without Covers.**

Do not operate the instrument with covers or panels removed.

### **Do Not Insert Objects into the Air Outlet.**

Do not insert objects into the air outlet, as doing so may cause damage to the instrument.

### **Use Proper Fuse.**

Please use the specified fuses.

**Avoid Circuit or Wire Exposure.**

Do not touch exposed junctions and components when the unit is powered on.

**Do Not Operate with Suspected Failures.**

If you suspect that any damage may occur to the instrument, have it inspected by **RIGOL** authorized personnel before further operations. Any maintenance, adjustment or replacement especially to circuits or accessories must be performed by **RIGOL** authorized personnel.

**Provide Adequate Ventilation.**

Inadequate ventilation may cause an increase of temperature in the instrument, which would cause damage to the instrument. So please keep the instrument well ventilated and inspect the air outlet and the fan regularly.

**Do Not Operate in Wet Conditions.**

To avoid short circuit inside the instrument or electric shock, never operate the instrument in a humid environment.

**Do Not Operate in an Explosive Atmosphere.**

To avoid personal injuries or damage to the instrument, never operate the instrument in an explosive atmosphere.

**Keep Product Surfaces Clean and Dry.**

To avoid dust or moisture from affecting the performance of the instrument, keep the surfaces of the instrument clean and dry.

**Prevent Electrostatic Impact.**

Operate the instrument in an electrostatic discharge protective environment to avoid damage induced by static discharges. Always ground both the internal and external conductors of cables to release static before making connections.

**Use the Battery Properly.**

Do not expose the battery (if available) to high temperature or fire. Keep it out of the reach of children. Improper change of a battery (lithium battery) may cause an explosion. Use the **RIGOL** specified battery only.

**Handle with Caution.**

Please handle with care during transportation to avoid damage to keys, knobs, interfaces, and other parts on the panels.

## Safety Notices and Symbols

### Safety Notices in this Manual:

**WARNING**

Indicates a potentially hazardous situation or practice which, if not avoided, will result in serious injury or death.

**CAUTION**

Indicates a potentially hazardous situation or practice which, if not avoided, could result in damage to the product or loss of important data.

### Safety Terms on the Product:

**DANGER** It calls attention to an operation, if not correctly performed, could result in injury or hazard immediately.

**WARNING** It calls attention to an operation, if not correctly performed, could result in potential injury or hazard.

**CAUTION** It calls attention to an operation, if not correctly performed, could result in damage to the product or other devices connected to the product.

### Safety Symbols on the Product:



Hazardous  
Voltage



Safety Warning



Protective Earth  
Terminal



Chassis Ground



Test Ground

---

## Care and Cleaning

### Care

Do not store or leave the instrument where it may be exposed to direct sunlight for long periods of time.

### Cleaning

Clean the instrument regularly according to its operating conditions.

1. Disconnect the instrument from all power sources.
2. Clean the external surfaces of the instrument with a soft cloth dampened with mild detergent or water. When cleaning the LCD, take care to avoid scarifying it.



#### CAUTION

To avoid damage to the instrument, do not expose it to caustic liquids.

---



#### WARNING

To avoid short-circuit resulting from moisture or personal injuries, ensure that the instrument is completely dry before connecting it to the power supply.

---

## Environmental Considerations

The following symbol indicates that this product complies with the WEEE Directive 2002/96/EC.



### Product End-of-Life Handling

The equipment may contain substances that could be harmful to the environment or human health. To avoid the release of such substances into the environment and avoid harm to human health, we recommend you to recycle this product appropriately to ensure that most materials are reused or recycled properly. Please contact your local authorities for disposal or recycling information.

## RSA5000 Series Overview

RSA5000 series is a new generation of cost-efficient real-time spectrum analyzer with high performance. With superb performance specifications and the clear user interface, the RSA5000 series allows you to operate it through various ways, such as pressing keys on the front panel, using the touch screen, connecting the mouse and the keyboard. Remote communication interfaces are also available. The instrument can be widely used in education science, corporate R&D, industrial production, and other fields.

### Main Features:

- Ultra-Real technology
- Frequency: up to 6.5 GHz
- Displayed average noise level (DANL): <-165 dBm (typical)
- Phase noise: <-108 dBc/Hz (typical)
- Level measurement uncertainty: <0.8 dB
- 6.5 GHz tracking generator
- Min. RBW 1 Hz
- EMC filter and quasi-peak detector
- Various measurement functions
- Multiple measurement modes
- Up to 40 MHz real-time analysis bandwidth
- Multiple trigger modes and trigger masks
- Density, Spectrogram, and other display modes
- PC software options
- 10.1" capacitive multi-touch screen, supporting touch gestures
- USB, LAN, HDMI and other communication and display interfaces



---

# Document Overview

**Topics in this manual:****Chapter 1 Quick Start**

This chapter introduces the front/rear panel and user interface as well as announcements during first use of the analyzer.

**Chapter 2 Functions of the Front Panel of GPSA**

This chapter gives detailed function descriptions of the GPSA's front panel keys and the associated menu keys.

**Chapter 3 Functions of the Front Panel of RTSA**

This chapter gives detailed function descriptions of the RTSA's front panel keys.

**Chapter 4 Input/Output**

This chapter introduces the parameter settings for the input/output interface.

**Chapter 5 Shortcut Key**

This chapter introduces the functions of the shortcut keys on the front panel.

**Chapter 6 System Function**

This chapter introduces the system function settings.

**Chapter 7 Remote Control**

This chapter shows how to control the analyzer in remote mode.

**Chapter 8 Troubleshooting**

This chapter lists the troubleshooting information and messages that may appear during the use of the analyzer.

**Chapter 9 Appendix**

This chapter lists the options and accessories that can be ordered along with your analyzer as well as the service and support information.

**Format Conventions in this Manual:****1. Keys:**

The keys on the front panel are usually denoted by the format of "Key Name (Bold) + Text Box". For example, **FREQ** denotes the **FREQ** key.

**2. Menu Keys:**

The menu softkeys are usually denoted by the format of "Menu Word (Bold) + Character Shading". For example, **Center Freq** denotes the center frequency menu item under the **FREQ** function key.

**3. Connectors:**

The connectors on the front or rear panel are usually denoted by the format of "Connector Name (Bold) + Square Brackets (Bold)". For example, **[Gen Output 50Ω]**.

**4. Operation Procedures:**

"→" represents the next step of operation. For example, **FREQ** → **Center Freq** indicates pressing **FREQ** on the front panel and then pressing the menu softkey **Center Freq**.

**Content Conventions in this Manual:**

The RSA5000 series spectrum analyzer includes the following models. This manual takes RSA5065-TG as an example.

<b>Model</b>	<b>Frequency Range</b>	<b>Tracking Generator</b>
RSA5065	9 kHz to 6.5 GHz	None
RSA5032	9 kHz to 3.2 GHz	None
RSA5065-TG	9 kHz to 6.5 GHz	6.5 GHz
RSA5032-TG	9 kHz to 3.2 GHz	3.2 GHz
RSA5065N	9 kHz to 6.5 GHz	6.5 GHz
RSA5032N	9 kHz to 3.2 GHz	3.2 GHz

**User Manuals of this Product:**

Quick Guide, User Guide, Programming Guide, Data sheet, etc. For the desired manual, please download it from [www.rigol.com](http://www.rigol.com).

# Contents

<b>Guaranty and Declaration .....</b>	<b>I</b>
<b>Safety Requirement .....</b>	<b>II</b>
General Safety Summary .....	II
Safety Notices and Symbols.....	IV
Care and Cleaning .....	V
Environmental Considerations.....	V
<b>RSA5000 Series Overview.....</b>	<b>VI</b>
<b>Document Overview.....</b>	<b>VII</b>
<b>Chapter 1 Quick Start.....</b>	<b>1-1</b>
General Inspection .....	1-2
Appearance and Dimensions.....	1-3
To Prepare for Use.....	1-4
To Adjust the Supporting Legs.....	1-4
To Connect to AC Power .....	1-5
Turn-on Checkout .....	1-5
Self-calibration.....	1-5
To Set the System Language.....	1-6
Front Panel .....	1-7
Function Keys on the Front Panel .....	1-8
Utility Function Keys on the Front Panel .....	1-10
Front Panel Key Backlight .....	1-11
Front Panel Connector .....	1-12
To Use the Numeric Keypad .....	1-14
Rear Panel .....	1-16
User Interface.....	1-18
Mouse/Keyboard/Touch Screen Operation Rule.....	1-20
Mouse Operation Rule .....	1-20
Keyboard Operation Rule .....	1-21
Touch Screen Operation Rule .....	1-22
Menu Operation .....	1-23
Parameter Setting.....	1-25
To Use the Built-in Help System .....	1-27
Fuse Replacement .....	1-28
Mode Setting .....	1-29
Mode .....	1-29
Mode Setup.....	1-30
<b>Chapter 2 Functions of the Front Panel of GPSA.....</b>	<b>2-1</b>
Basic Settings .....	2-2
FREQ.....	2-2
SPAN .....	2-8

AMPT .....	2-9
Sweep and Function Settings.....	2-14
BW.....	2-14
Sweep .....	2-18
Trigger .....	2-22
Trace.....	2-26
Tracking Generator (Option) .....	2-32
Measurement Settings .....	2-35
Meas .....	2-35
Meas Setup.....	2-38
Marker Measurement.....	2-66
Marker.....	2-66
Marker To .....	2-73
Marker Function .....	2-75
Peak.....	2-79
<b>Chapter 3 Functions of the Front Panel of RTSA.....</b>	<b>3-1</b>
Basic Settings .....	3-2
FREQ.....	3-2
SPAN.....	3-2
AMPT .....	3-5
Sweep and Function Settings.....	3-6
BW.....	3-6
Sweep .....	3-8
Trigger .....	3-10
Trace.....	3-15
Measurement Settings .....	3-17
Meas .....	3-17
Meas Setup.....	3-25
Marker Setup.....	3-32
Marker.....	3-32
Marker To .....	3-32
Marker Function .....	3-32
Peak.....	3-32
<b>Chapter 4 Input/Output.....</b>	<b>4-1</b>
<b>Chapter 5 Shortcut Key .....</b>	<b>5-1</b>
Auto Tune.....	5-1
Preset.....	5-3
User .....	5-9
Quick Save.....	5-9
Cont.....	5-9
Single.....	5-9
<b>Chapter 6 System Function .....</b>	<b>6-1</b>
System .....	6-1
File.....	6-9

---

Recall .....	6-13
Save.....	6-15
<b>Chapter 7 Remote Control .....</b>	<b>7-1</b>
Remote Control Overview.....	7-2
Remote Control via USB.....	7-3
Remote Control via LAN .....	7-4
<b>Chapter 8 Troubleshooting .....</b>	<b>8-1</b>
<b>Chapter 9 Appendix .....</b>	<b>9-1</b>
Appendix A: RSA5000 Accessories and Option List.....	9-1
Appendix B: Warranty .....	9-3
<b>Index .....</b>	<b>1</b>



# Chapter 1 Quick Start

This chapter gives you a quick review about the appearance and dimensions of the RSA5000 series, its front and rear panel, user interface, as well as announcements during first use of the analyzer.

Contents in this chapter:

- General Inspection
- Appearance and Dimensions
- To Prepare for Use
- Front Panel
- Rear Panel
- User Interface
- Mouse/Keyboard/Touch Screen Operation Rule
- Menu Operation
- Parameter Setting
- To Use the Built-in Help System
- Fuse Replacement
- Mode Setting

## General Inspection

### 1. Inspect the packaging

If the packaging has been damaged, do not dispose the damaged packaging or cushioning materials until the shipment has been checked for completeness and has passed both electrical and mechanical tests.

The consigner or carrier shall be liable for the damage to the instrument resulting from shipment. **RIGOL** would not be responsible for free maintenance/rework or replacement of the instrument.

### 2. Inspect the instrument

In case of any mechanical damage, missing parts, or failure in passing the electrical and mechanical tests, contact your **RIGOL** sales representative.

### 3. Check the accessories

Please check the accessories according to the packing lists. If the accessories are damaged or incomplete, please contact your **RIGOL** sales representative.



# Appearance and Dimensions

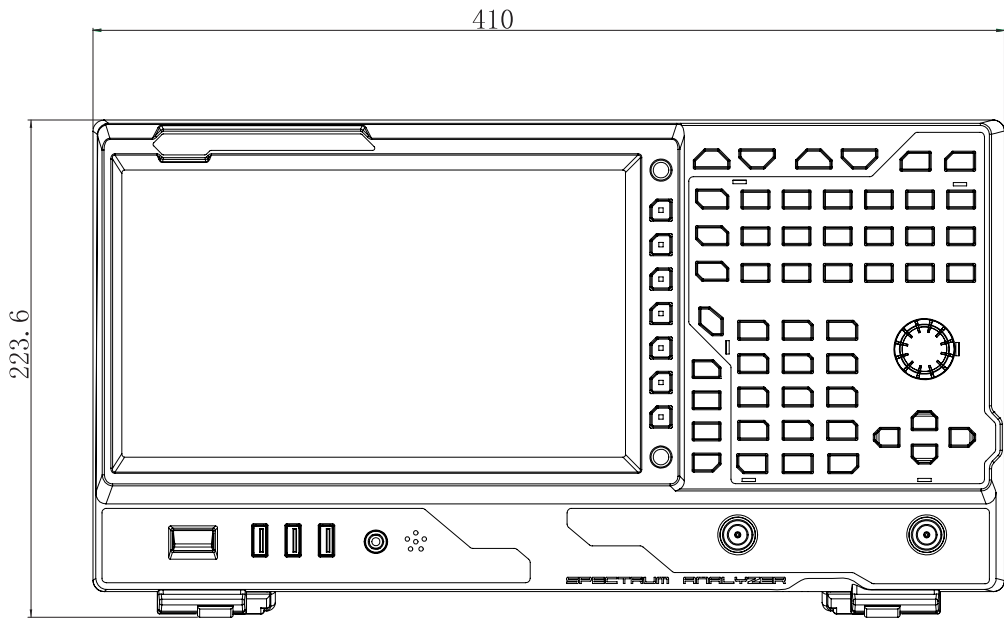

Figure 1-1 Front View

Unit: mm

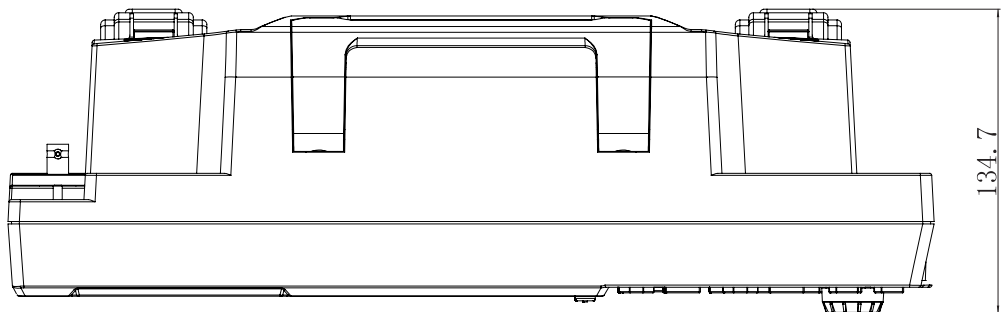

Figure 1-2 Vertical View

Unit: mm

## To Prepare for Use

### To Adjust the Supporting Legs

You can unfold the supporting legs to use them as stands to tilt the instrument upwards for easier operation and observation. You can also fold the supporting legs for easier storage or shipment when the instrument is not in use.

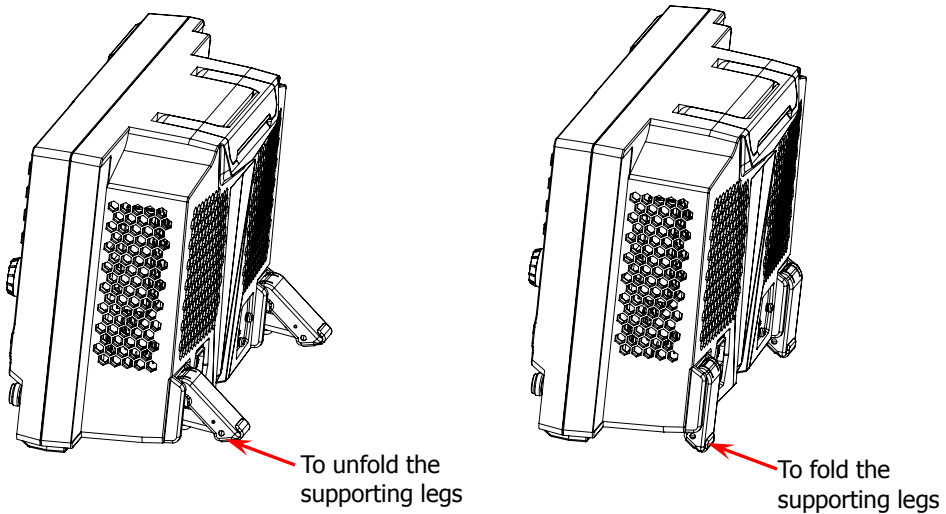
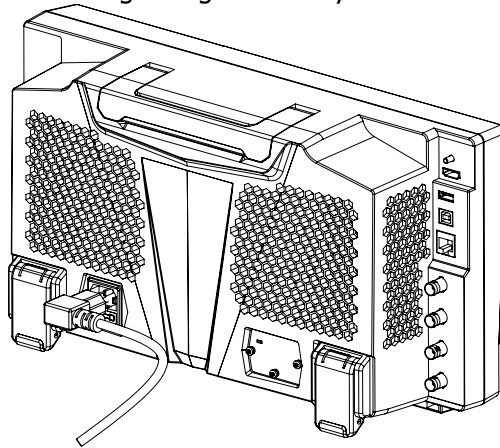

Figure 1-3 To Adjust the Supporting Legs

## To Connect to AC Power

Please use the power cord provided in the accessories to connect the spectrum analyzer to the AC power source. The AC power supply specification of this spectrum analyzer is 100-240 V, 45-440 Hz. The power consumption of the instrument cannot exceed 95 W. When the spectrum analyzer is connected to the AC power source via the power cord, the instrument automatically adapts to the voltage range, and you do not need to select the voltage range manually.



### CAUTION

To avoid electric shock, ensure that the instrument is correctly grounded.

## Turn-on Checkout

After connecting the instrument to the power source properly, press the Power key  on the front panel to start the spectrum analyzer. Then, you will see an initial splash screen. Following the start-up screen which shows the start-up initialization process information, the sweep curve is displayed.

## Self-calibration

After the instrument starts, execute self-calibration.

Press **System** → **Alignment** → **Align Now**, and then the instrument will perform self-calibration with the internal calibration source.

## To Set the System Language

RSA5000 series spectrum analyzer supports multiple system languages. You can press **System** → **Language** to switch the system language.

## Front Panel

The front panel of RSA5000 is shown in the following figure.

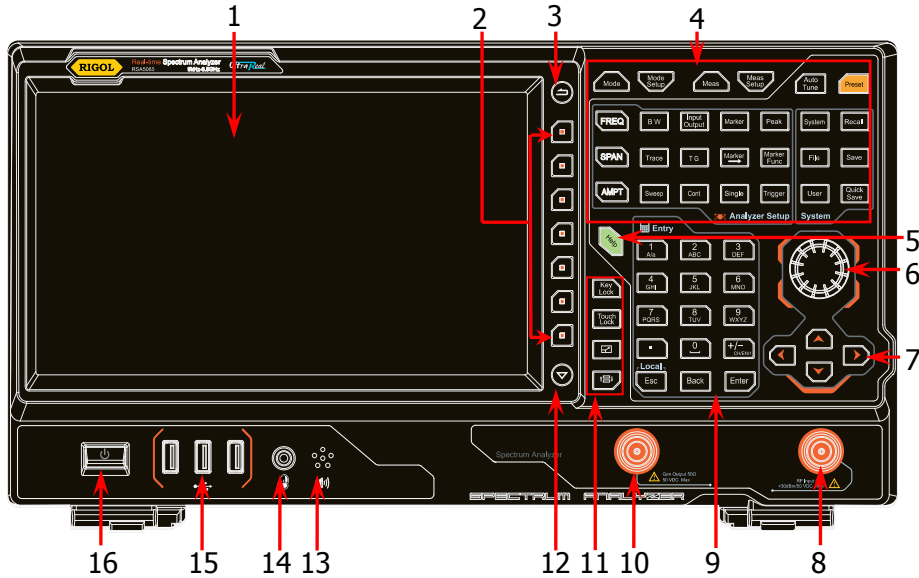

Figure 1-4 Front Panel

Table 1-1 Front Panel Description

No.	Description	No.	Description
1	LCD	9	Numeric keypad
2	Menu softkeys	10	Tracking generator output <sup>[1]</sup>
3	Back to previous menu item	11	Utility function key area
4	Function key area	12	Page up/down key
5	Help key	13	Speaker
6	Knob	14	Earphone jack
7	Arrow keys	15	USB HOST
8	RF input	16	Power key

**Note<sup>[1]</sup>:** This function is only available for RSA5065-TG/RSA5032-TG.

## Function Keys on the Front Panel

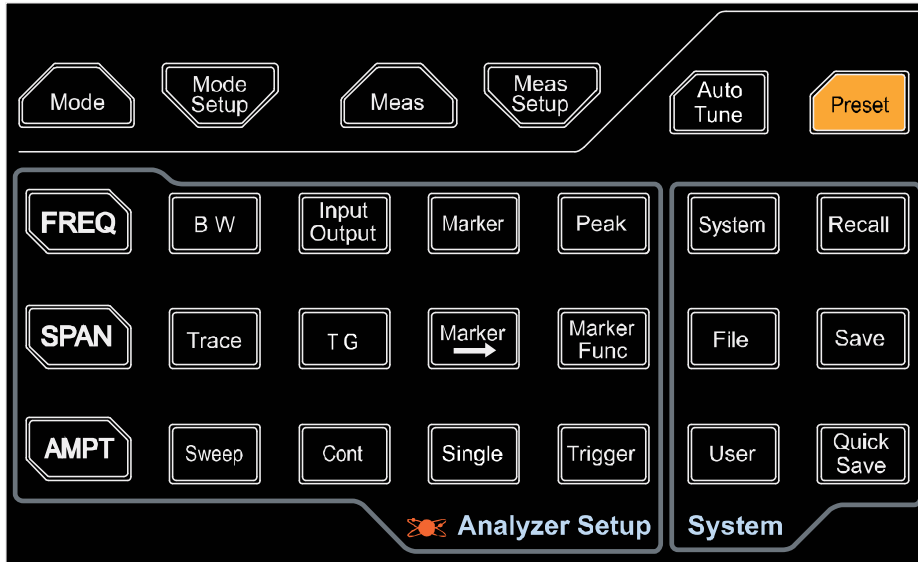



















Figure 1-5 Function Keys

Table 1-2 Descriptions of Function Keys on the Front Panel

Function Key	Description
	Sets the parameters such as center frequency, start frequency, and stop frequency; enables the signal tracking function.
	Sets the frequency span of the sweep.
	Sets the parameters such as reference level, RF attenuator, scale, and Y-axis unit. Enables preamp.
	Sets the parameters such as resolution bandwidth (RBW) and video bandwidth (VBW).
	Sets the parameters such as input impedance, external gain, and External Trigger 2. Selects the RF calibration signal.
	Reads the amplitude and frequency of a certain point on the trace via marker.
	Opens the peak search menu and searches for peaks immediately.
	Sets the parameters related to trace.
	Sets the parameters related to the tracking generator <sup>[1]</sup> .

	Sets other system parameters based on the current marker value.
	Indicates the special functions of the marker, such as noise marker, N dB bandwidth measurement, and frequency counter.
	Sets the sweep parameters.
	Sets the sweep/measurement mode to be continuous.
	Sets the sweep/measurement mode to be single.
	Sets the trigger source and its related parameters.
	Selects the working mode of the spectrum analyzer.
	Sets the parameters for the selected working mode.
	Selects and controls the measurement function <sup>[2]</sup> .
	Sets the parameters <sup>[2]</sup> for the selected measurement function.
	Searches for signals automatically within full frequency range.
	Restores the system to factory settings or user-defined state.
	Sets the system parameters.
	Recalls the files.
	Manages the files.
	Saves the files.
	User-defined shortcut key.
	Provides quick save function.

**Note<sup>[1]</sup>:** This function is only available for RSA5065-TG/RSA5032-TG.





**Note<sup>[2]</sup>:** This function is only available for the instrument installed with RSA5000-AMK.

**Tip:**

Click the function keypad icon  at the right corner of the LCD or finger-touch it, and then the function keypad that corresponds to the specified keys on the front panel appears. At this time, you can operate the instrument with the function keypad.

## Utility Function Keys on the Front Panel

Table 1-3 Descriptions of Utility Function Keys on the Front Panel

	Locks all the keys (except the Power key) on the front panel.
	Locks the touch screen of the instrument.
	In the multi-window display mode, press this key to select the specified window to zoom it in or out.
	In the multi-window display mode, press this key to switch the window.



## Front Panel Key Backlight

The on/off state and the color of the backlights of some keys on the front panel indicate the working state of the spectrum analyzer. The states are listed below.

### 1. Power Key

- Flash on and off alternatively, in breathing state: indicates that the unit is in stand-by state.
- Constant on: indicates that the instrument is in normal operating state.

### 2. Auto Tune

When you press the **Auto Tune** key, it is illuminated. The instrument starts sweeping within the full frequency range, searches for the signal with the maximum amplitude and moves it to the center of the screen. After the sweep is completed, the backlight turns off.

### 3. Tracking Generator (Option)

When the tracking generator function is enabled, the TG key is illuminated; when disabled, the backlight of the TG key is off.

### 4. Single

When the **Single** key is illuminated, it indicates that the sweep/measurement mode is single.

### 5. Keypad Locking Key

When the backlight is on, it indicates that all the keys (except the Power key) on the front panel is locked. Press the key again to unlock the front panel keys, and then the backlight of the key is off.

### 6. Touch Screen Locking Key

When the backlight is on, it indicates that the touch screen of the instrument is locked. Press the key again to unlock the touch screen, and then the backlight is off.

## Front Panel Connector

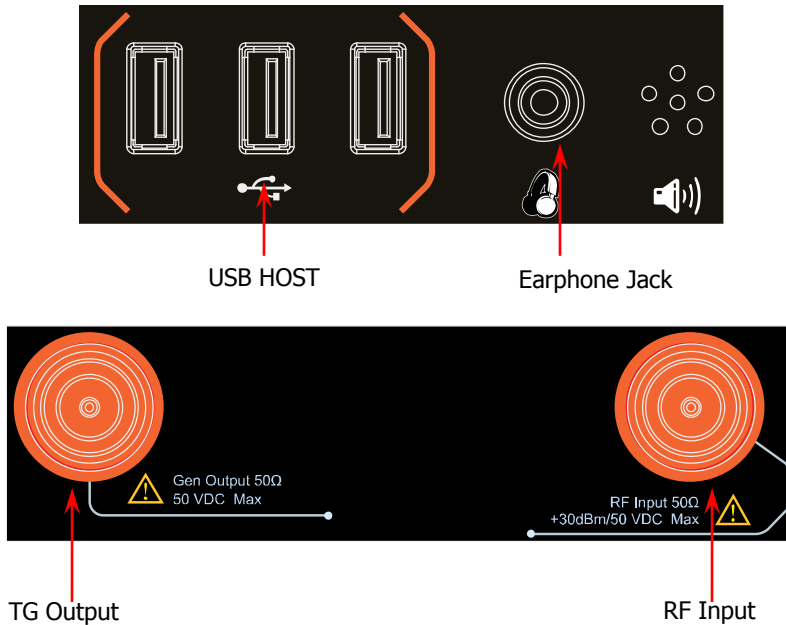

Figure 1-6 Front Panel Connector

### 1. USB HOST

The analyzer can serve as a "master" device to connect to the external USB device. The USB storage device, mouse, and keyboard can be connected to the instrument via the interface.

- **USB Storage Device**

Reads the state file, trace+state file, measurement data file, limit line file, and FMT file (in RTSA mode) from the USB storage device; or stores the current instrument state, trace, measurement data, limit line, or FMT to the USB storage device; or stores the contents currently displayed on the screen to the USB storage device in ".jpg", ".bmp", or ".png" format.

- **Mouse**

After the mouse is properly connected to the instrument, you can use it to click on the screen to perform parameter setting and function configuration. For details, refer to descriptions in "**Mouse/Keyboard/Touch Screen Operation Rule**".

- **Keyboard**

After the keyboard is properly connected to the instrument, you can use the shortcut keys on the keypad to perform the same function as what you do with the front panel keys. For details, refer to descriptions in "**Mouse/Keyboard/Touch Screen Operation Rule**".

## 2. Earphone Jack

Insert the earphone to the jack to acquire the audio output of the demodulated signal.



---

### CAUTION

To avoid damaging your hearing, please turn the volume down to zero first and then gradually turn the volume up after putting on the earphone.

---

## 3. Gen Output 50Ω

The output of the tracking generator can be connected to a receiver through a cable with an N male connector. This function is only available for RSA5065-TG/RSA5032-TG.



---

### CAUTION

To avoid damage to the tracking generator, the reverse power cannot exceed +10 dBm when the frequency is lower than 10 MHz; the reverse power cannot exceed +20 dBm when the frequency is greater than 10 MHz. The reverse DC voltage should not exceed 50 V.

---

## 4. RF Input 50Ω

The input terminal of the signal under test. **[RF Input 50Ω]** can be connected to the device under test (DUT) via a cable with an N male connector.



---

### CAUTION

For the signal input to the RF input terminal, ensure that the DC voltage component and the maximum continuous power of the AC (RF) signal component do not exceed 50 V and +30 dBm to avoid damaging the instrument.

---

## To Use the Numeric Keypad

The numeric keypad is available on the front panel of RSA5000, as shown in the figure below. The numeric keypad supports the Chinese characters, English uppercase/lowercase letters, numbers, and common symbols (including decimal point, space, and +/- signs), which are mainly used to edit the file/folder name and set parameters (refer to "**Parameter Setting**").





Figure 1-7 Numeric Keypad

The numeric keypad consists of the following parts:

### 1. Number/Letter

- Multiplexing keys for numbers and letters. They are used to directly input the desired number or letter.

- : press this key to input 1 in number input; to switch between uppercase and lowercase letter in English input. This key is invalid in Chinese input.

-  is the multiplexing key for 0 and space. Press this key to input 0 in number input and space in Chinese or English input.

### 2.

- Press this key to input a decimal point at the current cursor position in number input.
- This key is invalid in Chinese or English input.



- 3.
- The number input mode is, by default, selected for parameter setting. Press this key to input the symbol ("+" or "-"). When you press the key for the first time, the parameter symbol "-" is displayed, and when you press it again, "+" is displayed.
  - When you input a file or folder name, press this key repeatedly to switch among the Chinese input, English input, and number input.



- 4.
- When editing the parameter, press this key to exit parameter input.
  - When you edit the filename with the on-screen keyboard, press this key to hide the on-screen keyboard.
  - In multi-touch test, single-touch test, and keyboard test state, press this key to exit the current test state.
  - When the instrument is in remote mode, press this key to return to the local mode.



- 5.
- When editing the parameter, press this key to delete the character to the left of the cursor.
  - When editing the file name, press this key to delete the character to the left of the cursor.



- 6.
- During parameter editing, pressing this key will complete the input and insert a default unit for the parameter.

## Rear Panel

The rear panel of RSA5000 is shown in the following figure.

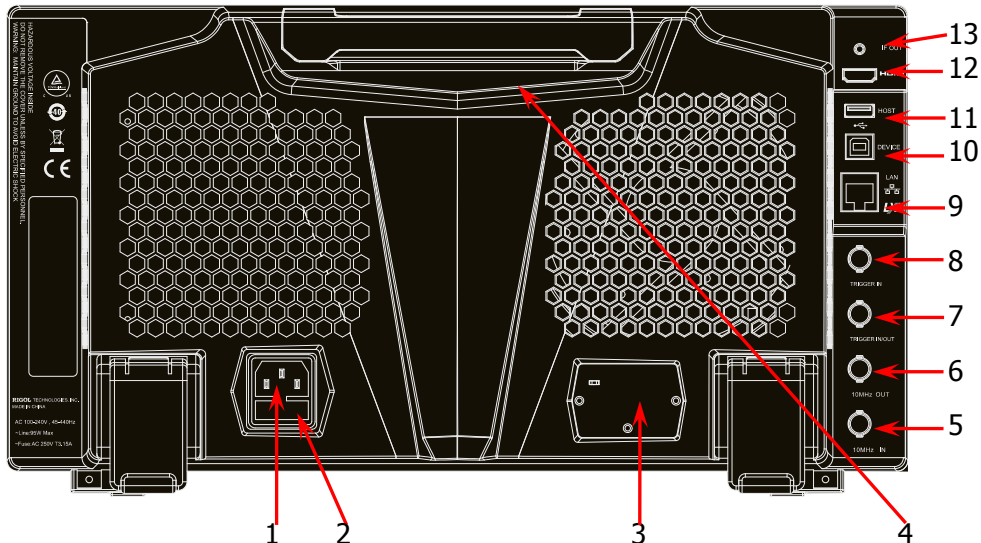

Figure 1-8 Rear Panel

### 1. AC Power Cord Connector

The AC power supply specification of RSA5000 is: 100-240 V; 45-440 Hz.

### 2. Fuse Holder

You can replace the fuse. The fuse rating supported by the instrument is AC 250 V, T3.15 A.

### 3. OCXO (Option)

OCXO (Oven Controlled Crystal Oscillator) can provide a highly stable frequency reference over temperature variations. For order information of the option, refer to the datasheet manual. **Note:** A 40-minute warm-up is required for OCXO to reach its nominal frequency.

### 4. Handle

You can rotate the handle upright and make the portable instrument easy to carry.

### 5. 10MHz IN

RSA5000 can use the internal or external reference source.

- When a 10 MHz external clock signal is received at the **[10 MHz IN]** connector, this signal is used as the external reference source. At this time, the status bar of the user interface displays "Ext". When the external

reference is lost, transfinite, or not connected, the instrument switches to the internal reference automatically. At this time, the icon "Ext" in the status bar of the user interface disappears.

- The **[10MHz IN]** and **[10MHz OUT]** connectors are usually used to realize synchronization among multiple instruments.

**Note:** When you input or disconnect an external clock signal for the first time, the network will be reconfigured.

## 6. 10MHz OUT

RSA5000 can use the internal or external reference source.

- When the internal reference source is used, the **[10MHz OUT]** connector can output a 10 MHz clock signal generated by the analyzer. This signal can be used to synchronize other instruments.
- The **[10MHz OUT]** and **[10MHz IN]** connectors are usually used to realize synchronization among multiple instruments.

## 7. TRIGGER IN/OUT

Indicates the input and output terminal of Ext Trigger2. You can press **Input** **Output** → **Ext Trigger2** to set it to be the external trigger input interface; or use it to synchronize the trigger output interfaces of other test devices.

## 8. TRIGGER IN

Indicates the input terminal of Ext Trigger1. The Ext Trigger1 signal is sent to the spectrum analyzer through a BNC cable.

## 9. LAN

Through this interface, the analyzer can be connected to your local network for remote control. An integrated testing system can be built quickly, as the analyzer conforms to LXI Core 2011 Device instrument standards.

## 10. USB DEVICE

The analyzer can serve as a "slave" device to connect to the external USB device. The analyzer can be connected to the PC through this interface. Then, the RSA5000 series spectrum analyzer can be controlled remotely through programming or the PC software.

## 11. USB HOST

The analyzer can serve as a "master" device to connect to the external USB device. The USB storage device, the keyboard, and the mouse can be connected to the instrument via the interface.

## 12. HDMI

The interface is used to connect to the display, enabling you to clearly observe the signal under test and its characteristics.

### 13. IF OUT

Indicates the intermediate frequency signal in the output RF component. Its center frequency is 430 MHz.

## User Interface

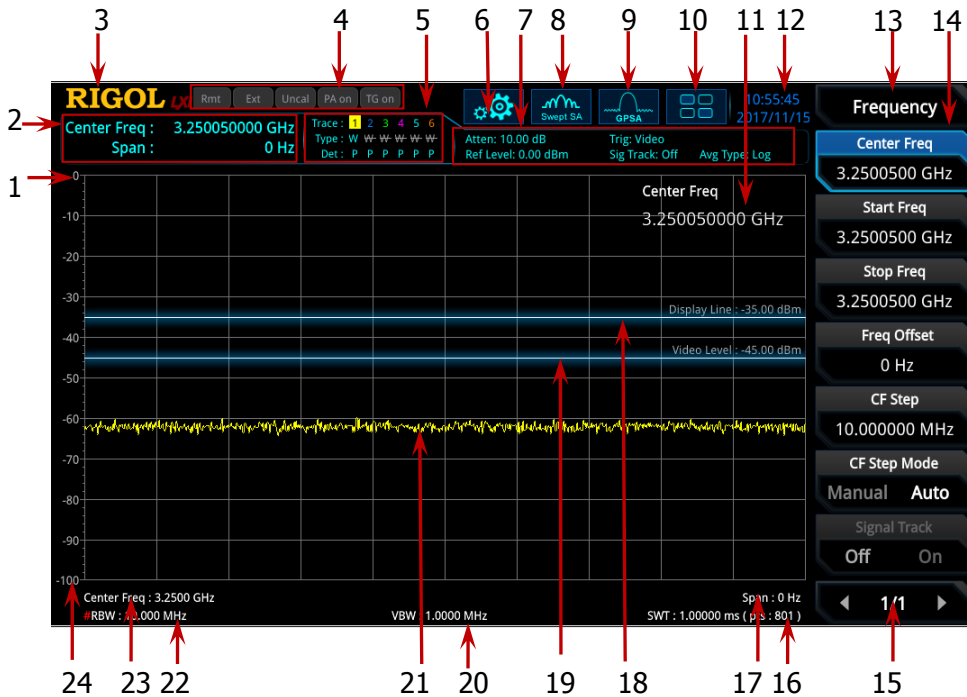











Figure 1-9 User Interface

Table 1-4 User Interface Icons

No.	Name	Description
1	Reference level	Displays the reference level value.
2	Measurement result	Displays the current measurement results for the marker (when no marker exists, the measurement results display frequency/span value).
3	<b>RIGOL</b>	Indicates the company logo.
4	System status	Rmt: indicates remote operation. Ext: indicates the external reference. Uncal: indicates that the measurement has not be calibrated. PA on: indicates that the preamp has been enabled. TG on: indicates that the tracking generator has been enabled.



5	Trace indicator <sup>[1]</sup>	Displays information about the trace and the detector.
6	Information setting	 : indicates messages, such as the prompt messages, alarm messages, and error messages.  : indicates the speaker. You can tune it up and down to increase and decrease the speaker volume, or set it to mute   : indicates the network settings. You can configure network parameters.  : unlocks the front panel keys;  : locks the front panel keys.  : unlocks the touch screen;  : locks the touch screen.  : indicates that no USB storage device is inserted;  : indicates that a USB storage device has been inserted.
7	Measurement bar	Displays measurement settings.
8	Measurement function	Displays the currently selected measurement function.
9	Working mode	Displays the currently selected working mode.
10	Function keypad	Clicks the keypad to display the function keypad interface.
11	Active function area	Displays the current parameter and its value.
12	Time	Displays the system time.
13	Menu title	Displays the currently selected menu name.
14	Menu item	Displays the menu item of the current function.
15	Menu page	Shows the current page and the total number of pages for the menu.
16	Sweep time and points	Indicates the sweep time and the number of sweep points in swept mode.
17	Span or stop frequency	The frequency range of the current sweep channel can be expressed by the combination of center frequency and span or the combination of start frequency and stop frequency.
18	Trigger level	Indicates video trigger level.
19	Display line	Indicates the readout reference and the threshold criteria for the peak
20	VBW	Indicates video bandwidth.
21	Spectrum line display area	Indicates the display area for the spectrum line.
22	RBW	Indicates the resolution bandwidth.
23	Center or start frequency	The frequency range of the current sweep channel can be expressed by the combination of center frequency and span or the combination of start

		frequency and stop frequency.
24	Y scale	Indicates the scale indication in the Y axis.

**Note<sup>[1]</sup>:** The display of the trace indicator is shown in the following figure:



- The first line displays the trace number. The color of the number is the same as that of the trace.
- The second line displays the trace type, including W (Clear/Write), A (Trace Average), M (Maximum Hold), and m (Minimum Hold). The letters with different colors and in different forms show different meanings.
  - The letter in blue indicates that the trace is updating.
  - The letter in gray indicates that the trace is not updated.
  - The letter with strikethrough and in gray color indicates that the trace will neither be updated nor displayed.
  - The letter with strikethrough and in blue color indicates that the trace is updating but not displayed. It is useful in trace math operation.
- The third line displays the detector type of each trace, including N (Normal, only available for GPSA), V (Voltage Average, only available for GPSA), P (Positive Peak), p (Negative Peak), S (Sample), R (RMS Average, only available for GPSA), Q (Quasi Peak, only available for GPSA), and A (Average, only available for RTSA). If it shows "f", it indicates that it is math operation trace. The letter in blue in the third line (detector type) indicates that the detector is in auto state; the letter in white indicates that it is in manual state.

## Mouse/Keyboard/Touch Screen Operation Rule

### Mouse Operation Rule







Connect the mouse (note that only the left-click operation is supported; the scroll and right-click operations with the mouse are not supported) to the spectrum analyzer via the USB HOST interface to perform the following operations:

1. Click to select the menu and window.
2. Press and hold the left mouse button to drag the data displayed on the graticule or move the slide bar.
3. Double-click the data displayed on the graticule and then the data will be appeared at the right-corner.
4. Under the Marker function, you can only use the mouse to move a marker, but unable to add a marker with the mouse.

## Keyboard Operation Rule

Connect the keyboard to the spectrum analyzer via the USB HOST interface, and then use the shortcut keys on the keyboard to perform the same function as what you do with the front panel keys.

Table 1-5 Matching Relations between the Front Panel Keys and the Keyboard Shortcut Keys

Front Panel Key	Keyboard Shortcut Key <sup>[1]</sup>
Mode	Alt + o
Mode Setup <sup>[2]</sup>	Shift + o
Meas	Alt + e
Meas Setup <sup>[2]</sup>	Shift + e
Auto Tune	Ctrl + Alt + a
Preset	Ctrl + Alt + p
FREQ <sup>[2]</sup>	Shift + f
SPAN <sup>[2]</sup>	Shift + s
AMPT <sup>[2]</sup>	Shift + a
BW <sup>[2]</sup>	Shift + b
Trace <sup>[2]</sup>	Shift + t
Sweep <sup>[2]</sup>	Shift + w
Input Output <sup>[2]</sup>	Shift + i
TG <sup>[2]</sup>	Shift + g
Cont	F11
Marker <sup>[2]</sup>	Shift + m
Marker -> <sup>[2]</sup>	Shift + k
Single	F12
Peak <sup>[2]</sup>	Shift + p
Marker Func <sup>[2]</sup>	Shift + u
Trigger <sup>[2]</sup>	Shift + r
System <sup>[2]</sup>	Shift + y
File	Ctrl + f
User	Ctrl + u
Recall	Ctrl + r
Save	Ctrl + s
Quick save	Ctrl + Alt + q
Help	Alt + F1
	Alt + F2
	Alt + F3
	Alt + F4
	Alt + F5
	Page Up
	Page Down
11 numeric keys	Numeric keys on the keyboard: 10 numeric

	numbers (1, 2, 3, 4, 5, 6, 7, 8, 9, 0) and a decimal point(.)
+	+
-	-
Esc	Esc
Back	Backspace
Enter	Enter
Arrow keys (Up/Down/Left/Right arrow key)	↑, ↓, ←, →
7 menu softkeys from top to bottom	F1 to F7

**Note<sup>[1]</sup>:** Except the keyboard shortcut keys mentioned in the above table, all the other keys on the keyboard do not work for the menu operation.

**Note<sup>[2]</sup>:** When the Caps Lock key is enabled, every letter you type would be in uppercase, even if you're not holding down the "Shift" key. If disabled, you have to press down "Shift" and the specified letter on the keyboard at the same time to input the letter in uppercase. For example, if you want to execute the "Shift+f" shortcut key operation, you only need to press "f" on the premise that the Caps Lock key is enabled.

## Touch Screen Operation Rule

RSA5000 has a 10.1-inch capacitive multi-touch screen that supports touch gestures.

1. When operating on the menus other than the Marker menu:
  - Tap the trace window, then slide left and right to modify the center frequency; slide up and down to modify the reference level.
  - Stretch two fingers horizontally in the trace window to decrease the span, and pinch the fingers horizontally to increase the span. Stretch two fingers in the vertical direction to decrease the Y-axis scale, and pinch the fingers vertically to increase the Y-axis scale.
2. When operating on the Marker menu:
  - In the empty space of the screen trace region, press and hold the region to add one new marker.
  - Tap and hold one marker to drag the marker.

## Menu Operation

There are 6 types of menus according to their operation modes. Each type of menu and its operation method are introduced below.

### 1. Parameter Input

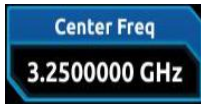

Select the menu and use the numeric keys to modify the value directly.

For example, to modify center frequency, first select **Center Freq**, and then input the desired value. Then, press **Enter** to complete parameter input.

### 2. State Switching

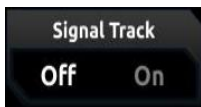

Press the corresponding menu key to switch between the sub-options.

For example, press **Signal Track**, and then you can switch between "On" and "Off" to enable or disable the signal tracking function.

### 3. Enter Lower-level Menu (with parameter)



Press the corresponding menu key to enter the lower-level menu and change the currently selected option. The parameter type in the upper-level menu will be changed when you return to the upper-level menu again.

For example, press **Y Axis Unit** to enter the lower-level menu. Select **dBm** and then automatically return to the previous menu automatically. Then, the unit of Y-axis will be changed to dBm.

### 4. Lower-level Menu (without parameter)

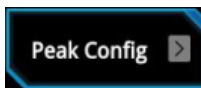

Press the corresponding menu key to enter the lower-level menu.

For example, press **Peak Config** to enter the lower-level menu directly.

### 5. Direct Execution



Press the key to execute the corresponding function.

For example, press **Mkr->CF** to set the center frequency of the analyzer to the frequency of the current marker.

### 6. State Selection

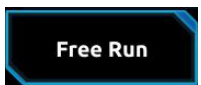

Press the corresponding menu key and modify the parameters, and then go back to the previous menu.

For example, press **Source -> Free Run** to select free trigger. The analyzer is in Free Run state at present.

**Tip:**

The above menu operations can be executed by touch gestures or clicking with the externally connected mouse. Also, you can connect to the keyboard and use the shortcut keys to perform the above menu operations. For the matching relations between the front panel keys and the keyboard shortcut keys, refer to Table 1-5.

## Parameter Setting

You can enter the desired parameter values by using the numeric keys, the knob, or arrow keys on the front panel. Also, you can set the parameters by using the touch screen, the externally connected keypad or the mouse. This section takes an example (set the center frequency to 800 MHz) to describe six methods of parameter setting.

### 1. Use the numeric keys

- 1) Press **FREQ** → **Center Freq**;
- 2) Input 800 by using the numeric keys;
- 3) Select the desired unit (MHz) from the pop-up menu.

### 2. Use the knob

When the parameter is editable, turn the knob clockwise to increase or counterclockwise to decrease the parameter value at the specified step.

- 1) Press **FREQ** → **Center Freq**;
- 2) Rotate the knob until the parameter is set to the desired value (800 MHz).

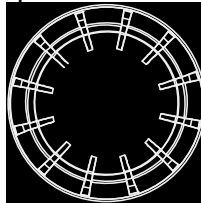

Figure 1-10 Knob

### 3. Use the arrow keys

When the parameter is editable, use the arrow keys to increase or decrease the parameter value at the specific step. Note that the step sizes for the Up/Down arrow key and the Left/Right arrow key are different.

- 1) Press **FREQ** → **Center Freq**;
- 2) Press the Up/Down arrow key or the Left/Right arrow key until the parameter is set to the desired value (800 MHz).



Figure 1-11 Arrow Keys

### 4. Use the touch screen

- 1) Touch the screen to select the function keypad icon  at the upper-right corner. Then, the function keypad is displayed. Touch **"FREQ"**;
- 2) Click **Center Freq**;

- 3) Then the numeric keypad is displayed. Input 800, and select the desired unit "MHz".

## 5. Use the keyboard

- 1) Press "Shift + f" to open the Frequency menu;
- 2) Press "F1" to select **Center Freq**;
- 3) Input 800 by using the numeric keys;
- 4) Press "F2" to select the desired unit (MHz) from the pop-up menu.

For the matching relations between the front panel keys and the keyboard shortcut keys, refer to Table 1-5.

## 6. Use the mouse

- 1) Click with the mouse to select the function keypad icon  at the upper-right corner of the screen. Then, the function keypad is displayed. Click "**FREQ**";
- 2) Click **Center Freq**;
- 3) Then the numeric keypad is displayed. Input 800, and select the desired unit "MHz".



## To Use the Built-in Help System

The built-in help system provides information about every function key on the front panel and every menu softkey.

### 1. Get the built-in help information

Press **Help** and a prompt message about how to obtain help information will be shown on the screen. Then, press the key that you want to know about its usage, and then the relevant help information for the key will be shown on the screen.

### 2. Page up/down operation

If the help information is displayed in several pages, you can press the arrow keys or use the knob to page up and down the help information.

### 3. Close the current help information

Press any key on the front panel to close the help information currently displayed on the screen.

When the help information is displayed on the screen, perform any of the following operations to close the currently displayed help information dialog box:

- press **Esc**;
- press the **Help** key again; or
- click **OK** in the displayed help information dialog box.

### 4. Get the help information of the menu key

Press **Help**, and the help information display window is displayed on the screen. Then, press the menu key and the help information of the corresponding menu item is displayed.

### 5. Get the help information of any function key

Press **Help**, and the help information display window is displayed on the screen. Then, press any function key and the corresponding function help information is displayed.

## Fuse Replacement

If you need to replace the fuse, use only the specified fuse (AC 250V, T3.15A) and perform the following operations:

1. Turn off the instrument, cut off the power, and remove the power cord.
2. Use a small straight slotted screwdriver to pry out the fuse holder.
3. Take out the fuse holder.
4. Replace the old fuse with a specified fuse.
5. Install the fuse holder.

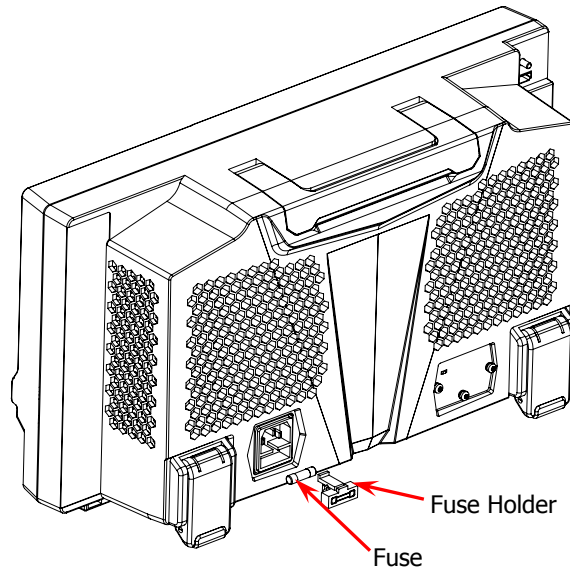

Figure 1-12 To Replace the Fuse



---

### **WARNING**

To avoid electric shock, please ensure that the instrument has been turned off, the power source has been cut off, and the fuse to be used conforms to the fuse rating.

---

# Mode Setting

## Mode

Provides two working modes: GPSA (general purpose spectrum analyzer) and RTSA (real-time spectrum analyzer).

**Note:** In different working modes, the functions of the keys on the front panel may be different. Press **Help** to display the help information of the current working mode. If you need help information for other modes, exit the help interface first. Then select the desired working mode and obtain the corresponding help information.

### 1. GPSA

GPSA adopts two analysis methods: swept and FFT. GPSA can not only carry out frequency domain analysis, but also time domain (zero span) analysis.

Select GPSA. In this working mode, press **Meas** to select multiple measurements. For details, refer to Chapter 2.

### 2. RTSA

RTSA provides the analysis function for the real-time signal, which can capture the complex signal seamlessly.

Select RTSA. Select RTSA. In this working mode, you can also press **Meas** to select multiple measurements. For details, refer to Chapter 3.

## Mode Setup

The Mode Setup menu is used to set parameters global to different measurements under all working modes. These parameters are independent of the currently running measurement, and they are global to all the measurements.

Open the global parameter setting menu for the selected working mode under **Mode**.

### 1. Global CF Mode

Turns on or off the global center frequency. In any working mode, if you enable the global center frequency, then the global center frequency will be set to the center frequency of the current mode. When you switch to a different working mode, the global center frequency will be set to the center frequency of its previous working mode. If you change the center frequency in any working mode, then the global center frequency will change with it.

### 2. Global CF

Sets the global center frequency. It is only available when you turns on the global center frequency.

### 3. Mode Preset

Resets the parameters of the current mode to be the factory default settings.

## Chapter 2 Functions of the Front Panel of GPSA

This chapter describes in detail the function keys on the front panel and their associated menu functions.

Contents in this chapter:

- Basic Settings
- Sweep and Function Settings
- Measurement Settings
- Marker Measurement

## Basic Settings

### FREQ

Sets the frequency parameters of the analyzer. The analyzer sweeps within a specified frequency range and restarts sweeping every time the frequency parameters are modified.

The frequency range of a channel can be expressed by either of two groups of parameters: Start Frequency/Stop Frequency ( $f_{start}/f_{stop}$ ); or Center Frequency/Span ( $f_{center}/f_{span}$ ). If any of the four parameters is changed, the other three parameters will make adjustment automatically to ensure the coupling relationship among them:

$$f_{center} = (f_{stop} + f_{start})/2 \quad (2-1)$$

$$f_{span} = f_{stop} - f_{start} \quad (2-2)$$

## Center Freq

Sets the center frequency (that corresponds to the horizontal center of the graticule) of the current channel. Press this key or touch the specified menu item on the screen to set the frequency entry mode to Center Frequency/Span. The center frequency and span values are respectively displayed at the lower left and right side of the graticule.

### Remarks:

- When you modify the center frequency, the start and stop frequency will be modified automatically if the span remains to be unchanged.
- Modifying the center frequency indicates that the frequency is changed along the current channel horizontally, and the adjustable range should be within the frequency range specified in the technical specifications of the analyzer.
- In zero span mode, the values of start frequency, stop frequency, and center frequency are the same, so once one of the parameter values is modified, the other two values will be modified automatically.
- You can use the numeric keys, the knob, and the arrow keys on the front panel to modify this parameter; also you can modify it on the touchscreen. For details, refer to descriptions in "**Parameter Setting**".

Table 2-1 Center Frequency

Parameter	Remarks
<b>Default</b>	$F_{max}^{[1]}/2$
<b>Range</b>	$(S_{min}/2)^{[2]}$ to $(F_{max} - S_{min}/2)$
<b>Unit</b>	GHz, MHz, kHz, Hz
<b>Knob Step</b>	span > 0, step = span/200
<b>Left/Right Arrow Key Step</b>	span = 0, step = RBW/100 Min = 1 Hz
<b>Up/Down Arrow Key Step</b>	CF step

**Note<sup>[1]</sup>:**  $F_{max}$  (maximum measurement frequency) is determined by the model of the spectrum analyzer. RSA5000 includes two models: 3.2 GHz and 6.5 GHz

**Note<sup>[2]</sup>:**  $S_{min}$  indicates the minimum span in non-zero span.

## Start Freq

Sets the start frequency of the current frequency channel. Press this key or touch the specified menu item on the screen to set the frequency entry mode to Start Frequency/Stop Frequency. The start frequency and stop frequency values are respectively displayed at the lower left and right side of the graticule.

### Remarks:

- When you modify the start frequency, the span and center frequency will be changed. The changes of span will affect other system parameters. For details, please refer to "**Span**".
- In zero span mode, the values of start frequency, stop frequency, and center frequency are the same, so once one of the parameter values is modified, the other two values will be modified automatically.
- You can use the numeric keys, the knob, and the arrow keys on the front panel to modify this parameter; also you can modify it on the touchscreen. For details, refer to descriptions in "**Parameter Setting**".

Table 2-2 Start Frequency

Parameter	Remarks
<b>Default</b>	center frequency-span/2
<b>Range<sup>[1]</sup></b>	0 Hz to Fmax
<b>Unit</b>	GHz, MHz, kHz, Hz
<b>Knob Step</b>	span > 0, step = span/200
<b>Left/Right Arrow Key Step</b>	span = 0, step = RBW/100 Min = 1 Hz
<b>Up/Down Arrow Key Step</b>	CF step

**Note<sup>[1]</sup>:** The range is from 0 Hz to (Fmax-10 Hz) in non-zero span.

## Stop Freq

Sets the stop frequency of the current frequency channel. Press this key or touch the specified menu item on the screen to set the frequency entry mode to Start Frequency/Stop Frequency. The start frequency and stop frequency values are respectively displayed at the lower left and right side of the graticule.

### Remarks:

- When you modify the stop frequency, the span and center frequency will be changed. The changes of span will affect other system parameters. For details, please refer to "**Span**".
- In zero span mode, the values of start frequency, stop frequency, and center frequency are the same, so once one of the parameter values is modified, the other two values will be modified automatically.
- You can use the numeric keys, the knob, and the arrow keys on the front panel to modify this parameter; also you can modify it on the touchscreen. For details,



refer to descriptions in "**Parameter Setting**".

Table 2-3 Stop Frequency

Parameter	Remarks
<b>Default</b>	center frequency+span/2
<b>Range</b> <sup>[1]</sup>	0 Hz to Fmax
<b>Unit</b>	GHz, MHz, kHz, Hz
<b>Knob Step</b>	span > 0, step = span/200
<b>Left/Right Arrow Key Step</b>	span = 0, step = RBW/100 Min = 1 Hz
<b>Up/Down Arrow Key Step</b>	CF step

**Note**<sup>[1]</sup>: The range is from 10 Hz to Fmax in non-zero span.

## CF Step

Changes the step size for the center frequency. Changing the center frequency by a constant step-size value switches the channel to be measured continuously.

### Remarks:

- Set a proper CF step value, and then select the center frequency. Use the Up/Down arrow key to switch the measurement channel at a fixed step size. Thus, the instrument can sweep the adjacent channels manually.
- You can use the numeric keys, the knob, and the arrow keys on the front panel to modify this parameter; also you can modify it on the touchscreen. For details, refer to descriptions in "**Parameter Setting**".

Table 2-4 CF Step

Parameter	Remarks
<b>Default</b>	Fmax/10
<b>Range</b>	-Fmax to Fmax
<b>Unit</b>	GHz, MHz, kHz, Hz
<b>Knob Step</b>	span > 0, step = span/200
<b>Left/Right Arrow Key Step</b>	span = 0, step = RBW Min = 1 Hz
<b>Up/Down Arrow Key Step</b>	at 1-2-5 step

## CF Step Mode

The CF step mode consists of "Manual" and "Auto".

### Remarks:

- In Auto mode, the CF step is 1/10 of the span in non-zero span mode or equals to RBW while in zero span mode.
- In Manual mode, you can use the numeric keys to set the step size.

## Freq Offset

You can set a frequency offset value to account for frequency conversions between the device under test (DUT) and the input terminal of the spectrum analyzer.

### Remarks:

- The change of this parameter only changes the display values of the center frequency, start frequency, and stop frequency; but does not affect any hardware settings of the spectrum analyzer.
- You can use the numeric keys, the knob, and the arrow keys on the front panel to modify this parameter; also you can modify it on the touchscreen. For details, refer to descriptions in "**Parameter Setting**".
- To eliminate the frequency offset, you can set the frequency offset to 0 Hz.

Table 2-5 Frequency Offset

Parameter	Remarks
<b>Default</b>	0 Hz
<b>Range</b>	-500 GHz to 500 GHz
<b>Unit</b>	GHz, MHz, kHz, Hz
<b>Knob Step</b>	span > 0, step = full span/200
<b>Left/Right Arrow Key Step</b>	
<b>Up/Down Arrow Key Step</b>	CF step

## Signal Track

Enables or disables the signal tracking function. This function is used to track and measure the signal whose frequency is unstable and whose transient variation in amplitude is less than 3 dB. Place Marker1 (refer to descriptions in "**Marker Measurement**") onto the signal under test to track and measure the variation of the signal. The signal tracking process is shown in the following figure:

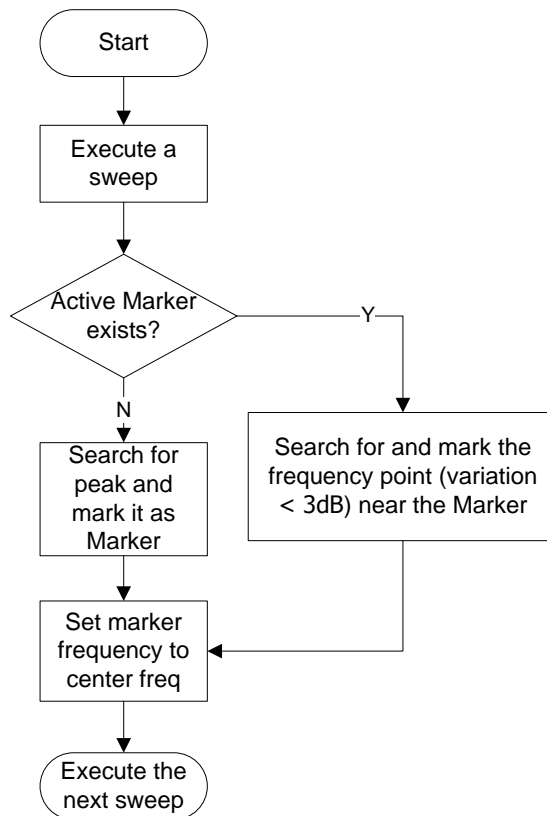

Figure 2-1 Signal Tracking Process

**Remarks:**

- If an active marker currently exists, when Signal Track is enabled, the instrument will search for and mark the point (whose amplitude variation is less than 3 dB) near the marker. Then, set the frequency at this point to be the center frequency to keep the signal at the center of the screen.
- If no marker is currently active, when Signal Track is enabled, the instrument will activate Marker1, execute a peak search automatically, and set the frequency value at the current peak to be the center frequency to keep the signal always displayed at the center of the screen.
- In continuous sweep, the system tracks the signal continuously; in single sweep, the instrument only performs a single signal track.
- The signal tracking function is only applicable to the swept analysis. The signal tracking function is invalid in the following conditions:
  - In zero span mode;
  - When the tracking generator is enabled;
  - When the trace is not updated;
  - When the continuous peak search is enabled;
  - In advanced measurement mode.

## SPAN

Sets the span of the analyzer. Changing this parameter will change the frequency parameters, and after the span is changed, the sweep restarts.

### Span

Sets the frequency range of the current channel. Press this key or touch the specified menu item on the screen to set the frequency entry mode to Center Frequency/Span. The center frequency and span values are respectively displayed at the lower left and right side of the graticule.

#### Remarks:

- When you modify the span, the start and stop frequency will be modified automatically, with the center frequency remains to be unchanged.
- In non-zero span, the span can be set to a minimum of 10 Hz. When the span is set to a maximum value, the spectrum analyzer enters the full span mode.
- You can set the span to 0 Hz manually; you can press the **Zero Span** menu item or run the SCPI commands to enter the zero span mode.
- When you modify the span in non-zero span mode, both CF step and RBW will be changed automatically if they are in Auto mode. Besides, the change of RBW will change the value of VBW (in Auto VBW mode).
- Any variation in span, RBW, or VBW would cause a change in the sweep time.
- You can use the numeric keys, the knob, and the arrow keys on the front panel to modify this parameter; also you can modify it on the touchscreen. For details, refer to descriptions in "**Parameter Setting**".

Table 2-6 Span

Parameter	Remarks
<b>Default</b>	Fmax
<b>Range<sup>[1]</sup></b>	0 Hz, 10 Hz to Fmax
<b>Unit</b>	GHz, MHz, kHz, Hz
<b>Knob Step</b>	span > 0, step = span/200 span = 0, step = 10 Min = 2 Hz
<b>Left/Right Arrow Key Step</b>	
<b>Up/Down Arrow Key Step</b>	at 1-2-5 step

**Note<sup>[1]</sup>:** When the span of the analyzer is set to 0 Hz, the spectrum analyzer enters the zero span mode.

### Last Span

Sets the span to the previous span setting.

## Full Span

Sets the maximum span.

## Zero Span

Sets the span to 0 Hz. The values of start frequency and stop frequency are the same as that of the center frequency. The X-axis is time. The analyzer measures the time-domain characteristics of the amplitude at the center frequency point of the input signal.

### Remarks:

The zero span mode displays the time-domain characteristics of the signal's fixed frequency components. Great differences can be found between the zero span and the non-zero span. The following functions are invalid in zero span.

- "Signal Track" under **FREQ**;
- "Mkr -> CF", "Mkr -> CF Step", "Mkr -> Start", "Mkr -> Stop", "Mkr  $\Delta$  -> CF", and "Mkr  $\Delta$  -> Span" under **Marker To**;

## AMPT

Sets the amplitude parameters of the analyzer. You can modify these parameters to make the signals under test be displayed with minimal errors in the current window, easy for you to observe.

## Ref Level

Sets the maximum power or voltage that can be displayed in the current window.

### Remarks:

- As the RF link is limited by the maximum mixer level, when the attenuation is reduced, the reference level will be reduced to meet the limitation of the mixer level; when the attenuation is increased, the reference level will remain unchanged.
- You can use the numeric keys, the knob, and the arrow keys on the front panel to modify this parameter; also you can modify it on the touchscreen. For details, refer to descriptions in "**Parameter Setting**".

Table 2-7 Reference Level

Parameter	Remarks
<b>Default</b>	0 dBm
<b>Range</b>	-170 dBm to 30 dBm
<b>Unit</b>	dBm, -dBm, V, mV, uV
<b>Knob Step</b>	In Log scale mode, step = scale/10
<b>Left/Right Arrow Key Step</b>	In Lin scale mode, step = 0.1 dBm
<b>Up/Down Arrow Key Step</b>	In Log scale mode, step = scale In Lin scale mode, step = 1 dBm

## Attenuation

Sets the RF front-end attenuator to allow high-level signals to pass through the mixer with low distortion, and low-level signals to pass through the mixer with low noise.

### Remarks:

- The attenuator consists of fixed attenuator and variable attenuator. The attenuation of the fixed attenuator is 20 dB, and the attenuation range of the variable attenuator is from 0 dB to 30 dB. Therefore, the input attenuation ranges from 0 dB to 50 dB.
- When the set attenuation amount is greater than 20 dB, fixed attenuator is preferred to be used by default.
- When the maximum mixer level and reference level are confirmed, the minimum of the input attenuation should meet the following equation:

$$ATT_{min} = L_{Ref} + a_{PA} + a_{Ext} - L_{Offset} - L_{mix} \quad (2-3)$$

Wherein,  $ATT_{min}$ ,  $L_{Ref}$ ,  $a_{PA}$ ,  $a_{Ext}$ ,  $L_{Offset}$ , and  $L_{mix}$  indicate the minimum input attenuation, reference level, PA, external gain, reference level offset, and maximum mixer level, respectively.

- You can use the numeric keys, the knob, and the arrow keys on the front panel to modify this parameter; also you can modify it on the touchscreen. For details, refer to descriptions in "**Parameter Setting**".

Table 2-8 Input Attenuation

Parameter	Remarks
<b>Default</b>	10 dB
<b>Range</b>	0 dB to 50 dB
<b>Unit</b>	dB
<b>Knob Step</b>	Preamp off, step = 1 dB
<b>Left/Right Arrow Key Step</b>	
<b>Up/Down Arrow Key Step</b>	5 dB

## Atten Auto

Selects "Manual" or "Auto" to be the current attenuation mode.

### Remarks:

- To select "Manual" to be the attenuation mode, press **Attenuation** to set the attenuation value, and the attenuation mode will be automatically switched to "Manual".
- When you select "Auto" to be the attenuation mode, the attenuator will automatically adjust the attenuation value to meet the current amplitude setting.

## RF Preamp

Sets the RF front-end preamplifier to be on or off. When the signal under test is a low-level signal, turning on the preamplifier can reduce the displayed average noise level, so that you can distinguish low-level signals from the noise. By default, the preamp gain is 20 dB.

## Y Axis Unit

Sets the unit of the Y-axis to dBm, dBmV, dBuV, Volts, or Watts. Wherein, dBm, dBmV, and dBuV are for Log scale; Volts and Watts are for Linear scale. The default unit is dBm.

### Remarks:

The conversion relations between units are as follows:

$$dBm = 10 \lg \left( \frac{\text{Volts}^2}{R} \times \frac{1}{0.001W} \right) \quad (2-4)$$

$$dB\mu V = 20 \lg \left( \frac{\text{Volts}}{1\mu V} \right) \quad (2-5)$$

$$dBmV = 20 \lg \left( \frac{\text{Volts}}{1mV} \right) \quad (2-6)$$

$$\text{Watts} = \frac{\text{Volts}^2}{R} \quad (2-7)$$

Wherein,  $R$  denotes the reference resistance.

## Scale Type

Sets the scale type of the Y-axis to Lin or Log. By default, it is Log.

### Remarks:

- In Log scale type, the Y-axis denotes the logarithmic coordinate. The top line of the graticule is the reference level, and the scale per division represents the scale value. When the scale type is changed from Lin to Log, the unit of Y-axis will automatically switch to the default unit (dBm) in Log scale type.
- In Lin scale type, the Y-axis denotes the linear coordinate. The top line of the graticule is the reference level, and 0 V is at the bottom of the graticule. Each vertical division of the graticule represents one-tenth of the reference level. The scale setting function is invalid. When the scale type is changed from Log to Lin, the unit of Y-axis will automatically switch to the default unit (Volts) in Lin scale type.
- The scale type does not affect the unit of Y-axis.
- If the "Normalize" function is enabled, "Log" is selected to be the scale type by default, and the scale type is grayed out and disabled.

## Scale/Div

Sets the logarithmic units per vertical grid division on the display. This function is only available when the scale type is set to "Log".

### Remarks:

- The amplitude range to be displayed can be adjusted by setting the scale.
- The range of the signal amplitude that can be displayed is as follows:  
Minimum: reference level – 10 × current scale value  
Maximum: reference level
- You can use the numeric keys, the knob, and the arrow keys on the front panel to modify this parameter; also you can modify it on the touchscreen. For details, refer to descriptions in "**Parameter Setting**".

Table 2-9 Scale

Parameter	Remarks
<b>Default</b>	10 dB
<b>Range</b>	0.1 dB to 20 dB
<b>Unit</b>	dB
<b>Knob Step</b>	scale $\geq$ 1, step = 1 dB
<b>Left/Right Arrow Key Step</b>	scale < 1, step = 0.1 dB
<b>Up/Down Arrow Key Step</b>	at 1-2-5 step



## Max Mixer Lvl

Sets the maximum input level of the mixer according to the amplitude of the signal.

### Remarks:

- For the high-level input signal, select a smaller maximum mixer level to increase the input attenuation and reduce the distortion of the signal; for the low-level input signal, select a larger maximum mixer level to reduce the input attenuation and noise.
- You can use the numeric keys, the knob, and the arrow keys on the front panel to modify this parameter; also you can modify it on the touchscreen. For details, refer to descriptions in "**Parameter Setting**".

Table 2-10 Maximum Mixing Level

Parameter	Remarks
<b>Default</b>	-10 dBm
<b>Range</b>	-50 dBm to -10 dBm
<b>Unit</b>	dBm, -dBm, mV, uV
<b>Knob Step</b>	1 dBm
<b>Left/Right Arrow Key Step</b>	
<b>Up/Down Arrow Key Step</b>	5 dBm

## Ref Offset

Adds an offset value to the reference level to compensate for gains or losses generated between the DUT and the analyzer input.

### Remarks:

- The offset value does not affect the trace position, but will modify the reference level readout and the marker amplitude readout.
- You can use the numeric keys, the knob, and the arrow keys on the front panel to modify this parameter; also you can modify it on the touchscreen. For details, refer to descriptions in "**Parameter Setting**".

Table 2-11 Reference Level Offset

Parameter	Remarks
<b>Default</b>	0 dB
<b>Range</b>	-300 dB to 300 dB
<b>Unit</b>	dB
<b>Knob Step</b>	1 dB
<b>Left/Right Arrow Key Step</b>	
<b>Up/Down Arrow Key Step</b>	5 dB

## Sweep and Function Settings

### BW

Sets the parameters such as RBW (Resolution Bandwidth) and VBW (Video Bandwidth).

### RBW

Sets the resolution bandwidth (RBW) to distinguish two signals whose frequencies are close with each other.

#### Remarks:

- Reducing RBW can gain a higher frequency resolution, but will also prolong the sweep time (when sweep time is set to Auto, it will be affected by both RBW and VBW).
- You can use the numeric keys, the knob, and the arrow keys on the front panel to modify this parameter; also you can modify it on the touchscreen. For details, refer to descriptions in "**Parameter Setting**".

**Note:** When "Detector Type" is "Quasi Peak", or the "Filter Type" is "EMC", the available values of RBW can only be 200 Hz, 9 kHz, 120 kHz, or 1 MHz.

Table 2-12 RBW

Parameter	Remarks
Default	10 MHz
Range	1 Hz to 10 MHz
Unit	GHz, MHz, kHz, Hz
Knob Step	at 1-3-10 step
Left/Right Arrow Key Step	
Up/Down Arrow Key Step	at 1-3-10 step

### RBW Mode

Sets the coupling mode of RBW.

#### Remarks:

- When you set **RBW Mode** to "Auto", RBW is in auto coupling state. Its value changes with the span (non-zero span), and the value is determined by span/RBW ratio. You can set **RBW Mode** to "Manual" or directly set the RBW value to change the coupling mode.
- When you perform the Preset operation, the coupling state is Auto.
- In zero span mode, RBW Mode is, by default, set to "Manual".

## SPAN/RBW Ratio

Sets the ratio of span to RBW. You can use the numeric keys, the knob, and the arrow keys on the front panel to modify this parameter; also you can modify it on the touchscreen. For details, refer to descriptions in "**Parameter Setting**".

Table 2-13 Span/RBW Ratio

Parameter	Remarks
Default	106
Range	2 to 10,000
Unit	None
Knob Step	at 1-2-5 step
Left/Right Arrow Key Step	
Up/Down Arrow Key Step	

## SPAN/RBW Mode

Sets the coupling mode of the Span/RBW ratio.

### Remarks:

- When you set **SPAN/RBW Mode** to "Auto", "SPAN/RBW Ratio" is in auto coupling state, and its value is 106. You can set **SPAN/RBW Mode** to "Manual" or directly set the SPAN/RBW ratio to change the coupling mode.
- When you perform the Preset operation, the coupling state is Auto.
- In zero span mode, the SPAN/RBW Mode menu item cannot be set.

## VBW

Sets the video bandwidth (VBW) to filter out the noises outside the video band.

### Remarks:

- Reducing VBW makes the spectral line smoother, so that the low-level signal in the noise can be detected, but this will also prolong the sweep time (when sweep time is set to Auto, it will be affected by both RBW and VBW).
- You can use the numeric keys, the knob, and the arrow keys on the front panel to modify this parameter; also you can modify it on the touchscreen. For details, refer to descriptions in "**Parameter Setting**".

Table 2-14 VBW

Parameter	Remarks
Default	10 MHz
Range	1 Hz to 10 MHz
Unit	GHz, MHz, kHz, Hz
Knob Step	at 1-3-10 step
Left/Right Arrow Key Step	
Up/Down Arrow Key Step	

## VBW Mode

Sets the coupling mode of the Span/RBW ratio.

### Remarks:

- When you set **VBW Mode** to "Auto", VBW is in auto coupling state. Its value changes with the RBW, and the value is determined by VBW/RBW ratio. You can set **VBW Mode** to "Manual" or directly set the VBW value to change the coupling mode.
- When you perform the Preset operation, the coupling state is Auto.

## VBW/RBW Ratio

Sets the ratio of VBW to RBW.

### Remarks:

- This value is different for different kinds of signals.  
Sine signal: 1 to 3 (for faster sweeps)  
Pulse signal: 10 (to reduce the impact on the amplitude of transient signals)  
Noise signal: 0.1 (to obtain the average of noises)
- You can use the numeric keys, the knob, and the arrow keys on the front panel to modify this parameter; also you can modify it on the touchscreen. For details, refer to descriptions in "**Parameter Setting**".

Table 2-15 VBW/RBW Ratio

Parameter	Remarks
Default	1
Range	0.00001 to 3,000,000
Unit	None
Knob Step	at 1-3-10 step
Left/Right Arrow Key Step	
Up/Down Arrow Key Step	at 1-3-10 step

## VBW/RBW Mode

Sets the coupling mode of the VBW/RBW ratio.

### Remarks:

- When you set **VBW/RBW Mode** to "Auto", "VBW/RBW Ratio" is in auto coupling state, and its value is determined by auto rule value. You can set **VBW/RBW Mode** to "Manual" or directly set the VBW/RBW ratio to change the coupling mode.
- When you perform the Preset operation, the coupling state is Auto.

## Filter Type

Sets the type of the RBW filter.

### Remarks:

- RSA5000 supports two kinds of RBW filters: Gaussian (-3 dB) or EMC (-6 dB)
- When EMC filter is selected currently, the available RBW can only be 200 Hz, 9 kHz, 120 kHz, or 1 MHz.
- By default, the analyzer uses the Gaussian filter. If the detector type is "Quasi-peak", then the analyzer automatically switches to EMI filter.

## Sweep

Sets sweep-related parameters, such as sweep time, sweep points, and sweep mode.

### Sweep Points

Sets the number of points acquired in each sweep, i.g. the number of the trace points.

#### Remarks:

- With the increase of the sweep points, the frequency resolution of the marker will increase with it, but the sweep speed will decrease with it.
- Due to the limitation of the minimum interval of sweep points, when the number of sweep points is increased, the sweep time will be prolonged.
- Changing the number of the sweep points will affect multiple parameters of the system. Therefore, the system will make a new sweep and measurement again.
- You can use the numeric keys, the knob, and the arrow keys on the front panel to modify this parameter; also you can modify it on the touchscreen. For details, refer to descriptions in "**Parameter Setting**".

Table 2-16 Number of Sweep Points

Parameter	Remarks
<b>Default</b>	801
<b>Range</b>	101 to 10,001
<b>Unit</b>	None
<b>Knob Step</b>	1
<b>Left/Right Arrow Key Step</b>	
<b>Up/Down Arrow Key Step</b>	

### Sweep Time

Sets the time required for the spectrum analyzer to complete one sweep operation within the span range.

#### Remarks:

- You can use the numeric keys, the knob, and the arrow keys on the front panel to modify this parameter; also you can modify it on the touchscreen. For details, refer to descriptions in "**Parameter Setting**".
- When RBW is smaller than 1 kHz, the spectrum analyzer starts to perform FFT sweeps. At this time, the **Sweep Time** menu is disabled and grayed out.

Table 2-17 Sweep Time

Parameter	Remarks
<b>Default</b>	1 ms
<b>Range<sup>[1]</sup></b>	1 $\mu$ s to 6,000 s
<b>Unit</b>	s, ms, $\mu$ s, ns, ps
<b>Knob Step</b>	sweep time/100, Min = 1 $\mu$ s
<b>Left/Right Arrow Key Step</b>	
<b>Up/Down Arrow Key Step</b>	at 1-1.5-2-3-5-7.5 step

**Note<sup>[1]</sup>:** The range is from 1 ms to 4,000 s in non-zero span.

## Sweep Time Mode

Sets the "Sweep Time" to be "Auto" or "Manual". By default, it is "Auto".

### Remarks:

- In non-zero span mode, the analyzer selects the shortest sweep time based on the current RBW and VBW settings if "Auto" is selected.
- Decreasing the sweep time can speed up the measurement. However, an error may be caused if the set sweep time is less than the minimum sweep time in Auto coupling. At this point, "UNCAL" is shown in the status bar on the screen.
- In zero span mode, the **Sweep Time Mode** menu is disabled and grayed out. When the system exits the zero span mode, the auto sweep coupling mode will restore to its previous state.
- When RBW is smaller than 1 kHz, the spectrum analyzer starts to perform FFT sweeps. At this time, the **Sweep Time** menu is disabled and grayed out.

## Sweep Time Rule

Sets the sweep type to "Norm" or "Accy". The sweep will be faster if "Norm" is selected; while in "Accy" type, a higher measurement precision can be obtained. When RBW is smaller than 1 kHz, the spectrum analyzer starts to perform FFT sweeps. At this time, the **Sweep Time** menu is disabled and grayed out.

## Continue

Sets the sweep mode to be continuous.

### Remarks:

- If the instrument is in single sweep mode and no measurement function is enabled, press this key to enter continuous sweep mode. In this case, if the trigger conditions are met, the instrument will sweep continuously.
- If the instrument is in single sweep mode and the measurement function is

enabled, press this key to enter continuous sweep mode. In this case, if the trigger conditions are met, the instrument will sweep continuously.

- In continuous sweep mode, the system will send a trigger initialization signal automatically and enter the trigger condition judgment directly after each sweep is completed.

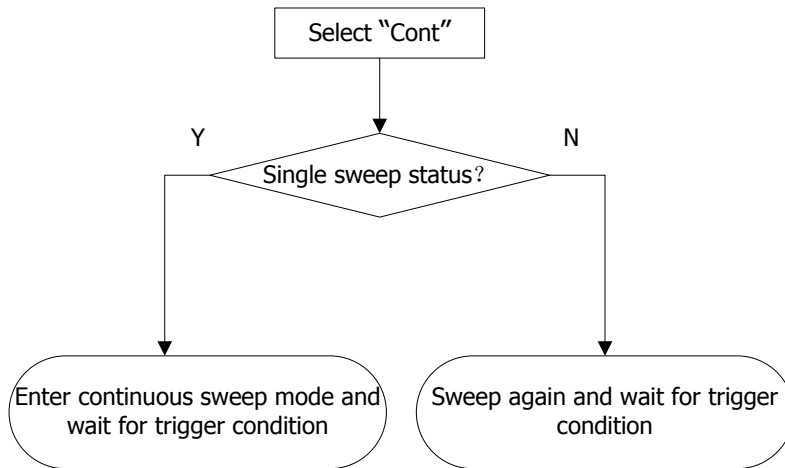

Figure 2-2 Process of Continuous Sweep

## Single

Sets the sweep mode to be single. Selects "Single", and then the **Single** key on the front panel is illuminated.

In single sweep mode, press **Single** under Sweep menu or press **Single** directly on the front panel to perform one measurement.

### Remarks:

- If the instrument is in continuous sweep mode and no measurement function is enabled, press this key to enter single sweep mode. In this case, if the trigger conditions are met, the instrument will execute the specified number of sweeps. (Note: In Average, Max Hold, and Min Hold modes, when performing the single measurement, the instrument will not stop sweeping until the sweep count has reached N. Wherein, N is determined by the average count of the current measurement.)
- If the instrument is in continuous sweep mode and the measurement function is enabled, press this key to set the measurement mode to "Single". In this case, if the trigger conditions are met, the instrument will execute the specified number of measurements.
- If the system is already in single sweep mode, press this key and then the system will execute the specified number of sweeps (or measurements) once the trigger conditions are met.
- In single sweep mode, trigger initialization (press **Sweep** → **Single** or send the



":INIT" command through the remote interface) should be executed before judging the trigger conditions.

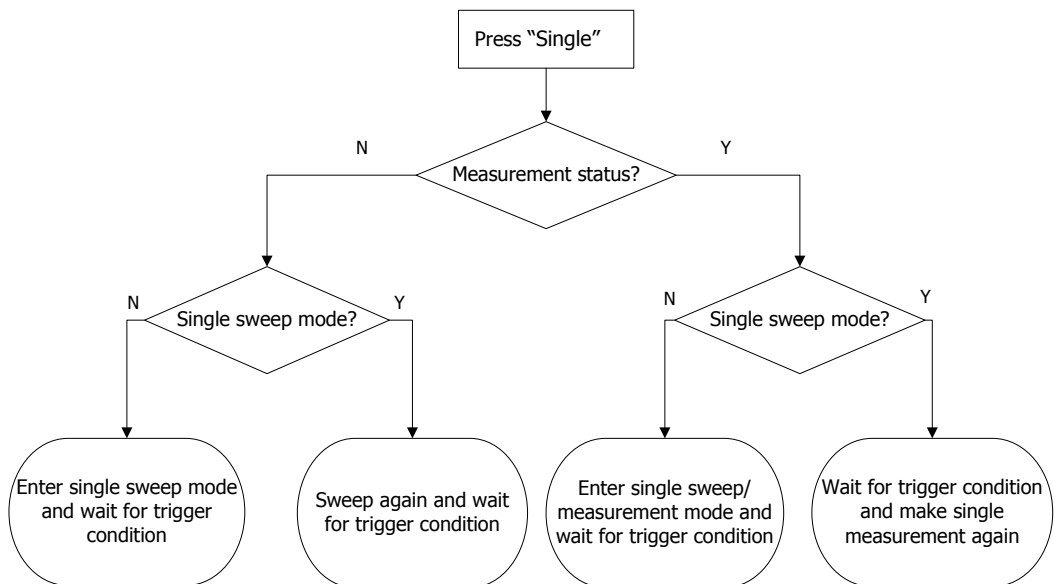

Figure 2-3 Process of Single Sweep

## Trigger

Selects the trigger source and sets trigger-related parameters.

### Trigger Source

Sets "Free Run", "External 1", "External 2", or "Video" to be the trigger source.

#### 1. Free Run

The trigger conditions are met at any time, that is, the analyzer generates trigger signals continuously.

#### 2. External 1

In this mode, an external signal is input via the **[TRIGGER IN]** connector on the rear panel. When the signal meets the set trigger conditions, trigger signals are generated.

#### 3. External 2

Press **Input Output** → **Ext Trigger2** to select "In". Then, an external signal is input via the **[TRIGGER IN/OUT]** connector on the rear panel. When the signal meets the set trigger conditions, trigger signals are generated.

**Note:** For the external trigger interface, the input signal frequency shall not exceed 1 MHz.

#### 4. Video

A trigger signal will be generated when the system detects a video signal whose voltage exceeds the specified video trigger level.

**Note:** This trigger type is available in either of the following conditions:

- 1) in non-zero span mode
- 2) when "Average(RMS)" or "Average(Vol)" is selected for the detector type.

## Slope

Sets the trigger polarity for External Trigger. It is set positive to trigger on a rising edge and negative to trigger on a falling edge.

## Trigger Delay Switch

Enables or disables the trigger delay function. After the trigger delay function is enabled, you can set the trigger delay time.

## Trig Delay

Sets the time interval during which the instrument waits to start the sweep operation after the trigger signal that meets the trigger conditions is generated. You can use the numeric keys, the knob, and the arrow keys on the front panel to modify this parameter; also you can modify it on the touchscreen. For details, refer to descriptions in "**Parameter Setting**".

Table 2-18 Trigger Delay

Parameter	Remarks
<b>Default</b>	1 $\mu$ s
<b>Range</b>	0 $\mu$ s to 500 ms
<b>Unit</b>	s, ms, $\mu$ s, ns, ps
<b>Knob Step</b>	trigger delay/100, Min = 1 $\mu$ s
<b>Left/Right Arrow Key Step</b>	
<b>Up/Down Arrow Key Step</b>	
	at 1-1.5-2-3-5-7.5 step

## Trigger Level

Sets the trigger level in video trigger. At this time, the trigger level line and the trigger level value are displayed on the screen.

### Remarks:

- When the video trigger signal is not within the display range, the trigger level line is displayed at the top or bottom of the waveform display area.
- You can use the numeric keys, the knob, and the arrow keys on the front panel to modify this parameter; also you can modify it on the touchscreen. For details, refer to descriptions in "**Parameter Setting**".

Table 2-19 Trigger Level

Parameter	Remarks
<b>Default</b>	-25 dBm
<b>Range</b>	-140 dBm to +30 dBm
<b>Unit<sup>[1]</sup></b>	dBm
<b>Knob Step</b>	1 dBm
<b>Left/Right Arrow Key Step</b>	
<b>Up/Down Arrow Key Step</b>	
	10 dBm

**Note<sup>[1]</sup>:** It is related to the specified unit of Y-axis.

## Trigger Holdoff Switch

Turns on or off the trigger holdoff function.

## Trigger Holdoff

Sets the holdoff time between trigger signals. You can use the numeric keys, the knob, and the arrow keys on the front panel to modify this parameter; also you can modify it on the touchscreen. For details, refer to descriptions in "**Parameter Setting**".

When the trigger conditions are met, the trigger occurs. Then, the delay begins, and the holdoff time begins. During the holdoff time, new trigger signals will be ignored. For a free-running trigger, the holdoff value is the minimum time between two trigger signals.

Table 2-20 Trigger Holdoff Time

Parameter	Remarks
<b>Default</b>	100 ms
<b>Range</b>	100 $\mu$ s to 500 ms
<b>Unit</b>	s, ms, $\mu$ s, ns, ps
<b>Knob Step</b>	sync holdoff time/100, Min = 1 $\mu$ s
<b>Left/Right Arrow Key Step</b>	
<b>Up/Down Arrow Key Step</b>	at 1-1.5-2-3-5-7.5 step

## Auto Trig Switch

Enables or disables the auto trigger function.

## Auto Trig

Sets the time that the instrument will wait for the trigger conditions to be met. When the set waiting time times out, the instrument will not wait and start to initiate the sweep measurement.

Table 2-21 Auto Trigger Time

Parameter	Remarks
<b>Default</b>	100 ms
<b>Range</b>	1 ms to 100 s
<b>Unit</b>	s, ms, $\mu$ s, ns, ps
<b>Knob Step</b>	auto trigger time/100, Min = 1 $\mu$ s
<b>Left/Right Arrow Key Step</b>	
<b>Up/Down Arrow Key Step</b>	at 1-1.5-2-3-5-7.5 step

The relationship among the relevant parameters concerning trigger is shown in the following figure.

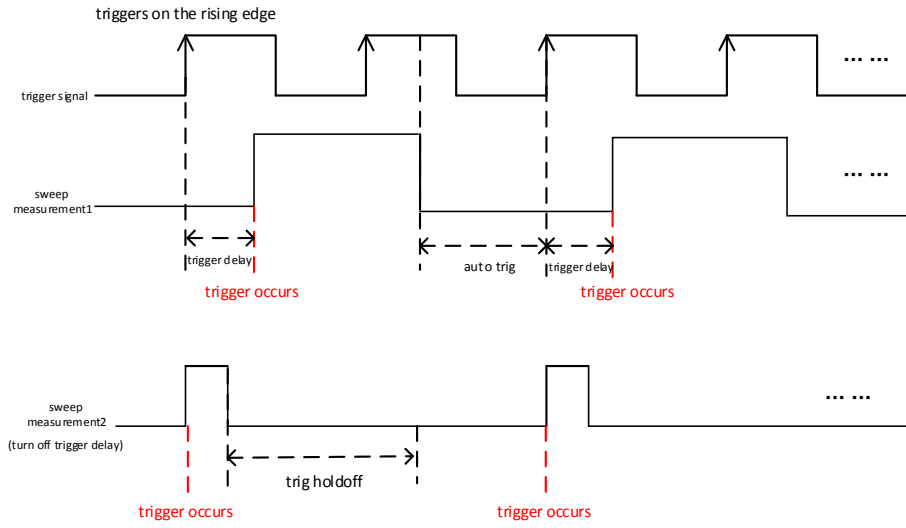

Figure 2-4 Trigger Parameter Relationship

## Trace

Displays the sweep signal on the screen. Press **Trace** to set parameters for trace.

### Trace Selection

RSA5000 can display at most 6 traces synchronously. Each trace is indicated in different colors (Trace1-yellow, Trace2-dark blue, Trace3-green, Trace4-purple, Trace5-light blue, Trace6-orange). For details, refer to the notes about "**trace indicator**" in "User Interface".

Select the corresponding trace to set the relevant parameters for the specified trace. By default, Trace1 is selected, and the trace type is "Clear Write".

**Note:** The trace currently displayed on the screen can be saved to the internal or external memory. If needed, you can recall it at any time. Press **Save** to save it according to descriptions in "**Save**".

### Trace Type

Sets the type of the currently selected trace. The system calculates the sampled data by a specific operation method according to the selected trace type. The results will not be displayed unless you set "Trace Update" and "Trace Display" to "On". Trace types include Clear Write, Average, Max Hold, and Min Hold.

#### 1. Clear Write

Sets the trace data to a minimum value, and displays the real-time sweep data of each point on the trace.

#### 2. Average

Displays an average trace, which is represented by averaging the data of each point on the trace. The type of the trace is displayed to be smooth.

#### 3. Max Hold

Maintains and displays a max hold trace, which represents the maximum data value on a point-by-point basis. When a new maximum value is generated, data will be updated, and the newly updated maximum value prevails.

#### 4. Min Hold

Maintains and displays a min hold trace, which represents the minimum data value on a point-by-point basis. When a new minimum value is generated, data will be updated, and the newly updated minimum value prevails.

## Detector Type

Sets the detector for the current measurement. The selected detector can be applied to the selected trace. The available trace detectors include Pos Peak, Neg Peak, Normal, Sample, Average (RMS), and Average (Vol).

### 1. Pos Peak

For each trace point, Positive Peak detector displays the maximum value of data sampled within the corresponding time interval.

### 2. Neg Peak

For each trace point, Negative Peak detector displays the minimum value of data sampled within the corresponding time interval.

### 3. Normal

Normal detector (also called Rosenfell detector) displays the maximum value and the minimum value of the sample data segment in alternating sequence. That is, for an odd-numbered data point, the minimum value of the sample data is displayed; for an even-numbered data point, the maximum value of the sample data is displayed. In this way, the amplitude variation range of the signal is clearly shown.

### 4. Sample

For each trace point, sample detector displays the transient level corresponding to the central time point of the corresponding time interval. This detector type is applicable to noise or noise-like signal.

### 5. Average (RMS)

For each data point, perform mean square root operation (see equation (2-8) of the sampled data within the corresponding time interval and display the result. In this type, noise can be rejected and weak signals can be clearly observed.

$$V_{RMS} = \sqrt{\frac{1}{N} \times \sum_{i=1}^N v_i^2} \quad (2-8)$$

Wherein,  $V_{RMS}$  is the root mean square value of voltage, expressed in V;  $N$  is the number of sampled values for each point displayed;  $v_i$  is the envelope of the sampled value, expressed in V. Reference impedance  $R$  can be used to

calculate power based on the formula:  $P = \frac{V_{RMS}^2}{R}$ .

### 6. Average (Vol)

For each data point, perform arithmetic averages (see equation below) on all the sampled data within the corresponding time interval and display the result.

$$V_{AV} = \frac{1}{N} \times \sum_{i=1}^N v_i \quad (2-9)$$

Wherein,  $V_{AV}$  is the average of voltage in V;  $N$  is the number of sampled values for each point displayed; and  $v_i$  is the envelop of the sampled value in V.

## 7. Quasi Peak

Quasi-peak detection is a weighted form of peak detection. For each data point, the detector detects the peak in the corresponding time interval, and uses quasi-peak detector circuit (containing specific charge and discharge structure) and the time constants specified in CISPR Publication 16 to make weighted calculation to display the weighted results. The quasi-peak detection is used for EMC test.

**Note:** The charge time for the quasi-detector is much shorter than the discharge time, which can not only reflects the amplitude of the signal, but also the time distribution of the signal.

## Detector Auto

Enables or disables the Detector Auto function. By default, Detector Auto is enabled. If you set the detector type manually, please disable the Detector Auto function.

## Trace Update

Enables or disables trace update.

## Trace Display

Enables or disables the trace display.

### Remarks:

- The trace state and the parameter settings for the corresponding state are as follows:
  - Active: Trace Update and Trace Display are "On".
  - View: Trace Update is "Off", and Trace Display is "On".
  - Clear: Trace Update and Trace Display are "Off".
  - Back-end: Trace Update is "On", and Trace Display is "Off".
- In most cases, the inactive trace data keep unchanged. However, the data may be changed in the following conditions:
  - Remotely write data into trace;



- Load the stored data to trace.
- Trace data are cleared by the trace clear function.
- When inactive trace is displayed, the trace will not be zoomed in or out based on the setting of X-axis, but will move up and down based on the changes of Y-axis values.
- When the trace is shifted from inactive to active state, the trace is cleared, the average timer is reset, and a new sweep is restarted.

## Math Function

Trace math functions perform mathematical operations between traces and, in some cases, user-defined offsets.

### 1. Op1-Op2

Calculates the power difference between Operand 1 (Op1) and Operand 2 (Op2), and saves it to the destination trace. During the sweep, the following formula is executed for each point:

$$Trace_{result} = 10\log(10^{(Op1/10)} - 10^{(Op2/10)}) \quad (2-10)$$

In the above formula, the values of the trace points are assumed to be in a decibel scale. If a point in Op1 is a maximum trace value, the difference (the result of the subtraction) is also a maximum trace value; if the difference is less than or equal to 0, the resultant point is the minimum trace value.

### 2. Op1+Op2

Calculates the power sum between Operand 1 (Op1) and Operand 2 (Op2), and saves it to the destination trace. During the sweep, the following formula is executed for each point:

$$Trace_{result} = 10\log(10^{(Op1/10)} + 10^{(Op2/10)}) \quad (2-11)$$

In the above formula, the values of the trace points are assumed to be in a decibel scale. If a point in Op1 or Op2 is a maximum trace value, the sum (the result of addition) is also a maximum trace value.

### 3. Op1+Offset

Calculates the sum between Operand 1 (Op1) and the offset, and saves it to the destination trace. During the sweep, the following formula is executed for each point:

$$Trace_{result} = Op1 + Offset \quad (2-12)$$

In the above formula, the parameter unit is dB.

### 4. Op1-Offset

Calculates the difference between Operand 1 (Op1) and the offset (Offset), and saves it to the destination trace. During the sweep, the following formula is executed for each point:

$$Trace_{result} = Op1 - Offset \quad (2-13)$$

In the above formula, the parameter unit is dB.

### 5. Op1–Op2+Ref

Operand 1 (Op1) minus Operand 2 (Op2), and then plus the reference (Reference). Then, saves the result to the destination trace. During the sweep, the following formula is executed for each point:

$$Trace_{result} = Op1 - Op2 + Reference \quad (2-14)$$

In the formula, the unit for Op1, Op2, and Reference is dBm.

### 6. Off

Disables the math function.

**Note:** The trace math functions are mutually exclusive. If you apply one math operation to a certain trace, the last selected math operation function should be disabled.

## Op1

Selects Operand 1 to be used for the trace math functions. Operand 2 can be configured with Trace1, Trace2, Trace3, Trace4, Trace5, or Trace6.

## Op2

Selects Operand 2 to be used for the trace math functions. Operand 2 can be configured with Trace1, Trace2, Trace3, Trace4, Trace5, or Trace6.

**Note:** The currently display trace does not involve in math operation.

## Offset

Sets the log offset in the math operation function. The unit is dB.

**Note:** This menu is only valid when you select "Op1+Offset" or "Op1-Offset" to be the math type.

Table 2-22 Offset

Parameter	Remarks
<b>Default</b>	0 dB
<b>Range</b>	-100 dB to 100 dB
<b>Unit</b>	dB
<b>Knob Step</b>	1 dB
<b>Left/Right Arrow Key Step</b>	
<b>Up/Down Arrow Key Step</b>	10 dB

## Reference

Sets the log reference difference in the math operation function. The unit is dBm.

**Note:** This menu is only valid when you select the "Op1-Op2+Ref" operation function.

Table 2-23 Reference

Parameter	Remarks
<b>Default</b>	0 dB
<b>Range</b>	-170 dB to 30 dB
<b>Unit</b>	dB
<b>Knob Step</b>	1 dB
<b>Left/Right Arrow Key Step</b>	
<b>Up/Down Arrow Key Step</b>	5 dB

## Preset All

Turns on Trace 1, and blanks all other traces. This operation does not affect the trace type, trace detector, and other states.

## Clear All

Clears all traces. All the trace data will be set to the minimum trace value (except the case that the trace is in Min Hold state). When the trace is in Min Hold state, the trace data will be set to the maximum trace value. That is, even if you turn off the trace update, the trace data will be updated after you perform the "Clear All" operation.

## Tracking Generator (Option)

Sets the parameter related to the tracking generator (TG). This function is only available for RSA5065-TG/RSA5032-TG.

### Tracking Generator

Enables or disables the tracking generator.

When the tracking generator is enabled, a signal with the same frequency as that of the current sweep signal will be output from the **[GEN OUTPUT 50Ω]** connector on the front panel. The power of the signal can be set through the menu.

### Amplitude

Sets the output power of the tracking generator signal.

You can use the numeric keys, the knob, and the arrow keys on the front panel to modify this parameter; also you can modify it on the touchscreen. For details, refer to descriptions in "**Parameter Setting**".

Table 2-24 Tracking Generator Output Signal Amplitude

Parameter	Remarks
Default	-40 dBm
Range	-40 dBm to 0 dBm
Unit	dBm, -dBm, mV, uV
Knob Step	1 dBm
Left/Right Arrow Key Step	
Up/Down Arrow Key Step	10 dBm

### Amplitude Offset

Sets the offset of the output power of the tracking generator when gains or losses occur between the TG output and external device, so as to display the actual power value.

#### Remarks:

- This parameter only changes the readout of the tracking generator output power, rather than the actual output power.
- The offset could be either a positive (gain in the external output) or a negative (loss in the external output) value.
- You can use the numeric keys, the knob, and the arrow keys on the front panel to modify this parameter; also you can modify it on the touchscreen. For details, refer to descriptions in "**Parameter Setting**".

Table 2-25 Tracking Generator Output Amplitude Offset

Parameter	Remarks
Default	0 dB
Range	-200 dB to 200 dB
Unit	dB
Knob Step	1 dB
Left/Right Arrow Key Step	
Up/Down Arrow Key Step	10 dB

## Normalize

Before enabling the normalize function, connect the tracking generator output terminal [**Gen Output 50Ω**] to the RF input terminal [**RF Input 50Ω**]. Normalization can eliminate the error of tracking generator output amplitude.

**Note:** Only when Output under the **TG** menu is "On" and the current Y-axis scale is log, can the Normalize menu be enabled.

### 1. Normalize

Enables or disables the normalize function. If no saving operation is performed on the reference trace before enabling the normalize function, the next time you enable the function, the analyzer will save the reference trace automatically after it completes the current sweep. During saving the reference trace, a prompt message will be displayed. When the normalize function is enabled, the corresponding value of the reference trace will be subtracted from the trace data after every sweep.

### 2. Reference Level

After the normalize function is enabled, you can adjust the vertical position of the trace on the screen by adjusting the reference level.

- Different from the **Ref Level** sub-menu under **AMPT**, the parameter "Reference Level" under "Normalize" will not affect the reference level of the analyzer once it is modified.
- You can use the numeric keys, the knob, and the arrow keys on the front panel to modify this parameter; also you can modify it on the touchscreen. For details, refer to descriptions in "**Parameter Setting**".

Table 2-26 Normalization Reference Level

Parameter	Remarks
Default	0 dB
Range	-200 dB to 200 dB
Unit	dB
Knob Step	1 dB
Left/Right Arrow Key Step	
Up/Down Arrow Key Step	10 dB

### 3. Reference Position

After the normalize function is enabled, you can adjust the vertical position of **Reference Level** on the screen by adjusting the reference position.

- The function of this menu is similar to that of Reference Level. When it is set to 0%, Reference Level is displayed at the bottom of the graticule and at the top line of the graticule when it is set to 100%.
- You can use the numeric keys, the knob, and the arrow keys on the front panel to modify this parameter; also you can modify it on the touchscreen. For details, refer to descriptions in "**Parameter Setting**".

Table 2-27 Tracking Generator Reference Position

Parameter	Remarks
<b>Default</b>	100%
<b>Range</b>	0% to 100%
<b>Unit</b>	%
<b>Knob Step</b>	1%
<b>Left/Right Arrow Key Step</b>	
<b>Up/Down Arrow Key Step</b>	10%

### 4. Reference Trace

Sets whether to display the reference trace. If you set "Reference Trace" to be "On", the reference trace saved (Trace 6) will be shown.

### 5. Save Ref Trace

Saves the data of Trace1 to Trace6 as the reference value for normalization. This operation should be done before you enable the normalize function.

# Measurement Settings

## Meas

Provides swept SA and VSWR, as well as multiple advanced measurement functions, including time-domain power, adjacent channel power, multi-channel power, occupied bandwidth, emission bandwidth, C/N ratio, harmonics, and TOI.

### Swept SA

Measures with swept analysis (frequency-domain), FFT analysis (frequency-domain), or zero span analysis (time-domain).

After you select **Swept SA**, the advanced measurement function (AMK) is off by default. Press **Meas Setup** to set the corresponding parameters for swept SA.

### Advanced Measurement Function (AMK)

This function is an option for RSA5000, and the function is only available when the advanced measurement kit (AMK) is installed. When you enable the measurement function, the screen is divided into two windows, with the upper window (the basic measurement window) displaying the sweep trace and the lower window displaying the measurement results.

#### 1. Meas Off

Disables the advance measurement function and returns to the swept SA interface in GPSA mode.

#### 2. T-Power

The system enters the zero span mode and calculates the power within the time domain. The available power types include Peak, Average, and RMS.

Select **T-Power** and then press **Meas Setup** to set the corresponding parameters.

#### 3. ACP

Measures the power of the main channel, the power of adjacent channels, and the power difference between the main channel and each of the adjacent channels. When this function is enabled, the span and resolution bandwidth of the analyzer will be adjusted to smaller values automatically.

Select **ACP** and then press **Meas Setup** to set the corresponding parameters.

#### 4. Multichan Pwr

Measures the power and power density of multiple channels or that of the specified channel bandwidth. When this function is enabled, the span and

resolution bandwidth of the analyzer will be adjusted to smaller values automatically.

Select **Multichan Pwr** and then press **Meas Setup** to set the corresponding parameters.

#### 5. Occupied BW

Integrates the power within the whole span and then calculates the bandwidth occupied by this power according to the specified power ratio. The OBW function also indicates the difference (namely "Transmit Freq Error") between the center frequency of the channel and the center frequency of the analyzer. Select **Occupied BW** and then press **Meas Setup** to set the corresponding parameters.

#### 6. Emission BW

Measures the bandwidth between two points on the signal which are X dB below the highest point within the span.

Selects **Emission BW** and then press **Meas Setup** to set the corresponding parameters.

#### 7. C/N Ratio

Measures the power of the carrier and that of the noise with the specified bandwidth, as well as their power ratio.

Select **C/N Ratio** and then press **Meas Setup** to set the corresponding parameters.

#### 8. Harmo Dist

Measures the power of each order of harmonic and THD (total harmonic distortion) of the carrier. The highest order of harmonics for measurement is 10. The fundamental harmonic amplitude of the carrier signal must be greater than -50 dBm; otherwise the measurement will be invalid.

Select **Harmo Dist** and then press **Meas Setup** to set the corresponding parameters.

#### 9. TOI

Measures the third-order intercept (TOI) of a two-tone signal (with the same amplitude and similar frequency), including the frequencies and amplitudes of Lower Tone, Upper Tone, Lower 3rd TOI, and Upper 3rd TOI, as well as the intercept points of both the Lower 3rd TOI and Upper 3rd TOI.

Select **TOI** and then press **Meas Setup** to set the corresponding parameters.  
Restart



## VSWR

Enables or disables the VSWR measurement function. When the VSWR measurement function is enabled, the user interface is divided into two sections automatically (the lower section provides the measurement wizard). At this time, you can perform the VSWR measurement according to the wizard. Press **Meas Setup** to set the corresponding parameters.

**Tip:**

The VSWR bridge and tracking generator are required in VSWR measurement. Therefore, this function is only available for the instrument installed with VSWR bridge and the tracking generator option. When the VSWR measurement is enabled, the tracking generator is enabled automatically, and the backlight of **TG** on the front panel turns on.

## Meas Setup

Open the parameter setting menu of the function selected in the **Meas** menu.

### Swept SA

#### 1. Avg Number

Specifies the number of counts (N) for Average, Max Hold, and Min Hold. For Average, the greater the value of N, the smoother the trace is displayed. In Average, Max Hold, and Min Hold modes, when performing the single measurement, the instrument stops sweeping after the sweep count has reached N.

Table 2-28 Swept SA Average Count

Parameter	Remarks
Default	100
Range	1 to 10,000
Unit	None
Knob Step	1
Left/Right Arrow Key Step	
Up/Down Arrow Key Step	1

#### 2. Avg Mode

The average modes include "Log", "RMS", and "Scalar".

- **Log:** In this mode, all filtering and averaging processes select the log unit (dB). This average type is the most effective one for finding the low-level signal that is close to the noise amplitude. The formula is shown as follow:

$$NewAvg = \frac{(k - 1) \times OldAvg + Newdata}{k} \quad (2-15)$$

In the above formula, the parameter unit is dB.

- **RMS:** In this mode, all filtering and averaging processes work on the power (the square of the amplitude) of the signal. This average type is best for measuring the true time average power of complex signals. The formula is shown as follows:

$$NewAvg = 10 \log \left( \frac{(k - 1) \times 10^{\frac{OldAvg}{10}} + 10^{\frac{Newdata}{10}}}{k} \right) \quad (2-16)$$

In the above formula, the parameter unit is dB.

- **Scalar:** In this mode, all filtering and averaging processes work on the voltage envelope of the signal. This average type is the most appropriate one for observing the great envelope fluctuations of AM or pulse-modulated signals such as radar and TDMA transmitters. The formula is shown as follows:

$$NewAvg = 20 \log \left( \frac{(k-1) \times 10^{\frac{OldAvg}{20}} + 10^{\frac{Newdata}{20}}}{k} \right) \quad (2-17)$$

In the above formula, the parameter unit is dB.

### 3. Avg State

Enables or disables the auto average function. When the auto average function is enabled, the instrument will select the best average type based on the current settings. When you select one of the average types manually, the instrument will apply the selected type, and the auto average function is disabled automatically.

### 4. Limit

Sets the parameters of limit lines. After you press **Preset**, the limit line measurement function is disabled, but the data of the limit lines will be reserved. The limit line data will only be deleted when the loading mode is Default. When you exit the measurement mode, the limit line data will not be deleted.

#### 1) Test Limits

Selects whether the displayed traces are tested against the corresponding limit lines. For each displayed trace, the corresponding limit line is turned on, and a message will be displayed at the upper-left corner of the trace to indicate whether the test passes or fails.

#### 2) Select Limit

Selects the current limit line. By default, it is Limit1.

#### 3) Limit State

Enables or disables the display of the limit line. When the limit line is on, the measurement interface displays the limit line, and the corresponding traces are tested based on the current limit lines. Each limit line is displayed in a different color.

#### 4) Edit Limit

When "Display State" of the limit line is set to "On", this menu is valid. When you press this key to enter the editing menu, open the limit editing window. Then, the current limit line will be turned on. Close the peak table, and open the trace that corresponds to the limit line.

- **Type:** Selects the type of the current limit line to be "Upper" or "Lower". If the trace amplitude is greater than the amplitude of the upper limit line and smaller than that of the lower limit line, then the test fails.
- **X To CF:** When "Fixed" is selected, the frequency of the current editing point will not be affected by the center frequency. When "Relative" is selected, the frequency of the current editing point is the difference between the frequency of the point and the current center frequency. At this time, if the center frequency changes, then the position of the

- current editing point changes along with the center frequency.
- **Y To Ref:** When "Fixed" is selected, the amplitude of the current editing point will not be affected by the reference level. When "Relative" is selected, the amplitude of the current editing point is the difference between the amplitude of the point and that of the current reference level. At this time, if the reference level changes, then the position of the current editing point changes along with the reference level.
  - **Margin State:** Enables or disables the display of the margin. When you enable the display of the margin, the measurement interface displays the margin lines; when you disable the display of the margin, the margin is invalid.
  - **Margin:** Sets the margin for the current limit line.
  - **Navigation:** Selects the first line of the limit line table.
  - **Frequency:** Edits the frequency of the current point. When Rel Freq is selected, edit the frequency difference between the frequency of the current point and the center frequency.
  - **Amplitude:** Edits the amplitude of the current point. If the Rel Ampt is enabled, edit the amplitude difference between the amplitude of the current point and the reference level.
  - **Append Point:** Inserts an edit point.
  - **Delete Point:** Deletes the point that you are editing.
  - **Build From:** Sets a trace for building the limit line. The range is from Trace1 to Trace6.
  - **Build:** Builds the limit line from the selected trace.
  - **Copy From:** Copies the selected limit line into the current limit line. The range is from Limit1 to Limit6.
  - **Copy:** Performs the limit line copy operation.
  - **X Offset:** Sets the frequency offset of the current limit line.
  - **Y Offset:** Sets the amplitude offset of the current limit line.
  - **Apply Offset:** Adds the X and Y offsets to each point of the current limit line, then resets the X and Y offset values to 0.

**Tip:** You can touch any point in the trace display window on the screen to edit the current point to be the limit line data point. You can also drag the point to adjust the position of the current edit point, that is, to change the frequency/amplitude of the current point.

## 5) Test Trace

Sets the trace for the current limit line test.

## 6) Delete Limit

Deletes the currently selected limit line. The data of the current limit line will be cleared and they will be restored to factory defaults.

**7) Deletes All Limits**

Deletes all limit lines. After you press the menu, the data of all the limit lines will be cleared and they will be restored to factory defaults.

**5. Auto Couple**

When you enable "Auto Couple" function, all the manual/auto settings in the current measurement mode will be set to "Auto". This operation does not affect other measurement modes.

In auto state, the auto coupled parameters are changed with their coupled parameters. The auto coupling operation will ensure the optimal performance of the instrument. After the operation, all the auto coupled parameters will immediately be automatically reset based on the coupled parameters.

**6. Meas Preset**

Restores all parameters of the current measurement mode to their factory default values.

## Time-domain Power (T-Power)

### Measurement Interface:

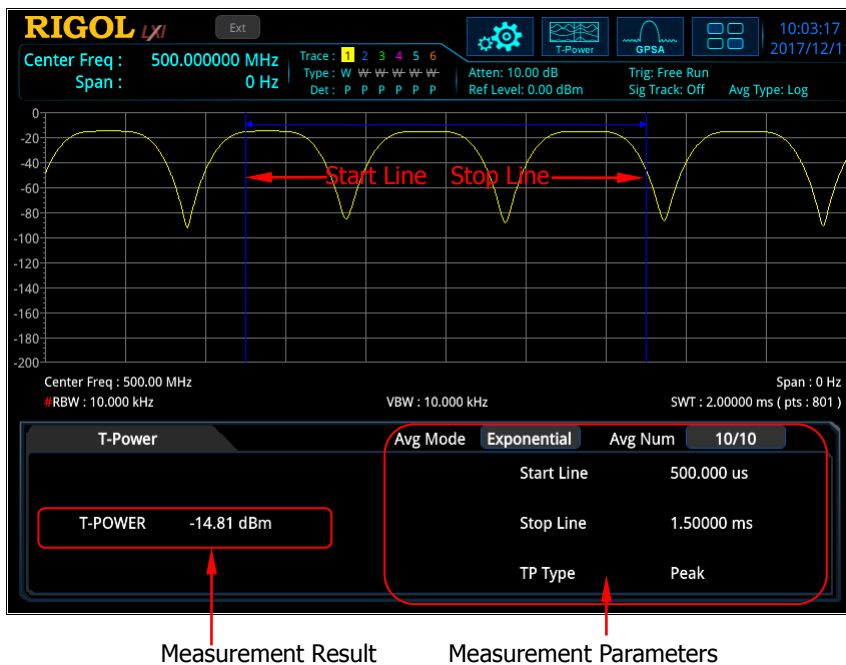

Figure 2-5 T-Power Measurement Interface

**Measurement Result:** T-power, i.g. the power of the signal from the start line to stop line.

**Measurement Parameters:** average count, average mode, average auto, power type, start line, and stop line.

#### 1. Avg Number

Specifies the number of times for averaging the measurement results. You can use the numeric keys, the knob, or arrow keys to modify this parameter; you can also use the touch screen to modify the parameter.

Table 2-29 Average Count of T-Power Measurement

Parameter	Remarks
<b>Default</b>	10
<b>Range</b>	1 to 1,000
<b>Unit</b>	None
<b>Knob Step</b>	1
<b>Left/Right Arrow Key Step</b>	
<b>Up/Down Arrow Key Step</b>	

## 2. Avg Mode

Sets the average mode to "Exponential" or "Repeat". The default average mode is "Exponential".

- When "Exponential" is selected, the result is the exponential average of the measurement results obtained in the past N times (N is specified in "**Avg Number**").
- When "Repeat" is selected, the result is the arithmetic average of the measurement results obtained in the past N times (N is specified in "**Avg Number**").

## 3. Avg State

Selects whether to auto averaging the measurement results. By default, it is set to "On".

## 4. TP Type

- **Peak**  
Displays the power of the signal (with the maximum amplitude) between the start line and stop line. The detector type is set to "Pos Peak" automatically.
- **Average**  
Displays the average power of signals between the start line and stop line. The detector type is set to "Voltage Avg" automatically.
- **RMS**  
Displays the root mean square value (expressed in W) of the voltages of signals between the start line and stop line. The detector type is set to "RMS Avg" automatically.

## 5. Start Line

Sets the left margin (in time unit) of T-Power measurement. The calculation range for the data of T-Power measurement is from the start line to the stop line. You can use the numeric keys, the knob, or arrow keys to modify this parameter; you can also use the touch screen to modify the parameter.

Table 2-30 Start Line for T-Power Measurement

Parameter	Remarks
<b>Default</b>	0 $\mu$ s
<b>Range</b>	0 $\mu$ s to (current value of stop line)
<b>Unit</b>	s, ms, $\mu$ s, ns, ps
<b>Knob Step</b>	sweep time/600, Min = 1 $\mu$ s
<b>Left/Right Arrow Key Step</b>	
<b>Up/Down Arrow Key Step</b>	at 1-1.5-2-3-5-7.5 step

## 6. Stop Line

Sets the right margin (in time unit) of T-Power measurement. The calculation range for the data of T-Power measurement is from the start line to the stop line.

You can use the numeric keys, the knob, or arrow keys to modify this parameter; you can also use the touch screen to modify the parameter.

Table 2-31 Stop Line for T-Power Measurement

Parameter	Remarks
<b>Default</b>	1 ms
<b>Range</b>	current value of start line to current value of sweep time
<b>Unit</b>	s, ms, $\mu$ s, ns, ps
<b>Knob Step</b>	sweep time/600, Min = 1 $\mu$ s
<b>Left/Right Arrow Key Step</b>	
<b>Up/Down Arrow Key Step</b>	at 1-1.5-2-3-5-7.5 step

## 7. Auto Couple

When you enable "Auto Couple" function, all the manual/auto settings in the current measurement mode will be set to "Auto".

In auto state, the auto coupled parameters are changed with their coupled parameters. The auto coupling operation will ensure the optimal performance of the instrument. After the operation, all the auto coupled parameters will immediately be automatically reset based on the coupled parameters.

## 8. Meas Preset

Restores all parameters of the current measurement mode to their factory default values.



## ACP

### Measurement Interface:

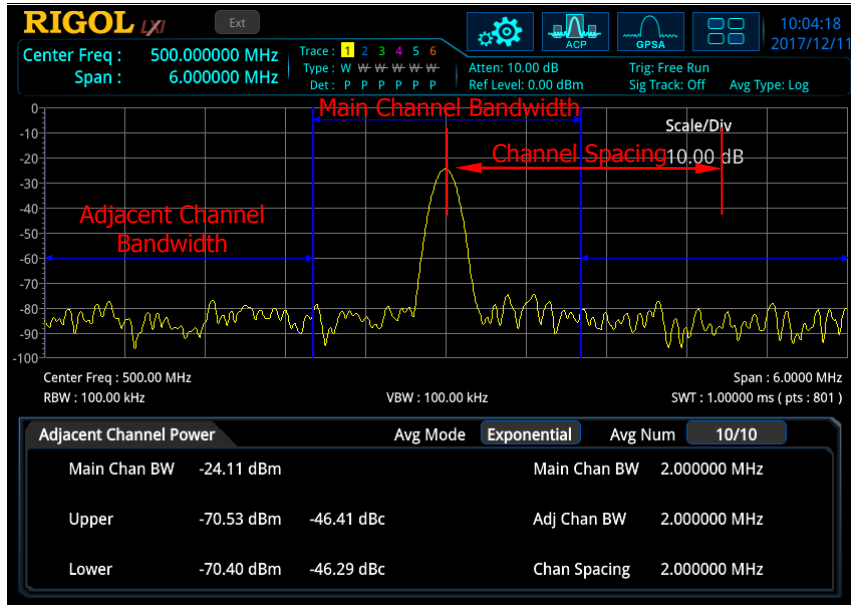

Figure 2-6 Adjacent Channel Power Measurement Interface

**Measurement Results:** main channel power, upper-adjacent channel power, and lower-adjacent channel power.

- Main channel power: displays the power within the bandwidth of the main channel.
- Upper: displays the power of the upper channel and the power difference between the upper channel and the main channel (in dBc).
- Lower: displays the power of the lower channel and the power difference between the lower channel and the main channel (in dBc).

**Measurement Parameters:** average count, average mode, auto average, main channel bandwidth, adjacent channel bandwidth, and channel spacing.

#### 1. Avg Number

Specifies the number of times for averaging the measurement results. You can use the numeric keys, the knob, or arrow keys to modify this parameter; you can also use the touch screen to modify the parameter.

Table 2-32 Average Count of ACP Measurement

Parameter	Remarks
<b>Default</b>	10
<b>Range</b>	1 to 1,000
<b>Unit</b>	None
<b>Knob Step</b>	1
<b>Left/Right Arrow Key Step</b>	1
<b>Up/Down Arrow Key Step</b>	1

## 2. Avg Mode

Sets the average mode to "Exponential" or "Repeat". The default average type is "Exponential".

- When "Exponential" is selected, the result is the exponential average of the measurement results obtained in the past N times (N is specified in "**Avg Number**").
- When "Repeat" is selected, the result is the arithmetic average of the measurement results obtained in the past N times (N is specified in "**Avg Number**").

## 3. Avg State

Selects whether to averaging the measurement results. By default, it is set to "On".

## 4. Main Chan BW

Sets the bandwidth of the main channel, and the power of the main channel is the power integral within this bandwidth. You can use the numeric keys, the knob, or arrow keys to modify this parameter; you can also use the touch screen to modify the parameter.

Table 2-33 Main Channel Bandwidth for ACP Measurement

Parameter	Remarks
<b>Default</b>	2 MHz
<b>Range</b>	33 Hz to 2.5 GHz
<b>Unit</b>	GHz, MHz, kHz, Hz
<b>Knob Step</b>	main channel bandwidth/100, Min = 1 Hz
<b>Left/Right Arrow Key Step</b>	
<b>Up/Down Arrow Key Step</b>	at 1-1.5-2-3-5-7.5 step

## 5. Adj Chan BW

Sets the frequency width of the adjacent channels.

- The adjacent channel bandwidth is related to the main channel bandwidth, and the settable range is from (main channel bandwidth/20) to (main channel bandwidth x 20).
- You can use the numeric keys, the knob, or arrow keys to modify this parameter; you can also use the touch screen to modify the parameter.

Table 2-34 Adjacent Channel Bandwidth for ACP Measurement

Parameter	Remarks
<b>Default</b>	2 MHz
<b>Range</b>	33 Hz to 2.5 GHz
<b>Unit</b>	GHz, MHz, kHz, Hz
<b>Knob Step</b>	adjacent channel bandwidth/100,
<b>Left/Right Arrow Key Step</b>	Min = 1 Hz
<b>Up/Down Arrow Key Step</b>	at 1-1.5-2-3-5-7.5 step

## 6. Chan Spacing

Sets the spacing between the center frequency of the main channel and that of the adjacent channels.

- Adjusting this parameter will also adjust the distance between the upper/lower channel and the main channel.
- You can use the numeric keys, the knob, or arrow keys to modify this parameter; you can also use the touch screen to modify the parameter.

Table 2-35 Channel Spacing for ACP Measurement

Parameter	Remarks
<b>Default</b>	2 MHz
<b>Range</b>	33 Hz to 2.5 GHz
<b>Unit</b>	GHz, MHz, kHz, Hz
<b>Knob Step</b>	channel spacing/100, Min = 1 Hz
<b>Left/Right Arrow Key Step</b>	
<b>Up/Down Arrow Key Step</b>	at 1-1.5-2-3-5-7.5 step

For details about the **Auto Couple** and **Meas Preset** menus, refer to their descriptions on Page 2-44.

## Multichan Pwr

### Measurement Interface:

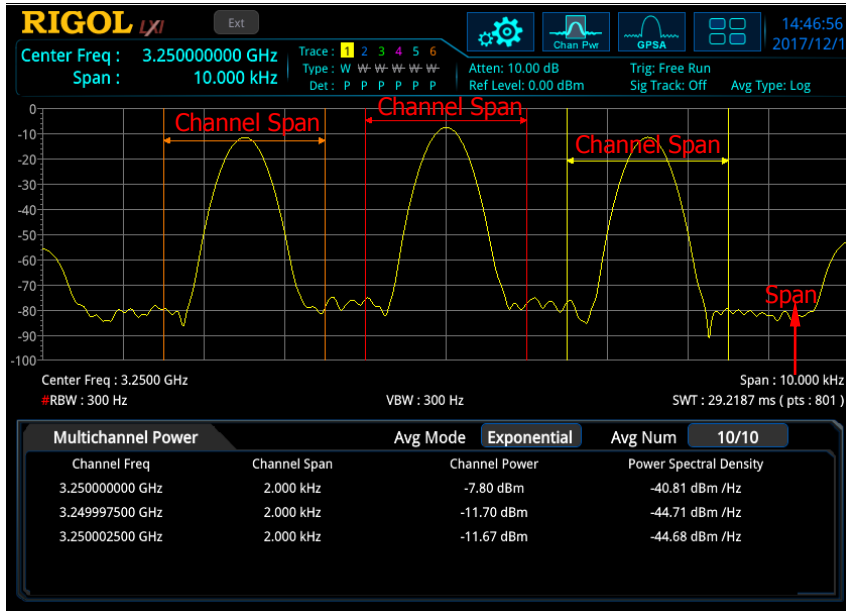

Figure 2-7 Multi-channel Power Measurement Interface

### Measurement Results: channel power and power spectral density

- Channel Power: power within the channel span.
- Power Spectral Density: power (in dBm/Hz) normalized to 1 Hz within the channel span.

**Measurement Parameters:** average count, average mode, auto average, channel frequency, and channel span.

#### 1. Avg Number

Specifies the number of times for averaging the measurement results. You can use the numeric keys, the knob, or arrow keys to modify this parameter; you can also use the touch screen to modify the parameter.

Table 2-36 Average Count for Multi-channel Power Measurement

Parameter	Remarks
<b>Default</b>	10
<b>Range</b>	1 to 1,000
<b>Unit</b>	None
<b>Knob Step</b>	1
<b>Left/Right Arrow Key Step</b>	1
<b>Up/Down Arrow Key Step</b>	1

## 2. Avg Mode

Sets the average mode to "Exponential" or "Repeat". The default average mode is "Exponential".

- When "Exponential" is selected, the result is the exponential average of the measurement results obtained in the past N times (N is specified in "**Avg Number**").
- When "Repeat" is selected, the result is the arithmetic average of the measurement results obtained in the past N times (N is specified in "**Avg Number**").

## 3. Avg State

Selects whether to averaging the measurement results. By default, it is set to "On".

## 4. Edit Channel

### 1) Channel Sheet

Opens or closes the channel editing table. When you select "On", the screen is split into two sections. The left section displays a channel editing table, and the right section displays the traces.

### 2) Navigations

Selects the first line of the channel editing table.

Note that when you select "Off" under **Channel Sheet**, this menu is invalid.

### 3) Channel Frequency

- In the channel editing table, when a channel is selected, this menu displays the center frequency of the selected channel. If you modify the frequency at this time, the center frequency of the corresponding selected channel will be updated at the same time.
- When no channel is selected in the channel editing table, this menu displays the center frequency of the last selected channel. At this time, you can set the center frequency of the channel according to your needs, and then press **Add Channel** to add a channel.

### 4) Channel Span

Sets the frequency width of the channel to be tested, and the power of the channel is the power integral within this bandwidth. You can use the numeric keys, the knob, or arrow keys to modify this parameter; you can also use the touch screen to modify the parameter.

- In the channel editing table, when a channel is selected, this menu displays the channel span of the selected channel. If you modify the span at this time, the span of the corresponding selected channel will be updated at the same time.
- When no channel is selected in the channel editing table, this menu displays the span of the last selected channel. At this time, you can set

the span of the channel according to your needs, and then press **Add Channel** to add a channel.

Table 2-37 Channel Span

Parameter	Remarks
<b>Default</b>	3 GHz
<b>Range</b>	10 Hz to $2 * \text{Min}[(\text{channel frequency} - \text{start frequency}), (\text{stop frequency} - \text{channel frequency})]$
<b>Unit</b>	GHz, MHz, kHz, Hz
<b>Knob Step</b>	channel span/100, Min = 1 Hz
<b>Left/Right Arrow Key Step</b>	
<b>Up/Down Arrow Key Step</b>	at 1-1.5-2-3-5-7.5 step

### 5) Add Channel

- If a channel is selected in the table editing table, pressing this key can add a channel that is the same as the selected channel to the table.
- When no channel is selected in the channel editing table, pressing this key can add a channel whose center frequency is the same as the value under **Channel Freq** and whose span is the same as the value under **Channel Span**.

Note that when you select "Off" under **Channel Sheet**, this **Add Channel** menu is also valid.

### 6) Delete Channel

Press this key to delete the currently selected channel.

Note that when you select "Off" under **Channel Sheet** or no channel is selected, this **Delete Channel** menu is invalid.

### 7) Deletes All Channels

Press **Del All Channel** to clear data in the channel editing table, i.g. deleting all the channels.

Note that when you select "Off" under **Channel Sheet**, this **Del All Channel** menu is also valid.

For details about the **Auto Couple** and **Meas Preset** menus, refer to their descriptions on Page 2-44.

## Occupied BW

### Measurement Interface:

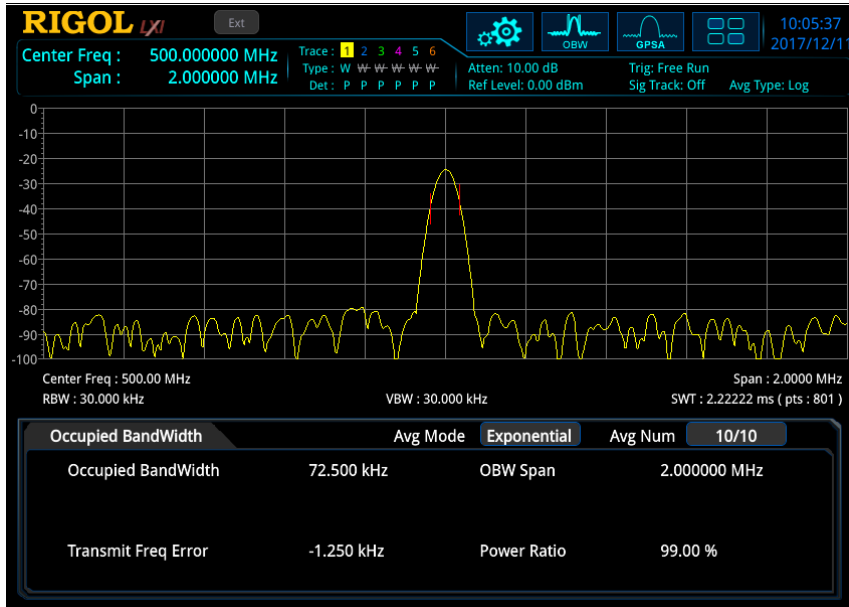

Figure 2-8 OBW Measurement Interface

**Measurement Results:** occupied bandwidth and transmit frequency error.

- **OBW:** Use the integral calculation method to calculate the power within the whole span, and then calculate the bandwidth occupied by the power based on the specified power ratio.
- **Transmit Frequency Error:** indicates the difference between the center frequency of the channel and that of the spectrum analyzer.

**Measurement Parameters:** average count, average mode, auto average, max hold, span, and power ratio.

#### 1. Avg Number

Specifies the number of times for averaging the measurement results. You can use the numeric keys, the knob, or arrow keys to modify this parameter; you can also use the touch screen to modify the parameter.

Table 2-38 Average Count for OBW Measurement

Parameter	Remarks
Default	10
Range	1 to 1000
Unit	None
Knob Step	1
Left/Right Arrow Key Step	1
Up/Down Arrow Key Step	1

## 2. Avg Mode

Sets the average mode to "Exponential" or "Repeat". The default average mode is "Exponential".

- When "Exponential" is selected, the result is the exponential average of the measurement results obtained in the past N times (N is specified in "**Avg Number**").
- When "Repeat" is selected, the result is the arithmetic average of the measurement results obtained in the past N times (N is specified in "**Avg Number**").

## 3. Avg State

Selects whether to averaging the measurement results. By default, it is set to "On".

## 4. Max Hold

Enables or disables max hold. By default, it is "Off".

- When Max Hold is enabled, each measurement result is compared with the previous result, and then display whichever is the maximum.
- When Max Hold is disabled, the current measurement result is displayed.
- Max Hold and average measurement mode are mutually exclusive. When Max Hold is enabled, the average measurement mode will be automatically disabled.

## 5. OBW Span

Sets the frequency range of integral calculation. The span is consistent with that of the spectrum analyzer. It is the frequency range of sweep. After it is set, the span of the spectrum analyzer will also be changed. You can use the numeric keys, the knob, or arrow keys to modify this parameter; you can also use the touch screen to modify the parameter.



Table 2-39 Span for OBW Measurement

Parameter	Remarks
<b>Default</b>	2 MHz
<b>Range</b>	10 Hz to 6.5 GHz
<b>Unit</b>	GHz, MHz, kHz, Hz
<b>Knob Step</b>	OBW span/100, Min = 1 Hz
<b>Left/Right Arrow Key Step</b>	
<b>Up/Down Arrow Key Step</b>	
	at 1-1.5-2-3-5-7.5 step

## 6. Power Ratio

Sets the percentage the signal power takes up in the whole span power. You can use the numeric keys, the knob, or arrow keys to modify this parameter; you can also use the touch screen to modify the parameter.

Table 2-40 Power Ratio for OBW Measurement

Parameter	Remarks
<b>Default</b>	99%
<b>Range</b>	1% to 99.99%
<b>Unit</b>	%
<b>Knob Step</b>	0.01%
<b>Left/Right Arrow Key Step</b>	
<b>Up/Down Arrow Key Step</b>	
	1%

For details about the **Auto Couple** and **Meas Preset** menus, refer to their descriptions on Page 2-44.

## Emission Bandwidth (EBW)

### Measurement Interface:

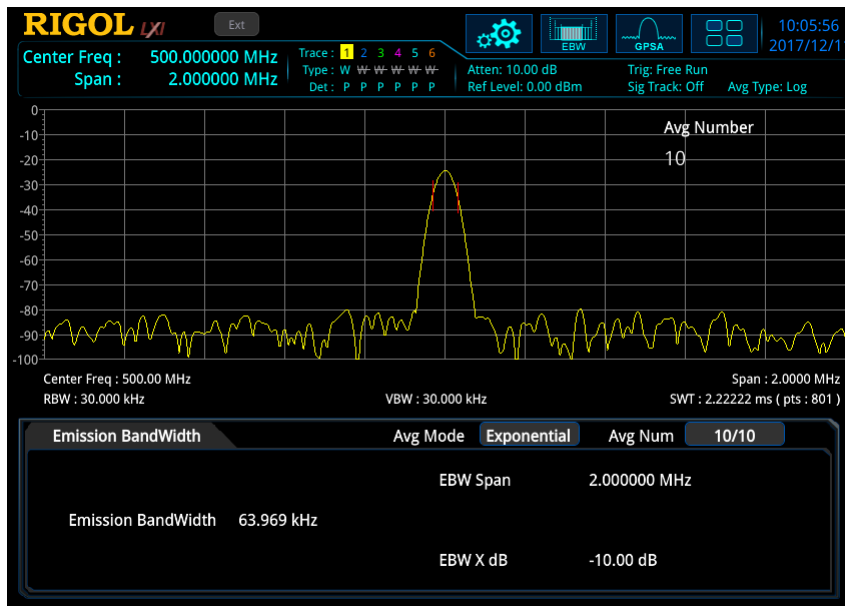

Figure 2-9 EBW Measurement Interface

**Measurement Results:** EBW, i.g. the bandwidth between two points on the signal which are X dB below the highest point within the span. During the measurement, the analyzer first determines the frequency ( $f_0$ ) of the maximum amplitude point within the span, and then finds the two frequency points ( $f_1$  and  $f_2$ ) at the left and right side of  $f_0$  at which the signal amplitude is X dB below the maximum amplitude. The EBW equals to  $f_2 - f_1$ .

**Measurement Parameters:** average count, average mode, auto average, max hold, span, and X dB.

#### 1. Avg Number

Specifies the number of times for averaging the measurement results. You can use the numeric keys, the knob or arrow keys to modify this parameter.

Table 2-41 Average Count for EBW Measurement

Parameter	Remarks
Default	10
Range	1 to 1,000
Unit	None
Knob Step	1
Left/Right Arrow Key Step	
Up/Down Arrow Key Step	

## 2. Avg Mode

Sets the average mode to "Exponential" or "Repeat". The default average mode is "Exponential".

- When "Exponential" is selected, the result is the exponential average of the measurement results obtained in the past N times (N is specified in "**Avg Number**").
- When "Repeat" is selected, the result is the arithmetic average of the measurement results obtained in the past N times (N is specified in "**Avg Number**").

## 3. Avg State

Selects whether to averaging the measurement results. By default, it is set to "On".

## 4. Max Hold

Enables or disables max hold. By default, it is "Off".

- When Max Hold is enabled, each measurement result is compared with the previous result, and then display whichever is the maximum.
- When Max Hold is disabled, the current measurement result is displayed.
- Max Hold and average measurement mode are mutually exclusive. When Max Hold is enabled, the average measurement mode will be automatically disabled.

## 5. EBW Span

This span is consistent with the span of the spectrum analyzer. It refers to the frequency range of the sweep. After it is set, the span of the spectrum analyzer will be modified accordingly. You can use the numeric keys, the knob, or arrow keys to modify this parameter; you can also use the touch screen to modify the parameter.

Table 2-42 Span for EBW Measurement

Parameter	Remarks
<b>Default</b>	2 MHz
<b>Range</b>	10 Hz to 6.5 GHz
<b>Unit</b>	GHz, MHz, kHz, Hz
<b>Knob Step</b>	EBW span/100, Min = 1 Hz
<b>Left/Right Arrow Key Step</b>	
<b>Up/Down Arrow Key Step</b>	at 1-1.5-2-3-5-7.5 step

## 6. EBW X dB

Sets the value of X dB, which is used for EBW calculation. You can use the numeric keys, the knob, or arrow keys to modify this parameter; you can also use the touch screen to modify the parameter.

Table 2-43 X dB for EBW Measurement

Parameter	Remarks
Default	-10 dB
Range	-100 dB to -0.1 dB
Unit	dB
Knob Step	0.1 dB
Left/Right Arrow Key Step	
Up/Down Arrow Key Step	1 dB

For details about the **Auto Couple** and **Meas Preset** menus, refer to their descriptions on Page 2-44.

## C/N Ratio (CNR)

### Measurement Interface:

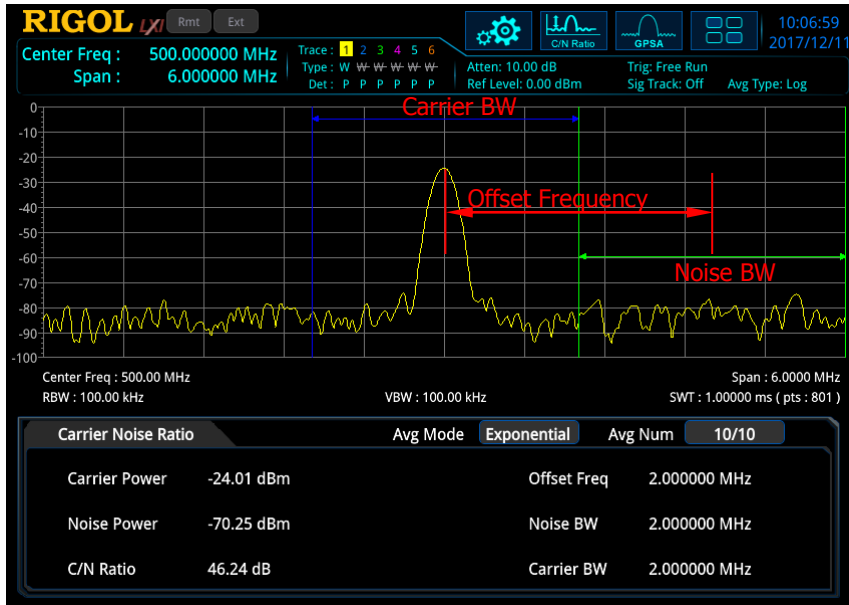

Figure 2-10 C/N Ratio Measurement Interface

**Measurement Results:** carrier power, noise power, and C/N ratio.

- Carrier Power: power within the carrier bandwidth.
- Noise Power: power within the noise bandwidth.
- C/N Ratio: the ratio of the carrier power to the noise power.

**Measurement Parameters:** average count, average mode, auto average, offset frequency, noise BW, and carrier bandwidth.

#### 1. Avg Number

Specifies the number of times for averaging the measurement results. You can use the numeric keys, the knob, or arrow keys to modify this parameter; you can also use the touch screen to modify the parameter.

Table 2-44 Average Count for C/N Ratio Measurement

Parameter	Remarks
<b>Default</b>	10
<b>Range</b>	1 to 1,000
<b>Unit</b>	None
<b>Knob Step</b>	1
<b>Left/Right Arrow Key Step</b>	
<b>Up/Down Arrow Key Step</b>	

**2. Avg Mode**

Sets the average mode to "Exponential" or "Repeat". The default average mode is "Exponential".

- When "Exponential" is selected, the result is the exponential average of the measurement results obtained in the past N times (N is specified in "**Avg Number**").
- When "Repeat" is selected, the result is the arithmetic average of the measurement results obtained in the past N times (N is specified in "**Avg Number**").

**3. Avg State**

Selects whether to averaging the measurement results. By default, it is set to "On".

**4. Offset Freq**

Sets the difference between the center frequency of the carrier and that of the noise. You can use the numeric keys, the knob, or arrow keys to modify this parameter; you can also use the touch screen to modify the parameter.

Table 2-45 Frequency Offset for C/N Ratio Measurement

Parameter	Remarks
Default	2 MHz
Range	3 Hz to 2.166666 GHz
Unit	GHz, MHz, kHz, Hz
Knob Step	offset frequency/100,
Left/Right Arrow Key Step	Min = 1 Hz
Up/Down Arrow Key Step	at 1-1.5-2-3-5-7.5 step

**5. Noise BW**

Sets the bandwidth of the noise to be measured. You can use the numeric keys, the knob, or arrow keys to modify this parameter; you can also use the touch screen to modify the parameter.

Table 2-46 Noise Bandwidth for C/N Ratio Measurement

Parameter	Remarks
Default	2 MHz
Range	3 Hz to 2.166666 GHz
Unit	GHz, MHz, kHz, Hz
Knob Step	noise BW/100, Min = 1 Hz
Left/Right Arrow Key Step	
Up/Down Arrow Key Step	at 1-1.5-2-3-5-7.5 step

**6. Carrier BW**

Sets the bandwidth of the carrier to be measured.

- The carrier bandwidth is related to the noise bandwidth, and the settable

- range is from (noise bandwidth/20) to (noise bandwidth x 20).
- You can use the numeric keys, the knob, or arrow keys to modify this parameter; you can also use the touch screen to modify the parameter.

Table 2-47 Carrier Bandwidth for C/N Ratio Measurement

Parameter	Remarks
<b>Default</b>	2 MHz
<b>Range</b>	3 Hz to 2.166666 GHz
<b>Unit</b>	GHz, MHz, kHz, Hz
<b>Knob Step</b>	carrier noise/100, Min = 1 Hz
<b>Left/Right Arrow Key Step</b>	
<b>Up/Down Arrow Key Step</b>	at 1-1.5-2-3-5-7.5 step

For details about the **Auto Couple** and **Meas Preset** menus, refer to their descriptions on Page 2-44.

## Harmo Dist (THD)

### Measurement Interface:

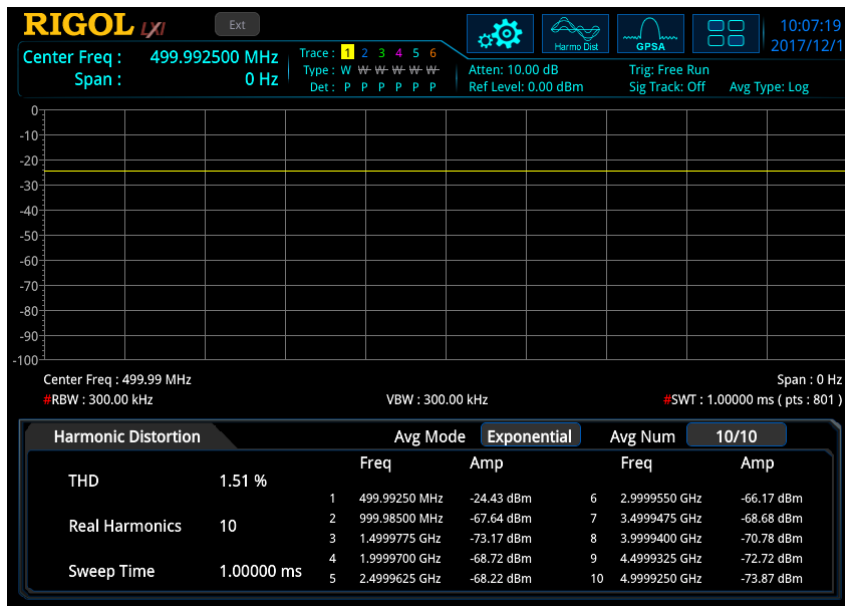

Figure 2-11 Harmonic Distortion Measurement Interface

**Measurement Results:** The amplitude of each order of harmonic and THD (total harmonic distortion) of the carrier. At most, 10th-order harmonic can be measured.  
**Measurement Parameters:** average count, average mode, auto average, number of harmonics, and sweep time.

#### 1. Avg Number

Specifies the number of times for averaging the measurement results. You can use the numeric keys, the knob, or arrow keys to modify this parameter; you can also use the touch screen to modify the parameter.

Table 2-48 Average Count for Harmo Dist Measurement

Parameter	Remarks
Default	10
Range	1 to 1,000
Unit	None
Knob Step	1
Left/Right Arrow Key Step	
Up/Down Arrow Key Step	

#### 2. Avg Mode

Sets the average mode to "Exponential" or "Repeat". The default average mode



is "Exponential".

- When "Exponential" is selected, the result is the exponential average of the measurement results obtained in the past N times (N is specified in "**Avg Number**").
- When "Repeat" is selected, the result is the arithmetic average of the measurement results obtained in the past N times (N is specified in "**Avg Number**").

### 3. Avg State

Selects whether to averaging the measurement results. By default, it is set to "On".

### 4. No. of Harmo

Sets the number of the harmonics to be measured. It is used to calculate the total harmonic distortion. You can use the numeric keys, the knob, or arrow keys to modify this parameter; you can also use the touch screen to modify the parameter.

Table 2-49 Number of Harmonics for Harmo Dist Measurement

Parameter	Remarks
<b>Default</b>	10
<b>Range</b>	2 to 10
<b>Unit</b>	None
<b>Knob Step</b>	1
<b>Left/Right Arrow Key Step</b>	
<b>Up/Down Arrow Key Step</b>	

### 5. Harmonic ST

Sets the sweep time of the harmonic measurement, namely the sweep time of the spectrum analyzer. You can use the numeric keys, the knob, or arrow keys to modify this parameter; you can also use the touch screen to modify the parameter.

Table 2-50 Sweep Time for Harmo Dist Measurement

Parameter	Remarks
<b>Default</b>	1 ms
<b>Range</b>	1 $\mu$ s to 6 ks
<b>Unit</b>	s, ms, $\mu$ s, ns, ps
<b>Knob Step</b>	1 $\mu$ s
<b>Left/Right Arrow Key Step</b>	
<b>Up/Down Arrow Key Step</b>	

For details about the **Auto Couple** and **Meas Preset** menus, refer to their descriptions on Page 2-44.

## Third-order Intercept (TOI)

### Measurement Interface:

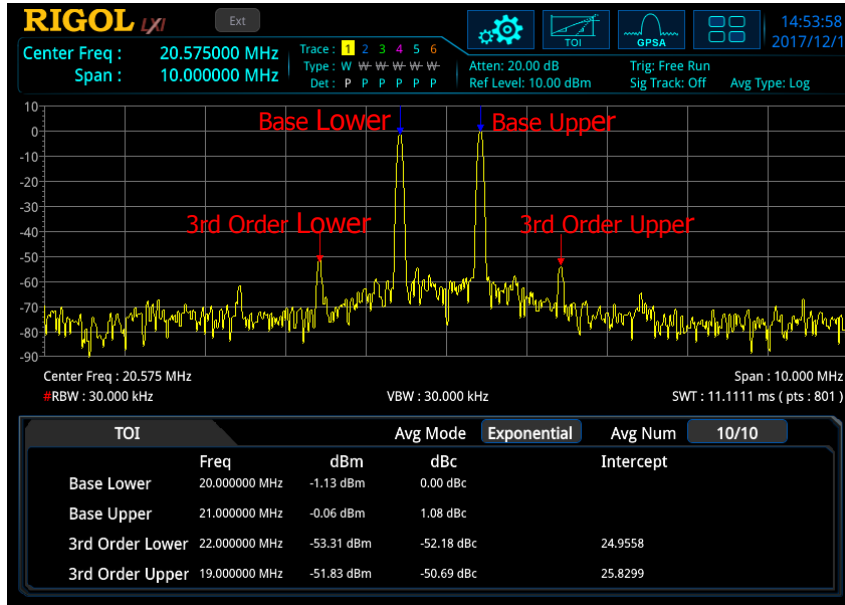

Figure 2-12 TOI Measurement Interface

### Measurement Results:

Base Lower, Base Upper, 3rd Order Lower, 3rd Order Upper, frequency and amplitude of the above four signals, the amplitude difference between each signal and the base lower signal, as well as the 3rd order intercept point (Intercept) of the base lower signal and base upper signal.

3rd order lower intercept point = (power of base lower signal - power of 3rd order lower signal) + power of base lower signal; 3rd order upper intercept point = (power of base upper signal - power of 3rd order upper signal)/2 + power of base upper signal.

**Measurement Parameters:** average count, average mode, auto average, and span.

#### 1. Avg Number

Specifies the number of times for averaging the measurement results. You can use the numeric keys, the knob, or arrow keys to modify this parameter; you can also use the touch screen to modify the parameter.

Table 2-51 Average Count for TOI Measurement

Parameter	Remarks
<b>Default</b>	10
<b>Range</b>	1 to 1,000
<b>Unit</b>	None
<b>Knob Step</b>	1
<b>Left/Right Arrow Key Step</b>	1
<b>Up/Down Arrow Key Step</b>	1

## 2. Avg Mode

Sets the average mode to "Exponential" or "Repeat". The default average mode is "Exponential".

- When "Exponential" is selected, the result is the exponential average of the measurement results obtained in the past N times (N is specified in "**Avg Number**").
- When "Repeat" is selected, the result is the arithmetic average of the measurement results obtained in the past N times (N is specified in "**Avg Number**").

## 3. Avg State

Selects whether to averaging the measurement results. By default, it is set to "On".

## 4. TOI Span

This span is consistent with the span of the spectrum analyzer. It refers to the frequency range of the sweep. After it is set, the span of the spectrum analyzer will be modified accordingly. You can use the numeric keys, the knob, or arrow keys to modify this parameter; you can also use the touch screen to modify the parameter.

Table 2-52 Span for TOI Measurement

Parameter	Remarks
<b>Default</b>	2 MHz
<b>Range</b>	10 Hz to 6.5 GHz
<b>Unit</b>	GHz, MHz, kHz, Hz
<b>Knob Step</b>	TOI distortion span/100,
<b>Left/Right Arrow Key Step</b>	Min = 1 Hz
<b>Up/Down Arrow Key Step</b>	at 1-1.5-2-3-5-7.5 step

For details about the **Auto Couple** and **Meas Preset** menus, refer to their descriptions on Page 2-44.

# VSWR

## Measurement Interface:

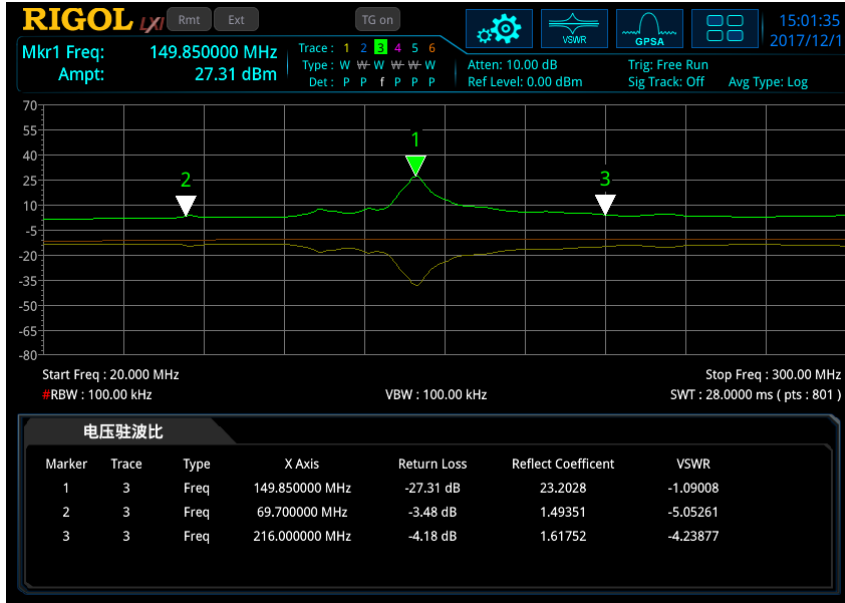

Figure 2-13 VSWR Measurement Interface

### Measurement Results: return loss, reflection coefficient, and VSWR.

- Return loss: also called reflection loss. It is calculated according to the formula:  $RL(dB) = 10 \lg(P_r/P_i)$ . Wherein,  $RL(dB)$  is return loss,  $P_i$  is incident power, and  $P_r$  is reflected power.
- Reflection coefficient: indicates the ratio of reflected voltage to the incident voltage.
- VSWR: indicates the ratio of maximum voltage to minimum voltage in standing wave pattern.

VSWR bridge and the tracking generator (RSA5065-TG/RSA5032-TG) are required during measurement. Two measurements have to be performed according to the measurement wizard at the lower section of the interface: measurement with the DUT disconnected (represented by Trace6) and measurement with the DUT connected (represented by Trace1). The return loss is determined by the difference (represented by the math trace) of the results of the two measurements. The reflection coefficient and VSWR are calculated according to the return loss.

### 1. Reset

Resets the VSWR measurement parameters to their default values.

**2. Cal Open**

After you disconnect the instrument, press this key, and then the instrument executes the first measurement. The measurement result is represented by Trace6.

**3. VSWR**

After you connect the instrument, press this key, and then the instrument executes the second measurement. The measurement result is represented by Trace1. At the same time, the analyzer calculates the difference (represented by the math trace) between the two measurement results. Then the return loss, reflection coefficient, and VSWR are calculated based on the difference.

**4. Selected Marker**

Select one of the eight markers. By default, Marker1 is selected. When a marker is selected, you can set its state. The selected marker is marked on the math trace. The measurement result at the current marker is displayed in the measurement wizard.

**5. Marker Mode**

Sets the type of the currently selected marker.

**6. Marker Freq**

Sets the frequency of the selected marker.

**7. Ref Value**

Sets the reference level to adjust the vertical position of the trace on the screen.

- Different from **Ref Level** under the **AMPT** menu, modifying this parameter does not affect the reference level of the analyzer.
- You can use the numeric keys, the knob, or arrow keys to modify this parameter; you can also use the touch screen to modify the parameter.

Table 2-53 VSWR Ref Value

Parameter	Remarks
Default	0 dB
Range	-200 dB to 200 dB
Unit	dB
Knob Step	1 dB
Left/Right Arrow Key Step	
Up/Down Arrow Key Step	

# Marker Measurement

## Marker

Marker is a triangle sign (as shown in the following figure), which is used for marking the point on the trace. Through the marker, you can read the amplitude and frequency of the point on the trace, or the sweep time point.

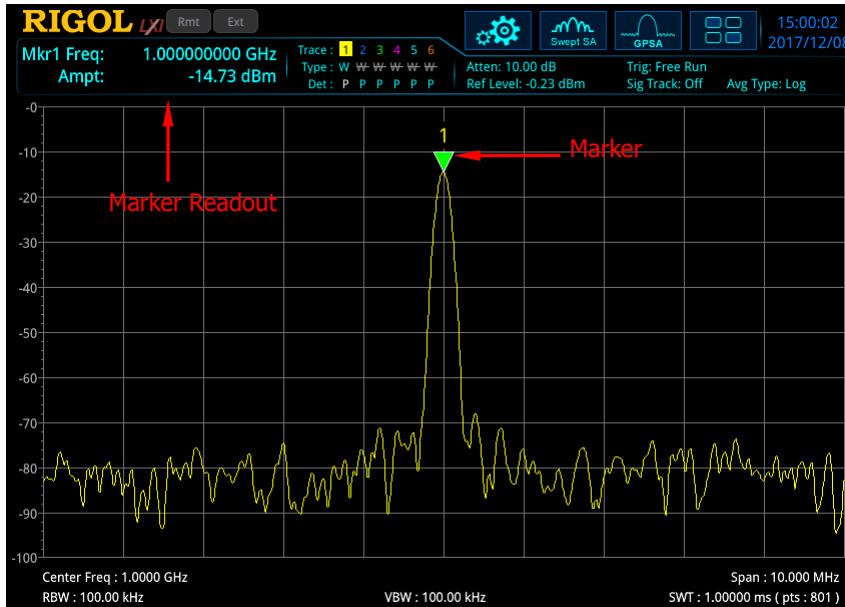

Figure 2-14 Marker

### Remarks:

- RSA5000 offers 8 markers. Each time, one marker or one pair of markers can be turned on.
- In the Marker menu, you can use the numeric keys, the knob, or the arrow keys to modify frequency or time; to view the readout of different points on the trace. You can also use the touch screen to do the above things.

## Selected Marker

RSA5000 provides 8 markers. By default, Marker1 is selected under "Selected Marker". After you select a marker, you can set parameters such as the marker mode, the marker trace, and marker readout. The currently enabled marker will be marked on the trace selected under **Marker Trace**. The readout of the currently activated marker at the marker point will be displayed in the measurement result bar at the upper-left corner of the screen.

## Marker Mode

Sets the type of the marker. The available marker modes include Position, Delta, Fixed, and Off.

### 1. Position

It is used to measure the X (Frequency or Time) and Y (Amplitude) values of a certain point on the trace. When "Position" is selected, a marker indicated by a number ("1") appears on the trace.

#### Remarks:

- If no active marker exists currently, a marker will be enabled at the center frequency of the current trace.
- The readout resolution of the X-axis (frequency or time) is related to the span. To obtain a higher readout resolution, reduce the span.

### 2. Delta

It is used to measure the difference between "reference point" and "certain point on the trace": X (frequency or time) and Y (amplitude) value. When "Delta" is selected, a pair of markers appears on the trace: Reference Marker (marked by "X") and the Delta Marker (marked by "Δ").

#### Remarks:

- If an active marker exists currently, then activate a reference marker at the current marker; otherwise activate both the reference marker and Delta marker at the same time at the center frequency.
- When you change the position of the Delta marker, the position of the reference marker remains unchanged, but the frequency (or time) difference between the two markers will change along with it.
- The frequency (or time) difference between the two markers and the amplitude difference between them are displayed in the measurement result bar at the upper-left corner of the screen.

**Application of the "Delta" Marker**

It is used to measure the S/N ratio of the single spectrum signal. Move the reference marker to the location where the signal resides, and move the Delta marker to the location where the noise resides. The amplitude displayed in the measurement results is S/N ratio.

**3. Fixed**

When you select "Fixed" marker, you can directly or indirectly set the X-axis and Y-axis values for the marker. Once specified, its position remains unchanged, and its Y-axis value does not change along with the trace. The fixed marker is generally used as the reference marker for the Delta marker. It is indicated by the sign "X".

**4. Off**

Turns off the marker currently selected. Then, the marker information displayed in the screen and the functions concerning the marker will also be disabled.

**Reference Marker**

Sets the reference marker for the current marker. By default, the reference marker is the marker next to it.

**Remarks:**

- Each marker can have another marker to be its reference marker.
- If the current marker is a Delta marker, the measurement result of the marker will be determined by the reference marker.
- Any marker cannot take itself to be the reference marker.

**Marker Trace**

Selects the trace that the current marker marks. It can be Trace1, Trace2, Trace3, Trace4, Trace5, or Trace6. One marker can only mark one trace. The selected trace determines the position of the marker, the readout unit of the marker, and the final readout results.

**Marker Trace Auto**

Enables or disables the auto marking trace function.

**Remarks:**

- When you enable the marker's auto marking trace function, the marker shifts from its off state to on state, and the marker's marking trace is automatically



- determined by the instrument.
- When you disable the marker's auto marking trace function, whatever states of the marker and the trace, the marker will be associated to the current marker trace.
- If you specify the marker's marking trace manually, the marker's auto marking trace function is automatically disabled.

## Marker Freq | Time

Sets the frequency (non-zero span) or time (zero span) of the marker to change the position of the marker on the trace. Press this key to modify the value to change the position of the marker.

Table 2-54 Marker Frequency

Parameter	Remarks
<b>Default</b>	3.25 GHz
<b>Range</b>	0 to 6.5 GHz
<b>Unit</b>	Readout = Frequency (or $1/\Delta\text{time}$ ), the available unit is GHz, MHz, kHz, or Hz. Readout = Time (or Period), the available unit is s, ms, $\mu\text{s}$ , ns, or ps.
<b>Knob Step</b>	Readout = Frequency (or $1/\Delta\text{time}$ ), step = $\text{span}/(\text{sweep points} - 1)$
<b>Left/Right Arrow Key Step</b>	Readout = Time (or Period), step = $\text{sweep time}/(\text{sweep points} - 1)$
<b>Up/Down Arrow Key Step</b>	Readout = Frequency (or $1/\Delta\text{time}$ ), step = $\text{span}/10$ Readout = Time (or Period), step = $\text{sweep time}/10$

## Marker Amplitude

When the marker type is set to "fixed", you can press this key to set the Y value of the current marker.

## Marker Readout

Selects a desired readout type of the X-axis for the marker and each marker can be configured with different readout types. This setting will change the readout type and will not change the actual value. The setting will affect the marker readouts in the measurement result bar at the upper-left corner of the screen.

### 1. Frequency

If you select "Frequency" to be the readout type, the "Position" and the "Fixed" marker modes display the absolute frequency; whereas the "Delta" marker mode displays the frequency difference between the Delta marker and the reference marker. In non-zero span mode, the default readout is "Frequency".

### 2. Time

If you select "Time" to be the readout type, the "Position" and the "Fixed" marker modes display the time difference between the marker and the start of the sweep; whereas the "Delta" marker mode displays the sweep time difference between the Delta marker and the reference marker. In zero span mode, the default readout is "Time".

### 3. I/Time

If you select "I/Time" to be the readout type, it displays the reciprocal of sweep time difference between the Delta marker and the reference marker. When the time difference is zero, the reciprocal is infinite, and "---" is displayed.

### 4. Period

If you select "Period" to be the readout type, the "Position" and the "Fixed" marker modes display the reciprocal of the marker frequency; whereas the "Delta" marker displays the reciprocal of the frequency difference. When the frequency difference is zero, the reciprocal is infinite, and "---" is displayed.

## Readout Auto

Enables or disables the readout auto function.

### Remarks:

- When you enable the function, if the trace is the frequency-domain trace, then the readout mode is frequency.
- If the marker is in auto reading state, and the marker trace changes, then the readout mode should be re-determined based on the destination trace.
- If the readout mode of X-axis is manually set, then the X-axis value will not change with the trace.

## Line State

Enables or disables the marker line.

### Remarks:

- When you enable the marker line, a cross line is displayed at the amplitude point where the marker resides. The width of the horizontal line and the height of the vertical line are consistent with the length and height of the graticule in the

waveform display area.

- If the marker is not visible in the selected area, extend the marker line to the display area for better observation. This function is useful for the marker outside the display area. The marker extension line can better display the amplitude of the marker, making it easy for you to observe and compare.

## Couple Markers

Enables or disables the couple marker function.

### Remarks:

- When this function is enabled, moving any marker will enable other markers (except the Fixed or Off marker) to move with it.
- The fixed marker does not move along with other marker, but if the fixed marker moves, other non-fixed markers will move with it.

## Marker Table

Enables or disables the marker table.

When it is set to "On", the lower section of the split screen displays all the enabled markers in the form of lists. They include marker number, trace number, marker readout type, X-axis readout, and amplitude. Through this table, you can view the measurement values of multiple points.

**Note:** The marker table currently opened can be saved to the internal or external memory, and you can recall it at any time if you need. Press **Save** to save it according to descriptions in "**Save**".

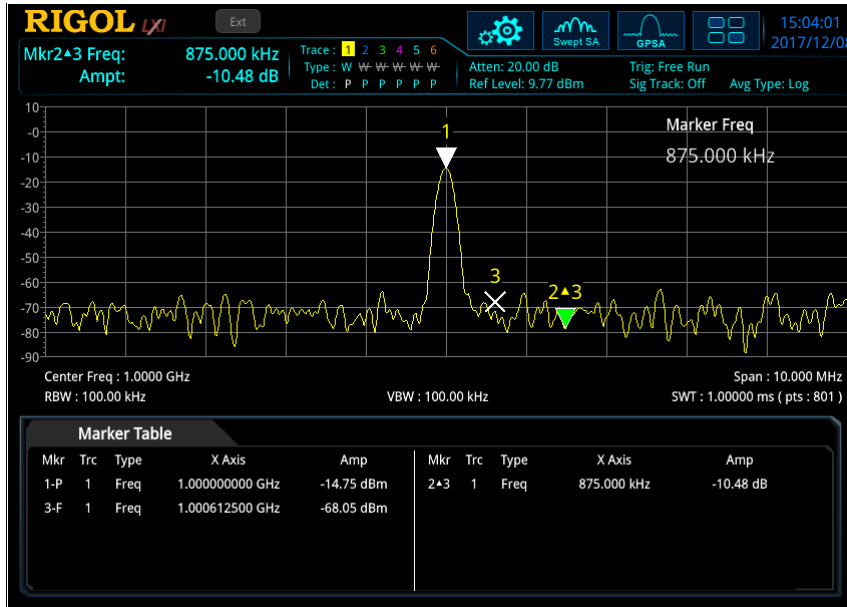

Figure 2-15 Marker Table

### Marker All Off

Turns off all the enabled markers and their related functions.

## Marker To

Sets the other system parameters (such as center frequency and reference level) by using the current marker values. Press any key under **Marker To** to activate a marker automatically if no marker is currently enabled.

### Mkr->CF

Sets the center frequency of the analyzer to the frequency of the current marker.

- If Position marker is selected, the center frequency will be set to the frequency of the current marker.
- If Delta marker is selected, the center frequency will be set to the frequency of the Delta marker.
- This function is invalid in zero span.

### Mkr->CF Step

Sets the center frequency step of the analyzer to the frequency of the current marker.

- If Position marker is selected, the center frequency step will be set to the frequency of the current marker.
- If Delta marker is selected, the center frequency step will be set to the frequency difference between the Delta marker and the reference marker.
- This function is invalid in zero span.

### Mkr->Start

Sets the start frequency of the analyzer to the frequency of the current marker.

- If Position marker is selected, the start frequency will be set to the frequency of the current marker.
- If Delta marker is selected, the start frequency will be set to the frequency of the Delta marker.
- This function is invalid in zero span.

### Mkr->Stop

Sets the stop frequency of the analyzer to the frequency of the current marker.

- If Position marker is selected, the stop frequency will be set to the frequency of the current marker.
- If Delta marker is selected, the stop frequency will be set to the frequency of the Delta marker.
- This function is invalid in zero span.

## **Mkr->Ref**

Sets the reference level of the analyzer to the amplitude of the current marker.

- If Position marker is selected, the reference level will be set to the amplitude of the current marker.
- Given a Delta marker, if the current marker is the reference marker, then the reference level is set to the amplitude of the reference marker; if the current marker is the Delta marker, then the reference level is set to the amplitude of the Delta marker.

## **Mkr $\Delta$ ->CF**

Sets the center frequency of the analyzer to the frequency difference between the two Delta markers.

- Only when "Delta" marker is selected, can this function be valid.
- This function is invalid in zero span.

## **Mkr $\Delta$ ->Span**

Sets the span of the analyzer to the frequency difference between the two Delta markers.

- Only when "Delta" marker is selected, can this function be valid.
- This function is invalid in zero span.

## Marker Function

### N dB State

Enables or disables the N dB bandwidth measurement function.

**Note:** In the N dB measurement state, if the current marker is disabled, then the N dB BW measurement function is also disabled.

### N dB Bandwidth

Sets the N dB value.

The N dB Bandwidth denotes the frequency difference between two points that are located on both sides of the current marker and with N dB fall ( $N < 0$ ) or rise ( $N > 0$ ) in amplitude, as shown in the figure below.

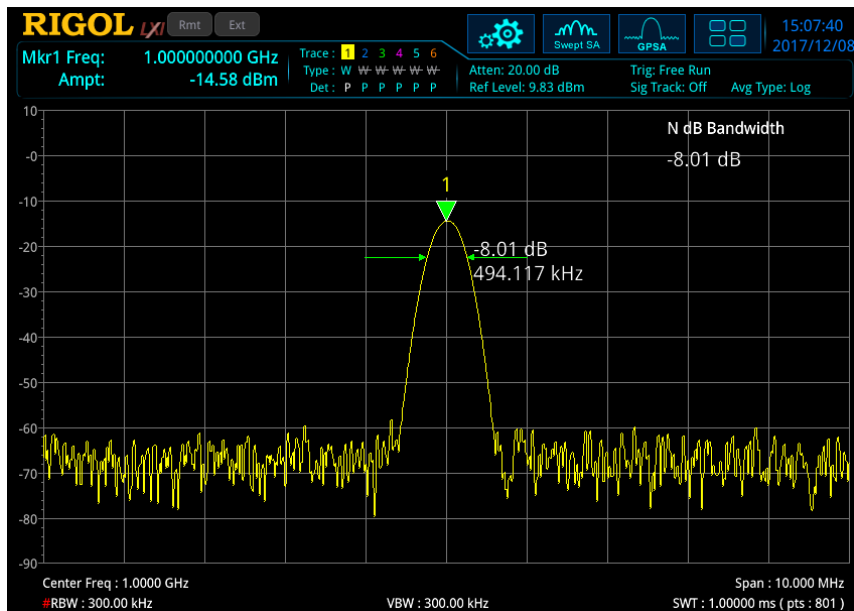

Figure 2-16 N dB Bandwidth Measurement

### Remarks:

- When the measurement starts, the analyzer will search for the two points which are located at both sides of the current point with N dB fall or rise in amplitude. Once the two points are found, the analyzer will display the frequency difference between the two points in the active function area. Once not found, "----" would be displayed.
- You can use the numeric keys, the knob, or arrow keys to modify the value of N.

For details, refer to descriptions in "**Parameter Setting**".

Table 2-55 N dB BW Parameter Settings

Parameter	Remarks
<b>Default</b>	-3.01 dB
<b>Range</b>	-140 dB to -0.01 dB
<b>Unit</b>	dB
<b>Knob Step</b>	1 dB
<b>Left/Right Arrow Key Step</b>	
<b>Up/Down Arrow Key Step</b>	1 dB

## Band Function

The band function defines the corresponding parameters for a frequency band to measure the signal at the marker point. When the band function is enabled and "Detector Auto" is enabled, then the Detector Type is automatically modified to "Average (RMS)".

### 1. Noise

When the noise measurement function is enabled, the measurement result of the Y-axis is the average noise level normalized to 1 Hz within the frequency band.

### 2. Band Power

In non-zero span mode, it calculates the total power within a span. In zero span mode, it calculates the average power within a certain time range.

### 3. Band Density

In non-zero span mode, the band density is the total power within the bandwidth to be measured divided by the measurement bandwidth. In zero span mode, the band density is the measured band power divided by  $B_n$  ( $B_n$  refers to the noise bandwidth of the RBW filter.)

### 4. Off

Disables the band function. Disabling the band function will neither affect the frequency band parameters nor disable the marker.



## Band Adjust

Adjusts the bandwidth parameters for the band function.

### 1. Band Span

Sets the bandwidth of the signal involved in the calculation for the band function.

### 2. Band Left

Sets the left edge frequency of the signal involved in the calculation for the band function.

### 3. Band Right

Sets the right edge frequency of the signal involved in the calculation for the band function.

### 4. Band Span Auto

Sets the manual/auto setting of the band span. When it is set to "Auto", the band span is 5% of the span or 5% of the sweep time. When you select "Manual", you can press **Band Span** to set it.

## Marker Counter

Enables or disables the frequency counter function of the current marker.

### Remarks:

- If no active marker currently exists, turning on the frequency counter will open a Position marker automatically.
- The frequency readout will be more accurate when the frequency counter is enabled.
- In zero span mode, enabling the frequency counter can measure the frequency near the center frequency.
- In the Delta marker mode, if the current reference marker is not a fixed type, then the reference marker can also be used for frequency counting.

## Gate Time

Sets the length of time for the marker counter to make gate measurement.

Table 2-56 Gate Time

Parameter	Remarks
Default	100 ms
Range	1 $\mu$ s to 500 ms
Unit	s, ms, $\mu$ s, ns, ps
Knob Step	gate time/100, Min = 1 $\mu$ s
Left/Right Arrow Key Step	
Up/Down Arrow Key Step	at 1-1.5-2-3-5-7.5 step

## Gate Time Auto

Turns on or off the auto gate time for marker counter.

### Remarks:

- Enables the auto gate time, and the gate time of the marker count is determined by the instrument automatically.
- When the auto gate time is disabled, press **Gate Time** to set it.

## Peak

The peak search function enables the marker to move to the specific signal peak point, and then in combination with the function of Delta marker, it can provide a powerful analysis capability.

### Peak Search

Performs the peak search function.

#### Remarks:

- If "Max" is selected under **Search Mode**, the system will search for the maximum value on the trace and mark it with a marker.
- If "Para" is selected under **Search Mode**, the system will search for the peak of the specified parameter on the trace and mark the peak with a marker.
- The peak search for the Next Peak, Next Peak Right, Next Peak Left, or peaks in the peak table must meet the specified peak search condition.
- When no peak meets the specified peak search condition, "No peak found" is displayed.

### Next Peak

Searches for and marks the peak whose amplitude on the trace is next to that of the current peak and which meets the peak search condition.

### Next Peak Right

Searches for and marks the nearest peak which is located at the right side of the current peak and meets the peak search condition.

### Next Peak Left

Searches for and mark the nearest peak which is located at the left side of the current peak and meets the peak search condition.

### Minimum Search

Searches for and marks the peak with the minimum amplitude on the trace.

## Pk-Pk Search

Executes Peak Search and Minimum Peak functions at the same time, and marks the results with the Delta marker. Wherein, the result of Peak Search is marked with the reference marker and the result of Minimum Peak is marked with the Delta marker.

## Cont Peak

Enables or disables continuous peak search. By default, it is Off. When it is enabled, after finishing each sweep, the analyzer will automatically execute one peak search operation to track the measurement signal.

When the marker is a fixed type, the Cont Peak menu is grayed out and disabled. The signal track and continuous peak functions are mutually exclusive. Once either of them is enabled, the menu of the other one will be grayed out. When the Cont Peak function is on, if the current marker is off, set the marker to Position mode, and then execute the peak search operation.

### Difference between Cont Peak and Signal Track

In Cont Peak, the system always searches for the maximum in the current frequency channel; while in Signal Track, the system will search for and mark the point (with no more than 3 dB variation in amplitude) near the marker before Signal Track is enabled, and then set the frequency of this point to be the center frequency.

## Peak Config

### 1. Peak Threshold

Specifies the minimum value of the peak amplitude. Only when the peak is greater than the peak threshold, can it be judged as a peak.

Table 2-57 Peak Threshold

Parameter	Remarks
<b>Default</b>	-90 dBm
<b>Range</b>	-200 dBm to 0 dBm
<b>Unit</b>	dBm, -dBm, V, mV, uV
<b>Knob Step</b>	1 dBm
<b>Left/Right Arrow Key Step</b>	
<b>Up/Down Arrow Key Step</b>	5 dBm

### 2. Threshold State

Enables or disables the peak threshold function.

### 3. Peak Excursion

Sets the amplitude of the peak. It defines the minimum amplitude variation required for a signal to be identified as peak.

Table 2-58 Peak Excursion

Parameter	Remarks
Default	6 dB
Range	0 dB to 100 dB
Unit	dB
Knob Step	1 dB
Left/Right Arrow Key Step	
Up/Down Arrow Key Step	5 dB

### 4. Excursion State

Enables or disables the peak excursion function.

#### Remarks:

- When the peak excursion function is enabled, press **Peak Excursion** to set it.
- When the peak excursion function is disabled, the **Peak Excursion** menu is disabled and grayed out.

### 5. Threshold Line

Sets whether to display the peak threshold line or not. By default, it is off.

#### Remarks:

- When the threshold state is on, the threshold line is, by default, on; when the threshold state is off, the threshold line is off. The threshold line displays the amplitude it represents.
- If the excursion state is on, then the peak amplitude line will be displayed at the top of the peak threshold, and the peak area will be displayed at the left section.

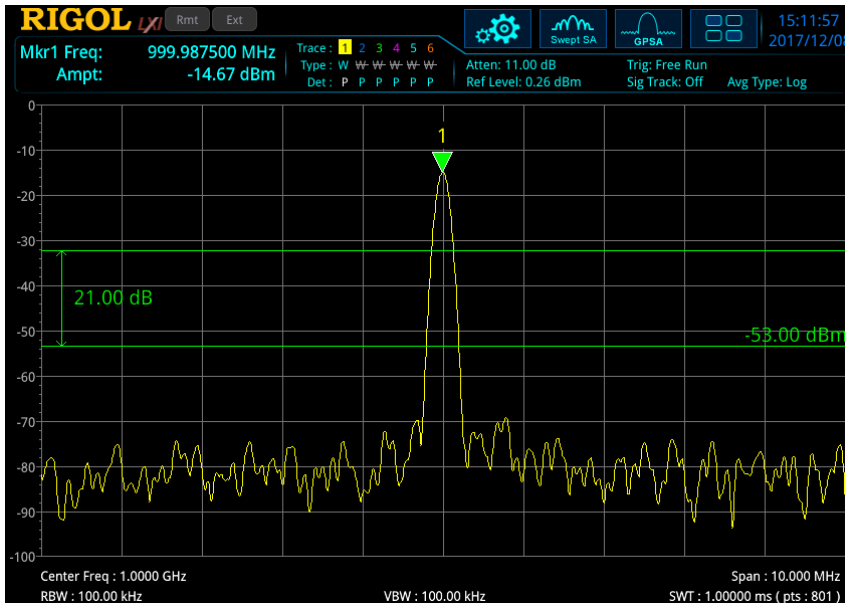

### 6. Search Mode

Sets the peak search condition: maximum value on the trace or the parameter that meets the search criteria.

- The available options are Max and Para. If "Max" is selected, the system searches for the maximum value on the trace. This setting applies only to the peak search executed by pressing Peak. Other searches such as Next Peak, Next Peak Right, and Next Peak Left are all searched based on "Para".
- If "Para" is selected, the system searches for the peak that meets the search criteria on the trace.

### Peak Table

Turns on or off the peak table. By default, it is Off.

When the peak table is turned on, the display is split into a measurement window and a peak table display window. The peak table will be displayed at the lower section of the screen, displaying the searched parameters (frequency and amplitude) that meet the criteria. You can use the externally connected mouse to click and drag the slide bar, use the scroll wheel in the middle of the mouse, use the touch screen gestures, press the Up/Down arrow keys and the corresponding keyboard shortcut keys to page up and down the peak table.

The marker table currently opened can be saved to the internal or external memory of the analyzer, and you can recall it at any time if you need. Press **Save** to save it according to descriptions in "**Save**".

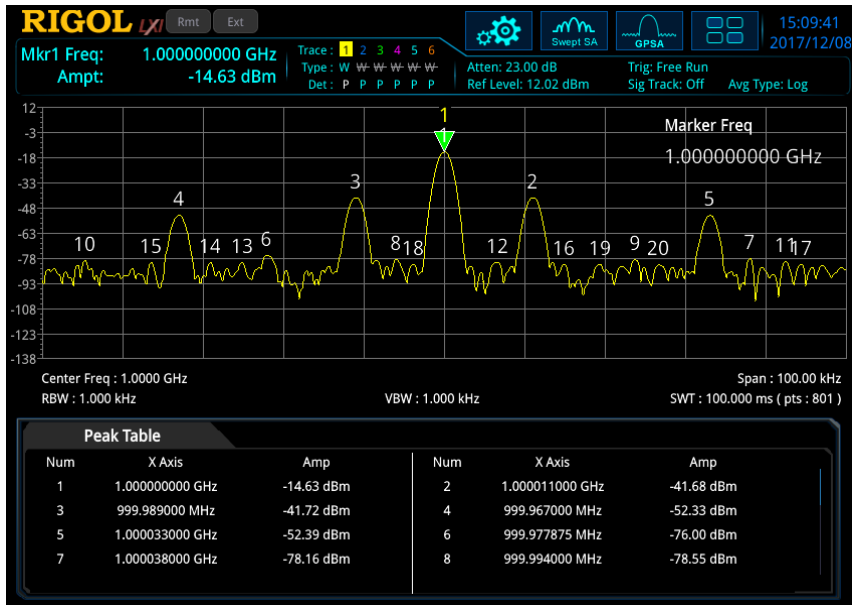

Figure 2-17 Peak Table

## Peak Table Sort

Selects the peak table sorting rule. Two options are available: Freq and Ampl. That is, list the peak in the order of ascending frequency or descending amplitude.

## Pk Table Readout

Sets the peak display condition to All, >Display Line, or <Display Line.

- All  
Lists all the peaks defined by the peak criteria, reading out based on the current sort setting in the peak table.
- >Display Line  
Displays the peaks meeting the peak criteria and whose amplitudes are greater than the specified display line in the table.
- <Display Line  
Displays the peaks meeting the peak criteria and whose amplitudes are smaller than the specified display line in the table.

**Note:** If the display line is off, the peak table displays all the peaks that meet the criteria. If you select ">Display Line" or "<Display Line" under "Table Readout", you should turn on the display line first.

## Display Line

Sets the display line level to change its display location. This line can be used as either the reference for you to read the measurement result or the threshold condition for the peaks displayed in the peak table. For details, refer to descriptions in "**Display Line**" under **System** → **Display**.



## Chapter 3 Functions of the Front Panel of RTSA

The real-time spectrum analyzer (RTSA) contains the digital IF component that has a strong processing capability. In real-time mode, all signal samples are processed to produce measurement results or initiate a trigger. In most cases, like the frequency swept analysis, the real-time analysis produces scalar results, such as power or amplitude.

The real-time spectrum analyzer has the following features:

- Seamless capture and analysis;
- High-speed measurement;
- Stable and consistent measurement speed;
- Frequency mask trigger;
- Diversified and advanced composite display

In general, the high-speed data stream in real-time mode can be used in the following two ways: to be served as the data source of composite spectrum display or be compared with the frequency mask to produce the frequency mask trigger.

This chapter describes in detail the function keys on the front panel and their associated menu functions in real-time mode.

**Note:** The keys or menus that have the same functions as those in GPSA will not be described in this chapter. For details, refer to the relevant contents in Chapter 2.

Contents in this chapter:

- Basic Settings
- Sweep and Function Settings
- Measurement Settings
- Marker Setup

## Basic Settings

### FREQ

Press **FREQ** on the front panel to enter the frequency setting menu. In this menu, Center Frequency is, by default, selected. You can modify the frequency-related parameters in this menu.

For details about each item under this menu, refer to "**FREQ**" in Chapter 2.

**Note:** "Signal Track" menu is not available in RTSA mode.

### SPAN

Press **SPAN** to enter the span setting menu. In this menu, Span is, by default, selected.

#### Span (Acq BW)

Sets the frequency range of the current channel.

#### Remarks:

- When you modify the span, the start and stop frequency will be modified automatically, with the center frequency remains to be unchanged.
- In manual span mode, the minimum span can be set to 5 kHz. When set to the full span, the span of analyzer is set to the currently supported maximum real-time bandwidth.
- You can use the numeric keys, the knob, and the arrow keys on the front panel to modify this parameter; also you can modify it on the touchscreen. For details, refer to descriptions in "**Parameter Setting**".

Table 3-1 Span

Parameter	Remarks
<b>Default</b> <sup>[1]</sup>	25 MHz
<b>Range</b> <sup>[2]</sup>	5 kHz to 25 MHz
<b>Unit</b>	GHz, MHz, kHz, Hz
<b>Knob Step</b>	span/200, Min = 2 Hz
<b>Left/Right Arrow Key Step</b>	
<b>Up/Down Arrow Key Step</b>	at 1-2-5 step

**Note**<sup>[1]</sup>: If the option RSA5000-B40 is installed, the default value is 40 MHz.

**Note**<sup>[2]</sup>: If the option RSA5000-B40 is installed, its range is from 5 kHz to 40 MHz.

## Last Span

Sets the span to the previous span setting.

## Full Span

Sets the maximum span.

### Remarks:

- In RTSA mode, the maximum bandwidth for single data acquisition is the maximum IF bandwidth of the installed option.
- For the standard configuration, the full span is 25 MHz.
- For the Option RSA5000-B40, the maximum bandwidth for single data acquisition is 40 MHz, so its full span is 40 MHz.

## Ref Value (PvT)

Sets the reference time for the horizontal axis in the PvT view. Modifying this value will not cause you to restart measurements. It is only used for trace display. When you enable the auto scale function or modifying the reference position, the ref value will be modified accordingly. Note that this menu is only valid in PvT measurement mode.

Table 3-2 Ref Value (PvT)

Parameter	Remarks
<b>Default</b>	0 $\mu$ s
<b>Range</b>	-1 s to 40 s
<b>Unit</b>	s, ms, $\mu$ s, ns, ps
<b>Knob Step</b>	ref value/100, min = 1 $\mu$ s
<b>Left/Right Arrow Key Step</b>	
<b>Up/Down Arrow Key Step</b>	at 1-1.5-2-3-5-7.5 step

**Note:** The PvT measurement displays the power variation of the signal within the user-defined time. The horizontal axis represents time, and the vertical axis represents amplitude.

## Scale/Div (PvT)

Sets the unit per division in the horizontal axis of the PvT view. Modifying this value will not cause you to restart measurements. It is only used for trace display. When you enable the auto scale function, the ref value will be modified accordingly. Note that this menu is only valid in PvT measurement mode.

Table 3-3 Scale/Div (PvT)

Parameter	Remarks
Default	acquisition time/10
Range	20 $\mu$ s ~ 4 s
Unit	s, ms, $\mu$ s, ns, ps
Knob Step	X-axis scale/100, min = 1 $\mu$ s
Left/Right Arrow Key Step	
Up/Down Arrow Key Step	at 1-1.5-2-3-5-7.5 step

## Ref Position (PvT)

Sets the position of the reference time in the horizontal axis of the PvT view to "Left", "Center", or "Right". Note that this menu is only valid in PvT measurement mode.

## Auto Scale (PvT)

Selects the setting mode for the horizontal scale of the PvT view. Note that this menu is only valid in PvT measurement mode.

### Remarks:

- When you select "Auto", the auto scale function enables you to automatically set the reference time and the X-axis scale based on the acquisition time and reference position.
  - The X-axis scale is 10% of the acquisition time.
  - The reference time is set to a different value according to a different reference position. When the reference position is set to "Left", the reference time is 0  $\mu$ s; when set to "Center", the reference time is half of the acquisition time; when set to "Right", the reference time equals to the acquisition time.
- When you set the reference time and the X-axis scale manually, the auto scale function will automatically switch to "Manual".

## AMPT

Press **AMPT** on the front panel to enter the amplitude setting menu. In this menu, Reference Level is, by default, selected.

In non-PvT measurement mode and the PvT measurement mode (except the Ref Level and Scale/Div menus), for details about each item under this menu, refer to "**AMPT**" in Chapter 2.

### Ref Level (PvT)

In the PvT measurement view, adjusting the reference level only changes the position of the trace displayed on the screen, but will not cause you to restart measurement. Note that this menu is only valid in PvT measurement mode.

Table 3-4 Ref Level (PvT)

Parameter	Remarks
<b>Default</b>	0 dBm
<b>Range</b>	-250 dBm to 250 dBm
<b>Unit</b>	dBm, -dBm, V, mV, $\mu$ V
<b>Knob Step</b>	For "Log" scale type, step = reference level/10
<b>Left/Right Arrow Key Step</b>	For "Lin" scale type, step = 0.1 dBm
<b>Up/Down Arrow Key Step</b>	For "Log" scale type, step = reference level For "Lin" scale type, step = 1 dBm

### Scale/Div (PvT)

Sets the unit per division in the vertical axis of the PvT view. Note that this menu is only valid in PvT measurement mode.

Table 3-5 Scale/Div (PvT)

Parameter	Remarks
<b>Default</b>	10 dB
<b>Range</b>	0.1 dB to 20 dB
<b>Unit</b>	dB
<b>Knob Step</b>	scale $\geq$ 0.1, step = 1 dB
<b>Left/Right Arrow Key Step</b>	scale < 0.1, step = 0.1 dB
<b>Up/Down Arrow Key Step</b>	at 1-2-5 step

## Sweep and Function Settings

### BW

Press **BW** to enter the bandwidth setting menu. In this menu, you can select the filter type and RBW.

### RBW

In RTSA mode, RBW selects from a pre-calculated selection of RBW values, which are computed based on the following formula:  $RBW = SPAN/Ratio$ . Wherein, Ratio is the Span/RBW ratio determined by the selected filter type.

In RTSA mode, there are 6 filter types available for you to choose. They correspond to 6 RBW values, namely RBW1 through RBW6. You can select a proper RBW value according to your needs.

**Note:** When the filter type is set to "Rectangular", RBW is automatically set to "RBW1", and "RBW2 through RBW6" are invalid.

Filter Type	Ratio1 1,024 point	Ratio2 521 point	Ratio3 256 point	Ratio4 128 point	Ratio5 64 point	Ratio6 32 point
Gaussian	404.761	205.938	101.190	50.595	25.298	12.649
Flattop	212.187	107.958	53.047	26.523	13.262	6.631
Blackman-Harris	399.131	203.074	99.783	49.891	24.946	12.473
Rectangular	800.782	407.429	200.196	100.098	50.049	25.024
Hanning	534.376	271.885	133.594	66.797	33.399	16.699
Kaiser	398.176	201.588	99.544	49.772	24.886	12.443

### RBW Auto

Sets the coupling mode of RBW to be "Auto" or "Manual".

#### Remarks:

- When you select "Auto", RBW is in auto coupling state.
- When you select "Manual" or directly set the RBW value, the coupling mode can be changed.

## Filter Type

Sets the type of the FFT window function.

RTSA adopts 6 filter types: Gaussian, Flattop, Blackman-Harris, Rectangular, Hanning, and Kaiser.

You can select a proper filter type according to the actual measurement requirements. You can refer to the following table.

Window Function	Spectral Leakage	Amplitude Accuracy	Frequency Resolution
Gaussian	Moderate	Good	Moderate
Flattop	Good	Excellent	Poor
Blackman-Harris	Excellent	Good	Moderate
Rectangular	Poor	Poor	Excellent
Hanning	Good	Moderate	Good
Kaiser	Good	Good	Moderate

**Note:** After you select the PvT measurement view in the PvT measurement mode, the bandwidth setting menu **BW** is disabled.

## Sweep

Press **Sweep** to enter the sweep setting menu. In this menu, set the sweep and control function of the analyzer.

## Acq Time

Sets the acquisition time for producing one single trace or one persistence bitmap. In this mode, the generated single trace will combine multiple overlapped FFT analysis results.

Table 3-6 Acquisition Time

Parameter	Remarks
<b>Default</b>	1 ms
<b>Range<sup>[1]</sup></b>	100 $\mu$ s to 40 s
<b>Unit</b>	s, ms, $\mu$ s, ns, ps
<b>Knob Step</b>	acquisition time/100, Min = 1 $\mu$ s
<b>Left/Right Arrow Key Step</b>	
<b>Up/Down Arrow Key Step</b>	at 1-1.5-2-3-5-7.5 step

**Note<sup>[1]</sup>:** If a persistence bitmap exists, the minimum acquisition time can be set to 32 ms; if no persistence bitmap exists, the minimum acquisition time can be set to 100  $\mu$ s.

## Acq Time Auto

Sets the state of the acquisition time for the spectrum analysis to "Auto" or "Manual".

### Remarks:

- When "Auto" is selected, the acquisition time adopts the default value.
- When "Manual" is selected, the acquisition time can be set manually within its available range.

## Acq Time (PvT)

In PvT mode, the acquisition time applies to all the traces, including the spectrum traces and spectrogram traces. Note that this menu is the same as the above **Acq Time** menu, the difference is that they can be set separately in different measurement modes.



Table 3-7 Acquisition Time

Parameter	Remarks
<b>Default</b>	30.00 ms
<b>Range</b>	0 s to 40 s
<b>Unit</b>	s, ms, $\mu$ s, ns, ps
<b>Knob Step</b>	acquisition time/100, Min = 1 $\mu$ s
<b>Left/Right Arrow Key Step</b>	
<b>Up/Down Arrow Key Step</b>	at 1-1.5-2-3-5-7.5 step

## Acq Time Auto (PvT)

Sets the acquisition time for the PvT analysis to "Auto" or "Manual".

### Remarks:

- When "Auto" is selected, the acquisition time (PvT) adopts the default value.
- When "Manual" is selected, the acquisition time (PvT) can be set manually within its available range.

## Continue

In RTSA mode, the continuous sweep function is logically same as that in GPSA mode. Press this key to perform the continuous sweep or measurement operation. This setting is global to all the activated traces and the detector types.

For details, refer to "**Continue**" in Chapter 2.

## Single

In RTSA mode, the single sweep function is logically same as that in GPSA mode. Press this key to perform the single sweep or measurement operation. This setting is global to all the activated traces.

**Note:** In RTSA mode, when performing the single measurement, the instrument will not stop sweeping until the sweep count has reached N. Wherein, N is determined by the result of "Avg. Number x (Acq/Trigger)" in the current measurement mode. During the single measurement, the trace data in the Normal view is updated for display in a real-time manner, whereas the trace history data in the Spectrogram view are not cleared.

For details, refer to "**Single**" in Chapter 2.

## Trigger

Press **Trigger** on the front panel to enter the trigger setting menu. The settings for the trigger parameters are basically the same as that in GPSA. In RTSA, IF power trigger and FMT are added. The Video trigger is not supported.

The following section will introduce IF power trigger and FMT. For descriptions about the parameter settings for "Slope", "Trigger Delay Switch", "Trig Delay", "Trigger Holdoff Switch", "Trigger Holdoff", "Auto Trig Switch", and "Auto Trig", please refer to "**Trigger**" in Chapter 2.

## Acq/Trigger

Sets the number of times for acquisition after each trigger signal that meets the requirements generated a trigger.

Table 3-8 Acq/Trigger

Parameter	Remarks
Default	1
Range	1 to 8,192
Knob Step	1
Left/Right Arrow Key Step	
Up/Down Arrow Key Step	at 1-1.5-2-3-5-7.5 step

## Power Trigger

A trigger signal will be generated when the system detects that the IF signal power exceeds the set IF power.

### Power

Sets the trigger level of the IF power trigger. When the signal meets the set trigger edge and exceeds the trigger level value, a trigger occurs. The IF power level is displayed in the waveform display area in the form of horizontal lines. When the set value is not within the waveform display range, the trigger level line is displayed at the top or bottom of the waveform display area.

Table 3-9 Power

Parameter	Remarks
<b>Default</b>	0 dBm
<b>Range</b>	(-140+level offset) to (30+level offset)
<b>Knob Step</b>	1 dBm
<b>Left/Right Arrow Key Step</b>	
<b>Up/Down Arrow Key Step</b>	at 1-3-10 step

## FMT

### 1. Mask Type

Determines which mask (upper or lower) is being displayed on the screen.

- Upper: only displays the upper mask.
- Lower: only displays the lower mask.
- Both: displays both the upper and lower masks.

### 2. Mask Edit

Press this key to enter the FMT editing interface. You can use the front panel keys to set the FMT. Besides, you can also finger touch or use the keypad to set and edit the FMT parameters in the FMT editing interface. In the visual prompt interface (only available in the single-window measurement mode), you can set and edit the FMT parameters. In the visual prompt interface, you can quickly set the common parameters. The detailed setting methods are the same as what you do with the corresponding front panel keys.

In addition, in the visual prompt interface, settings for the color style of the FMT are added. You can select the desired style from the available color template.

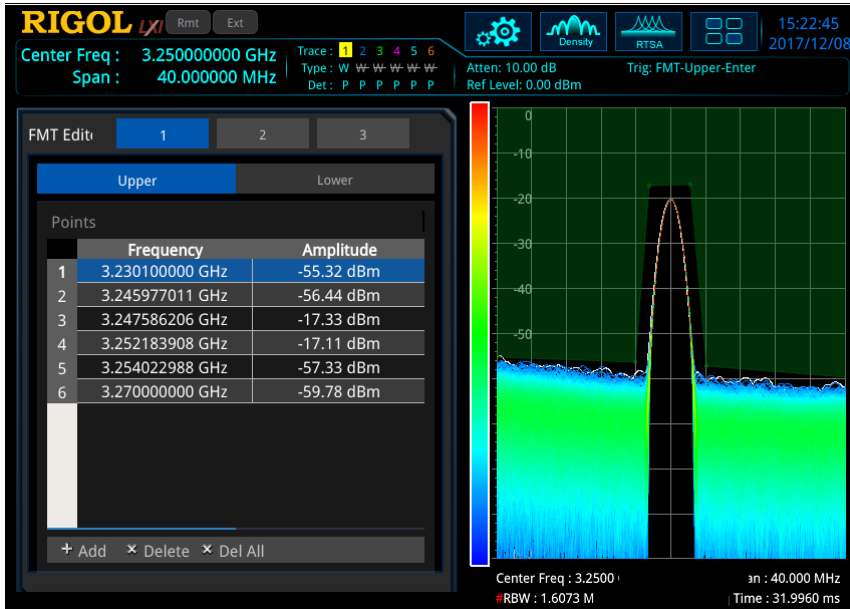

Figure 3-1 FMT Editing Interface

**1) Active Mask**

Selects the mask type that needs to be activated currently. The following operations for editing and setting the mask points are only valid for the currently activated mask type.

**2) Navigation**

Selects the first line of the mask editing table.

**3) Frequency**

Sets the frequency of the mask point. Its range is within the frequency range supported by the analyzer.

**4) Amplitude**

Sets the amplitude of the mask point. Its range is within the amplitude range supported by the analyzer.

**5) Insert Point**

Adds a mask point.

**6) Delete Point**

Deletes the currently selected mask point.

**7) Delete Mask**

Deletes the currently activated mask point.

**8) Build From Trace**

Selects a trace to build a mask.

**9) Build**

Builds a mask from the selected trace. The mask points are generated based on the rough outline of the trace. You can use the X and Y offset to adjust the mask position.

**10) Export**

Exports the mask to the file. You can also press **Save** → **FMT** to save the mask to the file.

**11) Import**

Press this key, and then the file manager interface is displayed. You can import the mask from the file. You can also press **Recall** → **FMT** to import the mask from the file.

**12) Recall**

In the file manager interface, after you select the desired file, press this key to load the corresponding mask.

**13) To Mask**

Selects the FMT file and imports it to the selected mask.

**14) New Mask**

Clears the currently activated mask and creates a default new mask.

**15) X Offset**

Sets the offsets of all the frequency points of the currently activated mask.

**16) Y Offset**

Sets the offsets of all the amplitude points of the currently activated mask.

**17) Apply Offset**

Adds the X and Y offsets to each point of the current mask.

**18) X Axis Type**

When "Fixed" is selected, the frequency of the current mask point will not be affected by the center frequency. When "Relative" is selected, the frequency of the current mask point is the difference between the frequency of the current mask point and the current center frequency. If you change the parameter state after completing the mask setup, the frequency of the mask should change with the state to keep the mask points to be in the same position relative to the current center frequency of the instrument.

### 19) Y Axis Type

When "Fixed" is selected, the amplitude of the current editing point will not be affected by the reference level. When "Relative" is selected, the amplitude of the current mask point is the difference between the amplitude of the current mask point and the current reference level. If you change the parameter state after completing the mask setup, the amplitude of the mask should change with the state to keep the mask points to be in the same position relative to the current reference level of the instrument.

## 3. Trigger Mask

Sets the currently effective trigger mask.

- Upper: only sets the upper trigger mask to be effective.
- Lower: only sets the lower trigger mask to be effective.
- Both: sets both the upper and lower trigger masks to be effective.

**Note:** When "Upper" is selected under **Mask Type**, the trigger mask is, by default, the upper mask; when "Lower" is selected under **Mask Type**, the trigger mask is, by default, the lower mask; when "Both" is selected under **Mask Type**, the trigger mask is, by default, the one before switching the mask type.

## 4. Trigger Criteria

Sets the condition that will cause the FMT trigger to occur. Both upper and lower masks use the same trigger criteria, and the trigger will occur when either mask meets the trigger criteria.

- Enter: Two states are required to initiate a trigger event. The signal must be outside the mask and then passes into the mask. The trigger event occurs when the first non-violating waveform is detected.
- Leave: Two states are required to initiate a trigger event. The signal must be inside the mask and then passes out of the mask. The trigger event occurs when the first non-violating waveform is detected.
- Inside: Only one state is required to initiate a trigger event. The signal has at least one data point inside (above) the mask. The trigger event occurs when the instrument detects the first signal with a point violating the mask. A trigger event could occur on the first acquisition.
- Outside: Only one state change is required to initiate a trigger event. The signal has all data points outside (below) the mask. The trigger event occurs when the instrument has detected the first spectral waveform that is completely below (outside) the mask. A trigger event could occur on the first acquisition.
- Enter-Leave: Three states are required to initiate a trigger event. The signal starts outside the mask and then passes into the mask. Next, the signal must pass outside the mask. The trigger event occurs at the second transition where the signal passes back out of the mask.
- Leave-Enter: Three states are required to initiate a trigger event. The signal starts inside the mask and then passes out of the mask. Next, the signal must pass into the mask. The trigger event occurs at the second transition

where the signal passes back into the mask.

## Trace

Press **Trace** on the front panel to enter the trace setting menu. In this menu, you can perform the operations related to trace, such as trace acquisition, trace display, trace saving, trace detector, and trace data.

### Remarks:

- Normal view: all the traces are available. The trace type can be set to any of the available trace types.
- Density view: only Trace1 is available. The trace type can be set to any of the available trace types. During the toggle of various measurement modes, before you enter the Density view, all other enabled and updated traces are turned off automatically; when you return to the previous mode, the traces will be restored to their previous state. The trace math operation function is disabled.
- Spectrogram view: all the traces are available.
  - Trace1: The trace type can only be set to "Clear Write", and the rest trace types are disabled and grayed out.
  - Trace2 through Trace6: The trace type can be set to "Clear Write", "Max Hold", and "Min Hold". The trace type "Average" is disabled;
  - The trace math operation function is disabled.
- Density Spectrogram view:
  - Only Trace1 is available;
  - The trace type can only be set to "Clear Write", and the rest trace types are disabled and grayed out;
  - The trace math operation function is disabled.
- When making PvT-related measurements, select the PvT view: only Trace1 is available; the trace type can only be set to "Clear Write"; the trace math operation function is disabled.

## Trace Detector

Sets the type of the trace detector, and it is valid for all the traces. The trace detector is, by default, determined automatically by the instrument. If you set the type of the trace detector manually, the detector auto setting function will be disabled. The available trace detectors include Pos Peak, Neg Peak, Sample, and Average.

For details about the trace menu items in the real-time spectrum measurement mode, refer to **"Trace"** in Chapter 2. In this manual, all the Trace menu items in the PvT measurement mode are expressed with "PvT" attached in brackets to distinguish themselves from the same menu items under other measurement modes.

## **Trace Detector (PvT)**

Sets the trace detector for the PvT mode.

## **Detector Auto (PvT)**

Enables or disables the Detector Auto function in PvT mode. By default, Detector Auto is enabled. If you set the detector type manually, please disable the Detector Auto function.

## **Trace Update (PvT)**

Enables or disables the trace update in PvT mode.

## **Trace Display (PvT)**

Enables or disables the trace display in PvT mode.

## **Preset All (PvT)**

In PvT mode, turns on Trace 1, and blanks all other traces. This operation does not affect the trace type, trace detector, and other states.

## **Clear All (PvT)**

Clears all traces in PvT mode. All the trace data will be set to the minimum trace value (except the case that the trace is in Min Hold state). When the trace is in Min Hold state, the trace data will be set to the maximum trace value. That is, even if you turn off the trace update, the trace data will be updated after you perform the "Clear All" operation.

**Note:** The trace settings in PvT and non-PvT modes are independent of each other. In PvT view, 6 traces are all available for setting, but only one trace can be displayed.



## Measurement Settings

### Meas

In RTSA mode, Normal, Density, Spectrogram, Density Spectrogram, PvT, PvT Spectrum, PvT Spectrogram, and AMK are available.

After you select a measurement function, the screen is split into several display windows; in multi-window mode, you can touch the screen or use the mouse to select a specified window as the current window, and maximize the current window. If you select a different window, its corresponding menu will be different.

### Normal

#### Measurement Interface:

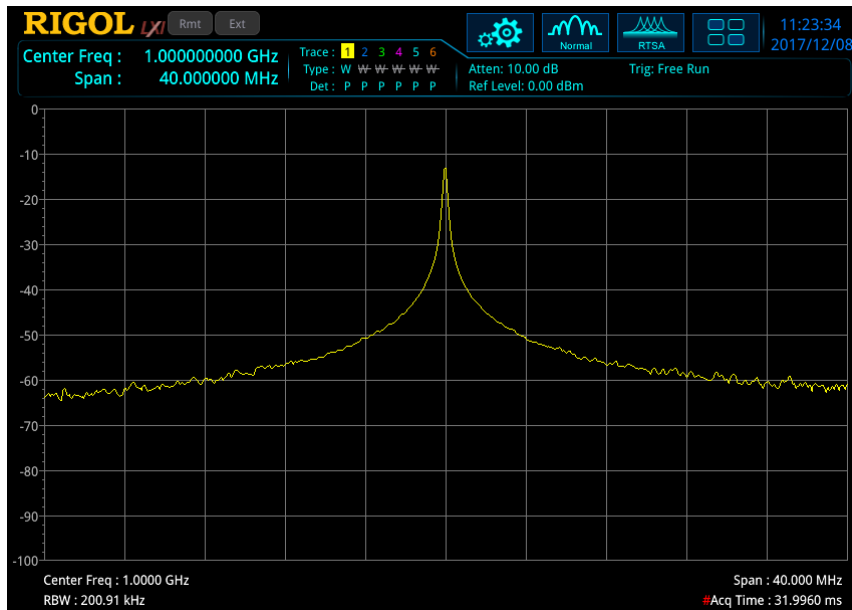

Figure 3-1 Normal View

After you select **Normal** to be the measurement type, the measurement interface is shown in the figure above. Press **Meas Setup** to set the relevant parameters.

#### Remarks:

- In RTSA mode, all signal samples are processed to produce measurement results based on the set mode or initiate a trigger.
- In Normal view, **Limit** measurement function is supported.

## Density

### Measurement Interface:

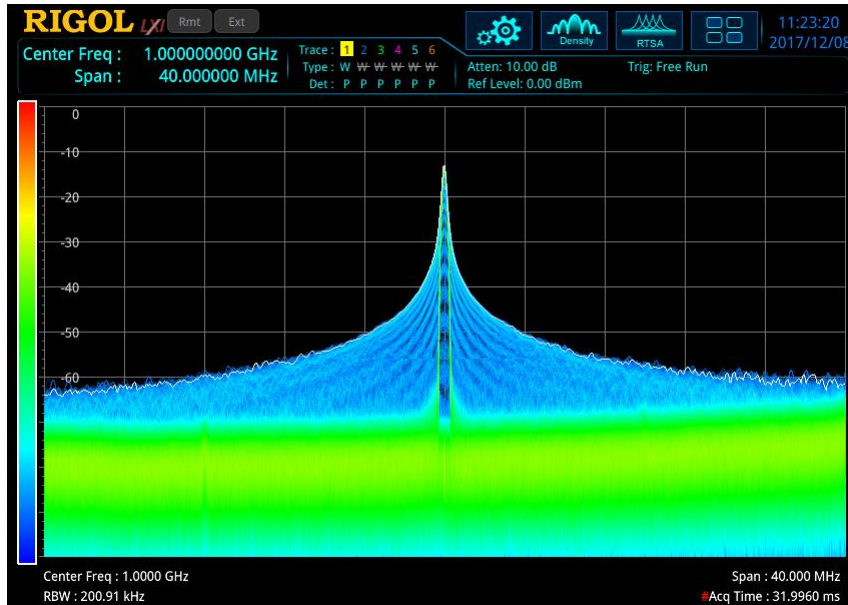

Figure 3-2 Density View

The instrument defaults to Density measurement mode, and the measurement interface is shown in the figure above. After you select **Density** to be the measurement type, press **Meas Setup** to set the relevant parameters.

#### Remarks:

- The density is defined as the number of times a frequency and amplitude point is hit during an acquisition interval.
- The Density view will also display a white trace. This trace shows the real-time spectrum for the latest acquisition interval. When using positive peak, negative peak, or average detectors, the white trace obtains detector data from all the data within the acquisition time; when using the Sample detector, the last FFT was used.
- To display the signal status within a longer time range, you can display multiple Density views on the screen. The latest Density view is displayed with the highest brightness. The longer the time from the latest Density view, the lower brightness of the Density view. Such display of the brightness is generally called persistence view.
- The Density view is displayed combined with the persistence view. X-axis represents frequency, Y-axis represents amplitude, Z-axis represents number of hits, and T-axis represents time. This view displays four dimensional data on a two dimensional display, using color to represent Z-axis and brightness to represent T-axis.

## Spectrogram

### Measurement Interface:



Figure 3-3 Spectrogram View

After you select **Spectrogram** to be the measurement type, the measurement interface is shown in the figure above. Press **Meas Setup** to set the relevant parameters.

#### Remarks:

- The Spectrogram view is displayed in multiple windows, including displaying the conventional Normal view. In this view, the multiple windows have a coupling relationship. The conventional Normal view displays the specified spectral line set by the trace parameters. Select the Normal view, **Limit** measurement function is supported. In the Spectrogram view, a white horizontal line represents the currently displayed trace. In the Spectrogram mode, display trace 1 indicates the latest trace.
- In the view, each horizontal line represents a trace, and the vertical Y-axis represents time. The latest trace data is displayed at the top of the Spectrogram by default, and the historical traces are moved up one position. The Spectrogram can hold 8,192 traces. When Spectrogram occupies a Window that has full vertical size, 486 traces can be displayed at one time. When Spectrogram occupies the vertical window in the lower section, 230 traces can be displayed at one time.
- In the view, the colors represent signal amplitude. The color bar is displayed at the far left of the Spectrogram view. For details about the settings of the color bar, refer to "**Ref Hue**".

- When you select a trace that has not yet been acquired, both the trace window and Spectrogram window will remain blank until the trace is acquired. Then, once a trace is acquired in the Spectrogram window, the window will be updated for one time. The trace window will show the specified trace.
- Any parameter change will clear out the spectrogram and restart an acquisition, unless in the idle state (single measurement or waiting for a trigger). The data will also be cleared on exit from the Spectrogram view.
- In the Spectrogram view, zero time is the point where the first trace starts an acquisition, meaning that each subsequent trace point is at a positive time that represents when that point was gathered, relative to the start point. Each trace is time stamped as it starts, and this time is remembered for each trace. With the increase of the traces, the time difference for the successive traces get larger.

## Density Spectrogram

### Measurement Interface:

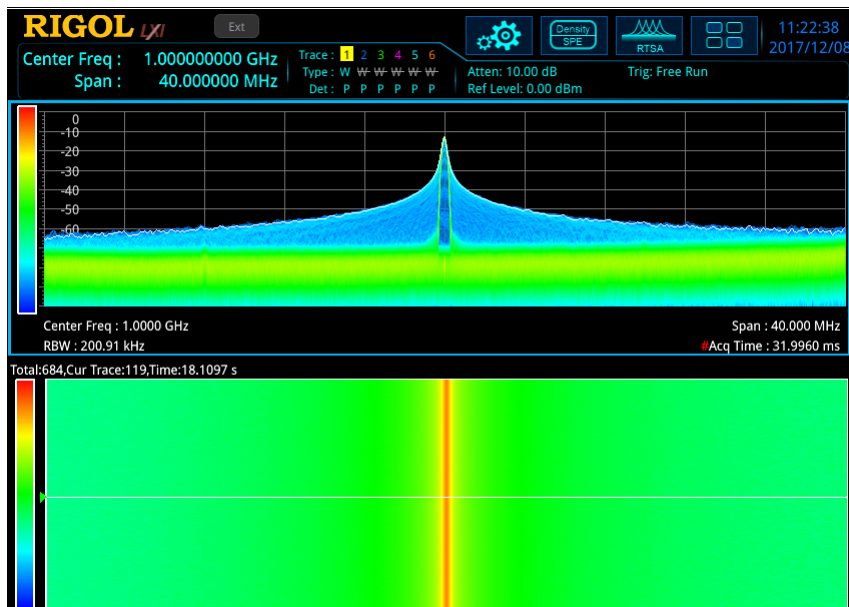

Figure 3-4 Density Spectrogram View

After you select **Density Spectrogram** to be the measurement type, the measurement interface is shown in the figure above. Press **Meas Setup** to set the relevant parameters.

### Remarks:

- The Density Spectrogram view is displayed in multiple windows, including Density and Spectrogram views. In this view, multiple windows have a coupling

relationship. You can use the mouse or touch the screen to display one of the windows in full screen.

- The parameter rule in the Density view is consistent with that in the single Density view. Note that the white real-time trace in the Density view corresponds to the display trace in the Spectrogram view, but the trace in the Density view shows the latest data.
- The parameter rule in the Spectrogram view is consistent with that displayed in the single Spectrogram view.
- The combined Density and Spectrogram view display the traces, the occurrences of all the signals within the acquisition interval time, their corresponding frequency/amplitude and time information.

## PvT

### Measurement Interface:

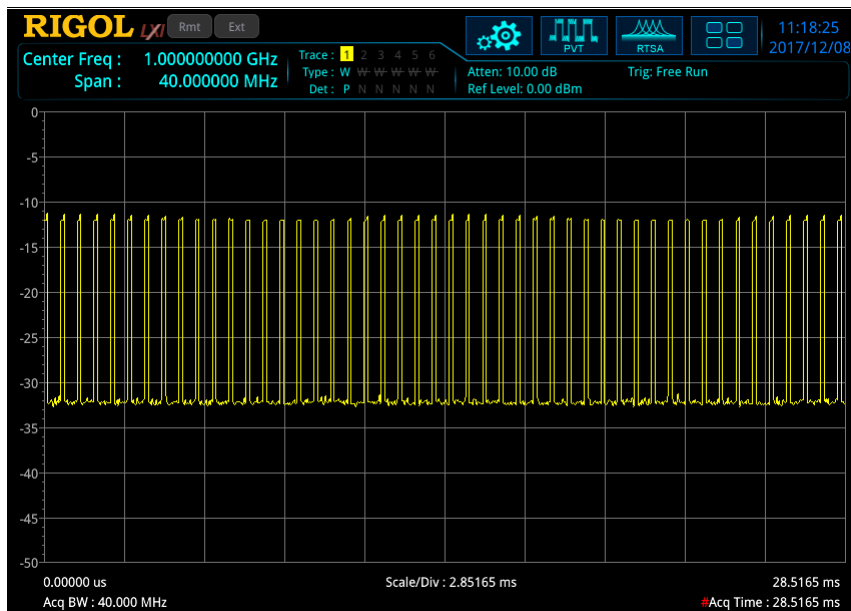

Figure 3-5 PvT View

After you select **PvT** to be the measurement type, the measurement interface is shown in the figure above. Press **Meas Setup** to set the relevant parameters.

### Remarks:

- The PvT measurement provides an analysis for time-domain data. X-axis represents the acquisition time, and Y-axis represents the power value of the signal.
- In RTSA mode, the acquisition time in PvT measurement can be different from that in the real-time spectrum measurement, but in the combined display of PvT

Spectrogram and PvT Spectrum, the acquisition time of the real-time spectrum measurement will be set to the PvT acquisition time.

- The menu items under **BW** in PvT measurement are disabled. The menu items of SPAN, AMPT, Trace, Sweep, Marker, Marker->, and Marker Func can be set separately.

## PvT Spectrum

### Measurement Interface:



Figure 3-6 PvT Spectrum View

After you select **PvT Spectrum** to be the measurement type, the measurement interface is shown in the figure above. Press **Meas Setup** to set the relevant parameters.

### Remarks:

- The PvT Spectrum view is displayed in multiple windows, including PvT view and real-time normal view. In PvT Spectrum view, multiple windows have a coupling relationship. You can use the mouse or touch the screen to display one of the windows in full screen.
- The parameter rule in the PvT Spectrum view is consistent with that in the single PvT view.
- The parameter rule in the real-time normal view is consistent with that in the single Normal view. Select the Normal view, **Limit** measurement function is supported.
- In PvT mode, the acquisition time applies to all the traces.

## PvT Spectrogram

### Measurement Interface:



Figure 3-7 PvT Spectrogram View

After you select **PvT Spectrogram** to be the measurement type, the measurement interface is shown in the figure above. Press **Meas Setup** to set the relevant parameters.

#### Remarks:

- The PvT Spectrogram view is displayed in multiple windows, including PvT view, real-time normal view, and spectrogram view. In PvT Spectrogram view, multiple windows have a coupling relationship. You can use the mouse or touch the screen to display one of the windows in full screen.
- The parameter rule in the PvT Spectrum view is consistent with that in the single PvT view.
- The parameter rule in the real-time normal view is consistent with that in the single Normal view. Select the Normal view, **Limit** measurement function is supported.
- The parameter rule in the spectrogram view is consistent with that in the single Spectrogram view.
- In PvT mode, the acquisition time applies to all the traces.

## Advanced Measurement Function (AMK)

### Measurement Interface:



Figure 3-8 SSC Measurement Interface

#### (1) Meas Off

Disables the advanced measurement function and returns to the Normal view in RTSA mode.

#### (2) SSC

SSC advance measurement function is a measurement analysis function specially customized for 2FSK signal. When you enter the SSC function interface, the screen is automatically split into two sections for display, with the upper section as the measurement window displaying the measurement trace; the lower section as the measurement result window displaying the measurement results. The measurement interface is shown in the figure above. Press **Meas Setup** to set the corresponding parameters.



## Meas Setup

Open the parameter setting menu of the function selected in the **Meas** menu. In the **Meas Setup** menu, only the menu items related to the current measurement function are displayed. Please view the relevant menus according to the current measurement function.

### Avg Number

Specifies the number of times for averaging the measurement results. The average value is displayed in a real-time manner after each measurement is completed.

Table 3-10 Average Count

Parameter	Remarks
<b>Default</b>	10
<b>Range</b>	1 to 1,000
<b>Unit</b>	None
<b>Knob Step</b>	1
<b>Left/Right Arrow Key Step</b>	
<b>Up/Down Arrow Key Step</b>	1

### Limit

Sets the parameters of limit lines. For details, refer to "**Limit**" in Chapter 2. Only when you select "Normal" view, can the limit line operation be available.

### Meas Preset

Restores all parameters of the current measurement mode to their preset values, without clearing the limit line.

## Density Parameters

### 1. Persistence

Sets how long the frequency/amplitude points displayed in the bitmap should take to fade.

#### Remarks:

- The persistence controls the length of time it will take for a point to go from 100% intensity to 0% intensity.
- If the point in the bitmap does not appear again during the persistence time, then the point will gradually become transparent until it disappears.

### 2. Persistence Infinite

Enables or disables the infinite mode of the persistence display.

- When off, it indicates the finite mode. At this time, you can define the persistence time. You can observe the density of each point over the entire measurement time.
- When on, it indicates the infinite mode. Infinite mode shows the total number of times a frequency/amplitude point appear during all the capture intervals since starting the measurement. In the infinite mode, the intensity for all the frequency/amplitude points is 100%, and there will be no fading, but its density will change with the measurement time.

### 3. Color Palettes

Selects different color palettes which allows optimization of visibility and contrast for different signal environment. In RTSA mode, there are five color palettes available for you to choose: Cool, Warm, Radar, Fire, and Frost. By default, "Warm" is selected to be the color palette.

### 4. Highest Density Hue

Sets the maximum density expressed in percentage.

Table 3-11 Highest Density Hue

Parameter	Remarks
Default	100
Range	0.1 to 100
Unit	None
Knob Step	0.1
Left/Right Arrow Key Step	
Up/Down Arrow Key Step	

### 5. Lowest Density Hue

Sets the minimum density expressed in percentage.

Table 3-12 Lowest Density Hue

Parameter	Remarks
Default	0
Range	0 to 99.9
Unit	None
Knob Step	0.1
Left/Right Arrow Key Step	
Up/Down Arrow Key Step	at 1-1.5-2-3-5-7.5 step

## 6. Curve Nonlinearity

Within the range between the highest density hue and lowest density hue, setting the curve nonlinearity can change the gradient among different density hues, making the displayed results move towards either the higher or lower end of the gradient. Increasing the curve nonlinearity value will compress the colors towards the higher end of the color bar, and decreasing the nonlinearity value will compress the colors towards the lower end of the color bar.

Table 3-13 Curve Nonlinearity

Parameter	Remarks
Default	75
Range	-100 to 100
Unit	None
Knob Step	1
Left/Right Arrow Key Step	
Up/Down Arrow Key Step	at 1-1.5-2-3-5-7.5 step

## 7. Auto Adjust Color

Sets the highest density due to the highest density value found in the current bitmap; sets the lowest density hue to the lowest non-zero density value found in the current bitmap.

## 8. Hue Truncate

Enables or disables the hue truncate function. When on, the area that is greater than the maximum value and smaller than the minimum value will be indicated in black; when off, it is indicated by boundary value.

## Spectrogram Parameters

### 1. Display Trace

Sets the trace index displayed in the trace window in the Spectrogram mode. You can determine the trace either by the trace number or the trace time. Trace 1 indicates the latest trace. If you select the trace by trace time, select a trace that is closest to the set time.

Table 3-14 Display Trace

Parameter	Remarks
<b>Default</b>	1
<b>Range</b>	1 to 8,192
<b>Unit</b>	None
<b>Knob Step</b>	1
<b>Left/Right Arrow Key Step</b>	
<b>Up/Down Arrow Key Step</b>	

### 2. Trace Selection

Sets the type for the trace to be displayed in the trace window. It can be set to "Time" or "TNum".

Each trace is associated with a time value that represents the acquisition time. The formula is as follows: Trace Time = Trace Number x Acquisition Time.

### 3. Couple Marker Trace

Sets whether to couple the marker to the selected trace. Turn on a marker, and set Marker Z to n. The available range of n is from 1 to 8,192. Set the Display Trace number to n. At this time, enable the Trace Couple function. Then, the marker will stay with the selected Trace n, and changes with it. When you disable the Trace Couple function, the marker will be fixed to Marker n that is set when you turn on the marker. Modify the Display Trace number, and the marker will not change with the trace.

### 4. Ref Hue

Adjusts the hue at the top of the color bar in the Spectrogram. The color bar in the Spectrogram is placed next to the waveform display to map the amplitude and color in the Spectrogram.

Table 3-15 Ref Hue

Parameter	Remarks
<b>Default</b>	0
<b>Range</b>	0 to 359.9
<b>Unit</b>	None
<b>Knob Step</b>	0.01
<b>Left/Right Arrow Key Step</b>	
<b>Up/Down Arrow Key Step</b>	

The hues of the colors run from 0 to 359 are shown below:

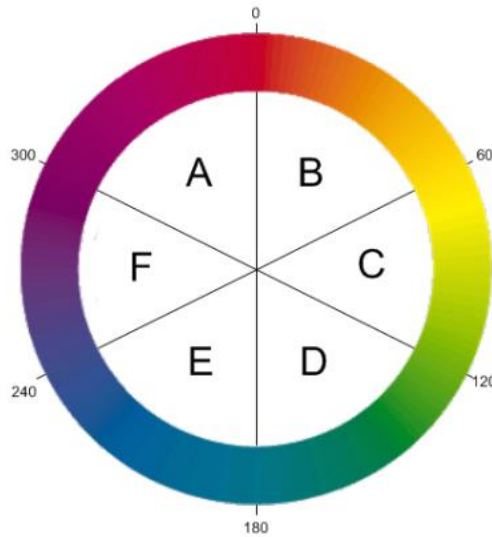

In the hue ring, Hue 0 is red (255,0,0), Hue 120 is green (0,255,0), Hue 240 is blue (0,0,255), Hue 60 is yellow (255,255,0), Hue 180 is Cyan (0,255,255), and Hue 300 is magenta (255,0,255). In Region A-B, the red value is constant (255); in Region C-D, the green value is constant (255); in Region E-F, the blue value is constant (255). There is no green in Region F-A, no blue in Region B-C, and no red in Region D-E.

When adjusting the reference hue, you are adjusting the hue at the top of the color bar. The bottom of the color bar shows the hue that is 240 degrees clockwise from the reference hue.

## 5. Ref Hue Pos

Sets the position of the reference hue displayed in the graticule. Any amplitudes higher than the reference position are displayed as black.

Table 3-16 Reference Hue Position

Parameter	Remarks
<b>Default</b>	100
<b>Range</b>	Max (10%, bottom hue value + 10%) to 100.0
<b>Unit</b>	None
<b>Knob Step</b>	1
<b>Left/Right Arrow Key Step</b>	
<b>Up/Down Arrow Key Step</b>	at 1-1.5-2-3-5-7.5 step

## 6. Bottom Hue Pos

Sets the bottom hue position displayed in the graticule. Any amplitudes lower than the bottom hue position are displayed as black.

Table 3-17 Bottom Hue Position

Parameter	Remarks
<b>Default</b>	0
<b>Range</b>	0 to Min (90%, reference position value - 10%)
<b>Unit</b>	None
<b>Knob Step</b>	1
<b>Left/Right Arrow Key Step</b>	
<b>Up/Down Arrow Key Step</b>	

## 7. Auto Adjust Hue

Auto adjusts the reference hue position and bottom hue position based on the highest amplitude value found in the spectrogram and the lowest amplitude value found in the spectrogram, respectively. The reference hue position is set to be the highest amplitude value, and the bottom hue position to be the lowest amplitude value.

## SSC

The SSC function can continuously capture the signals with abrupt changes of power.

### 1) Max Hold

Enables or disables the Max Hold. When the Max Hold is enabled, the signal captured each time will be compared with the last captured signal, whichever is the larger value will be displayed as the max hold trace.

### 2) Reset

Clears the existing measurement results.

### 3) Mark Line1 State

Enables or disables Mark Line1. When Mark Line1 is enabled, a blue vertical line is displayed in the basic measurement window.

### 4) Mark Line1

Displays or sets the frequency value at Mark Line1. You can use the numeric keys, the knob, or arrow keys to modify the frequency value at Mark Line1; you can also use the touch screen to modify the value.

### 5) Mark Line2 State

Enables or disables Mark Line2. When Mark Line2 is enabled, a red vertical line is displayed in the basic measurement window.

### 6) Mark Line2

Displays or sets the frequency value at Mark Line2. You can use the numeric keys, the knob, or arrow keys to modify the frequency value at Mark Line2; you

can also use the touch screen to modify the value.

### 7) Pass/Fail

Enables or disables the Pass/Fail function. Before enabling the Pass/Fail function, refer to the descriptions in the following section to edit the limit.

- On: If the amplitudes of 6 peaks are all within the amplitude range, it indicates "Pass". At this time, "Pass" is displayed in the measurement result display window. Otherwise, it indicates "Fail". At this time, "Fail" is displayed in the measurement result display window.
- Off: A message indicates that test stops is displayed in the measurement result display window.

### 8) Limit Edit

Sets the amplitude limit range of all peaks in the Pass/Fail test.

- Signal: Selects a signal to edit its amplitude limit range. The peaks that correspond to the selected signals are shown in the following table.

Signal	Peak
1	Peak1 and Peak2
2	Peak3 and Peak4
3	Peak5 and Peak6

- Ampt Up: Sets the upper limit of the amplitude.
- Ampt Down: Sets the lower limit of the amplitude.

## Marker Setup

### Marker

In RTSA mode, the Marker function in the real-time spectrum view is basically the same as that for GPSA (Note that when you select the Density view or the Spectrum view, the Marker Z menu is enabled). In the PvT measurement view, you are only allowed to set the marker on Trace1, and the "Marker Trace", "Marker Trace Auto", "Marker Readout", and "Readout Auto" menus are not supported. Other menus are basically the same as that in the real-time spectrum view.

### Marker Z

Sets the trace number of the spectrum trace where the marker stays in the Density or Spectrogram view. Only when you select the Spectrogram view, can this menu be effective.

For details about the marker, refer to relevant contents of "**Marker**" in Chapter 2.

### Marker To

In RTSA mode, the Marker To function in the real-time spectrum view is basically the same as that for GPSA. In the PvT measurement view, only the "Mkr -> Ref" menu is supported.

For details about the marker, refer to relevant contents of "**Marker To**" in Chapter 2.

### Marker Function

In RTSA mode, only "N dB Bandwidth" and "Band Function" menus are supported in the real-time spectrum view; whereas in the PvT measurement view, only "Band Function" is supported.

For details about the "N dB Bandwidth" and "Band Function" menus, refer to relevant contents of "**Marker Function**" in Chapter 2.

### Peak

In RTSA mode, the peak function is basically the same as that for GPSA. For details, refer to relevant contents of "**Peak**" in Chapter 2.



## Chapter 4 Input/Output

Sets the input/output interface.

### Input Impedance

Sets the input impedance for voltage-to-power conversions (refer to equation (2-4)). The default input impedance is 50  $\Omega$ . To measure a 75  $\Omega$  device, you should use a 75  $\Omega$  to 50  $\Omega$  adapter (option) supplied by **RIGOL** to connect the analyzer with the system under test, and then set the input impedance to 75  $\Omega$ .

### Ext Gain

Compensates for gain or loss in the measurement system outside the instrument.

#### Remarks:

- The value does not affect the trace position, but will modify the parameters such as reference level readout and the marker amplitude readout.
- You can use the numeric keys, the knob, and the arrow keys on the front panel to modify this parameter; also you can modify it on the touchscreen. For details, refer to descriptions in "**Parameter Setting**".

Table 4-1 External Gain

Parameter	Remarks
Default	0 dB
Range	-120 dB to 120 dB
Unit	dB
Knob Step	1 dB
Left/Right Arrow Key Step	
Up/Down Arrow Key Step	5 dB

### Ext Trigger2

Sets the external trigger 2 [**TRIGGER IN/OUT**] to be the "input" or "output" interface.



# Chapter 5 Shortcut Key

## Auto Tune

Automatically searches for the signal within the full frequency range, and adjusts the frequency and amplitude for optimal display effect of the signal to realize one-key signal search and auto setting of parameters.



Figure 5-1 Before Auto Search

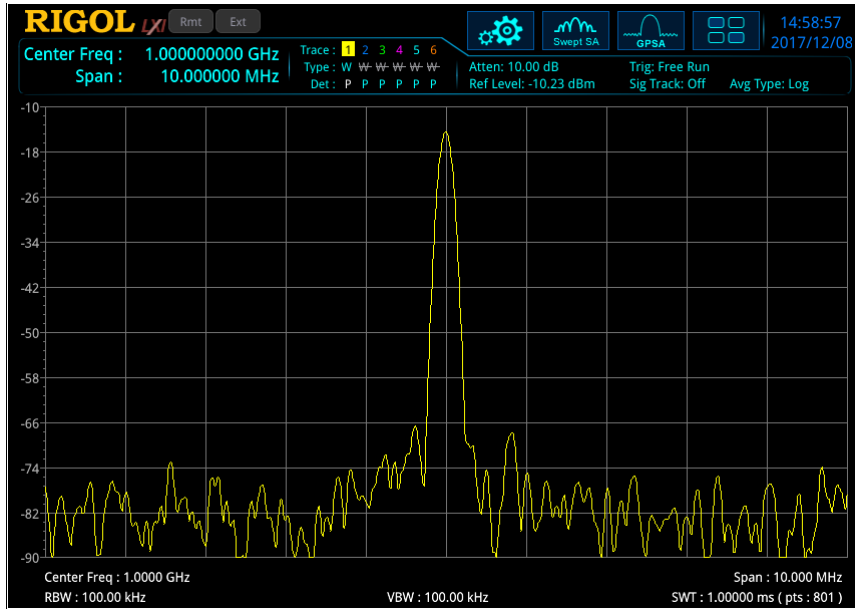

Figure 5-2 After Auto Search

**Remarks:**

- In the process of auto search, the backlight of the **Auto Tune** key on the front panel turns on. After the search is finished, the backlight of the key turns off.
- Some parameters such as the reference level, scale, input attenuation, and maximum mixer level may be changed during the auto search.
- Enable the AMK function or the calibration signal in GPSA mode; or the Auto Tune function is disabled in RTSA mode.

## Preset

Recalls the preset setting and restores the system settings of the analyzer to a specified status.

### Remarks:

- To set the preset type, press **System** → **Preset** → **Preset Type** to select "Default" or any one of the items from "User1" to "User6".
- Press **Preset** to recall the specified factory settings (as shown in the following table, except the items specified in Note[3]) or user settings.

Parameter Name	GPSA Parameter Value	RTSA Parameter Value (RSA5000-B40)	
		Non-PvT	PvT
<b>FREQ</b>			
Center Freq	3.25 GHz	3.25 GHz	
Start Freq	0 Hz	3.23 GHz	
Stop Freq	6.5 GHz	3.27 GHz	
CF Step	Auto, 650 MHz	Auto, 4 MHz	
Freq Offset	0 Hz	0 Hz	
Signal Track	Off	--	
<b>SPAN</b>			
Span	6.5 GHz	40 MHz	
Ref Value	--	--	0 us
Scale/Div	--	--	2.99885 ms
Ref Position	--	--	Left
Auto Scale	--	--	Auto
<b>AMPT</b>			
Ref Level	0 dBm	0 dBm	
Attenuation	Auto, 10 dB	Auto, 10 dB	
RF Preamp	Off	Off	
Y Axis Unit	dBm	dBm	
Scale Type	Log	Log	
Scale/Div	10 dB	10 dB	
Max Mixer Lvl	-10 dBm	-10 dBm	
Ref Offset	0 dB	0 dB	
<b>BW</b>			
RBW	Auto, 10 MHz	Auto, 197.64 kHz (RBW2)	--
SPAN/RBW Ratio	Auto, 106	--	--
VBW	Auto, 10 MHz	--	--
VBW/RBW Ratio	Auto, 1	--	--
Filter Type	--	Gaussian	--
<b>Sweep</b>			

Sweep Points	801	--	
Sweep Time	Auto, 1 ms	--	
Acq Time	--	Auto, 31.9960 ms	Auto, 21.9855 ms
Sweep Time Mode	Continuous	Continuous	
Sweep Time Rule	Normal	--	
<b>Trigger</b>			
Trigger Source	Free Run	Free Run	
Trigger Holdoff	Off, 100 ms	Off, 100 ms	
Auto Trig	Off, 100 ms	Off, 0 us	
Slope	Positive	Positive	
Trig Delay	Off, 1 us	Off, 1 us	
Trigger Level	-25 dBm	--	
Acq/Trigger	--	1	
Power	--	0 dB	
Mask Type	--	Upper	
Trigger Mask	--	Upper	
Trigger Criteria	--	Enter	
Active Mask	--	Upper	
Frequency	--	0 Hz	
Amplitude	--	0 dB	
Build From Trace	--	Trace1	
X Offset	--	0 Hz	
Y Offset	--	0 dB	
X Axis Type	--	Relative	
Y Axis Type	--	Relative	
<b>Trace</b>			
Selected Trace	Trace1	Trace1	--
Trace Type	Clear Write	Clear Write	--
Trace Det	Normal	Pos Peak	Pos Peak
Detector Auto	On	On	On
Trace Update	On	On	On
Trace Display	On	On	On
Math Function	Off	Off	--
Op1	Trace5	Trace5	--
Op2	Trace6	Trace6	--
Offset	0 dB	0 dB	--
Reference	0 dB	0 dB	--
<b>TG<sup>[1]</sup></b>			
Output	Off	--	
Amplitude	-40 dBm	--	
Amplitude Offset	0 dB	--	
Normalize	Off	--	
Reference Level	0 dB	--	

Reference Position	100%	--
Reference Trace	Off	--
<b>Mode</b>		
Measurement Mode	GPSA	
<b>Mode Setup</b>		
Global CF Mode	Off, 3.25 GHz	Off, 3.25 GHz
<b>Meas<sup>[2]</sup></b>		
Measurement Function	Swept SA Measurement	Normal
<b>Measure Setup<sup>[2]</sup> (GPSA)</b>		
<b>Swept SA Measurement</b>		
Avg Number	100	
Avg Mode	Log	
Avg State	On	
Test Limits	Off	
Select Limit	Limit1	
Limit State	Off	
Test Trace	Trace1	
Limit Type	Upper	
X to CF	Relative	
Y to Ref	Relative	
Margin	Off, 0 dB	
Frequency	0 Hz	
Amplitude	0 dBm	
Build From Trace	Trace1	
X Offset	0 Hz	
Y Offset	0 dB	
Select Limit	Limit1	
Limit Type	Upper	
X To CF	Fixed	
Y To Ref	Fixed	
Margin	Off, 0 dB	
Test Trace	Trace1	
Test Limits	On	
Limit State	Off	
<b>T-Power</b>		
Avg Number	Off, 10	
Avg Mode	Exponential	
Avg State	On	
TP Type	Peak	
Start Line	0 us	
Stop Line	1 ms	
<b>ACP</b>		
Avg Number	Off, 10	

Avg Mode	Exponential
Avg State	On
Main Chan BW	2 MHz
Adj Chan BW	2 MHz
Chan Spacing	2 MHz
<b>Multichan Pwr</b>	
Avg Number	Off, 10
Avg Mode	Exponential
Avg State	On
Channel Span	3 GHz
Channel Sheet	Off
Channel Freq	3.25 GHz
<b>Occupied BW</b>	
Avg Number	Off, 10
Avg Mode	Exponential
Avg State	On
Max Hold	Off
OBW Span	2 MHz
Power Ratio	99%
<b>Emission BW</b>	
Avg Number	Off, 10
Avg Mode	Exponential
Avg State	On
Max Hold	Off
EBW Span	2 MHz
EBW X dB	-10 dB
<b>C/N Ratio</b>	
Avg Number	Off, 10
Avg Mode	Exponential
Avg State	On
Offset Freq	2 MHz
Noise BW	2 MHz
Carrier BW	2 MHz
<b>Harmo Dist</b>	
Avg Number	Off, 10
Avg Mode	Exponential
Avg State	On
No. of Harmo	10
Harmonic ST	1 ms
<b>TOI</b>	
Avg Number	Off, 10
Avg Mode	Exponential
Avg State	On
TOI Span	2 MHz



<b>Measure Setup<sup>[2]</sup>(RTSA)</b>			
<b>Normal</b>			
Avg Number	100		
Test Limits	Off		
Select Limit	Limit1		
Limit State	Off		
Test Trace	Trace1		
Limit Type	Upper		
X to CF	Relative		
Y to Ref	Relative		
Margin	Off, 0 dB		
Frequency	0 Hz		
Amplitude	0 dBm		
Build From Trace	Trace1		
X Offset	0 Hz		
Y Offset	0 dB		
<b>Density</b>			
Avg Number	100		
Persistence	300 ms		
Pers Inf	Off		
Color Palettes	Warm		
Highest Density Hue	100		
Lowest Density Hue	0		
Curve Nonlinearity	75		
Hue Truncate	Off		
<b>Spectrogram</b>			
Avg Number	100		
Display Trace	0		
Trace Selection	Trace Number		
Couple Marker Trace	Off		
Ref Hue	0		
Ref Hue Pos	100		
Bottom Hue Pos	0		
<b>SSC</b>			
Max Hold	Off		
Mark Line1	Off, 3.23 GHz		
Marker Line2	Off, 3.27 GHz		
Pass/Fail	Off		
Signal	1		
Ampt Up	-100 dBm		
Ampt Down	-100 dBm		
<b>Marker</b>			
Selected Marker	Marker1	Marker1	Marker1
Marker Mode	Position	Position	Position

Reference Marker	Marker2	Marker2	Marker2
Marker Trace	Auto, Trace1	Auto, Trace1	--
Marker Freq	3.25 GHz	3.25 GHz	14.9942 ms
Marker Readout	Frequency	Frequency	--
Readout Auto	On	On	--
Line State	Off	Off	Off
Couple Markers	Off	Off	Off
Marker Table	Off	Off	Off
<b>Peak</b>			
Cont Peak	Off	Off	
Pk-Pk Search	Maximum Value	Maximum Value	
Peak Threshold	On, -90 dBm	On, -90 dBm	
Peak Excursion	On, 6 dB	On, 6 dB	
Threshold Line	Off	Off	
Peak Table	Off	Off	
Peak Table Sort	Amplitude	Frequency	
Table Readout	All	All	
<b>Marker Func</b>			
N dB Bandwidth	Off, -3.01 dB	Off, -3.01 dB	--
Band Function	Off	Off	Off
Marker Counter Switch	Off	--	--
Gate Time	On, 100 ms	--	--
<b>System<sup>[3]</sup></b>			
Power On	Preset	Preset	
Preset Type	Default	Default	
Align Auto	On	On	
LAN Setting Mode	DHCP	DHCP	
Display Line	Off, -25 dBm	Off, -25 dBm	
Graticule	On	On	
HDMI	Off	Off	
HDMI Resolution	1024*768 60Hz	1024*768 60Hz	
LCD	On	On	
LCD Backlight	80%	80%	
Power Switch	Default	Default	
Beep Switch	Off	Off	
User key	Off	Off	
Language	English	English	

**Note<sup>[1]</sup>:** This function is only available for RSA5065-TG/RSA5032-TG working in GPSA mode.

**Note<sup>[2]</sup>:** This function is only available for RSA5000 installed with the corresponding option.

**Note<sup>[3]</sup>:** Not affected by Preset settings.

## User

User-defined shortcut key. For some hard-to-find but commonly used function menu, you can define it as shortcut key (for the defining method, refer to the introduction in "**User Key**"). After that, press the shortcut key under any operation interface to quickly open and set the desired menu or function.

**Note:** You can use the User key to define all the keys on the front panel and the sub-menus of these keys (except **Save**).

## Quick Save

Repeats the most recent save that was performed from the **Save** menu. Its saving path is the currently defined "quick save path". The register storage does not support Quick Save.

## Cont

Press this key to perform the continuous sweep operation. For details, refer to "**Continue**" in Chapter 2.

## Single

Press this key to perform the single sweep operation. For details, refer to "**Single**" in Chapter 2.



# Chapter 6 System Function

## System

Sets the system parameters.

### Preset

Functions include: select the instrument settings to be recalled after the analyzer is powered on ("Last" or "Preset"); set the preset type ("Factory" or one of the items from "User1" to "User6"); save preset.

#### 1. Power On

Sets the power on setting to "Last" or "Preset".

- When "Last" is selected, the last system settings before power-off would be recalled automatically at power-on.
- When "Preset" is selected, settings defined in **Preset Type** would be recalled automatically at power-on.

#### 2. Preset Type

Sets the preset type to "Default" (by default) or any one of the items from "User1" to "User6".

- When Power On is set to "Preset", the specified preset type will be recalled at power-on.
- After the instrument starts, press **Preset** on the front panel in any operation interface will recall the specified preset type.

#### 3. Save User Preset

Saves the current system setting as user-defined settings to the internal non-volatile memory. You can store up to 6 system states (correspond to "User1" to "User6" in the preset type) and name each state file.

When one of the items from "User1" to "User6" is selected under **Preset Type**, press **Save User Preset**, and the then automatically enter the filename input interface. Then, perform the saving operation.

## Alignment

### 1. Align Now

Press this key and the analyzer will use the internal calibration source to perform a self-calibration immediately.



### 2. Align Auto

Enables or disables self-calibration. If self-calibration is enabled, the analyzer will perform one self-calibration after being started.

## Interface

The analyzer supports the LAN or USB communication interface.

### 1. LAN

Sets the LAN parameters. Tap the setting information icon  at the top of the user interface or use the externally connected mouse to click the icon, and then click the network setting icon . Then, the LAN parameter setting interface, as shown below, is displayed.

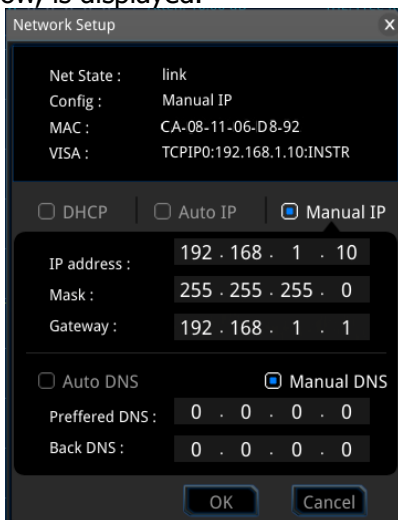

Figure 6-1 LAN Parameter Setting

The following items can be set by the front panel keys, the keyboard shortcut keys, the externally connected mouse, the touchscreen, or remote operation.

### 1) Mode

Sets the mode of obtaining the IP address.

- DHCP: When DHCP is selected, the DHCP server assigns network parameters (such as the IP address, subnet mask, and gateway) to the

analyzer based on the current network configuration.

- Auto: When "Auto" is selected, the instrument will acquire the IP address ranging from "169.254.0.1" to "169.254.255.254" and the subnet mask (255.255.0.0) automatically based on the current network configuration.
- Manual: When "Manual" is selected, you can self-define a desired IP address for the analyzer.

**Note:** The analyzer attempts to acquire the IP address configuration according to the sequence of DHCP, Auto IP, and Manual IP. These three methods cannot be disabled at the same time.

## 2) IP

Press **IP** and use the numeric keys to input the desired IP address.

The format of the IP address is "nnn.nnn.nnn.nnn". The range for the first segment (nnn) of the address is from 1 to 223 (except 127); and the range for the other three segments is from 0 to 255. You are recommended to ask your network administrator for an IP address available.

## 3) Subnet mask

Press **Mask** and use the numeric keys to input the desired subnet mask.

The format of the subnet mask is nnn.nnn.nnn.nnn; wherein, the range of "nnn" is from 0 to 255. You are recommended to ask your network administrator for a subnet mask available.

## 4) Gateway

Press **Gateway** and use the numeric keys to input the desired gate address.

The format of the default gateway is "nnn.nnn.nnn.nnn". The range for the first segment (nnn) of the address is from 1 to 223 (except 127); and the range for the other three segments is from 0 to 255. You are recommended to ask your network administrator for a gate address available.

## 5) DNS

- mDNS: enables or disables the sending of the network information (including IP address, host name, etc.).
- DNS Mode: Sets the mode of obtaining the DNS address to be "Manual" or "Auto".
- Preferred DNS: Sets the preferred address for the DNS.
- Backup DNS: Sets the backup address for the DNS.

The format of the DNS address is "nnn.nnn.nnn.nnn". The range for the first segment (nnn) of the address is from 1 to 223 (except 127); and the range for the other three segments is from 0 to 255. You are recommended to ask your network administrator for an address available.

## 6) Apply

After the LAN interface configuration is finished, press this key to apply the current configuration to the instrument.

### 7) Reset

Turns on DHCP and Auto-IP; turns Manual-IP off. Clears the set network password and restores it to the factory defaults.

## 2. USB

RSA5000 provides a USB DEVICE interface on the rear panel. The analyzer may serve as a "slave" device to be connected to the PC via this interface.

## Display

Controls the screen display. You can set the current mode, the current measurement interface or window, and other display-related parameters.

### 1. Display Line State

Turns on or off the display line.

### 2. Display Line

Sets the display line level to change its display location. This line can be used as either the reference for you to read the measurement result or the threshold condition for the peaks displayed in the peak table.

#### Remarks:

- This line is a horizontal reference of which the amplitude is equal to the set value, and the corresponding amplitude unit is the same as the Y-axis unit.
- You can use the numeric keys, the knob, and the arrow keys on the front panel to modify the display line level; also you can modify it on the touchscreen. For details, refer to descriptions in "**Parameter Setting**".
- If there are multiple windows in the user interface, the settings of the display line take effective in the selected window.
- If the display line is out of the visible range, it will be displayed at the top or bottom of the graticule, and indicated by arrows.

Table 6-1 Display Line Level

Parameter	Remarks
<b>Default</b>	-25 dBm
<b>Range</b>	Current amplitude range
<b>Unit</b>	dBm, -dBm, V, mV, uV
<b>Knob Step</b>	In Log scale mode, step = scale/10
<b>Left/Right Arrow Key Step</b>	In Lin scale mode, step = 0.1 dB
<b>Up/Down Arrow Key Step</b>	In Log scale mode, step = scale In Lin scale mode, step = 1 dB



**3. Graticule**

Enables or disables the display of the graticule.

**4. HDMI**

Enables or disables HDMI.

**5. HDMI Resolution**

Selects the resolution supported by HDMI interface to be "1024\*768 60Hz", "1280\*720 60Hz", "640\*480 60Hz", or "720\*480 60Hz".

**6. LCD**

Enables or disables LCD.

**Remarks:**

- If you are not updating data, turning off LCD can improve the measurement speed.
- To reduce the electromagnetic radiation of some circuit component, turn off the LCD.
- To avoid misoperation, turn off the LCD.

**7. LCD Backlight**

Sets the brightness of the LCD backlight.

The brightness is expressed in percentage. When it is 100, it indicates that the backlight is the brightest; when it is 1, the backlight is the darkest.

**About System**

Displays the system information or the option information.

**1. System Info**

- Model
- Serial Number
- Hardware Version Number
- Firmware Version Number
- Software Version

**2. Option Info**

Displays the option information.

RSA5000 provides many kinds of options to meet various measurement requirements. To purchase the corresponding option, please contact **RIGOL**.

**3. Self Test****● Screen**

Tests whether the screen has a dot defect by using six colors: blue, red, green, gray, white, and black. Press any key to switch the screen color and

exit the test.

- **Multi-point Touch**

Enters the multi-point touch test interface. Use multiple fingers to make pinch or stretch gestures on the screen, and observe the size of the characters. If they do not change along with your gestures, it indicates that problems occurred to the multi-point touch function. To exit the test, press **Esc** for three consecutive times.

- **Single-point Touch**

Enters the single-point touch test interface. Touch or use the mouse to make stretch or strike gestures on the screen, if the corresponding traces are displayed, then it indicates that the point on the touchscreen is valid. To exit the test, press **Esc** for three consecutive times.

- **Keyboard**

Enter the keyboard test interface. Press the function keys on the front panel one by one and observe whether the corresponding key is illuminated. If not, an error may have occurred to that key. To exit the test, press **Esc** for three consecutive times.

**Note:** For the transparent keys on the front panel, they will be also illuminated during the test.

#### 4. License Info

Displays the license registration information about the components such as Linux and QT.

#### 5. Online Update

Connect the analyzer to the external network by using the network cable. If you do not have the right to access the Internet, please ask the administrators to grant your right to access the external internet first. Then, press this key to update the software.

## Date/Time

Sets the system date and time.

### 1. Set Time

Sets the displayed system time of the analyzer. Press the **Hour**, **Minute**, and **Second** softkeys respectively to set the time.

### 2. Set Date

Sets the displayed system date of the analyzer. Press the **Year**, **Month**, and **Day** softkeys respectively to set the date. You can also press **Date Format** to select whether the date is displayed in "YMD" or "MDY" form.

## Security Clear

Press this key to perform the security clear function. This function includes the following operations:

- Deletes all the files that users have saved, including the state files, trace state files, screen files, measdata files, and limit files saved by users in all modes.
- Executes the factory resetting operation.

## Language

RSA5000 supports multi-language menu, Chinese and English built-in help and pop-up messages.

Press this key to select the desired display language.

## Settings

### 1. Power Switch

Sets whether the power switch on the front panel is effective or not.

- Default: When the analyzer is powered on, press the power switch on the front panel to start up the analyzer.
- Always: When the analyzer is powered on, it starts automatically.

### 2. Beep Switch

Turns on or off the beeper.

### 3. Volume

After you turn on the beeper, you can press this key to adjust the volume of the beeper.

### 4. User Key

Defines an associated function for the **User** key on the front panel. The definition method is as described below. After that, pressing **User** in any operation interface can quickly enable the defined function.

- Press **User Key** to select "On";
- Open the function menu that needs to be defined. For example, press **System** → **Display** → **Display Line**;

Press **User** and the definition is finished. At this time, **User Key** turns off automatically.

### 5. SCPI Display

When you use the SCPI commands to control the instrument remotely, turning on the SCPI Display will go to the specified menu of the corresponding command; turning off the SCPI Display will not go to the specified menu.

## Messages

Press this key, and then a prompt message dialog box will be displayed. You can press the corresponding softkey to select to view all the messages, the messages that have been read or not read. You can also use the touch screen or the externally connected mouse to tap or click the specified icon in the prompt message dialog box.

- 1. Select All**  
Selects all the displayed messages.
- 2. Select Read**  
Only selects the messages that have been read.
- 3. Select Unread**  
Only selects the messages that have not been read.
- 4. Delete**  
Deletes the selected messages.
- 5. Query All**  
Views all the displayed messages.
- 6. Query Read**  
Only views the messages that have been read.
- 7. Query Unread**  
Only views the messages that have not been read.

## File

RSA5000 allows you to save various types of files to the internal or external memory, and recall them when necessary.

Press **File** on the front panel to enter the file operation menu interface.

## File Explorer

Press the key to enter the file manager interface. You can use the touch gestures to tap the screen or use the mouse to click on the screen to select the corresponding file or folder. Displays all the files with the specified file types. When you select a file, you can press the **Copy**, **Paste**, or **Delete** softkeys to copy, paste, or delete the specified file.

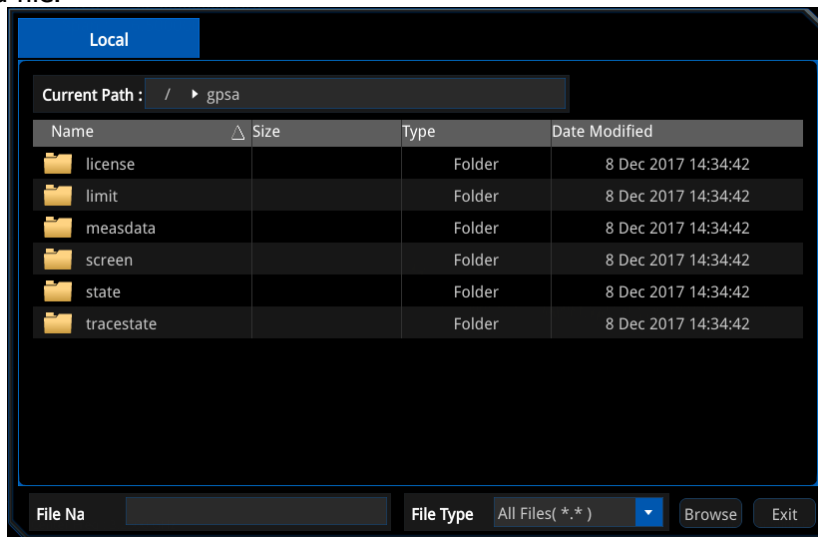

Figure 6-2 File Manager

The available file types include: State, Trace+State, Measurement Data, Limit, Screen Image, License, FMT, and All (all the above file types). The descriptions for various file types are shown in the following table.

Table 6-2 Descriptions of File Type

File Type	Format	Suffix Name
State	BIN	.sta
Trace+State	BIN	.trs
Measurement Data	CSV	.csv
Limit	CSV	.csv
Screen Image	IMAGE	.jpg/bmp/png
License	LICENSE	.lic
FMT	CSV	.csv

**Note:** RSA5000 can only recognize files whose filenames consist of Chinese characters, English letters, or numbers. If the filename or folder name contains other characters, the file or the folder might not be displayed normally in the file manager interface.

## Copy

Copies the currently selected file or folder.

## Paste

Pastes the file or folder.

When the current path has contained a file or folder whose name is the same as the one that you want to paste, after you perform the paste operation, the original file or folder will be overwritten.

## Rename

Rename a file that has been stored. After you select a file, press this key to input a new filename.

## Delete

Deletes the selected file.

## New Folder

Creates a folder. Press this key to create a new empty folder under the current directory, and the file is named with a default filename. To modify this filename, press **Rename** to rename the file.

## Quick Print

If the printer has been successfully installed, press this key to quickly print the currently displayed screen image.

## Print

Prints the current screen according to print parameter settings when the printer has been successfully installed and is in idle state.

## Printer Setup

### 1. Printer Parameters

#### 1) Page Size

Sets the page size for printing. When "Default" is selected, the page size depends on the printer currently connected.

#### 2) Quality

Sets the print quality.

#### 3) Color

Sets the print color to Color, Mono, Inverse, or Inverse-Mono.

#### 4) Orientation

Sets the print orientation to "Landscape" or "Portrait".

#### 5) Adjust

Sets the print border to be Adaptive, Non-Adpt, and Hold Min.

#### 6) Counts

Sets the print copies and the default is 1. The range available is from 1 to 99.

#### 7) Border

Turns on or off the border.

In addition, you can preview the print page, and set to print the image or the text in All page, 1/2, 1/4, or 1/9 page.

## 2. Add Device

Queries and adds a printer. Inputs the IP address of the printer, the manufacturer of the printer, the printer model, and printer drive. Then, the printer is added.

## 3. Select Device

Selects the desired printer.

## Import License

In the file manager interface, select a file to be imported and then press **Import License** to import the file.

## System Update

Press this key to update the analyzer software after selecting the update file in the USB storage device.



## Recall

RSA5000 allows you to recall various types of files saved to the internal or external storage memory.

Press **Recall** on the front panel to enter the file recalling menu. The available file types include: State, Trace+State, Measurement Data, Limit, and FMT (only available for RTSA).

### State

Press **State** to enter the state recalling menu. The state can be recalled from the register or the file.

#### 1. Recall

Press **File Explorer** to enter the file manager interface. Select a file and then press **Recall** to recall the file from a register or a file.

#### 2. Register1 through Register16

When any one of the items from Register1 to Register16 is selected, the state of the specified register will be recalled.

### Trace+State

Press **Trace+State** to enter the trace+state recalling menu. The state of the instrument and the selected trace can be recalled from a register or a file.

#### 1. Recall

Press **File Explorer** to enter the file manager interface. Select a file and then press **Recall** to import the file.

#### 2. To Trace

Selects the trace+state file or the trace data of the register to recall them to the selected trace.

#### 3. Register1 through Register16

When any one of the items from Register1 to Register16 is selected, the state of the specified register will be recalled.

## Measurement Data

Press **Measurement Data** to enter the measurement data recalling menu.

### 1. Recall

Press **File Explorer** to enter the file manager interface. Select a file and then press **Recall** to recall the file.

### 2. To Trace

Selects the measurement data file and recalls it to the selected trace.

## Limit

Press **Limit** to enter the limit recalling menu.

### 1. Recall

Press **File Explorer** to enter the file manager interface. Select a file and then press **Recall** to recall the file.

### 2. To Limit

Selects the limit line file and recalls it to the selected limit line.

## FMT (only available for RTSA)

Press **FMT** to enter the FMT recalling menu.

### 1. Recall

Press **File Explorer** to enter the file manager interface. Select a file and then press **Recall** to recall the file.

### 2. To Mask

Selects the FMT file to recall it to the selected mask.

## Save

RSA5000 allows you to save various types of files to the internal or external memory.

Press **Save** on the front panel to enter the file saving menu. The available file types include: State, Trace+State, Measurement Data, Limit, Screen Image, and FMT (only available for RTSA).

## State

Press **State** to enter the state saving menu. The state can be saved to the register or the file.

### 1. Save

Press this key to save the current state in the default filename or user-defined filename.

The default state filename is determined by the following methods:

- If you haven't input a filename by pressing the **Save As** key, its default filename is state<n>.sta. Wherein, n refers to the file number of the filenames that are named based on the naming mode in the current file directory. The value of <n> is the existing maximum file number plus 1. For example, if 3 files (state1.sta、state2.sta、state5.sta) exist in the current directory, then the new filename for the file that you want to save should be state6.sta by default.
- If you have pressed the **Save As** key to input the filename abc, then the file is saved to be "abc.sta". After that, press the **Save** key again, another file is saved automatically with the filename "abc1.sta".

### 2. Save As

Press this key and then use the numeric keypad on the front panel to input the filename. Then, press **Save** to save the corresponding state file.

You can also touch the screen or use the mouse to touch or click the **Save As** menu, and then input the filename with the keypad.

### 3. Register1 through Register16

When any one of the items from Register1 to Register16 is selected, the current state of the instrument will be saved to the corresponding register. The register supports quick save and recalling instrument state. The register menu displays the time for saving the instrument state.

## Trace+State

Press **Trace+State** to enter the trace+state saving menu. The state of the instrument and the selected trace can be saved to the register or the file.

### 1. Save

Press this key to save the current trace+state file in the default filename or user-defined filename.

The default filename is determined by the following methods:

- If you haven't input a filename by pressing the **Save As** key, its default filename is tracestate<n>.trs. Wherein, n refers to the file number of the filenames that are named based on the naming mode in the current file directory. The value of <n> is the existing maximum file number plus 1.
- If you have pressed the **Save As** key to input the filename abc, then the file is saved to be "abc.trs". After that, press the **Save** key again, another file is saved automatically with the filename "abc1.trs".

### 2. Save As

Press this key and then use the numeric keypad on the front panel to input the filename. Then, press **Save** to save the corresponding trace+state file.

You can also touch the screen or use the mouse to touch or click the **Save As** menu, and then input the filename with the keypad.

### 3. Save From Trace

Selects the trace to be saved. You can select any single trace from Trace1 to Trace6.

### 4. Register1 through Register16

When any one of the items from Register1 to Register16 is selected, the current state of the instrument will be saved to the corresponding register. The register supports quick save and loading instrument state. The register menu displays the time for saving the instrument state.

## Measurement Data

Press **Measurement Data** to enter the measurement data saving menu. The selected measurement data type (e.g. trace, measurement results, peak table, or marker table) can be saved to the specified file. The data will be saved in .csv format. They are separated with a comma, and this is convenient for you to use the Excel to analyze the data.

### 1. Save

Press this key to save the currently selected type of measurement data in the default filename or user-defined filename.

The default filename is determined by the following methods:

- If you haven't input a filename by pressing the **Save As** key, its default filename is measdata<n>.csv. Wherein, n refers to the file number of the filenames that are named based on the naming mode in the current file directory. The value of <n> is the existing maximum file number plus 1.
- If you have pressed the **Save As** key to input the filename abc, then the file is saved to be "abc.csv". After that, press the key again, another file is saved automatically with the filename "abc1.csv".

### 2. Save As

Press this key and then use the numeric keypad on the front panel to input the filename. Then, press **Save** to save the corresponding Measurement Data file.

You can also touch the screen or use the mouse to touch or click the **Save As** menu, and then input the filename with the keypad.

### 3. Save From Trace

If the data to be saved are traces, select the trace to be saved. You can select any single trace from Trace1 to Trace6.

### 4. Data Type

Selects the measurement data type to be saved. The data types supported by the instrument include trace, peak table, marker table, and measurement results.

## Limit

Press **Limit** to enter the limit line saving menu. The selected limit line is saved to the file.

### 1. Save

Press this key to save the currently selected limit line in the default filename or user-defined filename.

The default filename is determined by the following methods:

- If you haven't input a filename by pressing the **Save As** key, its default filename is limit<n>.csv. Wherein, n refers to the file number of the filenames that are named based on the naming mode in the current file directory. The value of <n> is the existing maximum file number plus 1.
- If you have pressed the **Save As** key to input the filename abc, then the file

is saved to be "abc.csv". After that, press the key again, another file is saved automatically with the filename "abc1.csv".

## 2. Save As

Press this key and then use the numeric keypad on the front panel to input the filename. Then, press **Save** to save the corresponding Limit file.

You can also touch the screen or use the mouse to touch or click the **Save As** menu, and then input the filename with the keypad.

## 3. Select Limit

Selects the limit line to be saved. You can select any single limit line from Limit1 to Limit6.

## Screen Image

Press **Screen Image** to enter the screen saving menu.

### 1. Save

Press this key to save the current screen image in the default filename or user-defined filename.

The default filename is determined by the following methods:

- If you haven't input a filename by pressing the **Save As** key, its default filename is screen<n>.jpg. Wherein, n refers to the file number of the filenames that are named based on the naming mode in the current file directory. The value of <n> is the existing maximum file number plus 1.
- If you have pressed the **Save As** key to input the filename abc, then the file is saved to be "abc.jpg". After that, press the key again, another file is saved automatically with the filename "abc1.jpg".

### 2. Save As

Press this key and then use the numeric keypad on the front panel to input the filename. Then, press **Save** to save the corresponding Screen Image file.

You can also touch the screen or use the mouse to touch or click the **Save As** menu, and then input the filename with the keypad.

### 3. Screenshot Info

#### 1) Format

Press this key to select the file format of the current screen image to be "JPEG", "BMP", or "PNG".

- 2) Color Type  
Press this key to select the color of the current screen image to be "Normal" or "Inverted".

## FMT (only available for RTSA)

Press **FMT** to enter the FMT file saving menu. Save the selected FMT file to the file.

### 1. Save

Press this key to save the currently selected FMT file in the default filename or user-defined filename.

The default filename is determined by the following methods:

- If you haven't input a filename by pressing the **Save As** key, its default filename is FMT<n>.csv. Wherein, n refers to the file number of the filenames that are named based on the naming mode in the current file directory. The value of <n> is the existing maximum file number plus 1.
- If you have pressed the **Save As** key to input the filename abc, then the file is saved to be "abc.csv". After that, press the key again, another file is saved automatically with the filename "abc1.csv".

### 2. Save As

Press this key and then use the numeric keypad on the front panel to input the filename. Then, press **Save** to save the corresponding FMT file.

You can also touch the screen or use the mouse to touch or click the **Save As** menu, and then input the filename with the keypad.

### 3. Select FMT

Selects the FMT to be saved.

## Quick Save Path

Open the file explorer interface, and then select the corresponding path. Press the **Quick Save Path** softkey to set the current path to be the quick save path.





# Chapter 7 Remote Control

You can control RSA5000 series spectrum analyzer through USB or LAN remote interface. This chapter introduces remote control and the control method.

Contents in this chapter:

- Remote Control Overview
- Remote Control via USB
- Remote Control via LAN

# Remote Control Overview

RSA5000 can be connected to the PC via the USB or LAN interface to set up communication and realize remote control through the PC. The remote control can be realized by using SCPI (Standard Commands for Programmable Instruments) commands. It can be realized through the following two methods:

## 1. User-defined programming

You can program and control the instrument by using the SCPI commands on the basis of NI-VISA (National Instrument – Virtual Instrument Software Architecture) library. For details about the SCPI commands and programming, refer to *RSA5000 Programming Guide*.

## 2. PC software

You can use the PC software (Ultra Sigma) to send the SCPI commands to remotely control the instrument.

This Chapter introduces in details how to use Ultra Sigma to send commands through each kind of interface to control the analyzer. Please refer to Ultra Sigma help documentation to install the software and the required components correctly. You can download the latest version of the software from [www.rigol.com](http://www.rigol.com).

**Note:** When the instrument is in remote mode, the front panel keys (except the Power key  and **Esc**) are locked. At this time, you can press **Esc** to exist the remote mode.

## Remote Control via USB

### 1. Connect the load to the PC

Use a USB cable to connect the analyzer (USB Device) with the PC (USB Host).

### 2. Install the USB driver

The analyzer is a USBTMC device. After you connect the analyzer to the PC properly and power it on for the first time (the analyzer will be automatically configured with the USB interface). In this case, "Found New Hardware Wizard" dialog box appears on the PC. Please install "USB Test and Measurement Device (IVI)" according to the instructions.

### 3. Search for the device resource

Start up Ultra Sigma (here we assume that you have installed Ultra Sigma properly) and the software will automatically search for the resource currently connected to the PC. You can also click  to search for the resource.

### 4. View the device resource

The resources found will appear under the "RIGOL Online Resource" directory, and the model number and USB interface information of the instrument will also be displayed.

For example, RSA5065 (USB0::0x1AB1::0xA4A9::L355010000000::INSTR).

### 5. Communication test

Right-click the resource name "RSA5065 (USB0::0x1AB1::0xA4A9::L355010000000::INSTR)" and select "SCPI Panel Control" to turn on the remote command control panel, through which you can send commands and read data. For details about the SCPI commands and programming, refer to *RSA5000 Programming Guide*.

## Remote Control via LAN

### 1. Connect the analyzer to the PC

Use the network cable to connect the analyzer to the PC or the local area network (LAN) where the PC resides.

### 2. Configure network parameters

Sets the network parameters according to the descriptions in "**Interface** → **LAN**".

### 3. Search for the device resource

Start up Ultra Sigma and click **LAN**. Then, click **Search** in the pop-up window, and the software starts searching for the analyzer resources connected to LAN. When a LAN resource is found, its name will be displayed in the resource box on the right side of the panel. Select the desired resource and click **OK** to add the resource.

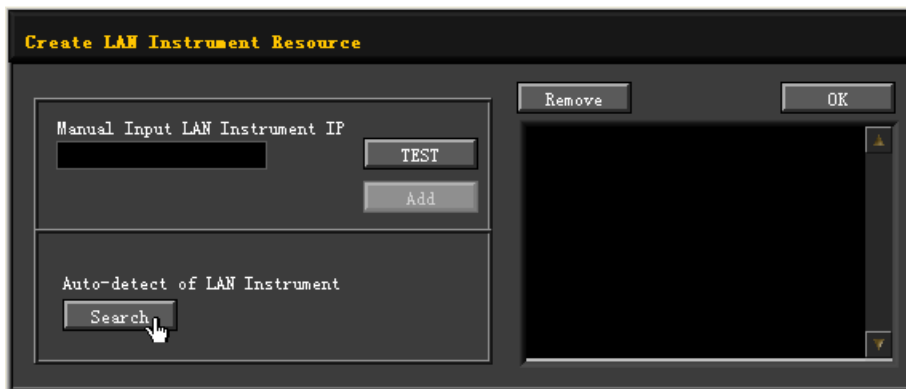

**Note:** The IP address of the selected resource should be consistent with that of the LAN interface. If you want to remove the resource, please select the resource name, and then click **Remove** to remove it.

### 4. View the device resource

The resources found are shown under the "RIGOL Online Resource" directory. For example, RSA5065 (TCPIP::172.16.3.194::INSTR).

### 5. Communication test

Right-click the resource name "RSA5065 (TCPIP::172.16.3.194::INSTR)" and select "SCPI Panel Control" to turn on the remote command control panel, through which you can send commands and read data.

### 6. Load LXI webpage

As the analyzer conforms to LXI CORE 2011 DEVICE standards, you can load LXI webpage through Ultra Sigma (right-click the instrument resource name and

select "LXI-Web"). Various important information about the instrument (including the model, manufacturer, serial number, description, MAC address, and IP address) will be displayed on the webpage.

**Note:** If you want to view or modify the network settings of this instrument, please click **Network Settings** and then a pop-up window is displayed. Input "rigol" ("rigol" must be in lowercase form, without quotation marks) in the user name and the password fields. Besides, you can click **Security** to reset the password.

**Tip:**

You can also directly input the IP address of the analyzer in the address bar of the PC browser to load the LXI webpage.



# Chapter 8 Troubleshooting

The commonly encountered failures of the analyzer and their solutions are listed below. If the following problems occur, locate and resolve the problems according to the following steps. If the problems still persist, contact **RIGOL** and provide your instrument information to us. (For instrument information, press **System** → **About System** → **System Info**.)

## 1. When I power on the instrument, the analyzer stays black and does not display anything.

- (1) Check whether the fan works normally.
  - If the fan works normally, but the screen stays black, check whether the connecting cable that connects the screen is loose.
  - If the fan does not work normally, it indicates that the instrument has failed to start up. Please handle it according to the method specified in Step (2).
- (2) Check the power source.
  - Check whether the power supply has been connected correctly and the power switch has been turned on.
  - Check whether the fuse is burned. If you need to replace the fuse, please use the specified fuse (AC 250V, T3.15A).

## 2. One or more keys on the keyboard does/do not respond, and stuck keys are found.

- (1) After you power on the instrument, check whether all the keys are unresponsive.
- (2) Press **System** → **About System** → **Self Test** → **Keyboard**, and check whether there are unresponsive keys or stuck keys.
- (3) If the above problems are found, check whether the keyboard cables are loose or the keypad is damaged. Do not disassemble the instrument by yourself, please contact **RIGOL**.

## 3. The spectral lines on the screen haven't been updated for a long time.

- (1) Check whether the screen is locked or not. If yes, press **Esc** to unlock it.
- (2) Check whether all the trigger conditions have been met and whether there is a valid trigger signal.
- (3) Check whether the analyzer is in single sweep.
- (4) Check whether the set current sweep time is too long.

## 4. Errors or poor precision were found in the measurement results.

To calculate the system errors and check the measurement results/precision, refer to the introductions in the "Specifications". To achieve the requirements of the specifications specified in this manual, perform the following operations.

- (1) Check whether all the external devices are successfully connected and are working normally.

- (2) Get an understanding about the signal under test, and configure appropriate parameters for the instrument.
- (3) Make measurements under proper conditions. For example, warm up the instrument for a while, or operate the instrument under the specified working temperature.
- (4) Calibrate the instrument regularly to reduce or avoid measurement errors that might occur due to device aging.
  - If you need calibration after the stated calibration period expires, contact **RIGOL** or get paid service from authorized measurement agencies.
  - The analyzer provides self-calibration function. If required, press **System** → **Alignment** → **Align Auto** and select "On". The analyzer will perform one self-calibration after being started.
  - Press **System** → **Alignment** → **Align Now** to make a self-calibration immediately.

## 5. Prompt Message

A prompt message will be displayed based on its working state, such as the tip message, error message, or state message. These messages are displayed to help you use the instrument properly, and do not indicate that there is something wrong with the instrument.



## Chapter 9 Appendix

### Appendix A: RSA5000 Accessories and Option List

	Description	Order No.
Model	Real-time Spectrum Analyzer, 9 kHz to 3.2 GHz	RSA5032
	Real-time Spectrum Analyzer, 9 kHz to 6.5 GHz	RSA5065
	Real-time Spectrum Analyzer, 9 kHz to 3.2 GHz (include TG)	RSA5032-TG
	Real-time Spectrum Analyzer, 9 kHz to 6.5 GHz (include TG)	RSA5065-TG
	Real-time Spectrum Analyzer, 9 kHz to 3.2 GHz (include TG and VNA)	RSA5032N
	Real-time Spectrum Analyzer, 9 kHz to 6.5 GHz (include TG and VNA)	RSA5065N
Standard Accessories	Quick Guide (hard copy)	-
	Power Cable	-
Option	Vector Signal Analysis Measurement Application	RSA5000-VSA
	EMI Measurement Application	RSA5000-EMI
	Preamplifier (PA)	RSA5000-PA
	High Stability Clock	OEXO-C08
	Real-time/Analysis Bandwidth 40 MHz	RSA5000-B40
	Advanced Measurement Kit	RSA5000-AMK
	Spectrum Analyzer PC Software	Ultra Spectrum
	EMI Pre-compliance Test Software	S1210 EMI Pre-compliance Software
Optional Accessories	High-performance Network Analysis Calibration Kit (frequency range: DC to 6.5 GHz)	CK106A
	Economical Network Analysis Calibration Kit (frequency range: DC to 1.5 GHz)	CK106E
	Include: N-SMA cable, BNC-BNC cable, N-BNC adaptor, N-SMA adaptor, 75 $\Omega$ -50 $\Omega$ adaptor, 900 MHz/1.8 GHz antenna (2pcs), 2.4 GHz antenna (2pcs)	DSA Utility Kit
	Include: N(F)-N(F) adaptor (1pcs), N(M)-N(M) adaptor (1pcs), N(M)-SMA(F) adaptor (2pcs), N(M)-BNC(F) adaptor (2pcs), SMA(F)-SMA(F) adaptor (1pcs), SMA(M)-SMA(M) adaptor (1pcs), BNC T type adaptor (1pcs), 50 $\Omega$ SMA load (1pcs), 50 $\Omega$ BNC impedance adaptor (1pcs)	RF Adaptor Kit
	Include: 50 $\Omega$ to 75 $\Omega$ adaptor (2pcs)	RF CATV Kit
	Include: 6 dB attenuator (1pcs), 10 dB attenuator (2pcs)	RF Attenuator Kit
	30 dB high-power attenuator, with the max power of 100 W	ATT03301H
	N(M)-N(M) RF Cable	CB-NM-NM-75-L-1 2G
	N(M)-SMA(M) RF Cable	CB-NM-SMAM-75-L-12G
	VSWR Bridge, 1 MHz to 3.2 GHz	VB1032

	VSWR Bridge, 2 GHz to 8 GHz	VB1080
	Near-field Probe	NFP-3
	Rack Mount Kit	RM6041
	USB Cable	CB-USBA-USBB-FF-150

**Note: For more details about the accessories and the options, please contact RIGOL sales representatives or the local distributors.**

## **Appendix B: Warranty**

**RIGOL** TECHNOLOGIES CO., LTD. (hereinafter referred to as **RIGOL**) warrants that the product will be free from defects in materials and workmanship within the warranty period. If a product proves defective within the warranty period, **RIGOL** guarantees free replacement or repair for the defective product.

To get repair service, please contact with your nearest **RIGOL** sales or service office.

There is no other warranty, expressed or implied, except such as is expressly set forth herein or other applicable warranty card. There is no implied warranty of merchantability or fitness for a particular purpose. Under no circumstances shall **RIGOL** be liable for any consequential, indirect, ensuing, or special damages for any breach of warranty in any case.



# Index

3rd Order Lower .....	2-62	Keyboard Test .....	6-6
3rd Order Upper .....	2-62	LAN .....	6-2
ACP .....	2-35, 2-45	Last Span .....	2-8, 3-3
Acq Times/Trigger .....	3-10	Main Channel Bandwidth .....	2-46
Adjacent Channel Bandwidth.....	2-46	Main Channel Power .....	2-45
Auto .....	6-3	Manual IP .....	6-3
Auto Search .....	5-1	Marker Table .....	2-71
Average (RMS) .....	2-27	Marker Trace .....	2-68
Average Mode .....	2-43	Mask Type .....	3-11
Average Power .....	2-43	Max Hold .....	2-26, 2-52, 2-55
Avg Number .....	2-42	Min Hold .....	2-26
Base Lower .....	2-62	Mkr->CF .....	2-73
Base Upper .....	2-62	Mkr->Ref .....	2-74
C/N Ratio .....	2-36, 2-57	Mkr->Start .....	2-73
Cal Open .....	2-65	Mkr->Step .....	2-73
Carrier BW .....	2-58	Mkr->Stop .....	2-73
Carrier Power .....	2-57	Mkr $\Delta$ ->CF .....	2-74
Center Frequency .....	2-3	Mkr $\Delta$ ->Span .....	2-74
CF step .....	2-5	Multi-channel Power .....	2-35
Channel Power .....	2-48	Multi-point Touch .....	6-6
Channel Spacing .....	2-47	N dB Bandwidth .....	2-75
Clear Write .....	2-26	Next Peak .....	2-79
Cont Peak .....	2-80	Next Peak Left .....	2-79
Delta Marker .....	2-67	Next Peak Right .....	2-79
Density .....	3-18	No. of Harmo .....	2-61
Density Spectrogram .....	3-20	Noise BW .....	2-58
DHCP .....	6-2	Noise Power .....	2-57
Display Line .....	6-4	Normal .....	3-17
EBW .....	2-36, 2-54	Normalization Reference Level ....	2-33
EBW X dB .....	2-55	Normalize .....	2-33
FMT .....	3-11	OBW .....	2-36, 2-51
Free Run .....	2-22	OCXO .....	1-16
Full Span .....	2-9	Offset Frequency .....	2-58
Gateway .....	6-3	Peak Power .....	2-43
Graticule Brightness .....	6-5	Peak Table .....	2-82
Harmonic Distortion .....	2-36	Pk-Pk Search .....	2-80
Harmonic ST .....	2-61	Power On .....	6-1
IF Power Trigger .....	3-10	Power Ratio .....	2-53
Input Attenuation .....	2-10	Power Spectral Density .....	2-48
Input Impedance .....	4-1	Preset .....	5-3, 6-1
Intercept .....	2-62	Preset Type .....	6-1
IP .....	6-3	PvT .....	3-21
ITime .....	2-70	PvT Spectrogram .....	3-23

---

PvT Spectrum .....	3-22	Start Line .....	2-43
RBW.....	2-14	Stop Freq .....	2-4
Readout.....	2-69	Stop Line.....	2-43
Reference Level.....	2-9	Subnet Mask.....	6-3
Reference Level Offset .....	2-13	Sweep Time .....	2-18
Reference Marker .....	2-67	System Info.....	6-5
Reference Position .....	2-34	TOI.....	2-36
Reference Trace.....	2-34	TP Type.....	2-43
Reset .....	2-64	T-Power .....	2-35, 2-42
RMS .....	2-43	Tracking Generator .....	2-32
Sample.....	2-27	USB .....	6-4
Save Preset.....	6-1	VBW .....	2-14
Save Ref Trace .....	2-34	VBW/RBW Ratio.....	2-16
Scale Type .....	2-12	Video .....	2-22
Screen Test.....	6-5	Video Bandwidth.....	2-14
Signal Track .....	2-6	VSWR .....	2-37, 2-65
Single-point Touch .....	6-6	VSWR Ref Level .....	2-65
Span .....	2-8, 2-52, 2-63, 3-2	Y Axis Unit.....	2-11
Spectrogram .....	3-19	Zero Span .....	2-9
Start Freq .....	2-4		