

RIGOL

Quick Guide

English

中文

MSO8000 Series Digital Oscilloscope

Jul. 2019

RIGOL (SUZHOU) TECHNOLOGIES INC.

Guaranty and Declaration

Copyright

© 2019 **RIGOL** (SUZHOU) TECHNOLOGIES INC. All Rights Reserved.

Trademark Information

RIGOL is a registered trademark of **RIGOL** (SUZHOU) TECHNOLOGIES INC.

Publication Number

QGA26101-1110

Notices

- **RIGOL** products are covered by P.R.C. and foreign patents, issued and pending.
- **RIGOL** reserves the right to modify or change parts of or all the specifications and pricing policies at the company's sole decision.
- Information in this publication replaces all previously released materials.
- Information in this publication is subject to change without notice.
- **RIGOL** shall not be liable for either incidental or consequential losses in connection with the furnishing, use, or performance of this manual, as well as any information contained.
- Any part of this document is forbidden to be copied, photocopied, or rearranged without prior written approval of **RIGOL**.

Product Certification

RIGOL guarantees that this product conforms to the national and industrial standards in China as well as the ISO9001:2015 standard and the ISO14001:2015 standard. Other international standard conformance certifications are in progress.

Contact Us

If you have any problem or requirement when using our products or this manual, please contact **RIGOL**.

E-mail: service@rigol.com

Website: www.rigol.com

General Safety Summary

1. Only the exclusive power cord designed for the instrument and authorized for use within the local country could be used.
2. Ensure that the instrument is safely grounded.
3. Observe all terminal ratings.
4. Use proper overvoltage protection.
5. Do not operate without covers.
6. Do not insert objects into the air outlet.
7. Use the proper fuse.
8. Avoid circuit or wire exposure.
9. Do not operate the instrument with suspected failures.
10. Provide adequate ventilation.
11. Do not operate in wet conditions.
12. Do not operate in an explosive atmosphere.
13. Keep instrument surfaces clean and dry.
14. Prevent electrostatic impact.
15. Handle with caution.

Safety Notices and Symbols

Safety Notices in this Manual:



WARNING

Indicates a potentially hazardous situation or practice which, if not avoided, will result in serious injury or death.



CAUTION

Indicates a potentially hazardous situation or practice which, if not avoided, could result in damage to the product or loss of important data.

Safety Terms on the Product:

DANGER It calls attention to an operation, if not correctly performed, could result in injury or hazard immediately.

WARNING It calls attention to an operation, if not correctly performed, could result in potential injury or hazard.

CAUTION It calls attention to an operation, if not correctly performed, could result in damage to the product or other devices connected to the product.

Safety Symbols on the Product:Hazardous
VoltageSafety
WarningProtective Earth
Terminal

Chassis Ground



Test Ground

Care and Cleaning

Care

Do not store or leave the instrument where it may be exposed to direct sunlight for long periods of time.

Cleaning

Clean the instrument regularly according to its operating conditions.

1. Disconnect the instrument from all power sources.
2. Clean the external surfaces of the instrument with a soft cloth dampened with mild detergent or water. When cleaning the LCD, take care to avoid scarifying it.

**CAUTION**

To avoid damage to the instrument, do not expose it to caustic liquids.

**WARNING**

To avoid short-circuit resulting from moisture or personal injuries, ensure that the instrument is completely dry before connecting it to the power supply.

Document Overview

This manual gives you a quick review about the front and rear panel of MSO8000 series, the user interface, and the basic operation method.

Tip

For the latest version of this manual, download it from the official website of **RIGOL** (www.rigol.com).

Format Conventions in this Manual

1. Key

The key on the front panel is denoted by the format of "Key Name (Bold) + Text Box". For example, **Utility** denotes the "Utility" key.









2. Menu

The menu items are denoted by the format of "Menu Word (Bold) + Character Shading". For example, **System** denotes the "System" menu item under **Utility**.

3. Operation Procedures

→ denotes the next step of operation. For example, **Utility** → **System** denotes that first press **Utility**, and then press the **System** softkey.

4. Knob

Label	Knob	Label	Knob
Horizontal SCALE 	Horizontal Time Base Knob	Vertical SCALE 	Vertical Scale Knob
Horizontal POSITION 	Horizontal Position Knob	Vertical OFFSET 	Vertical Offset Knob
Wave Vertical SCALE 	Waveform Vertical Scale Knob	Trigger LEVEL 	Trigger Level Knob
Wave Vertical POSITION 	Waveform Vertical Position Knob		Multifunction Knob

Content Conventions in this Manual

MSO8000 series includes the following models. Unless otherwise specified, this manual takes MSO8204 as an example to illustrate the functions and operation methods of MSO8000 series digital oscilloscope.

Model	Max. Analog Bandwidth	No. of Analog Channels	No. of Function/Arbitrary Waveform Generator Channels	No. of Digital Channels
MSO8064	600 MHz	4	2 (Opt.)	16 (Required to purchase the probe)
MSO8104	1 GHz	4	2 (Opt.)	16 (Required to purchase the probe)
MSO8204	2 GHz	4	2 (Opt.)	16 (Required to purchase the probe)

General Inspection

1. Inspect the packaging

If the packaging has been damaged, do not dispose the damaged packaging or cushioning materials until the shipment has been checked for completeness and has passed both electrical and mechanical tests.

The consigner or carrier shall be liable for the damage to the instrument resulting from shipment. **RIGOL** would not be responsible for free maintenance/rework or replacement of the instrument.

2. Inspect the instrument

In case of any mechanical damage, missing parts, or failure in passing the electrical and mechanical tests, contact your **RIGOL** sales representative.

3. Check the accessories

Please check the accessories according to the packing lists. If the accessories are damaged or incomplete, please contact your **RIGOL** sales representative.

Product Overview

MSO8000 series is a medium and high-end mixed signal digital oscilloscope designed on the basis of the ASIC chip (**RIGOL** self-owns its intellectual property right) and UltraVision II technical platform developed by **RIGOL**. Integrating 7 independent instruments into one, the MSO8000 series is equipped with the analog bandwidth of up to 2 GHz, extremely high memory depth of 500 Mpts, sound waveform display effects, excellent waveform capture rate, and powerful data analysis functions. Many of its specifications have reached the top level in the industry. Meanwhile, it supports the real-time eye diagram measurement and jitter analysis. Its cost-effective features and high performance make it prominent as the 2 GHz mixed signal digital oscilloscope.

For descriptions of the front panel, refer to Figure 1 and Table 1; for descriptions of the rear panel, refer to Figure 2 and Table 2; and for descriptions of the main interface (display screen), refer to Figure 3 and Table 3.

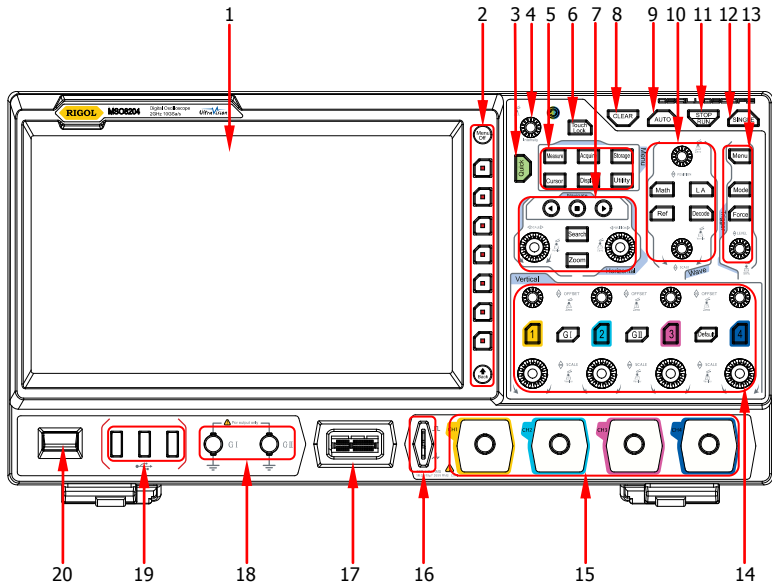

Figure 1 Front Panel

Table 1 Front Panel Description

No.	Description	No.	Description
1	Capacitive Touch Screen	11	RUN/STOP Key
2	Function Menu Operation Keys	12	Single Trigger Control Key
3	Quick Key (Shortcut Key)	13	Trigger Control System
4	Multifunction Knob	14	Vertical Control System
5	Common Operation Keys	15	Analog Channel Input Terminals
6	Touch Lock Key	16	Probe Compensation Signal Output Terminal/Ground Terminal
7	Horizontal Control System	17	Digital Channel Input Interface
8	CLEAR Key	18	Dual-channel Function/Arbitrary Waveform Generator Output Terminals ^[1]
9	Auto Waveform Display Key	19	USB HOST Interface
10	Waveform Control System	20	Power Key

Note:^[1] This port function needs to be activated by purchasing the MSO8000-AWG option.

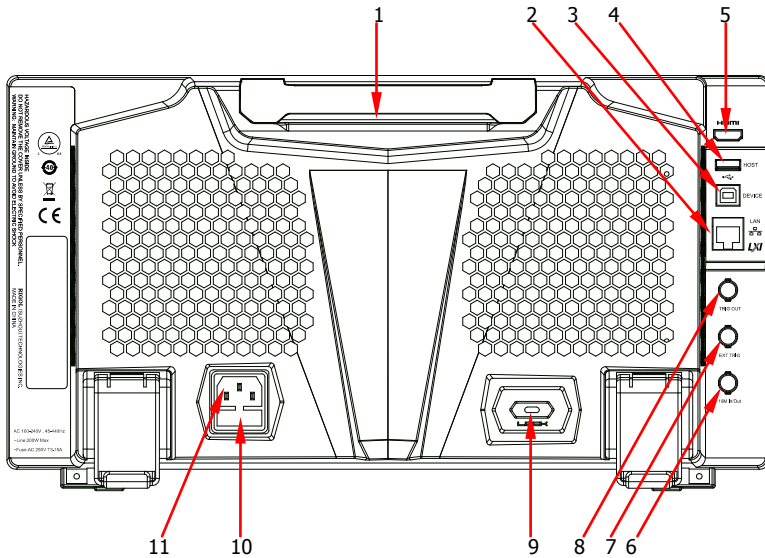

Figure 2 Rear Panel

Table 2 Rear Panel Description

No.	Description
1	Handle
2	LAN Interface
3	USB DEVICE Interface
4	USB HOST Interface
5	HDMI Video Output
6	Reference Clock Input/Output
7	EXT Trigger Input
8	Trigger Output Interface
9	Kensington Security Lock Hole
10	Fuse
11	AC Power Cord Connector

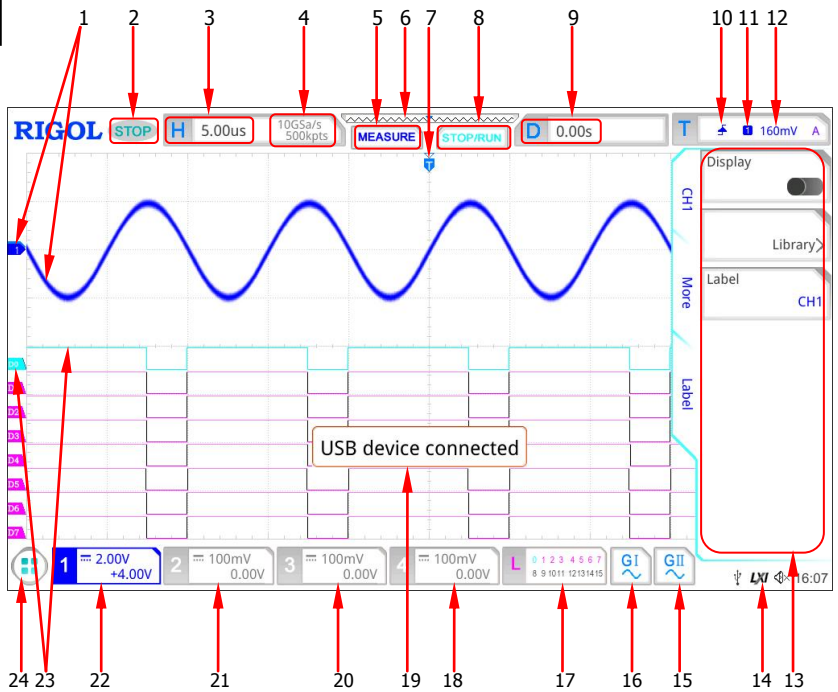

Figure 3 User Interface

Table 3 User Interface Icons

No.	Description	No.	Description
1	Analog Channel Label and Waveform	13	Operation Menu
2	Operating Status	14	Notification Area
3	Horizontal Time Base	15	Arbitrary Waveform Generator 2 Waveform Label
4	Sample Rate and Memory Depth	16	Arbitrary Waveform Generator 1 Waveform Label
5	Auto Measurement Label	17	Digital Channel Status Area
6	Waveform Memory	18	CH4 Status Label
7	Trigger Position	19	Message Box
8	RUN/STOP Label	20	CH3 Status Label
9	Horizontal Position	21	CH2 Status Label
10	Trigger Type	22	CH1 Status Label
11	Trigger Source	23	Digital Channel Label and Waveform
12	Trigger Level/Threshold Level	24	Function Navigation

To Prepare for Use

To Adjust the Supporting Legs

Adjust the supporting legs properly to use them as stands to tilt the oscilloscope upwards for stable placement of the oscilloscope as well as better operation and observation, as shown in Figure 4.

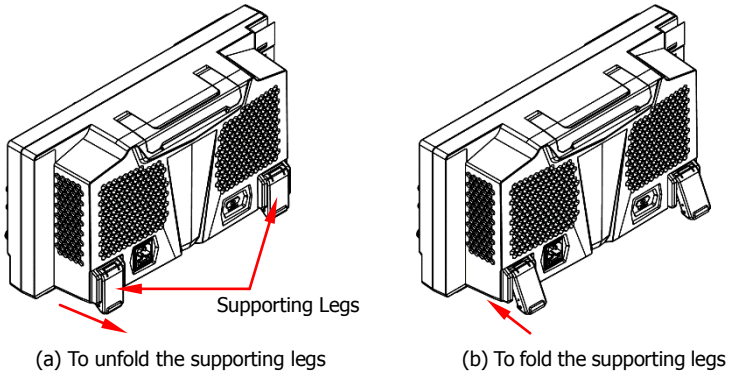

Figure 4 To Adjust the Supporting Legs

To Connect to AC Power

The input AC power requirements of the oscilloscope are 100~240 V, 45~440 Hz. Please use the power cord provided in the accessories to connect the oscilloscope to the AC power source via the power cord connector, as shown in Figure 5.

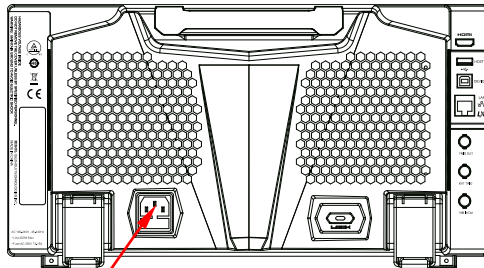



Figure 5 To Connect to AC Power

Turn-on Checkout

When the oscilloscope is connected to power, press the Power key  at the lower-left corner of the front panel to start the oscilloscope. (You can also press **Utility** → **System** → **Power status**, and select "Switch On". After the instrument is connected to power source, it will start directly.) During the start-up process, the oscilloscope performs a series of self-tests. After the self-test, the welcome screen is displayed.

To Set the System Language

MSO8000 series oscilloscope supports multiple system languages. You can press **Utility** → **Language** to set the system language.

To Connect the Probe

RIGOL provides the passive probe, the active probe, and the logic probe for MSO8000 series. For specific probe models, please refer to *MSO8000 Series Datasheet*. For detailed technical information of the probes, please refer to the specified Probe User's Guide.

Connect the passive probe:

1. Connect the BNC terminal of the probe to an analog channel input terminal of the oscilloscope on the front panel, as shown in Figure 6.
2. Connect the ground alligator clip or spring of the probe to the circuit ground terminal, and then connect the probe tip to the circuit point to be tested.

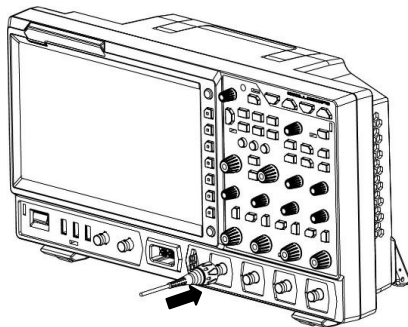

Figure 6 To Connect the Passive Probe

After you connect the passive probe, check the probe function and probe

compensation adjustment before making measurements. For detailed procedures, refer to "**Function Inspection**" and the "**Probe Compensation**" sections introduced in this manual.

Connect the active probe:

Take RP7150 (the active differential probe) as an example.

1. Connect the probe head to the preamp of the active probe, as shown in Figure 7.

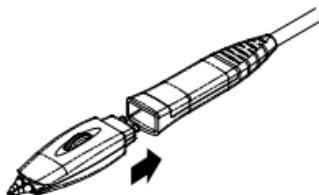

Figure 7 To Connect the Probe Head to the Preamp of the Active Probe

2. Connect the other end of the preamp to an analog channel input terminal of the oscilloscope on the front panel, as shown in Figure 8. Note that you should push the probe to the end to ensure that it is tightly connected.

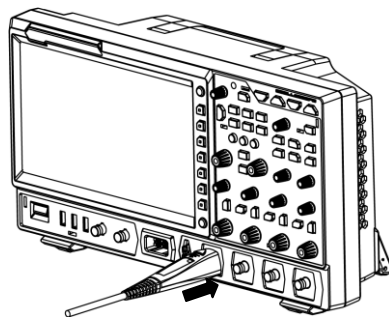

Figure 8 To Connect the Active Probe

3. Use the probe auxiliary equipment to connect the probe front to the circuit under test. For details about the probes, refer to *RP7000 Series Active Probe User's Guide*.

After connecting the active probe, you can perform probe calibration and offset voltage adjustment if necessary. For detailed procedures, refer to the descriptions of the active probe in user's guide.

Connect the logic probe:

1. Connect the output terminal of the logic probe to the digital channel input terminal on the front panel of the oscilloscope in the correct direction, as shown in Figure 9.
2. Connect the other terminal of the logic probe to the signal terminal under test. **RIGOL's** MSO8000 series has a configuration of a logic probe RPL2316. To apply to different application scenarios, RPL2316 provides three connection methods to connect the signal under test. For details, refer to *RPL2316 Logic Probe User's Guide*.

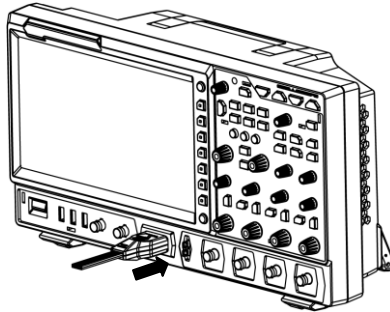

Figure 9 To Connect the Logic Probe

Note:

- Before you connect the logic probe to the signal under test, connect logic probe's adapter provided in the accessories to its corresponding channel group.
- The digital channel input terminal does not support hot plugging. Please do not insert or pull out the logic probe when the instrument is in power-on state.

Function Inspection

1. Press **Default** on the front panel, and then a prompt message "Restore default?" is displayed. Press or tap **OK** to restore the oscilloscope to its factory default settings.
2. Connect the ground alligator clip of the probe to the "Ground Terminal" as shown in Figure 10 below.
3. Use the probe to connect the input terminal of CH1 of the oscilloscope and the "Compensation Signal Output Terminal" of the probe, as shown in Figure 10.

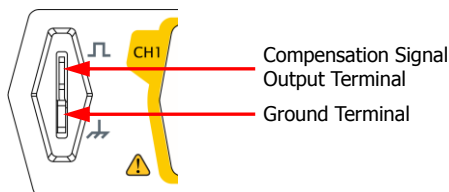

Figure 10 To Use the Compensation Signal

4. Set the probe attenuation to 10X, and then press **AUTO**.
5. Observe the waveform on the display. In normal condition, the square waveform as shown in Figure 11 should be displayed.

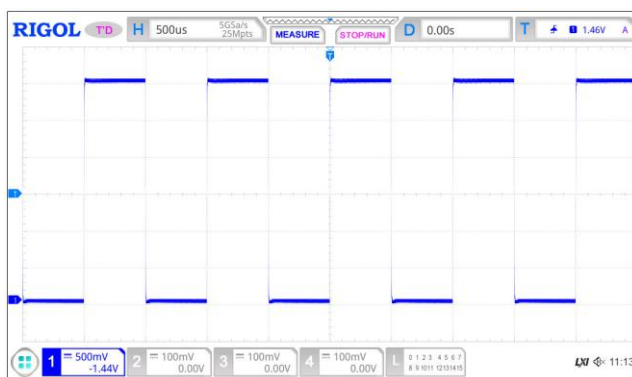

Figure 11 Square Waveform Signal

6. Use the same method to test the other channels. If the square waveforms actually shown do not match that in the figure above, please perform "**Probe Compensation**" introduced in this manual.

**WARNING**

To avoid electric shock when using the probe, please make sure that the insulated wire of the probe is in good condition. Do not touch the metallic part of the probe when the probe is connected to high voltage source.

Probe Compensation

When the probes are used for the first time, you should compensate the probes to make them match the input channels of the oscilloscope. Non-compensated or poorly compensated probes may cause measurement inaccuracy or errors. The probe compensation procedures are as follows:

1. Perform Step 1, 2, 3 and 4 specified in "**Function Inspection**".
2. Check the displayed waveforms and compare them with Figure 12.

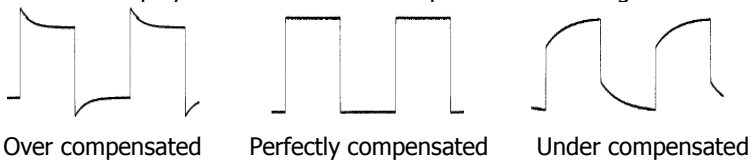

Figure 12 Probe Compensation

3. Use a nonmetallic screwdriver to adjust the low-frequency compensation adjustment hole on the probe until the waveform is displayed as "Perfectly compensated" in the figure above.

Touch Screen Operation

MSO8000 series provides a 10.1-inch super large capacitive touch screen, which supports multi-touch and gesture operation. It has strong waveform display capability and excellent user experience. It features great convenience, high flexibility, and great sensitivity. The actions supported by the touch screen controls include tapping, pinching&stretching, dragging as well as rectangle drawing.

Tap

Use one finger to touch the symbol or characters on the screen slightly, as shown in Figure 13. The actions supported by the tap action include:

- Tap and operate the menus on the menu.
- Tap the function navigation icon  at the lower-left corner of the touch screen to enable the function navigation.
- Tap the displayed numeric keypad to set the parameters.
- Tap the virtual keypad to set the label name and the filename.
- Tap close button at the upper-right corner of the message box to close it.
- Tap and operate the windows on the screen.



Figure 13 Tap Gesture

Pinch&Stretch

Pinch or stretch two points on the screen with two fingers to zoom in or out the waveform. To zoom in the waveform, first pinch the two fingers and then stretch the fingers; to zoom out the waveform, first stretch the two fingers, and then pinch the fingers together, as shown in Figure 14. The actions supported by the pinch action include:

- Pinching&stretching in the horizontal direction can adjust the horizontal time base of the waveform.
- Pinching&stretching in the vertical direction can adjust the vertical scale of the waveform.

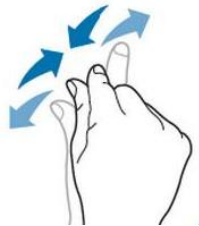

Figure 14 Pinch&Stretch Gesture

Drag

Use one finger to select the object, and then drag the object to a destination place, as shown in Figure 15. The actions supported by the drag action include:

- Drag the waveform to change its position or offset.
- Drag the window controls to change the positions of the controls (e.g. numeric keypad).
- Drag the marker to change the position of the marker.

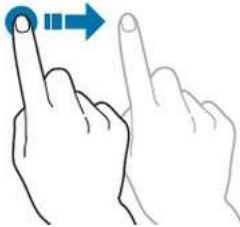

Figure 15 Drag Gesture

Rectangle Drawing

Enable the function navigation, and then tap the "Draw rect" icon to switch to the rectangle drawing mode. Drag to draw a rectangle on the screen, as shown in Figure 16. The actions supported by the rectangle drawing include:

- Select "Trigger zone A":
 - Draw the region for Trigger zone A;
 - Open Trigger zone A;
 - Open the "Zone trig" menu.
- Select "Trigger zone B":
 - Draw the area for Trigger zone B;
 - Open Trigger zone B;
 - Open the "Zone trig" menu.
- Select "Histogram":
 - Draw the region for the histogram;
 - Open the "Histogram" menu.
- Select "Horizontal zoom": expands the waveforms in the horizontal direction.
- Select "Vertical zoom": expands the waveforms in the vertical direction.
- Select "waveform zoom": expands the waveforms both in the horizontal and vertical direction.

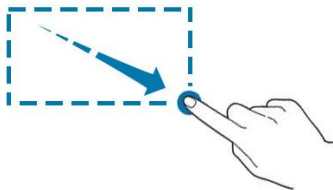



Figure 16 Rectangle Drawing Gesture

To Use the Built-in Help System

The help system of this oscilloscope provides instructions for all the function keys on the front panel and their corresponding menu keys. The steps for opening the built-in help system are as follows:

1. Press **Utility** → **System** → **Help**, and then the "Help" menu is displayed on the screen. You can also use the touch screen function, tap the function navigation icon  at the lower-left corner of the touch screen to enable the function navigation. Tap the "Help" icon, and then the "Help" menu is displayed on the screen.
2. Press **Help**, and then the help information is displayed on the screen, as shown in Figure 17. The help interface mainly consists of two sections. The left section lists "Help Options", and the right section is the "Help Display Area".

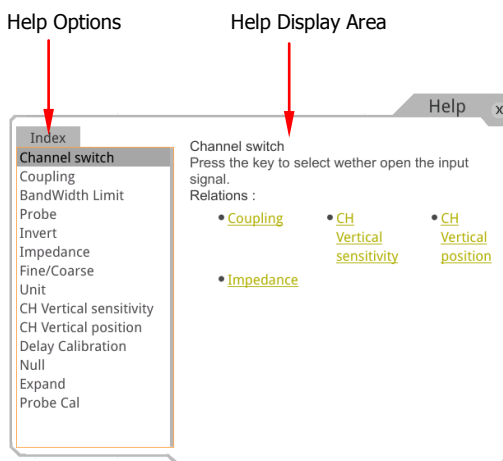



Figure 17 Help Information

After opening the help interface, you can get its help information in the "Help Display Area" through the following three methods:

Method 1:

For the keys, you can directly press the front-panel keys (except the Power key , the **Menu Off** key and **Back** key) to obtain the help information. For the buttons, you can rotate the knob or press down the knob to get the help information (except the multifunction knob ). As the function of rotating the

knob is different from that of pressing down the knob, these two operations will give you different help information.



Method 2:

In the "Help Options", rotate the multifunction knob  to switch among the help options to get the corresponding help information.

Method 3:

Enable the touch screen and tap the desired help option to get the corresponding help information.

Tip

- Help information for other keys and buttons:
 - Power key : powers on/off the instrument.
 - **Menu Off** key: displays or hides menus. By default, menus are displayed. If menus are hidden, pressing this key can display the menus again.
 - **Back** key: returns to the previous menu or the last set function menu.
 - Multifunction knob : In non-menu-operation mode, rotate this knob to adjust the brightness of waveform display. When you operate on the menu, this knob is illuminated. For the menu item that has multiple parameters under it, when you press the menu softkey, rotate the knob to select the parameter item, then press down the knob to select it (sometimes, the specified parameter item can be selected by rotating the knob). It can also be used to modify parameters, input a filename, etc.
- If the menu item is grayed out, you cannot press the corresponding front-panel menu key to obtain the help information. What you can do is only to follow the above Method 2 or 3 to get the help information.



Parameter Setting Method

For the MSO8000 series, you can use the multifunction knob or enable the touch screen to set the parameters of MSO8000 series. The common parameter setting methods are as follows:



Method 1:

For the parameters with the sign , rotate the multifunction knob  on the front panel directly to select the parameter item or modify the parameter value.

Method 2:

For the parameters with the sign , rotate the multifunction knob  on the front panel and press it down to select the parameter item or modify the parameter value.

Method 3:

For the parameters with  displayed on the menu, rotate the multifunction knob  on the front panel directly to set the parameter, or press down the multifunction knob  or the specified menu softkey, and then the numeric keypad is shown in Figure 18 below.

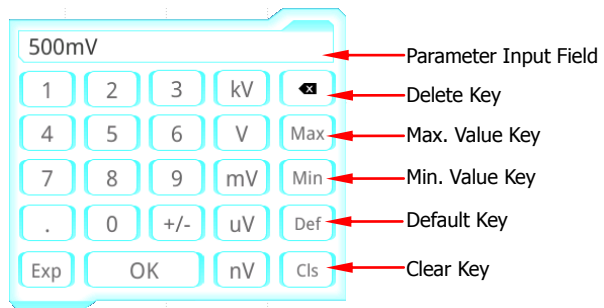



Figure 18 Numeric Keypad

In the numeric keypad, rotate the multifunction knob  to select the parameter, then press down the knob to select it. Then input the value or the unit. You can also enable the touch screen and tap the value or unit in the numeric keypad to input them. After you input all the values and select the desired units, the numeric keypad is turned off automatically. This indicates that you have completed parameter setting. Besides, after you have input the

values, you can also press **OK** directly to close the numeric keypad. At this time, the unit of the parameter is the default unit. In the numeric keypad, you can also perform the following operations:

- Delete the parameter value that has been input.
- Set the parameter to a maximum or minimum value (sometimes, the maximum or minimum value are the specified one for the current state).
- Set the parameter to a default value.
- Clear the parameter input field.

Method 4:

For the parameters without the above signs, press the desired menu softkey to switch between the parameter items. This method is applicable to the parameters with only two available options.

Tip

The above method is commonly used for the parameter settings of the oscilloscope. For other methods of parameter settings, refer to details in relevant chapters of *MSO8000 User's Guide*.

Fuse Replacement

If you need to replace the fuse, use only the specified fuse (AC 250 V, T3.15 A; 5.2 mm×20 mm) and perform the following operations, as shown in Figure 19:

1. Turn off the instrument, cut off the power, and remove the power cord.
2. Use a small straight slotted screwdriver to pry out the fuse holder.
3. Take out the fuse.
4. Replace the old fuse with a specified fuse.
5. Install the fuse holder.

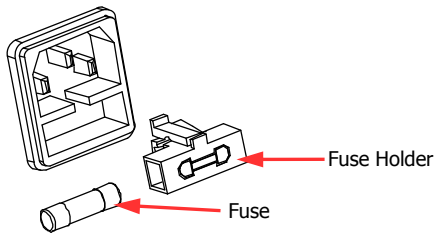

Figure 19 Fuse Replacement



WARNING

To avoid electric shock, please ensure that the instrument has been turned off, the power source has been cut off, and the fuse to be used conforms to the fuse rating.

Remote Control

MSO8000 series digital oscilloscope can be connected to the PC via the USB, LAN, or GPIB interface to set up communication and realize remote control through the PC. The remote control can be realized by using SCPI (Standard Commands for Programmable Instruments) commands. MSO8000 series digital oscilloscope supports three ways of remote control: user-defined programming, PC software (e.g. **RIGOL** Ultra Sigma), and Web Control.

More Product Information

1. Obtain the device information

Press **Utility** → **System** → **About** to obtain the information of the instrument, such as the manufacturer, model, serial number, hardware version number, etc. You can also open the "Help" menu, and then press **About** to obtain the device information.

2. View the option information and the option installation

The instrument is installed with the trial versions of the options before leaving factory. When you power on the instrument for the first time after leaving factory, the trial time is about 2,160 minutes. Open the "Help" menu, and then press **Option list** to view the options currently installed on the oscilloscope and their information. Press **Option setup** to install the option. For detailed setting methods, refer to descriptions in *MSO8000 User's Guide*.

For more information about this instrument, refer to the relevant manuals by logging in to the official website of **RIGOL** (www.rigol.com) to download them.

MSO8000 User's Guide: introduces the functions of the instrument and the operation methods, remote control methods, possible failures and solutions in using the instrument, the technical specifications, and order information.

MSO8000 Programming Guide: provides detailed descriptions of SCPI commands and programming examples of the instrument.

MSO8000 Datasheet: provides the main features and technical specifications of the instrument.

RIGOL

快速指南

中文

MSO8000 系列数字示波器

2019 年 7 月

RIGOL (SUZHOU) TECHNOLOGIES INC.

保证和声明

版权

© 2019 苏州普源精电科技有限公司

商标信息

RIGOL 是苏州普源精电科技有限公司的注册商标。

中文

文档编号

QGA26001-1110

声明

- 本公司产品受中国及其他国家和地区的专利（包括已取得的和正在申请的专利）保护。
- 本公司保留改变规格及价格的权利。
- 本手册提供的信息取代以往出版的所有资料。
- 本手册提供的信息如有变更，恕不另行通知。
- 对于本手册可能包含的错误，或因手册所提供的信息及演绎的功能以及因使用本手册而导致的任何偶然或继发的损失，**RIGOL** 概不负责。
- 未经 **RIGOL** 事先书面许可，不得影印、复制或改编本手册的任何部分。

产品认证

RIGOL 认证本产品符合中国国家产品标准和行业产品标准及 ISO9001:2015 标准和 ISO14001:2015 标准，并进一步认证本产品符合其他国际标准组织成员的相关标准

联系我们

如您在使用此产品或本手册的过程中有任何问题或需求，可与 **RIGOL** 联系：

电子邮箱：service@rigol.com

网址：www.rigol.com

一般安全概要

1. 请使用所在国家认可的本产品专用电源线。
2. 请确保产品可靠接地。
3. 查看所有终端额定值。
4. 请使用合适的过压保护。
5. 请勿开盖操作。
6. 请勿将异物插入排风口。
7. 请使用合适的保险丝。
8. 避免电路外露。
9. 怀疑产品出故障时，请勿进行操作。
10. 请保持适当的通风。
11. 请勿在潮湿环境下操作。
12. 请勿在易燃易爆的环境下操作。
13. 请保持产品表面的清洁和干燥。
14. 请注意防静电保护。
15. 请注意搬运安全。

安全术语和符号

本手册中的安全术语：



警告

警告性声明指出可能会造成人身伤害或危及生命安全的情况或操作。



注意

注意性声明指出可能导致本产品损坏或数据丢失的情况或操作。

产品上的安全术语：

DANGER
WARNING
CAUTION

表示您如果不进行此操作，可能会立即对您造成危害。

表示您如果不进行此操作，可能会对您造成潜在的危害。

表示您如果不进行此操作，可能会对本产品或连接到本产品的其他设备造成损坏。

产品上的安全符号：



高电压



安全警告



保护性接地端



壳体接地端



测量接地端

保养与清洁

保养

请勿将仪器放置在长时间受到日照的地方。

清洁

请根据使用情况定期对仪器进行清洁。方法如下：

1. 断开电源。
2. 用柔和的清洁剂或清水浸湿软布擦拭仪器外部。清洁带有液晶显示屏的仪器时，请注意不要划伤液晶显示屏。

中文



注意

请勿使任何腐蚀性的液体沾到仪器上，以免损坏仪器。



警告

重新通电之前，请确认仪器已经干透，避免因水分造成电气短路甚至人身伤害。

文档概述

本文档用于指导用户快速了解MSO8000系列数字示波器的前后面板、用户界面及基本操作方法等。

提示

本手册的最新版本可登陆 **RIGOL** 网址 (www.rigol.com) 进行下载。

文档格式的约定

1. 按键

用“按键字符(加粗)+文本框”表示前面板按键，如 **Utility** 表示“Utility”按键。

2. 菜单

用“菜单文字(加粗)+字符底纹”表示一个菜单选项，如 **系统** 表示 **Utility** 按键下的“系统”菜单选项。

3. 操作步骤

用箭头“→”表示下一步操作，如 **Utility** → **系统** 表示按下前面板上的 **Utility** 按键后，再按 **系统** 菜单键。

4. 旋钮

标识	旋钮	标识	旋钮
水平  SCALE	水平时基旋钮	垂直  SCALE	垂直档位旋钮
水平  POSITION	水平位移旋钮	垂直  OFFSET	垂直偏移旋钮
波形垂直  SCALE	波形垂直档位旋钮	触发  LEVEL	触发电平旋钮
波形垂直  POSITION	波形垂直位移旋钮		多功能旋钮

文档内容的约定

MSO8000系列数字示波器包含以下型号。如无特殊说明，本手册以MSO8204为例说明MSO8000系列及其基本操作。

型号	最高模拟带宽	模拟通道数	函数/任意波形发生器通道数	数字通道数
MSO8064	600 MHz	4	2 (选件)	16 (需选配探头)
MSO8104	1 GHz	4	2 (选件)	16 (需选配探头)
MSO8204	2 GHz	4	2 (选件)	16 (需选配探头)

一般性检查

1. 检查运输包装

如运输包装已损坏，请保留被损坏的包装或防震材料，直到货物经过完全检查且仪器通过电性和机械测试。

因运输造成仪器损坏，由发货方和承运方联系赔偿事宜。**RIGOL**公司恕不进行免费维修或更换。

中文

2. 检查整机

若存在机械损坏或缺失，或者仪器未通过电性和机械测试，请联系您的**RIGOL**经销商。

3. 检查随机附件

请根据装箱单检查随机附件，如有损坏或缺失，请联系您的**RIGOL**经销商。

产品简介

MSO8000 系列数字示波器是基于 **RIGOL** 自主知识产权的 ASIC 芯片和 UltraVision II 技术平台的中高端混合信号数字示波器。示波器模拟通道带宽高达 2 GHz，集 7 种仪器于一身，具有 500 Mpts 超大存储深度、良好的波形显示效果、优异的波形捕获率和强大的数据分析功能，多项指标均达业界一流水平，并且支持实时眼图测量和抖动分析，是业内最具性价比优势的 2 GHz 混合信号数字示波器。

前面板、后面板和主界面（显示屏）的简要介绍请分别参考图 1（具体说明见表 1）、图 2（具体说明见表 2）和图 3（具体说明见表 3）。



图 1 前面板

表 1 前面板说明

编号	说明	编号	说明
1	电容触摸屏	11	运行/停止控制键
2	功能菜单操作键	12	单次触发控制键
3	Quick 快捷键	13	触发控制系统
4	多功能旋钮	14	垂直控制系统
5	常用操作键	15	模拟通道输入
6	触摸屏锁定键	16	探头补偿信号输出端/接地端
7	水平控制系统	17	数字通道输入
8	全部清除键	18	双通道函数/任意波形发生器输出端 ^[1]
9	波形自动显示键	19	USB HOST 接口
10	波形控制系统	20	电源键

注^[1]：该端口功能需购买 MSO8000-AWG 选件进行激活。

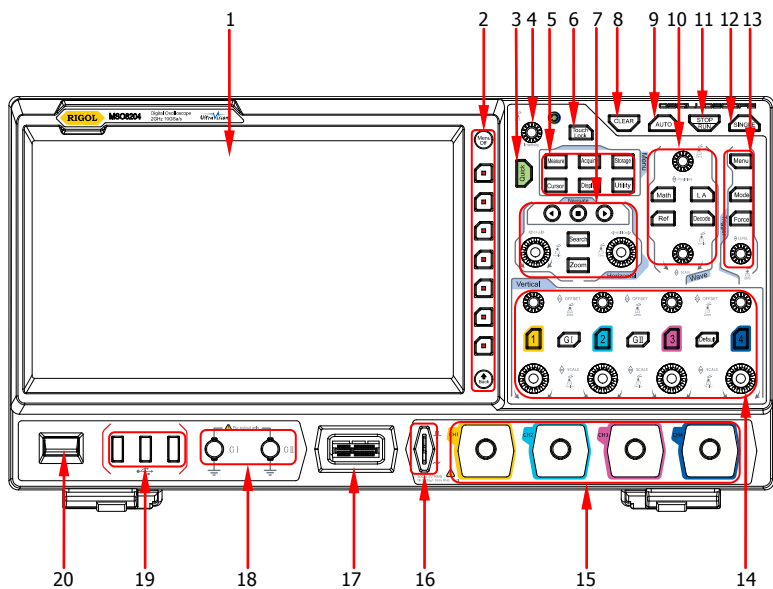
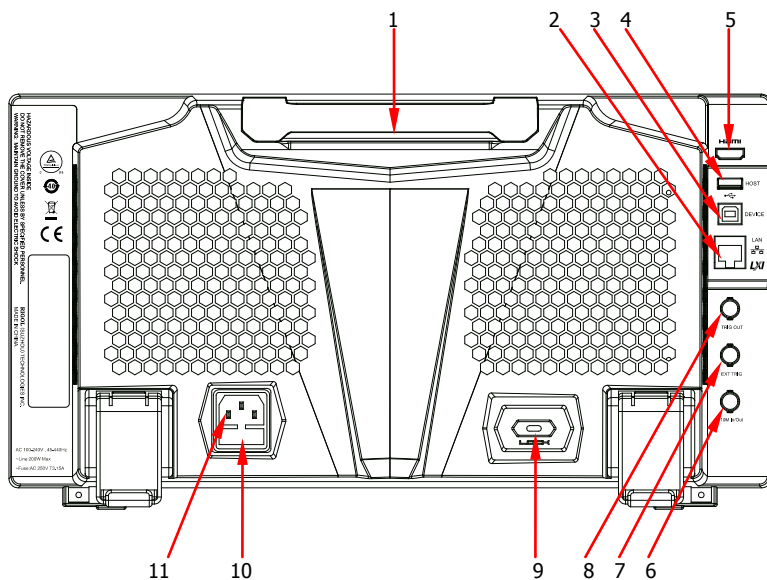

中文

图 2 后面板

表 2 后面板说明

编号	说明
1	手柄
2	LAN 接口
3	USB DEVICE 接口
4	USB HOST 接口
5	HDMI 高清视频输出
6	参考时钟输入/输出端
7	EXT 触发输入端
8	触发输出接口
9	Kensington 安全锁孔
10	保险丝
11	AC 电源插孔



图 3 用户界面

表 3 用户界面标识

编号	说明	编号	说明
1	模拟通道标签和波形	13	操作菜单
2	运行状态	14	通知区域
3	水平时基	15	任意波发生器 2 波形标签
4	采样率和存储深度	16	任意波发生器 1 波形标签
5	自动测量标签	17	数字通道状态区
6	波形存储器	18	CH4 状态标签
7	触发位置	19	消息框
8	运行/停止控制标识	20	CH3 状态标签
9	水平位移	21	CH2 状态标签
10	触发类型	22	CH1 状态标签
11	触发源	23	数字通道标签和波形
12	触发电平/阈值电平	24	功能导航

使用前准备

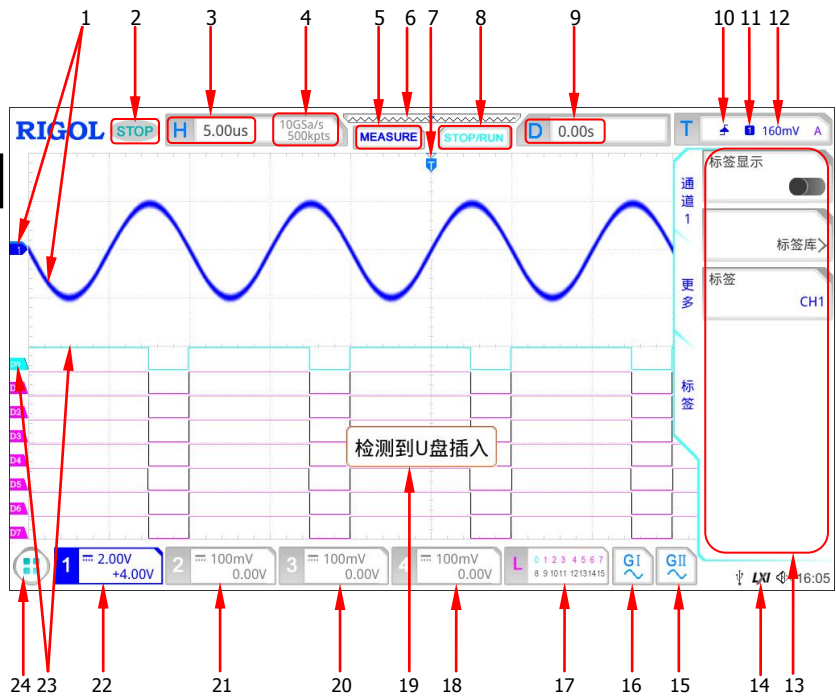
调节支撑脚

适当的调整支撑脚，将其作为支架使示波器向上倾斜，以稳定放置示波器，便于更好的操作和观察显示屏，如图 4 所示。

中文



图 4 调节支撑脚

连接电源

本示波器可输入交流电源的规格为： $100\sim 240\text{ V}$ ， $45\sim 440\text{ Hz}$ 。请使用附件提供的电源线按图 5 所示将示波器连接到电源中。



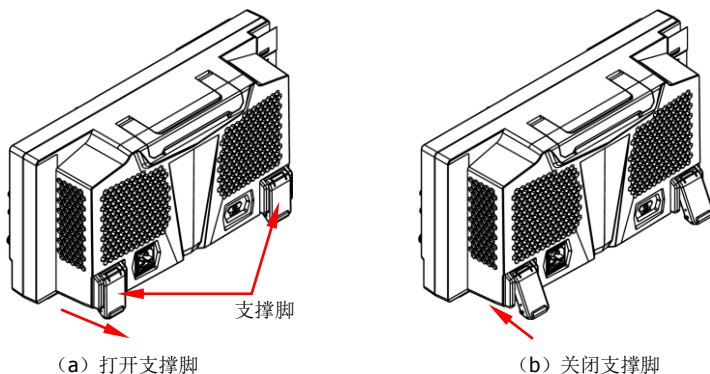

图 5 连接电源

开机检查

当示波器处于通电状态时，按前面板左下角的电源键  即可启动示波器。（您也可以通过按 **Utility** → **系统** → **电源状态**，选择“开关常开”，示波器通电后直接开机）。开机过程中示波器执行一系列自检，自检结束后出现开机画面。

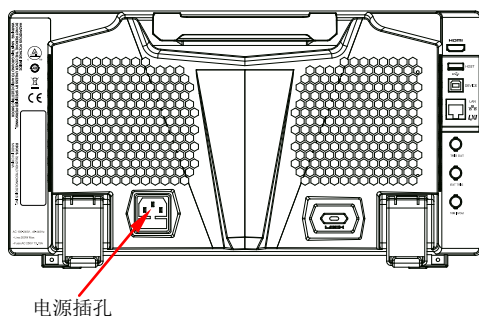
中文

设置系统语言

MSO8000 系列示波器支持多种系统语言，您可以按 **Utility** → **Language** 设置系统语言。

连接探头

RIGOL 为 MSO8000 系列提供无源探头、有源探头和逻辑探头。探头的具体型号请参考《MSO8000 系列数据手册》。有关探头的详细技术信息请参考相应的探头用户手册。

连接无源探头：

1. 将探头的 BNC 端连接至示波器前面板的模拟通道输入端，如图 6 所示。
2. 将探头接地鳄鱼夹或接地弹簧连接至电路接地端，然后将探针连接至待测电路测试点中。



图 6 连接无源探头

连接无源探头后，您需要在测量前进行探头功能检查和探头补偿调节，具体步骤请参考本手册中“**功能检查**”和“**探头补偿**”一节介绍的内容。

连接有源探头：

以 RP7150（差分有源探头）为例：

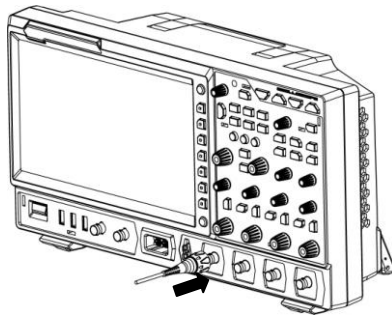
1. 将探头前端与有源探头放大器连接，如图 7 所示。



图 7 连接探头前端与有源探头放大器

2. 将有源探头放大器的另一端连接至示波器前面板的模拟通道输入端，如图 8 所示。注意将探头推到紧闭的位置。

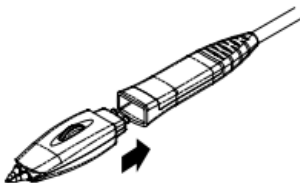

图 8 连接有源探头

3. 使用探头辅助装置将探头前端连接到待测电路中。探头详细信息请参考《RP7000 系列有源探头用户手册》。

连接有源探头后，您可以根据需要进行探头校准和偏移电压调整等，具体步骤请参考本产品用户手册中关于有源探头内容的介绍。

连接逻辑探头：

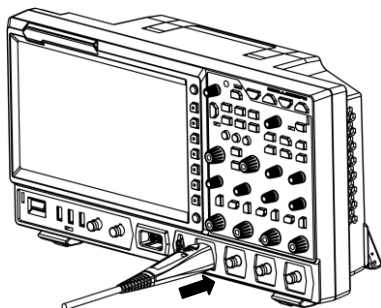
1. 将逻辑探头输出端按正确的方向连接至示波器前面板的数字通道输入端，如图 9 所示。
2. 将逻辑探头另一端连接至待测信号端。**RIGOL** 为 MSO8000 配置 RPL2316 逻辑探头，为适应不同的应用场合，RPL2316 提供了三种连接被测信号的方法，具体请参考《RPL2316 逻辑探头用户手册》。



图 9 连接逻辑探头

注意：

- 将逻辑探头连接至待测信号前，须将附件提供的逻辑探头适配器与其对应的通道组连接。
- 数字通道输入接口不支持热插拔，请勿在仪器带电的情况下插入或拔出逻辑探头。

功能检查

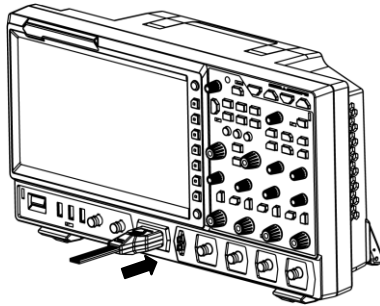
1. 按示波器前面板 **Default** 键，屏幕弹出“确定恢复默认设置？”提示框，按 **确定** 键或点击“确定”选项将示波器恢复为出厂默认配置。
2. 将探头的接地鳄鱼夹连接至图 10 所示的“接地端”。
3. 使用探头连接示波器的通道 1 (CH1) 输入端和图 10 所示的“补偿信号输出端”。



图 10 使用补偿信号

4. 将探头衰减比设定为 10X，然后按 **AUTO** 键。
5. 观察示波器显示屏上的波形，正常情况下应显示图 11 所示的方波信号。

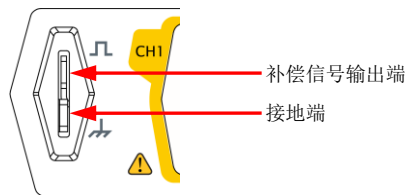

图 11 方波信号

6. 用同样方法检查其他通道。如实际显示的方波形状与上图不相符，请执行本手册中“**探头补偿**”一节介绍的内容。

**警告**

为避免使用探头时被电击，请首先确保探头的绝缘导线完好，并且在连接高压源时不要接触探头的金属部分。

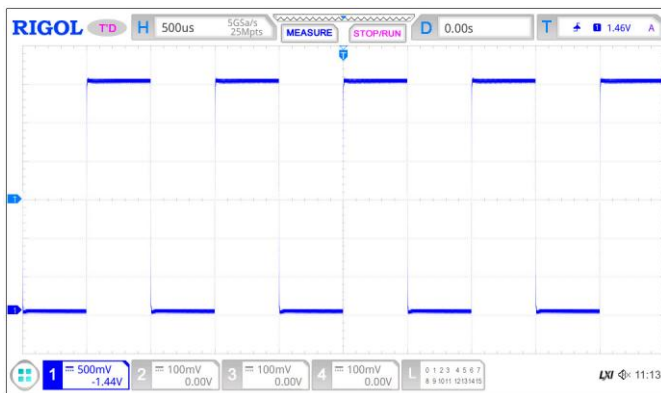
探头补偿

首次使用探头时，应进行探头补偿调节，使探头与示波器输入通道匹配。未经补偿或补偿偏差的探头会导致测量误差或错误。探头补偿步骤如下：

1. 执行上一节“**功能检查**”介绍中的步骤 1、2、3 和 4。
2. 检查所显示的波形形状并与图 12 所得波形进行对比。



图 12 探头补偿

3. 使用附件中提供的探头补偿调节棒调整探头上的低频补偿调节孔，直到显示的波形如上图 12 所示的“**补偿正确**”。

触摸屏操作

MSO8000 系列提供 10.1 英寸超大电容触摸屏，支持多点触控和手势操作，兼顾了强大的波形显示能力及优异的用户体验，具有简捷方便、灵活和高灵敏度等特点。触摸屏控件支持的功能包括触摸、捏合、拖动和矩形绘制。

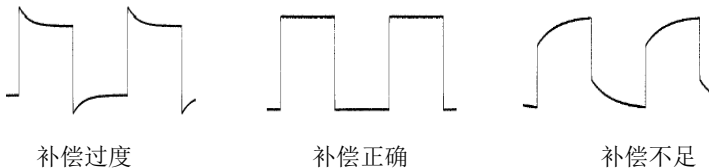
中文

触摸

用一个手指轻轻点碰屏幕上的图符或文字，如图 13 所示。触摸可实现的功能包括：

- 触摸屏幕上显示的菜单，可对菜单进行操作。
- 触摸屏幕左下角的功能导航图标 ，可打开功能导航。
- 触摸弹出的数字键盘，可对参数进行设置。
- 触摸虚拟键盘，设置标签名和文件名。
- 触摸信息弹出框右上角的关闭按钮，关闭弹出框。
- 触摸屏幕上显示的其他窗口，对窗口进行操作。



图 13 触摸手势

捏合

将两根手指靠拢在一起或分开。捏合手势可放大或缩小相关波形。需放大时，先将两根手指先靠拢在一起，然后滑动分开；需缩小时，先将两根手指分开，然后滑动在一起，如图 14 所示。捏合可实现的功能包括：

- 水平方向捏合可调整波形的水平时基。
- 垂直方向捏合可调整波形的垂直档位。



图 14 捏合手势

拖动

用单指按住拖动目标不放，然后将其拖至目标位置，如图 15 所示。拖动可实现的功能包括：

- 拖动波形以改变波形位移或偏移。
- 拖动窗口控件以改变窗口位置（如数字键盘）。
- 拖动光标以改变光标位置。

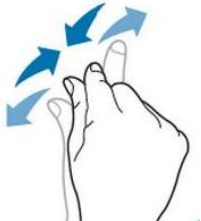

图 15 拖动手势

矩形绘制

打开功能导航，然后点击“矩形绘制”图标，切换为矩形绘制模式，在屏幕上拖动手指以绘制矩形，如图 16 所示。矩形绘制可实现的功能包括：

- 选择“区域触发 A”：
 - 绘制区域触发 A 的区域；
 - 打开区域触发 A；
 - 打开“区域触发”菜单。
- 选择“区域触发 B”：
 - 绘制区域触发 B 的区域；
 - 打开区域触发 B；
 - 打开“区域触发”菜单。
- 选择“直方图”：
 - 绘制直方图的范围；
 - 打开“直方图”菜单。
- 选择“水平缩放”：水平方向扩展波形。
- 选择“垂直缩放”：垂直方向扩展波形。
- 选择“波形缩放”：水平方向和垂直方向同时扩展波形。

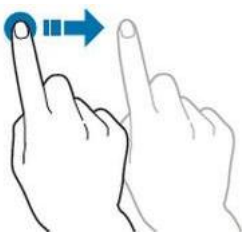



图 16 矩形绘制手势

使用内置帮助系统

本示波器的帮助系统提供了前面板各功能按键及相应菜单键的说明。打开帮助系统的步骤如下：

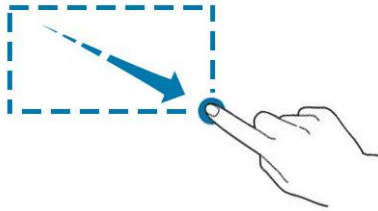
1. 按 **Utility** → **系统** → **帮助**，进入“帮助”功能菜单。您也可以使用触摸屏功能，点击屏幕左下角的功能导航图标 ，然后点击“帮助”图标进入“帮助”功能菜单。
2. 按前面板的 **帮助** 键，屏幕弹出帮助界面，如图 17 所示。帮助界面主要分为两部分，左边为“帮助选项”，右边为“帮助显示区”。





图 17 帮助信息

打开帮助界面后，您可以通过以下三种方法在帮助显示区中获得相应的帮助信息：

方法一：

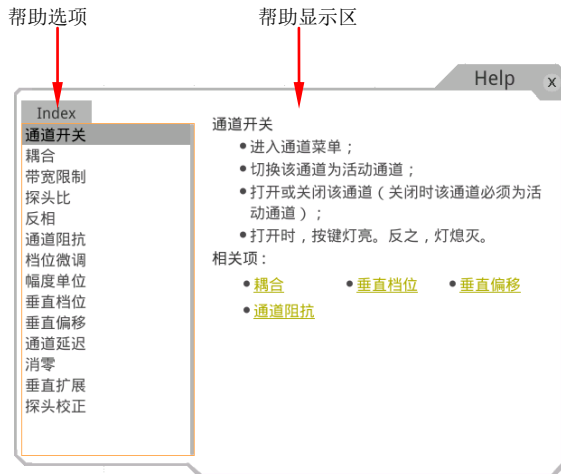
对于按键，您可以直接按仪器前面板上的按键获取帮助信息（电源键 、**Menu Off** 键、**Back** 键除外）；对于旋钮，您可以旋转旋钮或按下旋钮获取帮助信息（多功能旋钮  除外），由于旋转旋钮和按下旋钮的功能不同，所以获取不同的帮助信息。

中文



方法二：

您可以在“帮助选项”中，旋转多功能旋钮  切换帮助选项获取帮助信息。

方法三：

使用触摸屏功能，通过触摸手势直接点击所需的帮助选项获取帮助信息。



提示

- 其他按键和旋钮帮助信息：
 - 电源键 ：电源开/关键。
 - **Menu Off** 键：菜单隐藏键，按此键可隐藏菜单。
 - **Back** 键：菜单返回键，按此键可返回上一级菜单或返回前一次设置的功能菜单。
 - 多功能旋钮 ：非菜单操作时，转动该旋钮可调整波形显示的亮度。菜单操作时，该旋钮背光灯变亮，对于含有多个参数选项的菜单项，按下相应的菜单软键后，旋转该旋钮选择参数项然后再按下该旋钮选中（有时旋转该旋钮即可选中指定的参数项）。该旋钮还可以用于修改参数、输入文件名等。
- 若菜单项置灰，您无法直接按前面板相应的菜单键获取相应的帮助信息，您只能通过上述介绍的方法二或方法三获取帮助信息。



参数设置方法

MSO8000 系列的参数设置主要支持多功能旋钮和触摸屏两种输入方式，常用的参数设置方法如下：



方法一：

对于菜单上显示  的参数，直接旋转前面板上的多功能旋钮  即可选择参数项或修改参数值。

方法二：

对于菜单上显示  的参数，旋转前面板上的多功能旋钮  选择选项后再按下即可选中参数项或修改参数值。

方法三：

对于菜单上显示  的参数，旋转前面板上的多功能旋钮  进行设置，或按下前面板上的多功能旋钮  或者对应菜单软键，通过弹出的数字键盘进行设置，如图 18 所示。





图 18 数字键盘

在数字键盘中，您可以旋转多功能旋钮  进行选择然后再按下该旋钮选中即可输入该数值或单位，或者使用触摸屏功能，点击数字键盘中的数值或单位进行输入。输入全部数值并选择所需的单位后，数字键盘自动关闭，则完成参数设置。另外，完成数值输入后，您也可以直接点击数字键盘中的“OK”键关闭数字键盘，此时参数的单位为默认单位。在数字键盘中，您还可以进行以下操作：

- 删除已输入参数数值。
- 将参数设置为最大值或最小值（有时特指当前状态下的最大值或最小值）。
- 将参数设置为默认值。
- 清空参数输入框。

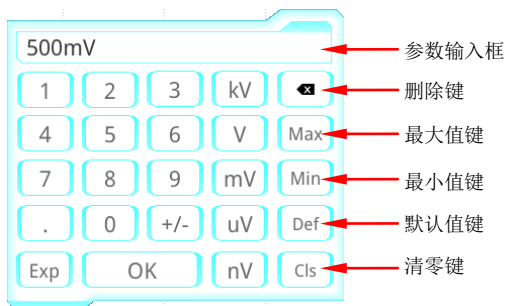
方法四：

对于菜单上无图标显示的参数，直接按相应的菜单软键即可切换设置所需的参数（此方法适用于只有两个可选选项的参数）。

提示

上述方法是示波器常用的参数设置方法，若某些参数有其他设置方法，将在本产品用户手册的相关章节中详细介绍。

更换保险丝

如需更换保险丝，请使用仪器指定规格（AC 250 V，T3.15 A；5.2 mm×20 mm）的保险丝，按如下步骤进行更换（如图 19 所示）：

1. 关闭仪器，断开电源，拔去电源线；
2. 使用小一字螺丝刀撬出保险丝座；
3. 取出保险丝；
4. 更换指定规格的保险丝；
5. 重新安装保险丝座。

中文



图 19 更换保险丝



警告

为避免电击，更换保险丝之前，请确保仪器已关闭并且已断开与电源的连接，且确保更换的保险丝规格符合要求。

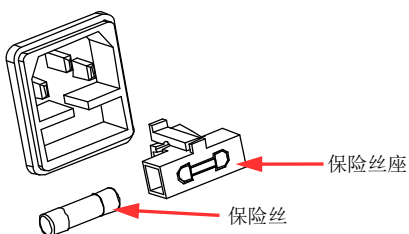
远程控制

MSO8000 系列数字示波器支持通过 USB 接口、LAN 接口和 GPIB 接口与计算机进行通信从而实现远程控制。远程控制基于 SCPI (Standard Commands for Programmable Instruments) 命令集实现。MSO8000 系列数字示波器支持三种远程控制方式：用户自定义编程、使用 PC 软件（如 **RIGOL Ultra Sigma**）和 Web Control 控制。

更多产品信息

1. 获取设备信息

按 **Utility** → **系统** → **关于此示波器**，您可获取设备信息，包括厂商、产品型号、产品序列号和硬件版本号等。您也可以打开“帮助”功能菜单，然后再按 **关于此示波器** 键获取设备信息。

2. 查看选件信息及选件安装

仪器出厂时我们将为用户提供选件的试用版本，试用时间将从出厂后首次打开示波器电源开始，试用时间约为 2160 分钟。打开“帮助”功能菜单，按 **选件列表** 键，可查看示波器当前已安装的选件及其相关信息；按 **选件安装** 键，进行选件安装，选件安装的具体方法请参考本产品用户手册中的详细介绍。

欲了解本产品更多信息，请查阅相关手册（您可登录 **RIGOL** 网站（www.rigol.com）下载）。

《MSO8000 系列用户手册》：提供本产品的功能介绍及操作方法、远程控制方法、在使用过程中可能出现的故障及处理方法、性能指标以及订货信息。

《MSO8000 系列编程手册》：提供本产品的 SCPI 命令集以及编程实例。

《MSO8000 系列数据手册》：提供本产品的主要特色和技术指标。