



RIGOL

MSO8000A Series

Digital Oscilloscope

User Guide

May. 2023



Guaranty and Declaration

Copyright

© 2023 RIGOL TECHNOLOGIES CO., LTD. All Rights Reserved.

Trademark Information

RIGOL® is the trademark of RIGOL TECHNOLOGIES CO., LTD.

Notices

- RIGOL products are covered by P.R.C. and foreign patents, issued and pending.
- RIGOL reserves the right to modify or change parts of or all the specifications and pricing policies at the company's sole decision.
- Information in this publication replaces all previously released materials.
- Information in this publication is subject to change without notice.
- RIGOL shall not be liable for either incidental or consequential losses in connection with the furnishing, use, or performance of this manual, as well as any information contained.
- Any part of this document is forbidden to be copied, photocopied, or rearranged without prior written approval of RIGOL.

Product Certification

RIGOL guarantees that this product conforms to the national and industrial standards in China as well as the ISO9001:2015 standard and the ISO14001:2015 standard. Other international standard conformance certifications are in progress.

Contact Us

If you have any problem or requirement when using our products or this manual, please contact RIGOL.

E-mail: service@rigol.com

Website: <http://www.rigol.com>

Section	Description	Page
	List of Figures.....	X
	List of Tables.....	XIV
1	Safety Requirement	1
1.1	General Safety Summary	1
1.2	Safety Notices and Symbols	3
1.3	Measurement Category	3
1.4	Ventilation Requirement	4
1.5	Working Environment	4
1.6	Care and Cleaning	6
1.7	Environmental Considerations	6
2	MSO8000A Series Overview	8
3	Document Overview	10
4	Quick Start	12
4.1	General Inspection	12
4.2	Appearance and Dimensions	13
4.3	To Prepare for Use	13
4.3.1	To Adjust the Supporting Legs	13
4.3.2	To Connect to AC Power	14
4.3.3	Turn-on Checkout	14
4.3.4	Fuse Replacement	15
4.3.5	To Connect the Probe	16
4.3.6	Function Inspection	19
4.3.7	Probe Compensation	20
4.4	Front Panel Overview	21
4.5	Rear Panel Overview	23
4.6	Front Panel Function Overview	25
4.6.1	Vertical	25
4.6.2	Horizontal	26
4.6.3	Wave	28
4.6.4	Trigger	29
4.6.5	Clear	29
4.6.6	Auto	29
4.6.7	RUN/STOP	30

4.6.8	Single	30
4.6.9	Multifunction knob	30
4.6.10	Function Menu	30
4.6.11	Touch Lock Key	31
4.6.12	Quick key (shortcut key)	31
4.7	User Interface	32
4.8	Touch Screen Controls	37
4.8.1	Tap	37
4.8.2	Pinch & Stretch	38
4.8.3	Drag	38
4.8.4	Rectangle Drawing	39
4.9	Parameter Setting Method	40
4.10	To Use the Security Lock	42
4.11	To Use the Built-in Help System	42
4.12	To View the Option Information and the Option Installation	44
5	To Set the Vertical System	47
5.1	To Enable or Disable the Analog Channel	47
5.2	To Adjust the Vertical Scale	48
5.3	Vertical Expansion	49
5.4	To Adjust the Vertical Offset	50
5.5	Channel Coupling	51
5.6	BW Limit	52
5.7	Probe Ratio	52
5.8	Input Impedance	54
5.9	Waveform Invert	54
5.10	To Set the Probe	55
5.10.1	Passive Probe	55
5.10.2	Active Probe	56
5.11	Amplitude Unit	56
5.12	Channel Delay	57
5.13	To Set the Bias	57
5.14	Channel Label	58
6	To Set the Horizontal System	60
6.1	To Adjust the Horizontal Time Base	60
6.2	To Adjust the Horizontal Position	61
6.3	Delayed Sweep	62
7	To Set the Sample System	65

7.1	Timebase Mode	65
7.1.1	YT Mode	65
7.1.2	XY Mode	65
7.1.3	ROLL Mode	68
7.2	Acquisition Mode	68
7.2.1	Normal	68
7.2.2	Average	69
7.2.3	Peak	70
7.2.4	High Resolution	70
7.3	Sampling Mode	70
7.4	Sample Rate	71
7.5	LA Sample Rate	72
7.6	Memory Depth	72
7.7	LA Memory Depth	74
7.8	Anti-Aliasing	74
7.9	Horizontal Expansion	74
8	To Trigger the Oscilloscope	76
8.1	Trigger Source	76
8.2	Trigger LEVEL/Threshold Level	77
8.3	Trigger Mode	78
8.4	Trigger Coupling	80
8.5	Trigger Holdoff	80
8.6	Noise Rejection	81
8.7	Trigger Type	81
8.7.1	Edge Trigger	82
8.7.2	Pulse Trigger	83
8.7.3	Slope Trigger	85
8.7.4	Video Trigger	89
8.7.5	Pattern Trigger	91
8.7.6	Duration Trigger	94
8.7.7	Timeout Trigger	97
8.7.8	Runt Trigger	99
8.7.9	Window Trigger	101
8.7.10	Delay Trigger	103
8.7.11	Setup/Hold Trigger	106
8.7.12	Nth Edge Trigger	108
8.7.13	RS232 Trigger (Option)	110

8.7.14	I2C Trigger (Option)	112
8.7.15	SPI Trigger (Option)	116
8.7.16	CAN Trigger (Option)	118
8.7.17	FlexRay Trigger (Option)	121
8.7.18	LIN Trigger (Option)	123
8.7.19	I2S Trigger (Option)	126
8.7.20	MIL-STD-1553 Trigger (Option)	129
8.8	Zone Trigger	133
8.9	Trigger Output Connector	135
9	Operations and Measurements	137
9.1	Math Operation	137
9.1.1	Addition	138
9.1.2	Subtraction	139
9.1.3	Multiplication	140
9.1.4	Division	141
9.1.5	FFT	143
9.1.6	"AND" Operation	147
9.1.7	"OR" Operation	149
9.1.8	"XOR" Operation	151
9.1.9	"NOT" Operation	152
9.1.10	Intg	154
9.1.11	Diff	155
9.1.12	Sqrt	156
9.1.13	Lg (Base 10 Exponential)	157
9.1.14	Ln	158
9.1.15	Exp	160
9.1.16	Abs	161
9.1.17	Low Pass	162
9.1.18	High Pass	163
9.1.19	Band Pass	165
9.1.20	Band Stop	166
9.1.21	AX+B	167
9.1.22	Avg	169
9.1.23	Math Operation Label	170
9.2	Auto Measurement	171
9.2.1	Quick Measurement after AUTO	171
9.2.2	Measurement Parameter	173

9.2.3	Measurement Settings	181
9.2.4	Remove the Measurement Result	185
9.2.5	Statistical Function	186
9.2.6	All Measurement	186
9.3	Cursor Measurement	186
9.3.1	Manual Mode	188
9.3.2	Track Mode	193
9.3.3	XY Mode	196
9.3.4	Measure Mode	198
10	Digital Voltmeter (DVM) and Frequency Counter	199
10.1	Digital Voltmeter (DVM)	199
10.1.1	To Enable or Disable DVM Measurement	199
10.1.2	To Select the Measurement Source	200
10.1.3	To Select Measurement Mode	200
10.1.4	To Set the Limits	200
10.2	Frequency Counter	201
10.2.1	To Enable or Disable the Frequency Counter	201
10.2.2	To Select the Measurement Source	202
10.2.3	To Select the Measurement Item	202
10.2.4	To Set the Resolution	202
10.2.5	To Clear Count	202
10.2.6	To Enable or Disable the Statistical Function	202
11	Power Analysis (Option)	204
11.1	Power Quality	204
11.2	Ripple	207
12	Histogram Analysis	209
12.1	To Enable or Disable the Histogram Function	209
12.2	To Select the Histogram Type	210
12.3	To Select the Histogram Source	210
12.4	To Set the Measurement Items	210
12.5	To Set the Histogram Height	211
12.6	To Set the Histogram Range	211
12.7	To Enable or Disable the Statistical Function	211
12.8	To Reset	212
13	Real-time Eye Diagram and Jitter Analysis (Option)	213
13.1	Real-time Eye Analysis	213
13.1.1	To Enable or Disable the Eye Analysis Function	214

13.1.2	To Select the Source of the Eye Diagram	214
13.1.3	Threshold Settings	214
13.1.4	To Set Clock Recovery	215
13.1.5	To Enable or Disable the Eye Measurement Result	216
13.1.6	To Reset Color	217
13.2	Jitter Analysis	217
13.2.1	To Enable or Disable the Jitter Function	218
13.2.2	To Select the Jitter Source	218
13.2.3	Threshold Settings	218
13.2.4	To Set Clock Recovery	219
13.2.5	To Set the Jitter Measurement	219
13.2.6	To Enable or Disable the Jitter Measurement Result	222
13.2.7	To Reset Statistics	222
14	Digital Channel	223
14.1	To Select the Digital Channel	223
14.2	To Enable/Disable the Digital Channel	224
14.3	To Set the Threshold	225
14.4	Auto Arrangement Setting	225
14.5	To Set the Waveform Display Size	226
14.6	To Set the Label	226
14.7	Group Setting	226
14.8	Waveform Color of the Digital Channel	227
15	Protocol Decoding	229
15.1	Parallel Decoding	229
15.2	RS232 Decoding (Option)	236
15.3	I2C Decoding (Option)	243
15.4	SPI Decoding (Option)	248
15.5	LIN Decoding (Option)	254
15.6	CAN Decoding (Option)	261
15.7	FlexRay Decoding (Option)	266
15.8	I2S Decoding (Option)	271
15.9	1553B Decoding (Option)	276
16	Reference Waveform	280
16.1	To Enable the Ref Function	280
16.2	To Select the Reference Channel	280
16.3	To Select the Ref Source	280
16.4	To Adjust the Ref Waveform Display	281

16.5	To Save to Internal Memory	281
16.6	To Clear the Display of the Reference Waveform	281
16.7	To View Details of the Reference Waveform	281
16.8	To Reset the Reference Waveform	282
16.9	To Set the Color of the Reference Waveform	282
16.10	To Set the Label	282
16.11	To Export to Internal or External Memory	283
16.12	To Import from Internal or External Memory	283
17	Pass/Fail Test	284
17.1	To Enable or Disable the Pass/Fail Test Function	284
17.2	To Start or Stop the Pass/Fail Test Operation	284
17.3	To Select the Source	284
17.4	To Create a Mask	285
17.5	To Save a Mask	286
17.6	To Load a Mask	286
17.7	To Set the Output Form of the Test Results	286
17.8	To Enable or Disable the Display of the Statistics of the Test Results	287
17.9	To Reset Statistics	288
18	Waveform Recording and Playing	289
18.1	Common Settings	289
18.2	Record Options	290
18.3	Play Options	292
19	Search and Navigation Function	293
19.1	Search Function	293
19.2	Navigation Function	295
20	Display Control	297
20.1	To Select the Display Type	297
20.2	To Set the Persistence Time	297
20.3	To Set the Waveform Intensity	298
20.4	To Set the Screen Grid	298
20.5	To Set the Grid Brightness	299
20.6	Show Scale	299
20.7	Color Grade	299
20.8	Waveform Freeze	299
21	Function/Arbitrary Waveform Generator (Option)	301
21.1	To Output Basic Waveforms	301
21.1.1	To Output Sine	301

21.1.2	To Output Square	303
21.1.3	To Output Ramp	303
21.1.4	To Output Pulse	304
21.1.5	To Output DC	304
21.1.6	To Output Noise	305
21.1.7	Sinc	305
21.1.8	Exp.Rise	306
21.1.9	Exp.Fall	307
21.1.10	ECG	307
21.1.11	Gauss	308
21.1.12	Lorentz	309
21.1.13	Haversine	310
21.2	To Output the Arbitrary Waveform	311
21.2.1	To Load the Channel and Waveform	311
21.2.2	To Create the Waveforms	312
21.2.3	To Edit the Waveforms	314
21.3	Modulation	316
21.3.1	AM	316
21.3.2	FM	317
21.3.3	FSK	318
21.4	Sweep	319
21.5	Burst	321
22	Store and Load	323
22.1	Storage System	323
22.2	Storage Type	323
22.2.1	Binary Data Format (.bin)	326
22.3	Load Type	329
22.4	Internal Storage and Load	329
22.5	External Storage and Load	331
22.6	Disk Management	332
22.6.1	To Select the File Type	333
22.6.2	To Create a Folder	333
22.6.3	To Delete a File or Folder	337
22.6.4	To Copy and Paste a File or Folder	338
22.6.5	To Rename a File or Folder	339
22.6.6	To Clear the Internal Memory Safely	339
22.7	Factory Settings	339

23	System Utility Function Setting	359
23.1	Remote Interface Configuration	359
23.1.1	LAN Configuration	359
23.1.2	To Set mDNS	362
23.1.3	To Set the Host Name	362
23.1.4	To Set the GPIB address	362
23.1.5	To Set HDMI	362
23.1.6	USB Connection	363
23.2	System-related	363
23.2.1	Beeper	363
23.2.2	Language	363
23.2.3	System Information	363
23.2.4	Power On	364
23.2.5	Power Status	364
23.2.6	Aux Output	364
23.2.7	Ref Clock	365
23.2.8	Help Menu	365
23.2.9	SelfCal	366
23.2.10	Auto Config	367
23.2.11	Print Setting	367
23.2.12	Email	369
23.2.13	Key Locker	370
23.2.14	Quick Operation	371
23.2.15	Screen Saver	374
23.2.16	Self-check	375
23.2.17	System Time	376
23.2.18	Default Option	377
24	Remote Control	379
24.1	Remote Control via USB	380
24.2	Remote Control via LAN	380
24.3	Remote Control via GPIB	381
25	Troubleshooting	383
26	Appendix	385
26.1	Appendix A: Options and Accessories	385
26.2	Appendix B: Warranty	386
	Index	387

List of Figures

Figure 4.1 Front View	13
Figure 4.2 Vertical View	13
Figure 4.3 To Adjust the Supporting Legs	14
Figure 4.4 To Connect to AC Power	14
Figure 4.5 Fuse Replacement	16
Figure 4.6 Connect the Passive Probe	17
Figure 4.7 To Connect the Probe Head to the Preamp of the Active Probe	17
Figure 4.8 Connect the Active Probe	18
Figure 4.9 Connect the logic probe	19
Figure 4.10 To Use the Compensation Signal	19
Figure 4.11 Square Waveform Signal	20
Figure 4.12 Probe Compensation	21
Figure 4.13 Front Panel Overview	21
Figure 4.14 Rear Panel Overview	23
Figure 4.15 User Interface	32
Figure 4.16 Tap Gesture	37
Figure 4.17 Pinch & Stretch Gesture	38
Figure 4.18 Drag Gesture	38
Figure 4.19 Rectangle Drawing Gesture(a)	39
Figure 4.20 Rectangle Drawing Gesture(b)	39
Figure 4.21 Numeric Keypad	41
Figure 4.22 To Use the Security Lock	42
Figure 4.23 Help Information	43
Figure 5.1 Waveform Invert	55
Figure 5.2 Zero Offset	57
Figure 5.3 Label Editing Interface	58
Figure 6.1 Delayed Sweep Mode	63

Figure 7.1 Measurement Schematic Diagram of Phase Deviation	66
Figure 7.2 Waveforms before Averaging	69
Figure 7.3 Waveforms after 128 Times of Averaging	69
Figure 7.4 Memory Depth	73
Figure 8.1 Schematic Diagram of the Acquisition Memory	78
Figure 8.2 Schematic Diagram of Trigger Holdoff	81
Figure 8.3 Positive Pulse Width/Negative Pulse Width	83
Figure 8.4 Positive Slope Time/Negative Slope Time	86
Figure 8.5 Pattern Trigger	92
Figure 8.6 Virtual Keypad for Pattern Setting	93
Figure 8.7 Duration Trigger	95
Figure 8.8 Timeout Trigger	97
Figure 8.9 Runt Trigger	99
Figure 8.10 Delay Trigger	104
Figure 8.11 Setup/Hold Trigger	106
Figure 8.12 Nth Edge Trigger	108
Figure 8.13 Schematic Diagram of RS232 Protocol	110
Figure 8.14 Schematic Diagram of I2C Protocol	112
Figure 8.15 Virtual Keypad for Binary Data Bit	114
Figure 8.16 Virtual Keypad for Hex Data Bit	115
Figure 8.17 Sequential Chart of SPI Bus	116
Figure 8.18 Data Frame Format of the CAN Bus	118
Figure 8.19 Sample Position	120
Figure 8.20 Frame Format of FlexRay Bus	121
Figure 8.21 Data Frame Format of the LIN Bus	124
Figure 8.22 Sample Position	126
Figure 8.23 Sequential Chart of I2S Bus	127
Figure 8.24 Formats of the Command Word, Data Word, and Status Word of the 1553B Bus	130

Figure 8.25 Trigger Output Connector	135
Figure 9.1 Time Parameters	174
Figure 9.2 Voltage Parameters	179
Figure 9.3 Manual Cursor Measurement Example	193
Figure 9.4 Lissajous Schematic Diagram	198
Figure 11.1 Connection Diagram of Power Quality Analysis	206
Figure 11.2 Connection Diagram of Ripple Analysis	208
Figure 13.1 Diagram of Eye Measurement Parameters	217
Figure 15.1 Schematic Diagram of Parallel Decoding	230
Figure 15.2 Parallel Decoding Event Table	234
Figure 15.3 Schematic Diagram of RS232 Serial Bus	236
Figure 15.4 Schematic Diagram of Negative Logic	236
Figure 15.5 I2C Serial Bus	243
Figure 15.6 I2C Decoding Event Table	246
Figure 15.7 SPI Serial Bus	249
Figure 15.8 SPI Decoding Event Table	253
Figure 15.9 LIN Decoding Event Table	257
Figure 15.10 Sample Position	262
Figure 15.11 CAN Decoding Event Table	264
Figure 15.12 Sample Position	268
Figure 15.13 FlexRay Decoding Event Table	269
Figure 15.14 I2S Decoding Event Table	274
Figure 15.15 1553B Decoding Event Table	277
Figure 18.1 Recording Process	290
Figure 21.1 Symmetry Definition	303
Figure 21.2 Duty Cycle Definition	304
Figure 21.3 Sinc	306
Figure 21.4 Exp.Rise	306
Figure 21.5 Exp.FallExp.Fall	307

Figure 21.6 ECG	308
Figure 21.7 Gauss	309
Figure 21.8 Lorentz	310
Figure 21.9 Haversine	311
Figure 21.10 AM	316
Figure 21.11 FM	317
Figure 22.1 Disk Management Interface	333
Figure 22.2 Create a Folder	334
Figure 23.1 Network Connection Setting Interface	359
Figure 23.2 SelfCal	367
Figure 24.1 Search for the Available Device	382
Figure 24.2 Confirm the Available Device	382

List of Tables

Table 4.1 Front Panel Description	21
Table 5.2 BW Limit	52
Table 5.3 Probe Ratio	53
Table 9.1 Window Function	146
Table 9.2 Logic "AND" Operation	147
Table 9.3 Logic "OR" Operation	149
Table 9.4 Logic "XOR" Operation	151
Table 9.5 Logic "NOT" Operation	152
Table 22.4 Factory Settings	339

1 Safety Requirement

1.1 General Safety Summary

Please review the following safety precautions carefully before putting the instrument into operation so as to avoid any personal injury or damage to the instrument and any product connected to it. To prevent potential hazards, please follow the instructions specified in this manual to use the instrument properly.

- **Use Proper Power Cord.**

Only the exclusive power cord designed for the instrument and authorized for use within the destination country could be used.

- **Ground the Instrument.**

The instrument is grounded through the Protective Earth lead of the power cord. To avoid electric shock, it is essential to connect the earth terminal of the power cord to the Protective Earth terminal before connecting any inputs or outputs.

- **Connect the Probe Correctly.**

If a probe is used, the probe ground lead must be connected to earth ground. Do not connect the ground lead to high voltage. Improper way of connection could result in dangerous voltages being present on the connectors, controls or other surfaces of the oscilloscope and probes, which will cause potential hazards for operators.

- **Observe All Terminal Ratings.**

To avoid fire or shock hazard, observe all ratings and markers on the instrument and check your manual for more information about ratings before connecting the instrument.

- **Use Proper Overvoltage Protection.**

Ensure that no overvoltage (such as that caused by a bolt of lightning) can reach the product. Otherwise, the operator might be exposed to the danger of an electric shock.

- **Do Not Operate Without Covers.**

Do not operate the instrument with covers or panels removed.

- **Do Not Insert Objects into the Air Outlet.**

Do not insert objects into the air outlet, as doing so may cause damage to the instrument.

- **Use the Proper Fuse.**

Please use the specified fuses.

- **Avoid Circuit or Wire Exposure.**

Do not touch exposed junctions and components when the instrument is powered on.
- **Do Not Operate With Suspected Failures.**

If you suspect that any damage may occur to the instrument, have it inspected by RIGOL authorized personnel before further operations. Any maintenance, adjustment or replacement especially to circuits or accessories must be performed by RIGOL authorized personnel.
- **Provide Adequate Ventilation.**

Inadequate ventilation may cause an increase of temperature in the instrument, which would cause damage to the instrument. So please keep the instrument well ventilated and inspect the air outlet and the fan regularly.
- **Do Not Operate in Wet Conditions.**

To avoid short circuit inside the instrument or electric shock, never operate the instrument in a humid environment.
- **Do Not Operate in an Explosive Atmosphere.**

To avoid personal injuries or damage to the instrument, never operate the instrument in an explosive atmosphere.
- **Keep Instrument Surfaces Clean and Dry.**

To avoid dust or moisture from affecting the performance of the instrument, keep the surfaces of the instrument clean and dry.
- **Prevent Electrostatic Impact.**

Operate the instrument in an electrostatic discharge protective environment to avoid damage induced by static discharges. Always ground both the internal and external conductors of cables to release static before making connections.
- **Use the Battery Properly.**

Do not expose the battery (if available) to high temperature or fire. Keep it out of the reach of children. Improper change of a battery (lithium battery) may cause an explosion. Use the RIGOL specified battery only.
- **Handle with Caution.**

Please handle with care during transportation to avoid damage to keys, knobs, interfaces, and other parts on the panels.

**WARNING**

Equipment meeting Class A requirements may not offer adequate protection to broadcast services within residential environment.

1.2 Safety Notices and Symbols

Safety Notices in this Manual:



WARNING

Indicates a potentially hazardous situation or practice which, if not avoided, will result in serious injury or death.



CAUTION

Indicates a potentially hazardous situation or practice which, if not avoided, could result in damage to the product or loss of important data.

Safety Notices on the Product:

- DANGER**
 It calls attention to an operation, if not correctly performed, could result in injury or hazard immediately.
- WARNING**
 It calls attention to an operation, if not correctly performed, could result in potential injury or hazard.
- CAUTION**
 It calls attention to an operation, if not correctly performed, could result in damage to the product or other devices connected to the product.

Safety Symbols on the Product:



Hazardous
Voltage



Safety Warning



Protective Earth
Terminal

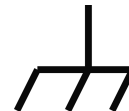

Chassis Ground



Test Ground

1.3 Measurement Category

Measurement Category

This instrument can make measurements in Measurement Category I.



WARNING

This instrument can only be used for measurements within its specified measurement categories.

Measurement Category Definitions

- **Measurement category I** is for measurements performed on circuits not directly connected to MAINS. Examples are measurements on circuits not derived from MAINS, and specially protected (internal) MAINS derived circuits. In the latter case, transient stresses are variable. Thus, you must know the transient withstand capability of the equipment.
- **Measurement category II** is for measurements performed on circuits directly connected to low voltage installation. Examples are measurements on household appliances, portable tools and similar equipment.
- **Measurement category III** is for measurements performed in the building installation. Examples are measurements on distribution boards, circuit-breakers, wiring (including cables, bus-bars, junction boxes, switches and socket-outlets) in the fixed installation, and equipment for industrial use and some other equipment. For example, stationary motors with permanent connection to a fixed installation.
- **Measurement category IV** is for measurements performed at the source of a low-voltage installation. Examples are electricity meters and measurements on primary overcurrent protection devices and ripple control units.

1.4 Ventilation Requirement

This instrument uses a fan to force cooling. Please make sure that the air inlet and outlet areas are free from obstructions and have free air. When using the instrument in a bench-top or rack setting, provide at least 10 cm clearance beside, above and behind the instrument for adequate ventilation.



CAUTION

Inadequate ventilation may cause an increase of temperature in the instrument, which would cause damage to the instrument. So please keep the instrument well ventilated and inspect the air outlet and the fan regularly.

1.5 Working Environment

Temperature

Operating: 0°C to +50°C

Non-operating: -30°C to +70°C

Humidity

- **Operating:**
 - Below +30°C: ≤90%RH (without condensation)
 - +30°C to +40°C: ≤75% RH (without condensation)

+40°C to +50°C: ≤45%RH (without condensation)

- **Non-operating:**

Below +65°C: ≤90%RH (without condensation)



WARNING

To avoid short circuit inside the instrument or electric shock, never operate the instrument in a humid environment.

Altitude

- **Operating:** below 3 km
- **Non-operating:** below 15 km

Protection Level Against Electric Shock

ESD ±8kV

Installation (Overvoltage) Category

This product is powered by mains conforming to installation (overvoltage) category II.



WARNING

Ensure that no overvoltage (such as that caused by a bolt of lightning) can reach the product. Otherwise, the operator might be exposed to the danger of an electric shock.

Installation (Overvoltage) Category Definitions

Installation (overvoltage) category I refers to signal level which is applicable to equipment measurement terminals connected to the source circuit. Among these terminals, precautions are done to limit the transient voltage to a low level.

Installation (overvoltage) category II refers to the local power distribution level which is applicable to equipment connected to the AC line (AC power).

Pollution Degree

Pollution Degree 2

Pollution Degree Definition

- **Pollution Degree 1:** No pollution or only dry, nonconductive pollution occurs. The pollution has no effect. For example, a clean room or air-conditioned office environment.
- **Pollution Degree 2:** Normally only nonconductive pollution occurs. Temporary conductivity caused by condensation is to be expected. For example, indoor environment.
- **Pollution Degree 3:** Conductive pollution or dry nonconductive pollution that becomes conductive due to condensation occurs. To be found in industrial

environment or construction sites (harsh environments). For example, sheltered outdoor environment.

- **Pollution Degree 4:** The pollution generates persistent conductivity caused by conductive dust, rain, or snow. For example, outdoor areas.

Safety Class

Class 1 – Grounded Product

1.6 Care and Cleaning

Care

Do not store or leave the instrument where it may be exposed to direct sunlight for long periods of time.

Cleaning

Clean the instrument regularly according to its operating conditions.

1. Disconnect the instrument from all power sources.
2. Clean the external surfaces of the instrument with a soft cloth dampened with mild detergent or water. Avoid having any water or other objects into the chassis via the heat dissipation hole. When cleaning the LCD, take care to avoid scarifying it.



CAUTION

To avoid damage to the instrument, do not expose it to caustic liquids.



WARNING

To avoid short-circuit resulting from moisture or personal injuries, ensure that the instrument is completely dry before connecting it to the power supply.

1.7 Environmental Considerations

The following symbol indicates that this product complies with the WEEE Directive 2002/96/EC.



The equipment may contain substances that could be harmful to the environment or human health. To avoid the release of such substances into the environment and avoid harm to human health, we recommend you to recycle this product appropriately to ensure that most materials are reused or recycled properly. Please contact your local authorities for disposal or recycling information.

You can click on the following link <https://int.rigol.com/services/services/declaration> to download the latest version of the RoHS&WEEE certification file.

2 MSO8000A Series Overview

MSO8000A series digital oscilloscope developed by RIGOL is a medium and high-end mixed signal digital oscilloscope designed on UltraVision II technical platform. With the analog bandwidth up to 2 GHz, the digital oscilloscope integrates 7 instruments into one, with 500 Mpts memory depth, sound waveform display effects, excellent waveform capture rate, and powerful data analysis functions. Many of its specifications have reached the top level in the industry. Meanwhile, it supports the real-time eye diagram measurement and jitter analysis. Its cost-effective features and high performance make it prominent as the 2 GHz mixed signal digital oscilloscope.

Main Features:

- Analog channel bandwidth: 750 MHz, 1.5 GHz, and 2 GHz
- 4 analog channels and 1 EXT channel, 16 digital channels (required to purchase the probe)
- Up to 10 GSa/s real-time sample rate
- Max. memory depth: 500 Mpts (std.)
- Waveform capture rate 600,000 wfms/s
- Recording and playback for a maximum of 450,000 frames of hardware real-time and ceaseless waveforms
- Integrates 7 independent instruments into 1, including digital oscilloscope, 16-channel logic analyzer, spectrum analyzer, arbitrary waveform generator (option), digital voltmeter, 6-digit frequency counter and totalizer, and protocol analyzer (option)
- Provides auto measurement for up to 41 waveform parameters, offers full-memory hardware measurement function
- Various math operations, built-in powerful FFT analysis and peak search functions
- Histogram analysis (standard)
- Independent search, navigation key, and event table
- Real-time eye diagram and jitter analysis software (option)
- Advanced built-in power analysis software (option)

- User-defined one-key quick operation
- 10.1-inch capacitive multi-touch screen, 256-level intensity grading display, with color persistence
- Multiple interfaces available: USB HOST & DEVICE, LAN (LXI), HDMI, TRIG OUT, and USB-GPIB
- Web Control remote command
- Unique online upgrade
- Compact and portable industrial design, easy to operate

3 Document Overview

This manual gives you a quick review about the front and rear panel of MSO8000A series, the user interface, and the basic operation method.



TIP

For the latest version of this manual, download it from the official website of RIGOL (<http://www.rigol.com>).

Publication Number

UGA31100-1110

Format Conventions in this Manual:



1. Key

The front panel key is denoted by menu key icon. For example,  indicates the "Default" key.

2. Menu

The menu items are denoted by the format of "Menu Word (Bold) + Character Shading". For example, **System** denotes the "System" menu item under the  menu.





3. Operation Procedures:





">" denotes the next step of operation. For example,  > **System** denotes that first press , and then press the **System** key.

4. Connector

The connectors on the front or rear panel are usually denoted by the format of "Connector Name (Bold) + Square Brackets (Bold)". For example, **[TRIG OUT]**.

5. Knob

Label	Knob	Label	Knob
Horizontal  SCALE	Horizontal Scale Knob	Vertical  SCALE	Vertical Scale Knob
Horizontal  POSITION	Horizontal Position Knob	Vertical  OFFSET	Vertical Offset Knob

Label	Knob	Label	Knob
Wave Vertical  <u>SCALE</u>	Vertical Scale Knob	Trigger  <u>LEVEL</u>	Trigger Level Knob
Wave Vertical  <u>POSITION</u>	Wave Vertical Position Knob		Multifunction knob

Content Conventions in this Manual:

MSO8000A series includes the following models. Unless otherwise specified, this manual takes MSO8204A as an example to illustrate the functions and operation methods of the MSO8000A series.

Model	Max. Analog Bandwidth	No. of Digital Channels	No. of Analog Channels	No. of AWG Channels
MSO8074A	750 MHz	16	4	2
MSO8154A	1.5 GHz	16	4	2
MSO8204A	2 GHz	16	4	2

4 Quick Start

This chapter introduces the precautions when using the oscilloscope for the first time, the front/rear panels of the oscilloscope, the user interface, touch screen controls, and how to use the built-in help system.

4.1 General Inspection

1. Inspect the packaging

If the packaging has been damaged, do not dispose the damaged packaging or cushioning materials until the shipment has been checked for completeness and has passed both electrical and mechanical tests.

The consigner or carrier shall be liable for the damage to the instrument resulting from shipment. RIGOL would not be responsible for free maintenance/rework or replacement of the instrument.

2. Inspect the instrument

In case of any mechanical damage, missing parts, or failure in passing the electrical and mechanical tests, contact your RIGOL sales representative.

3. Check the accessories

Please check the accessories according to the packing lists. If the accessories are damaged or incomplete, please contact your RIGOL sales representative.

4.2 Appearance and Dimensions

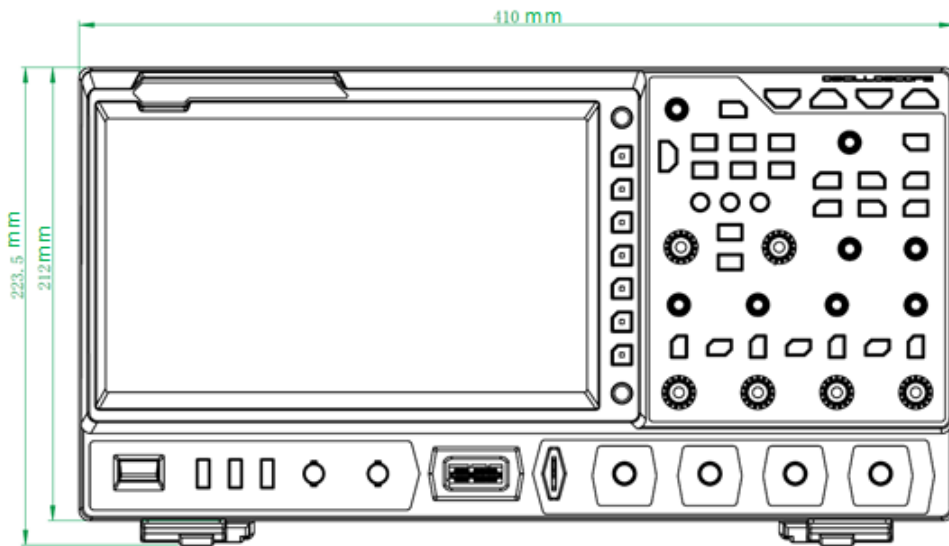

Figure 4.1 Front View

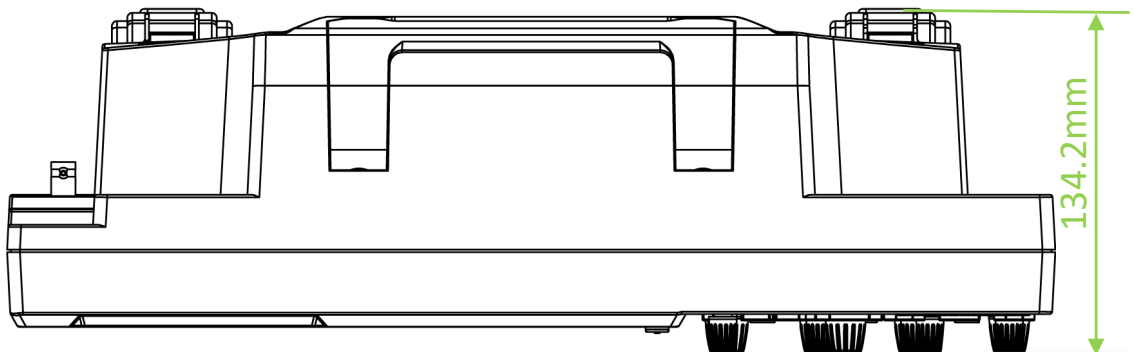

Figure 4.2 Vertical View

4.3 To Prepare for Use

4.3.1 To Adjust the Supporting Legs

Adjust the supporting legs properly to use them as stands to tilt the oscilloscope upwards for stable placement of the oscilloscope as well as better operation and observation. Users can also fold the supporting legs when the instrument is not in use for easier storage or shipment, as shown in the figure below.

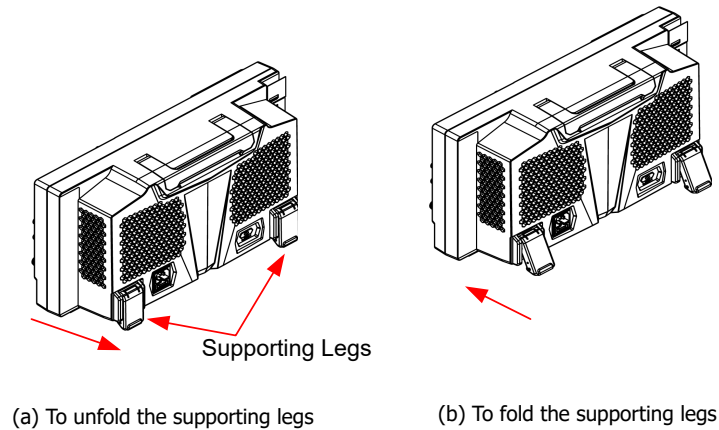

Figure 4.3 To Adjust the Supporting Legs

4.3.2 To Connect to AC Power

The input AC power requirements of the oscilloscope are 100 V-240 V, 45 Hz-440 Hz. Please use the power cord provided in the accessories to connect the oscilloscope to the AC power source, as shown in the figure below.

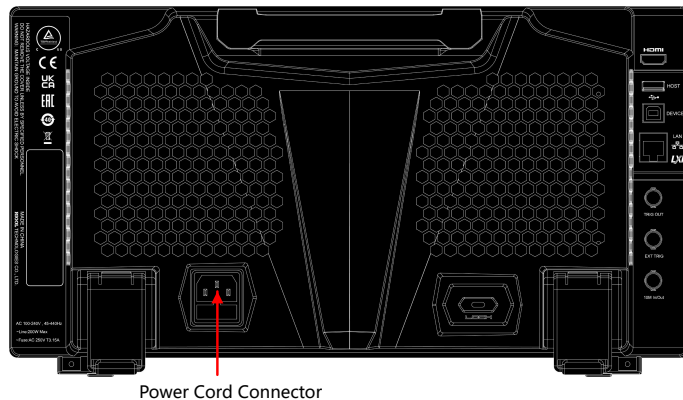



Figure 4.4 To Connect to AC Power



WARNING

To avoid electric shock, ensure that the instrument is correctly grounded.

4.3.3 Turn-on Checkout

When the oscilloscope is connected to power, press the Power key at the lower-left corner of the front panel to start the oscilloscope. (You can also press  > **System** > **Power status**, and select "Switch On". After the instrument is connected to power source, it will start directly.) You can also enable the touch screen to perform the above operations.) During the start-up process, all the backlights of the front-panel

keys are illuminated for a few seconds. The oscilloscope starts to perform a series of self-tests. After the self-test, the splash screen is displayed.





NOTE

Restart and Shutdown:

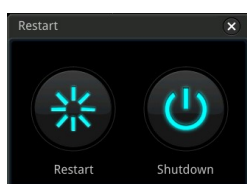
1. Enable the touch screen and then tap the function navigation icon  at the lower-left corner of the touch screen to enable the function navigation.
2. Tap the "Restart" icon, and then you can select "Restart" or "Shutdown", as shown in the figure below.



3. If you tap "Restart" , the oscilloscope powers off and then automatically restarts again.
If you tap "Shutdown" , the oscilloscope powers off (you can also press the Power key at the lower-left corner of the front panel to turn off the oscilloscope).

4.3.4 Fuse Replacement

If you need to replace the fuse, please use the specified fuse (AC 250 V, T3.15 A; 5.2 mm × 20 mm) and perform the following operations (as shown in *Figure 4.5*):

1. Turn off the instrument, cut off the power, and remove the power cord.
2. Use a small straight slotted screwdriver to pry out the fuse holder.
3. Take out the fuse holder.
4. Replace the old fuse with a specified fuse.
5. Install the fuse holder.

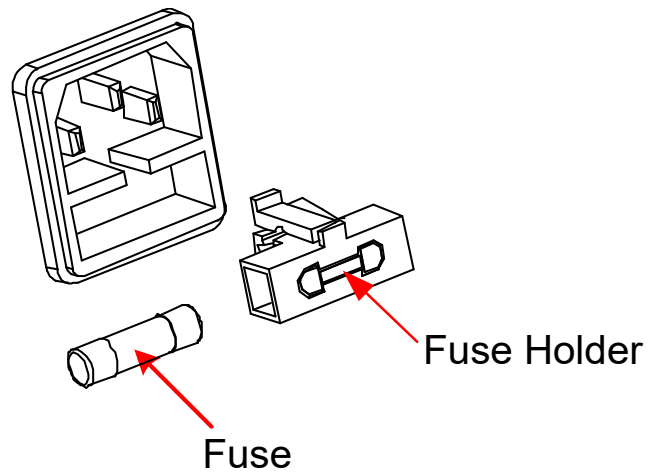

Figure 4.5 Fuse Replacement



WARNING

To avoid electric shock, please ensure that the instrument has been turned off, the power source has been cut off, and the fuse to be used conforms to the fuse rating.

4.3.5 To Connect the Probe

RIGOL provides the passive probe, the active probe, and the logic probe for the MSO8000A series. For specific probe models, please refer to *MSO8000A Datasheet*. For detailed technical information of the probes, please refer to the corresponding Probe User Guide.

Connect the passive probe:

1. Connect the BNC terminal of the probe to an analog channel input terminal of the oscilloscope on the front panel as shown in [Figure 4.6](#).
2. Connect the ground alligator clip or spring of the probe to the circuit ground terminal, and then connect the probe tip to the circuit point to be tested.

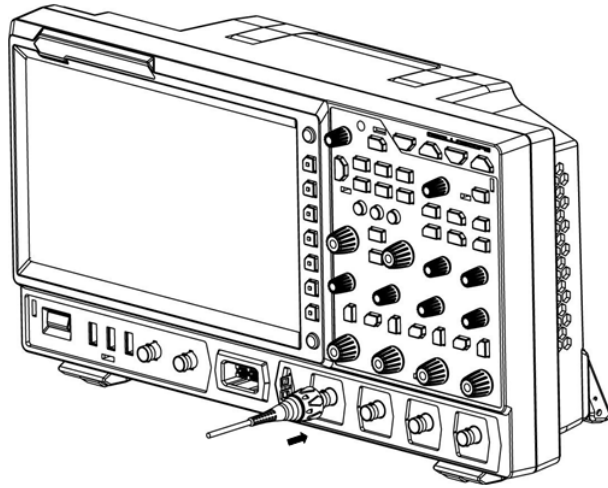

Figure 4.6 Connect the Passive Probe

After you connect the passive probe, check the probe function and probe compensation adjustment before making measurements. For detailed procedures, refer to "*Function Inspection*" and "*Probe Compensation*".

Connect the active probe:

Take RP7150 (active differential probe head) as an example.

1. Connect the probe head to the preamp of the active probe, as shown in *Figure 4.7*.

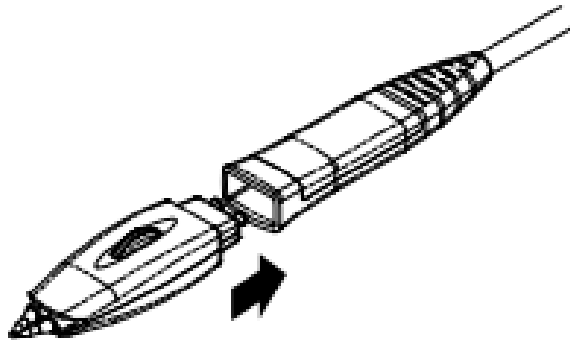

Figure 4.7 To Connect the Probe Head to the Preamp of the Active Probe

2. Connect the other end of the preamp to an analog channel input terminal of the oscilloscope on the front panel, as shown in the figure below.
3. Note that you need to push the probe to the due position to lock it firmly.

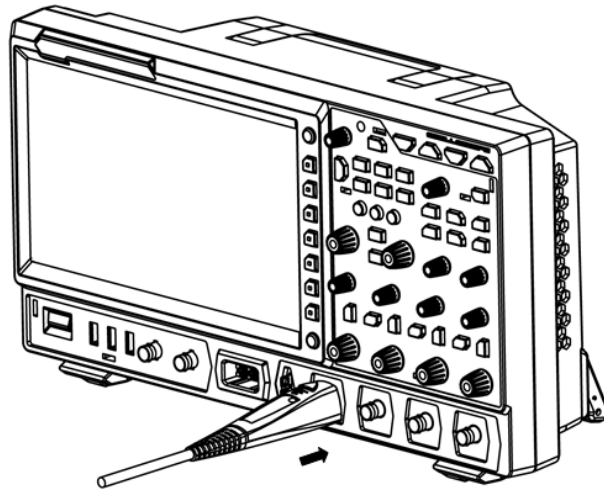

Figure 4.8 Connect the Active Probe

4. Use the probe's auxiliary device to connect the probe head to the circuit under test. For details about the probes, refer to *RP7000 Series Active Probe User Guide*.

After you connect the active probe, you can make probe calibration and offset voltage adjustment.

Connect the logic probe

1. Connect the output terminal of the logic probe to the digital channel input terminal on the front panel of the oscilloscope in the correct direction, as shown in *Figure 4.9*.
2. Connect the other terminal of the logic probe to the signal terminal under test. RIGOL's MSO8000A series has a standard configuration of a logic probe RPL2316. To apply to different application scenarios, RPL2316 provides three connection methods to connect the signal under test. For details, refer to *RPL2316 Logic Probe User Guide*.

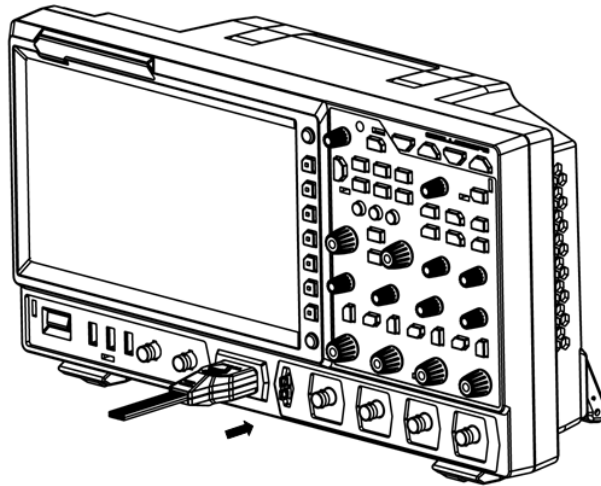

Figure 4.9 Connect the logic probe



NOTE

- Before you connect the logic probe to the signal under test, connect logic probe's adapter provided in the accessories to its corresponding channel group.
- The digital channel input terminal does not support hot plugging. Please do not insert or pull out the logic probe when the instrument is in power-on state.

4.3.6 Function Inspection

1. Press **Default** on the front panel, then a prompt message "Restore default settings?" is displayed. Press **OK** or tap **OK** to restore the instrument to its factory default settings.
2. Connect the ground alligator clip of the probe to the "Ground Terminal" as shown in *Figure 4.10*.
3. Use the probe to connect the input terminal of CH1 of the oscilloscope and the "Compensation Signal Output Terminal" of the probe, as shown in *Figure 4.10*.

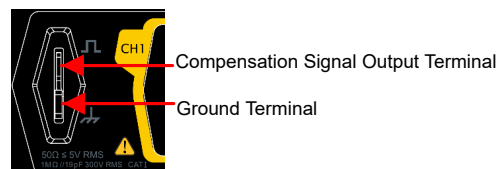

Figure 4.10 To Use the Compensation Signal

4. Set the probe attenuation to 10X, and then press **AUTO**.

5. Observe the waveform on the display. In normal condition, the square waveform as shown in *Figure 4.11* should be displayed.

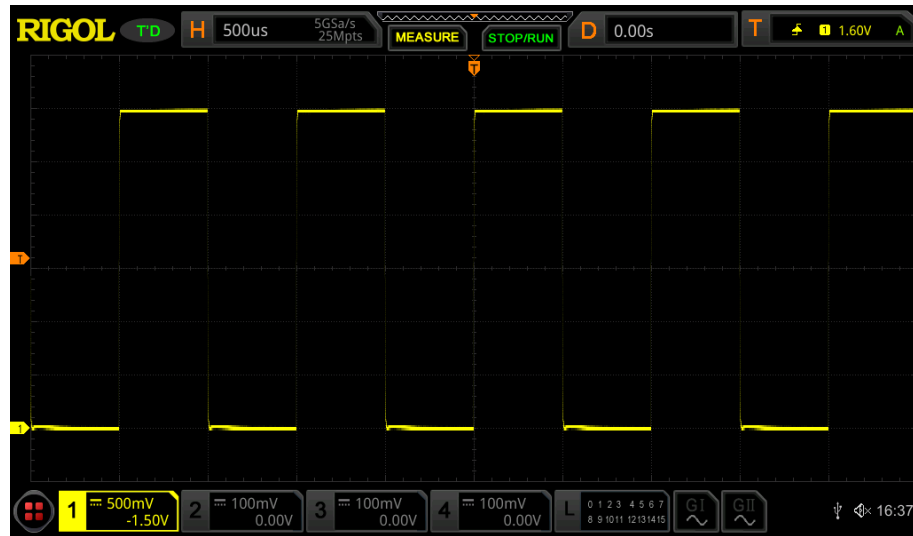

Figure 4.11 Square Waveform Signal

6. Use the same method to test the other channels. If the square waveforms actually shown do not match that in the figure above, please perform "*Probe Compensation*" introduced in the next section.



WARNING

To avoid electric shock when using the probe, please make sure that the insulated wire of the probe is in good condition. Do not touch the metallic part of the probe when the probe is connected to high voltage source.

4.3.7 Probe Compensation

When the probes are used for the first time, you should compensate the probes to make them match the input channels of the oscilloscope. Non-compensated or poorly compensated probes may cause measurement inaccuracy or errors. The probe compensation procedures are as follows:

1. Perform Step 1, 2, 3 and 4 specified in "*Function Inspection*".
2. Check the displayed waveforms and compare them with the waveforms shown in *Figure 4.12*.

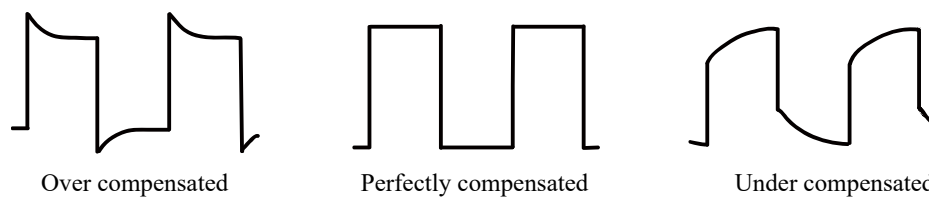

Figure 4.12 Probe Compensation

- Use the probe compensation adjustment tool provided in the accessories to adjust the low-frequency compensation adjustment hole on the probe until the displayed waveform is consistent with the "Perfectly compensated" waveform shown in *Figure 4.12*.

4.4 Front Panel Overview

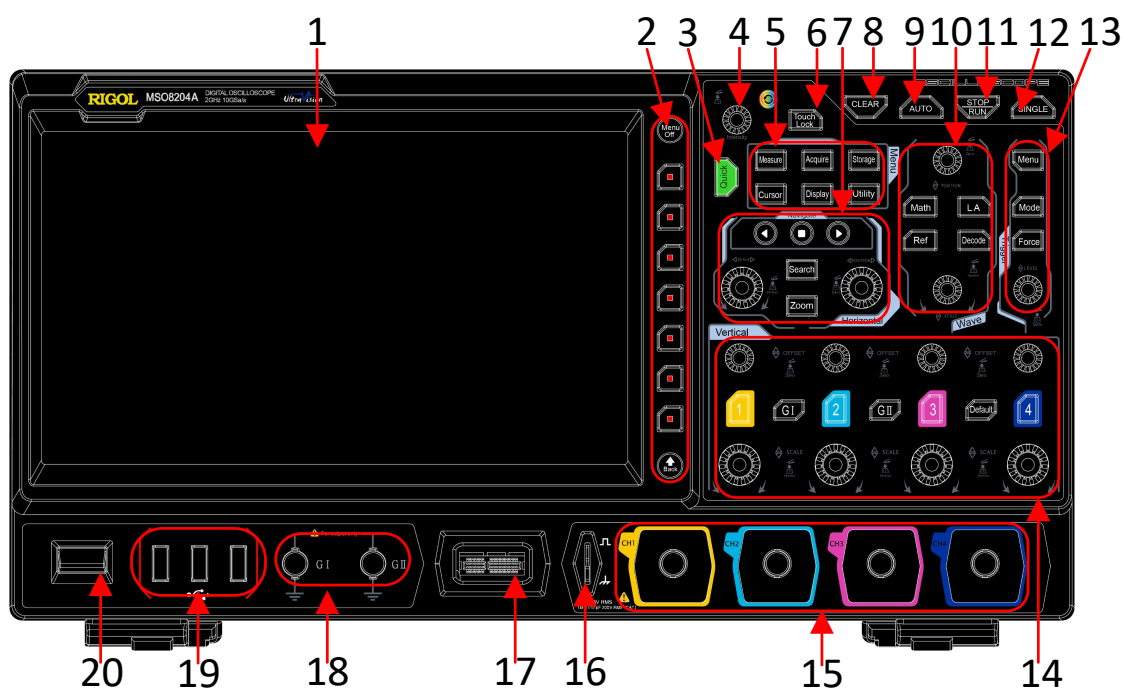

Figure 4.13 Front Panel Overview

Table 4.1 Front Panel Description

No.	Description	No.	Description
1	Capacitive Touch Screen	11	RUN/STOP Key

No.	Description	No.	Description
2	Function Menu Operation Keys	12	Single Trigger Control Key
3	Quick Key (Shortcut Key)	13	Trigger Control System
4	Multifunction Knob	14	Vertical Control System
5	Common Operation Keys	15	Analog Channel Input Terminals
6	Touch Lock Key	16	Probe Compensation Signal Output Terminal/Ground Terminal
7	Horizontal Control System	17	Digital Channel Input Interface
8	CLEAR Key	18	Dual-channel Function/Arbitrary Waveform Generator Output Terminals ^[1]
9	Auto Waveform Display Key	19	USB HOST Interface
10	Waveform Control System	20	Power Key

NOTE

^[1]: This function is only available for the model installed with the MSO8000-AWG option.



4.5 Rear Panel Overview

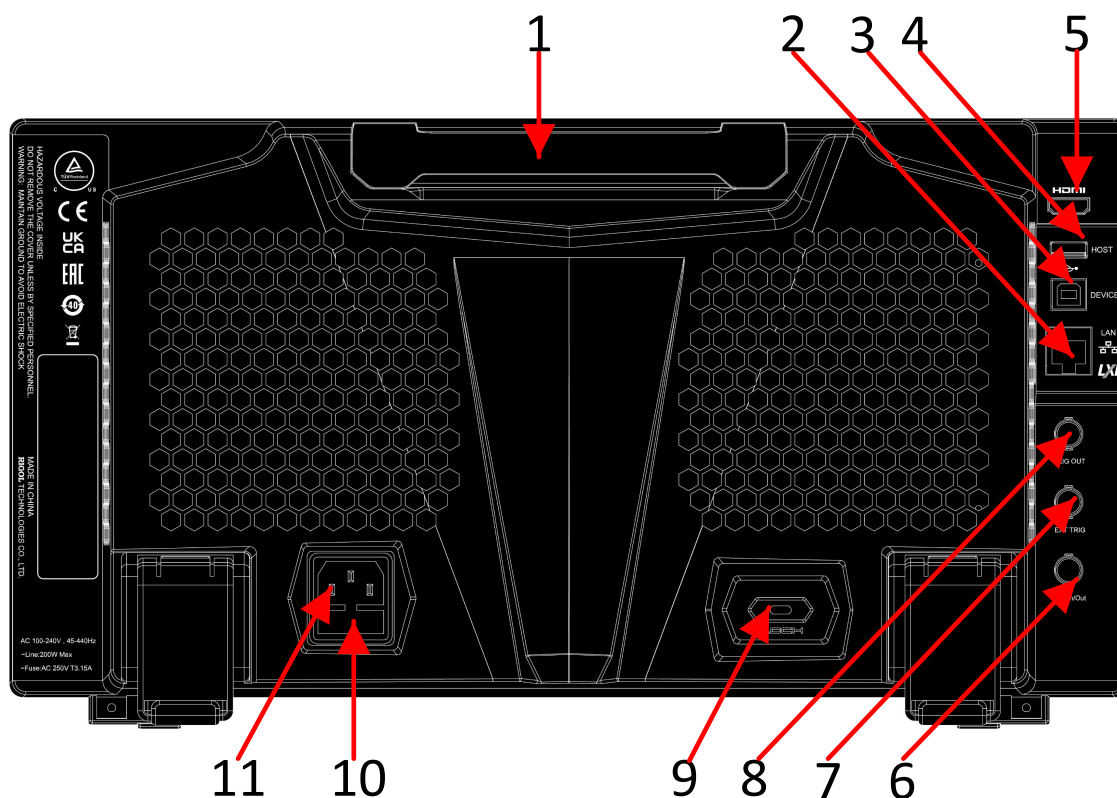

Figure 4.14 Rear Panel Overview

1. Handle

Rotate the handle upright to carry the instrument easily. Rotate it downward if you do not need to carry it.

2. LAN Interface

Connect the instrument to network via this interface. The instrument is in compliance with the standards specified in LXI Device Specification 2011. It can be used to set up a test system.

When you access to the Internet, you can use the Web Control or PC software Ultra Scope to send the SCPI commands or use the user-defined programming to control the instrument. When update is available, you can perform online upgrading for the system software of the instrument via the LAN interface. After it is connected to the network, you can print the waveform displayed on the screen when you use the network printer.

TIP



After the oscilloscope is connected to network (if you do not have the access to the Internet, please ask the administrator to open the specified network authority), you can perform online upgrading for the system software:

1. Enable the touch screen and then tap the function navigation icon  at the lower-left corner of the touch screen to enable the function navigation.
2. Tap the "Help" icon, and then the "Help" menu is displayed on the screen.
3. Press **Online upgrade** or enable the touch screen to tap "Online upgrade", then a "System Update Information" window is displayed, requesting you whether to accept or cancel "RIGOL TERMS OF ONLINE UPGRADE SERVICE". Tap "Accept" to start online upgrade. Tap "Cancel" to cancel the online upgrade.

3. USB DEVICE Interface

You can connect the instrument to the PC via this interface. Then you can use the PC software Ultra Scope to send the SCPI commands or use the user-defined programming to control the instrument.

4. USB HOST Interface

You can connect the storage device that is compatible with the USB to the instrument via the USB HOST interface.

Connecting the storage device can save or recall the waveform files and setup files, as well as save the data and screen image. When update is available, you can perform local upgrading for the system software of the instrument via the USB HOST interface.

NOTE

Perform local upgrading for the system software:

1. Insert the USB storage device (stored with upgrading files under its root directory) into the USB HOST interface, and then the "Help" menu is automatically displayed.
2. Press **Local upgrade** or enable the touch screen to tap "Local upgrade", then a dialog box "Upgrade system firmware?" is displayed.
3. Press **OK** or enable the touch screen to tap "OK" to start local upgrade for the oscilloscope. If you tap "Cancel", the local upgrade will be cancelled.

5. HDMI Video Output

Through this interface, you can connect the instrument to an external display (e.g. monitor or projector) equipped with the HDMI interface to better observe the waveform display clearly. At this time, you can also view the waveforms on the LCD of the instrument.

6. 10 M In/Out

Indicates the reference clock. It can provide accurate sample clock signal for the oscilloscope, and can be used to synchronize the clock of two or multiple oscilloscopes.

7. EXT TRIG

Inputs the external signal via the external input terminal.

8. Trigger Out and Pass/Fail

- TRIG OUT

The oscilloscope can output a signal that can reflect the current capture rate of the oscilloscope at each trigger via this interface. Connect the signal to a waveform display device and measure the frequency of the signal. The measurement result is the same as the current capture rate.

- Pass/Fail

The instrument can output a pulse from the **[TRIG OUT]** connector when a pass/failed event is detected during the pass/fail test.

9. Lock Hole

You can lock the instrument to a fixed location by using the security lock (please purchase it by yourself) via the lock hole.

10. Fuse

If you need to replace the fuse, use only the specified fuse. For details, refer to descriptions in "[Fuse Replacement](#)".





11. AC Power Cord Connector

Indicates the input terminal where AC power source is connected. The power supply requirements of the instrument are: 100 V~240 V; 45 Hz~ 440 Hz. Please use the power cord provided in the accessories to connect the oscilloscope to the AC power source.

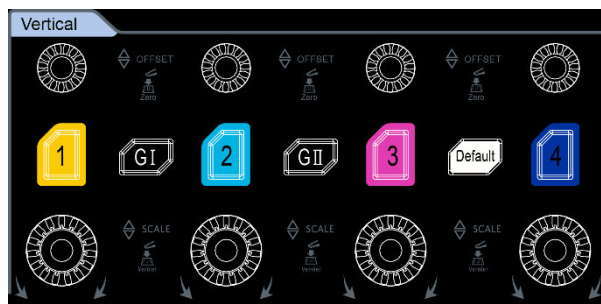
4.6 Front Panel Function Overview

4.6.1 Vertical





-    : indicates the analog channel switch key. The four channels are marked by different colors which are also used to mark both the corresponding

waveforms of the specified channel on the screen and the channel input connectors.

- : indicates the Function/Arbitrary Waveform Generator key. Press GI to enable or disable the output of the [GI] connector on the front panel; press GII to enable or disable the output of the [GII] connector on the front panel; and then enter the corresponding signal source setting interface. Enable or disable the status display of the current signal.

NOTE





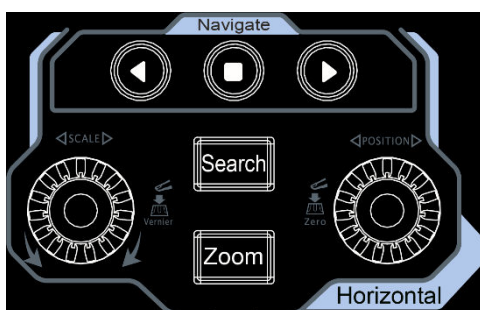

This function is only available for model installed with the MSO8000-AWG option.

- : indicates the default setting key. Press this key to restore the instrument to its factory default settings.
- Vertical**  **OFFSET**: indicates the channel vertical offset knob. You can rotate the knob to modify the vertical offset of the current channel waveform. Each analog channel is configured with an independent vertical offset adjustment knob. Turn it clockwise to increase the offset, and turn it counterclockwise to decrease the offset. During the modification, the waveform would move up and down. Meanwhile, the offset information in the corresponding status label would change accordingly. Press down this knob to quickly reset the vertical offset to zero.
- Vertical**  **SCALE**: indicates the channel vertical scale knob. It is used to modify the vertical scale of the current channel. Each analog channel is configured with an independent vertical scale adjustment knob. Turn it clockwise to decrease the scale, and turn it counterclockwise to increase the scale. During the modification, the display amplitude of the waveform will enlarge or reduce. The scale information in the corresponding status label will change accordingly. Press down this knob to quickly switch the vertical scale adjustment mode between "Coarse" and "Fine".

4.6.2 Horizontal







- : indicates the delayed sweep key. Press this key to enable or disable the delayed sweep function.

-  indicates the Search key. Press this key to enter the search setting menu. The search function allows you to search for relevant events from the collected data based on the user-set search condition.
-  indicates the navigation combination key. With the combination keys, you can perform recording&playing navigation, time navigation, and event navigation.
- Horizontal  POSITION:** indicates the horizontal position knob. Rotate the knob to modify the horizontal position (i.g. trigger position). The trigger point would move left or right relative to the center of the screen when you rotate the knob. During the modification, waveforms of all the channels would move left or right, and the horizontal position message (e.g. ) at the upper-right corner of the screen would change accordingly. Press down this knob to quickly reset the horizontal position (or the delayed sweep position).
- Horizontal  SCALE:** indicates the horizontal time base knob. You can rotate the knob to modify the horizontal time base. Turn it clockwise to decrease the time base, and turn it counterclockwise to increase the time base. During the modification, waveforms of all the channels will be displayed in expanded or compressed form, and the time base message (e.g. ) at the upper section of the screen would change accordingly. Press down this knob to quickly switch the horizontal time base adjustment mode between "Coarse" and "Fine".

4.6.3 Wave







- : indicates the math operation key. Press this key to enable the math operation function. The math operations include $A+B$, $A-B$, $A\times B$, A/B , FFT, and etc. Besides, you can also set the math operation label.
- : indicates the logic analyzer key. Press this key to open the logic analyzer control menu. You can enable or disable any channel or channel group, modify the waveform sizes of the digital channel, modify the threshold of the digital channel, and group the 16 digital channels. Besides, you can also set a label for each digital channel.
- : indicates the reference waveform key. Press this key to open the reference waveform setting menu. You can compare the actually measured waveform with the reference waveform to locate the circuit failure.
- : indicates the decode key. Press this key to open the decode setting menu, and then you can set the decode options. This series of oscilloscope supports the parallel decoding and many protocol decodings. (For details, refer to the descriptions in "*Protocol Decoding*").
- Wave Vertical**  **POSITION**: indicates the waveform vertical position knob. Rotate the knob to adjust the vertical position of the current digital channel waveform, the vertical position of the math operation waveform, the vertical

position of the reference waveform, or the vertical display position of the bus decoding.

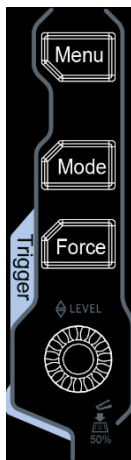
- **Wave Vertical**  **SCALE**: indicates the waveform vertical scale knob. Rotate the knob to adjust the vertical scale of math operation waveform or the vertical scale of the reference waveform, and also can adjust the size of the displayed digital channel waveforms.

4.6.4 Trigger



- : Press this key to open the trigger operation menu. This oscilloscope provides various trigger types.
- : Press this key to switch the trigger mode to **Auto**, **Normal**, or **SINGLE**.
- : Press this key to generate a trigger signal forcibly.
- **Trigger**  **LEVEL**: modifies the trigger level/threshold level. Turn it clockwise to increase the level, and turn it counterclockwise to decrease the level. During the modification, the trigger level line would move up and down and the trigger level/threshold level value at the upper-right corner of the screen would change accordingly. Press down the knob to quickly set the trigger level to 50% of the waveform peak-peak value.

4.6.5 Clear



Press this key to clear all the waveforms on the screen. If the oscilloscope is in the "RUN" state, new waveforms will continue being displayed.

4.6.6 Auto



Press this key to enable the waveform auto setting function. The oscilloscope will automatically adjust the vertical scale, horizontal time base, and trigger mode according to the input signal to realize optimal waveform display.

4.6.7 RUN/STOP



Press this key to set the operating state of the oscilloscope to "RUN" or "STOP". In the "RUN" state, the key is illuminated in yellow. In the "STOP" state, the key is illuminated in red.

4.6.8 Single



Press this key to set the trigger mode to "Single".

4.6.9 Multifunction knob



- **Non-menu Operation:**

In non-menu-operation mode, rotate this knob to adjust the brightness of waveform display. The settable screen brightness ranges from 1% to 100%. Turn it clockwise to increase the brightness, and turn it counterclockwise to decrease the brightness. Press  > **Intensity** to adjust the waveform brightness. You can also use the knob to adjust it.

- **Menu Operation:**

When you operate on the menu, the backlight of the knob is illuminated. For the menu item that has multiple parameters under it, when you press the menu softkey, rotate the knob to select the parameter item, then press down the knob to select the item (sometimes, the specified parameter item can be selected by rotating the knob). The knob can also be used to modify parameters, input filenames, etc.

4.6.10 Function Menu

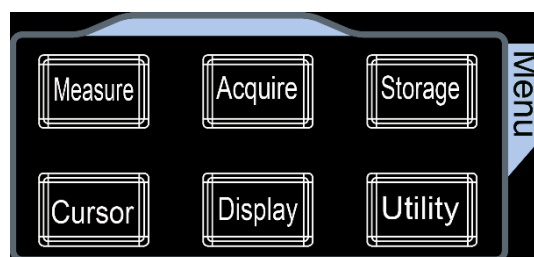



: Press this key to enter the measurement setting menu. You can set the measurement source, enable or disable the all measurement function, the statistical analysis function, and etc. You can make a quick measurement for 41 waveform parameters.

: Press this key to enter the acquisition setting menu. You can set the time base mode, the acquisition mode, memory depth, and etc.

: Press this key to enter the file or waveform storage and load interface. The file types for storage include image, waveform, and setups. Besides, waveform load and setup load are supported. The disk management and file auto naming function are also supported in this menu.

: Press this key to enter the cursor measurement menu. The oscilloscope provides four cursor modes: Manual, Track, XY, and Measure. Note that XY cursor mode is only available when the horizontal time base is set to "XY".

: Press this key to enter the Display setting menu. You can set the display type, persistence time, wave intensity, and etc.

: Press this key to enter the system function setting menu. You can set system-related functions or parameters, such as I/O, sound, language, and etc. Besides, some advanced functions (such as the pass/fail test, waveform recording, and self-calibration) are also supported.

4.6.11 Touch Lock Key



Press this key to disable the touch screen function.

NOTE

By default, the touch screen function of the oscilloscope is always enabled. If you disable the function, press the key again to enable it.

4.6.12 Quick key (shortcut key)



Press this key to perform the quick operation, including screenshot, waveform saving, setup saving, all measurement, statistics reset, and etc.

Press  > **More** > **Quick settings** to set the quick shortcut keys.

4.7 User Interface

MSO8000A series has a 10.1-inch WSVGA (1024×600) LCD, with 256 level gray-scale display. The user interface displays the acquired waveforms, the setting information, and the measurement results.

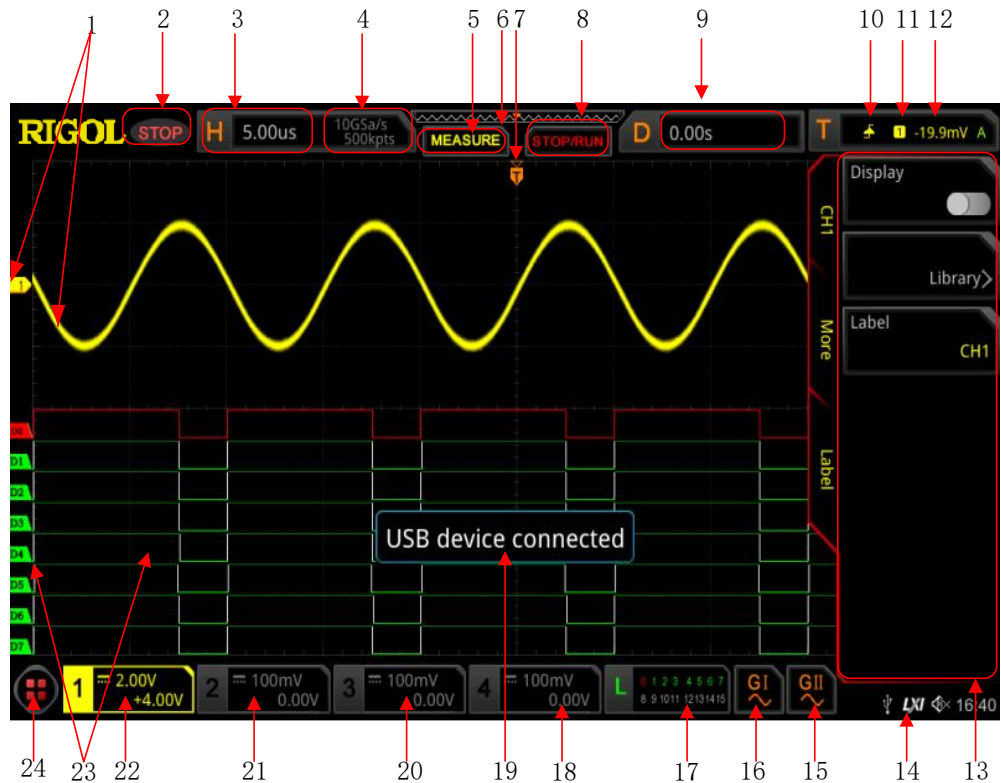

Figure 4.15 User Interface

1. Analog Channel Label/Waveform

Different channels are marked with different colors. The color of the channel label is the same as that of the waveform.

2. Operating Status

The available states include RUN, STOP, T'D (triggered), WAIT, and AUTO.

3. Horizontal Time Base

- Represents the time length per grid in the horizontal axis of the screen.
- Use **Horizontal**  **SCALE** to modify this parameter. The adjustable range of the horizontal time base is different for different models.

4. Sample Rate/Memory Depth

- Displays the current sample rate and memory depth of the analog channel.

- The sample rate and the memory depth will change along with the horizontal time base.

5. Auto Measurement Label

Enable the touch screen, and then tap the label. Up to 41 waveform parameters are available for auto measurement. It also offers full-memory hardware measurement function.

6. Save Wave

Provides a diagram of the position of the screen waveform in the memory.

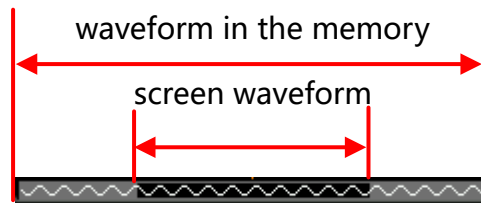

7. Trigger Position

Displays the trigger position of the screen waveform and that of the waveform in the memory.

8. Run/Stop Label

In the run state, the label is displayed in green; while in the stop state, it is displayed in red. You can enable the touch screen to tap the icon "STOP/RUN" to control its operating status.

9. Horizontal Position

Use **Horizontal**  **POSITION** to modify this parameter. Press down this knob to quickly reset the horizontal position.



10. Trigger Type

Displays the currently selected trigger type and trigger condition setting. When you select different trigger types, different labels are displayed. For example,  represents triggering on the rising edge in "Edge" trigger.

11. Source

Displays the currently selected trigger source (CH1-CH4, AC Line, EXT, or D0-D15). When you select different trigger sources, different labels are displayed. For example,  denotes that CH1 is selected as the trigger source.

12. Trigger LEVEL/Threshold Level





- When CH1-CH4 or EXT is selected as the trigger source, you need to set a proper trigger level.
- When D0-D15 is selected as the trigger source, you need to set a proper threshold level.
- The trigger level label  is displayed at the left section of the screen, and the trigger level/threshold level value is displayed at the upper-right corner of the screen.
- When you use **Trigger**  LEVEL to modify the trigger level/threshold level, the trigger level/threshold level value will change with the up and down of .

13. Operation Menu

Press any softkey on the front panel to activate the corresponding menu.

14. Notification Area

Displays the beeper icon, the USB storage device icon, time, and the LAN connection icon.

- Sound icon: Press  > **Sound** to turn on or off the sound. When the sound is turned on,  will be displayed; when off,  will be displayed.
- USB storage device icon: When a USB storage device is detected,  will be displayed.
- Time: displays the system time. For the system time setting, refer to descriptions in "*System Time*".
- LAN connection icon: When the LAN interface is successfully connected,  will be displayed.

15. AWG 2

- Displays the on/off status of AWG 2.
- Displays the waveform type set for the current AWG 2.
- It is only available for the model installed with the MSO8000-AWG option.



16. AWG 1

- Displays the on/off status of AWG 1.
- Displays the waveform type set for the current AWG 1.
- It is only available for the model installed with the MSO8000-AWG option.

17. Digital Channel Status Area

Displays the current status of the 16 digital channels. The digital channels currently turned on are displayed in green, and the currently selected digital channel is highlighted in red. The digital channels turned off are displayed in gray.



18. CH4 Status Label

- Displays the status of CH4.
- It displays the vertical scale of CH4. That is, the voltage value per grid of CH4 in the vertical axis.
- Displays the offset of CH4, i.g. the vertical offset of CH4 waveform.
- Different labels will be displayed according to the current channel setting. For example, if you select "DC" for channel coupling,  is displayed; if you enable the bandwidth limit,  is displayed; if you select "50 Ω" for impedance,  is displayed.



19. Message Box

Displays the prompt messages.



20. CH3 Status Label

- Displays the status of CH3.
- Displays the vertical scale of CH3. That is, the voltage value per grid of CH3 in the vertical axis.
- Displays the offset of CH3, i.g. the vertical offset of CH3 waveform.
- Different labels will be displayed according to the current channel setting. For example, if you select "DC" for channel coupling,  is displayed; if you enable the bandwidth limit,  is displayed; if you select "50 Ω" for impedance,  is displayed.

21. CH2 Status Label

- Displays the status of CH2.
- Displays the vertical scale of CH2. That is, the voltage value per grid of CH2 in the vertical axis. Displays the offset of CH2, i.g. the vertical offset of CH2 waveform.
- Different labels will be displayed according to the current channel setting. For example, if you select "DC" for channel coupling,  is displayed; if you enable the bandwidth limit,  is displayed; if you select "50 Ω" for impedance,  is displayed.

22. CH1 Status Label

- Displays the on/off status of CH1.
- Displays the vertical scale of CH1. That is, the voltage value per grid of CH1 in the vertical axis.
- Displays the offset of CH1, i.g. the vertical offset of CH1 waveform.
- Different labels will be displayed according to the current channel setting. For example, if you select "DC" for channel coupling,  is displayed; if you enable the bandwidth limit,  is displayed; if you select "50 Ω" for impedance,  is displayed.



23. Digital Channel Label/Waveform

The logic high and low level of the digital waveform are displayed in green. Its edge is displayed in white. The color of the currently selected waveform of the digital channel is consistent with that of the channel label, being displayed in red. The grouping setting function under the logic analyzer function menu can divide the digital channels into 4 channel groups. The channel label of the same channel group is displayed in the same color; different channel groups are marked with different colors.

24. Function Navigation

Enable the touch screen and then tap this icon to enable the function navigation.

**NOTE**

In Slope Trigger, Runt Trigger, and Window trigger, you need to set the upper and lower limits of the trigger level, and two trigger level labels ( and ) are displayed.

4.8 Touch Screen Controls

MSO8000A series provides a 10.1-inch super large capacitive touch screen, which supports multi-touch and gesture operation. It has strong waveform display capability and excellent user experience. It features great convenience, high flexibility, and great sensitivity. The actions supported by the touch screen controls include tapping, pinching & stretching, dragging, and rectangle drawing.

**TIP**

The touch screen function is available for all the menus displayed on the screen and the buttons enabled. In this manual, key operation descriptions are illustrated in details, and as for the touch screen function about some operations, refer to descriptions in relevant chapters.

4.8.1 Tap

Use one finger to touch the symbol or characters on the screen slightly, as shown in [Figure 4.16](#). With the Tap gesture, you can perform the following operation:

- Tap the menu displayed on the screen to operate on the menu.
- Tap the function navigation icon  at the lower-left corner of the touch screen to open the function navigation.
- Tap the displayed numeric keypad to set the parameters.
- Tap the virtual keypad to set the label name and the filename.
- Tap the close button at the upper-right corner of the message box to close the prompt window.
- Tap other windows on the touch screen and operate on the windows.



Figure 4.16 Tap Gesture

4.8.2 Pinch & Stretch

Pinch or stretch two points on the screen with two fingers to zoom in or out the waveform. To zoom in the waveform, first pinch the two fingers and then stretch the fingers; to zoom out the waveform, first stretch the two fingers, and then pinch the fingers together, as shown in *Figure 4.17*. With the pinch&stretch gesture, you can perform the following operation:

- Pinching&stretching in the horizontal direction can adjust the horizontal time base of the waveform.
- Pinching&stretching in the vertical direction can adjust the vertical scale of the waveform.



Figure 4.17 Pinch & Stretch Gesture

4.8.3 Drag

Use one finger to select the object, and then drag the object to a destination place, as shown in *Figure 4.18*. With the drag gesture, you can perform the following operation:

- Drag the waveform to change its position or scale.
- Drag the window controls to change the position of the window (e.g. numeric keypad).
- Drag the marker to change the position of the marker.



Figure 4.18 Drag Gesture

4.8.4 Rectangle Drawing

Enable the function navigation, and then tap the "Draw rect" icon to switch to the rectangle drawing mode. Drag a finger from upper left to lower right across the screen to draw a rectangle on the screen, as shown in [Figure 4.19](#). Move your finger away from the screen, and then a menu is displayed on the screen. At this time, you can tap to select "Trigger zone A", "Trigger zone B", "Histogram", "Horizontal zoom in", "Vertical zoom in", or "Waveform zoom in". Drag a finger from lower right to upper left across the screen to draw a rectangle on the screen, as shown in [Figure 4.20](#). Move your finger away from the screen, and then a menu is displayed on the screen. At this time, you can tap to select "Trigger zone A", "Trigger zone B", "Histogram", "Horizontal zoom out", "Vertical zoom out", or "Waveform zoom out".

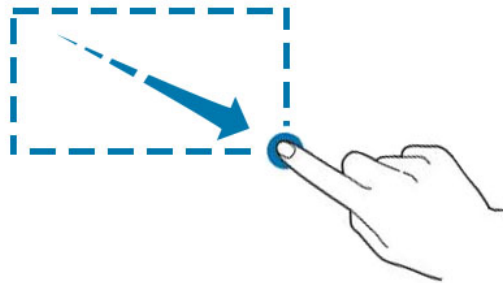

Figure 4.19 Rectangle Drawing Gesture(a)

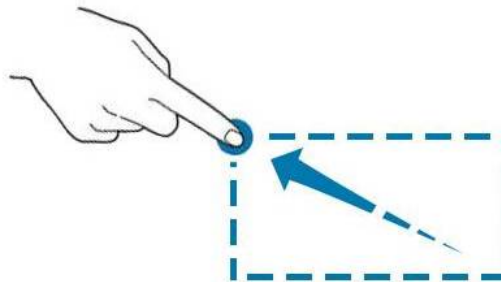



Figure 4.20 Rectangle Drawing Gesture(b)

- Select "Trigger zone A":
 - Draw the region for Trigger zone A;
 - Open Trigger zone A;
 - Open the "Zone Trigger" menu.
- Select "Trigger zone B":

- Draw the region for Trigger zone B;
- Open Trigger zone B:
- Open the "Zone Trigger" menu.
- Select "Histogram":
 - Draw the region for the histogram;
 - Open the "Histogram" menu.
- Select "Horizontal zoom in": expands the waveforms in the horizontal direction. Select "Horizontal zoom out": compresses the waveforms in the horizontal direction.
- Select "Vertical zoom in": expands the waveforms in the vertical direction. Select "Vertical zoom out": compresses the waveforms in the vertical direction.
- Select "Waveform zoom in": expands the waveforms both in the horizontal and vertical direction. Select "Waveform zoom out": compresses the waveforms both in the horizontal and vertical direction.

**TIP**



Tap the "Draw rect" icon to switch between the rectangle drawing and waveform operation modes.

Tap the "Draw rect" icon, if  is displayed, it indicates that the rectangle drawing mode is enabled. Tap the "Draw rect" icon, if  is displayed, it indicates that the waveform operation mode is enabled. By default, the waveform operation mode is enabled.



4.9 Parameter Setting Method

You can use the knob or enable the touch screen to set the parameters of MSO8000A series. The common parameter setting methods are as follows:



Method 1:

For the parameters with the sign , rotate the multifunction knob  on the front panel directly to select the parameter item or modify the parameter value.

Method 2:

For the parameters with the sign , rotate the multifunction knob  on the front panel and then press it down to select the parameter item or modify the parameter value.

Method 3:

For the parameters with  displayed on the menu, rotate the multifunction knob  on the front panel directly to set the parameter, or press down the multifunction knob  or the specified menu softkey, and then the numeric keypad is shown in *Figure 4.21* below.

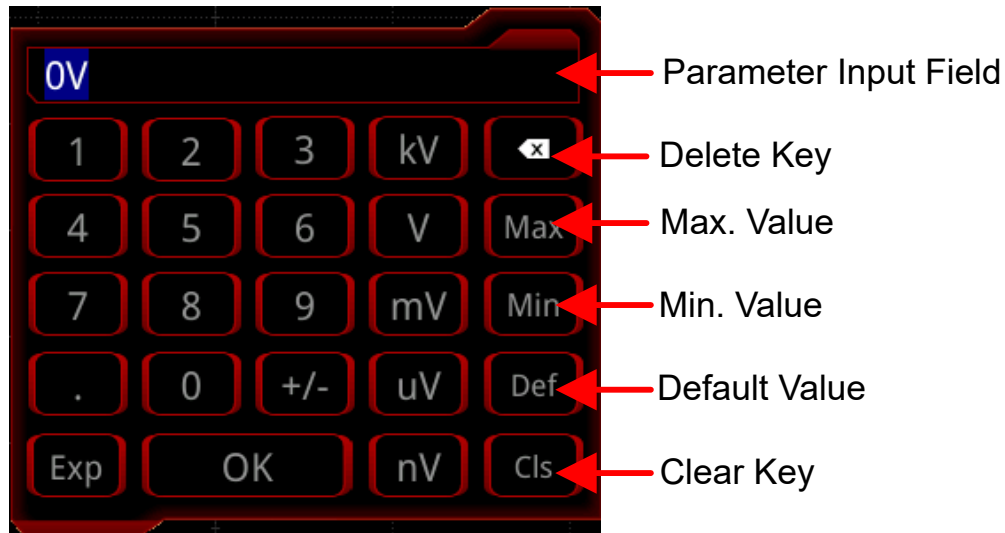



Figure 4.21 Numeric Keypad

In the numeric keypad, rotate the multifunction knob  to select the parameter, then press down the knob to select it. Then input the value or the unit. You can also enable the touch screen and tap the value or unit in the numeric keypad to input them. After you input all the values and select the desired units, the numeric keypad is turned off automatically. This indicates that you have completed parameter setting. Besides, after you have input the values, you can also press OK directly to confirm the input and close the numeric keypad. At this time, the unit of the parameter is the default unit. In the numeric keypad, you can also perform the following operations:

- Delete the parameter value that has been input.
- Set the parameter to a maximum or minimum value (sometimes, the maximum or minimum value are the specified one for the current state).
- Set the parameter to a default value.
- Clear the parameter input field.

Method 4:

For the parameters without the above signs, press the desired menu softkey to switch between the parameter items. This method is applicable to the parameters with only two available options.

**TIP**

The above method is commonly used for the parameter settings of the oscilloscope. For other methods of parameter settings, refer to details in User Guide of this instrument.

4.10 To Use the Security Lock

If necessary, you can lock the instrument to a fixed location by using the security lock (please purchase it by yourself), as shown in *Figure 4.22*.

The method is as follows: align the lock with the lock hole and plug it into the lock hole vertically, turn the key clockwise to lock the oscilloscope, and then pull the key out.

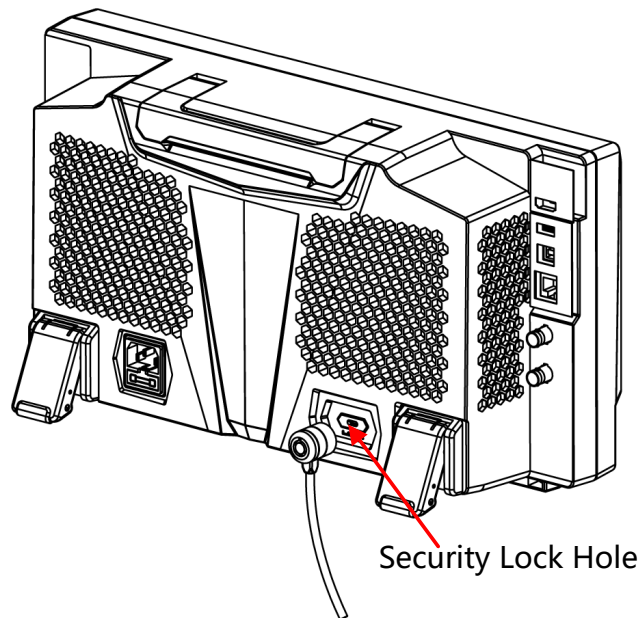



Figure 4.22 To Use the Security Lock

**NOTE**

Please do not insert other objects into the security lock hole to avoid damaging the instrument.

4.11 To Use the Built-in Help System

The help system of this oscilloscope provides instructions for all the function keys on the front panel and their corresponding menu keys. The steps for opening the built-in help system are as follows:

1. Press  > **System** > **Help**, and then the "Help" menu is displayed on the screen. You can also use the touch screen function, tap the navigation icon  at the lower-left corner of the touch screen to enable the function navigation. Tap the "Help" icon, and then the "Help" menu is displayed on the screen.
2. Press the **Content** menu key or tap the "Content" menu item, then the help information is displayed on the screen, as shown in *Figure 4.23*. The help interface mainly consists of two sections. The left section lists "Help Options", and the right section is the "Help Display Area".

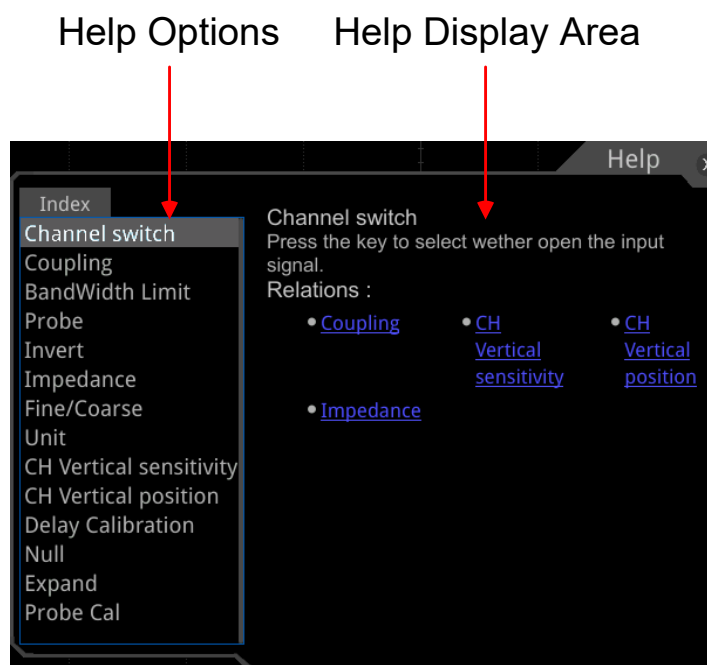







Figure 4.23 Help Information

After opening the help interface, you can get its help information in the "Help Display Area" through the following three methods:

Method 1:

For the key operation, you can directly press the front-panel keys (except the Power key,  key, and the  key) to obtain the help information. For the knob operation, you can rotate the knob or press down the knob to get the help information (except the multifunction knob , **Wave Vertical**  **POSITION**, and **Wave Vertical**  **SCALE**). As the function of rotating the knob is different from that of pressing down the knob, these two operations will give you different help information.





Method 2:

In the "Help Options", rotate the multifunction knob  to switch among the help options to get the corresponding help information.

Method 3:

Enable the touch screen and tap the desired help option to get the corresponding help information.

TIP



- Help information for other keys and buttons:
 - Power key: powers on/off the instrument.
 -  key: displays or hides menus. Pressing this key can hide the menus.
 -  key: returns to the previous menu or last set function menu.
 - Multifunction knob : In non-menu-operation mode, rotate this knob to adjust the brightness of waveform display. When you operate on the menu, the backlight of the knob is illuminated. For the menu item that has multiple parameters under it, when you press the menu softkey, rotate the knob to select the parameter item, then press down the knob to select it (sometimes, the specified parameter item can be selected by rotating the knob). The knob can also be used to modify parameters, input the filename, etc.
 - **Wave Vertical**  **POSITION**: Rotate the knob to adjust the vertical position of the current digital channel waveform, the vertical position of the math operation waveform, the vertical position of the reference waveform, or the vertical display position of the bus decoding.
 - **Wave Vertical**  **SCALE**: Rotate the knob to adjust the vertical scale of math operation waveform or the vertical scale of the reference waveform, and also can adjust the size of the displayed digital channel waveforms.
- If the menu item is grayed out, you cannot press the corresponding front-panel menu key to obtain the help information. What you can do is only to follow the above Method 2 or 3 to get the help information.

4.12 To View the Option Information and the Option Installation

This series of oscilloscope provides multiple options to fulfill your measurement requirements. If you need any of these options, order them according to the Order No. available in "*Appendix A: Options and Accessories*", and then install the options according to this section. Besides, you can also view the options currently installed on the oscilloscope or activate the newly purchased option.

1. View the Installed Option

The instrument is installed with the trial versions of the options before leaving factory. When you power on the instrument for the first time, the trial time is about 2,160 minutes. If your instrument has currently installed the option, perform the following operations to view the name of the installed option and other detailed information about the option from the option list.

- a. Press  > **System** > **Help**, and then the "Help" menu is displayed on the screen. You can also use the touch screen function, tap the navigation icon  at the lower-left corner of the touch screen to enable the function navigation. Tap the "Help" icon, and then the "Help" menu is displayed on the screen.
- b. Press the **Option list** or tap the **Option list** menu item, and then a list of the options installed is displayed on the screen for users to view.

2. Install the option

The option license is a string of fixed characters. Each instrument has one unique license. The license file should be in specific format, with the filename extension ".lic". After you purchase an option, you will obtain a key (used for obtaining the license). Then, you can install the option according to the following steps.

a. Obtain an option license

- a. Log in to the RIGOL official website (www.rigol.com), click **SERVICE CENTRE** (Products & Services) > **License Activation** to enter the license activation interface.
- b. In the software license registration interface, input the correct key, serial number (press  > **System** > **About** to obtain the serial number of the instrument. You can also open the "Help" function menu, and then press **About** to obtain the serial number), and the verification code. Click **Generate** to obtain the download link of the option license file. If you need to use the option license file, please click the link to download the file to the root directory of the USB storage device.

b. Install the option

- a. Confirm that the option license file is located in the root directory of the USB storage device, and connect the USB storage device to the oscilloscope properly.
- b. The **Option install** key is activated, and press this menu key to start installing the option.
- c. After installation, a prompt message "Option activated successfully" is displayed.

NOTE

After the option has been installed, you are recommended to restart the instrument.

**TIP**

- Only 1 option license file of one instrument is allowed to be stored in the same USB storage device, but the USB storage device can store the option license file of several different instruments. You are not allowed to modify the licensed filename.
- During the installation process, you are not allowed to power off the instrument or pull out the USB storage device.
- Sending the SCPI commands (:SYSTEM:OPTion:INSTall <license>) to install options is supported. Installing options by inputting the license code manually is not supported.

5 To Set the Vertical System

MSO8000A series provides 4 analog input channels (CH1-CH4). Each channel is equipped with an independent vertical control system. The setting methods for the vertical systems of the 4 channels are the same. This chapter takes CH1 as an example to introduce the setting method for the vertical system. By default, only CH1 is enabled.

5.1 To Enable or Disable the Analog Channel

Enable the Analog Channel:

Connect a signal to CH1, and then press  in the vertical control area (Vertical) on the front panel to enable CH1. Then, the backlight of the channel is illuminated. At this point, the channel setting menu is displayed at the right section of the screen and the channel is activated. The channel status label at the bottom of the screen is shown in the figure below. You can also enable the touch screen to tap the channel status label to enable the channel.



The information displayed in the channel status label is related to the current channel setting (irrelevant with the on/off status of the channel). After the channel is turned on, modify the parameters such as the vertical scale, horizontal time base, trigger mode, and trigger level according to the input signal for easy observation and measurement of the waveform.

If CH1 is enabled but not activated, the channel status label is shown in the following figure. To activate the channel, press  on the front panel in the vertical control area (Vertical) or enable the touch screen to tap the waveform activation channel displayed on the screen.

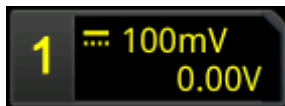

Disable the Analog Channel:

If the setting menu of the channel that needs to be disabled (the current channel is activated) is displayed at the right section of the screen, press the channel key to disable the channel. If the setting menu of the channel that needs to be disabled is not displayed at the right section of the screen, first open the setting menu of the channel to be disabled (activate the channel), then press the channel key to disable the channel. You can also enable the touch screen to tap the channel status label to

disable the channel. For example, if CH1 and CH2 are enabled and CH2 channel setting menu is displayed on the screen, then if you need to disable CH1, first activate CH1, and then press  or enable the touch screen to tap CH1 channel status label to disable CH1. If CH1 is disabled, the channel status label is shown in the following figure.



5.2 To Adjust the Vertical Scale

Vertical scale indicates the voltage value per grid in the vertical axis of the screen. It is often expressed in V/div. While you adjust the vertical scale, the display amplitude of the waveform would enlarge or reduce. The scale information of the channel status label (e.g. as shown in the following figure) at the lower section of the screen would change accordingly.





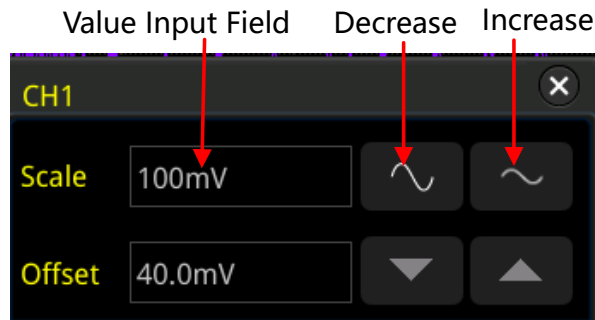

The adjustable range of the vertical scale is related to the currently set probe ratio and input impedance. By default, the probe ratio is 1X and the input impedance is 1 MΩ. In this case, the adjustable range of the vertical scale is from 1 mV/div to 10 V/div.

When CH1 is turned on, you can adjust the vertical scale with the following three methods:

- Rotate **Vertical**  **SCALE** that corresponds to CH1 to adjust the vertical scale (clockwise to reduce the scale and counterclockwise to increase).
- Enable the touch screen function, and then adjust the vertical scale with the pinch & stretch gesture on the touch screen. For details, refer to the "*Pinch & Stretch*" section.
- Enable the touch screen function, and tap the channel status label at the bottom of the screen. The following window is displayed. Tap the icon at the right side of the Scale input field to decrease or increase the scale. You can also tap the input field to input a specific value with the displayed numeric keypad.



In the vertical control area (Vertical) on the front panel, press **Vertical**  **SCALE** to adjust the vertical scale in "Coarse" (by default) or "Fine" mode. You can also press  **> More > Fine** to enable or disable the fine adjustment.

- Fine adjustment: Rotate **Vertical**  **SCALE** to further adjust the vertical scale within a relatively smaller range to improve the vertical resolution. If the amplitude of the input waveform is a little bit greater than the full scale under the current scale and the amplitude would be a little bit lower if the next scale is used, fine adjustment can be used to improve the amplitude of waveform display to view signal details.
- Coarse adjustment (take counterclockwise as an example): Rotate **Vertical**  **SCALE** to set the vertical scale at 1-2-5 step, i.e. 1 mV/div, 2 mV/div, 5 mV/div, 10 mV/div...10 V/div.

5.3 Vertical Expansion

When changing the vertical scale of the analog channel by rotating the **Vertical**  **SCALE**, you can select to expand or compress the waveform around the "Center" or "GND" (Ground). By default, "GND" is selected under Expand.

Press  **> More**, then press **Expand** continuously to select "Center" or "GND".

- Center: when the vertical scale is changed, the waveform will be expanded or compressed around the screen center.
- GND: when the vertical scale is changed, the waveform will be expanded or compressed around the signal ground level position.





5.4 To Adjust the Vertical Offset

Vertical offset indicates the offset of the signal ground level position of the waveform from the screen center in the vertical direction. Its unit is consistent with the currently selected amplitude unit (refer to "*Amplitude Unit*"). When adjusting the vertical offset, the waveforms of the corresponding channel moves up and down. The vertical offset information (as shown in the following figure) in the channel status label at the bottom of the screen will change accordingly.



The adjustable range of the vertical offset is related to the current input impedance, probe ratio, and vertical scale.

When CH1 is turned on, you can adjust the vertical offset with the following four methods:

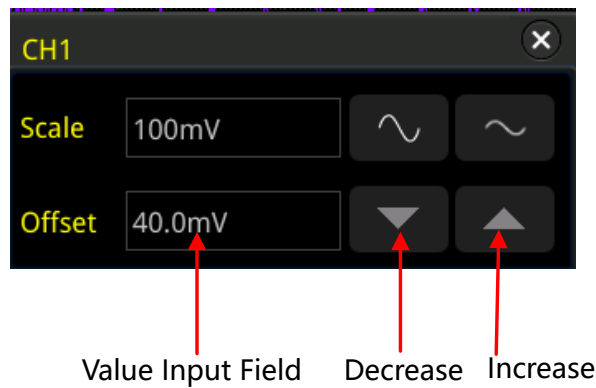

- Rotate **Vertical**  **OFFSET** that corresponds to CH1 to adjust the vertical offset within the adjustable range. Rotate this knob clockwise to increase the vertical offset, and rotate it counterclockwise to reduce the vertical offset. Pressing down the knob can quickly reset the vertical offset (set the vertical offset to 0).
- Menu setting: Press  > **More** > **Offset**, and then the numeric keypad is displayed. Input the offset value with the numeric keypad.
- Enable the touch screen function, and then adjust the vertical offset with the drag gesture. For details, refer to the "*Drag*" section.
- Enable the touch screen function, and tap the channel status label at the bottom of the screen. The following window is displayed. Tap the   icon at the right side of the Offset input field to decrease or increase the offset. You can also tap the input field to input a specific value with the displayed numeric keypad.



5.5 Channel Coupling

The undesired signals can be filtered out by setting the coupling mode. For example, the signal under test is a square waveform with DC offset.

- When the coupling mode is "DC": the DC and AC components of the signal under test can both pass the channel.
- When the coupling mode is "AC": the DC components of the signal under test are blocked.
- When the coupling mode is "GND": the DC and AC components of the signal under test are both blocked.

Press  to open the CH1 setting menu. Then, press **Coupling** continuously or rotate the multifunction knob  to select the desired coupling mode (by default, it is DC). The current coupling mode is displayed in the channel status label at the bottom of the screen, as shown in the figure below. You can also enable the touch screen, and then touch the CH1 setting menu to select the desired coupling mode.



DC



AC

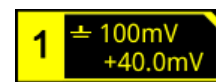

GND



NOTE

- When the input impedance is set to "50 Ω", the channel coupling is set to DC coupling by force, and the **Coupling** menu is grayed out and cannot be modified.
- When the coupling mode is "AC", the input impedance is set to 1 MΩ by force, and the **Impedance** menu is grayed out and cannot be modified.

5.6 BW Limit

This series oscilloscope supports the bandwidth limit function. Setting the bandwidth limit can reduce the noises in the displayed waveforms. For example, the signal under test is a pulse with high frequency oscillation.

- When the bandwidth limit is disabled, the high frequency components of the signal under test can pass the channel.
- When you enable the bandwidth limit and limit it to 20 MHz or 250 MHz, the high frequency components found in the signal under test that are greater than 20 MHz or 250 MHz are attenuated.

Press  to open the CH1 setting menu. Then, press **BW Limit** continuously or rotate the multifunction knob  to select the desired bandwidth limit. Press down the knob to select it. By default, it is OFF. When the bandwidth limit is enabled, the character "B" will be displayed in the channel status label at the bottom of the screen. You can also enable the touch screen to select the desired BW limit.



The bandwidth limit that you select is based on the input impedance of the oscilloscope, as shown in [Table 5.2 BW Limit](#).

Table 5.2 BW Limit

Input Impedance of the Oscilloscope	Available Bandwidth Limit
50 Ω	20 M
1 M Ω	20 MHz and 250 MHz

NOTE

Bandwidth limit can not only reduce the noise, but also can attenuate or eliminate the high frequency components of the signal.

5.7 Probe Ratio

This series oscilloscope allows you to set the probe attenuation manually. To obtain the correct measurement results, you must set the probe ratio properly. By default, the probe ratio is 1X.



Press  to open the CH1 setting menu. Then, press **Attenuation** continuously or rotate the multifunction knob  to select the desired probe ratio. You can also enable the touch screen, and then tap to select the desired probe ratio. The probe ratio values available are as shown in the following table.

Table 5.3 Probe Ratio

Menu	Attenuation (display amplitude of the signal under test: actual amplitude of the signal under test)
0.0001X	0.0001:1
0.0002X	0.0002:1
0.0005X	0.0005:1
0.001X	0.001:1
0.002X	0.002:1
0.005X	0.005:1
0.01X	0.01:1
0.02X	0.02:1
0.05X	0.05:1
0.1X	0.1:1
0.2X	0.2:1
0.5X	0.5:1
1X (default)	1:1
2X	2:1
5X	5:1
10X	10:1
20X	20:1
50X	50:1
100X	100:1
200X	200:1
500X	500:1
1000X	1000:1
2000X	2000:1

Menu	Attenuation (display amplitude of the signal under test: actual amplitude of the signal under test)
5000X	5000:1
10000X	10000:1
20000X	20000:1
50000X	50000:1

NOTE



After the oscilloscope auto-recognized certain probes with a fixed attenuation ratio, the probe ratio will also be auto recognized. You do not have to set it manually.



5.8 Input Impedance

To reduce the circuit load between the oscilloscope and the circuit under test, this oscilloscope provides two input impedance modes: 1 M Ω (default) and 50 Ω .

- 1 M Ω : The input impedance of the oscilloscope is very high, and the current flowed from the circuit under test can be ignored.
- 50 Ω : makes the oscilloscope match with the device whose input impedance is 50 Ω .

Press  to open the CH1 setting menu. Then, press **Impedance** continuously to select the input impedance of the oscilloscope. If you select "50 Ω ", the channel status label at the bottom of the screen will display the icon .

NOTE

- After the oscilloscope recognizes the probe automatically, the input impedance will also be auto recognized. You do not have to set it manually.
- The setting of the input impedance will affect the ranges of channel vertical scale and offset.



5.9 Waveform Invert

Press  to open the CH1 setting menu. Then, press **Invert** continuously to enable or disable the waveform invert. When enabled, the channel label is displayed, as shown in the following figure.



When the waveform invert is turned off, the waveform is displayed normally; when the waveform invert is turned on, the voltage values of the displayed waveform are inverted. Enabling the waveform invert will change the result of math function and waveform measurement.

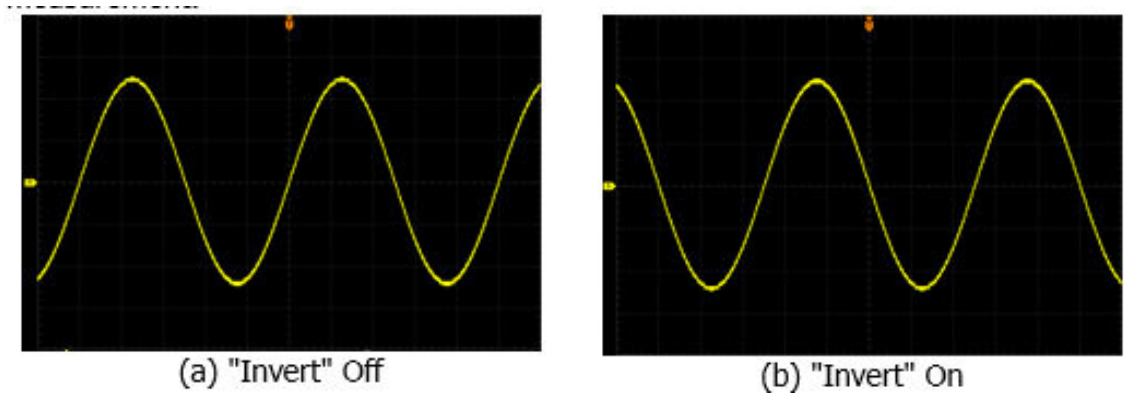

Figure 5.1 Waveform Invert



NOTE

When the waveform invert is enabled, the trigger edge or the trigger polarity will change (e.g. Edge trigger, Pulse trigger, or Slope trigger).

5.10 To Set the Probe

The analog channel of this oscilloscope not only supports the common passive probe, but also the active probe. It can automatically recognize the currently connected probe type and its probe ratio. For detailed technical information of the probes, please refer to the corresponding Probe User Guide.

Press **1** to open the CH1 setting menu. Then, press **Probe** to open the probe menu. If different probes are connected to the oscilloscope, different information about the probe will be displayed, and you can perform the different operations on the menu.

5.10.1 Passive Probe

If a passive probe is connected, for example, when RIGOL RP3500A probe model is connected to the oscilloscope, press **Probe** to open the probe menu. Its sub-menus are grayed out and disabled.



TIP

For some of the ordinary passive probes, the oscilloscope can recognize their probe ratio automatically. If not recognized, please refer to "*Probe Ratio*" to set the probe ratio.

5.10.2 Active Probe

If an active probe is connected, for example, when RIGOL RP7150 probe model is connected to the oscilloscope, press **Probe** to open the probe menu, then operate on the menu item.



TIP

- When a 50 Ω active probe is connected, the input impedance (refer to "*Input Impedance*") of the channel will be automatically set to "50 Ω ".
- For the active probe, the oscilloscope can recognize the probe ratio automatically. If the currently connected probe supports a variety of probe ratios, please refer to *Probe Ratio* to set the probe ratio.

Probe Delay

To avoid measurement result errors arising from the transmission delay of the probe cable, the oscilloscope provides the probe delay adjustment function for the active probe. Press **Skew**, then rotate the multifunction knob  or use the pop-up numeric keypad to set the probe delay.

Bias Voltage

The oscilloscope provides the bias voltage adjustment function for active probes. This function is used to adjust the signal under test that exceeds the input dynamic range of the probe amplifier to an appropriate range to ensure the integrity of the signal under test. Press **Bias**, rotate the multifunction knob  or use the pop-up numeric keypad to set the DC bias voltage.

Probe Information



Press **About** to view information about the probe currently connected, such as the manufacturer, model, serial number, and the last calibration date.

Probe Calibration

Press **Calibration** to start zero calibration automatically for the probe.

5.11 Amplitude Unit

Sets the amplitude display unit for the current channel. The available units are W, A, V, and U. When the amplitude unit is changed, the unit related to the channel will also be changed accordingly.

Press  > **More** > **Unit**, then press **Unit** continuously or rotate the multifunction knob  to select a unit. You can also enable the touch screen to select the desired unit. The default unit is V.

5.12 Channel Delay

When using an oscilloscope for actual measurement, the transmission delay of the probe cable may bring relatively greater errors (zero offset). This series oscilloscope allows you to set a delay time for calibrating the zero offset of the corresponding channel. Zero offset is defined as the offset of the crossing point of the waveform and trigger level line relative to the trigger position, as shown in *Figure 5.2*.

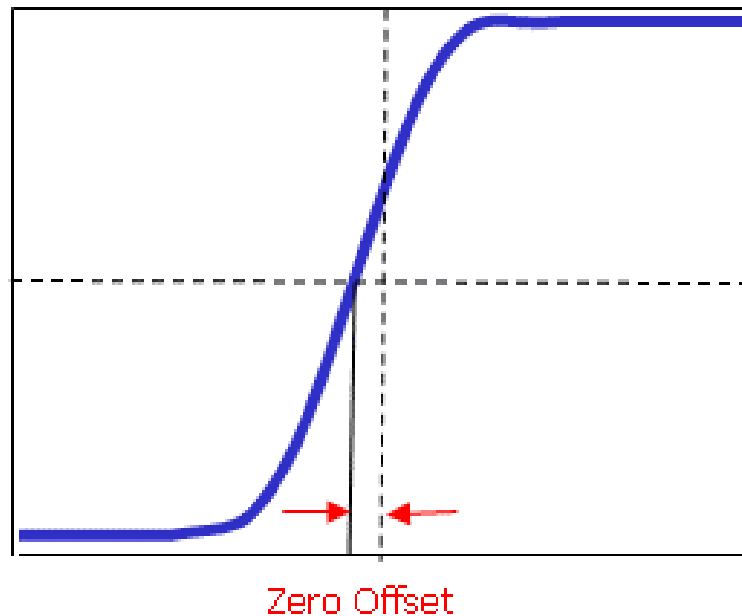

Figure 5.2 Zero Offset

Press **1** > **More** > **CH-CH Skew**, rotate the multifunction knob **↻** or use the numeric keypad to set the desired delay calibration time. The available range of the delay calibration time is from -100 ns to 100 ns.

NOTE

This parameter is related to the instrument model and the current horizontal time base setting. The larger the horizontal time base is, the larger the setting step will be.

5.13 To Set the Bias

When you use an oscilloscope to make actual measurements, a small offset that arises from the temperature drift of the component or external environment disturbance may occur on the zero-cross voltage of the channel, which will affect the measurement results of the vertical parameters. This series oscilloscope allows you to set an offset calibration voltage for calibrating the zero point of the corresponding channel, so as to improve the accuracy of the measurement results.

Press **1** > **More** > **Bias**, rotate the multifunction knob  or use the numeric keypad to set the desired bias voltage.

NOTE

If the zero-cross voltage of the channel has a larger amplitude offset that exceeds the adjustable null range, please perform self-calibration for the instrument to ensure the measurement accuracy. For details, refer to descriptions in "*SelfCal*".



5.14 Channel Label

The instrument uses the channel number to mark the corresponding channel by default. For ease of use, you can also set a label for each channel. For example, "**CH1**".

Press **1** > **More** > **Label** to enter the label setting menu. You can use the built-in label or manually input a label. Three input methods are available for you to input a label name, including Chinese, English, and Traditional Chinese.

The label setting menu includes the following menu items.

- Press **Display** to turn on or off the display of the channel label. If it is enabled, the label will be displayed at the left side of the waveform. When on, CH1 is, by default, displayed to be the channel label.
- Press **Library** to select the preset labels such as CH1, ACK, ADDR, BIT, CLK, CS, DATA, IN, MISO, MOSI, OUT, RX and TX.
- Press **Label**, and the label editing interface is automatically displayed, as shown in *Figure 5.3*. You can input the label manually. For details, refer to descriptions in "*To Create a Folder*".

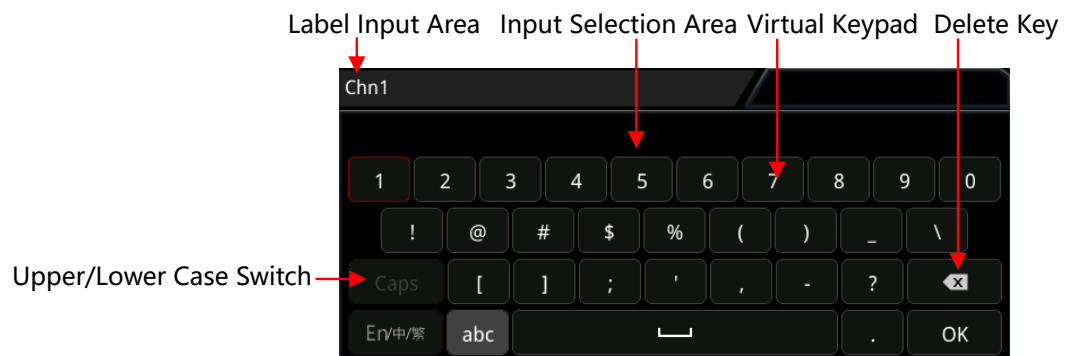



Figure 5.3 Label Editing Interface

For example, set the label to "**Chn1**". In the virtual keypad, tap "Caps" to switch the uppercase or lowercase mode. Input "C", then tap OK to confirm the input. If **Display** is enabled, the label **Chn1** will be displayed at the left side of the CH1 waveform.

To delete or modify the input characters, tap to move the cursor to the right side of the character required to be deleted or modified, and then tap the delete key to delete the character. To modify the characters, input the desired characters again.

The "Input Selection Area" is available for you to select Chinese characters when you choose the Chinese input mode.

- Press **Info**, and the channel information sub-menu is displayed. Rotate the multifunction knob  to select "Bandwidth" or "Bias", and press down the knob to select it. Then the channel label displays the current bandwidth or bias. Both the bandwidth and bias information can also be displayed at the same time in the channel label, as shown in the figure below.

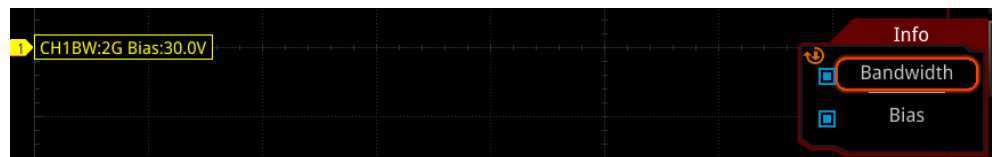

You can also enable the touch screen to drag the channel label to move its position on the screen.

You can run the `:CHANnel<n>:LABel:POSition` command to set the position of the specified channel label;

run the `:CHANnel<n>:LABel:SIZE` command to set the font size of the specified channel label.

6 To Set the Horizontal System

6.1 To Adjust the Horizontal Time Base

Horizontal time base, also called the horizontal scale, refers to the time of each grid in the horizontal direction of the screen. It is usually expressed in s/div. The adjustable range of the horizontal time base is related to the model type.

While you change the horizontal time base, the displayed waveforms of all channels are expanded or compressed (please refer to "[Horizontal Expansion](#)") horizontally relative to the current selected horizontal Expand baseline. The horizontal time base at the upper-left corner of the screen will be changed accordingly, as shown in the figure below.

H 1.00us

You can adjust the horizontal time base with the following three methods:

- Rotate **Horizontal**  **SCALE** to adjust the horizontal time base within the available range (clockwise to reduce the horizontal time base and counterclockwise to increase).
- Enable the touch screen function and adjust the horizontal time base with the pinch & stretch gesture on the touch screen. For details, refer to the "[Pinch & Stretch](#)" section.
- Enable the touch screen function, and tap the Horizontal Scale label **H** 1.00us at the top of the screen. The following window is displayed. Tap the icon at the right side of the **Scale** input field to decrease or increase the horizontal time base. You can also tap the **Scale** input field to input a specific value with the displayed numeric keypad.

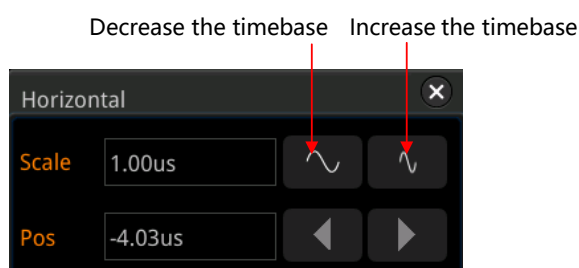

In the Horizontal control area (Horizontal) on the front panel, press the **Horizontal SCALE** knob to switch the adjustment mode between "Coarse" and "Fine" (by default, it is Coarse). You can also press  > **More** > **Fine** to enable or disable the fine adjustment of the horizontal time base.

- Coarse adjustment: Rotate the **Horizontal SCALE** knob will adjust the horizontal time base of the waveforms of all channels at 1-2-5 step within the adjustable range. Rotate it clockwise to reduce the horizontal time base, and counterclockwise to increase the horizontal time base.
- Fine adjustment: Rotate the **Horizontal SCALE** knob will adjust the horizontal time base of the waveforms of all channels with a minor step value within the adjustable range. Rotate it clockwise to reduce the horizontal time base, and counterclockwise to increase the horizontal time base.



NOTE

When the delayed sweep is enabled, rotate the **Horizontal SCALE** knob to adjust the time base for the delayed sweep. The delayed sweep time base displayed in the center of the screen will be changed accordingly, as shown in the following figure.

Zoom:50ns

6.2 To Adjust the Horizontal Position

Horizontal position, also called trigger position, refers to the trigger point position of the waveforms of all channels in the horizontal direction relative to the screen center. When the waveform trigger point is at the left (right) side of the screen center, the horizontal position is a positive (negative) value.

While you change the horizontal position, the waveform trigger points and the displayed waveforms of all channels are moved left and right. The horizontal position at the right-upper corner of the screen changes accordingly, as shown in the figure below.





You can adjust the horizontal Position with the following three methods:

- Rotate **Horizontal POSITION** to adjust the horizontal position of the waveforms of all channels. When you rotate the knob clockwise, the waveform

trigger point moves right on the screen; when rotate it counterclockwise, the waveform trigger point moves left. Press down this knob to quickly reset the horizontal position (the horizontal position is reset to zero).

- Enable the touch screen function, and then adjust the Horizontal Position with the drag gesture. For details, refer to the "*Drag*" section.

- Enable the touch screen function, and tap the Horizontal position label  at the top of the screen. The following window is displayed. Tap the  icon at the right side of the Pos input field to decrease or increase the horizontal position. You can also tap the Pos input field to input a specific value with the displayed numeric keypad.

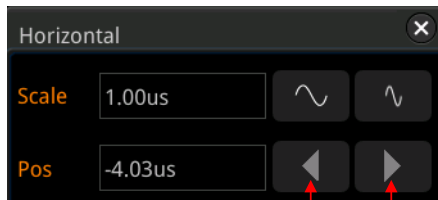

Decrease the position Increase the position





NOTE

When the delayed sweep is enabled, rotate the **Horizontal**  **POSITION** to adjust the horizontal position of the delayed sweep (press down the knob to quickly reset it). The horizontal position of the delayed sweep at the upper-right corner of the screen changes accordingly.

6.3 Delayed Sweep

Delayed sweep can be used to enlarge a length of waveform horizontally to view waveform details.

In the horizontal control area on the front panel, press  to enable or disable the delayed sweep. By default, it is disabled. You can also press  > **More** > **Zoom** to enable or disable the delayed sweep function.

**NOTE**

To enable the delayed sweep, you must ensure that the current time base mode is "YT".

In delayed sweep mode, the screen is divided into two display areas as shown in *Figure 6.1*.

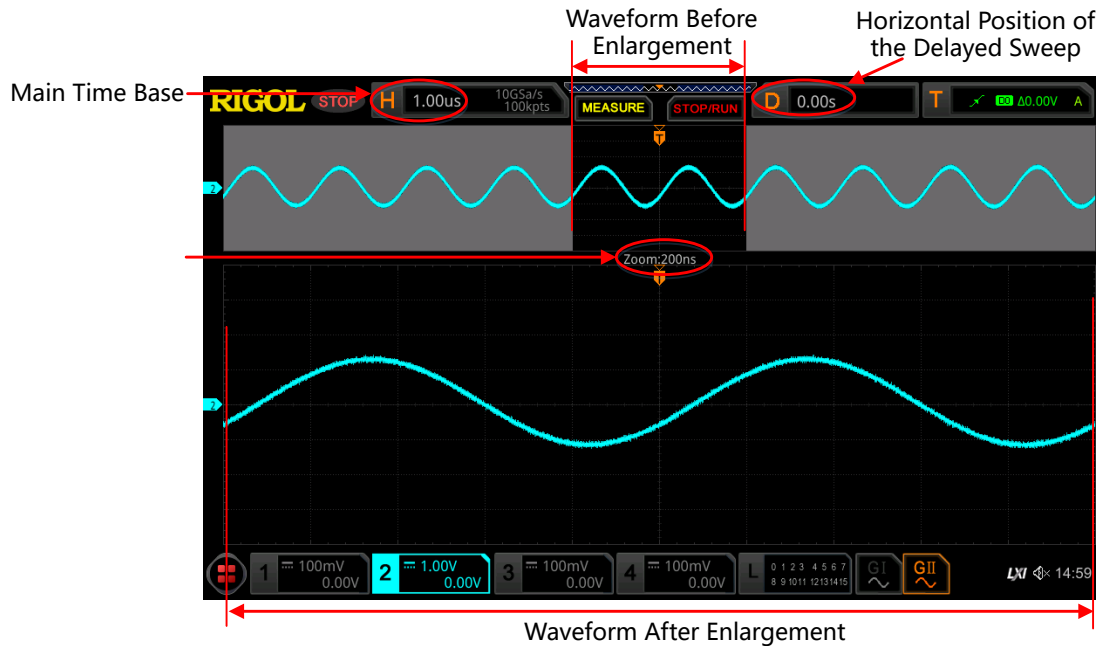





Figure 6.1 Delayed Sweep Mode

Waveform before enlargement:



The waveform in the area that is not covered by subtransparent blue in the upper part of the screen is the waveform before enlargement. Its horizontal time base (also called main time base) is displayed at the upper-left corner of the screen. You can rotate the **Horizontal**  **POSITION** knob to move the area left and right or rotate the **Horizontal**  **SCALE** knob to enlarge or reduce this area.

**NOTE**

If you need to modify the horizontal time base (also called main time base) of the normal sweep, please disable the delayed sweep function first. Rotate the **Horizontal**  **SCALE** knob to set the required main time base, and then enable the delayed sweep function.

Waveform after enlargement:

The waveform in the lower part of the screen is the horizontally expanded delayed sweep waveform. Its horizontal time base (also called the time base of the delayed sweep) is displayed on the screen. Compared with the main time base, the time based of the delayed sweep has increased the waveform resolution. At this time, the

Horizontal  **SCALE** knob is to adjust the time base of the delayed sweep, and the **Horizontal**  **POSITION** knob is to adjust the horizontal position of the delayed sweep.



**NOTE**

The time base of the delayed sweep should be smaller than or equal to the main time base.

7 To Set the Sample System

7.1 Timebase Mode

This series of oscilloscope supports three available time base modes: YT mode, XY mode, and ROLL mode. By default, the time base mode is YT.

Press  > **Timebase Mode** on the front panel, and then rotate the multifunction knob  to select the desired mode. Then, press down the knob to select the mode. You can also press **Timebase Mode** continuously or enable the touch screen to select the desired mode.

7.1.1 YT Mode

In this mode, the Y axis represents voltage, and the X axis represents time.

NOTE

 Only when this mode is enabled, can delayed sweep be turned on. In this mode, when the horizontal time base is equal to or greater than 200ms/div, the instrument enters slow sweep mode. For details, refer to descriptions in "*ROLL Mode*".

7.1.2 XY Mode

In this mode, both the X axis and the Y axis represent the voltage. The mode changes the display from voltage-time display mode to voltage-voltage display. You can use the Lissajous method to measure the phase deviation of the two input signals whose frequencies are the same. The following figure shows the measurement schematic diagram of phase deviation.

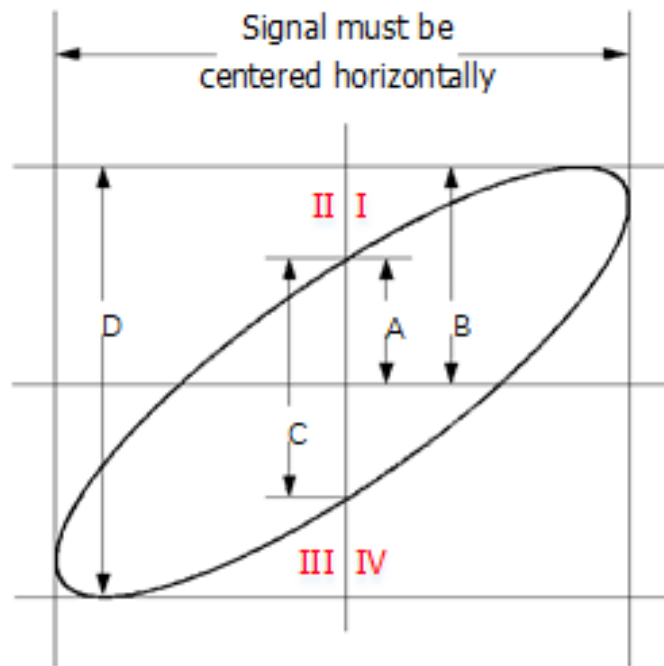

Figure 7.1 Measurement Schematic Diagram of Phase Deviation

According to $\sin\theta = A/B$ or C/D , θ is the phase deviation angle between the two channels. The definitions of A, B, C, and D are shown in the above figure. The phase deviation angle is obtained, that is:

$$\theta = \pm \arcsin(A/B) \text{ or } \pm \arcsin(C/D)$$

If the principal axis of the ellipse is within Quadrant I and III, the phase deviation angle obtained should be within Quadrant I and IV, namely within $(0 \text{ to } \pi/2)$ or $(3\pi/2 \text{ to } 2\pi)$. If the principal axis of the ellipse is within Quadrant II and IV, the phase deviation angle obtained should be within Quadrant II and III, namely within $(\pi/2 \text{ to } \pi)$ or $(\pi \text{ to } 3\pi/2)$.

The XY function can be used to measure the phase deviation occurred when the signal under test passes through a circuit network. Connect the oscilloscope to the circuit to monitor the input and output signals of the circuit.

Application example: measures the phase deviation between the input signals of two channels.

Use Lissajous method

1. Connect one sine signal to CH1, and then connect another sine signal (with the same frequency and amplitude as the previous one but a 90° phase deviation from the previous one) to CH2.

2. Press **AUTO**, after you select "XY" mode, rotate the **Horizontal SCALE** knob to adjust the sample rate properly to obtain a better view of Lissajous graph for observation and measurement.
3. Rotate the **Vertical SCALE** knob that corresponds to CH1 and CH2 respectively to make the signals easy to observe. Then, a circle, as shown in the figure below, should be displayed.

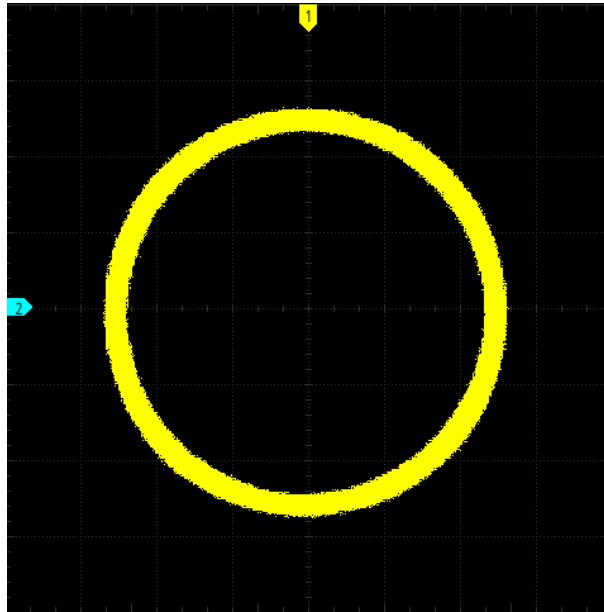

4. Observe the measurement result shown in the figure above. According to the measurement schematic diagram of the phase deviation (as shown in *Figure 7.1*), $A/B(C/D)=1$. Thus, the phase deviation angle of the two channel input signals is $\theta = \pm \arcsin 1 = 90^\circ$.



NOTE

- The maximum sample rate in XY mode is 2.5 GSa/s. In this mode, CH1 and CH2 are forced to be enabled; CH3 and CH4 are forced to be disabled. Generally, a longer sample waveform can ensure better display effect of Lissajous figure. But due to the limitation of the memory depth, you have to reduce the waveform sample rate to acquire a longer waveform (refer to the introduction in "*Memory Depth*"). Therefore, during the measurement, reducing the sample rate properly can achieve better display effect of Lissajous figure.
- The following functions cannot be set in XY mode:
"Delayed Sweep", *"To Select the Display Type"*, *"Show Scale"*, *"Protocol Decoding"*, *"Pass/Fail Test"*, *"Waveform Recording and Playing"*, and *"Digital Channel"*.

7.1.3 ROLL Mode

In this mode, the waveform scrolls from right to left to update the display. The available range of the horizontal scale is from 200 ms to 1 ks. Press **More > Auto ROLL** to select "ON". The system automatically enters the ROLL mode, and slow sweep mode is disabled.



NOTE

- If the current delayed sweep is enabled, then when you enable the ROLL mode, the delayed sweep is disabled automatically. When you re-enable the "YT" mode, the delayed sweep will be re-enabled.
- The following functions cannot be set in ROLL mode:

"To Adjust the Horizontal Position" (available when the oscilloscope is in "Stop" operating status), *"Delayed Sweep"*, *"To Trigger the Oscilloscope"*, *"Protocol Decoding"*, *"Pass/Fail Test"*, *"Waveform Recording and Playing"*, and *"To Set the Persistence Time"*.



Slow Sweep

It is similar to the ROLL mode. In YT mode, when the horizontal time base is set to 200 ms/div or smaller, the instrument enters the "slow sweep" mode in which the instrument first acquires the data at the left of the trigger point and then waits for a trigger event. After the trigger occurs, the instrument continues to finish the waveform at the right of the trigger point. When observing the low-frequency signal in the slow sweep mode, it is recommended that you set *"Channel Coupling"* to "DC".

7.2 Acquisition Mode

The acquisition mode is used to control how to generate waveform points from the sample points.

This series of oscilloscope supports the following four acquisition modes: Normal, Average, Peak, and High Res. By default, the acquisition mode is Normal.

Press  > **Acquisition** on the front panel, and then rotate the multifunction knob  to select the desired acquisition mode. Then, press down the knob to select the mode. You can also press **Acquisition** continuously or enable the touch screen to select the mode.

7.2.1 Normal

In this mode, the oscilloscope samples the signal at a specified fixed time interval to rebuild the waveform. For most of the waveforms, using this mode can produce the optimal display effects.

7.2.2 Average

In this mode, the oscilloscope averages the waveforms from multiple samples to reduce the random noise of the input signal and improve the vertical resolution. Greater number of averages can lower the noise and increase the vertical resolution; while at the same time, it will slow the response of the displayed waveform to the waveform changes.

When you select "Average" mode, press **Averages**, and rotate the multifunction knob  to set the desired number of averages. You can also use the pop-up numeric keypad to input the average count. When the average count value is not in N power-of-2 increments, a prompt message "Truncation average error" is displayed. At this time, a value that is smaller than the one you input and the closest to N power-of-2 increments will be input automatically. For example, if you input 9 with the numeric keypad, the average count will be automatically input as 8.

The number of averages can be set to 2, 4, 8, 16, 32, 64, 128, 256, 512, 1024, 2048, 4096, 8192, 16384, 32768, or 65536. By default, it is 2.

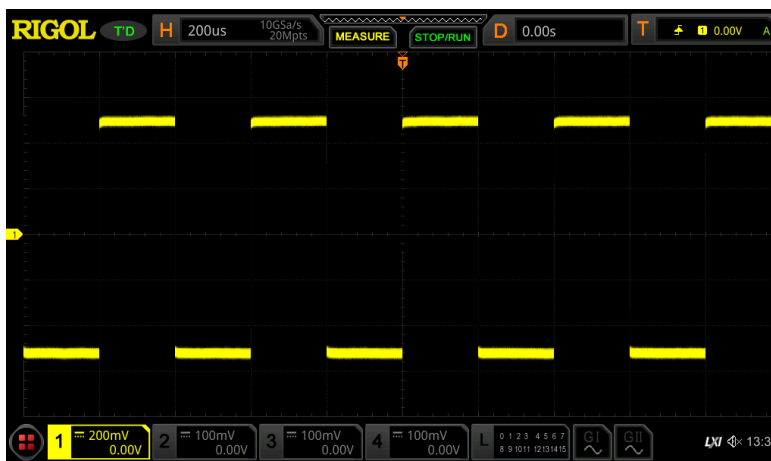

Figure 7.2 Waveforms before Averaging

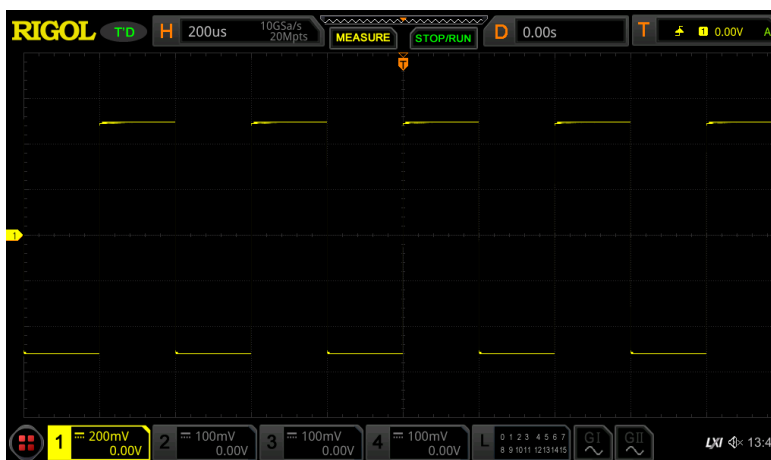

Figure 7.3 Waveforms after 128 Times of Averaging

7.2.3 Peak

In this mode, the oscilloscope acquires the maximum and minimum values of the signal within the sample interval to get the envelope of the signal or the narrow pulse that might be lost. In this mode, signal aliasing can be prevented, but the noise displayed would be larger.

In this mode, the oscilloscope can display all the pulses whose pulse widths are at least the same as the sample period.

7.2.4 High Resolution

This mode uses a kind of ultra-sample technique to average the neighboring points of the sample waveform to reduce the random noise on the input signal and generate much smoother waveforms on the screen. This is generally used when the sample rate of the digital converter is higher than the storage rate of the acquisition memory.



NOTE

- The averaging modes of the "Average" and "High Res" are different. The former uses "Multi-sample Average" and the latter uses "Single Sample Average".
- In "High Res" mode, the oscilloscope improves the measurement accuracy at the cost of bandwidth. Each time the sampling rate changes, a window displaying the current bandwidth appears temporarily at the lower-left corner of the screen.
- In high-resolution mode, highest capture rate is not available.
- The available number of resolution bits is 9, 10, 11, and 12. When each bit resolution is selected, a corresponding bandwidth is displayed temporarily.
- The high-resolution mode supports all the timebase modes: YT mode (including recording and ZOOM), XY mode, ROLL mode, and SCAN mode.
- In high-resolution mode, the high-resolution waveforms can be exported, with 16 bits per point.
- When high-resolution waveforms are imported, waveform plotting and analysis also support high resolution.

7.3 Sampling Mode

This oscilloscope only supports the real-time sampling mode. In this mode, the oscilloscope produce the waveform display from samples collected during one trigger event. The highest real-time sample rate on the analog channel of this oscilloscope series is 10 GSa/s. The current sample rate is displayed under **CH SampleRate**.



TIP



Press  on the front panel to stop sampling, and then the oscilloscope will maintain its last captured graph. You can still expand or zoom the waveforms by using the horizontal and vertical control knobs.

7.4 Sample Rate

Sampling is the process of converting the analog signal into the digital signal at a specified time interval and then restoring them in sequence. The sample rate is the reciprocal of the time interval.

The sample rate of the analog channel is related to the current channel mode. The maximum real-time sample rate in the single-channel mode of the oscilloscope is 10 GSa/s. The maximum real-time sample rate in the dual-channel mode is 5 GSa/s, and the maximum real-time sample rate in the 4-channel mode is 2.5 GSa/s.



TIP

Single-channel mode: only one of the four channels (CH1/CH2/CH3/CH4) is enabled.

Dual-channel mode: either CH1 or CH2 is enabled; and either CH3 or CH4 is enabled.

4-channel mode: CH1/CH2 are both enabled or CH3/CH4 are both enabled.



NOTE

The sample rate is displayed both in the status bar at the upper part of the screen and in the **CH SampleRate** menu. To indirectly modify the sample rate, rotate the **Horizontal**  **SCALE** knob to adjust the horizontal time base or modify the memory depth. In addition, if the triggering source selects the analog channel, the channel mode will be changed, and thus affecting the sampling rate.

The impact of low sample rate on the waveform:

- 1. Waveform Distortion:** when the sample rate is too low, some waveform details are lost, and the sample waveform displayed is rather different from the actual waveform of the signal.

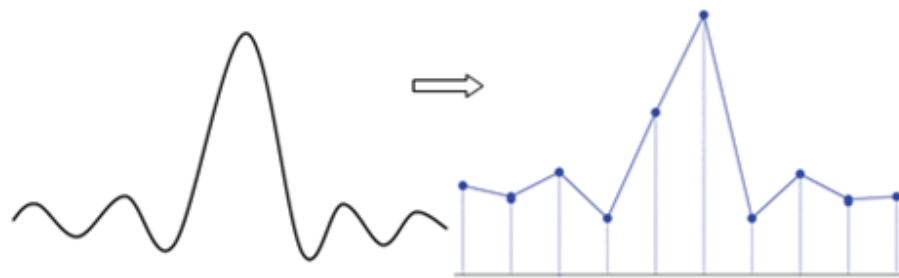

- 2. Waveform Aliasing:** when the sample rate is twice lower than the actual signal frequency (Nyquist Frequency), the frequency of the waveform rebuilt from the sample data is smaller than the actual signal frequency.

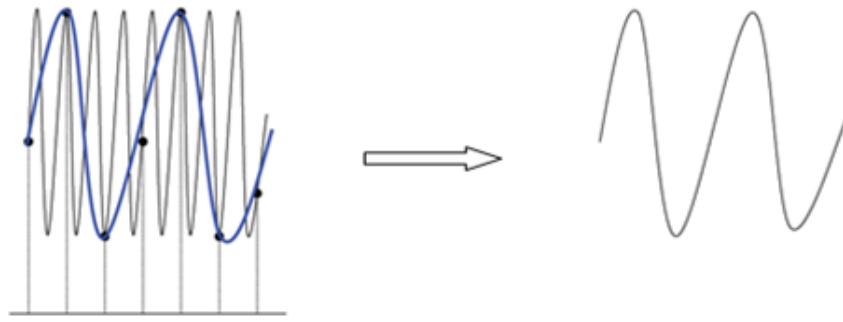

3. Waveform Leakage: when the sample rate is too low, the waveform rebuilt from the sample data do not reflect all the actual signal information.

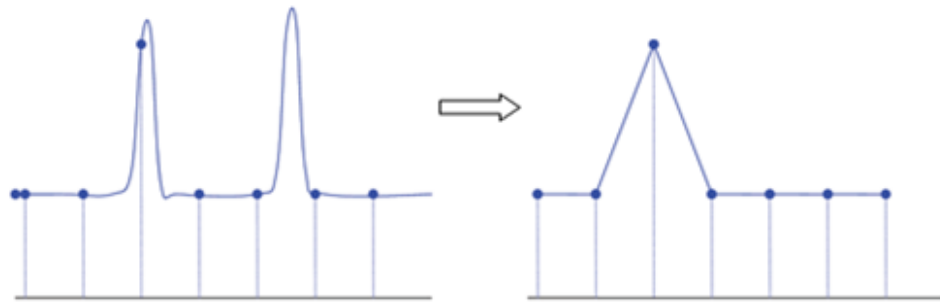

7.5 LA Sample Rate

LA sampling is the process of sampling on the compared digital signals at a certain time interval. LA sample rate is the reciprocal of the time interval. For example, if the LA sample rate is 500 MSa/s, it indicates that the oscilloscope will make data acquisition on the digital signals at an interval of 2 ns. The maximum LA sample rate of the oscilloscope is 1.25 GSa/s, and its display value is related to the sample rate of the current analog channel.



NOTE

- The digital signals mentioned here refers to the signal obtained from the comparison between the input signal and the user-defined threshold level. The rule of the comparison is that when the amplitude of the input signal is greater than the threshold level, it is judged to be the logic high level; when the amplitude of the input signal is smaller than the threshold level, it is judged to be the logic low level.
- LA sample rate is displayed under the **LA SampleRate** menu. To indirectly modify the LA sample rate, rotate the **Horizontal**  **SCALE** knob to adjust the horizontal time base or modify the memory depth.

7.6 Memory Depth

Memory depth refers to the number of points of the oscilloscope that can store in one trigger acquisition. It reflects the storage capability of the acquisition storage. This oscilloscope is equipped with a standard memory depth of up to 500 Mpts.

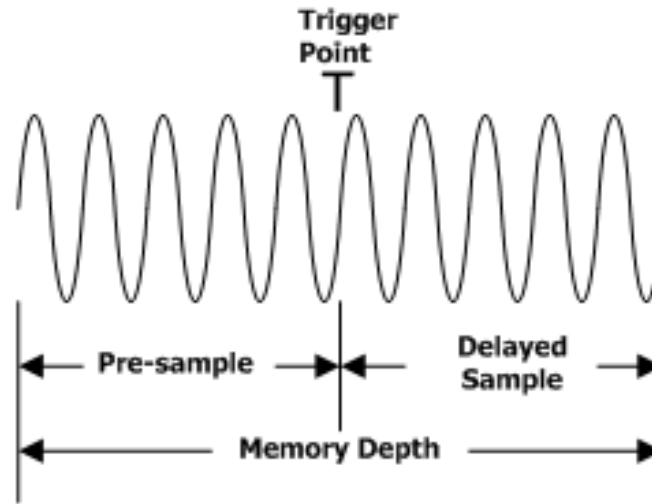



Figure 7.4 Memory Depth

The following equation shows the relations among memory depth, sample rate, and horizontal time base scale:

$$MDepth = SRate \times TScale \times HDivs$$

- **Mdepth:** indicates the memory depth. The unit is pts.
- **SRate:** indicates the sample rate. The unit is Sa/s.
- **TScale:** indicates the horizontal time base scale. The unit is s/div.
- **HDivs:** indicates the number of grids in the horizontal direction. The unit is div.

Therefore, under the same horizontal time base scale, a higher memory depth can ensure a higher sample rate.

Press  > **Mem Depth**, then rotate the multifunction knob  to select the desired memory depth, and then press down the knob to select it. You can also press **Mem Depth** continuously or enable the touch screen to select the desired memory depth. By default, the memory depth is Auto.

- In single-channel mode, the memory depths available include Auto, 1 Kpts, 10 Kpts, 100 Kpts, 1 Mpts, 10 Mpts, 25 Mpts, 50 Mpts, 100 Mpts, 125 Mpts, 250 Mpts, and 500 Mpts.
- In dual-channel mode, the memory depths available include Auto, 1 Kpts, 10 Kpts, 100 Kpts, 1 Mpts, 10 Mpts, 25 Mpts, 50 Mpts, 100 Mpts, 125 Mpts, and 250 Mpts.

- In 4-channel mode, the memory depths available include Auto, 1 Kpts, 10 Kpts, 100 Kpts, 1 Mpts, 10 Mpts, 25 Mpts, 50 Mpts, 100 Mpts, and 125 Mpts.

**NOTE**

In "Auto" mode, the oscilloscope selects the memory depth automatically according to the current sample rate.

7.7 LA Memory Depth

Press  > **More** to view the memory depth of the current digital channel under **LA Mem Depth**. The LA memory depth will change with the memory depth of the analog channel, and cannot be set separately. The maximum LA memory depth is 62.5 Mpts.

7.8 Anti-Aliasing

At a slower sweep speed, the sample rate is reduced, and a dedicated display algorithm can be used to minimize the possibility of aliasing.



Press  > **Anti-Aliasing** to enable or disable the anti-aliasing function. By default, anti-aliasing is disabled. In this case, it is more likely to generate waveform aliasing.

**NOTE**

This function should be enabled when the horizontal time base has a large deviation from the period of the signal under test (e.g. when the horizontal time base is greater than five-fold the period of the signal under test).



7.9 Horizontal Expansion

Horizontal expansion indicates the reference position that the screen waveform is referenced to when it is horizontally expanded or compressed in adjusting the

Horizontal  **SCALE** knob. In YT mode, press  > **More** > **Expand**, then rotate the multifunction knob  to switch to the desired memory depth, and then press down the knob to select the option. You can also press the **Expand** key continuously or use the touch screen to select the desired reference. The horizontal expansion reference supported by the oscilloscope includes Center, Left, Right, Trigger, and User. The default is "Center".

- Center: when the horizontal time base is modified, the waveform will be expanded or compressed horizontally relative to the screen center.

- Left: when the horizontal time base is modified, the waveform will be expanded or compressed horizontally relative to the leftmost position of the screen.
- Right: when the horizontal time base is modified, the waveform will be expanded or compressed horizontally relative to the rightmost position of the screen.
- Trigger: when the horizontal time base is modified, the waveform will be expanded or compressed horizontally relative to the trigger point.
- User: when the horizontal time base is modified, the waveform displayed will be expanded or compressed horizontally relative to the user-defined reference position.

After you select "User", press **Expand User** and then rotate the multifunction knob  to set the expansion reference. Its available range is from rightmost position of the screen to leftmost position of the screen. By default, it is the screen center. Pressing down the multifunction knob  can quickly reset the user-defined reference position to 0.

**NOTE**



This function is unavailable in XY mode, ROLL mode, and YT mode with the delayed sweep being enabled.

8 To Trigger the Oscilloscope

As for trigger, you set certain trigger condition according to the requirement and when a waveform in the waveform stream meets this condition, the oscilloscope captures this waveform as well as the neighboring part, and displays them on the screen. For the digital oscilloscope, it samples waveform continuously no matter whether it is stably triggered, but only stable trigger can be stably displayed. The trigger module ensures that every time base sweep or acquisition starts from the user-defined trigger condition, namely every sweep is synchronous with the acquisition and the waveforms acquired is overlapped so as to display the stable waveforms.

Trigger settings should be based on the features of the input signal. To quickly capture the desired waveform, you need to understand the signal under test. This oscilloscope provides abundant trigger types that help you focus on the desired waveform details.

8.1 Trigger Source

In the trigger control area on the front panel, press  > **Source**, then rotate the multifunction knob  to select a desired source, then press down the knob to select it. You can also press **Source** continuously or enable the touch screen to select it.

The analog channels (CH1-CH4), digital channels (D0-D15), EXT, or AC Line can all be selected as the trigger source.

Analog channel input:

Signals input from analog channels CH1-CH4 can all be used as trigger sources. No matter whether the channel selected is enabled, the channel can work normally.

Digital channel input:

Signals input from digital channels D0-D15 can all be used as trigger sources. No matter whether the channel selected is enabled, the channel can work normally.

External trigger input:

The external trigger source can trigger on the fifth channel while all the other four channels are acquiring data. The trigger signal (e.g. external clock or signal of the circuit under test) will be connected to **EXT** trigger source via the external trigger input terminal [**EXT TRIG**] connector. You can set the trigger conditions within the range of the trigger level (from -8 V to +8 V).

AC line input:

The trigger signal is obtained from the AC power input of the oscilloscope. AC trigger is usually used to measure signals relevant to the AC power frequency. For example,

stably triggering the waveform output from the transformer of a transformer substation. It is mainly used in related measurements of the power industry.

8.2 Trigger LEVEL/Threshold Level

The adjustment of the trigger level/threshold level is related to the type of the trigger source.

- When the trigger source is selected from CH1 to CH4, rotate the **Trigger**  **LEVEL** knob to adjust the trigger level. During the adjustment, a trigger level line (the color of the trigger level line is the same as that of the channel) and a trigger label "▶" are displayed on the screen, and they move up and down with the variation of the trigger level. When you stopping modifying the trigger level, the trigger level line disappears in about 2 s. The current trigger level of is displayed at the upper-right corner of the screen.

NOTE

In Runt Trigger, Slope Trigger, and Window trigger, you need to set the upper and lower limits of the trigger level. Rotate the **Trigger**  **LEVEL** knob to adjust the trigger level. The difference between the current upper limit and lower limit of the trigger level is displayed at the upper-right side of the screen. Two trigger level labels ▶ and ◻ are displayed at the left side of the screen. During the adjustment of trigger level, two trigger level lines appear on the screen, and they move up and down with the change of the trigger level. At the same time, the real-time trigger level information is displayed at the lower-left corner of the screen (As shown in the figure below, H indicates the upper limit of the trigger level, L indicates the lower limit of the trigger level, and Δ indicates the trigger level deviation).

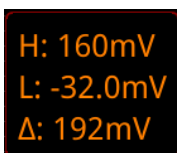



H: 160mV
L: -32.0mV
Δ: 192mV

- When the trigger source is EXT, rotate the **Trigger**  **LEVEL** knob to adjust the trigger level. The current trigger level of is displayed at the upper-right corner of the screen.

NOTE

For this trigger source, only the variation of the trigger level value is displayed on the screen during the adjustment of the trigger level, without displaying the trigger level lines on the screen.



- When the trigger source is AC Line, there is no trigger level.
- When the trigger source is D0-D15, rotate the **Trigger**  **LEVEL** knob to adjust the threshold level. The current threshold level value is displayed at the upper-

right corner of the screen. In addition, you can also press  to enter the LA logic analysis setting menu. Then set the threshold level of the digital channel in the sub-menu threshold setting. For the setting method, refer to "*To Set the Threshold*".

You can also enable the touch screen to adjust the trigger level/threshold level. Two methods are available for you:

Method 1: Enable the touch screen and drag the trigger level line to adjust the trigger level. For details about the operations, refer to descriptions in "*Drag*".

Method 2: Enable the touch screen, and tap the trigger setting label

 at the upper-right corner of the screen. The following window is displayed. Tap the  icon at the right side of the input field of the trigger level to decrease or increase the trigger level. You can also tap the input field of the trigger level to input a specific value with the displayed numeric keypad.

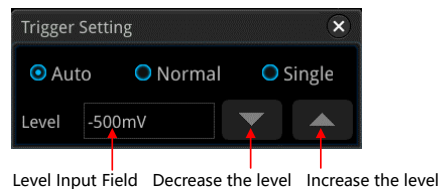

8.3 Trigger Mode

The following is the schematic diagram of the acquisition memory. To easily understand the trigger event, we classify the acquisition memory into the pre-trigger buffer and post-trigger buffer.

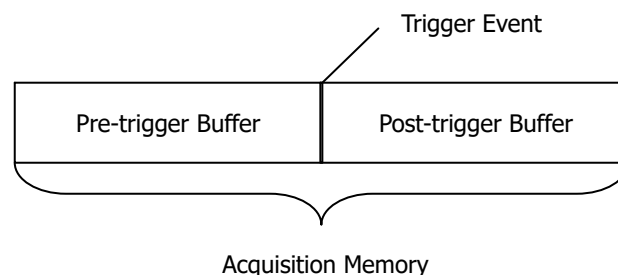



Figure 8.1 Schematic Diagram of the Acquisition Memory

After the system runs, the oscilloscope operates by first filling the pre-trigger buffer. It starts searching for a trigger after the pre-trigger buffer is filled. While searching for the trigger, the data sampled will still be transmitted to the pre-trigger buffer (the new data will continuously overwrite the previous data). When a trigger is found, the pre-trigger buffer contains the data acquired just before the trigger. Then, the

oscilloscope will fill the post-trigger buffer and display the data in the acquisition memory. If the acquisition is activated via , the oscilloscope will repeat this process; if the acquisition is activated via , the oscilloscope will stop after finishing a single acquisition (you can pan and zoom the currently displayed waveform).

This oscilloscope provides Auto, Normal, and Single trigger modes. The default is Auto.

In the trigger control area on the front panel, press  to quickly switch the current trigger mode. The trigger mode is displayed at the upper-right corner of the screen: A (Auto), N (Normal), and S (Single).

- **Auto:** In this trigger mode, if the specified trigger conditions are not found, the oscilloscope will initiate a trigger and capture waveforms forcibly. This trigger mode should be used when the signal level is unknown or the DC should be displayed as well as when forcible trigger is not necessary as the trigger condition always occurs.
- **Normal:** In this trigger mode, triggers and acquisitions only occur when the specified trigger conditions are found. This trigger mode should be used when the signal is with low repetition rate or only the event specified by the trigger setting needs to be sampled as well as when auto trigger should be prevented to acquire stable display.
- **Single:** In this trigger mode, the oscilloscope performs a single trigger and acquisition when the specified trigger conditions are found, and then stops. This trigger mode should be used when you need to perform a single acquisition of the specified event and analyze the acquisition result (you can pan and zoom the currently displayed waveform, and the subsequent waveform data will not overwrite the current waveform). After a single trigger mode is initiated, the operating status of the oscilloscope turns out to be in "STOP" state.

NOTE

In **Normal** and **Single** trigger modes, pressing  can generate a trigger signal forcibly.



You can also enable the touch screen to set the trigger mode. Tap the trigger setting label  at the upper-right corner of the screen. Then the following window is displayed. Tap to select "Auto", "Normal", or "Single" as the trigger mode.

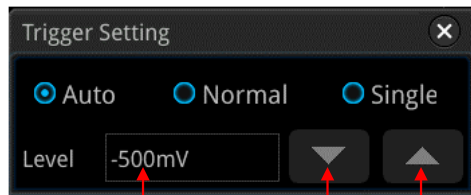

Level Input Field Decrease the level Increase the level



8.4 Trigger Coupling

Trigger coupling decides which kind of components will be transmitted to the trigger module. Please distinguish trigger coupling from "*Channel Coupling*".



NOTE

Trigger coupling is only valid when the trigger type is Edge and the trigger source is an analog channel.

Press  > **Coupling** in the trigger control area on the front panel, and then rotate the multifunction knob  to select the desired coupling mode (by default, it is DC). You can also press **Coupling** key continuously or use the touch screen to select the desired coupling mode.

- DC: allows DC and AC components to pass the trigger path.
- AC: blocks the DC components and attenuates signals.
- LFR: blocks the DC components and rejects the low-frequency components.
- HFR: rejects the high frequency components.



TIP

When "AC" or "LFR" is selected under Coupling, no trigger level lines and trigger icons are displayed. When you adjust the trigger level, you can only see the changes of the trigger level values at the upper-right corner of the screen.

8.5 Trigger Holdoff

Trigger holdoff can be used to stably trigger on complex repetitive waveforms that have multiple edges (or other events) between waveform repetitions (such as pulse series). Holdoff time indicates the time that the oscilloscope waits for re-arming the trigger module after generating a correct trigger. The oscilloscope will not trigger

even if the trigger condition is met during the holdoff time and will only re-arm the trigger module after the holdoff time expires.

For example, to stably trigger the repetitive pulse series as shown in the figure below, the holdoff time should be set to a value that is greater than t_1 and smaller than t_2 .

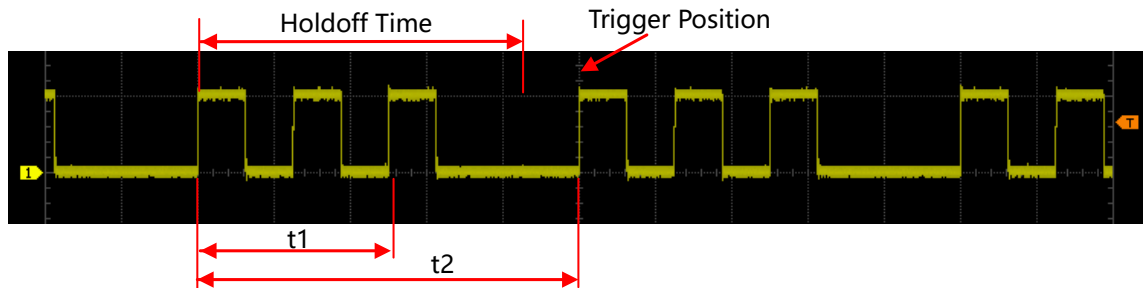



Figure 8.2 Schematic Diagram of Trigger Holdoff

In the trigger control area (Trigger), press **Menu** > **Holdoff** (for some trigger, **Holdoff** is a sub menu under **More**, at this time, press **Menu** > **More** > **Holdoff**), and then rotate the multifunction knob  at a small step to modify the holdoff time (the holdoff to this time when the waveforms are stably triggered; by default, the holdoff time is 8 ns) or use the numeric keypad to set the holdoff time. The adjustable range of the holdoff time is from 8 ns to 10 s.

8.6 Noise Rejection

Noise rejection can reject the high frequency noise in the signal and reduce the possibility of miss-trigger of the oscilloscope.

In the trigger control area (Trigger) on the front panel, press **Menu** to enter the trigger setting menu, then press **Noise Reject** continuously (for some trigger, **Noise Reject** is a sub-menu under **More**, at this time, press **Menu** > **More** > **Noise Reject**) to enable or disable the noise rejection.

NOTE



This function is only valid when the trigger source is an analog channel.

8.7 Trigger Type

8.7.1 Edge Trigger

Triggers on the trigger level/threshold level of the specified edge of the input signal.

Trigger Type:

In the trigger control area (Trigger) on the front panel, press  > **Type**, and rotate the multifunction knob  to select "Edge", then press down the knob to select it. You can also press **Type** continuously or enable the touch screen to select it. At this time, the current trigger setting information (including trigger type, trigger source, and trigger level/threshold level) is displayed at the upper-right corner of the screen, as shown in the figure below. The information will change based on the trigger settings.

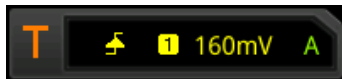

Source Selection:



Press **Source** to open the signal source list and select CH1-CH4, AC Line, EXT, or D0-D15. For details, refer to descriptions in "*Trigger Source*". The current trigger source is displayed at the upper-right corner of the screen.

NOTE

Only when we select the channel (that has been input with signals) as the trigger source, can we obtain a stable trigger.

Edge Type:

Press **Slope**, then rotate the multifunction knob  to select the input signal edge on which the oscilloscope triggers. Then the current edge type is displayed at the upper-right corner of the screen. You can also press **Slope** continuously or enable the touch screen to select it.

-  Rising: triggers on the rising edge of the input signal when the voltage level meets the specified trigger level.
-  Falling: triggers on the falling edge of the input signal when the voltage level meets the specified trigger level.
-  Either: triggers on the rising or falling edge of the input signal when the voltage level meets the preset trigger level.

Trigger Mode:

In the trigger control area (Trigger) on the front panel, press  to quickly switch the current trigger mode. For details, refer to descriptions in "*Trigger Mode*".

Trigger Parameter Setting:

Sets the trigger parameters (trigger coupling, trigger holdoff and noise rejection) under this trigger type. For details, refer to descriptions in "*Trigger Coupling*", "*Trigger Holdoff*" and "*Noise Rejection*".

Trigger LEVEL/Threshold Level:

Rotate the **Trigger**  **LEVEL** knob to adjust the trigger level or threshold level. Please refer to descriptions in "*Trigger LEVEL/Threshold Level*". The current trigger level/threshold level is displayed at the upper-right corner of the screen.

8.7.2 Pulse Trigger

Triggers on the positive or negative pulse with a specified width. In this mode, the oscilloscope will trigger when the pulse width of the input signal satisfies the specified pulse width condition.

In this oscilloscope, positive pulse width is defined as the time difference between the two crossing points of the trigger level and positive pulse; negative pulse width is defined as the time difference between the two crossing points of the trigger level and negative pulse, as shown in the figure below.

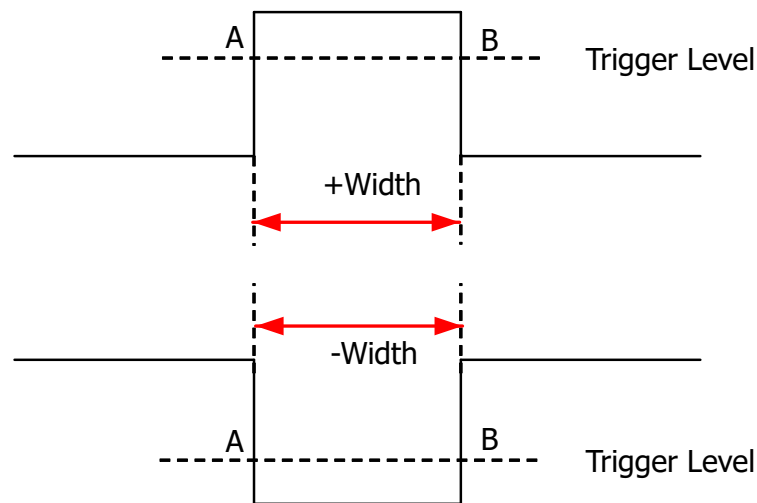

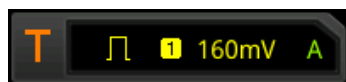

Figure 8.3 Positive Pulse Width/Negative Pulse Width

Trigger Type:

Press **Type**, and then rotate the multifunction knob  to select "Pulse". Press down the knob to select the trigger type. Then, the current trigger setting information is displayed at the upper-right corner of the screen, as shown in the figure below. You can also press **Type** continuously or enable the touch screen to select it.

**Source Selection:**

Press **Source** to open the signal source list and select CH1-CH4 or D0-D15. For details, refer to descriptions in "*Trigger Source*". The current trigger source is displayed at the upper-right corner of the screen.

**NOTE**

Only when we select the channel (that has been input with signals) as the trigger source, can we obtain a stable trigger.

Polarity:

Press **Polarity** continuously to select the desired polarity. The polarities available are positive polarity (▮▮) or negative polarity (▮▮).



Trigger Condition:

Press **When**, then rotate the multifunction knob  to select the trigger condition, and then press down the knob to select it. You can also press **When** continuously or enable the touch screen to select it.

- When you select "Positive" for polarity and ">" for trigger condition, the oscilloscope triggers when the positive pulse width of the input signal is greater than the specified pulse width.
- When you select "Positive" for polarity and "<" for trigger condition, the oscilloscope triggers when the positive pulse width of the input signal is smaller than the specified pulse width.
- When you select "Positive" for polarity and "<>" for trigger condition, the oscilloscope triggers when the positive pulse width of the input signal is greater than the specified lower limit of pulse width and smaller than the specified upper limit of pulse width.
- When you select "Negative" for polarity and ">" for trigger condition, the oscilloscope triggers when the negative pulse width of the input signal is greater than the specified pulse width.
- When you select "Negative" for polarity and "<" for trigger condition, the oscilloscope triggers when the negative pulse width of the input signal is smaller than the specified pulse width.
- When you select "Negative" for polarity and "<>" for trigger condition, the oscilloscope triggers when the negative pulse width of the input signal is greater

than the specified lower limit of pulse width and smaller than the specified upper limit of pulse width.

Pulse Width Setting:

- When ">" or "<" is set to trigger conditions, press **Lower** or **Upper**, and then rotate the multifunction knob  to set the lower limit value or the upper limit value. You can also use the pop-up numeric keypad to set it. The pulse range available is from 800 ps to 10 s.
- When the trigger condition is set to "<>", press **Upper** and **Lower**, and then rotate the multifunction knob  to set the upper limit value and the lower limit value. You can also use the pop-up numeric keypad to set them.

NOTE

The lower limit of the pulse width must be smaller than the upper limit.

Trigger Mode:

In the trigger control area (Trigger) on the front panel, press  to quickly switch the current trigger mode. For details, refer to descriptions in "*Trigger Mode*".

Trigger Parameter Setting:

Sets the trigger parameters (trigger holdoff and noise rejection) under this trigger type. For details, refer to descriptions in "*Trigger Holdoff*" and "*Noise Rejection*".

Trigger LEVEL/Threshold Level:

Rotate the **Trigger**  **LEVEL** knob to adjust the trigger level or threshold level. Please refer to descriptions in "*Trigger LEVEL/Threshold Level*". The current trigger level/threshold level is displayed at the upper-right corner of the screen.

8.7.3 Slope Trigger

In Slope trigger, the oscilloscope triggers on the positive or negative slope of the specified time. This trigger mode is applicable to ramp and triangle waveforms.

In this oscilloscope, positive slope time is defined as the time difference between the two crossing points of trigger level line A and B with the rising edge; negative slope time is defined as the time difference between the two crossing points of trigger level line A and B with the falling edge. As shown in the figure below:

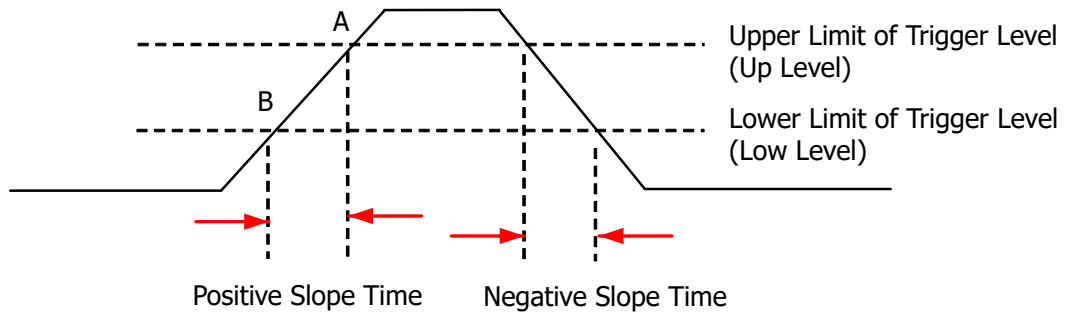



Figure 8.4 Positive Slope Time/Negative Slope Time

Trigger Type:

Press **Type**, and then rotate the multifunction knob  to select "Slope". Press down the knob to select the trigger type. Then, the current trigger setting information is displayed at the upper-right corner of the screen, as shown in the figure below. You can also press **Type** continuously or enable the touch screen to select it.



Source Selection:



Press **Source** to switch the trigger source and select CH1-CH4. For details, refer to descriptions in "*Trigger Source*". The current trigger source is displayed at the upper-right corner of the screen.

NOTE

Only when we select the channel (that has been input with signals) as the trigger source, can we obtain a stable trigger Wave.

Edge Type:

Press **Slope** to select the input signal edge on which the oscilloscope triggers.

-  Rising: triggers on the rising edge of the input signal.
-  Falling: triggers on the falling edge of the input signal.



Trigger Condition:

Press **When**, then rotate the multifunction knob  to select the trigger condition, and then press down the knob to select the trigger condition. You can also press **When** continuously or enable the touch screen to select it.

- When you select "Rising" for the edge type and ">" for trigger condition, the oscilloscope triggers when the positive slope time of the input signal is greater than the specified time.

- When you select "Rising" for the edge type and "<" for trigger condition, the oscilloscope triggers when the positive slope time of the input signal is smaller than the specified time.
- When you select "Rising" for the edge type and "<>" for trigger condition, the oscilloscope triggers when the positive slope time of the input signal is greater than the specified lower limit time and smaller than the specified upper limit time.
- When you select "Falling" for the edge type and ">" for trigger condition, the oscilloscope triggers when the negative slope time of the input signal is greater than the specified time.
- When you select "Falling" for the edge type and "<" for trigger condition, the oscilloscope triggers when the negative slope time of the input signal is smaller than the specified time.
- When you select "Falling" for the edge type and "<>" for trigger condition, the oscilloscope triggers when the negative slope time of the input signal is greater than the specified lower limit time and smaller than the specified upper limit time.

Slope Time Setting:

- When the **Trigger Condition** is set to ">" or "<", press **Lower** or **Upper**, and then rotate the multifunction knob  to set the lower limit value or the upper limit value. You can also use the numeric keypad to set it. The available range of the slope time is from 800 ps to 10 s.
- When the **Trigger Condition** is set to "<>", press **Upper** and **Lower**, and then rotate the multifunction knob  to set the upper limit value and the lower limit value. You can also use the numeric keypad to set them.

NOTE

The lower slope time limit must be smaller than the upper slope time limit.

Level Selection and Adjustment of Trigger Level:

After the trigger condition setting is completed, you need to adjust the trigger level to correctly trigger the signal and obtain a stable waveform. Press **Level Select** (when "<>" is selected as the trigger condition, **Level Select** is a sub-menu under **More**), then rotate the multifunction knob  to select the desired level type for adjustment, and then press down the knob to select the type. You can also press **Level Select** continuously or enable the touch screen to select it.

- Level A: only adjusts the upper limit of the trigger level, and the lower limit of the trigger level remains unchanged.
- Level B: only adjusts the lower limit of the trigger level, and the upper limit of the trigger level remains unchanged.
- Level AB: adjusts the upper and lower limits of the trigger level at the same time, and the trigger level deviation (the difference between the upper limit and lower limit of the trigger level) remains unchanged.

NOTE



In Slope trigger, pressing **Trigger**  **LEVEL** can quickly switch the current level adjustment type.

Rotate the **Trigger**  **LEVEL** knob to adjust the corresponding trigger level. During the adjustment of trigger level, two trigger level lines appear on the screen, and they move up and down with the change of the trigger level. At the same time, the real-time trigger level information is displayed at the lower-left corner of the screen (As shown in the figure below, H indicates the upper limit of the trigger level, L indicates the lower limit of the trigger level, and Δ indicates the trigger level deviation). When you stopping modifying the trigger level, the trigger level line and the trigger level information at the lower-left corner of the screen disappear in about 2 s. The current trigger level deviation is displayed at the upper-right corner of the screen.

H: 208mV
L: -32.0mV
 Δ : 240mV

Trigger Mode:

In the trigger control area (Trigger) on the front panel, press  to quickly switch the current trigger mode. For details, refer to descriptions in "*Trigger Mode*".

Trigger Parameter Setting:

Sets the trigger parameters (trigger holdoff and noise rejection) under this trigger type. For details, refer to descriptions in "*Trigger Holdoff*" and "*Noise Rejection*".

8.7.4 Video Trigger

The video signal can include image information and timing information, which adopts different standards and formats. This series oscilloscope can trigger on the standard video signal field or line of NTSC (National Television Standards Committee), PAL (Phase Alternating Line), or SECAM (Sequential Couleur A Memoire).

Trigger Type:

Press **Type**, and then rotate the multifunction knob  to select "Video". Press down the knob to select the type. Then, the current trigger setting information is displayed at the upper-right corner of the screen, as shown in the figure below. You can also press **Type** continuously or enable the touch screen to select it.





Source Selection:

Press **Source** to switch the trigger source and select CH1-CH4. For details, refer to descriptions in "*Trigger Source*". The current trigger source is displayed at the upper-right corner of the screen.

NOTE

Only when we select the channel (that has been input with signals) as the trigger source, can we obtain a stable trigger Wave.

Video Polarity:

Press **Polarity** continuously to select the desired video polarity. The polarities available are positive polarity  and negative polarity .

Video Standard:

Press **Standard**, and rotate the multifunction knob  to select the desired video standard. You can also press **Standard** continuously or enable the touch screen to select it.

Video Standard	Frame Frequency (Frame)	Scan Type	TV Scan Line
NTSC	30	Interlaced Scan	525
PAL/SECAM	25	Interlaced Scan	625
480p/60Hz	60	Progressive Scan	525
576p/50Hz	50	Progressive Scan	625

Video Standard	Frame Frequency (Frame)	Scan Type	TV Scan Line
720p/60Hz	60	Progressive Scan	750
720p/50Hz	50	Progressive Scan	750
720p/30Hz	30	Progressive Scan	750
720p/25Hz	25	Progressive Scan	750
720p/24Hz	24	Progressive Scan	750
1080p/60Hz	60	Progressive Scan	1125
1080p/50Hz	50	Progressive Scan	1125
1080p/30Hz	30	Progressive Scan	1125
1080p/25Hz	25	Progressive Scan	1125
1080p/24Hz	24	Progressive Scan	1125
1080i/60Hz	60	Interlaced Scan	1125
1080i/50Hz	50	Interlaced Scan	1125

Sync:

Press **Sync**, then rotate the multifunction knob  to select the sync type, and then press down the knob to select it. You can also press **Sync** continuously or enable the touch screen to select it.

- All Lines: triggers on the first line found.
- Line: triggers on the specified line.

When this sync type is selected, you can specify a line number. Press **Line**, then rotate the multifunction knob  or use the pop-up numeric keypad to modify the line number. The range of the line number is related to the currently selected video standards. The range is from 1 to 525 (NTSC), 1 to 625 (PAL/SECAM), 1 to 525 (480p), 1 to 625 (576p), 1 to 750 (720p), or 1 to 1125 (1080p/1080i).

- Odd: triggers on the rising edge of the first ramp pulse in the odd field. It is available when the video standard is NTSC, PAL/SECAM, or 1080i.

- Even: triggers on the rising edge of the first ramp pulse in the even field. It is available when the video standard is NTSC, PAL/SECAM, or 1080i.

Noise Rejection:

Sets the trigger parameter (noise rejection) under this trigger type. For details, refer to descriptions in "[Noise Rejection](#)".

Trigger Mode:

In the trigger control area (Trigger) on the front panel, press  to quickly switch the current trigger mode. For details, refer to descriptions in "[Trigger Mode](#)".

Trigger Level:

Rotate the **Trigger**  **LEVEL** knob to modify the level. For details, refer to descriptions in "[Trigger LEVEL/Threshold Level](#)".



TIP

- For a better observation of the waveform details in the video signal, you can set a larger memory depth first.
- In the trigger debugging process of video signals, the frequency in different part of the signal can be reflected by a different brightness, as RIGOL digital oscilloscope provides the intensity graded color display function. Experienced users can quickly judge the signal quality and discover abnormalities during the debugging process.

8.7.5 Pattern Trigger

Identifies a trigger condition by searching for a specified pattern. This pattern is a logical "AND" combination of channels. Each channel can be set to H (high), L (low), or X (don't care). A rising or falling edge (you can only specify a single edge) can be specified for one channel included in the pattern. When an edge is specified, the oscilloscope will trigger at the edge specified if the pattern set for the other channels are true (namely the actual pattern of the channel is the same as the preset pattern). If no edge is specified, the oscilloscope will trigger on the last edge that makes the pattern true. If all the channels in the pattern are set to "X", the oscilloscope will not trigger.

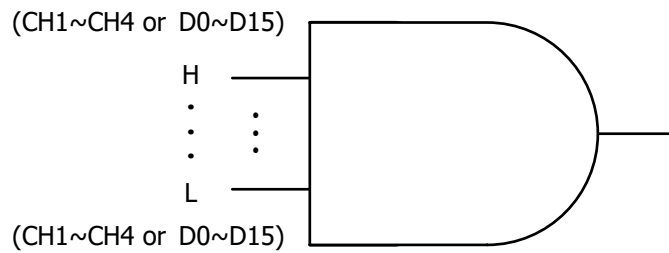



Figure 8.5 Pattern Trigger

Trigger Type:

Press **Type**, and then rotate the multifunction knob  to select "Pattern". Press down the knob to select the trigger type. Then, the current trigger setting information is displayed at the upper-right corner of the screen, as shown in the figure below. You can also press **Type** continuously or enable the touch screen to select it.

**Source Selection:**

Press **Source** to open the signal source list and select CH1-CH4 or D0-D15. For details, refer to descriptions in "*Trigger Source*". The current trigger source is displayed at the upper-right corner of the screen.





NOTE

Only when we select the channel (that has been input with signals) as the trigger source, can we obtain a stable trigger Wave.

Pattern Setting:

Press **Code**, then rotate the multifunction knob  to select the pattern of the currently selected channel, and then press down the knob to select it. You can also press **Code** continuously or enable the touch screen to select it. The following five patterns are available:

- H: sets the pattern of the channel selected to "1", i.g. the voltage level is higher than the trigger level/threshold level of the channel.
- L: sets the pattern of the channel selected to "0", i.g. the voltage level is lower than the trigger level/threshold level of the channel.

- X: sets the pattern of the channel selected to "X", i.g. this channel is not used as a part of the pattern. When all channels in the pattern are set to "X", the oscilloscope will not trigger.
-  Rising: sets the pattern to the rising edge ("") of the channel selected.
-  Falling: sets the pattern to the falling edge ("") of the channel selected.

At this time, the corresponding pattern is displayed at the bottom of the screen. The patterns of channels CH1-CH4 and D0-D15 are presented from left to right, as shown in the figure below.

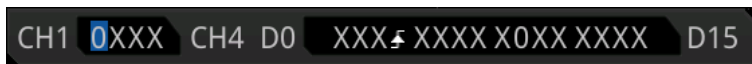

You can also set the pattern with the virtual keypad. The setting methods are as follows:



Enable the touch screen to tap the channel pattern. Then, a virtual keypad is displayed. Set the channel pattern with the keypad. For example, tap CH2 pattern, then the the channel pattern is displayed, as shown in *Figure 8.6*. Tap the left arrow key  to move the cursor to the left or tap the right arrow key  to move the cursor to the right. Then select a pattern. After the pattern of the current channel is set completely, the cursor goes to the next pattern bit automatically. Set them respectively. After all the pattern bits are set completely, tap OK to confirm the setting, and close the virtual keypad. You can also tap ALL to apply the current pattern to all the channels. This key functions the same as the **All Bits** menu key.



Figure 8.6 Virtual Keypad for Pattern Setting

NOTE

Only one edge (rising or falling edge) can be specified in the pattern. If one edge item is currently defined and then another edge item is defined in another channel in the pattern,



then a prompt message "Invalid input" is displayed. Then, the latter defined edge item will be replaced by X.

All Bits:

Press **All Bits** to set the patterns of all trigger sources to the pattern settings selected currently.

Trigger Condition:

Press **When**, then rotate the multifunction knob  to select the trigger condition, and then press down the knob to select it. You can also press **When** continuously or enable the touch screen to select it.

- **And:** triggers when the pattern meets the logical AND condition.
- **Or:** triggers when the pattern meets the logical OR condition.

Trigger Mode:

In the trigger control area (Trigger) on the front panel, press  to quickly switch the current trigger mode. For details, refer to descriptions in "*Trigger Mode*".

Trigger Parameter Setting:

Sets the trigger parameters (trigger holdoff and noise rejection) under this trigger type. For details, refer to descriptions in "*Trigger Holdoff*" and "*Noise Rejection*".

Trigger LEVEL/Threshold Level:

Rotate the **Trigger**  **LEVEL** knob to adjust the trigger level/ threshold level. Please refer to descriptions in "*Trigger LEVEL/Threshold Level*". The current trigger level/ threshold level is displayed at the upper-right corner of the screen.

8.7.6 Duration Trigger

In duration trigger, the instrument identifies a trigger condition by searching for the duration of a specified pattern. This pattern is a logical "AND" combination of the channels. Each channel can be set to H (high), L (low), or X (don't care). The instrument triggers when the duration (ΔT) of this pattern meets the preset time, as shown in the figure below.

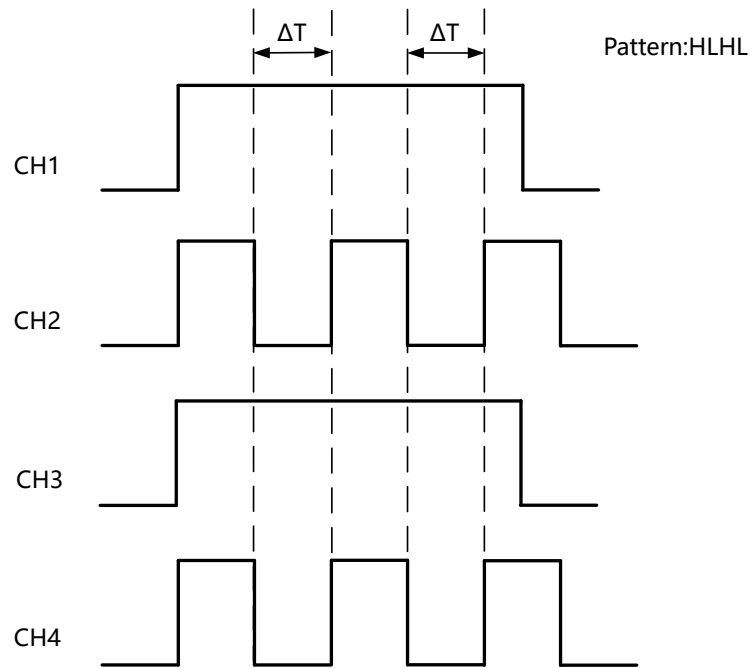



Figure 8.7 Duration Trigger

Trigger Type:

Press **Type**, and then rotate the multifunction knob  to select "Duration". Press down the knob to select the trigger type. Then, the current trigger setting information is displayed at the upper-right corner of the screen, as shown in the figure below. You can also press **Type** continuously or enable the touch screen to select it.



Source Selection:

Press **Source** to open the signal source list and select CH1-CH4 or D0-D15. For details, refer to descriptions in "*Trigger Source*". The current trigger source is displayed at the upper-right corner of the screen.



NOTE

Only when we select the channel (that has been input with signals) as the trigger source, can we obtain a stable trigger Wave.

Pattern Setting:

Press **Code**, then rotate the multifunction knob  to select the pattern of the current signal source. Press down the knob to select it. At this time, the corresponding pattern is displayed at the bottom of the screen. The patterns of channels CH1-CH4 and D0-D15 are presented from left to right, as shown in the figure below. You can also press **Code** continuously or enable the touch screen to select it.

CH1 0XX1 CH4 D0 X~~X~~XX XXXX XXXX XXXX D15

- H: sets the pattern of the channel selected to "H", i.g. the voltage level is higher than the trigger level/threshold level of the channel.
- L: sets the pattern of the channel selected to "L", i.g. the voltage level is lower than the trigger level/threshold level of the channel.
- X: sets the pattern of the channel selected to "X", i.g. this channel is not used as a part of the pattern. When all channels in the pattern are set to "Don' t Care", the oscilloscope will not trigger.

Trigger Condition:

Press **When**, then rotate the multifunction knob  to select the the desired trigger condition, and then press down the knob to select it. You can also press **When** continuously or enable the touch screen to select it.

- >: triggers when the duration of the pattern is greater than the preset time.
Press **Lower** to set the lower limit of the duration of the pattern. Its range is from 800 ps to 10 s.
- <: triggers when the duration of the pattern is smaller than the preset time.
Press **Upper** to set the upper limit of the duration of the pattern. Its range is from 800 ps to 10 s.
- <>: triggers when the duration of the pattern is smaller than the upper limit of the preset time and greater than the lower limit of the preset time. Press **Upper** to set the upper limit of the duration of the pattern. Its range is from 801 ps to 10 s. Press **Lower** to set the lower limit of the duration of the pattern. Its range is from 800 ps to 9.9 s.
- > <: triggers when the duration of the pattern is greater than the upper limit of the preset time or smaller than the lower limit of the preset time. Press **Upper** to set the upper limit of the duration of the pattern. Its range is from 800 ps to 10 s. Press **Lower** to set the lower limit of the duration of the pattern. Its range is from 800 ps to 9.9 s.

NOTE

The lower time limit must be smaller than the upper time limit.

All Bits:

Press **All Bits** to set the patterns of all the trigger sources to the pattern settings selected currently.

Trigger Mode:

In the trigger control area (Trigger) on the front panel, press  to quickly switch the current trigger mode. For details, refer to descriptions in "*Trigger Mode*".

Trigger Parameter Setting:

Sets the trigger parameters (trigger holdoff and noise rejection) under this trigger type. For details, refer to descriptions in "*Trigger Holdoff*" and "*Noise Rejection*".

Trigger LEVEL/Threshold Level:

Rotate the **Trigger**  **LEVEL** knob to adjust the trigger level/ threshold level. Please refer to descriptions in "*Trigger LEVEL/Threshold Level*". The current trigger level/ threshold level is displayed at the upper-right corner of the screen.

8.7.7 Timeout Trigger

In Timeout trigger, the instrument triggers when the time interval (ΔT) (the time from when the rising edge (or falling edge) of the input signal passes through the trigger level to the time from when the neighboring falling edge (or rising edge) passes through the trigger level) is greater than the preset timeout value, as shown in the figure below.

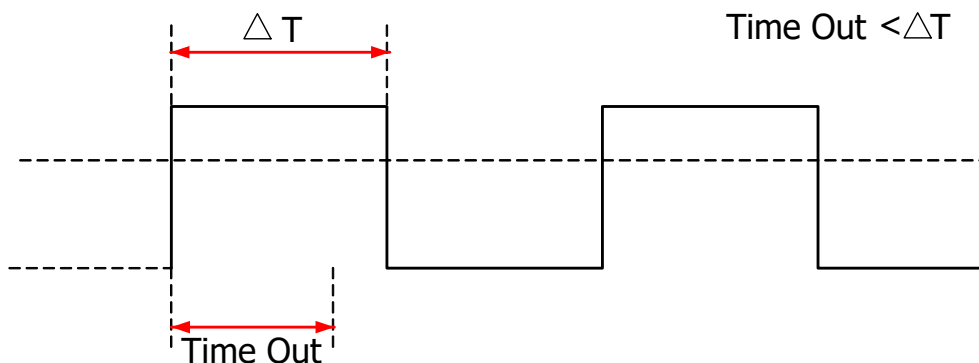



Figure 8.8 Timeout Trigger

Trigger Type:

Press **Type**, and then rotate the multifunction knob  to select "Timeout". Press down the knob to select the type. Then, the current trigger setting information is displayed at the upper-right corner of the screen, as shown in the figure below. You can also press **Type** continuously or enable the touch screen to select it.



Source Selection:

Press **Source** to open the signal source list and select CH1-CH4 or D0-D15. For details, refer to descriptions in "*Trigger Source*". The current trigger source is displayed at the upper-right corner of the screen.





NOTE

Only when we select the channel (that has been input with signals) as the trigger source, can we obtain a stable trigger Wave.

Edge Type:

Press **Slope**, then rotate the multifunction knob  to select input signal edge on which the oscilloscope triggers. You can also press **Slope** continuously or enable the touch screen to select it.

-  Rising: starts timing when the rising edge of the input signal passes through the trigger level.
-  Falling: starts timing when the falling edge of the input signal passes through the trigger level.
-  Either: starts timing when either edge of the input signal passes through the trigger level.

Timeout Value:

Timeout value represents the maximum time that the signal remains idle before the signal passes through the trigger level. Press **Timeout**, and then rotate the multifunction knob  or use the pop-up numeric keypad to set the timeout value. The available range is from 16 ns to 10 s.

Trigger Mode:

In the trigger control area (Trigger) on the front panel, press  to quickly switch the current trigger mode. For details, refer to descriptions in "*Trigger Mode*".

Trigger Parameter Setting:

Sets the trigger parameter (noise rejection) under this trigger type. For details, refer to descriptions in "*Noise Rejection*".

Trigger LEVEL/Threshold Level:

Rotate the **Trigger**  **LEVEL** knob to adjust the trigger level or threshold level. Please refer to descriptions in "*Trigger LEVEL/Threshold Level*". The current trigger level/threshold level is displayed at the upper-right corner of the screen.

8.7.8 Runt Trigger

This trigger mode is used to trigger pulses that pass through one trigger level but fail to pass through another trigger level, as shown in the figure below.

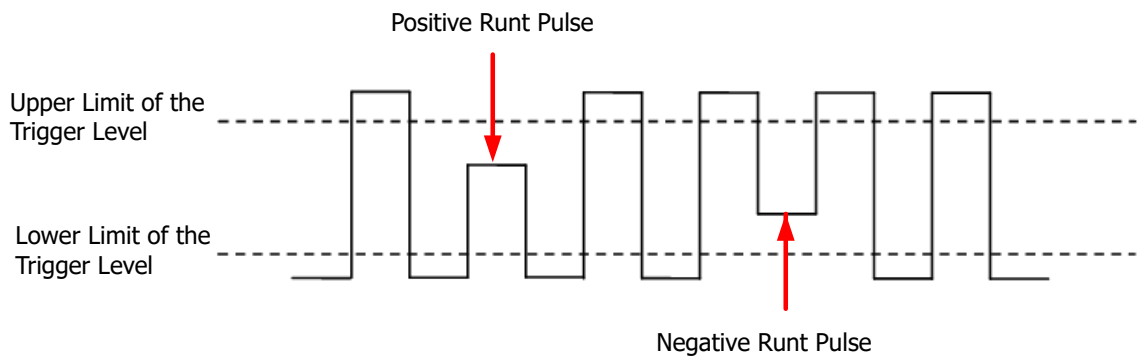



Figure 8.9 Runt Trigger

Trigger Type:

Press **Type**, and then rotate the multifunction knob  to select "Runt". Press down the knob to select it. Then, the current trigger setting information is displayed at the upper-right corner of the screen, as shown in the figure below. You can also press **Type** continuously or enable the touch screen to select it.



Source Selection:

Press **Source** to switch the trigger source and select CH1-CH4. For details, refer to descriptions in "*Trigger Source*". The current trigger source is displayed at the upper-right corner of the screen.





NOTE

Only when we select the channel (that has been input with signals) as the trigger source, can we obtain a stable trigger Wave.

Polarity:

Press **Polarity** to select the polarity of the Runt trigger.

-  Positive: triggers on the positive runt pulse.
-  Negative: triggers on the negative runt pulse.

Trigger Condition:

Press **When**, then rotate the multifunction knob  to select the the desired trigger condition, and then press down the knob to select it. You can also press **When** continuously or enable the touch screen to select it.

- **None**: indicates not setting the trigger condition of Runt trigger.
- **>**: triggers when the runt pulse width is greater than the lower limit of pulse width. Press **Lower** to set the minimum pulse width of Runt trigger.
- **<**: triggers when the runt pulse width is smaller than the upper limit of pulse width. Press **Upper** to set the maximum pulse width of Runt trigger.
- **<>**: triggers when the runt pulse width is greater than the lower limit and smaller than the upper limit of pulse width. Press **Upper** to set the maximum pulse width of Runt trigger. Press **Lower** to set the minimum pulse width of Runt trigger.

NOTE

The lower limit of the pulse width must be smaller than the upper limit.

Level Selection and Adjustment of Trigger Level:

After the trigger condition setting is completed, you need to adjust the trigger level to correctly trigger the signal and obtain a stable waveform. Press **Level Select** (when "<>" is selected as the trigger condition, **Level Select** is a sub-menu under **More**), then rotate the multifunction knob  to select the desired level type for adjustment, and then press down the knob to select it. You can also press **Level Select** continuously or enable the touch screen to select it.

Level A: only adjusts the upper limit of the trigger level, and the lower limit of the trigger level remains unchanged.

Level B: only adjusts the lower limit of the trigger level, and the upper limit of the trigger level remains unchanged.

Level AB: adjusts the upper and lower limits of the trigger level at the same time, and the trigger level deviation (the difference between the upper limit and lower limit of the trigger level) remains unchanged.

NOTE

In Runt trigger, pressing the **Trigger**  **LEVEL** knob can quickly switch the current level adjustment type.



Rotate the **Trigger**  **LEVEL** knob to adjust the corresponding trigger level. During the adjustment of trigger level, two trigger level lines appear on the screen, and they move up and down with the change of the trigger level. At the same time, the real-time trigger level information is displayed at the lower-left corner of the screen (As shown in the figure below, H indicates the upper limit of the trigger level, L indicates the lower limit of the trigger level, and Δ indicates the trigger level deviation). When you stopping modifying the trigger level, the trigger level line and the trigger level information at the lower-left corner of the screen disappear in about 2 s. The current trigger level deviation is displayed at the upper-right corner of the screen.

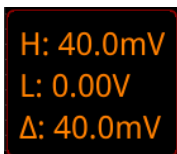

H: 40.0mV
L: 0.00V
 Δ : 40.0mV

Trigger Mode:

In the trigger control area (Trigger) on the front panel, press  to quickly switch the current trigger mode. For details, refer to descriptions in "[Trigger Mode](#)".

Trigger Parameter Setting:

Sets the trigger parameters (trigger holdoff and noise rejection) under this trigger type. For details, refer to descriptions in "[Trigger Holdoff](#)" and "[Noise Rejection](#)".

8.7.9 Window Trigger

Window trigger provides a high trigger level and a low trigger level. The instrument triggers when the input signal passes through the high trigger level or the low trigger level.

Trigger Type:

Press **Type**, and then rotate the multifunction knob  to select "Window". Press down the knob to select the trigger type. Then, the current trigger setting information is displayed at the upper-right corner of the screen, as shown in the figure below. You can also press **Type** continuously or enable the touch screen to select it.



T  Δ 40.0mV A

Source Selection:

Press **Source** to switch the trigger source and select CH1-CH4. For details, refer to descriptions in "[Trigger Source](#)". The current trigger source is displayed at the upper-right corner of the screen.



NOTE

Only when we select the channel (that has been input with signals) as the trigger source, can we obtain a stable trigger.



Edge Type:

Press **Slope**, then rotate the multifunction knob  to select the input signal edge on which the oscilloscope triggers. You can also press **Slope** continuously or enable the touch screen to select it.

-  **Rising**: triggers on the rising edge of the input signal when the voltage level is higher than the preset high trigger level.
-  **Falling**: triggers on the falling edge of the input signal when the voltage level is lower than the preset low trigger level.
-  **Either**: triggers on the rising or falling edge of the input signal when the voltage level meets the preset trigger level.

Trigger Position:

After selecting the window type, press **Position** to select the trigger position so as to further specify the time point of trigger. You can also press **Position** continuously or enable the touch screen to select it.

- **Enter**: triggers when the input signal enters the specified trigger level range.
- **Exit**: triggers when the input signal exits the specified trigger level range.
- **Time**: triggers when the accumulated hold time since the input signal entered the specified trigger level range is equal to the window time. Press **Time**, and then rotate the multifunction knob  or use the pop-up numeric keypad to set the window time. The available range is from 8 ns to 10 s.

Level Selection and Adjustment of Trigger Level:

After the trigger condition setting is completed, you need to adjust the trigger level to correctly trigger the signal and obtain a stable waveform. Press **Level Select**, then rotate the multifunction knob  to select the desired level type for adjustment, and then press down the knob to select the type. You can also press **Level Select** continuously or enable the touch screen to select it.

- **Level A**: only adjusts the upper limit of the trigger level, and the lower limit of the trigger level remains unchanged.
- **Level B**: only adjusts the lower limit of the trigger level, and the upper limit of the trigger level remains unchanged.

- Level AB: adjusts the upper and lower limits of the trigger level at the same time, and the trigger level deviation (the difference between the upper limit and lower limit of the trigger level) remains unchanged.

**NOTE**

In Window trigger, pressing **Trigger**  **LEVEL** can quickly switch the current level adjustment type.

Rotate the **Trigger**  **LEVEL** knob to adjust the corresponding trigger level. During the adjustment of trigger level, two trigger level lines appear on the screen, and they move up and down with the change of the trigger level. At the same time, the real-time trigger level and slope information is displayed at the lower-left corner of the screen (As shown in the figure below, H indicates the upper limit of the trigger level, L indicates the lower limit of the trigger level, and Δ indicates the trigger level deviation). When you stopping modifying the trigger level, the trigger level line and the trigger level information at the lower-left corner of the screen disappear in about 2 s. The current trigger level deviation is displayed at the upper-right corner of the screen.

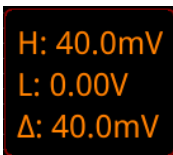

H: 40.0mV
L: 0.00V
 Δ : 40.0mV

Trigger Mode:

In the trigger control area (Trigger) on the front panel, press  to quickly switch the current trigger mode. For details, refer to descriptions in "[Trigger Mode](#)".

Trigger Parameter Setting:

Sets the trigger parameters (trigger holdoff and noise rejection) under this trigger type. For details, refer to descriptions in "[Trigger Holdoff](#)" and "[Noise Rejection](#)".

8.7.10 Delay Trigger

In Delay trigger, you need to set Source A and Source B. The oscilloscope triggers when the time difference (ΔT) between the specified edges of Source A (Edge A) and Source B (Edge B) meets the preset time limit, as shown in the figure below.

**NOTE**

Edge A and Edge B must be two neighboring edges.

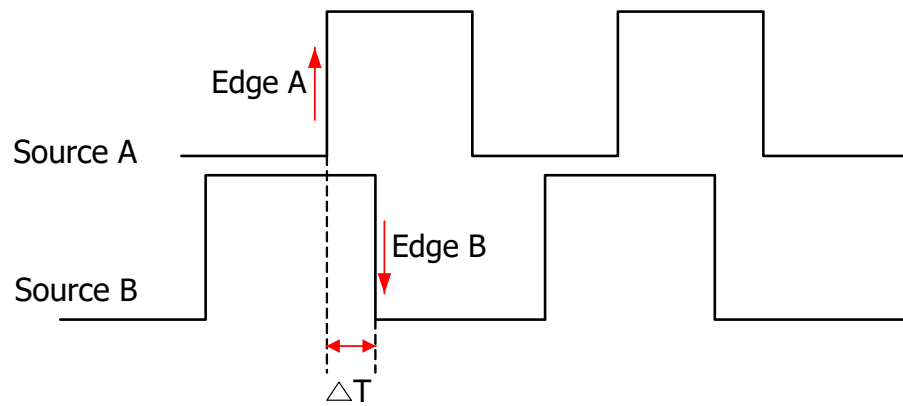

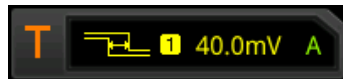

Figure 8.10 Delay Trigger

Trigger Type:

Press **Type**, and then rotate the multifunction knob  to select "Delay". Press down the knob to select the trigger type. Then, the current trigger setting information is displayed at the upper-right corner of the screen, as shown in the figure below. You can also press **Type** continuously or enable the touch screen to select it.



**Source A:**

Press **SourceA** to select CH1-CH4 or D0-D15 as the trigger source of Source A. For details, refer to descriptions in "*Trigger Source*". The current trigger source is displayed at the upper-right corner of the screen.

NOTE

Only when we select the channel (that has been input with signals) as the trigger source, can we obtain a stable trigger.

Edge A:

Press **EdgeA** continuously to select the trigger edge type of Source A in Delay trigger. It can be set to "Rising"  or "Falling" .



Source B:

Press **SourceB** to select CH1-CH4 or D0-D15 as the trigger source of Source B. For details, refer to descriptions in "*Trigger Source*". The current trigger source is displayed at the upper-right corner of the screen.

NOTE

Only when we select the channel (that has been input with signals) as the trigger source, can we obtain a stable trigger.

Edge B:

Press **EdgeB** continuously to select the trigger edge type of Source B in Delay trigger. It can be set to "Rising"  or "Falling" .

Trigger Condition:

Press **When** to set the time limit condition of Delay trigger.

- **>**: triggers when the time difference (ΔT) between the specified edges of Source A and Source B is greater than the preset time lower limit. Press **Lower** to set the delay time lower limit in Delay trigger.
- **<**: triggers when the time difference (ΔT) between the specified edges of Source A and Source B is smaller than the preset time upper limit. Press **Upper** to set the delay time upper limit in Delay trigger.
- **< >**: triggers when the time difference (ΔT) between the specified edges of Source A and Source B is greater than the lower limit of the preset time and smaller than the upper limit of the preset time. Press **Upper** to set the delay time upper limit in Delay trigger. Press **Lower** to set the delay time lower limit in Delay trigger.

NOTE

The lower time limit must be smaller than the upper time limit.

- **> <**: triggers when the time difference (ΔT) between the specified edges of Source A and Source B is smaller than the lower limit of the preset time or greater than the upper limit of the preset time. Press **Upper** to set the delay time upper limit in Delay trigger. Press **Lower** to set the delay time lower limit in Delay trigger.

NOTE

The lower time limit must be smaller than the upper time limit.

Trigger Mode:

In the trigger control area (Trigger) on the front panel, press  to quickly switch the current trigger mode. For details, refer to descriptions in "*Trigger Mode*".

Trigger Parameter Setting:

Sets the trigger parameters (trigger holdoff and noise rejection) under this trigger type. For details, refer to descriptions in "*Trigger Holdoff*" and "*Noise Rejection*".

Trigger LEVEL/Threshold Level:

Rotate the **Trigger**  **LEVEL** knob to adjust the trigger level/ threshold level. Please refer to descriptions in "*Trigger LEVEL/Threshold Level*". The current trigger level/ threshold level is displayed at the upper-right corner of the screen.

8.7.11 Setup/Hold Trigger

In setup&hold trigger, you need to set the clock source and data source. The setup time starts when the data signal passes the trigger level and ends at the coming of the specified clock edge; the hold time starts at the coming of the specified clock edge and ends when the data signal crosses the trigger level again, as shown in the figure below. The oscilloscope triggers when the setup time or hold time is smaller than the preset time.

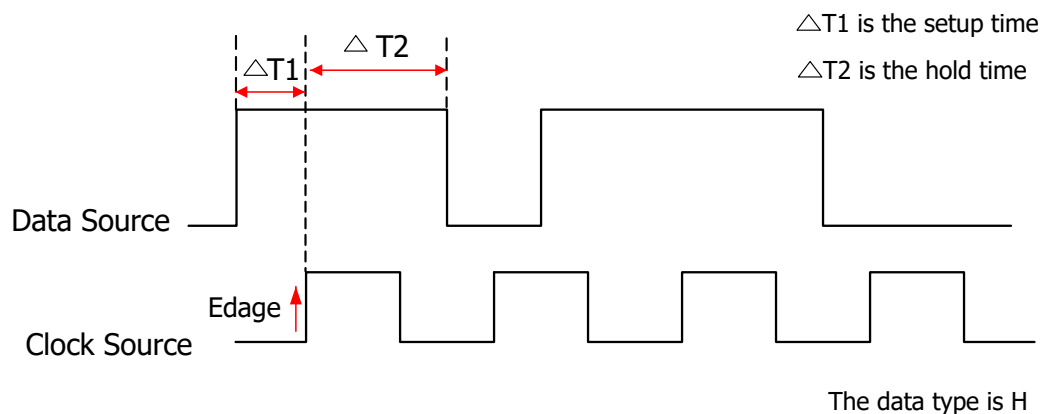
**Figure 8.11 Setup/Hold Trigger****Trigger Type:**

Press **Type**, and then rotate the multifunction knob  to select "Setup/Hold". Press down the knob to select the trigger type. Then, the current trigger setting information is displayed at the upper-right corner of the screen, as shown in the figure below. You can also press **Type** continuously or enable the touch screen to select it.

**Clock Source:**



Press **SCL** to set the signal source of the clock line. It can be set to CH1-CH4 or D0-D15. For details, refer to descriptions in "*Trigger Source*". The current clock source (trigger source) is displayed at the upper-right corner of the screen.

NOTE

Only when we select the channel (that has been input with signals) as the clock source, can we obtain a stable trigger.



Edge Type:

Press **Slope** to select the desired clock edge type. It can be set to "Rising"  or "Falling" .

Data Source:

Press **SDA** to set the signal source of the data line. It can be set to CH1-CH4 or D0-D15. For details, refer to descriptions in "*Trigger Source*". The current data source (trigger source) is displayed at the upper-right corner of the screen.

**NOTE**



Only when we select the channel (that has been input with signals) as the trigger source, can we obtain a stable trigger.

Data Type:

Press **Data Type** to set the effective pattern of the data signal. It can be set to H (high level) or L (low level).

Trigger Condition:

Press **When**, then rotate the multifunction knob  to select the of Setup/Hold trigger condition, and then press down the knob to select it. You can also press **When** continuously or enable the touch screen to select it.

- **Setup:** the oscilloscope triggers when the setup time is smaller than the specified setup time. After selecting this type, press **Setup**, and then rotate the multifunction knob  or use the pop-up numeric keypad to set the setup time.
- **Hold:** the oscilloscope triggers when the hold time is smaller than the specified hold time. After selecting this type, press **Hold**, and then rotate the multifunction knob  or use the pop-up numeric keypad to set the hold time.
- **Setup/Hold:** the oscilloscope triggers when the setup time or hold time smaller than the specified time value. After selecting this type, press **Setup** and **Hold** respectively, then rotate the multifunction knob  or use the pop-up numeric keypad to set the setup and hold time.

Trigger Mode:

In the trigger control area (Trigger) on the front panel, press  to quickly switch the current trigger mode. For details, refer to descriptions in "*Trigger Mode*".

Trigger Parameter Setting:

Sets the trigger parameter (noise rejection) under this trigger type. For details, refer to descriptions in "*Noise Rejection*".

Trigger LEVEL/Threshold Level:

Rotate the **Trigger**  **LEVEL** knob to adjust the trigger level/ threshold level. Please refer to descriptions in "*Trigger LEVEL/Threshold Level*". The current trigger level/ threshold level is displayed at the upper-right corner of the screen.

8.7.12 Nth Edge Trigger

Triggers on the Nth edge that appears after the specified idle time. For example, in the waveform shown in the figure below, the instrument should trigger on the second rising edge after the specified idle time (the time between two neighboring rising edges), and the idle time should be within the range between P and M ($P < \text{Idle Time} < M$). Wherein, M is the time between the first rising edge and its previous rising edge; P is the maximum time between the rising edges that participate in counting.

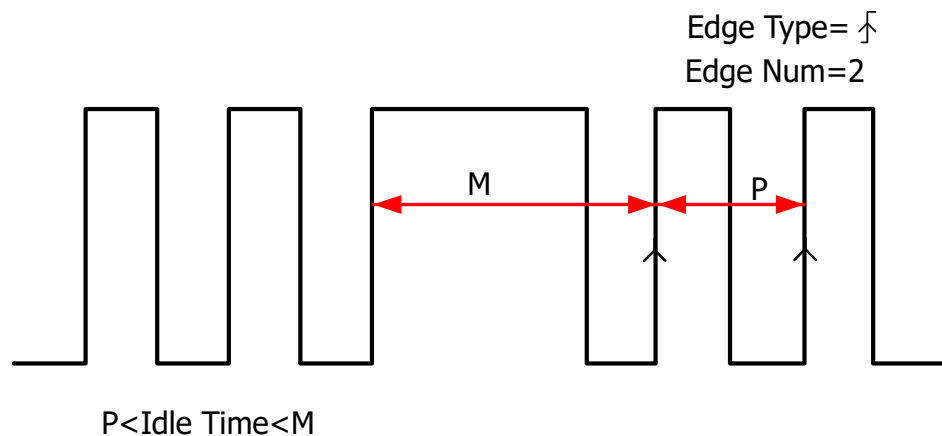

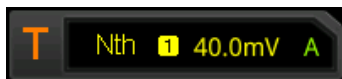

Figure 8.12 Nth Edge Trigger

Trigger Type:

Press **Type**, and then rotate the multifunction knob  to select "Nth Edge". Press down the knob to select the trigger type. Then, the current trigger setting information is displayed at the upper-right corner of the screen, as shown in the figure below. You can also press **Type** continuously or enable the touch screen to select it.



Source Selection:

Press **Source** to open the signal source list and select CH1-CH4 or D0-D15. For details, refer to descriptions in "*Trigger Source*". The current trigger source is displayed at the upper-right corner of the screen.





NOTE

Only when we select the channel (that has been input with signals) as the trigger source, can we obtain a stable trigger.

Edge Type:

Press **Slope** to select the input signal edge on which the oscilloscope triggers.

-  Rising: triggers on the rising edge of the input signal when the voltage level meets the specified trigger level.
-  Falling: triggers on the falling edge of the input signal when the voltage level meets the specified trigger level.

Idle Time:

Press **Idle Time**, then use the pop-up numeric keypad to set the idle time before the edge counting in Nth edge trigger. Rotate the multifunction knob  or use the pop-up numeric keypad to set the idle time.

Edge Count:

Press **Edges** to set the value of "N" in Nth edge trigger. Rotate the multifunction knob  or use the pop-up numeric keypad to set the edge count. The available range is from 1 to 65,535.

Trigger Mode:

In the trigger control area (Trigger) on the front panel, press  to quickly switch the current trigger mode. For details, refer to descriptions in "*Trigger Mode*".

Trigger Parameter Setting:

Sets the trigger parameter (noise rejection) under this trigger type. For details, refer to descriptions in "*Noise Rejection*".

Trigger LEVEL/Threshold Level:

Rotate the **Trigger**  knob to adjust the trigger level/ threshold level. Please refer to descriptions in "*Trigger LEVEL/Threshold Level*". The current trigger level/ threshold level is displayed at the upper-right corner of the screen.

8.7.13 RS232 Trigger (Option)

RS232 bus is a serial communication mode used in data transmission between PCs or between a PC and a terminal. In RS232 serial protocol, a character is transmitted as a frame of data. The frame consists of 1 start bit, 5-8 data bits, 1 check bit, and 1-2 stop bits. Its format is as shown in the figure below. This series oscilloscope triggers when the start frame, error frame, check error, or the specified data of the RS232 signal is detected.

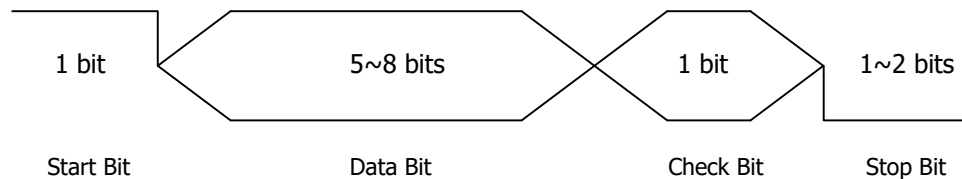

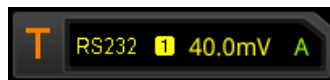

Figure 8.13 Schematic Diagram of RS232 Protocol

Trigger Type:

Press **Type**, and then rotate the multifunction knob  to select "RS232". Press down the knob to select the trigger type. Then, the current trigger setting information is displayed at the upper-right corner of the screen, as shown in the figure below. You can also press **Type** continuously or enable the touch screen to select it.



Source Selection:

Press **Source** to open the signal source list and select CH1-CH4 or D0-D15. For details, refer to descriptions in "*Trigger Source*". The current trigger source is displayed at the upper-right corner of the screen.

NOTE

Only when we select the channel (that has been input with signals) as the trigger source, can we obtain a stable trigger.

Trigger Condition:

Press **When**, then rotate the multifunction knob  to select the the desired trigger condition. Press down the knob to select it. You can also press **When** continuously or enable the touch screen to select it.

- Start: triggers on the start frame position.
- Error: triggers when an error frame is detected.

- Check Error: triggers when a check error is detected.
- Data: triggers on the last bit of the preset data bits. Press **Data**, then rotate the multifunction knob  or use the pop-up numeric keypad to set the data of RS232 trigger.

Data Bits:

Indicate the number of bits per frame. Press **More** > **Data Bits**, then rotate the multifunction knob  to select the desired data bits, and then press down the knob to select it. You can also press **Data Bits** continuously or enable the touch screen to select it. The available data bits include "5 Bits", "6 Bits", "7 Bits", and "8 Bits".



Stop Bit:

Indicates when to stop outputting data. Press **More** > **Stop Bit**, then rotate the multifunction knob  to select the desired stop bit, and then press down the knob to select it. You can also press **Stop Bit** continuously or enable the touch screen to select it. The available stop bits include 1 Bit, 1.5 Bits, and 2 Bits.

Parity:

Used to verify whether data are properly transmitted. Press **More** > **Parity**, and rotate the multifunction knob  to select the desired parity mode. Then press down the knob to select it. You can also press **Parity** continuously or enable the touch screen to select it. The available parity modes include "None", "Even", and "Odd".

Polarity

Press **Polarity** continuously to select the polarity of data transmission. It can be set to "Pos"  or "Neg" .

Baud Rate:

Sets the baud rate of data transmission (i.g. specifies a clock frequency). Three setting methods are available for baud rate:

- Press **Baud Rate**, then set the user-defined baud rate with the displayed numeric keypad.
- Press **Baud Rate**, then select the preset baud rate from the drop-down list. The available baud rates include 50 bps, 75 bps, 110 bps, 134 bps, 150 bps, 300 bps, and etc.
- Press **Baud Rate**, then rotate the multifunction knob  to adjust the baud rate at a small step of 1 bps.

Trigger Mode:

In the trigger control area (Trigger) on the front panel, press  to quickly switch the current trigger mode. For details, refer to descriptions in "*Trigger Mode*".

Trigger Parameter Setting:

Sets the trigger parameter (noise rejection) under this trigger type. For details, refer to descriptions in "*Noise Rejection*".

Trigger LEVEL/Threshold Level:

Rotate the **Trigger**  **LEVEL** knob to adjust the trigger level/ threshold level. Please refer to descriptions in "*Trigger LEVEL/Threshold Level*". The current trigger level/ threshold level is displayed at the upper-right corner of the screen.

8.7.14 I2C Trigger (Option)

I2C is a 2-wire serial bus used to connect the microcontroller and its peripheral device. It is a bus standard widely used in the microelectronic communication control field.

The I2C serial bus consists of SCL and SDA. Its transmission rate is determined by SCL, and its transmission data is determined by SDA, as shown in the figure below. This series oscilloscope triggers on the start condition, restart, stop, missing acknowledgment, specific device address, or data value. Besides, it can also trigger on the specific device address and data values at the same time.

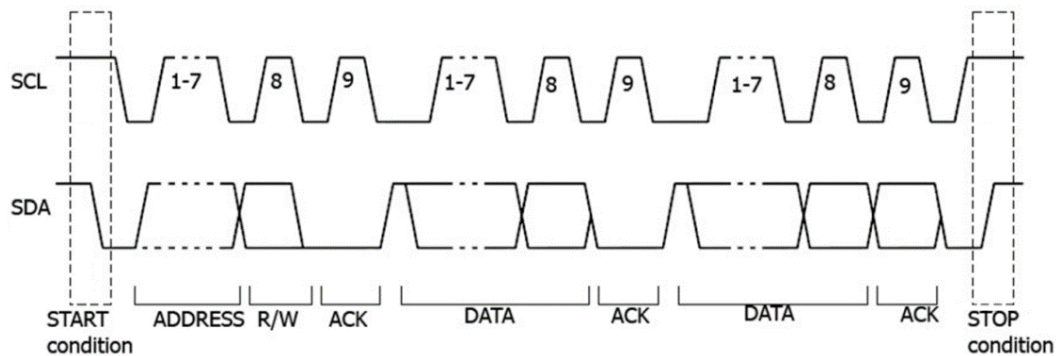

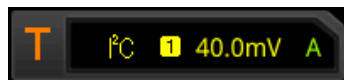

Figure 8.14 Schematic Diagram of I2C Protocol

Trigger Type:

Press **Type**, and then rotate the multifunction knob  to select "I2C". Press down the knob to select the trigger type. Then, the current trigger setting information is displayed at the upper-right corner of the screen, as shown in the figure below. You can also press **Type** continuously or enable the touch screen to select it.



Source Selection:

Press **SCL** and **SDA** to specify the sources of SCL and SDA respectively. They can be set to CH1-CH4 or D0-D15. For details, refer to descriptions in "*Trigger Source*". The current trigger source is displayed at the upper-right corner of the screen.





NOTE

Only when we select the channel (that has been input with signals) as the trigger source, can we obtain a stable trigger.

Trigger Condition:

Press **When**, then rotate the multifunction knob  to select the the desired trigger condition. Press down the knob to select it. You can also press **When** continuously or enable the touch screen to select it.

- Start: triggers when SDA data transitions from high level to low level while SCL is high level.
- Stop: triggers when SDA data transitions from low level to high level while SCL is high level.
- Restart: triggers when another start condition occurs before a stop condition.
- MissedAck: triggers when the SDA data is high level during any acknowledgment of SCL clock position.
- Address: the trigger searches for the specified address value. When this event occurs, the oscilloscope will trigger on the read/write bit. After this trigger condition is selected:
 - Press **AddrBits**, then rotate the multifunction knob  to select the desired address bits, and then press down the knob to select it. You can also press **AddrBits** continuously or enable the touch screen to select it. The available address bits are "7 Bits", "8 Bits", and "10 Bits".
 - Press **Address**, then rotate the multifunction knob  or use the pop-up numeric keypad to set the address of I2C trigger.
 - Press **More** > **Direction** to select "Read", "Write" or "R/W".

NOTE

This setting is not available when **AddrBits** is set to "8 Bits".

- Data: the trigger searches for the specified data value on the data line (SDA). When this event occurs, the oscilloscope will trigger on the clock line (SCL) transition edge of the last bit of data. After this trigger condition is selected:
 - Press **Bit X**, and set the current bit with the following two methods.

Method 1: First rotate the multifunction knob  to switch to the data bit that needs to be operated on. Then press down the knob continuously to set the current bit. As shown in the figure below, the left is its binary format, and the right is its corresponding Hex format.



Method 2: Press **Bit X** or enable the touch screen to select the data bit. Then set it with the pop-up virtual keypad. For setting methods, refer to descriptions in "*Pattern Trigger*". If you modify the binary data bit, a virtual keypad as shown in *Figure 8.15* is displayed. If you modify the hex data bit, a virtual keypad as shown in *Figure 8.16* is displayed.



Figure 8.15 Virtual Keypad for Binary Data Bit

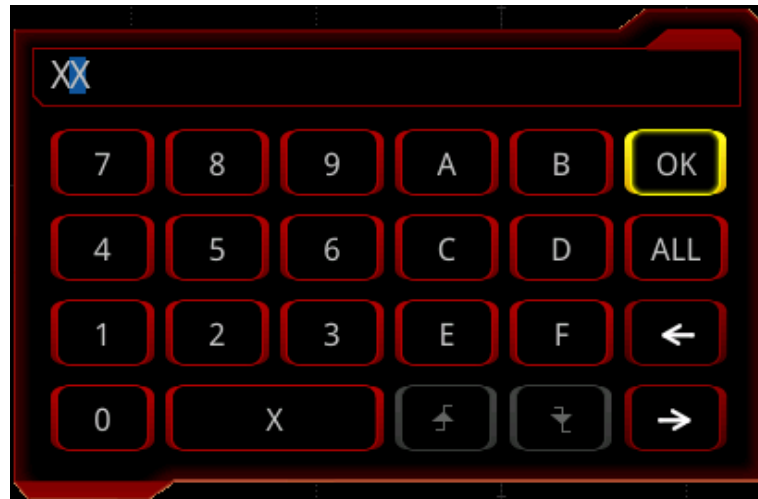





Figure 8.16 Virtual Keypad for Hex Data Bit

- Press **Bytes**, then rotate the multifunction knob  or use the pop-up numeric keypad to set the length of the data. Its range is from 1 to 5.
- Press **More** > **Addr Bits**, then rotate the multifunction knob  to select the desired address bits, and then press down the knob to select it. You can also press **Addr Bits** continuously or enable the touch screen to select it. The available address bits are "7 Bits", "8 Bits", and "10 Bits".
- A&D: the oscilloscope searches for the specified address and data at the same time, then triggers when both the address and data meet the conditions. After this condition is selected, you need to set the sub-menu items such as **Bit X**, **Bytes**, **Addr Bits**, **Address**, and **Direction**. For the setting methods, refer to descriptions in "Address" and "Data" conditions.

Trigger Mode:

In the trigger control area (Trigger) on the front panel, press  to quickly switch the current trigger mode. For details, refer to descriptions in "*Trigger Mode*".

Trigger Parameter Setting:

Sets the trigger parameter (noise rejection) under this trigger type. For details, refer to descriptions in "*Noise Rejection*".

Trigger LEVEL/Threshold Level:

Rotate the **Trigger**  **LEVEL** knob to adjust the trigger level/ threshold level. Please refer to descriptions in "*Trigger LEVEL/Threshold Level*". The current trigger level/ threshold level is displayed at the upper-right corner of the screen.

8.7.15 SPI Trigger (Option)

In SPI trigger, after the CS or timeout condition is satisfied, the oscilloscope triggers when the specified data is found. When using SPI trigger, you need to specify the CLK clock sources and MISO data sources.

Below is the sequential chart of SPI bus.

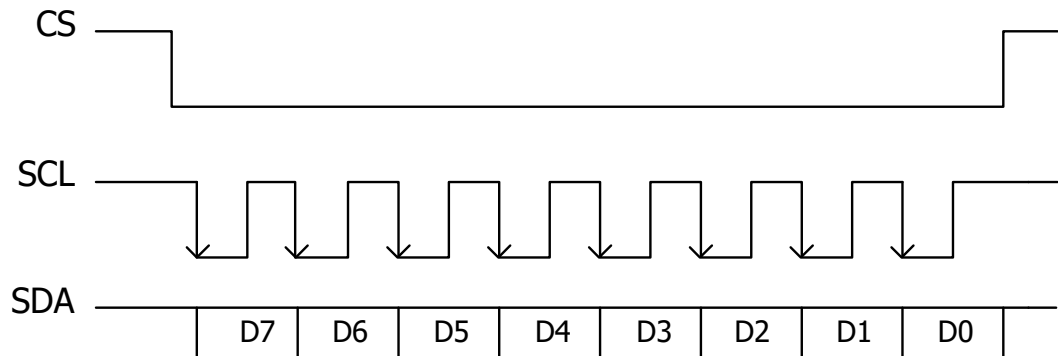

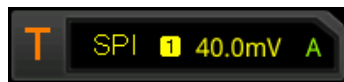

Figure 8.17 Sequential Chart of SPI Bus

Trigger Type:

Press **Type**, and then rotate the multifunction knob  to select "SPI". Press down the knob to select the trigger type. Then, the current trigger setting information is displayed at the upper-right corner of the screen, as shown in the figure below. You can also press **Type** continuously or enable the touch screen to select it.



Source Selection:



Press **CLK** and **MISO** to specify the sources of CLK and MISO respectively. They can be set to CH1-CH4 or D0-D15. For details, refer to descriptions in "[Trigger Source](#)". The current trigger source is displayed at the upper-right corner of the screen.

NOTE

Only when we select the channel (that has been input with signals) as the trigger source, can we obtain a stable trigger.

Edge Type:



Press **Slope** continuously to select the desired clock edge type. Press down the knob to select it.

-  Rising: samples the MISO data on the rising edge of the clock.
-  Falling: samples the MISO data on the falling edge of the clock.

Trigger Condition:



Press **When** continuously to select the desired trigger condition.

- Timeout: the oscilloscope starts to search for the data (MISO) on which to trigger after the clock signal (CLK) stays in the idle state for a specified period of time. After selecting this condition, you can press **Timeout**, then rotate the multifunction knob  or use the pop-up numeric keypad to set the idle time. The range is from 8 ns to 10 s.
- With CS: if the CS signal is valid, the oscilloscope will trigger when the data (SDA) satisfying the trigger conditions is found.
 - After selecting this condition, you can press **CS** select the chip selection signal line. The available channels are CH1-CH4 and D0-D15. For details, refer to descriptions in "*Trigger Source*". The current trigger source is displayed at the upper-right corner of the screen.
 - Press **More** > **CS Mode** to set the current CS mode to "Pos " (high level is valid) or "Neg " (low level is valid).

Current Bit:

Press **More** > **Bit X** to set the data bit that needs to be operated on. For setting methods, refer to descriptions in "*I2C Trigger (Option)*".

Data Bits:

Press **More** > **DataBits**, then rotate the multifunction knob  or use the pop-up numeric keypad to set the number of bits in the serial data string. The number of bits in the string can be set to any integer ranging from 4 to 32.

Trigger Mode:

In the trigger control area (Trigger) on the front panel, press  to quickly switch the current trigger mode. For details, refer to descriptions in "*Trigger Mode*".

Trigger Parameter Setting:

Sets the trigger parameter (noise rejection) under this trigger type. For details, refer to descriptions in "*Noise Rejection*".

Trigger LEVEL/Threshold Level:

Rotate the **Trigger**  **LEVEL** knob to adjust the trigger level/ threshold level. Please refer to descriptions in "*Trigger LEVEL/Threshold Level*". The current trigger level/ threshold level is displayed at the upper-right corner of the screen.

8.7.16 CAN Trigger (Option)

This oscilloscope can trigger on the start of a frame, end of a frame, frame of the specified type (e.g. Remote, Overload, Data, etc.), or error frame of the specified type (e.g. Answer Error, Check Error, Format Error, etc.) of the CAN signal.

The data frame format of the CAN bus is as shown in the figure below.

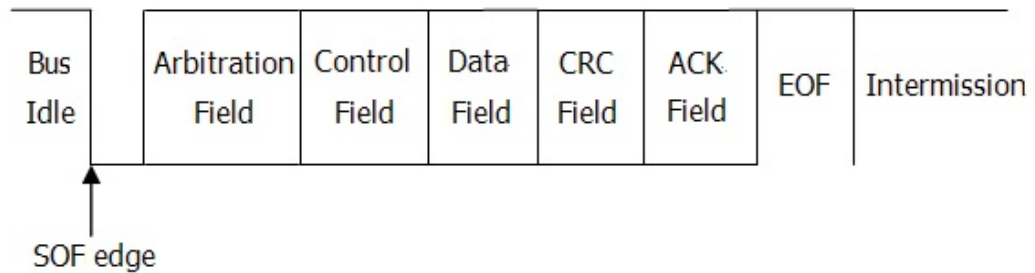

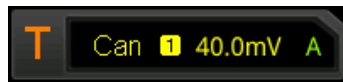

Figure 8.18 Data Frame Format of the CAN Bus

Trigger Type:

Press **Type**, and then rotate the multifunction knob  to select "CAN". Press down the knob to select the trigger type. Then, the current trigger setting information is displayed at the upper-right corner of the screen, as shown in the figure below. You can also press **Type** continuously or enable the touch screen to select it.



Source Selection:

Press **Source** to open the signal source list and select CH1-CH4 or D0-D15. For details, refer to descriptions in "*Trigger Source*". The current trigger source is displayed at the upper-right corner of the screen.

NOTE

Only when we select the channel (that has been input with signals) as the trigger source, can we obtain a stable trigger.

Trigger Condition:

Press **When** to select the desired trigger condition.

- SOF: triggers at the start of a frame.
- EOF: triggers at the end of a frame.
- Remote ID: triggers on the specified ID of Remote frame. Set the following parameters:
 - Press **Extend ID** to enable or disable the extended ID.

- Press **Bit X** to set the data bit that needs to be operated. For setting methods, refer to descriptions in "*I2C Trigger (Option)*".
- Overload: triggers on the overload frames.
- Frame ID: triggers on the data frames with the specified ID. Set the following parameters:
 - Press **Extend ID** to enable or disable the extended ID.
 - Press **Bit X** to set the data bit that needs to be operated. For setting methods, refer to descriptions in "*I2C Trigger (Option)*".
- Frame Data: triggers on the data frames with the specified Data. Set the following parameters:
 - Press **Bit X** to set the data bit that needs to be operated. For setting methods, refer to descriptions in "*I2C Trigger (Option)*".
 - Press **Bytes**, then rotate the multifunction knob  or use the numeric keypad to set the length of the data. Its range is from 1 to 8.
- Data & ID: triggers on the data frames with the specified ID and data. Set the following parameters:
 - Press **Define** to select "Data" or "ID".
 - When you select "Data", set **Bit X** and **Bytes**. For detailed settings, refer to parameter settings for "Frame Data".
 - When you select "ID", set **Extended ID** and **Bit X**. For detailed settings, refer to parameter settings for "Frame ID".
- Frame Error: triggers on the error frame.
- Bit Fill: triggers on the error frame with the bit fill.
- Answer Error: triggers on the answer error frame.
- Check Error: triggers on the check error frame.
- Format Error: triggers on the format error frame.
- Random Error: triggers on the random error frame, such as the format error frame, answer error frame, etc.



Signal Type:

Press **More** > **Signal Type** to select the desired signal type.

- CAN_H: indicates the actual CAN_H bus signal.
- CAN_L: indicates the actual CAN_L bus signal.
- TX/RX: indicates the Transmit signal and Receive signal from the CAN bus transceiver.
- DIFF: indicates the CAN differential bus signals connected to an analog channel by using a differential probe. Connect the differential probe's positive lead to the CAN_H bus signal and connect the negative lead to the CAN_L bus signal.

Baud Rate:

Press **More** > **Baud** to set the baud rate. Three methods are available for setting the baud rate:

- Press **Baud**, then set the user-defined baud rate with the displayed numeric keypad.
- Press **Baud**, then rotate the multifunction knob  to select the preset baud rate from the available options. The available baud rates include 10 kb/s, 20 kb/s, 33.3 kb/s, 50 kb/s, 62.5 kb/s, 83.3 kb/s, and etc.
- Press **Baud**, then rotate the multifunction knob  to adjust the baud rate at a small step. The step size is different for adjusting different baud rates.

Sample Position

Sample position is a point within a bit's time. The oscilloscope samples the bit level at this point. The sample position is represented by the proportion of "the time from the start of the bit to the sample position" to the "bit time", as shown in the figure below.

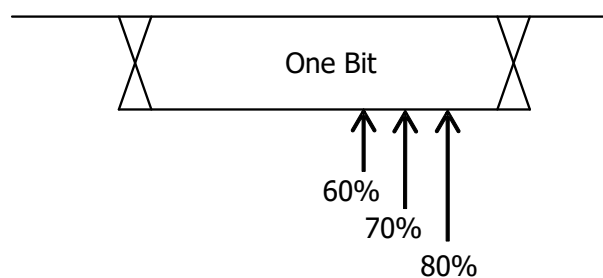



Figure 8.19 Sample Position

Press **More** > **Sample Position**, then rotate the multifunction knob  or use the pop-up numeric keypad to set the sample position. The settable range is from 10% to 90%.

Trigger Mode:

In the trigger control area (Trigger) on the front panel, press  to quickly switch the current trigger mode. For details, refer to descriptions in "*Trigger Mode*".

Trigger Parameter Setting:

Sets the trigger parameter (noise rejection) under this trigger type. For details, refer to descriptions in "*Noise Rejection*".

Trigger LEVEL/Threshold Level:

Rotate the **Trigger**  **LEVEL** knob to adjust the trigger level/ threshold level. Please refer to descriptions in "*Trigger LEVEL/Threshold Level*". The current trigger level/ threshold level is displayed at the upper-right corner of the screen.

8.7.17 FlexRay Trigger (Option)

This series oscilloscope can trigger on the specified frame, symbol, error, or position of the FlexRay bus.

FlexRay is a type of differential serial bus configured with three consecutive segments (i.g. packet header, payload, and packet trailer). Its data transmission rate is up to 10 Mb/s. Each frame contains a static segment and a dynamic segment, and ends with the bus idle time.

Its format is as shown in the figure below.

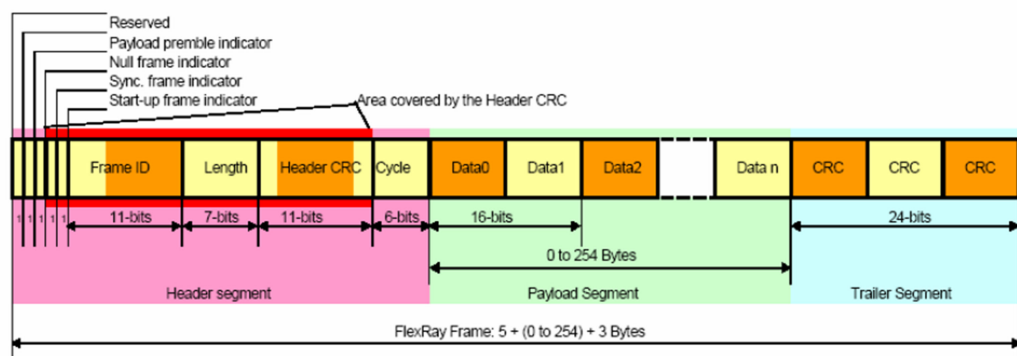



Figure 8.20 Frame Format of FlexRay Bus

Trigger Type:

Press **Type**, and then rotate the multifunction knob  to select "FlexRay". Press down the knob to select the trigger type. Then, the current trigger setting information is

displayed at the upper-right corner of the screen, as shown in the figure below. You can also press **Type** continuously or enable the touch screen to select it.



Source Selection:

Press **Source** to open the signal source list and select CH1-CH4 or D0-D15. For details, refer to descriptions in "*Trigger Source*". The current trigger source is displayed at the upper-right corner of the screen.

NOTE

Only when we select the channel (that has been input with signals) as the trigger source, can we obtain a stable trigger.

Baud Rate:

Press **Baud**, and rotate the multifunction knob  to select a FlexRay baud rate that matches the actual FlexRay bus signal. Press down the knob to select it. You can also press **Baud** continuously or enable the touch screen to select it. The available baud rates are 2.5 Mb/s, 5 Mb/s, and 10 Mb/s.

Trigger Condition:

Press **When**, then rotate the multifunction knob  to select the trigger condition, and then press down the knob to select it. You can also press **When** continuously or enable the touch screen to select it.

- Post: triggers on the specified position of the FlexRay bus. Press **Post** to select "TSS End", "FSS_BSS End", "FES End", or "DTS End".
- Frame: triggers on the frame of FlexRay bus.
 - Press **Frame** to select the frame type. The types of frames include null, Sync, Start, and All.
 - Press **More** > **Define** to select "ID" or "Cyc Count".

When you select "ID", set the following parameters: ID Comp and ID Min. Press **More** > **ID Comp** to select the comparison conditions. The available choices include =, ≠, >, <, ><, <>. Press **More** > **ID Max** or press **More** > **ID Min**, then rotate the multifunction knob  or use the pop-up numeric keypad to set the frame ID.

When you select "Cyc Count", set the following parameters: Cyc Comp and Count Min. Press **More** > **Cyc Comp** to select the comparison conditions. The available choices include =, ≠, >, <, ><, <>. Press **More** > **Count Max**

or press **More** > **Count Min**, then rotate the multifunction knob  or use the pop-up numeric keypad to set the cycle count.

- Symbol: triggers on the CAS/MTS (Collision Avoidance Symbol/Media Access Test Symbol) and WUP (Wakeup Pattern) of FlexRay bus.
 - Press **Symbol** to select the symbol type. The symbol type includes CAS/MTS and WUS.
 - Press **More** > **ID Comp** to select the comparison conditions. The available choices include =, ≠, >, <, ><, <>. Press **More** > **ID Max** or press **More** > **ID Min**, then rotate the multifunction knob  or use the pop-up numeric keypad to set the frame ID.
- Error: triggers when an error occurs to the FlexRay bus. Press **Error** to select the error type. It includes Head CRC Err, Tail CRC Err, Decode Err, and Random Err.

NOTE

As the occurrence possibility of specified FlexRay frame is very low, it is recommended that you set the oscilloscope to "Normal" trigger mode when the trigger condition is set to "Frame", so as to prevent the instrument from triggering automatically while waiting for the specified frame. The same goes for "Error" trigger condition. In addition, when multiple FlexRay errors occur at the same time, you need to adjust the trigger holdoff so as to view the specific error.

Trigger Mode:

In the trigger control area (Trigger) on the front panel, press  to quickly switch the current trigger mode. For details, refer to descriptions in "*Trigger Mode*".

Trigger Parameter Setting:

Sets the trigger parameter (noise rejection) under this trigger type. For details, refer to descriptions in "*Noise Rejection*".

Trigger LEVEL/Threshold Level:

Rotate the **Trigger**  **LEVEL** knob to adjust the trigger level/ threshold level. Please refer to descriptions in "*Trigger LEVEL/Threshold Level*". The current trigger level/ threshold level is displayed at the upper-right corner of the screen.

8.7.18 LIN Trigger (Option)

This oscilloscope can trigger on the sync field of LIN signal, and can also trigger on the specified identifier, data, or frame.

The data frame format of the LIN bus is as shown in the figure below.



Figure 8.21 Data Frame Format of the LIN Bus

Trigger Type:

Press **Type**, and then rotate the multifunction knob  to select "LIN". Press down the knob to select the trigger type. Then, the current trigger setting information is displayed at the upper-right corner of the screen, as shown in the figure below. You can also press **Type** continuously or enable the touch screen to select it.

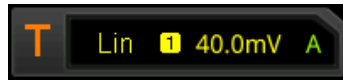

Source Selection:

Press **Source** to open the signal source list and select CH1-CH4 or D0-D15. For details, refer to descriptions in "*Trigger Source*". The current trigger source is displayed at the upper-right corner of the screen.



NOTE



Only when we select the channel (that has been input with signals) as the trigger source, can we obtain a stable trigger.

Trigger Condition:

Press **When**, then rotate the multifunction knob  to select the trigger condition, and then press down the knob to select it.

You can also press **When** continuously or enable the touch screen to select it.

- Sync: triggers on the last bit of the sync field.
- ID: triggers when the frames with the specified ID are found. Press **ID**, then rotate the multifunction knob  or use the pop-up numeric keypad to set ID.
- Data: triggers when the data that meet the preset conditions are found.
 - Press **Bit X** to set the data bit that needs to be operated. For setting methods, refer to descriptions in "*I2C Trigger (Option)*".
 - Press **Bytes**, then rotate the multifunction knob  or use the pop-up numeric keypad to set the length of the data. Its range is from 1 to 8.



- Data&ID: triggers when the frames with the specified ID and data that meet the preset conditions are both found.
 - Press **Bit X** to set the data bit that needs to be operated. For setting methods, refer to descriptions in "*I2C Trigger (Option)*".
 - Press **Bytes**, then rotate the multifunction knob  or use the pop-up numeric keypad to set the length of the data. Its range is from 1 to 8.
 - Press **ID**, then rotate the multifunction knob  or use the pop-up numeric keypad to set ID.
- Sleep: triggers when the sleep frame is found.
- Wakeup: triggers when the wakeup frame is found.
- Error: triggers on the specified type of error frame. Press **Error Type** to select the error type: Sync, Even Odd, or Check Sum.

Protocol Version:

Press **More** > **Version**, select the protocol version that matches the signal under test. The available versions include 1.X, 2.X and Both.

Baud Rate:

Press **More** > **Baud** to set the baud rate. Three methods are available for setting the rate:

- Press **Baud**, then set the user-defined baud rate with the displayed numeric keypad.
- Press **Baud**, then rotate the multifunction knob  to select the preset baud rate from the available options. The available baud rates include 1.2 kbps, 2.4 kbps, 4.8 kbps, 9.6 kbps, 19.2 kbps, and etc.
- Press **Baud**, then rotate the multifunction knob  to adjust the baud rate at a small step.

Sample Position

Sample position is a point within a bit's time. The oscilloscope samples the bit level at this point. The sample position is represented by the proportion of "the time from the start of the bit to the sample point" to the "bit time", as shown in the figure below.

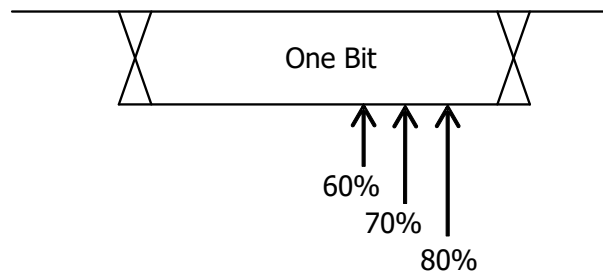



Figure 8.22 Sample Position

Press **More** > **Sample Position**, then rotate the multifunction knob  or use the pop-up numeric keypad to set the sample position. The settable range is from 10% to 90%.

Trigger Mode:

In the trigger control area (Trigger) on the front panel, press  to quickly switch the current trigger mode. For details, refer to descriptions in "*Trigger Mode*".

Trigger Parameter Setting:

Sets the trigger parameter (noise rejection) under this trigger type. For details, refer to descriptions in "*Noise Rejection*".

Trigger LEVEL/Threshold Level:

Rotate the **Trigger**  **LEVEL** knob to adjust the trigger level/ threshold level. Please refer to descriptions in "*Trigger LEVEL/Threshold Level*". The current trigger level/ threshold level is displayed at the upper-right corner of the screen.

8.7.19 I2S Trigger (Option)

In I2S trigger, the oscilloscope searches for the specified data value and take it as the condition for identifying the trigger. You need to specify the serial clock line (SCLK, 1 pulse is found on the clock line once 1 bit of digital audio data is sent), frame clock line (WS, used for switch the audio channel data), and serial data line (SDA, used for transmit audio data represented in binary (2's complement)).

Below is the sequential chart of I2S bus.

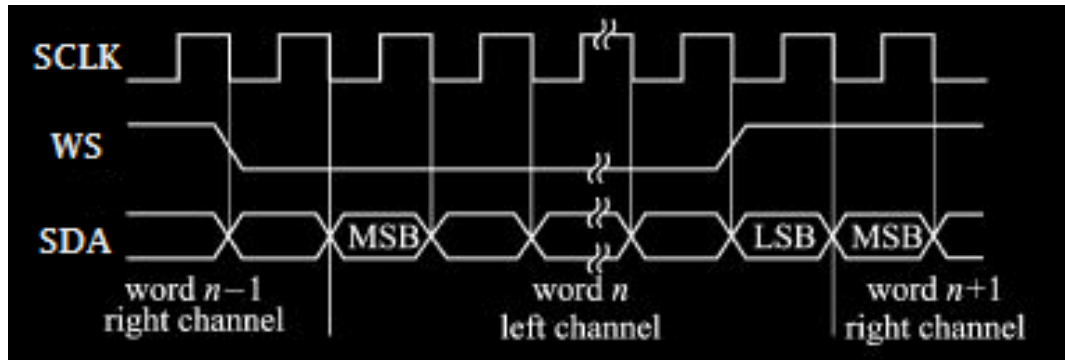

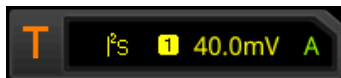

Figure 8.23 Sequential Chart of I2S Bus

Trigger Type:

Press **Type**, and then rotate the multifunction knob  to select "I2S". Press down the knob to select the trigger type. Then, the current trigger setting information is displayed at the upper-right corner of the screen, as shown in the figure below. You can also press **Type** continuously or enable the touch screen to select it.



Source Selection:



Press **SCLK**, **WS**, and **SDA** to specify the sources for SCLK, WS, and SDA. The available choices are CH1-CH4, EXT, or D0-D15. For details, refer to descriptions in "[Trigger Source](#)". The current trigger source is displayed at the upper-right corner of the screen.

NOTE

Only when we select the channel (that has been input with signals) as the trigger source, can we obtain a stable trigger.

Edge Type:

Press **SCLK Edge**, then rotate the multifunction knob  to select the desired clock edge type. Press down the knob to select it.

-  Rising: samples the SDA data on the rising edge of the clock.
-  Falling: samples the SDA data on the falling edge of the clock.

Audio:

Press **Audio** continuously or rotate the multifunction knob  to select the audio channel. The available choices include "Left", "Right", and "Either".

Trigger Condition:

Press **More** > **When**, then rotate the multifunction knob  to select the trigger condition, and then press down the knob to select it. You can also press **When** continuously or enable the touch screen to select it.

- **=**: triggers when the channel's data value equals the set data value. Press **Data** to set the data bit. For setting methods, refer to descriptions in "*I2C Trigger (Option)*".
- **≠**: triggers when the channel's data value does not equal the set data value. Press **Data** to set the data bit. For setting methods, refer to descriptions in "*I2C Trigger (Option)*".
- **<**: triggers when the channel's data value is smaller than the set data value. Press **Data Max** to set the upper limit of the data bit. For setting methods, refer to descriptions in "*I2C Trigger (Option)*".
- **>**: triggers when the channel's data value is greater than the set data value. Press **Data Min** to set the lower limit of the data bit. For setting methods, refer to descriptions in "*I2C Trigger (Option)*".
- **> <**: triggers when the channel's data value is smaller than the upper limit of the data value and greater than the lower limit of the data value. Press **Data Max** and **Data Min** to set the upper limit and lower limit of the data bit respectively. For setting methods, refer to descriptions in "*I2C Trigger (Option)*".
- **< >**: triggers when the channel's data value is greater than the upper limit of the data value and smaller than the lower limit of the data value. Press **Data Max** and **Data Min** to set the upper limit and lower limit of the data bit respectively. For setting methods, refer to descriptions in "*I2C Trigger (Option)*".

Width:

Press **More** > **Width**, then rotate the multifunction knob  or use the pop-up numeric keypad to set the width. Its range is from 4 to 32.

User Width:

Press **More** > **User Width**, then rotate the multifunction knob  or use the pop-up numeric keypad to set the user width. Its range is from 4 to 32.

**NOTE**

The user width is smaller than or equal to the width.

Alignment:

Press **More** > Alignment, and rotate the multifunction knob  to select the alignment way for data signal. You can also press **Alignment** continuously or enable the touch screen to select it.

I2S: MSB (Most Significant Bit) of data for each sample is sent first, and LSB (Least Significant Bit) is sent last. The MSB appears on the SDA line one bit clock after the edge of the WS transition.

LJ: data transmission (MSB first) begins at the edge of the WS transition.

RJ: data transmission (MSB first) is right-justified to the WS transition.

Trigger Mode:

In the trigger control area (Trigger) on the front panel, press  to quickly switch the current trigger mode. For details, refer to descriptions in "*Trigger Mode*".

Trigger Parameter Setting:

Sets the trigger parameter (noise rejection) under this trigger type. For details, refer to descriptions in "*Noise Rejection*".

Trigger LEVEL/Threshold Level:

Rotate the **Trigger**  **LEVEL** knob to adjust the trigger level/ threshold level. Please refer to descriptions in "*Trigger LEVEL/Threshold Level*". The current trigger level/ threshold level is displayed at the upper-right corner of the screen.

8.7.20 MIL-STD-1553 Trigger (Option)

1553B is the abbreviation for the MIL-STD-1553 bus. This oscilloscope can trigger on the sync field of 1553B bus, and can also trigger on the specified data word, command word, status word, or error type.

The command word, data word, and status word format of the 1553B bus is as shown in the figure below.

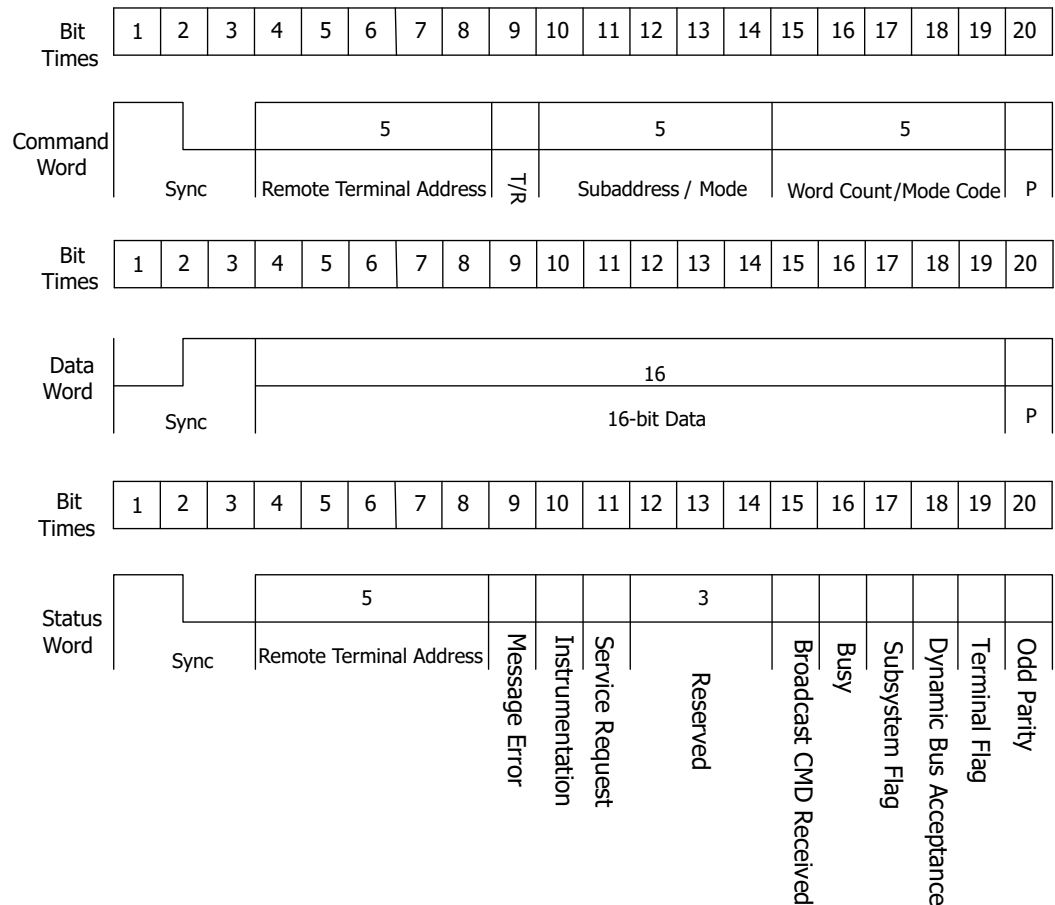



Figure 8.24 Formats of the Command Word, Data Word, and Status Word of the 1553B Bus

Trigger Type:

Press **Type**, and then rotate the multifunction knob  to select "MIL-STD-1553". Press down the knob to select the trigger type. Then, the current trigger setting information is displayed at the upper-right corner of the screen, as shown in the figure below. You can also press **Type** continuously or enable the touch screen to select it.



Source Selection:

Press **Source** to open the signal source list and select CH1-CH4. For details, refer to descriptions in "*Trigger Source*". The current trigger source is displayed at the upper-right corner of the screen.

NOTE

Only when we select the channel (that has been input with signals) as the trigger source, can we obtain a stable trigger.



Trigger Condition:

Press **When**, then rotate the multifunction knob  to select the trigger condition, and then press down the knob to select it.

You can also press **When** continuously or enable the touch screen to select it.

- Sync: triggers on the specified sync type. After this trigger condition is selected, press **Sync** to select the desired sync type: Data Sync, Cmd/Status Sync, or All Sync.
- Data: triggers on the specified data word. After this trigger condition is selected, press **Comp** to select the comparison conditions. The available choices include =, ≠, >, <, ><, and <>.
 - =: triggers when the channel's data word equals the set data word. Press **Min** to set the lower limit of the data word. For setting methods, refer to descriptions in "*I2C Trigger (Option)*".
 - ≠: triggers when the channel's data word does not equal the set data word. Press **Min** to set the lower limit of the data word. For setting methods, refer to descriptions in "*I2C Trigger (Option)*".
 - <: triggers when the channel's data word is smaller than the set data word. Press **Max** to set the upper limit of the data word. For setting methods, refer to descriptions in "*I2C Trigger (Option)*".
 - >: triggers when the channel's data word is greater than the set data word. Press **Min** to set the lower limit of the data word. For setting methods, refer to descriptions in "*I2C Trigger (Option)*".
 - < >: triggers when the channel's data word is smaller than the upper limit of the data word and greater than the lower limit of the data word. Press **Max** and **Min** to set the upper limit and lower limit of the data word respectively. For setting methods, refer to descriptions in "*I2C Trigger (Option)*".

- > <: triggers when the channel's data word is greater than the upper limit of the data word and smaller than the lower limit of the data word. Press **Max** and **Min** to set the upper limit and lower limit of the data word respectively. For setting methods, refer to descriptions in "*I2C Trigger (Option)*".
- RTA: triggers on the specified remote terminal address. After this trigger condition is selected, press **RTA** to set the remote terminal address. For setting methods, refer to descriptions in "*I2C Trigger (Option)*".
- RTA+11Bit: triggers on the RTA and the remaining 11 bits. After this trigger condition is selected:
 - Press **RTA** to set the remote terminal address. For setting methods, refer to descriptions in "*I2C Trigger (Option)*".
 - Press **Bit time** to set the bit time position value to 0 (low), 1 (high), or X (don't care). For setting methods, refer to descriptions in "*I2C Trigger (Option)*".
- Error: triggers on the specified error type. After this trigger condition is selected, press **Err Type** to select the error type.
 - Sync Error: triggers when an invalid sync pulse is found.
 - Check Error: triggers when the parity bit is incorrect for the data in the word.

Level Selection and Adjustment of Trigger Level:

After the trigger condition setting is completed, you need to adjust the trigger level to correctly trigger the signal and obtain a stable waveform. Press **Level Select** (when "Data" is selected for the trigger condition, press **More** > **Level Select**), then rotate the multifunction knob  to select the desired level type for adjustment, and then press down the knob to select it. You can also press **Level Select** continuously or enable the touch screen to select it.

- Level A: only adjusts the upper limit of the trigger level, and the lower limit of the trigger level remains unchanged.

- Level B: only adjusts the lower limit of the trigger level, and the upper limit of the trigger level remains unchanged.
- Level AB: adjusts the upper and lower limits of the trigger level at the same time, and the trigger level deviation (the difference between the upper limit and lower limit of the trigger level) remains unchanged.



NOTE

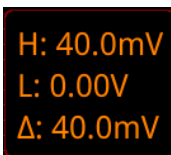

In MIL-STD-1553 trigger, pressing the **Trigger**  **LEVEL** knob can quickly switch the current level adjustment type.

Rotate the **Trigger**  **LEVEL** knob to adjust the corresponding trigger level. During the adjustment of trigger level, two trigger level lines appear on the screen, and they move up and down with the change of the trigger level. At the same time, the real-time trigger level and slope information is displayed at the lower-left corner of the screen (As shown in the figure below, H indicates the upper limit of the trigger level, L indicates the lower limit of the trigger level, and Δ indicates the trigger level deviation). When you stopping modifying the trigger level, the trigger level line and the trigger level information at the lower-left corner of the screen disappear in about 2 s. The current trigger level deviation is displayed at the upper-right corner of the screen.



H: 40.0mV
L: 0.00V
 Δ : 40.0mV

Polarity:

Press **More** > **Polarity** continuously to select the desired polarity. The polarities available are positive polarity  and negative polarity .

Trigger Mode:

In the trigger control area (Trigger) on the front panel, press  to quickly switch the current trigger mode. For details, refer to descriptions in "*Trigger Mode*".

Trigger Parameter Setting:

Sets the trigger parameter (noise rejection) under this trigger type. For details, refer to descriptions in "*Noise Rejection*".

8.8 Zone Trigger

This series oscilloscope supports the zone trigger and provides two rectangle areas: Trigger zone A and Trigger zone B. You can set the trigger conditions to "Intersect" or

"Not intersect". Refer to "*Rectangle Drawing*" to select "Trigger zone A" or "Trigger zone B" to open the zone trigger setting menu. You can also press  > **Analyze** > **Zone trigger** to enter the zone trigger setting menu.

Enable or Disable Trigger zone A or Trigger zone B:

Press **Zone A enable** or **Zone B enable** continuously to enable or disable Trigger zone A or Trigger zone B. You can also refer to "*Rectangle Drawing*" to select "Trigger zone A" or "Trigger zone B" to enable Trigger zone A or Trigger zone B. If both Trigger zone A and Trigger zone B are disabled, then the zone trigger function is disabled. At this time, you must enable either of them to re-enable the zone trigger.

NOTE

If "*XY Mode*" or "*ROLL Mode*" is enabled, the zone trigger function is disabled.

Select Source A or Source B:

Press **Source A** or **Source B**, then rotate the multifunction knob  to select the desired source, and then press down the knob to select it. You can also press **Source A** or **Source B** continuously to select the trigger source; or enable the touch screen to tap the desired trigger source and select it. The available sources include CH1-CH4. The zone name color and the zone color are the same as the color of the selected source channel.

Set the Conditions for Trigger zone A and Trigger zone B:

Press **Zone A** or **Zone B**, then rotate the multifunction knob  to select "Intersect" or "Not intersect", then press down the knob to select it. You can also press **Zone A** or **Zone B** continuously to select the condition; or enable the touch screen to tap the desired condition and select it.

If you enable Zone A, select CH1 as Source A and select "Intersect" as the condition, as shown in the figure below.



If you enable Zone A, select CH1 as Source A and select "Intersect" as the condition, the following figure is displayed.

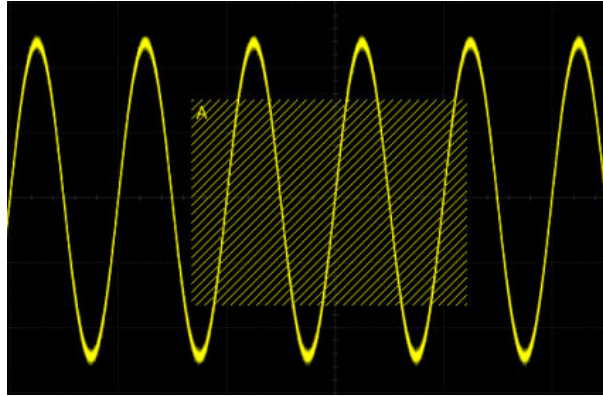

TIP

If you enable both Trigger zone A and Trigger zone B, then perform the "A&&B" operation, and it will become the final trigger condition.

8.9 Trigger Output Connector

The trigger output connector ([TRIG OUT]) on the rear panel of this oscilloscope series can output trigger signals determined by the current setting.

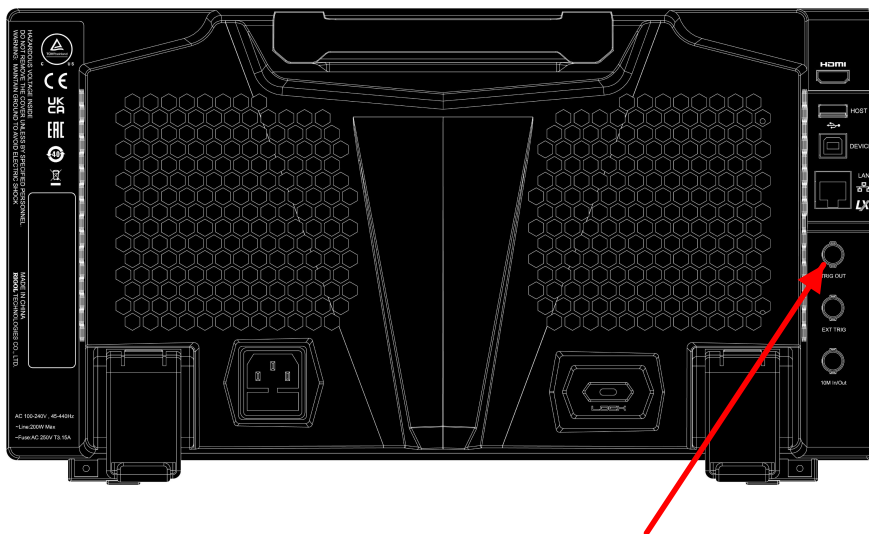

Trigger Output Connector

Figure 8.25 Trigger Output Connector

Press  > **System** > **AUX Out** to select "TrigOut" . A signal which reflects the current capture rate of the oscilloscope can be output from the [TRIG OUT] connector each time a trigger is generated by the oscilloscope. If this signal is

connected to a waveform display device to measure the frequency, the measurement result is the same as the current capture rate.



**NOTE**

If you press  > **System** > **AUX Out** to select "PassFail", then in the pass/fail test, when a pass/fail event is detected, the oscilloscope outputs a pulse from the rear-panel **[TRIG OUT]** connector.

9 Operations and Measurements

MSO8000A can perform math operations, auto measurements, and cursor measurements on sampled and displayed data.

9.1 Math Operation

Press  in the waveform control area (Wave) on the front panel to open the math operation menu. You can also tap the function navigation icon  at the lower-left corner of the screen to open the function navigation. This oscilloscope provides 4 math operations: Math1, Math2, Math3, and Math4. The following section takes Math1 as an example to introduce math operation.

Press  > **Math1** > **Operator** to select the desired math function. Press **Operation** continuously to enable or disable the operation. When enabled, the results of math operation are displayed with purple waveforms on the screen, and the math operation formula, vertical scale, and other parameters (the displayed data parameters are different for different math operations) are displayed at the bottom of the screen. The results of the math operation also allow further measurement. This oscilloscope supports enabling four math operations at the same time, as shown in the figure below.

1	CH1+CH2	5mV	2.5GSa/s
2	CH4+CH1	500mV	2.5GSa/s
3	CH2+CH3	50mV	2.5GSa/s
4	CH1+CH3	20mV	2.5GSa/s

This series of oscilloscope can realize multiple math operations between waveforms of different channels, including

- arithmetic operations (A+B, A-B, A×B, A/B, and Avg)
- FFT operation
- logic operation: A&&B, A||B, A^B, and !A
- function operation: Intg, Diff, Sqrt, Lg, Ln, Exp, Abs, and AX+B (linear function)
- math filter: low-pass filter, high-pass filter, band-pass filter, and band-stop filter

NOTE

When you select the source, only the enabled channel is available.



9.1.1 Addition



Add the waveform voltage values of signal source A and B point by point and display the results.

Press  > **Math1** > **Operator** to select "A+B":

- Press **Operation** continuously to enable or disable the addition operation function.
- Press **SourceA** and **SourceB** respectively, and rotate the multifunction knob  to select the channel for SourceA and SourceB. Then press down the knob to select the channel. You can also press **SourceA** and **SourceB** continuously or enable the touch screen to select the channel. The available channels for SourceA and SourceB are CH1-CH4 and Ref1-Ref10.

NOTE

The source of Math2 can be CH1-CH4, Ref1-Ref10, or Math1; the source of Math3 can be CH1-CH4, Ref1-Ref10, Math1, or Math2; the source of Math4 can be CH1-CH4, Ref1-Ref10, Math1, Math2, or Math3; only the channels that have been enabled currently can be selected.

- Press **Offset** to set the vertical offset of the operation results. For setting methods, refer to the descriptions in "*Parameter Setting Method*". You can also directly rotate **Wave Vertical**  **POSITION** or enable the touch screen to adjust the vertical offset.
- Press **Scale** to set the vertical scale of the operation results. For setting methods, refer to the descriptions in "*Parameter Setting Method*". You can also directly rotate **Wave Vertical**  **SCALE** or enable the touch screen to adjust the vertical Scale.
- Press **More** > **AutoSetting** to adjust the vertical scale and offset of the operation results to the optimal value according to the current configuration for better observation.
- Press **More** > **Invert** to enable or disable the inverted display function of the waveform.
- Press **More** > **Expand** to expand or compress the math operation waveform around the "Center" or "GND".

- Press **More** > **Label** to set the label for math operation results. For details, refer to the descriptions in "*Math Operation Label*".
- Press **More** > **Color Grade** to enable or disable the color grade display of the operation results. When enabled, different colors are displayed on the screen to indicate the times of data acquisition or acquisition probability.
- Press **More** > **Reset ColorGrade** to clear the color grade display and display the color grade again.

9.1.2 Subtraction

Subtract the waveform voltage values of signal source B from that of source A point by point and display the results.

Press  > **Math1** > **Operator** to select "A-B":

- Press **Operation** continuously to enable or disable the subtraction operation function.
- Press **SourceA** and **SourceB** respectively, and rotate the multifunction knob  to select the channel for SourceA and SourceB. Then press down the knob to select the channel. You can also press **SourceA** and **SourceB** continuously or enable the touch screen to select the channel. The available channels for SourceA and SourceB are CH1-CH4 and Ref1-Ref10.

NOTE

The source of Math2 can be CH1-CH4, Ref1-Ref10, or Math1; the source of Math3 can be CH1-CH4, Ref1-Ref10, Math1, or Math2; the source of Math4 can be CH1-CH4, Ref1-Ref10, Math1, Math2, or Math3; only the channels that have been enabled currently can be selected.

- Press **Offset** to set the vertical offset of the operation results. For setting methods, refer to the descriptions in "*Parameter Setting Method*". You can also directly rotate **Wave Vertical**  **POSITION** or enable the touch screen to adjust the vertical offset.
- Press **Scale** to set the vertical scale of the operation results. For setting methods, refer to the descriptions in "*Parameter Setting Method*". You can also directly

rotate **Wave Vertical**  **SCALE** or enable the touch screen to adjust the vertical Scale.

- Press **More** > **AutoSetting** to adjust the vertical scale and offset of the operation results to the optimal value according to the current configuration for better observation.
- Press **More** > **Invert** to enable or disable the inverted display function of the waveform.
- Press **More** > **Expand** to expand or compress the math operation waveform around the "Center" or "GND".
- Press **More** > **Label** to set the label for math operation results. For details, refer to descriptions in "*Math Operation Label*".
- Press **More** > **Color Grade** to enable or disable the color grade display of the operation results. When enabled, different colors are displayed on the screen to indicate the times of data acquisition or acquisition probability.
- Press **More** > **Reset ColorGrade** to clear the color grade display and display the color grade again.

9.1.3 Multiplication



Multiply the waveform voltage values of signal source A and B point by point and display the results.

Press  > **Math1** > **Operator** to select "A×B":

- Press **Operation** continuously to enable or disable the multiplication operation function.
- Press **SourceA** and **SourceB** respectively, and rotate the multifunction knob  to select the channel for SourceA and SourceB. Then press down the knob to select the channel. You can also press **SourceA** and **SourceB** continuously or enable the touch screen to select the channel. The available channels for SourceA and SourceB are CH1-CH4 and Ref1-Ref10.

NOTE

The source of Math2 can be CH1-CH4, Ref1-Ref10, or Math1; the source of Math3 can be CH1-CH4, Ref1-Ref10, Math1, or Math2; the source of Math4 can be CH1-CH4, Ref1-

- Ref10, Math1, Math2, or Math3; only the channels that have been enabled currently can be selected.
- Press **Offset** to set the vertical offset of the operation results. For setting methods, refer to the descriptions in "*Parameter Setting Method*". You can also directly rotate **Wave Vertical**  **POSITION** or enable the touch screen to adjust the vertical offset.
 - Press **Scale** to set the vertical scale of the operation results. For setting methods, refer to the descriptions in "*Parameter Setting Method*". You can also directly rotate **Wave Vertical**  **SCALE** or enable the touch screen to adjust the vertical Scale.
 - Press **More** > **AutoSetting** to adjust the vertical scale and offset of the operation results to the optimal value according to the current configuration for better observation.
 - Press **More** > **Invert** to enable or disable the inverted display function of the waveform.
 - Press **More** > **Expand** to expand or compress the measurement waveform around the "Center" or "GND".
 - Press **More** > **Label** to set the label for math operation results. For details, refer to descriptions in "*Math Operation Label*".
 - Press **More** > **Color Grade** to enable or disable the color grade display of the operation results. When enabled, different colors are displayed on the screen to indicate the times of data acquisition or acquisition probability.
 - Press **More** > **Reset ColorGrade** to clear the color grade display and display the color grade again.

9.1.4 Division



Divide the waveform voltage values of signal source A by that of source B point by point and display the results. It can be used to analyze the multiple relationships of waveforms of two channels. **Note:** When the voltage of signal source B is 0 V, the division result is treated as 0.

Press  > **Math1** > **Operator** to select "A÷B":

- Press **Operation** continuously to enable or disable the division operation function.
- Press **SourceA** and **SourceB** respectively, and rotate the multifunction knob  to select the channel for SourceA and SourceB. Then press down the knob to select the channel. You can also press **SourceA** and **SourceB** continuously or enable the touch screen to select the channel. The available channels for SourceA and SourceB are CH1-CH4 and Ref1-Ref10.

NOTE

The source of Math2 can be CH1-CH4, Ref1-Ref10, or Math1; the source of Math3 can be CH1-CH4, Ref1-Ref10, Math1, or Math2; the source of Math4 can be CH1-CH4, Ref1-Ref10, Math1, Math2, or Math3; only the channels that have been enabled currently can be selected.

- Press **Offset** to set the vertical offset of the operation results. For setting methods, refer to the descriptions in "*Parameter Setting Method*". You can also directly rotate **Wave Vertical**  **POSITION** or enable the touch screen to adjust the vertical offset.
- Press **Scale** to set the vertical scale of the operation results. For setting methods, refer to the descriptions in "*Parameter Setting Method*". You can also directly rotate **Wave Vertical**  **SCALE** or enable the touch screen to adjust the vertical Scale.
- Press **More** > **AutoSetting** to adjust the vertical scale and offset of the operation results to the optimal value according to the current configuration for better observation.
- Press **More** > **Invert** to enable or disable the inverted display function of the waveform.
- Press **More** > **Expand** to expand or compress the measurement waveform around the "Center" or "GND".
- Press **More** > **Label** to set the label for math operation results. For details, refer to descriptions in "*Math Operation Label*".

- Press **More** > **Color Grade** to enable or disable the color grade display of the operation results. When enabled, different colors are displayed on the screen to indicate the times of data acquisition or acquisition probability.
- Press **More** > **Reset ColorGrade** to clear the color grade display and display the color grade again.

9.1.5 FFT

FFT (Fast Fourier Transform) is used to transform time-domain signals to frequency-domain components (frequency spectrum). This series of oscilloscope provide FFT operation function which enables you to observe the time-domain waveform and spectrum of the signal at the same time. FFT operation can facilitate the following works:



- Measure harmonic components and distortion in the system;
- Display the characteristics of the noise in DC power;
- Analyze vibration.

Press  > **Math1** > **Operator** to "FFT":

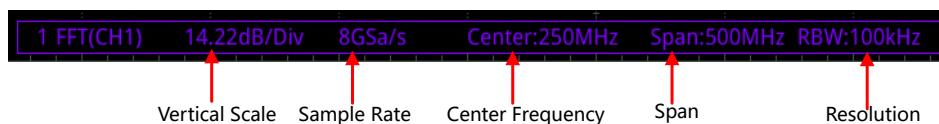
- Press **Operation** continuously to enable or disable the FFT operation function. When enabled, the operation results are displayed as purple waveforms on the screen. At the same time, the parameters such as vertical scale, center frequency, and resolution are displayed at the bottom of the screen, as shown in the following figure. Of which, FFT resolution is the quotient of the sample rate and the number of FFT points. If the number of FFT points is a fixed value (65535 at most), then the lower the sample rate, the higher the resolution.



- Press **Source**, rotate the multifunction knob , and then press the knob to select the channel. You can also press **Source** continuously or enable the touch screen to select the channel. The available channels are CH1, CH2, CH3, CH4.

- Press **Offset** to set the vertical offset of the operation results. For setting methods, refer to the descriptions in "*Parameter Setting Method*". You can also directly rotate **Wave Vertical**  **POSITION** or enable the touch screen to adjust the vertical offset.
- Press **Scale** to set the vertical scale of the operation results. For setting methods, refer to the descriptions in "*Parameter Setting Method*". You can also directly rotate **Wave Vertical**  **SCALE** or enable the touch screen and use the "Pinch & Stretch" gesture to adjust the vertical scale. If the source channel unit is set to "V", then the unit of the vertical scale is displayed as dBV. If you select other source channel unit, then the unit of the vertical scale is displayed as dB.
- Press **AutoSetting** to adjust the vertical scale and offset of the operation results to an optimal value based on the current configuration, so as to better observe.
- Press **More** > **Unit** to select the vertical unit. The vertical unit can be set to dB/dBm or Vrms. The vertical amplitude can be expressed both in log form and linear form, with dBm/dBV and Vrms as the unit respectively. If you need to display the FFT spectrum within a larger dynamic range, dBm/dBV is recommended.
- Press **More** > **X** to select "Span-Center" (frequency range to center frequency) or "Start-End" (start frequency to stop frequency).
 - "Span-Center" (frequency range to center frequency): the frequency range refers to the screen width, and you can divide the frequency range by 10 to obtain the frequency per division. Press **Span** to set the frequency range of the frequency-domain waveform. For setting methods, refer to descriptions in "*Parameter Setting Method*". Press **Center** to set the frequency of the frequency-domain waveform relative to the horizontal center of the screen. For setting methods, refer to descriptions in "*Parameter Setting Method*".
 - "Start-End" (start frequency to stop frequency): start frequency refers to the frequency at the left side of the screen. Press **Start** to set the start



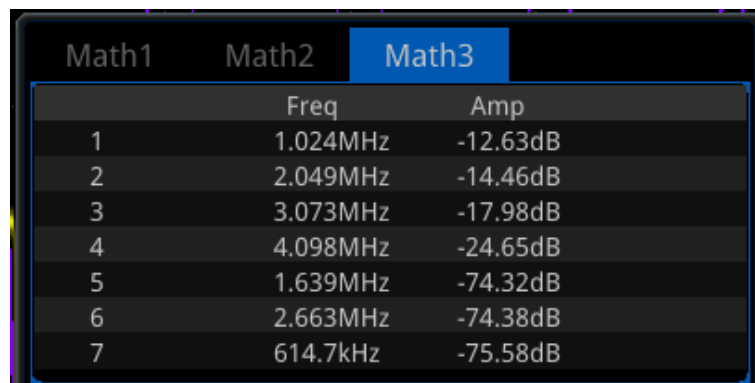

frequency of the frequency-domain waveform. For setting methods, refer to descriptions in "*Parameter Setting Method*". Stop frequency refers to the frequency at the right side of the screen. Press **End** to set the stop frequency of the frequency-domain waveform. For setting methods, refer to descriptions in "*Parameter Setting Method*".

- Press **More** > **Peak Search** to enter the peak search menu.

Press **Peak Search** continuously to enable or disable the Peak search function. When enabled, the peak search results are displayed on the screen, as shown in the figure below. Enable the touch screen and tap the "Math" label at the top of the peak search results to switch among Math1-Math4.



Math1	Math2	Math3
	Freq	Amp
1	1.024MHz	-12.63dB
2	2.049MHz	-14.46dB
3	3.073MHz	-17.98dB
4	4.098MHz	-24.65dB
5	1.639MHz	-74.32dB
6	2.663MHz	-74.38dB
7	614.7kHz	-75.58dB

- Press **Peak Number**, then rotate the multifunction knob  or use the pop-up numeric keypad to set the number of peaks. Its range is from 1 to 15. By default, it is 5.
- Press **Threshold**, then rotate the multifunction knob  or use the pop-up numeric keypad to set the threshold of the peak.
- Press **Excursion**, then rotate the multifunction knob  or use the pop-up numeric keypad to set the excursion of the peak.
- Press **Table Order**, and rotate the multifunction knob  to select the sorting mode of the peak, and then press down the knob to select the mode. You can also press **Source** continuously or enable the touch screen to select the mode. The available sorting mode is "Amp Order" and "Freq Order". By default, it is "Amp Order".

- Press **Export**, and the save setting menu is displayed. You can export the peak search results to the internal memory or the external USB storage device in CSV format. For detailed saving operation, refer to descriptions in "*Store and Load*".
- Press **More** > **Window** to select the desired window function.

Spectral leakage can be considerably decreased when a window function is used. This series of oscilloscope provides 6 FFT window functions (as shown in *Table 9.1 Window Function*) which have different characteristics and are applicable to measure different waveforms. You need to select the window function according to the characteristics of the waveform to be measured.

Table 9.1 Window Function

Window Function	Characteristics	Waveforms Applicable to the Window Function
Rectangular	Best frequency resolution Poorest amplitude resolution Similar to the situation when no window is applied.	Transient or short pulse, the signal levels before and after the multiplication are basically the same. Sine waveforms with the same amplitudes and rather similar frequencies. Wide band random noise with relatively slow change of waveform spectrum.
Blackman-Harris	Best amplitude resolution Poorest frequency resolution	Single frequency signal, searching for higher order harmonics
Hanning	Better frequency resolution and poorer amplitude resolution compared with Rectangular	Sine, periodic, and narrow band random noise
Hamming	A little bit better frequency resolution than Hanning	Transient or short pulse, the signal levels before and after the multiplication are rather different

Window Function	Characteristics	Waveforms Applicable to the Window Function
Flattop	Measure the signals accurately	Measure the signal that has no accurate reference and requires an accurate measurement
Triangle	Better frequency resolution	Measure the narrow band signal and that has strong noise interference

- For FFT math operation setting label, refer to descriptions in "*Math Operation Label*".
- Press **More** > **More** > **Color Grade** to enable or disable the color grade display of the FFT operation results. When enabled, different colors are displayed on the screen to indicate the times of data acquisition or acquisition probability.
- Press **More** > **More** > **Reset ColorGrade** to clear the color grade display and then display the color grade again.

**TIP**

FFT shortcut operation: Enable the touch screen, and then tap the function navigation icon  at the lower-left corner of the screen to open the function navigation. Then, tap the "FFT" icon to open the FFT menu. This oscilloscope supports 4 FFTs: FFT1, FFT2, FFT3, and FFT4. For details, refer to the descriptions in this section.

9.1.6 "AND" Operation

Performs logic "AND" operation on the waveform voltage values of the specified sources point by point and displays the results. In operation, when the voltage value of the source channel is greater than the threshold of the corresponding channel, it is regarded as logic "1"; otherwise it is logic "0". The results of logic AND operation of two binary bits are shown in *Table 9.2 Logic "AND" Operation*.

Table 9.2 Logic "AND" Operation

A	B	A&&B
0	0	0
0	1	0
1	0	0

A	B	A&&B
1	1	1

Press  > **Math1** > **Operator** to "A&&B":

- Press **Operation** continuously to enable or disable the "AND" function.
- Press **SourceA** and **SourceB** respectively, and rotate the multifunction knob  to select the channel for SourceA and SourceB. Then press down the knob to select the channel. You can also press **SourceA** and **SourceB** continuously or enable the touch screen to select the channel. The available channels for SourceA and SourceB are CH1-CH4 and D0-D15.



NOTE

Only the channels that have been enabled currently can be selected.

- If Source A (or Source B) selects CH1, press **More** > **Thre.CH1** to set the threshold of Source A (or Source B) in logic operation. For setting methods, refer to descriptions in "*Parameter Setting Method*".
- If Source A (or Source B) selects CH2, press **More** > **Thre.CH2** to set the threshold of Source A (or Source B) in logic operation. For setting methods, refer to descriptions in "*Parameter Setting Method*".
- If Source A (or Source B) selects CH3, press **More** > **Thre.CH3** to set the threshold of Source A (or Source B) in logic operation. For setting methods, refer to descriptions in "*Parameter Setting Method*".
- If Source A (or Source B) selects CH4, press **More** > **Thre.CH4** to set the threshold of Source A (or Source B) in logic operation. For setting methods, refer to descriptions in "*Parameter Setting Method*".

TIP

The thresholds of the digital channels (D0-D15) are respectively set in the LA module.

- Press **Offset**, then rotate the multifunction knob  to set the vertical offset of the operation results. You can also directly rotate **Wave Vertical**  **POSITION** or enable the touch screen to adjust the vertical offset.
- Press **Size**, then rotate the multifunction knob  to select the waveform size, and press down the knob to select the size. You can also press **Size** continuously or enable the touch screen to select the channel. The available sizes include

"Small", "Medium", and "Large". In addition, you can also rotate **Wave Vertical**

 **SCALE** to adjust the waveform size.

- Press **More** > **AutoSetting** to adjust the vertical scale and offset of the operation results to the optimal value according to the current configuration for better observation.
- Press **More** > **Sensitivity** to set the sensitivity of the digital signal converted from the analog signal on the source. For setting methods, refer to descriptions in "*Parameter Setting Method*".
- Press **More** > **Label** to set the label for math operation results. For details, refer to the descriptions in "*Math Operation Label*".

9.1.7 "OR" Operation

Performs logic "OR" operation on the waveform voltage values of the specified sources point by point and displays the results. In operation, when the voltage value of the source channel is greater than the threshold of the corresponding channel, it is regarded as logic "1"; otherwise it is logic "0". The results of logic OR operation of two binary bits are shown in *Table 9.3 Logic "OR" Operation*.

Table 9.3 Logic "OR" Operation





A	B	A B
0	0	0
0	1	1
1	0	1
1	1	1

Press  > **Math1** > **Operator** to select "A||B":

- Press **Operation** continuously to enable or disable the "A||B" operation function.
- Press **SourceA** and **SourceB** respectively, and rotate the multifunction knob  to select the channel for SourceA and SourceB. Then press down the knob to select the channel. You can also press **SourceA** and **SourceB** continuously or enable the touch screen to select the channel. The available channels for SourceA and SourceB are CH1-CH4 and D0-D15.

NOTE

Only the channels that have been enabled currently can be selected.

- If Source A (or Source B) selects CH1, press **More** > **Thre.CH1** to set the threshold of Source A (or Source B) in logic operation. For setting methods, refer to descriptions in "*Parameter Setting Method*".
- If Source A (or Source B) selects CH2, press **More** > **Thre.CH2** to set the threshold of Source A (or Source B) in logic operation. For setting methods, refer to descriptions in "*Parameter Setting Method*".
- If Source A (or Source B) selects CH3, press **More** > **Thre.CH3** to set the threshold of Source A (or Source B) in logic operation. For setting methods, refer to descriptions in "*Parameter Setting Method*".
- If Source A (or Source B) selects CH4, press **More** > **Thre.CH4** to set the threshold of Source A (or Source B) in logic operation. For setting methods, refer to descriptions in "*Parameter Setting Method*".
- Press **Offset**, then rotate the multifunction knob  to set the vertical offset of the operation results. You can also directly rotate **Wave Vertical**  **POSITION** or enable the touch screen to adjust the vertical offset.
- Press **Size**, then rotate the multifunction knob  to select the waveform size. Press down the knob to select it. You can also press **Size** continuously or enable the touch screen to select the channel. The available sizes include "Small", "Medium", and "Large". In addition, you can also rotate **Wave Vertical**  **SCALE** to adjust the waveform size.
- Press **More** > **AutoSetting** to adjust the vertical scale and offset of the operation results to the optimal value according to the current configuration for better observation.
- Press **More** > **Sensitivity** to set the sensitivity of the digital signal converted from the analog signal on the source. For setting methods, refer to descriptions in "*Parameter Setting Method*".
- Press **More** > **Label** to set the label for math operation results. For details, refer to descriptions in "*Math Operation Label*".

9.1.8 "XOR" Operation

Performs logic "XOR" operation on the waveform voltage values of the specified sources point by point and displays the results. In operation, when the voltage value of the source channel is greater than the threshold of the corresponding channel, it is regarded as logic "1"; otherwise it is logic "0". The results of logic OR operation of two binary bits are shown in *Table 9.4 Logic "XOR" Operation*.

Table 9.4 Logic "XOR" Operation

A	B	A^B
0	0	0
0	1	1
1	0	1
1	1	0





Press  > **Math1** > **Operator** to select "A^B":

- Press **Operation** continuously to enable or disable the "A^B" operation function.
- Press **SourceA** and **SourceB** respectively, and rotate the multifunction knob  to select the channel for SourceA and SourceB. Then press down the knob to select the channel. You can also press **SourceA** and **SourceB** continuously or enable the touch screen to select the channel. The available channels for SourceA and SourceB are CH1-CH4 and D0-D15.

NOTE

Only the channels that have been enabled currently can be selected.

- If Source A (or Source B) selects CH1, press **More** > **Thre.CH1** to set the threshold of Source A (or Source B) in logic operation. For setting methods, refer to descriptions in "*Parameter Setting Method*".
- If Source A (or Source B) selects CH2, press **More** > **Thre.CH2** to set the threshold of Source A (or Source B) in logic operation. For setting methods, refer to descriptions in "*Parameter Setting Method*".
- If Source A (or Source B) selects CH3, press **More** > **Thre.CH3** to set the threshold of Source A (or Source B) in logic operation. For setting methods, refer to descriptions in "*Parameter Setting Method*".
- If Source A (or Source B) selects CH4, press **More** > **Thre.CH4** to set the threshold of Source A (or Source B) in logic operation. For setting methods, refer to descriptions in "*Parameter Setting Method*".

- Press **Offset**, then rotate the multifunction knob  to set the vertical offset of the operation results. You can also directly rotate **Wave Vertical**  **POSITION** or enable the touch screen to adjust the vertical offset.
- Press **Size**, then rotate the multifunction knob  to select the waveform size. Press down the knob to select it. You can also press **Size** continuously or enable the touch screen to select the channel. The available sizes include "Small", "Medium", and "Large". In addition, you can also rotate **Wave Vertical**  **SCALE** to adjust the waveform size.
- Press **More** > **AutoSetting** to adjust the vertical scale and offset of the operation results to the optimal value according to the current configuration for better observation.
- Press **More** > **Sensitivity** to set the sensitivity of the digital signal converted from the analog signal on the source. For setting methods, refer to descriptions in "*Parameter Setting Method*".
- Press **More** > **Label** to set the label for math operation results. For details, refer to the descriptions in "*Math Operation Label*".

9.1.9 "NOT" Operation

Performs logic "NOT" operation on the waveform voltage values of the specified sources point by point and displays the results. In operation, when the voltage value of the source channel is greater than the threshold of the corresponding channel, it is regarded as logic "1"; otherwise it is logic "0". The results of logic "NOT" operation of two binary bits are as shown in *Table 9.5 Logic "NOT" Operation*.

Table 9.5 Logic "NOT" Operation





A	!A
0	1
1	0

Press  > **Math1** > **Operator** to select "!A":

- Press **Operation** continuously to enable or disable the "NOT" function.
- Press **SourceA**, and rotate the multifunction knob  to select the channel for SourceA. Then press down the knob to select the channel. You can also press **SourceA** continuously or enable the touch screen to select the channel. The available channels for SourceA are CH1-CH4 and D0-D15.

NOTE

Only the channels that have been enabled currently can be selected.

- If Source A selects CH1, press **More** > **Thre.CH1** to set the threshold of Source A in logic operation. For setting methods, refer to descriptions in "*Parameter Setting Method*".
- If Source A selects CH2, press **More** > **Thre.CH2** to set the threshold of Source A in logic operation. For setting methods, refer to descriptions in "*Parameter Setting Method*".
- If Source A selects CH3, press **More** > **Thre.CH3** to set the threshold of Source A in logic operation. For setting methods, refer to descriptions in "*Parameter Setting Method*".
- If Source A selects CH4, press **More** > **Thre.CH4** to set the threshold of Source A in logic operation. For setting methods, refer to descriptions in "*Parameter Setting Method*".
- Press **Offset**, then rotate the multifunction knob  to set the vertical offset of the operation results. You can also directly rotate **Wave Vertical**  **POSITION** or enable the touch screen to adjust the vertical offset.
- Press **Size**, then rotate the multifunction knob  to select the waveform size. Press down the knob to select it. You can also press **Size** continuously or enable the touch screen to select the channel. The available sizes include "Small", "Medium", and "Large". In addition, you can also rotate **Wave Vertical**  **SCALE** to adjust the waveform size.
- Press **AutoSetting** to adjust the vertical scale and offset of the operation results to an optimal value based on the current configuration, so as to better observe.
- Press **More** > **Sensitivity** to set the sensitivity of the digital signal converted from the analog signal on the source. For setting methods, refer to descriptions in "*Parameter Setting Method*".

- Press **More** > **Label** to set the label for math operation results. For details, refer to the descriptions in "*Math Operation Label*".

9.1.10 Intg



Calculates the integral of the selected source. For example, you can use integral to measure the area under a waveform or the pulse energy.

Press  > **Math1** > **Operator** to "Intg":

- Press **Operation** continuously to enable or disable the "Intg" operation function.
- Press **SourceA**, and rotate the multifunction knob  to select the channel for SourceA. You can also press **SourceA** continuously or enable the touch screen to select the channel. The available channels for SourceA are CH1-CH4 and Ref1-Ref10.

NOTE

The source of Math2 can be CH1-CH4, Ref1-Ref10, or Math1; the source of Math3 can be CH1-CH4, Ref1-Ref10, Math1, or Math2; the source of Math4 can be CH1-CH4, Ref1-Ref10, Math1, Math2, or Math3; only the channels that have been enabled currently can be selected.

- Press **Offset** to set the vertical offset of the operation results. For setting methods, refer to the descriptions in "*Parameter Setting Method*". You can also directly rotate **Wave Vertical**  **POSITION** or enable the touch screen to adjust the vertical offset.
- Press **Scale** to set the vertical scale of the operation results. For setting methods, refer to the descriptions in "*Parameter Setting Method*". You can also directly rotate **Wave Vertical**  **SCALE** or enable the touch screen to adjust the vertical Scale.
- Press **AutoSetting** to adjust the vertical scale and offset of the operation results to an optimal value based on the current configuration, so as to better observe.
- Press **More** > **Bias** to set the DC offset correction factor for the input signal. Note that this parameter can only be set by using the numeric keypad.
- Press **More** > **Invert** to enable or disable the inverted display function of the waveform.

- Press **More** > **Label** to set the label for math operation results. For details, refer to the descriptions in "*Math Operation Label*".
- Press **More** > **Color Grade** to enable or disable the color grade display of the operation results. When enabled, different colors are displayed on the screen to indicate the times of data acquisition or acquisition probability.
- Press **More** > **Reset ColorGrade** to clear the color grade display and display the color grade again.

9.1.11 Diff



Calculates the discrete time derivative of the selected source. For example, you can use differentiate to measure the instantaneous slope of a waveform.

Press  > **Math1** > **Operator** to "Diff":

- Press **Operation** continuously to enable or disable the "Diff" operation function.
- Press **SourceA**, and rotate the multifunction knob  to select the channel for SourceA. You can also press **SourceA** continuously or enable the touch screen to select the channel. The available channels for SourceA are CH1-CH4 and Ref1-Ref10.

NOTE

The source of Math2 can be CH1-CH4, Ref1-Ref10, or Math1; the source of Math3 can be CH1-CH4, Ref1-Ref10, Math1, or Math2; the source of Math4 can be CH1-CH4, Ref1-Ref10, Math1, Math2, or Math3; only the channels that have been enabled currently can be selected.

- Press **Offset** to set the vertical offset of the operation results. For setting methods, refer to the descriptions in "*Parameter Setting Method*". You can also directly rotate **Wave Vertical**  **POSITION** or enable the touch screen to adjust the vertical offset.
- Press **Scale** to set the vertical scale of the operation results. For setting methods, refer to the descriptions in "*Parameter Setting Method*". You can also directly rotate **Wave Vertical**  **SCALE** or enable the touch screen to adjust the vertical Scale.

- Press **AutoSetting** to adjust the vertical scale and offset of the operation results to an optimal value based on the current configuration, so as to better observe.
- Press **More** > **Smooth** to set the number of smoothing times in differential operation. For setting methods, refer to descriptions in "*Parameter Setting Method*".

NOTE

As the high-frequency component of waveform data has a great impact on the differential operation, you need to adjust the parameter "Smooth" to a larger value, so as to restore the low-frequency component.

- Press **More** > **Invert** to enable or disable the inverted display function of the waveform.
- Press **More** > **Label** to set the label for math operation results. For details, refer to descriptions in "*Math Operation Label*".
- Press **More** > **Color Grade** to enable or disable the color grade display of the operation results. When enabled, different colors are displayed on the screen to indicate the times of data acquisition or acquisition probability.
- Press **More** > **Reset ColorGrade** to clear the color grade display and display the color grade again.



TIP

Because differentiation is very sensitive to noise, it is helpful to set acquisition mode to "Average".

9.1.12 Sqrt



Calculates the square roots of the selected source point by point and displays the results.

Press  > **Math1** > **Operator** to select "Sqrt":

- Press **Operation** continuously to enable or disable the "Sqrt" operation function.
- Press **SourceA**, and rotate the multifunction knob  to select the channel for SourceA. You can also press **SourceA** continuously or enable the touch screen to select the channel. The available channels for SourceA are CH1-CH4 and Ref1-Ref10.

NOTE

The source of Math2 can be CH1-CH4, Ref1-Ref10, or Math1; the source of Math3 can be CH1-CH4, Ref1-Ref10, Math1, or Math2; the source of Math4 can be CH1-CH4, Ref1-Ref10, Math1, Math2, or Math3; only the channels that have been enabled currently can be selected.

- Press **Offset** to set the vertical offset of the operation results. For setting methods, refer to the descriptions in "*Parameter Setting Method*". You can also directly rotate **Wave Vertical**  **POSITION** or enable the touch screen to adjust the vertical offset.
- Press **Scale** to set the vertical scale of the operation results. For setting methods, refer to the descriptions in "*Parameter Setting Method*". You can also directly rotate **Wave Vertical**  **SCALE** or enable the touch screen to adjust the vertical Scale.
- Press **AutoSetting** to adjust the vertical scale and offset of the operation results to an optimal value based on the current configuration, so as to better observe.
- Press **More** > **Invert** to enable or disable the inverted display function of the waveform.
- Press **More** > **Label** to set the label for math operation results. For details, refer to descriptions in "*Math Operation Label*".
- Press **More** > **Color Grade** to enable or disable the color grade display of the operation results. When enabled, different colors are displayed on the screen to indicate the times of data acquisition or acquisition probability.
- Press **More** > **Reset ColorGrade** to clear the color grade display and display the color grade again.

9.1.13 Lg (Base 10 Exponential)

Calculates the base 10 exponential of the selected source point by point and displays the results.



Press  > **Math1** > **Operator** to "Lg":

- Press **Operation** continuously to enable or disable the "Lg" operation function.

- Press **SourceA**, and rotate the multifunction knob  to select the channel for SourceA. You can also press **SourceA** continuously or enable the touch screen to select the channel. The available channels for SourceA are CH1-CH4 and Ref1-Ref10.

NOTE

The source of Math2 can be CH1-CH4, Ref1-Ref10, or Math1; the source of Math3 can be CH1-CH4, Ref1-Ref10, Math1, or Math2; the source of Math4 can be CH1-CH4, Ref1-Ref10, Math1, Math2, or Math3; only the channels that have been enabled currently can be selected.

- Press **Offset** to set the vertical offset of the operation results. For setting methods, refer to the descriptions in "*Parameter Setting Method*". You can also directly rotate **Wave Vertical**  **POSITION** or enable the touch screen to adjust the vertical offset.
- Press **Scale** to set the vertical scale of the operation results. For setting methods, refer to the descriptions in "*Parameter Setting Method*". You can also directly rotate **Wave Vertical**  **SCALE** or enable the touch screen to adjust the vertical Scale.
- Press **AutoSetting** to adjust the vertical scale and offset of the operation results to an optimal value based on the current configuration, so as to better observe.
- Press **More** > **Invert** to enable or disable the inverted display function of the waveform.
- Press **More** > **Label** to set the label for math operation results. For details, refer to descriptions in "*Math Operation Label*".
- Press **More** > **Color Grade** to enable or disable the color grade display of the operation results. When enabled, different colors are displayed on the screen to indicate the times of data acquisition or acquisition probability.
- Press **More** > **Reset ColorGrade** to clear the color grade display and display the color grade again.

9.1.14 Ln



Calculates the natural logarithm (Ln) of the selected source point by point and displays the results.

Press  > **Math1** > **Operator** to "Ln":

- Press **Operation** continuously to enable or disable the "Ln" operation function.
- Press **SourceA**, and rotate the multifunction knob  to select the channel for SourceA. You can also press **SourceA** continuously or enable the touch screen to select the channel. The available channels for SourceA are CH1-CH4 and Ref1-Ref10.

NOTE

The source of Math2 can be CH1-CH4, Ref1-Ref10, or Math1; the source of Math3 can be CH1-CH4, Ref1-Ref10, Math1, or Math2; the source of Math4 can be CH1-CH4, Ref1-Ref10, Math1, Math2, or Math3; only the channels that have been enabled currently can be selected.

- Press **Offset** to set the vertical offset of the operation results. For setting methods, refer to the descriptions in "*Parameter Setting Method*". You can also directly rotate **Wave Vertical**  **POSITION** or enable the touch screen to adjust the vertical offset.
- Press **Scale** to set the vertical scale of the operation results. For setting methods, refer to the descriptions in "*Parameter Setting Method*". You can also directly rotate **Wave Vertical**  **SCALE** or enable the touch screen to adjust the vertical Scale.
- Press **AutoSetting** to adjust the vertical scale and offset of the operation results to an optimal value based on the current configuration, so as to better observe.
- Press **More** > **Invert** to enable or disable the inverted display function of the waveform.
- Press **More** > **Label** to set the label for math operation results. For details, refer to descriptions in "*Math Operation Label*".
- Press **More** > **Color Grade** to enable or disable the color grade display of the operation results. When enabled, different colors are displayed on the screen to indicate the times of data acquisition or acquisition probability.
- Press **More** > **Reset ColorGrade** to clear the color grade display and display the color grade again.

9.1.15 Exp



Calculates the exponential of the selected source point by point and displays the results.

Press  > **Math1** > **Operator** to "Exp":

- Press **Operation** continuously to enable or disable the "Exp" operation function.
- Press **SourceA**, and rotate the multifunction knob  to select the channel for SourceA. You can also press **SourceA** continuously or enable the touch screen to select the channel. The available channels for SourceA are CH1-CH4 and Ref1-Ref10.

NOTE

The source of Math2 can be CH1-CH4, Ref1-Ref10, or Math1; the source of Math3 can be CH1-CH4, Ref1-Ref10, Math1, or Math2; the source of Math4 can be CH1-CH4, Ref1-Ref10, Math1, Math2, or Math3; only the channels that have been enabled currently can be selected.

- Press **Offset** to set the vertical offset of the operation results. For setting methods, refer to the descriptions in "*Parameter Setting Method*". You can also directly rotate **Wave Vertical**  **POSITION** or enable the touch screen to adjust the vertical offset.
- Press **Scale** to set the vertical scale of the operation results. For setting methods, refer to the descriptions in "*Parameter Setting Method*". You can also directly rotate **Wave Vertical**  **SCALE** or enable the touch screen to adjust the vertical Scale.
- Press **AutoSetting** to adjust the vertical scale and offset of the operation results to an optimal value based on the current configuration, so as to better observe.
- Press **More** > **Invert** to enable or disable the inverted display function of the waveform.
- Press **More** > **Label** to set the label for math operation results. For details, refer to descriptions in "*Math Operation Label*".

- Press **More** > **Color Grade** to enable or disable the color grade display of the operation results. When enabled, different colors are displayed on the screen to indicate the times of data acquisition or acquisition probability.
- Press **More** > **Reset ColorGrade** to clear the color grade display and display the color grade again.

9.1.16 Abs



Calculates the absolute value of the selected source and displays the results.

Press  > **Math1** > **Operator** to select "Abs":

- Press **Operation** continuously to enable or disable the "Abs" function.
- Press **SourceA**, and rotate the multifunction knob  to select the channel for SourceA. Then press down the knob to select the channel. You can also press **SourceA** continuously or enable the touch screen to select the channel. The available channels for SourceA are CH1-CH4 and Ref1-Ref10.

NOTE

The source of Math2 can be CH1-CH4, Ref1-Ref10, or Math1; the source of Math3 can be CH1-CH4, Ref1-Ref10, Math1, or Math2; the source of Math4 can be CH1-CH4, Ref1-Ref10, Math1, Math2, or Math3; only the channels that have been enabled currently can be selected.

- Press **Offset** to set the vertical offset of the operation results. For setting methods, refer to the descriptions in "*Parameter Setting Method*". You can also directly rotate **Wave Vertical**  **POSITION** or enable the touch screen to adjust the vertical offset.
- Press **Scale** to set the vertical scale of the operation results. For setting methods, refer to the descriptions in "*Parameter Setting Method*". You can also directly rotate **Wave Vertical**  **SCALE** or enable the touch screen to adjust the vertical Scale.
- Press **AutoSetting** to adjust the vertical scale and offset of the operation results to an optimal value based on the current configuration, so as to better observe.
- Press **More** > **Invert** to enable or disable the inverted display function of the waveform.

- Press **More** > **Label** to set the label for math operation results. For details, refer to the descriptions in "*Math Operation Label*".
- Press **More** > **Color Grade** to enable or disable the color grade display of the operation results. When enabled, different colors are displayed on the screen to indicate the times of data acquisition or acquisition probability.
- Press **More** > **Reset ColorGrade** to clear the color grade display and display the color grade again.

9.1.17 Low Pass



Only allows the signals whose frequencies are lower than the current upper limit frequency to pass.

Press  > **Math1** > **Operator** to "LowPass":

- Press **Operation** continuously to enable or disable the "LowPass" operation function.
- Press **SourceA**, and rotate the multifunction knob  to select the channel for SourceA. You can also press **SourceA** continuously or enable the touch screen to select the channel. The available channels for SourceA are CH1-CH4 and Ref1-Ref10.

NOTE

The source of Math2 can be CH1-CH4, Ref1-Ref10, or Math1; the source of Math3 can be CH1-CH4, Ref1-Ref10, Math1, or Math2; the source of Math4 can be CH1-CH4, Ref1-Ref10, Math1, Math2, or Math3; only the channels that have been enabled currently can be selected.

- Press **Offset** to set the vertical offset of the operation results. For setting methods, refer to the descriptions in "*Parameter Setting Method*". You can also directly rotate **Wave Vertical**  **POSITION** or enable the touch screen to adjust the vertical offset.
- Press **Scale** to set the vertical scale of the operation results. For setting methods, refer to the descriptions in "*Parameter Setting Method*". You can also directly rotate **Wave Vertical**  **SCALE** or enable the touch screen to adjust the vertical Scale.

- Press **ωc** to set the upper limit frequency. For setting methods, refer to descriptions in "*Parameter Setting Method*".

NOTE

The settable range of the Upper limit frequency is related to the Math sample rate (displayed at the bottom of the screen when the Math function is enabled). The sample rate of the analog channel or the changes of the memory depth can affect the Math sample rate.

- Press **More** > **AutoSetting** to adjust the vertical scale and offset of the operation results to an optimal value based on the current configuration, so as to better observe.
- Press **More** > **Invert** to enable or disable the inverted display function of the waveform.
- Press **More** > **Label** to set the label for math operation results. For details, refer to descriptions in "*Math Operation Label*".
- Press **More** > **Color Grade** to enable or disable the color grade display of the operation results. When enabled, different colors are displayed on the screen to indicate the times of data acquisition or acquisition probability.
- Press **More** > **Reset ColorGrade** to clear the color grade display and display the color grade again.

9.1.18 High Pass



Only allows the signals whose frequencies are higher than the current lower limit frequency to pass.

Press  > **Math1** > **Operator** to select "HighPass":

- Press **Operation** continuously to enable or disable the "HighPass" operation function.
- Press **SourceA**, and rotate the multifunction knob  to select the channel for SourceA. You can also press **SourceA** continuously or enable the touch screen to select the channel. The available channels for SourceA are CH1-CH4 and Ref1-Ref10.

NOTE

The source of Math2 can be CH1-CH4, Ref1-Ref10, or Math1; the source of Math3 can be CH1-CH4, Ref1-Ref10, Math1, or Math2; the source of Math4 can be CH1-CH4, Ref1-Ref10, Math1, Math2, or Math3; only the channels that have been enabled currently can be selected.

- Press **Offset** set the vertical offset of the operation results. For setting methods, refer to the descriptions in "*Parameter Setting Method*". You can also directly rotate **Wave Vertical**  **POSITION** or enable the touch screen to adjust the vertical offset.
- Press **Scale** to set the vertical scale of the operation results. For setting methods, refer to the descriptions in "*Parameter Setting Method*". You can also directly rotate **Wave Vertical**  **SCALE** or enable the touch screen to adjust the vertical Scale.
- Press **wc** to set the lower limit frequency. For setting methods, refer to descriptions in "*Parameter Setting Method*".

NOTE

The settable range of the lower limit frequency is related to the Math sample rate (displayed at the bottom of the screen when the Math function is enabled). The sample rate of the analog channel or the changes of the memory depth can affect the Math sample rate.

- Press **More** > **AutoSetting** to adjust the vertical scale and offset of the operation results to an optimal value based on the current configuration, so as to better observe.
- Press **More** > **Invert** to enable or disable the inverted display function of the waveform.
- Press **More** > **Label** to set the label for math operation results. For details, refer to descriptions in "*Math Operation Label*".
- Press **More** > **Color Grade** to enable or disable the color grade display on the of the operation results. When enabled, different colors are displayed on the screen to indicate the times of data acquisition or acquisition probability.
- Press **More** > **Color Grade** to clear the color grade display and display the color grade again.

9.1.19 Band Pass



Only allows the signals whose frequencies are higher than the current lower limit frequency and lower than the current upper limit frequency to pass.

Press  > **Math1** > **Operator** to "BandPass":

- Press **Operation** continuously to enable or disable the "BandPass" operation function.
- Press **SourceA**, and rotate the multifunction knob  to select the channel for SourceA. You can also press **SourceA** continuously or enable the touch screen to select the channel. The available channels for SourceA are CH1-CH4 and Ref1-Ref10.

NOTE

The source of Math2 can be CH1-CH4, Ref1-Ref10, or Math1; the source of Math3 can be CH1-CH4, Ref1-Ref10, Math1, or Math2; the source of Math4 can be CH1-CH4, Ref1-Ref10, Math1, Math2, or Math3; only the channels that have been enabled currently can be selected.

- Press **Offset** to set the vertical offset of the operation results. For setting methods, refer to the descriptions in "*Parameter Setting Method*". You can also directly rotate **Wave Vertical**  **POSITION** or enable the touch screen to adjust the vertical offset.
- Press **Scale** to set the vertical scale of the operation results. For setting methods, refer to the descriptions in "*Parameter Setting Method*". You can also directly rotate **Wave Vertical**  **SCALE** or enable the touch screen to adjust the vertical Scale.
- Press **AutoSetting** to adjust the vertical scale and offset of the operation results to an optimal value based on the current configuration, so as to better observe.
- Press **More** > **ωc1** to set the lower limit frequency. For setting methods, refer to descriptions in "*Parameter Setting Method*".
- Press **More** > **ωc2** to set the upper limit frequency. For setting methods, refer to descriptions in "*Parameter Setting Method*".

NOTE

The settable ranges of the upper and lower limit frequencies are related to the Math sample rate (displayed at the bottom of the screen when the Math function is enabled).

The sample rate of the analog channel or the changes of the memory depth can affect the Math sample rate.

- Press **More** > **Invert** to enable or disable the inverted display function of the waveform.
- Press **More** > **Label** to set the label for math operation results. For details, refer to descriptions in "*Math Operation Label*".
- Press **More** > **Color Grade** to enable or disable the color grade display of the operation results. When enabled, different colors are displayed on the screen to indicate the times of data acquisition or acquisition probability.
- Press **More** > **Reset ColorGrade** to clear the color grade display and display the color grade again.

9.1.20 Band Stop

Only allows the signals whose frequencies are lower than the current lower limit frequency and higher than the current upper limit frequency to pass.

Press  > **Math1** > **Operator** to "BandStop":

- Press **Operation** continuously to enable or disable the "BandStop" operation function.
- Press **SourceA**, and rotate the multifunction knob  to select the channel for SourceA. You can also press **SourceA** continuously or enable the touch screen to select the channel. The available channels for SourceA are CH1-CH4 and Ref1-Ref10.

NOTE

The source of Math2 can be CH1-CH4, Ref1-Ref10, or Math1; the source of Math3 can be CH1-CH4, Ref1-Ref10, Math1, or Math2; the source of Math4 can be CH1-CH4, Ref1-Ref10, Math1, Math2, or Math3; only the channels that have been enabled currently can be selected.

- Press **Offset** to set the vertical offset of the operation results. For setting methods, refer to the descriptions in "*Parameter Setting Method*". You can also directly rotate **Wave Vertical**  **POSITION** or enable the touch screen to adjust the vertical offset.

- Press **Scale** to set the vertical scale of the operation results. For setting methods, refer to the descriptions in "*Parameter Setting Method*". You can also directly rotate **Wave Vertical**  **SCALE** or enable the touch screen to adjust the vertical Scale.
- Press **AutoSetting** to adjust the vertical scale and offset of the operation results to an optimal value based on the current configuration, so as to better observe.
- Press **More** > **ωc1** to set the lower limit frequency. For setting methods, refer to descriptions in "*Parameter Setting Method*".
- Press **More** > **ωc2** to set the upper limit frequency. For setting methods, refer to descriptions in "*Parameter Setting Method*".

NOTE

The settable ranges of the Lower and Upper limit frequencies are related to the Math sample rate (displayed at the bottom of the screen when the Math function is enabled). The sample rate of the analog channel or the changes of the memory depth can affect the Math sample rate.

- Press **More** > **Invert** to enable or disable the inverted display function of the waveform.
- Press **More** > **Label** to set the label for math operation results. For details, refer to the descriptions in "*Math Operation Label*".
- Press **More** > **Color Grade** to enable or disable the color grade display of the operation results. When enabled, different colors are displayed on the screen to indicate the times of data acquisition or acquisition probability.
- Press **More** > **Reset ColorGrade** to clear the color grade display and display the color grade again.

9.1.21 AX+B



Applies a linear function to the selected source, and displays the results.

Press  > **Math1** > **Operator** to "AX+B":

- Press **Operation** continuously to enable or disable the "AX+B" operation function.
- Press **SourceA**, and rotate the multifunction knob  to select the channel for SourceA. You can also press **SourceA** continuously or enable the touch screen to select the channel. The available channels for SourceA are CH1-CH4 and Ref1-Ref10.

NOTE

The source of Math2 can be CH1-CH4, Ref1-Ref10, or Math1; the source of Math3 can be CH1-CH4, Ref1-Ref10, Math1, or Math2; the source of Math4 can be CH1-CH4, Ref1-Ref10, Math1, Math2, or Math3; only the channels that have been enabled currently can be selected.

- Press **Offset** to set the vertical offset of the operation results. For setting methods, refer to the descriptions in "*Parameter Setting Method*". You can also directly rotate **Wave Vertical**  **POSITION** or enable the touch screen to adjust the vertical offset.
- Press **Scale** to set the vertical scale of the operation results. For setting methods, refer to the descriptions in "*Parameter Setting Method*". You can also directly rotate **Wave Vertical**  **SCALE** or enable the touch screen to adjust the vertical Scale.
- Press **AutoSetting** to adjust the vertical scale and offset of the operation results to an optimal value based on the current configuration, so as to better observe.
- Press **More** > **A** to set the value of A. Note that this parameter can only be set by using the numeric keypad.
- Press **More** > **B** to set the value of B. Note that this parameter can only be set by using the numeric keypad.
- Press **More** > **Invert** to enable or disable the inverted display function of the waveform.
- Press **More** > **Label** to set the label for math operation results. For details, refer to the descriptions in "*Math Operation Label*".

- Press **More** > **Color Grade** to enable or disable the color grade display of the operation results. When enabled, different colors are displayed on the screen to indicate the times of data acquisition or acquisition probability.
- Press **More** > **Reset ColorGrade** to clear the color grade display and display the color grade again.

9.1.22 Avg

Averages the waveforms of the specified channel for several times and displays the results.

Press  > **Math1** > **Operator** to "Avg":

- Press **Operation** continuously to enable or disable the "Avg" operation function.
- Press **SourceA**, and rotate the multifunction knob  to select the channel for SourceA. You can also press **SourceA** continuously or enable the touch screen to select the channel. The available channels for SourceA are CH1-CH4 and Ref1-Ref10.

NOTE

The source of Math2 can be CH1-CH4, Ref1-Ref10, or Math1; the source of Math3 can be CH1-CH4, Ref1-Ref10, Math1, or Math2; the source of Math4 can be CH1-CH4, Ref1-Ref10, Math1, Math2, or Math3; only the channels that have been enabled currently can be selected.

- Press **Averages** to input the average time in the displayed numeric keypad.

When the average count value is not in N power-of-2 increments, a prompt message "Truncation average error" is displayed. At this time, a value that is smaller than the one you input and the closest to N power-of-2 increments will be input automatically. For example, if you input 9 with the numeric keypad, the average count will be input 8 automatically.

The number of averages can be set to 2, 4, 8, 16, 32, 64, 128, 256, 512, 1024, 2048, 4096, 8192, 16384, 32768, or 65536. By default, it is 2.

- Press **Offset** to set the vertical offset of the operation results. For setting methods, refer to the descriptions in "*Parameter Setting Method*". You can also directly rotate **Wave Vertical**  **POSITION** or enable the touch screen to adjust the vertical offset.

- Press **Scale** to set the vertical scale of the operation results. For setting methods, refer to the descriptions in "*Parameter Setting Method*". You can also directly rotate **Wave Vertical**  **SCALE** or enable the touch screen to adjust the vertical Scale.
- Press **More** > **AutoSetting** to adjust the vertical scale and offset of the operation results to an optimal value based on the current configuration, so as to better observe.
- Press **More** > **Invert** to enable or disable the inverted display function of the waveform.
- Press **More** > **Expand** to expand or compress waveform around the "Center" or "GND".
- Press **More** > **Label** to set the label for math operation results. For details, refer to descriptions in "*Math Operation Label*".
- Press **More** > **Color Grade** to enable or disable the color grade display of the operation results. When enabled, different colors are displayed on the screen to indicate the times of data acquisition or acquisition probability.
- Press **More** > **Reset ColorGrade** to clear the color grade display and display the color grade again.

9.1.23 Math Operation Label

Press **Label** to enter the label setting menu.

- Press **Display** continuously to enable or disable the label display of the waveform. If it is enabled, the label will be displayed at the left side of the waveform.
- Press **Library** to select the preset waveform label, including ADD, SUB, MUL, DIV, FFT, AND, OR, XOR, NOT, Intg, Diff, Sqrt, Lg, Ln, Exp, Abs, LPas, HPas, BPas, Bstop, and AX+B.
- Press **Label**, and the label editing interface is automatically displayed. You can input the label manually. For details, refer to descriptions in "*Channel Label*".





9.2 Auto Measurement

This series oscilloscope provides auto measurements for 41 waveform parameters, enabling users to make statistics and analysis of the measurement results.

9.2.1 Quick Measurement after AUTO

When the oscilloscope is correctly connected and has detected a valid input signal,

press  to enable the waveform auto setting function and open the auto setting function menu.

- : Press this key, and then the single period of the signal is displayed automatically on the screen. Meanwhile, the system will make measurements for the "Period" and "frequency" of the currently displayed waveforms in a of single period. The measurement results are displayed at the bottom of the screen.
- : Press this key, and then multiple periods of the signal are displayed automatically on the screen. Meanwhile, the system will make measurements for the "Period" and "frequency" of the currently displayed waveforms in multiple periods. The measurement results are displayed at the bottom of the screen.
- : Press this key, and then one rising edge of the signal is displayed automatically on the screen. Meanwhile, the system will make measurements for the "rise time" of the currently displayed rising edge. The measurement results are displayed at the bottom of the screen. By default, it is intended for the fast edge signal.
- : Press this key, and then one falling edge of the signal is displayed automatically on the screen. Meanwhile, the system will make measurements for the "fall time" of the currently displayed falling edge. The measurement results are displayed at the bottom of the screen. By default, it is intended for the fast edge signal.
- : Press this key, and the system returns to the last set menu.
- Press **Option** to enter the auto setting function menu.

- Press **Lock** to lock the AUTO function. To unlock the AUTO function, use the following two methods:

Method 1: Send the remote command :SYSTEM:AUTOscale ON to unlock the AUTO function.



Method 2: Press **Lock** again, then a password input dialog box is displayed. Input the password. By default, there is no password, and press OK to unlock the function.

NOTE

If you lock the Auto function and then exit the auto setting function menu, you can

press  > **More** > **Auto Config** to enter the auto setting function menu again to unlock the Auto function.



- Press **Peak to Peak** to enable or disable the peak-peak priority setting. This function is intended for the shifted signal. If there is a large deviation, you can view the signal waveform in priority when you enable the function.
- Press **CH** to select "All" or "Open".

If you select "All", press  and the system will test the 4 analog channels (CH1-CH4) in sequence. If no signal is found on the channel, then the channel is disabled; if a signal is found on the channel, adjust the channel to an optimal scale to display the signal. If you select "Open", press  and the system will only test the enabled channels.

- Press **Overlay** to enable or disable the waveform overlay display function. If enabled, waveforms of different channels will be displayed in the same position of the screen; if disabled, waveforms of different channels will be displayed on the screen from top to bottom in sequence.
- Press **Coupling** to enable or disable the coupling hold function. If enabled, after you press , the settings for the channel coupling remain unchanged; if disabled, then the channel coupling is, by default, set to "DC".
- Press **Password**, and then the password reset dialog box is displayed, as shown in the figure below. You can reset the password. The initial password

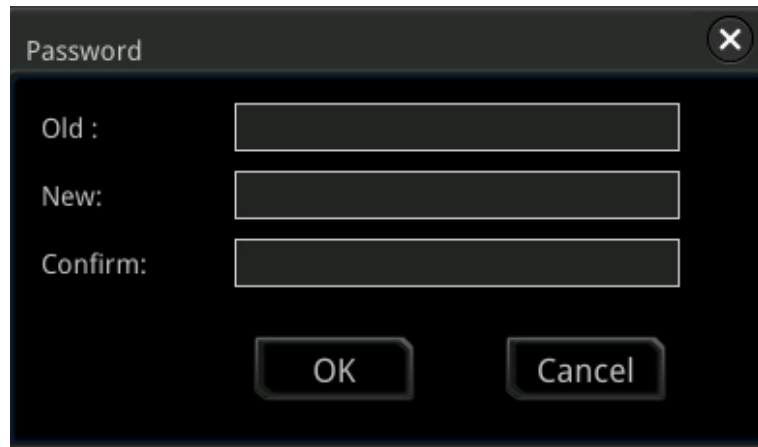
is empty. You do not need to input the old password when you reset the password for the first time.



- : Press this key to cancel the auto setting and recovers to the parameter settings prior to pressing the  key.

NOTE

The waveform auto setting function requires that the frequency of the signal should be greater than or equal to 35 Hz, the amplitude greater than or equal to 5 mV. Otherwise, the waveform auto setting function may be invalid.

9.2.2 Measurement Parameter

Press  on the front panel to enter the measurement setting menu. You can set the measurement source, enable or disable the all measurement function, the statistical analysis function, and etc. You can also quickly make measurements for 41 waveform parameters. The measurement results will be displayed on the screen. The measurement results on the screen are always marked in the same color as the current measurement channel. You can also enable the touch screen and tap the auto measurement label "MEASURE" at the top of the screen to enter the measurement setting menu.

NOTE

If there is no signal input for the current source or the measurement result is not within the valid range (too large or too small), then the measurement results are invalid, and "*****" is displayed on the screen. Please re-input the signal or set the signal.

Time Parameters

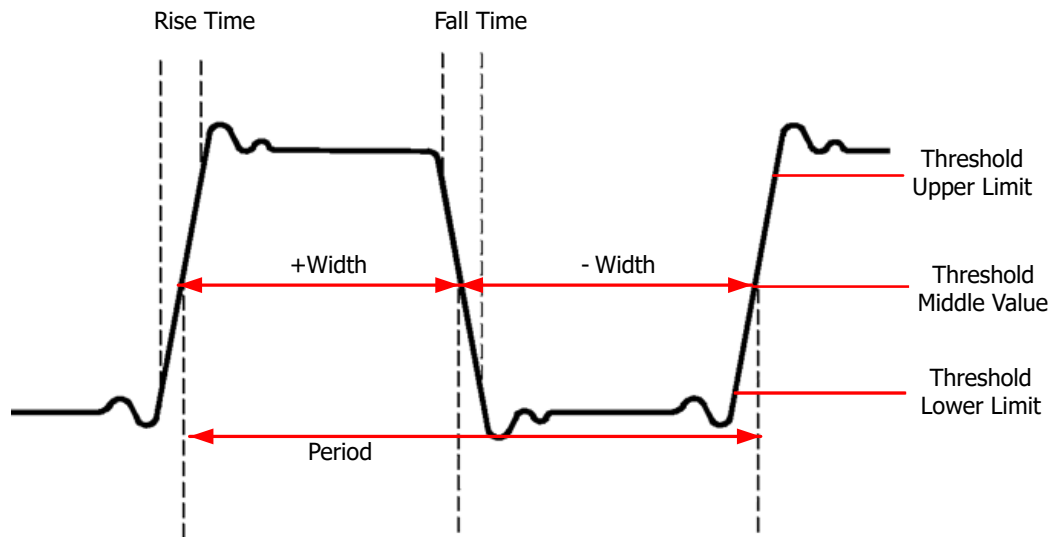



Figure 9.1 Time Parameters

1. **Period:** defined as the time between the middle threshold points of two consecutive, like-polarity edges.
2. **Frequency:** defined as the reciprocal of period.
3. **Rise Time:** indicates the time for the signal amplitude to rise from the threshold lower limit to the threshold upper limit.
4. **Fall Time:** indicates the time for the signal amplitude to rise from the threshold upper limit to the threshold lower limit.
5. **+Width:** indicates the time between the threshold middle value of a rising edge to the threshold middle value of the next falling edge.
6. **-Width:** indicates the time between the threshold middle value of a falling edge to the threshold middle value of the next rising edge.
7. **+Duty:** indicates the ratio of the positive pulse width to the period.
8. **-Duty:** indicates the ratio of the negative pulse width to the period.
9. **Tvmax:** indicates the time that corresponds to the maximum value of the waveform (V_{max}).
10. **Tvmin:** indicates the time that corresponds to the minimum value of the waveform (V_{min}).



NOTE

The default values for threshold upper limit, threshold middle value, and threshold low limit are 90%, 50%, and 10%, respectively. You can press  > **Setting** to enter the sub-menu to set the parameters.

Count Values

1. Positive Pulse Count: The number of positive pulses that rise from under the threshold lower limit to above the threshold upper limit.

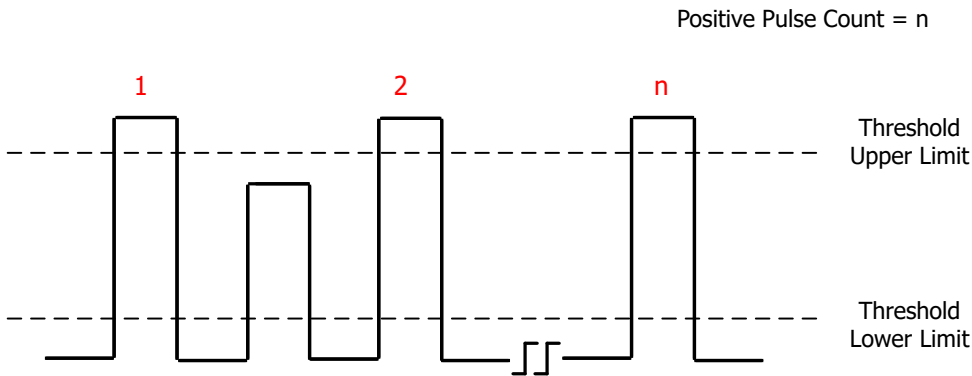

2. Negative Pulse Count: The number of negative pulses that fall from above the threshold upper limit to below the threshold lower limit.

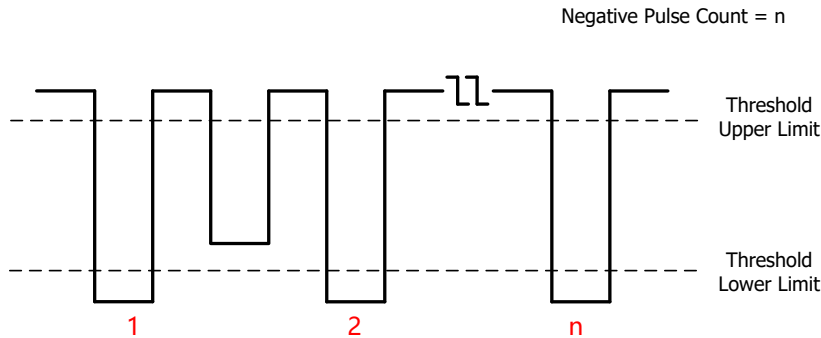

3. Rising Edge Count: The number of rising edges that rise from under the threshold lower limit to above the threshold upper limit.

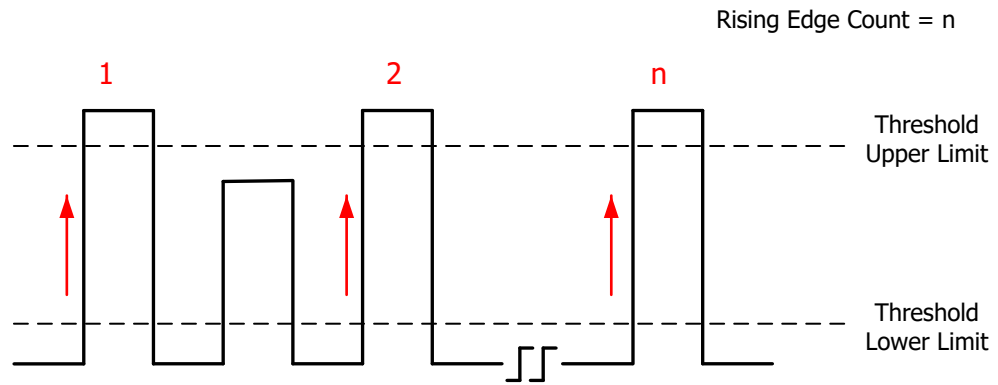

4. Falling Edge Count: The number of falling edges that fall from above the threshold upper limit to below the threshold lower limit.

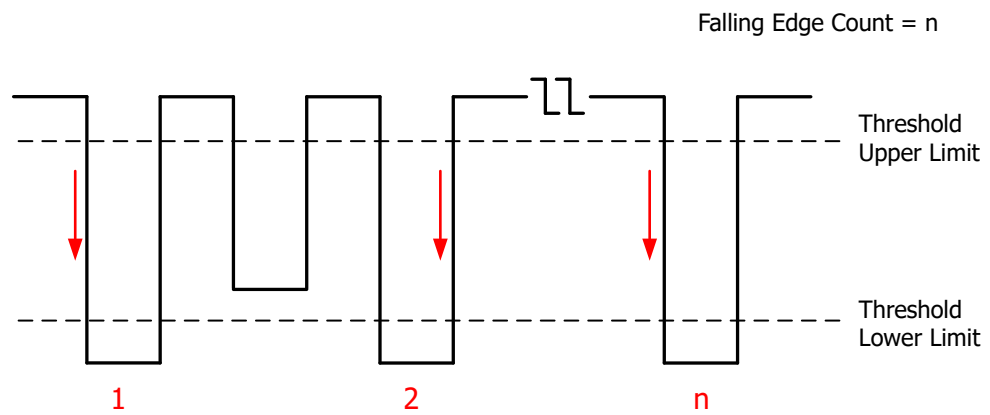

NOTE

- The above measurement items are only available for the analog channels.
- The default values for threshold upper limit and threshold low limit are 90% and 10%, respectively. You can press  > **Setting** to enter the sub-menu to set the parameters.

Delay and Phase Parameters

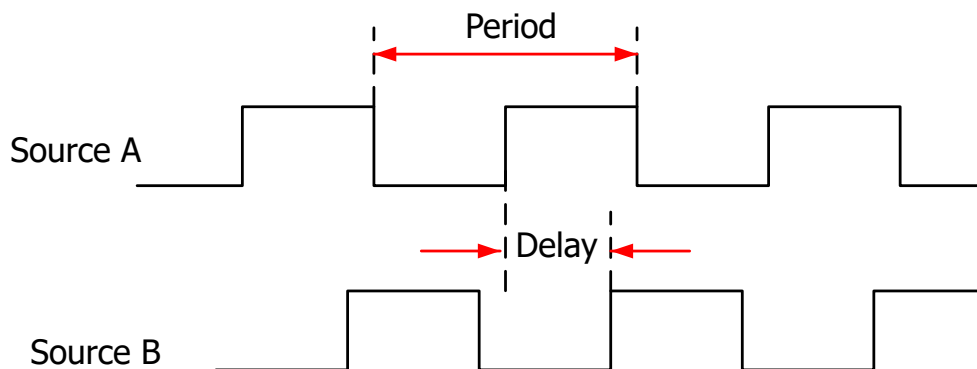

1. **Delay $A^f \rightarrow B^f$** : indicates the time difference between the threshold middle values on the rising edge of Source A and that of Source B. Negative delay indicates that the rising edge of Source A occurred after that of Source B.
2. **Delay $A^{\bar{f}} \rightarrow B^{\bar{f}}$** : indicates the time difference between the threshold middle values on the falling edge of Source A and that of Source B. Negative delay indicates that the falling edge of Source A occurred after that of Source B.
3. **Delay $A^f \rightarrow B^{\bar{f}}$** : indicates the time difference between the threshold middle values on the rising edge of Source A and the falling edge of Source B. Negative delay indicates that the rising edge of Source A occurred after the falling edge of Source B.
4. **Delay $A^{\bar{f}} \rightarrow B^f$** : indicates the time difference between the threshold middle values on the falling edge of Source A and the rising edge of Source B. Negative delay indicates that the falling edge of Source A occurred after the rising edge of Source B.
5. **Phase $A^f \rightarrow B^f$** : indicates the phase deviation between the threshold middle values on the rising edge of Source A and that of Source B. The phase formula is as follows:

$$Phase_{A_R B_R} = \frac{Delay_{A_R B_R}}{Period_{sourceA}} \times 360^\circ$$

Wherein, $Phase_{A_R B_R}$ represents Phase $A^f \rightarrow B^f$, $Delay_{A_R B_R}$ represents Delay $A^f \rightarrow B^f$, and $Period_{sourceA}$ represents period of Source A.

6. **Phase $A^{\bar{f}} \rightarrow B^{\bar{f}}$** : indicates the phase deviation between the threshold middle values on the falling edge of Source A and that of Source B. The phase formula is as follows:

$$Phase_{A_F B_F} = \frac{Delay_{A_F B_F}}{Period_{sourceA}} \times 360^\circ$$

Wherein, $Phase_{A_F B_F}$ represents Phase $A^{\bar{f}} \rightarrow B^{\bar{f}}$, $Delay_{A_F B_F}$ represents Delay $A^{\bar{f}} \rightarrow B^{\bar{f}}$, and $Period_{sourceA}$ represents period of Source A.

7. Phase $A_{R} \rightarrow B_{F}$: indicates the phase deviation between the threshold middle values on the rising edge of Source A and falling edge of Source B. The phase formula is as follows:

$$Phase_{A_{R} B_{F}} = \frac{Delay_{A_{R} B_{F}}}{Period_{sourceA}} \times 360^{\circ}$$

Wherein, $Phase_{A_{R} B_{F}}$ represents Phase $A_{R} \rightarrow B_{F}$, $Delay_{A_{R} B_{F}}$ represents Delay $A_{R} \rightarrow B_{F}$, and $Period_{sourceA}$ represents period of Source A.

8. Phase $A_{F} \rightarrow B_{R}$: indicates the phase deviation between the threshold middle values on the falling edge of Source A and the rising edge of Source B. The phase formula is as follows:

$$Phase_{A_{F} B_{R}} = \frac{Delay_{A_{F} B_{R}}}{Period_{sourceA}} \times 360^{\circ}$$

Wherein, $Phase_{A_{F} B_{R}}$ represents Phase $A_{F} \rightarrow B_{R}$, $Delay_{A_{F} B_{R}}$ represents Delay $A_{F} \rightarrow B_{R}$, and $Period_{sourceA}$ represents period of Source A.



NOTE

- Source A and Source B can be any channel among CH1-CH4, Math1-Math4, and D0-D15.

You can press  > **Add** to enter the sub-menu to set the parameters.

- The default threshold middle value is 50%. You can press  > **Setting** to enter the sub-menu to set the parameters.

Voltage Parameters

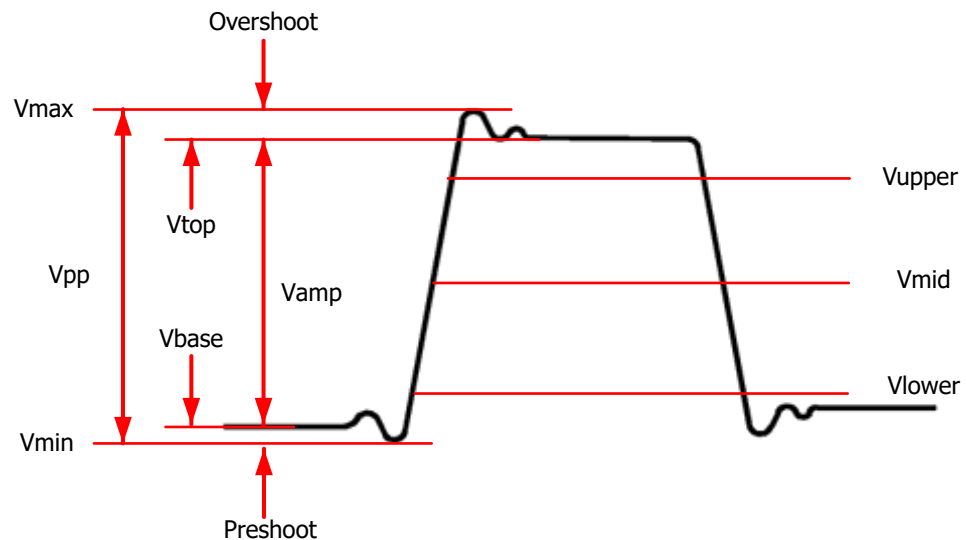

Figure 9.2 Voltage Parameters

1. **Vmax:** indicates the voltage value from the highest point of the waveform to the GND.
2. **Vmin:** indicates the voltage value from the lowest point of the waveform to the GND.
3. **Vpp:** the voltage value from the highest point to the lowest point of the waveform.
4. **Vtop:** indicates the voltage value from the flat top of the waveform to the GND.
5. **Vbase:** indicates the voltage value from the flat base of the waveform to the GND.
6. **Vamp:** indicates the voltage value from the top of the waveform to the base of the waveform.
7. **Vupper:** indicates the actual voltage value that corresponds to the threshold maximum value.
8. **Vmid:** indicates the actual voltage value that corresponds to the threshold middle value.
9. **Vlower:** indicates the actual voltage value that corresponds to the threshold minimum value.
10. **Vavg:** indicates the arithmetic average value on the whole waveform or in the gating area. The formula is shown as follows:

$$Average = \frac{\sum_{i=1}^n x_i}{n}$$

Wherein, x_i is the measurement result of the i th point, and n is the number of points being measured.

- 11. RMS:** indicates the root mean square value on the whole waveform or in the gating area. The formula is as follows.

$$RMS = \sqrt{\frac{\sum_{i=1}^n x_i^2}{n}}$$

Wherein, x_i is the measurement result of the i th point, and n is the number of points being measured.

- 12. Per.VRMS:** indicates the root mean square value within a period. The formula is as shown above.
- 13. Overshoot:** indicates the ratio of the difference between the maximum value and the top value of the waveform to the amplitude value.
- 14. Preshoot:** indicates the ratio of the difference between the minimum value and the base value of the waveform to the amplitude value.
- 15. Std. Dev:** indicates the root-mean-square value of the waveforms, with the DC component removed. The formula is shown as follows:

$$Std.Dev = \sqrt{\frac{\sum_{i=1}^n (x_i - Average)^2}{n}}$$

Wherein, x_i is the amplitude of the i th point, $Average$ is the waveform average value, and n is the number of the points being measured.



Other Parameters

- 1. +SlewRate:** On the rising edge, first calculate the difference between the high value and the low value, then use the difference to divide the corresponding time value to obtain the positive slew rate.
- 2. -SlewRate:** On the falling edge, first calculate the difference between the low value and the high value, then use the difference to divide the corresponding time value to obtain the negative slew rate.

- 3. Area:** indicates the area of the whole waveform within the screen. The unit is V*s. The area of the waveform above the zero reference (namely the vertical offset) is positive, and the area of the waveform below the zero reference is negative. The area measured is the algebraic sum of the area of the whole waveform within the screen.
- 4. Period Area:** indicates the area of the first period of waveform on the screen. The unit is V*s. The area of the waveform above the zero reference (namely the vertical offset) is positive, and the area of the waveform below the zero reference is negative. The area measured is the algebraic sum of the whole period area.

9.2.3 Measurement Settings

1. Measure Category

Press  > **Add** > **Category** to select "Horizontal", "Vertical", or "Other". Meanwhile, the specific measurement parameters are displayed on the screen, as shown in the figure below. You can also rotate the multifunction knob  to select "Horizontal", "Vertical", or "Other". Then press down the knob to select it.

- "Horizontal" measurement parameters: Period, Frequency, Rise Time, Fall Time, +Width, -Width, +Duty, -Duty, Positive Pulse Count, Negative Pulse Count, Rising Edge Count, Falling Edge Count, Tvmax, Tvmin, +Slew Rate, and -Slew Rate.
- "Vertical" measurement parameters: Vmax, Vmin, Vpp, Vtop, Vbase, Vamp, Vupper, Vmid, Vlower, Vavg, VRMS, Per. VRMS, Overshoot, Preshoot, Area, Period Area, and Std Dev.
- "Other" measurement parameters: Delay $A_f \rightarrow B_f$, Delay $A_t \rightarrow B_t$, Delay $A_f \rightarrow B_t$, Delay $A_t \rightarrow B_f$, Phase $A_f \rightarrow B_f$, Phase $A_t \rightarrow B_t$, Phase $A_f \rightarrow B_t$, and Phase $A_t \rightarrow B_f$.

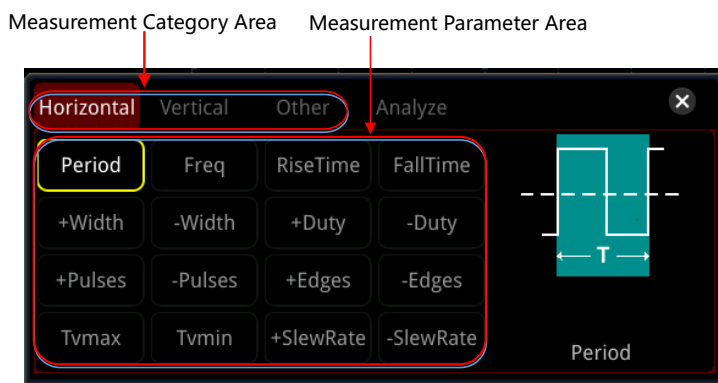

In the measurement parameter interface, rotate the multifunction knob  to select a measurement item and then press down the knob to select it. Then the measurement results of the item are displayed at the bottom of the screen (measurement results of up to 10 items can be displayed at most). When you add a new measurement item, its measurement result will be displayed as the first, with the original items moving right in sequence. When you add a new measurement item after ten items have been added, the last item at the bottom of the screen will be closed. You can also enable the touch screen to tap the specified measurement category and measurement item.

TIP

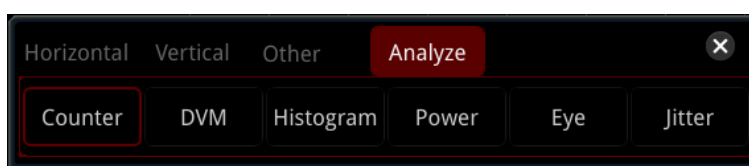

- When you rotate the multifunction knob to switch between the measurement parameter area and the measurement category, you need to press down the knob to select the desired measurement category.
- In the measurement category area, rotate the multifunction knob  to select "Analyze". The following figure is displayed. Select "Counter", "DVM", "Histogram", "Power" (required to install the option MSO8000-PWR), "Eye", or "Jitter" (required to install the option MSO8000-JITTER when "Eye" or "Jitter" is selected) to open the specified menu. For description about these functions, refer to relevant chapters.



2. Source Selection

For different measurement categories, the selection methods for measurement sources are different.



- Horizontal and vertical parameter measurement

Press  > **Add** > **Source A**, then rotate the multifunction knob  to select the desired channel for measurement and press down the knob to select it. You can also press **Source A** continuously or enable the touch screen to select it. The available channels include CH1-CH4, Math1-Math4, and D0-D15.

- Other (Delay and Phase) parameter measurement

Press  > **Add** > **Source A (Source B)** to set the two source channels for the current measurement category. The available channels include CH1-CH4, Math1-Math4, and D0-D15.

3. Edge Setting

Press  > **Add** > **EdgeSet** to set the EdgeA Event, EdgeB Event, EdgeA Number, and EdgeB Number. You can rotate the multifunction knob  to select "Auto", "First", "Last", or "Any Edge" for the EdgeA Event or EdgeB Event. Then press down the knob to select it. When EdgeA Event or EdgeB Event selects "Any Edge", you can set the EdgeA Number and EdgeB Number. The range is from 1 to 1,000.

- First: selects the first edge searched across the screen range to measure.
- Last: selects the last edge searched across the screen range to measure.
- Auto: selects the nearest edge to measure according to the principle of proximity. By default, "Auto" is selected.
- Any Edge: selects any edge searched across the screen range to measure.

NOTE

Only in "Other" measurement category, can you set these parameters. To select "Other" measurement category, press  > **Add** > **Category** to set the measurement category to "Other".

4. Indicator

Press **Indicator** continuously to enable or disable the indicator. You can also press  > **Remove** > **Indicator** to enable or disable the indicator. For details, refer to descriptions in *Measure Mode*.

5. Measurement Settings



Press **Settings** to enter the sub-menu of measurement.

- Press **Mode** to select the measurement mode to "Normal" or "Precision".
 - Normal: executes measurement of up to 1 Mpts.
 - Precision: executes measurement of up to 200 Mpts, improving the resolution of measurement results. In this mode, the refresh rate of the waveforms may be reduced.

- Press **Type** to select "Threshold", "Range", or "Amp Method".
 - Select "Threshold", and then make the following settings:
 - Press **Source** to select the desired channel for measurement (CH1-CH4 or Math1-Math4).
 - Press **Upper** to select "Upper(%)" or "Upper(Abs)" first, and then press the key to set the upper limit of the measurement. For details, refer to descriptions in "*Parameter Setting Method*". When the upper limit is set to be smaller than or equal to the current middle value, a prompt message "Set at lower limit" is displayed. Then, the oscilloscope will automatically adjust the upper limit and make it greater than the middle value. By default, it is 90%.
 - Press **Mid** to select "Mid(%)" or "Mid(Abs)" first, and then press the key to set the middle value of the measurement. For details, refer to descriptions in "*Parameter Setting Method*". The middle value is limited by the settings of the upper limit and lower limit. By default, it is 50%.
 - Press **Lower** to select "Lower(%)" or "Lower(Abs)" first, and then press the key to set the lower limit of the measurement. For details, refer to descriptions in "*Parameter Setting Method*". When the lower limit is set to be greater than or equal to the current middle value, a prompt message "Set at upper limit" is displayed. Then, the oscilloscope will automatically adjust the lower limit and make it smaller than the middle value. By default, it is 10%.
 - Press **Default**, and then the upper value, middle value, and lower value will be restored to the defaults.
 - Select "Range", and then press **Region** to select "Main", "Zoom", or "Cursor".
 - Main: indicates that the measurement range is within the main time base region.
 - Zoom: indicates that the measurement range is within the zoomed time base region.

NOTE

Only when you enable the delayed sweep function first, can "Zoom" be enabled.

--Cursor: when you select it, two cursors will be displayed on the screen. At this time, press **CursorA** and **CursorB** respectively and then rotate the multifunction knob  to adjust the positions of the two cursors to determine the measurement range. Also, you can press **CursorAB** and then rotate the multifunction knob  to adjust the positions of the two cursors simultaneously.

- Select "Amp Method", and then press **Amp Method** to select "Auto" or "Manual". This method affects the measurement method for the top and base values. If you select "Manual", you need to set the following parameters:
 - Press **Top** to select "Histogram" or "Max-Min".
 - Press **Base** to select "Histogram" or "Max-Min".



**NOTE**

- Modifying the threshold will affect the measurement results of time, delay and phase parameters.
- If you select "Manual" for the amplitude method, the measurement results of other parameters may be affected.
- "Histogram" and "Max-Min" are the internal measurement algorithm for the oscilloscope. The "Histogram" method here is different from the Histogram function of the oscilloscope.

9.2.4 Remove the Measurement Result

This oscilloscope allows you to remove the measurement results of the parameters.

Press  > **Remove** to enter the "Remove" sub-menu.

- Press **Remove** to remove the last added measurement item. Note that pressing this key one time can only remove one measurement item. When you remove a measurement item, the measurement result of the last added item at the bottom of the screen will be removed. You can rotate the multifunction knob  to switch the measurement item, then press down the knob  or press **Remove** to remove the item. You can also enable the touch screen to tap the desired measurement item, and then press **Remove** to remove the item.
- Press **Remove All** to remove all the displayed measurement items.
- Press **Indicator** to enable or disable the indicator.

Besides, you can also press  > **Add** > **Remove** to enter the "Remove" sub-menu.

**TIP**

If the "Remove" sub-menu is not displayed in the current menu, when you select a certain measurement item, the system will automatically enter the "Remove" sub-menu.

9.2.5 Statistical Function

Performs statistics and displays the measurement results (Cur, Avg, Max, Min, Dev, and Cnt) of at most 10 items, as shown in the figure below.

	Vpp2	Vmax2
Cur:	20.922mV	12.553mV
Avg:	22.414mV	13.512mV
Max:	33.475mV	20.922mV
Min:	16.737mV	8.3688mV
Dev:	2.1923mV	1.7656mV
Cnt:	1000	1000

Press  > **Statistic** to enter the sub-menu of "Statistic".

- Press **Statistic** to enable or disable the statistical function.
- Press **Reset Stat.** to clear the history statistics data and makes parameters statistics again.
- Press **Count**, then rotate the multifunction knob  or use the pop-up numeric keypad to set the count value. Its range is from 2 to 100000. Its default value is 1000.

9.2.6 All Measurement

All measurement could measure the time parameter, count value, voltage parameters, and other parameters of the current measurement source and display the results on

the screen. Press  > **All Measure** to select "OFF" (disabling the all measurement function) or select the desired channel for measurement (CH1-CH4). If you select "CH1", data of all measurement parameters of CH1 are displayed on the screen.

NOTE

The removal operation will not clear the measurement results of the all-measurement function.

9.3 Cursor Measurement

Cursor measurement can measure the X axis values (e.g Time) and Y axis values (e.g. Voltage) of the selected waveform. Before making cursor measurement, connect the signal to the oscilloscope to acquire stable display. All the parameters supported by

the "*Auto Measurement*" function can be measured with cursor measurement. The cursor measurement function provides the following two cursors.

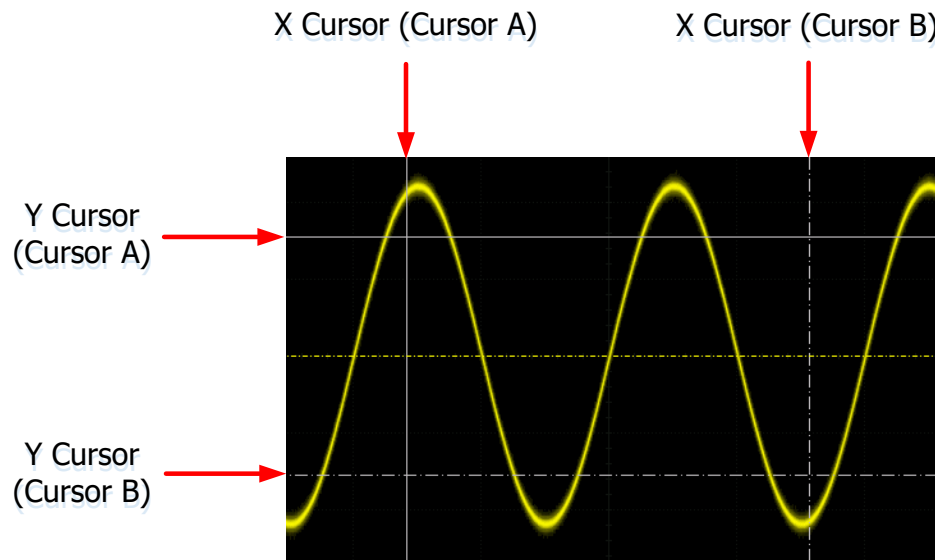

- **X Cursor**

X cursor is a vertical solid/dotted line that is used to make horizontal adjustments. It can be used to measure time (s), frequency (Hz), phase ($^{\circ}$), and ratio (%).



- Cursor A is a vertical solid line (AX is displayed at the bottom of the screen), and Cursor B is a vertical dotted line (BX is displayed at the bottom of the screen).
- In the X-Y cursor mode, X cursor is used to measure the waveform amplitude of CH1.

- **Y Cursor**

Y cursor is a horizontal solid/dotted line that is used to make vertical adjustment. It can be used to measure amplitude (the unit is the same as that of the source channel amplitude) and ratio (%).

- Cursor A is a horizontal solid line (AY is displayed at the bottom of the screen), and Cursor B is a horizontal dotted line (BY is displayed at the bottom of the screen).

- In the X-Y cursor mode, Y cursor is used to measure the waveform amplitude of CH2.

Press  on the front panel to open the cursor measurement menu, or enable the touch screen and then tap the function navigation icon  at the lower-left corner of the screen to open the function navigation. Then, tap the "Cursor" icon to open the cursor measurement menu.

In the cursor measurement menu, press **Mode** and then rotate the multifunction knob  to select the desired cursor mode (the default is "OFF"). Press down the knob to select it. You can also press **Mode** continuously or enable the touch screen to select it. The available modes are "Manual", "Track", "XY", and "Measure". When you select "OFF", the cursor measurement function is disabled.



NOTE

- When the Time Base Mode is set to "XY", the XY cursor measurement mode is valid.
- No cursor will be displayed if no cursor measurement parameter is selected or the measurement source has no input.
- When the waveform is expanded or compressed horizontally, the cursor will change accordingly.

9.3.1 Manual Mode

In this mode, you can adjust the cursor manually to measure the value of the waveforms of the specified source at the current cursor. The measurement results are displayed at the upper-left corner of the screen. When you change the cursor position, the measurement results will be changed accordingly.

Press **Mode** to select "Manual" to enable the manual cursor measurement function. If the settings for the parameter such as the cursor type, measurement source, horizontal measurement unit, and vertical measurement unit are different, the measurement results will be different for cursor measurement. The measurement results are displayed at the upper-left corner of the screen, as shown in the figure below.

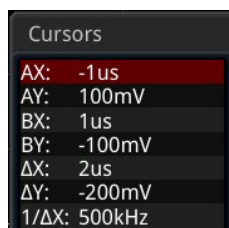

- AX: indicates the X value at Cursor A.
- AY: indicates the Y value at Cursor A.

- BX: indicates the X value at Cursor B.
- BY: indicates the Y value at Cursor B.
- ΔX : indicates the horizontal spacing between Cursor A and Cursor B.
- ΔY : indicates the vertical spacing between Cursor A and Cursor B.
- $1/\Delta X$: indicates the reciprocal of the horizontal spacing between Cursor A and Cursor B.

1. Select the Cursor Type

Press **Select** continuously to select the cursor type.

- X-X: It is a pair of vertical solid (Cursor A)/dotted (Cursor B) lines, used for measuring time parameters. The measurement results include AX, BX, ΔX , and $1/\Delta X$ (displayed only when "s" or "Hz" is selected under Hori. Unit).
- Y-Y: It is a pair of horizontal solid (Cursor A)/dotted (Cursor B) lines, used for measuring voltage parameters. The measurement results include AY, BY, and ΔY .
- XY-X: when this mode is selected, X cursors and Y cursors are both displayed. However, you can only set the AX and BX values. The measurement results of X cursors are the same as what you set in X-X mode.
- XY-Y: when this mode is selected, X cursors and Y cursors are both displayed. However, you can only set the AY and BY values. The measurement results of Y cursors are the same as what you set in Y-Y mode.

2. Select the Measurement Source

Press **Source**, rotate the multifunction knob  to select the measurement channel, and then press down the knob to select it. You can also press **Source** continuously or enable the touch screen to select it. The available source channels are NONE, CH1-CH4, LA, and Math1-Math4.

NOTE

- Only channels currently enabled can be selected.
- When "LA" is selected as the channel source, **Select** is grayed out and disabled. By default, "X" is selected under Select.

3. Adjust the Cursor Position

- When "X-X" is selected, you can adjust the position of X cursors.



- Press **AX**, then rotate the multifunction knob  to adjust the horizontal position (X-axis) of Cursor A (X cursor). Its adjustable range is limited within the screen.

Enable the touch screen and tap **AX** to set the horizontal position of Cursor A (X cursor) with the pop-up numeric keypad. The horizontal axis indicates time, and the unit of its setting value is the same as that of the horizontal unit.

- Press **BX**, then rotate the multifunction knob  to adjust the horizontal position (X-axis) of Cursor B (X cursor). Its adjustable range is limited within the screen.

Enable the touch screen and tap **BX** to set the horizontal position of Cursor B (X cursor) with the pop-up numeric keypad. The horizontal axis indicates time, and the unit of its setting value is the same as that of the horizontal unit.

- Press **AX BX**, then rotate the multifunction knob  to adjust the horizontal positions (X-axis) of Cursor A and Cursor B (X cursors). Its adjustable range is limited within the screen. The horizontal spacing between Cursor A and Cursor B (X cursors) remains unchanged.

b. When "Y-Y" is selected for the mode, you can adjust the position of Y cursors.

- Press **AY**, then rotate the multifunction knob  to adjust the vertical position (Y-axis) of Cursor A (Y cursor).

Enable the touch screen and tap **AY** to set the vertical position of Cursor A (Y cursor) with the pop-up numeric keypad. The vertical axis indicates voltage, and the unit of its setting value is the same as that of the vertical unit.

- Press **BY**, then rotate the multifunction knob  to adjust the vertical position (Y-axis) of Cursor B (Y cursor).

Enable the touch screen and tap **BY** to set the vertical position of Cursor B (Y cursor) with the pop-up numeric keypad. The vertical axis indicates voltage, and the unit of its setting value is the same as that of the vertical unit.

- Press **AY BY**, then rotate the multifunction knob  to adjust the vertical positions (Y-axis) of Cursor A and Cursor B (Y cursors). The vertical spacing between Cursor A and Cursor B (Y cursors) remains unchanged.

**NOTE**

If one of the three menu items (**AX**, **BX**, and **AX BX**) is selected; or one of the three menu items (**AY**, **BY**, and **AY BY**) is selected; you can press down the multifunction knob  continuously to switch among the three items.

4. Set the Horizontal/Vertical Measurement Unit

- When "X-X" is selected, you can set the horizontal measurement unit. When the source is set to Math1-Math4, this menu is grayed out and disabled.

Press **More** > **Hori. Unit**, then rotate the multifunction knob  to select the horizontal measurement unit, and then press down the knob to select it. You can also press **Hori. Unit** continuously or enable the touch screen to select it. The available units include "s", "Hz", "Degree(°)", and "Percent(%)".

- s: measures the time value at X Cursor (taking the trigger position as reference). The measurement results include AX, BX, ΔX , and $1/\Delta X$. Wherein, AX, BX, and ΔX all indicate time, and $1/\Delta X$ indicates frequency.
- Hz: measures the frequency value at X Cursor (taking the trigger position as reference). The measurement results include AX, BX, ΔX , and $1/\Delta X$. Wherein, AX, BX, and ΔX all indicate frequency, and $1/\Delta X$ indicates time.
- Degree(°): measures the phase value at X Cursor. The measurement results include AX, BX, and ΔX , and they are all expressed in degree.

This oscilloscope allows you to set the phase reference position according to your needs. After adjusting X Cursor to a desired position, press **Set Reference** to take the current cursor position as the reference. The current positions of Cursor A and Cursor B are respectively defined as "0°" and "360°". Meanwhile, two vertical cursors (in blue) that cannot be moved are displayed on the screen as the phase reference position (the phase position at "0°" and "360°" are respectively marked by a solid line and a dotted line). Before you set manually, the oscilloscope adopts the default phase reference position.

- Percent(%): measures ratio at X Cursor. The measurement results include AX, BX, and ΔX , and they are all expressed in percentage.

This oscilloscope allows you to set the ratio reference position according to your needs. After adjusting X Cursor to a desired position, press **Set Reference** to take the current cursor position as the reference. The current positions of Cursor A and Cursor B are respectively defined as "0%" and "100%". Meanwhile, two cursors (in blue) that cannot be moved are

displayed on the screen as the ratio reference position (the ratio position at "0%" and "100%" are respectively marked by a solid line and a dotted line). Before you set manually, the oscilloscope adopts the default ratio reference position.

- When "Y-Y" is selected, you can set the vertical measurement unit. When the source is set to Math1-Math4, this menu is grayed out and disabled.

Press **More** > **Vert. Unit**, then rotate the multifunction knob  to select the vertical measurement unit, and then press down the knob to select it. You can also press **Vert. Unit** continuously or enable the touch screen to select it. The available units include "Source" and "Percent(%)".

- Source: measures the amplitude at Y Cursor (taking the channel ground point as the reference). The measurement results include AY, BY, and ΔY (its unit is consistent with that of the current source).
- Percent(%): measures ratio at Y Cursor. The measurement results include AY, BY, and ΔY , and they are all expressed in percentage.

This oscilloscope allows you to set the ratio reference position according to your needs. After adjusting Y Cursor to a desired position, press **Set Reference** to take the current cursor position as the reference. The current positions of Cursor A and Cursor B are respectively defined as "0%" and "100%". Meanwhile, two cursors (in blue) that cannot be moved are displayed on the screen as the ratio reference position (the ratio position at "0%" and "100%" are respectively marked by a solid line and a dotted line). Before you set manually, the oscilloscope adopts the default ratio reference position.

5. Set LA Type

When the measurement source is set to "LA", you need to set the LA display type. Press **More**, and then press **La Type** continuously to select "HEX" or "BIN".

6. Measurement Example

Measure the period of a sine wave by using the manual cursor measurement and Auto measurement respectively. The measurement results are both 1 ms, as shown in *Figure 9.3*.

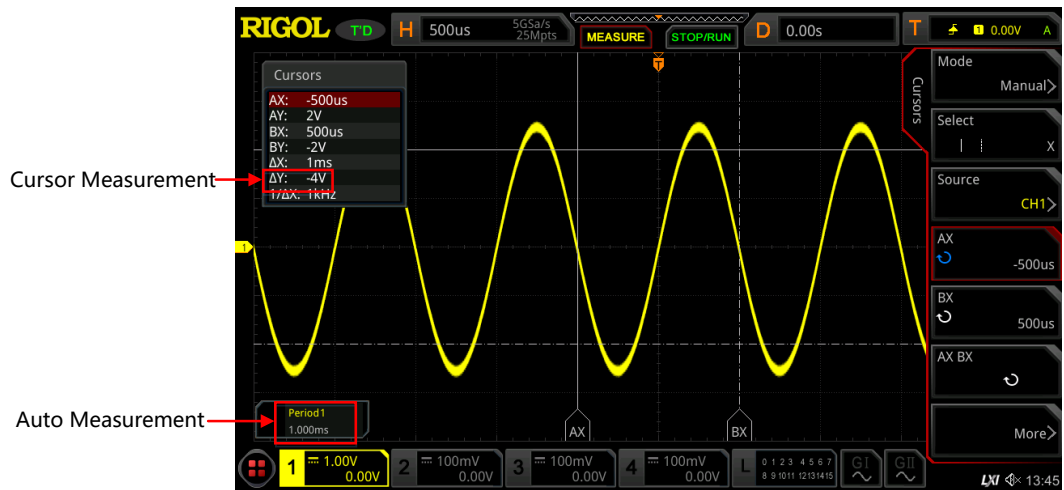

Figure 9.3 Manual Cursor Measurement Example

9.3.2 Track Mode

In this mode, you can adjust the two pairs of cursors (Cursor A and Cursor B) to measure the X and Y values on two different sources respectively. The points being measured on Cursor A and Cursor B are marked by ++ and -- respectively. When the cursors are moved horizontally/vertically, the markers will position on the waveform automatically. When the waveform is expanded or compressed horizontally/vertically, the markers will track the points being marked at the last adjustment of the cursors.

NOTE

When the delayed sweep function is enabled, the track cursor is within the expanded area.



Press **Mode** to select "Track" to enable the cursor track function. The measurement results will be displayed at the upper-left corner of the screen, as shown in the following figure. When you modify the Track measurement parameter, the measurement results will be changed accordingly.

Cursors	
AX:	-1us
AY:	-30.27mV
BX:	1us
BY:	-30.27mV
ΔX:	2us
ΔY:	0V
1/ΔX:	500kHz

- AX: indicates the X value at Cursor A.
- AY: indicates the Y value at Cursor A.
- BX: indicates the X value at Cursor B.

- BY: indicates the Y value at Cursor B.
- ΔX : indicates the horizontal spacing between Cursor A and Cursor B.
- ΔY : indicates the vertical spacing between Cursor A and Cursor B.
- $1/\Delta X$: indicates the reciprocal of the horizontal spacing between Cursor A and Cursor B.

1. Select the Measurement Source

- Press **AX Source**, rotate the multifunction knob  to select the measurement channel, and then press down the knob to select it. You can also press **AX Source** continuously or enable the touch screen to select it. The available source channels include NONE, CH1-CH4, and Math1-Math4.
- Press **BX Source**, rotate the multifunction knob  to select the measurement channel, and then press down the knob to select it. You can also press **BX Source** continuously or enable the touch screen to select it. The available source channels include NONE, CH1-CH4, and Math1-Math4.



NOTE

Only channels currently enabled can be selected.

2. Select the Track Cursor



Press **Track** to select "X" or "Y" as the current track cursor. By default, it is "X".

- X: tracks X Cursor and measures the value at X Cursor.
- Y: tracks Y Cursor and measures the time of the first point at the left side of the screen.



3. Adjust the Cursor Position

a. When "X" is selected for the track mode, you can adjust the position of X cursor.

- Press **AX**, then rotate the multifunction knob  to adjust the horizontal position (X-axis) of Cursor A (X cursor). Its adjustable range is limited within the screen.

- Press **BX**, then rotate the multifunction knob  to adjust the horizontal position (X-axis) of Cursor B (X cursor). Its adjustable range is limited within the screen.
- Press **AX BX**, then rotate the multifunction knob  to adjust the horizontal positions (X-axis) of Cursor A and Cursor B (X cursors). Its adjustable range is limited within the screen. The horizontal spacing between Cursor A and Cursor B (X cursors) remains unchanged.

b. When "Y" is selected for the track mode, you can adjust the position of Y cursor.

- Press **AY**, then rotate the multifunction knob  to adjust the vertical position (Y-axis) of Cursor A (Y cursor).
- Press **BY**, then rotate the multifunction knob  to adjust the vertical position (Y-axis) of Cursor B (Y cursor).
- Press **AY BY**, then rotate the multifunction knob  to adjust the vertical positions (Y-axis) of Cursor A and Cursor B (Y cursors). The vertical spacing between Cursor A and Cursor B (Y cursors) remains unchanged.



NOTE

- If one of the three menu items (**AX**, **BX**, and **AX BX**) is selected; or one of the three menu items (**AY**, **BY**, and **AY BY**) is selected; you can press down the multifunction knob  continuously to switch among the three items.
- In track mode, the horizontal cursor (or vertical cursor) will track the marked point in a timely manner (i.g, the cursor will move up and down with the transient change of the waveform). Thus, the X value (or Y value) might change even though you do not adjust the cursor.

4. Measurement Example

Measure the waveforms of CH1 and CH2 with Cursor A and Cursor B, respectively. Then, expand the waveforms horizontally, and you will find that the cursor will track the point that has been marked, as shown in the following figure.

Track Measurement (before Horizontal Expansion):

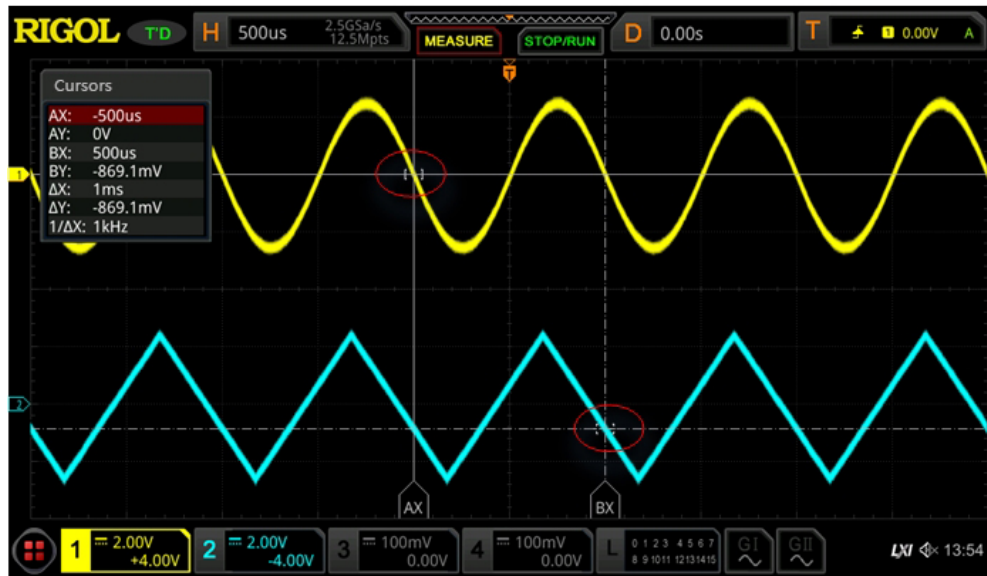

Track Measurement (after Horizontal Expansion):

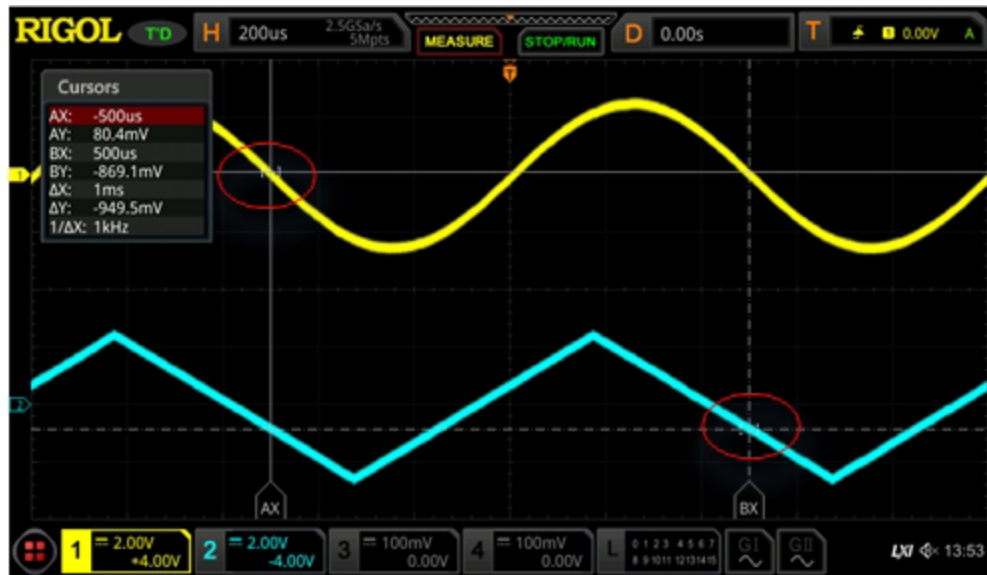

9.3.3 XY Mode





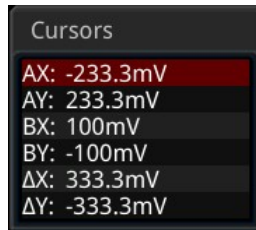

XY mode is only available when the horizontal time base mode is "XY" (refer to "*Timebase Mode*"). In this mode, two pairs of cursors will appear. You can adjust the cursor positions to measure the X and Y values at the crossing points of the two pairs of cursors.

Press **Mode** to select "XY" to enable the XY cursor measurement function. The measurement results will be displayed at the upper-left corner of the screen, as shown in the following figure.



- AX: indicates the X value at Cursor A.
- AY: indicates the Y value at Cursor A.
- BX: indicates the X value at Cursor B.
- BY: indicates the Y value at Cursor B.
- ΔX: indicates the horizontal spacing between Cursor A and Cursor B.
- ΔY: indicates the vertical spacing between Cursor A and Cursor B.

1. Adjust the Cursor Position

- Press **AX**, then rotate the multifunction knob  to adjust the X value at Cursor A.
- Press **BX**, then rotate the multifunction knob  to adjust the X value at Cursor B.
- Press **AY**, then rotate the multifunction knob  to adjust the Y value at Cursor A.
- Press **BY**, then rotate the multifunction knob  to adjust the Y value at Cursor B.
- Press **More** > **ABX**, then rotate the multifunction knob  to adjust the X values at Cursor A and Cursor B simultaneously.
- Press **More** > **ABY**, then rotate the multifunction knob  to adjust the Y values at at Cursor A and Cursor B simultaneously.

During the adjustment, the measurement results will change accordingly. The adjustable range is limited within the screen.

NOTE

If you select either of the items (**ABX** and **ABY**), you can press down the multifunction knob  continuously to switch between them.



2. Display Lissajous Legend

This oscilloscope provides the Lissajous schematic diagram under different frequencies and phase deviations, as shown in *Figure 9.4*. Press **More** > **Lissajous**, then the Lissajous schematic diagram is displayed.

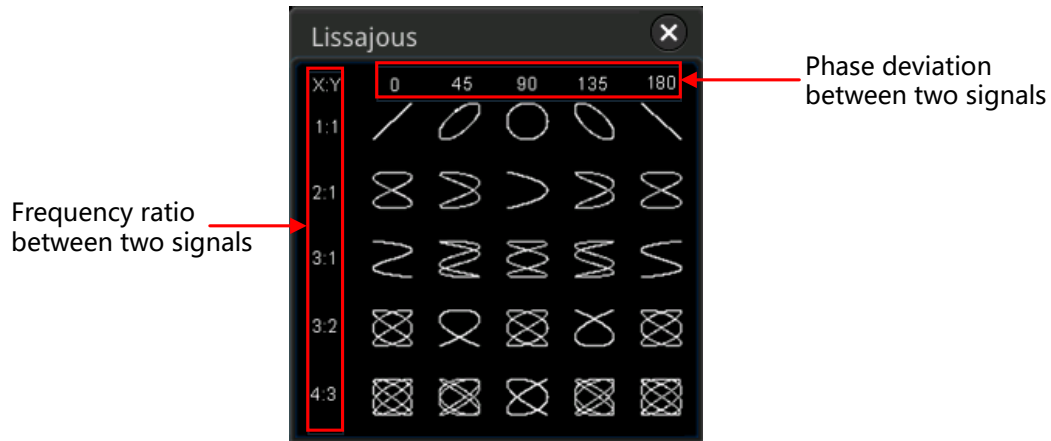

Figure 9.4 Lissajous Schematic Diagram

9.3.4 Measure Mode

Press **Mode** to select "Measure". In this mode, the cursor position for measurement is displayed.





Press **Indicator** continuously to enable or disable the Indicator. If it is enabled, one or multiple cursors are displayed on the screen. Before enabling the indicator, you need to enable at least one parameter for auto measurement. The number of cursors will change along with the enabled measurement parameters.

10 Digital Voltmeter (DVM) and Frequency Counter

This series oscilloscope provides a built-in digital voltmeter (DVM) and frequency counter, which enable you to perform an accurate measurement, improving user experience in counter and frequency measurement.

10.1 Digital Voltmeter (DVM)

The built-in DVM of this oscilloscope provides 3-digit voltage measurements on any analog channel. DVM measurements are asynchronous from the oscilloscope's acquisition system and are always acquiring.

Press  > **Analyze** > **DVM** to open the DVM setting menu, or enable the touch screen and then tap the function navigation icon  at the lower-left corner of the screen to open the function navigation. Then, tap the "DVM" icon to open the DVM setting menu. You can also press  > **Add**, then in the displayed measurement category area, rotate the multifunction knob  to select "Analyze", and then select "DVM" to open the DVM setting menu.

10.1.1 To Enable or Disable DVM Measurement

In the "DVM" setting menu, press the **DVM** continuously to enable or disable DVM measurement. When enabled, the following figure is displayed. The DVM display also has a scale that is determined by the channel's vertical scale and vertical offset. The scale range is the range of the screen. The scale's yellow triangle pointer shows the most recent measurement result. The specific value above the pointer shows the measurement extrema over the last 3 seconds.

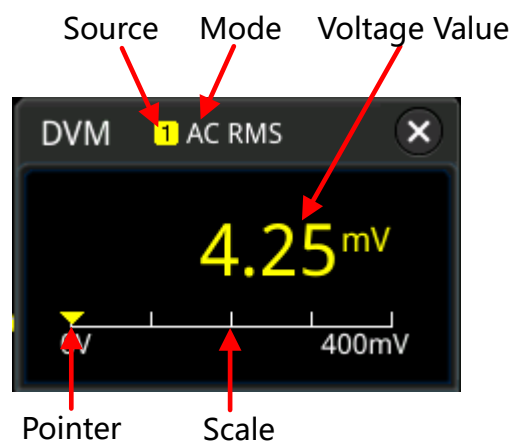

**NOTE**

DVM measurement and the oscilloscope share the same probe, so the unit for the DVM measurement is consistent with that of the channel.

10.1.2 To Select the Measurement Source

Press **Source** in the "DVM" setting menu, then rotate the multifunction knob  to select the desired source. You can also press **Source** continuously or enable the touch screen to select it. The analog channel (CH1-CH4) can be selected to be the measurement source.

**NOTE**

Even if the analog channel (CH1-CH4) is not enabled, you can still perform the DVM measurement.

10.1.3 To Select Measurement Mode

Press **Mode**, and rotate the multifunction knob  to select the desired Mode, and then press down the knob to select it. You can also press **Mode** continuously to select the mode or enable the touch screen to tap the desired mode and select it. The DVM measurement modes include AC RMS, DC, and AC+DC RMS.

- AC RMS: displays the root-mean-square value of the acquired data, with the DC component removed.
- DC: displays the average value of the acquired data.
- AC+ DC RMS: displays the root-mean-square value of the acquired data.

10.1.4 To Set the Limits

Press **Limits** to enter the sub-menu of Limits. Then set the following parameters.

- Beeper

Press **Beeper** continuously to enable or disable the Beeper.

- Limits Condition Setting

Press **When**, then rotate the multifunction knob  to select desired limit setting condition. Press down the knob to select it. You can also press **When** continuously or enable the touch screen to select it. The limits conditions include "In Limits" and "Out Limits".







- In Limits: when the voltage value is within the limits, you can enable or disable the beeper to sound an alarm.
- Out Limits: when the voltage value is outside of the limits, you can enable or disable the beeper to sound an alarm.
- Upper/Lower Limit Setting

Press **Upper**, then rotate the multifunction knob  or use the pop-up numeric keypad to set the upper limit of the voltage.

Press **Lower**, then rotate the multifunction knob  or use the pop-up numeric keypad to set the lower limit of the voltage.

10.2 Frequency Counter

The frequency counter analysis function provides frequency, period, or edge event counter measurements on any analog channel.

Press  > **Analyze** > **Counter** to open the Frequency Counter setting menu, or enable the touch screen and then tap the function navigation icon  at the lower-left corner of the screen to open the function navigation. Then, tap the "Counter" icon  to open the frequency counter setting menu. You can also directly press  > **Counter** on the front panel to enter the frequency counter setting menu. In addition, You can also press  > **Add**, then in the displayed measurement category area, rotate the multifunction knob  to select "Analyze", and then select "Counter" to open the frequency counter setting menu.

10.2.1 To Enable or Disable the Frequency Counter

In the "Counter" setting menu, press **Counter** continuously to enable or disable the frequency counter measurement. When enabled, the following figure is displayed.

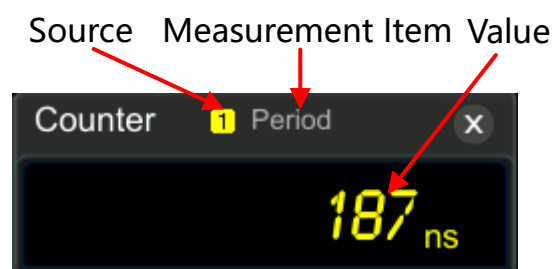

10.2.2 To Select the Measurement Source

Press **Source**, then rotate the multifunction knob  to select the desired source, and then press down the knob to select the source. You can also press **Source** continuously or enable the touch screen to select it. Analog channels (CH1-CH4), digital channels (D0-D15), and EXT can all be selected as the source of the frequency counter.

10.2.3 To Select the Measurement Item

The measurement items supported by the frequency counter of this oscilloscope include Frequency, Period, and Totalize measurements. Wherein, Totalize indicates the count of edge events on the signal.

Press **Measure** in the "Counter" menu, then rotate the multifunction knob  to select the desired measurement item, and then press down the knob to select the item. You can also press **Measure** continuously or enable the touch screen to tap the desired measurement item and select it.

10.2.4 To Set the Resolution

For Period and Frequency measurements, you need to set the readout resolution.

Press **Resolution**, then rotate the multifunction knob  or use the pop-up numeric keypad to set the resolution. The range of resolution is from 3 bits to 6 bits. By default, it is 5 bits.



NOTE

The greater the resolution, the longer the gate time. In this way, the measurement time will be longer.

10.2.5 To Clear Count

When "Totalize" is selected under **Measure**, the oscilloscope measures the count of edge events on the signal. At this time, press **Clear Count** to clear the measurement results.

10.2.6 To Enable or Disable the Statistical Function

For Period and Frequency measurements, you can enable the frequency counter statistical function. Press **Statistic** continuously to enable or disable the statistical function. When enabled, the maximum value and minimum value will be displayed in the frequency counter data, as shown in the following figure.

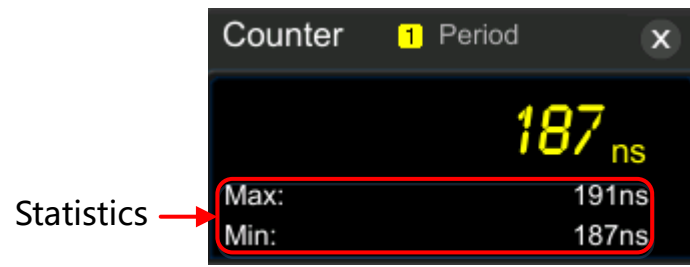





11 Power Analysis (Option)

The oscilloscope provides an optional power analysis function, which can help you easily analyze the efficiency and reliability of the switch-mode power supplies. With the power analysis function, you can analyze the power quality and output ripple noise of the input power.

11.1 Power Quality

By analyzing the power quality, you can test the quality of AC input lines. The specific measurement parameters for power quality analysis include V_RMS, I_RMS, real power, apparent power, reactive power, power factor, reference frequency, phase angle, impedance, voltage crest factor, and current crest factor.



Press  > **Analyze** > **Power Analyzer** to open the power analysis setting menu, or enable the touch screen and then tap the function navigation icon  at the lower-left corner of the touch screen to enable the function navigation. Then, tap the "Power" icon to open the power analysis setting menu. You can also press  > **Add**, then in the displayed parameter measurement category area, rotate the multifunction knob  to select the "Analyze" tab, then select "UPA" to open the power analysis setting menu.

- **Select the Analysis Type**

In the power analysis setting menu, press **Analysis Type** and rotate the multifunction knob  to select "Power Quality", and then press down the knob to select it. You can also press **Analysis Type** continuously or enable the touch screen to select the desired analysis type.

- **Set the Power Quality Analysis Source**

In the power analysis setting menu, press **Source** to enter the source setting menu.





- Press **Voltage** and rotate the multifunction knob  to select the channel (CH1-CH4) for acquiring voltage. Press down the knob to select it. You can also press **Voltage** continuously or enable the touch screen to select the channel.
- Press **Current** and rotate the multifunction knob  to select the channel (CH1-CH4) for acquiring current. Press down the knob to select it. You can

also press **Current** continuously or enable the touch screen to select the channel.

- Press **Freq. Ref** continuously to select "Voltage" or "Current" as the frequency reference.

- **Set the Reference Level**

Press **Ref Levels** (level of the frequency reference channel) to enter the reference level setting menu.

- Press **Type**, rotate the multifunction knob  to set the reference level display type to "Percent(%)" or "Absolute", and then press down the knob. You can also press **Type** continuously or enable the touch screen to select the type.
- Press **Upper**, then rotate the multifunction knob  or use the pop-up numeric keypad to set the upper limit value. Reducing the upper limit to the current middle value will automatically reduce the middle value and lower limit to keep them lower than the upper limit.
- Press **Mid**, then rotate the multifunction knob  or use the numeric keypad to set the middle value. The middle value is limited by the settings of the upper limit and lower limit.
- Press **Lower**, then rotate the multifunction knob  or use the numeric keypad to set the lower limit. Increasing the lower limit to the current middle value will automatically increase the middle value and upper limit to keep them higher than the lower limit.
- Press **Default**, and then the upper limit, middle value, and lower limit will be restored to the defaults.

- **Set Count**

Press **Count**, then rotate the multifunction knob  or use the numeric keypad to set the number of statistical times for power quality analysis. Its range is from 2 to 5000. By default, it is 1000.

- **Reset**

Press **Reset Stat.** to clear the current data and execute statistics on the measurement results again.

- **Open or Close the Results Display Window**

Press **Display** continuously to enable or disable the display of the results. When enabled, the statistical results will be displayed on the screen, as shown in the figure below. You can also enable the touch screen to tap the icon  at the right-upper corner of the statistical results window to close it.

NOTE

If you select "ON" under Display, the multiplication operation will be automatically enabled in the Math operation.

Power Quality						
	Curr	Avg	Max	Min	Dev	Cnt
V _{RMS} (1)	2.607V	1.794V	2.688V	0.000V	572.4mV	1000
I _{RMS} (2)	2.561A	1.713A	2.625A	0.000A	563.2mA	1000
Real Power(1)	-3.558W	-1.598W	2.166W	-3.586W	694.8mW	1000
Apparent Power(1-2)	6.679VA	3.394VA	7.052VA	0.000VA	1.514VA	1000
Reactive Power(1-2)	5.652VAR	6.029VAR	6.869VAR	3.323VAR	840.9mVAR	135
Power Factor(1-2)	-532.8m	-320.4m	436.4m	-536.0m	218.7m	135
Frequency(1)	20.00kHz	20.00kHz	20.16kHz	19.97kHz	21.16Hz	137
Phase Angle(1-2)	2.132°	1.903°	2.136°	1.119°	231.6m°	135
Impedance(1-2)	1.017Ω	1.004Ω	1.025Ω	720.1mΩ	61.68mΩ	135
V Crest Factor(1)	1.112	1.147	1.457	1.077	96.94m	135
I Crest Factor(2)	1.114	1.130	1.461	1.098	72.76m	135

- **View the Connection Diagram**

Press **Tips**, and then the connection diagram of the power quality analysis is displayed on the screen. Please connect the cables according to the connection method as shown in *Figure 11.1*. Press **Tips** again or enable the touch screen to tap the icon  at the right-upper corner of the connection diagram window to close it.

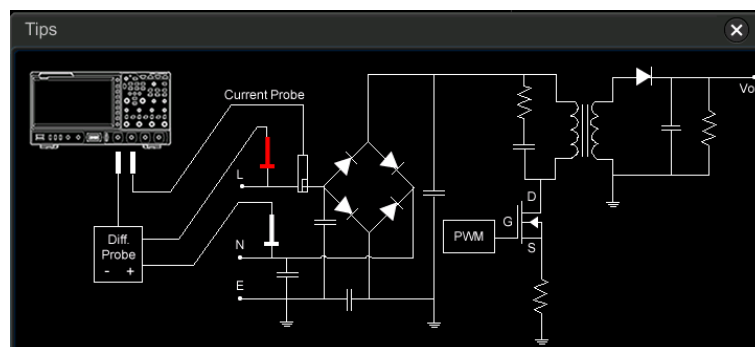

Figure 11.1 Connection Diagram of Power Quality Analysis

11.2 Ripple

Power ripple is an important parameter for evaluating DC power supply, which indicates the ripple quantity of the output DC voltage. The ripple analysis can measure the current value, average value, minimum value, maximum value, standard deviation, and count value of the ripples on the power output terminal.



NOTE

The 1X probe is recommended for the ripple measurement. For example, PVP2150 or PVP2350.

- **Select the Analysis Type**

In the power analysis setting menu, press **Analysis Type** and rotate the multifunction knob  to select "Ripple", and then press down the knob to select it. You can also press **Analysis Type** continuously or enable the touch screen to select the desired analysis type.

- **Set the Ripple Analysis Source**

Press **Source**, and rotate the multifunction knob  to select the ripple analysis source (CH1-CH4), then press down the knob to select the source. You can also press **Source** continuously or enable the touch screen to select it.

- **Set Count**

Press **Count**, then rotate the multifunction knob  or use the numeric keypad to set the number of statistical times for ripple analysis. Its range is from 2 to 5000. By default, it is 1000.

- **Reset**

Press **Reset Stat.** to clear the current data and execute statistics on the measurement results again.

- **Open or Close the Results Display Window**

Press **Display** continuously to enable or disable the display of the results. When enabled, the statistical results will be displayed on the screen, as shown in the figure below. You can also enable the touch screen to tap the icon  at the right-upper corner of the statistical results window to close it.

Ripple(1) 						
	Curr	Avg	Min	Max	Dev	Cnt
Ripple	22.71mV	22.83mV	18.92mV	30.28mV	2.100mV	123

- **View the Connection Diagram**

Press **Tips**, and then the connection diagram of the Ripple analysis is displayed on the screen. Please connect the cables according the connection method as

shown in *Figure 11.2*. Press **Tips** again or enable the touch screen to tap the icon  at the right-upper corner of the connection diagram window to close it.

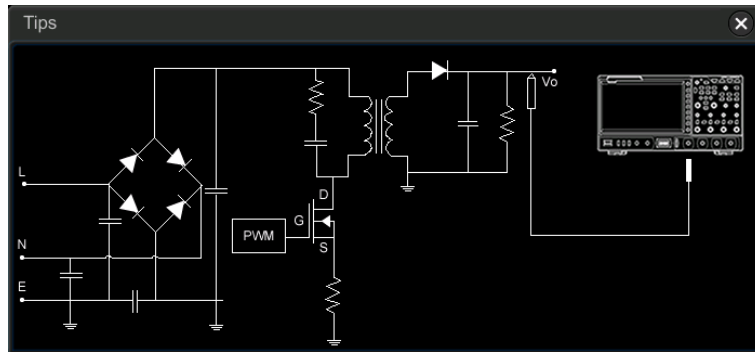

Figure 11.2 Connection Diagram of Ripple Analysis





12 Histogram Analysis

This series oscilloscope supports the standard histogram analysis function, enabling you to judge the trend of waveforms, and quickly locate the potential problems of the signal.

12.1 To Enable or Disable the Histogram Function

The histogram analysis function supported by this series is available to provide a statistical view of waveforms or measurement results. It can be classified into horizontal histogram, vertical histogram, and measurement histogram. With the on-going acquisition and measurement of the waveforms, the height of the bar graph will change within the set range of the histogram window to indicate the number of times for data statistics.

You can go to the "Histogram" setting menu through the following four ways:

- On the front panel, press  > **Analyze** > **Histogram** to enter the histogram setting menu.
- Enable the touch screen and then tap the function navigation icon  at the lower-left corner of the touch screen to enable the function navigation. Then tap the "Histogram" icon, and the histogram setting menu is displayed at the right section of the screen.
- Enable the touch screen and tap the auto measurement label "MEASURE" at the top of the screen to enter the measurement setting menu. In the measurement category area, rotate the multifunction knob  to select the "Analyze" option and then press down the knob to select it. You can also tap the "Analyze" option to select it. In the measurement parameter area, rotate the multifunction knob  to select the "Histogram" option and then press down the knob to select it. You can also tap the "Histogram" option to select it and then enter the "Histogram" setting menu.
- Refer to descriptions in "*Rectangle Drawing*" to enter the "Histogram" setting menu.

In the "Histogram" setting menu, press **Enable** continuously to enable or disable the histogram analysis function.

**TIP**

To record peaks or glitches in the histogram data, please always enable the histogram function.

12.2 To Select the Histogram Type

The histogram includes the following three types:

- Horizontal: displays the number of times for statistics making in the forms of columns in the histogram bar graph at the bottom of the graticule.
- Vertical: displays the number of times for statistics making in the forms of rows in the histogram bar graph at the left of the graticule.
- Measure: displays the number of times for statistics of the measurement results in the forms of columns in the histogram bar graph at the bottom of the graticule.

Press **Type**, then rotate the multifunction knob  to select the desired histogram type, and then press down the knob to select the type. You can also press **Type** continuously or enable the touch screen to select the type.

12.3 To Select the Histogram Source

If "Horizontal" or "Vertical" is selected under Type, you need to set the source (CH1-CH4). Press **Source**, then use the multifunction knob  to select the desired source, and then press down the knob to select the source. You can also press **Source** continuously or enable the touch screen to select it.

12.4 To Set the Measurement Items

When you select "Measure" as the histogram type, press **Measure** > **Add** on the front panel or tap the auto measurement label "MEASURE" at the top of the screen to enter the measurement setting menu, and then add one or multiple measurement items. At this time, the added measurement item(s) can be served as the measurement histogram source(s) and displayed in the **Item** menu.

12.5 To Set the Histogram Height

The histogram height indicates the number of grids the histogram bar graph should use on the screen. Press **Height**, then rotate the multifunction knob  or use the pop-up numeric keypad to set the height. The available range of height is from 1 to 4. By default, it is 2.

12.6 To Set the Histogram Range

When "Horizontal" or "Vertical" is selected under Type, you need to set the window range. Set "Left Limit", "Right Limit", "Top Limit", and "Bottom Limit" respectively to adjust the size and position of the histogram window. Press **Range** to enter the sub-menu of histogram range. Then press the corresponding softkey and rotate the multifunction knob  to set their values.

NOTE

The adjustment for the horizontal time base and vertical scale will not affect the time base of the histogram range, but only shows variation with the scale.

12.7 To Enable or Disable the Statistical Function

Press **Statistic** to enable or disable statistical function. When the statistical function is enabled, the statistical results of the histogram data will be displayed, as shown in the following figure. Note: when you select "Measure" under "Type", the statistical data results also include the parameter XScale.

Histogram Result	
Sum	1.243Mhits
Peaks	3.1khits
Max	1.99us
Min	-2.01us
Pk_Pk	4us
Mean	-15ns
Median	-20ns
Mode	-2.01us
Bin width	10ns
Sigma	1.154us

- Sum: indicates the sum of all bins (buckets) in the histogram.
- Peaks: indicates the maximum number of hits in any single bin.
- Max: indicates the value that corresponds to the maximum bin that has any hits.
- Min: indicates the value that corresponds to the minimum bin that has any hits.

- Pk_Pk: indicates the Delta between the max. value and the min. value.
- Mean: indicates the average value of the histogram.
- Median: indicates the median value of the histogram.
- Mode: indicates the mode value of the histogram.
- Bin width: indicates the width of each bin (bucket) in the histogram.
- Sigma: indicates the standard deviation of the histogram.
- XScale: indicates the horizontal scale of the histogram. It is 100 times the value of Bin width.

12.8 To Reset

Press **Reset** to reset the statistical data and restart to make statistics.

13 Real-time Eye Diagram and Jitter Analysis (Option)

This series oscilloscope provides the real-time eye diagram and measurement with the clock recovery function. The flexible and convenient jitter measurement and analysis enable the users to instinctively understand the strong and weak Inter-Symbol Interference in the system, so as to accurately and quickly make deterministic jitter measurement for the high-speed serial signal.

If you have purchased and activated the MSO8000-JITTER option, the oscilloscope also supports real-time eye diagram and jitter analysis functions.

13.1 Real-time Eye Analysis





An eye diagram is a view of a signal. A real-time eye accomplishes this by acquiring data, performing clock recovery, then superimposing (folding) successive unit intervals within a single plot. This is a statistical view in the form of a color grade. The eye analysis function is usually used to observe the waveforms of the Receive signal to analyze the impact of inter-symbol interference (ISI) and noise on the system performance.



NOTE

The eye diagram can only be obtained when the horizontal time base is less than or equal to 1 $\mu\text{s}/\text{div}$.

You can go to the "Eye" setting menu through the following three ways:

- On the front panel, press  > **Analyze** > **Eye** to enter the eye setting menu.
- You can also enable the touch screen and then tap the function navigation icon  at the lower-left corner of the screen to open the function navigation. Then, tap the "Eye" icon to open the "Eye" setting menu.
- Enable the touch screen and tap the auto measurement label "MEASURE" at the top of the screen to enter the measurement setting menu. In the measurement category area, rotate the multifunction knob  to select the "Analyze" tab and then press down the knob to select it. You can also tap the "Analyze" tab to select it. In the measurement parameter area, rotate the multifunction knob 

(Option)

to select "Eye" and then press down the knob to select it. You can also tap to select "Eye" to enter the "Eye" setting menu.

13.1.1 To Enable or Disable the Eye Analysis Function

In the "Eye" setting menu, press **Eye** continuously to enable or disable the eye diagram analysis function.

13.1.2 To Select the Source of the Eye Diagram

Press **Source** in the "Eye" setting menu, then use the multifunction knob  to select the desired eye source, and then press down the knob to select the source. You can also press **Source** continuously or enable the touch screen to select it. The analog channel (CH1-CH4) can be selected to be the eye source.

13.1.3 Threshold Settings

In the "Eye" setting menu, press **Threshold** to enter the threshold setting menu.

- **Set the High Threshold**

Press **HighThres**, then rotate the multifunction knob  or use the pop-up numeric keypad to set the high threshold.

NOTE

If you reduce the high threshold to a value below the set middle threshold, the oscilloscope will adjust the high threshold automatically to make it greater than the middle threshold.

- **Set the Middle Threshold**

Press **MidThres**, then rotate the multifunction knob  or use the pop-up numeric keypad to set the middle threshold.

NOTE

The middle threshold is limited by the set low threshold and high threshold.

- **Set the Low Threshold**

Press **LowThres**, then rotate the multifunction knob  or use the pop-up numeric keypad to set the low threshold.

NOTE

If you increase the low threshold to a value above the set middle threshold, the oscilloscope will decrease the low threshold automatically to make it smaller than the middle threshold.

13.1.4 To Set Clock Recovery

The clock recovery provides an ideal clock for comparison to actual signal edges.

In the "Eye" setting menu, press **Clock Recovery** to enter the clock recovery menu. This oscilloscope supports several clock recovery methods, including constant clock, phase-locked loop (PLL), and external clock.

1. Set the Constant Clock Recovery

Press **RecoveryType**, and rotate the multifunction knob  to select "Constant", and then press down the knob to select it. You can also press **RecoveryType** continuously or enable the touch screen to select it.

- Set the data rate type

The data rate type for Constant includes Manual, Semi-Auto, and Auto.

- Manual: recovers the clock by the data rate input manually.
- Semi-Auto: recovers the clock by the manually preset data rate and the signal edge.
- Auto: recovers the clock based on the narrowest pulse of the signal.

Press **Type**, and rotate the multifunction knob  to select the desired data rate type, and then press down the knob to select it. You can also press **Type** continuously or enable the touch screen to select it.

- Set the data rate

Press **Data Rate**, then rotate the multifunction knob  or use the pop-up numeric keypad to set the data rate.

NOTE

When the data rate type is set to Auto, the **Data Rate** menu is grayed out and disabled, and only the automatically recovered frequency of the ideal clock can be displayed

2. Set the Phase-Locked Loop (PLL) Recovery

Press **RecoveryType**, and rotate the multifunction knob  to select "PLL", and then press down the knob to select it. You can also press **RecoveryType** continuously or enable the touch screen to select it.

- Set the data rate

Press **Data Rate**, then rotate the multifunction knob  or use the pop-up numeric keypad to set the data rate.

(Option)

- Set the PLL order

This oscilloscope supports first-order PLL and second-order PLL. Press **PLL Order**, and rotate the multifunction knob  to select the order number and then press down the knob to select it. You can also press **PLL Order** continuously or enable the touch screen to select it.

- Set the loop BW

Press **Loop BW**, then rotate the multifunction knob  or use the pop-up numeric keypad to set the loop bandwidth.

- Set the damping factor

When PLL order is set to "2nd Order", you need to set the damping factor. It is the damping factor of the transfer function. Press **DampFactor**, then rotate the multifunction knob  or use the pop-up numeric keypad to set the damping factor.

The typical damping factor is 1.0 and 0.707. The former is critically damped, and the latter is the ideal or optimal value.

3. Set the External Clock Recovery

Press **RecoveryType**, and rotate the multifunction knob  to select "Explicit", and then press down the knob to select it. You can also press **RecoveryType** continuously or enable the touch screen to select it.

Press **Source**, then use the multifunction knob  to select the desired source, and then press down the knob to select the source. You can also press **Source** continuously or enable the touch screen to select it. The analog channel (CH1-CH4) can be selected to be the source of the external clock.

13.1.5 To Enable or Disable the Eye Measurement Result

In the "Eye" setting menu, press **Result** continuously to enable or disable the display of the eye measurement result. When it is enabled, the statistical results of the eye measurement data will be displayed at the upper-left corner of the screen, as shown in the following figure. You can enable the touch screen, and drag the statistical results to any place where you want to put it for view on the screen.

Measure	
One	: 0V
Zero	: 0V
Eye Width	: 0s
Eye Height	: 0V
Eye Amp	: 0V
Cross	: 0%
Q Factor	: 0

Wherein,

One: indicates "1" level.

Zero: indicates "0" level.

Eye Width: indicates the width of an eye diagram.

Eye Height: indicates the height of an eye diagram.

Eye Amp: indicates the amplitude of an eye diagram.

Cross: indicates the crossing percentage of an eye diagram.

Q Factor: indicates the Q factor.

The parameters of the eye measurement are shown in *Figure 13.1*.

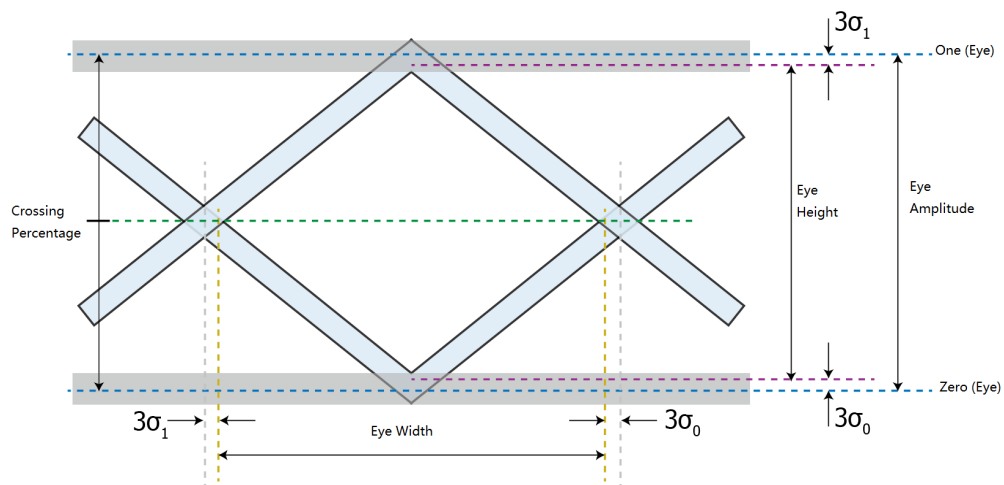

Figure 13.1 Diagram of Eye Measurement Parameters

13.1.6 To Reset Color

Press **Reset Color** to clear the color level counter.





13.2 Jitter Analysis

The jitter analysis function is mainly used to analyze the integrity of the high-speed serial signal and measure the variance of a measurement over time. The measurement

(Option)

item includes TIE, Cycle to Cycle, +Width to +Width, and -Width to -Width. Wherein, TIE indicates time interval error. The TIE measurement compares the edges in a data signal with the edges in an ideal data signal determined by the clock recovery feature to generate error statistics.

You can go to the "Jitter" setting menu through the following three ways:

- On the front panel, press  > **Analyze** > **Jitter** to enter the jitter setting menu.
- You can also enable the touch screen and then tap the function navigation icon  at the lower-left corner of the screen to open the function navigation. Then, tap the "Jitter" icon to open the "Jitter" setting menu.
- Enable the touch screen and tap the auto measurement label "MEASURE" at the top of the screen to enter the measurement setting menu. In the measurement category area, rotate the multifunction knob  to select the "Analyze" tab and then press down the knob to select it. You can also tap the "Analyze" tab to select it. In the measurement parameter area, rotate the multifunction knob  to select "Jitter" and then press down the knob to select it. You can also tap to select "Jitter" to enter the "Jitter" setting menu.

13.2.1 To Enable or Disable the Jitter Function

In the jitter setting menu, press **Enable** continuously to enable or disable the jitter analysis function. When the jitter analysis function and the jitter trend are enabled, Math3 trend operation function is enabled by default and the trend graph is displayed on the screen.

13.2.2 To Select the Jitter Source

Press **Source** in the "Jitter" setting menu, then use the multifunction knob  to select the desired jitter source, and then press down the knob to select the source. You can also press **Source** continuously or enable the touch screen to select it. The analog channel (CH1-CH4) can be selected to be the jitter source.

13.2.3 Threshold Settings

For setting methods of the jitter threshold, refer to descriptions in "*Threshold Settings*" in the "*Real-time Eye Analysis*" section.

13.2.4 To Set Clock Recovery

For setting methods of the clock recovery in the jitter, refer to descriptions in "*To Set Clock Recovery*" in the "*Real-time Eye Analysis*" section.



NOTE

When the measurement item is "TIE", you need to set the clock recovery. For other measurement items, you do not need to set the clock recovery.

13.2.5 To Set the Jitter Measurement

Press **Measure** to enter the jitter measurement menu. You can set the jitter measurement item and the graph display mode of the jitter measurement results.

- **Set the Jitter Measurement Item**

The jitter measurement items supported by this oscilloscope include TIE, Cycle to Cycle, +Width to +Width, and -Width to -Width.

Press **Item**, then rotate the multifunction knob  to select desired measurement item, and then press down the knob to select the item. You can also press **Item** continuously or enable the touch screen to select it.

- **TIE**

Compares edges in a signal under test with the edges in an ideal signal determined by the clock recovery feature. Then, all the signal intervals are measured based on the ideal data rate to generate the error statistics.

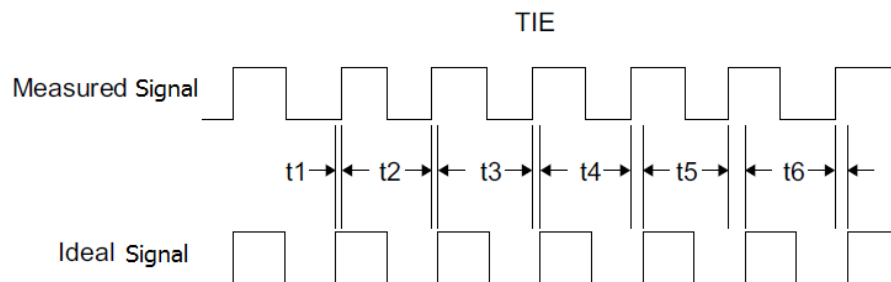

- **Cycle to Cycle**

Measures the first cycle and then subtracts the first cycle from the second cycle. The measurement is made according to this rule.

(Option)

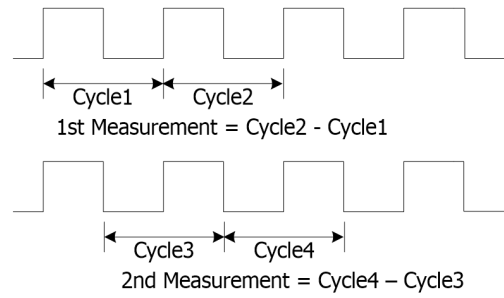

- **+Width to +Width**

The +Width to +Width jitter measurement subtracts the first cycle's positive pulse width from the second cycle's positive pulse width for the first measurement result. The +Width to +Width jitter measurement subtracts the second cycle's positive pulse width from the third cycle's positive pulse width for the second measurement result, and so on, until all of the cycles of the waveforms have been measured.

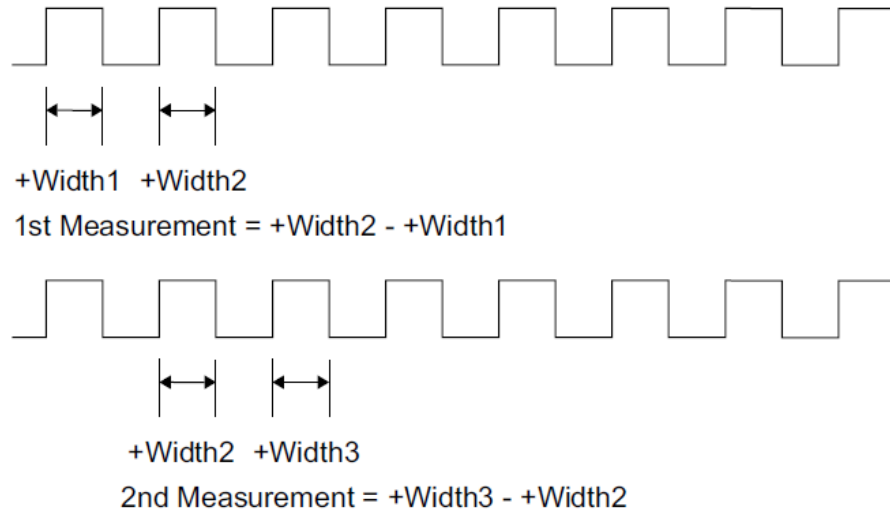

- **-Width to -Width**

The -Width to -Width jitter measurement subtracts the first cycle's negative pulse width from the second cycle's negative pulse width for the first measurement result. The -Width to -Width jitter measurement subtracts the second cycle's negative pulse width from the third cycle's negative pulse width for the second measurement result, and so on, until all of the cycles of the waveforms have been measured.

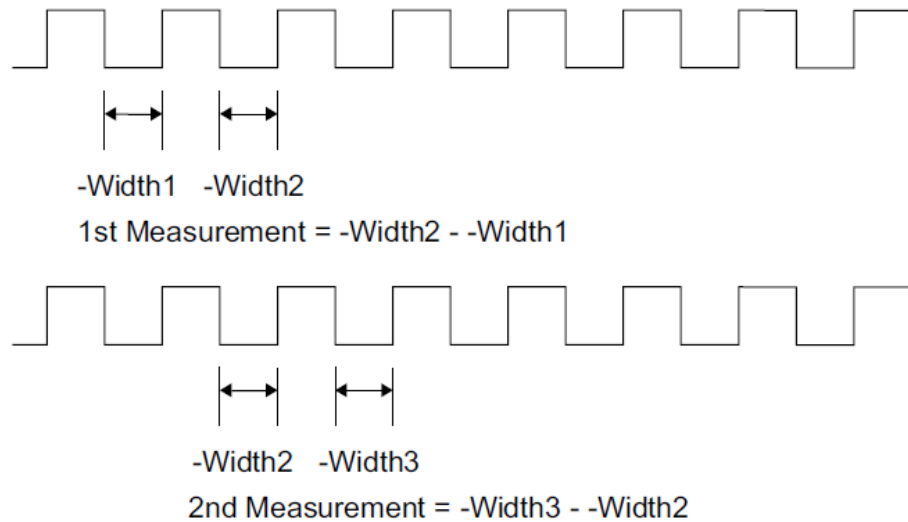

- **Jitter Edge**

When the measurement item is "TIE" or "Cycle to Cycle", you need to set the edge of the measurement signal. The edges include Rising, Falling, and Either.

Press **Slope**, then rotate the multifunction knob  to select the desired edge, and then press down the knob to select it. You can also press **Slope** continuously or enable the touch screen to select it.

- **Jitter Trend Graph**

The trend graph can display the trend of the jitter measurement results. The data obtained from the waveforms of the same frame are generated to form a curve, which enables users to find out the cause for jitter.

Press **Trend** continuously to enable or disable the display of the trend graph.

NOTE

When the clock recovery method is set to "PLL", the PLL system cannot reach the expected ideal clock frequency until it reaches the specified lock time. During the lock time, the TIE jitter measurement results based on the ideal recovery clock are incorrect. The data produced during this time will be discarded in data processing. Therefore, in the TIE jitter trend graph based on the PLL recovery, part of trend graph at the left section of the screen will be lost. When a message "Invalid settings" is displayed below the trend graph, please modify the loop bandwidth, the horizontal timebase, or other related settings to make valid measurements.

- **Jitter Histogram**

The histogram shows the distribution of the jitter measurement results. Gaussian distributions indicates random jitter, and non-Gaussian distributions indicate the deterministic jitter.

Press **Histogram** continuously to enable or disable the display of the histogram.

NOTE

(Option)

When you select the specified measurement item and enable the display of the histogram, the selected item will be displayed under the **Item** menu of the Histogram setting menu simultaneously. Meanwhile, the jitter analysis function in the histogram setting menu will also be enabled. The histogram type will be switched to Jitter. At this time, the statistical count and distribution of the jitter measurement results will be displayed in columns in the bar histogram at the bottom of the screen.

- **Auto Setting**

Used to configure the scale of the trend graph automatically.

Press **Auto Setting**, and then the vertical scale and offset of the trend graph will be automatically adjusted to optimal values based on the current configurations, so that users can get a better observation of the results.

13.2.6 To Enable or Disable the Jitter Measurement Result

In the jitter setting menu, press **Result** continuously to enable or disable the display of the jitter measurement result. When enabled, the jitter measurement data results will be displayed on the screen, as shown in the following figure. You can enable the touch screen to drag the jitter measurement data results to any place for view.

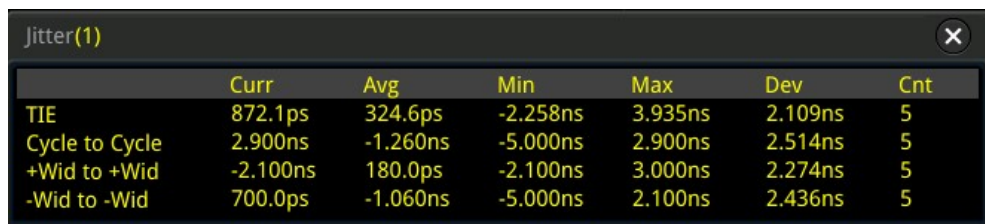

	Curr	Avg	Min	Max	Dev	Cnt
TIE	872.1ps	324.6ps	-2.258ns	3.935ns	2.109ns	5
Cycle to Cycle	2.900ns	-1.260ns	-5.000ns	2.900ns	2.514ns	5
+Wid to +Wid	-2.100ns	180.0ps	-2.100ns	3.000ns	2.274ns	5
-Wid to -Wid	700.0ps	-1.060ns	-5.000ns	2.100ns	2.436ns	5

13.2.7 To Reset Statistics

In the jitter setting menu, press **Reset** to reset the statistics of the jitter measurement result.

14 Digital Channel

This series oscilloscope provides the standard the logic analyzer (LA) function, and it has 16 digital channels. The default channel label is D15-D0. The oscilloscope compares the voltages acquired in each sample with the preset logic threshold. If the voltage of the sample point is greater than the threshold, it will be stored as logic 1; otherwise, it will be stored as logic 0. The oscilloscope displays logic levels ("1" and "0") in the form of a graph for you to easily detect and analyze the errors in circuit design (hardware design and software design).



Before using the digital channels, connect the oscilloscope and the device under test using RPL2316 logic probe provided in the accessories. To apply to different application scenarios, RPL2316 provides three connection methods to connect the signal under test. For details, refer to RPL2316 Logic Probe User Guide.



NOTE

The digital channel input terminal does not support hot plugging. Please do not insert or pull out the logic probe when the instrument is in power-on state.

14.1 To Select the Digital Channel

Press  on the front panel or enable the touch screen to tap the LA status label at the bottom of the screen to enter LA setting menu. Press **Select** to open the channel menu, and rotate the multifunction knob  to select the channel. You can also press **Select** continuously or enable the touch screen to select it.

- Select any of the digital channels (D0-D15). The channel label and waveform of the selected channel are displayed in red.
- Select the user-defined group: selects any group of the channels from the four user-defined groups. The labels and the waveforms of all the channels in the selected channel group will be indicated in red.



NOTE

Only the enabled digital channel can be selected, and only the user-defined channel group that has been grouped can be available.

For how to enable the digital channel/group, refer to descriptions in "[To Enable/Disable the Digital Channel](#)".

For how to define the user-defined group, refer to refer to descriptions in "[Group Setting](#)".

14.2 To Enable/Disable the Digital Channel

Press **On/Off** to enter the on/off sub-menu of the digital channel.

- **Enable/disable the channels (D7-D0) simultaneously**



Press **D7-D0** continuously to enable or disable the channels (D7-D0). You can also enable the touch screen and tap the LA status area. Then the channel and threshold setting interface is displayed, as shown in the figure below. Tap "D7-D0" to enable or disable D7-D0 channels. Tap the close icon  at the upper-right corner of the interface to close the interface; or tap the LA status label at the bottom of the screen to close the interface.



- **Enable/disable the channels (D15-D8) simultaneously**



Press **D15-D8** continuously to enable or disable the channels (D15-D8). You can also enable the touch screen and tap the LA status area. Then the channel and threshold setting interface is displayed. Tap "D15-D8" to enable or disable D15-D8 channels.

- **Enable/disable a single digital channel**

Press **Dx On/Off** to open the channel selection list. Rotate the multi-function knob  to select a channel, and then press down the knob  to enable or disable it. You can also press **Dx On/Off** continuously to switch to select any channel, and press down the multifunction knob  to enable or disable the channel. You can also enable the touch screen to enable or disable the selected channel. In addition, You can also enable the touch screen and tap the LA status area. Then the channel and threshold setting interface is displayed. Tap a single digital channel to enable or disable it.

NOTE

After pressing **D7-D0** to enable or disable D7-D0, you can still disable or enable any channel among D7-D0 through the **Dx On/Off** key. After pressing **D7-D0** to enable D7-D0 channels, the D0-D7 channels under **Dx On/Off** are enabled automatically. The same is true for D15-D8 channels.

- **Enable or Disable User-defined Channel Group** Press **Group On/Off**, then rotate the multifunction knob  to select the specified channel group. Press down the knob to enable or disable all the channels in this channel group. You can also enable the touch screen to tap the specified group and select it. The enabled channel groups are marked with , and the disabled channel groups are marked with .

NOTE

This function is only valid when the channels have been grouped by users. For how to carry out group settings, refer to descriptions in "*Group Setting*".

14.3 To Set the Threshold

The threshold levels of channels D7-D0 and channels D15-D8 can be set separately according to your needs. Press **Threshold** to enter the threshold setting menu. When the voltage of the input signal is greater than the currently set threshold, it is treated as logic 1; otherwise, it is treated as logic 0.

Press **D7-D0** or **D15-D8** respectively to open the threshold selection list and select the preset threshold. The available preset values include TTL(1.4 V), CMOS5.0(2.5 V), CMOS3.3(1.65 V), CMOS2.5(1.25 V), CMOS1.8(0.9 V), ECL(-1.3 V), PECL(3.7 V), LVDS(1.2 V), and 0.00 V. You can also press **D7-D0** or **D15-D8** respectively, then rotate the multifunction knob  with a small step value or use the numeric keypad to set the desired threshold.

Besides, you can also enable the touch screen and tap the LA status area. Then the channel and threshold setting interface is displayed. You can select the channel and set the threshold in this pop-up interface. Tap the drop-down button () of Threshold to select the preset threshold from the drop-down list. Also you can tap the input field of Threshold to input the value with the pop-up numeric keypad.

14.4 Auto Arrangement Setting

Press **Arrange** to select the waveform order mode of the currently selected channels on the screen. You can select "D0-D15" or "D15-D0", By default, it is "D15-D0".

- D0-D15: the waveforms on the screen are D0-D15 in sequence from top to bottom.
- D15-D0: the waveforms on the screen are D15-D0 in sequence from top to bottom.

14.5 To Set the Waveform Display Size

Press **Size**, then use the multifunction knob  to select the desired waveform display size, and then press down the knob to select it. You can also press **Size** continuously or enable the touch screen to select it. The available display sizes are Small, Medium, and Large.



NOTE

"Large" is only available when the number of currently enabled channels is less than or equal to 8.

14.6 To Set the Label

By default, the instrument takes D0-D15 as the channel label of the 16 digital channels. You can set a user-defined label for each digital channel to easily differentiate the digital channels. You can use the preset label or input a label manually. Press **Label** to enter the label setting menu.

- **Enable or disable the label display**

Press **Display** continuously to enable or disable the display of the channel label. If it is enabled, the label will be displayed at the left side of the waveform.

- **Select a specified digital channel**

Press **Select** and rotate the multifunction knob  to select the desired digital channel that needs a label. You can also press **Select** continuously or enable the touch screen to select the channel. Select any channel from D0-D15.

- **Use preset labels**

Press **Library** to select a preset label. The available preset labels include ACK, ADO, ADDR, BIT, CAS, CLK, CS, DATA, HALT, INT, LOAD, NMI, OUT, PAS, PIN, RDY, RST, RX, TX, WR, MISO, and D0-D15.

- **Input a label manually**





Press **Label** to open the label input interface. You can input the label manually. For details, refer to descriptions in "[Channel Label](#)".

14.7 Group Setting

Press **On/Off** > **Group** to enter the user-defined group setting menu. You can randomly grouping or ungrouping any of the 16 digital channels. You can also directly press **More** to enter the menu to group or ungroup channels according to your needs.



- **Group:**

For grouping, the operations for the four user-defined groups (Group1, Group2, Group3, and Group4) are the same. Here take Group1 as an example.

Press **Group1** to open the D0-D15 channel selection list (the status icon is located at the left side of each channel). Rotate the multifunction knob  or press **Group1** continuously to select the channel(s) to be added to Group1. Then, press down the multifunction knob  to add the selected channel(s) to Group1. The channel(s) that has/have been added to Group1 is/are marked with the status icon , and the channel(s) that has/have not been added to Group1 is/are marked with the status icon .

Use the same method to group the other channels. Each channel can only be added to one single group, and the channels that have been add to other group cannot be selected. You can perform group operation on 16 digital channels (D0-D15).

- **Ungroup:**

Press **UnGroup** to open the list. Rotate the multifunction knob  or press **UnGroup** continuously to select any channel group, then press down the knob  to ungroup the channels.



NOTE

- You can only ungroup the digital channels.
- If no group is set, the **UnGroup** menu and the **Group On/Off** menu are grayed out and disabled.

14.8 Waveform Color of the Digital Channel

When the digital channel is enabled, its corresponding waveforms and label are displayed on the screen. This oscilloscope supports setting the display color of the high logic level, low logic level, and edges.



Press **More** > **Color** to enter the waveform color setting menu.

- Press **High**, and rotate the multifunction knob  to set the display color of the high logic level. Press down the knob to select the color. You can also press **High** continuously or enable the touch screen to select it.
- Press **Edge**, and rotate the multifunction knob  to set the edge color. Press down the knob to select it. You can also press **Edge** continuously or enable the touch screen to select it.

- Press **Low**, and rotate the multifunction knob  to set the display color of the low logic level. Press down the knob to select it. You can also press **Low** continuously or enable the touch screen to select it.

15 Protocol Decoding

You can use the protocol analysis to discover errors, debug hardware, and accelerate development easily, ensuring you to accomplish the projects with high speed and good quality. Protocol decoding is the basis of protocol analysis. Only protocol analyses with correct protocol decoding are acceptable, and only correct protocol decoding can identify more error information. This series oscilloscope provides four bus decoding modules (Decode 1, Decode 2, Decode 3, and Decode 4) to make common protocol decoding (including Parallel (standard), RS232 (option), I2C (option), SPI (option), LIN (option), CAN (option), FlexRay (option), I2S (option), and 1553B (option)) for the input signals of the analog channels (CH1-CH4) and the digital channels (D0-D15). As the decoding functions and setting methods of Decode1, Decode2, Decode3, and Decode4 are the same, this chapter takes Decode1 as an example for illustration.

Press  on the front panel to open the decode setting menu, or enable the touch screen to tap the function navigation icon  at the lower-left corner of the screen to open the function navigation. Then, tap the "Decode" icon to open the decode setting menu.

To get the decoding option information, refer to descriptions in "[Appendix A: Options and Accessories](#)".

If you have purchased the decoding option, activate it according the descriptions in "[To View the Option Information and the Option Installation](#)".

15.1 Parallel Decoding

Parallel bus consists of clock line and data line. As shown in the figure below, CLK is the clock line, whereas Bit0 and Bit1 are the 0 bit and 1st bit on the data line respectively. The oscilloscope will sample the channel data on the rising edge, falling edge, or the rising/falling edge of the clock and judge each data point (logic "1" or logic "0") according to the preset threshold level.

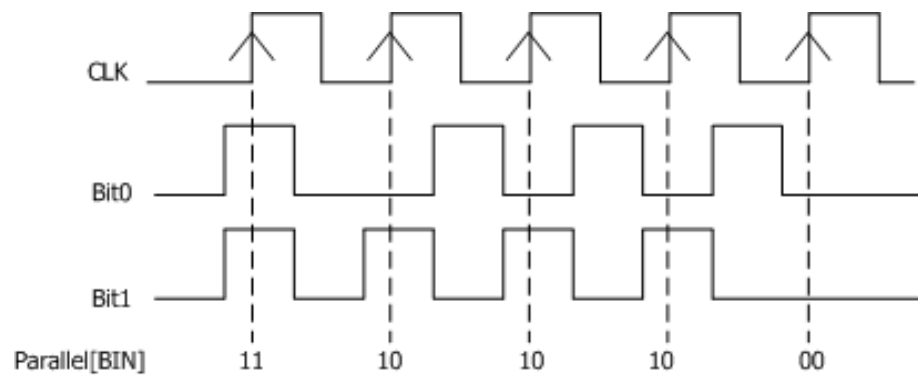



Figure 15.1 Schematic Diagram of Parallel Decoding

In the decode setting menu, press **Decode1** > **Bus Type**, then rotate the multifunction knob  to select "Parallel". Press down the knob  to select it. You can also press **Bus Type** continuously or enable the touch screen to select it.

1. Enable or Disable the Bus

Press **Bus Status** continuously to enable or disable the decoding function.





2. Set the Clock Line (CLK)

Press **Clock** to enter the clock line setting menu.

- Set the clock channel

Press **Clock**, then rotate the multifunction knob  to select any clock channel. Press down the knob to select it. You can also press **Clock** continuously or enable the touch screen to select it. The analog channel (CH1-CH4) and digital channel (D0-D15) can all be selected as the clock source. If "OFF" is selected, no clock channel is set, and sampling is performed when a hop occurs to the data of the data channel during decoding.

- Set the clock edge type

Press **CLK Edge**, then rotate the multifunction knob  to select clock edge type. Press down the knob to select it. You can also press **CLK Edge** continuously or enable the touch screen to select it. You can select to sample the channel data on the rising edge () , falling edge () , or both edges () of the clock signal.

Rising : samples the channel data on the rising edge of the clock.

Falling : samples the channel data on the falling edge of the clock.

Both : samples the channel data on either the rising edge or the falling edge of the clock.

- **Set the threshold**

When the clock signal is an analog channel (CH1-CH4), you need to set a threshold. Press **Threshold**, then rotate the multifunction knob  or use the pop-up numeric keypad to set the threshold.

3. Set the Bus Parameters

Press **Bus** to enter the bus setting menu.

- **Set the bus**

Press **BUS** to select the digital bus for Parallel decoding, as shown in the following table.

Bus	Width	Bit X	Channel	Remarks
CH1	1	0	CH1	Width , Bit X , and CH are set automatically, and you cannot modify them.
CH2	1	0	CH2	Width , Bit X , and CH are set automatically, and you cannot modify them.
CH3	1	0	CH3	Width , Bit X , and CH are set automatically, and you cannot modify them.
CH4	1	0	CH4	Width , Bit X , and CH are set automatically, and you cannot modify them.
D7-D0	8	0 (default)	D0 (default)	Bit0 to Bit7 are set to D7 to D0 respectively. Width is set automatically, and you cannot modify it.
D15-D8	8	0 (default)	D8 (default)	Bit0 to Bit7 are set to D15 to D8 respectively. Width is set automatically, and you cannot modify it.
D15-D0	16	0 (default)	D0 (default)	Bit0 to Bit15 are set to D15 to D0 respectively. Width is set automatically, and you cannot modify it.

Bus	Width	Bit X	Channel	Remarks
D0-D7	8	0 (default)	D7 (default)	Bit0 to Bit7 are set to D0 to D7 respectively. Width is set automatically, and you cannot modify it.
D8-D15	8	0 (default)	D15 (default)	Bit0 to Bit7 are set to D8 to D15 respectively. Width is set automatically, and you cannot modify it.
D0-D15	16	0 (default)	D15 (default)	Bit0 to Bit15 are set to D0 to D15 respectively. Width is set automatically, and you cannot modify it.
User	1 to 20	0 (Default)	—	-

- Set the width

When BUS is set to "User", you can set the bus width. Press **Width**, then rotate the multifunction knob  or use the pop-up numeric keypad to set the width. The available range is from 1 to 20.

- Specify a data channel for each bit

When BUS is set to any digital channel, you can specify a data channel for each bit.

Press **Bit X**, then rotate the multifunction knob  or use the pop-up numeric keypad to set the bit of the channel. By default, 0 is selected. Its available range is from 0 to (width - 1).

Press **CH**, then rotate the multifunction knob  to select the desired channel source, and then press down the knob to select it. You can also press **CH** continuously or enable the touch screen to select it. The analog channel (CH1-CH4) and digital channel (D0-D15) can all be selected as the channel source.

- Set the threshold level

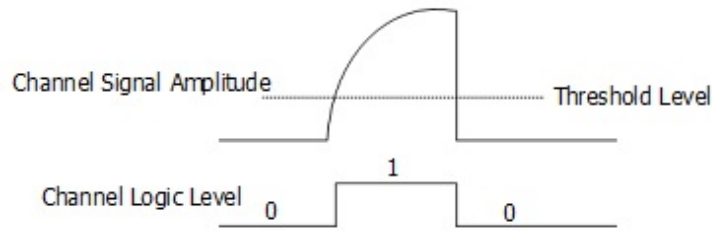

To judge logic "1" and logic "0" of the buses, you need to set a threshold for each analog channel (CH1-CH4). When the channel signal amplitude is greater than the preset threshold, it is judged as logic "1"; otherwise logic "0". Press **Threshold**, then rotate the multifunction knob  or use the pop-up numeric keypad to set the threshold.



- **Set the endian**

Press **Endian** continuously to select "Normal" or "Invert" as the endian of the bus.

- **Set the polarity**

Press **Polarity** continuously to select Positive  or Negative  as the polarity for data decoding.



4. Set Display-related Parameters

Press **Display** to enter the display setting menu.

- **Set the display format**

Press **Format**, rotate the multifunction knob  to select the display format of the bus data. Then, press down the knob to select it. You can also press **Format** continuously or enable the touch screen to select it. The available formats include Hex, Dec, Bin, and ASCII.

- **Adjust the vertical position of the bus**

Press **Position**, and then rotate the multifunction knob  to adjust the vertical display position of the bus. You can also rotate **Wave Vertical**  **POSITION** to adjust the vertical display position of the bus.

- **Set the label display**

Press **Label** to enable or disable the label display of the Parallel decoding bus. When enabled, the bus label "Parallel" will be displayed at the upper-left side of the bus (when the bus display is enabled).

- **Set parameters for the event table**

Press **Event Table** to enter the event table setting menu. The event table displays the decoded data and the corresponding decoding information in time order in the form of a table. It can be used to observe relatively longer decoded data. The decoding information includes the decoded data, the corresponding line number, and time information.

- Open or close the event table: Press **Event Table** continuously to enable or disable the display of the event table. When enabled, the following event table as shown in *Figure 15.2* is displayed. You can also enable the touch screen to tap the icon  at the right-upper corner of the event table to close it.

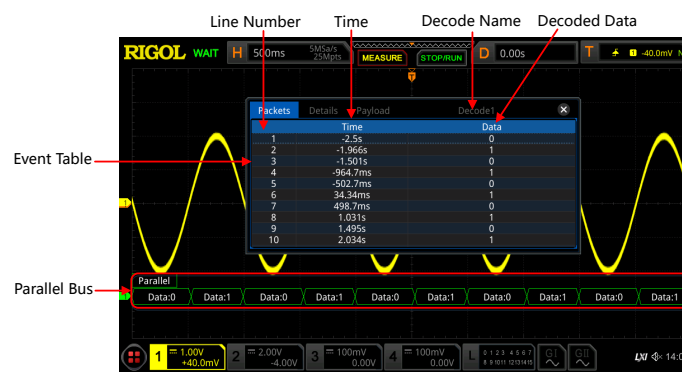





Figure 15.2 Parallel Decoding Event Table

NOTE

- When you adjust the horizontal time base, the waveform displayed on the screen will also change, and the total number of lines containing the decoding information in the event table will also be changed.
- The displayed decoded data information in the bus is related to the value of the horizontal time base. Reducing the horizontal time base can help you view the detailed information.
- Set the event table format: Press **Format**, rotate the multifunction knob  to select the display format of "Data" in the event table. Then, press down the knob to select it. You can also press **Format** continuously or enable the touch screen to select it. The available formats include Hex, Dec, Bin, and ASC.

- Set the view type: Press **View**, rotate the multifunction knob  to select the form of the event table to be viewed. Then, press down the knob to select it. You can also press **View** continuously or enable the touch screen to select it. The available choices include "Packets", "Details", and "Payload". You can also tap "Packets", "Details", or "Payload" at the top of the event table to select it.

If you select "Packets", time and decoded data are displayed in the event table. If you select "Details", the detailed data in the specified row will be displayed in the event table. If "..." appears in the row of data, it indicates that the decoded data are not fully displayed. At this time, you can view the details in the "Packets" view. If you select "Payload", all data in the specified column will be displayed in the event table. If "..." appears in the specified column of data, it indicates that the decoded data are not fully displayed. At this time, you can view the details in the "Packets" view.

- Export: If you select "Packets", you can export time and the corresponding decoded data. Press **Export**, then the save setting interface is displayed. You can export the data table of the packet to the internal memory or the external USB storage device (when detected) in CSV format. For detailed saving operation, refer to descriptions in "*Store and Load*".
- Jump to: Set the operating status of the oscilloscope to "STOP". Then, select the data of the specified time from the event table. Press **Jump to** and the specified data waveforms are displayed in the center of the screen.
- Decode: The setting of this menu enables you to quickly view the corresponding event tables of four decode modules (Decode1, Decode2, Decode3, and Decode4). Press **Decode**, then use the multifunction knob  to select a decode module, then press down the knob to select it. You can also press **Decode** continuously or enable the touch screen to select it.

5. Set the Noise Rejection

Press **Settings** > **Noise Reject** to enable or disable the noise rejection function. Noise rejection can remove the data that last not enough time on the bus and eliminate the burst glitch in the actual circuit. When the noise rejection is enabled,

press **Reject Time**, rotate the multifunction knob  or use the pop-up numeric keypad to set the desired rejection time. The available range is from 0 s to 1 s.

15.2 RS232 Decoding (Option)

RS232 serial bus consists of the transmitting data line (TX) and the receiving data line (RX).

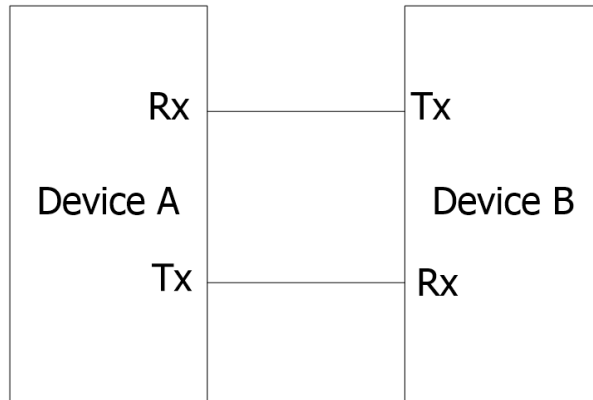

Figure 15.3 Schematic Diagram of RS232 Serial Bus

The industry standard of RS232 uses "Negative Logic", i.g. high level is logic "0" and low level is logic "1".

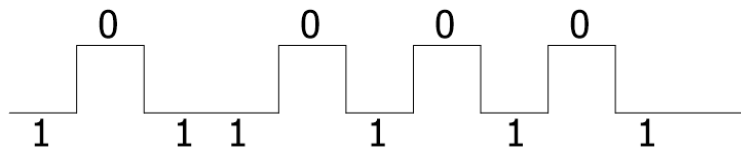
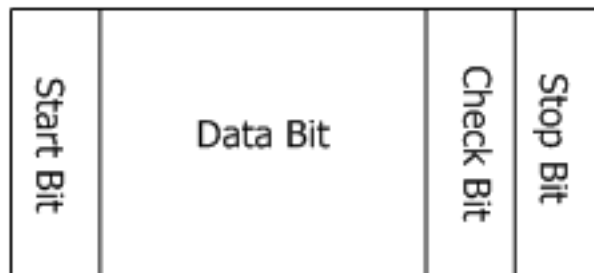

Figure 15.4 Schematic Diagram of Negative Logic

In RS232, baud rate is used to represent the transmission rate (namely bits per second) of the data.

You need to set the start bit, data bits, check bit (optional), and stop bits for each frame of data.



Start Bit: indicates when to output data.

Data Bit: indicates the number of data bits actually contained in each frame of data.

Check Bit: used to check whether the data are properly transmitted.

Stop Bit: indicates when to stop outputting data.

In the decode setting menu, press **Decode1** > **Bus Type**, then rotate the multifunction knob  to select "RS232". Press down the knob to select it. You can also press **Bus Type** continuously or enable the touch screen to select it.

1. Enable or Disable the Bus

Press **Bus Status** continuously to enable or disable the decoding function.

2. Quickly Apply RS232 Trigger Settings to RS232 Decoding

Press **Copy Trig** to copy the current RS232 trigger settings and apply them to RS232 decoding function (set the corresponding RS232 decoding parameters automatically). For source channels, copy the source channel of the trigger to the Tx source channel of the decoding. For analog channels, the threshold level settings will also be copied.

3. Set the Baud Rate

Three methods are available for setting the baud rate:

- Press **Baud**, then set the user-defined baud rate with the displayed numeric keypad.
- Press **Baud**, then select the preset baud rate from the drop-down list. The available baud rates include 50 bps, 75 bps, 110 bps, 134 bps, 150 bps, 300 bps, and etc.
- Press **Baud**, then rotate the multifunction knob  to adjust the baud rate at a small step size. The step size is different for adjusting different baud rates.

4. Set the Source

Press **Sources** to enter the signal setting menu.

- Set the Tx source and the threshold

- Press **Tx**, then rotate the multifunction knob  to select the desired channel, and press down the knob to select it. You can also press **Tx** continuously or enable the touch screen to select it. The available channels include OFF, CH1-CH4, and D0-D15.

- When you select the analog channel (CH1-CH4), press **Threshold**, then rotate the multifunction knob  or use the pop-up numeric keypad to set the threshold of the Tx source channel. When you modify the threshold of the Tx source channel, a dotted line displaying the current threshold level is displayed on the screen. It disappears in about 2 s after you stop modifying the threshold.



- **Set the Rx source and the threshold**

Use the same method to select the Rx source and set the threshold (available only when the Rx source channel is set to an analog channel (CH1-CH4)).

NOTE

The source channels of Tx and Rx cannot be set to "OFF" at the same time.

- **Set the polarity**

Press **Polarity** continuously to set Positive  or Negative  as the polarity for data decoding.

- Positive: Uses negative logic. High level is logic "0" and low level is logic "1".
- Negative: Uses positive logic. High level is logic "1" and low level is logic "0".

5. Set the Data Package

Press **Settings** to enter the data package setting menu.

- **Data**

Press **Data** and rotate the multifunction knob  to set the number of data bits actually contained in each frame of data. Then, press down the knob to select it. You can also press **Data** continuously or enable the touch screen to select it. The available data bits are 5 bits, 6 bits, 7 bits, 8 bits, and 9 bits.

- **Parity**

Used to check whether the data are properly transmitted. Press **Parity**, and rotate the multifunction knob  to select the desired parity mode, then press down the knob to select it. You can also press **Parity** continuously or enable the touch screen to select it.

- None: indicates that no check bit appears during the transmission.

- Even: indicates that the total number of "1" in the data bit and check bit is an even number. For example, when 0x55 (01010101) is sent, "0" should be added to the check bit.
- Odd: indicates that the total number of "1" in the data bit and check bit is an odd number. For example, when 0x55 (01010101) is sent, "1" should be added to the check bit.

- Stop Bit

Press **Stop Bit**, and rotate the multifunction knob  to set the stop bits after each frame of data. You can also press **Stop Bit** continuously or enable the touch screen to select it. It can be set to 1 bit, 1.5 bits, or 2 bits.

- Endian

Press **Endian** to select "LSB" or "MSB". By default, it is "LSB".

LSB: indicates Least Significant Bit transmission sequence, i.g. the lowest bit of the data is transmitted first.

MSB: indicates Most Significant Bit transmission sequence, i.g. the highest bit of the data is transmitted first.

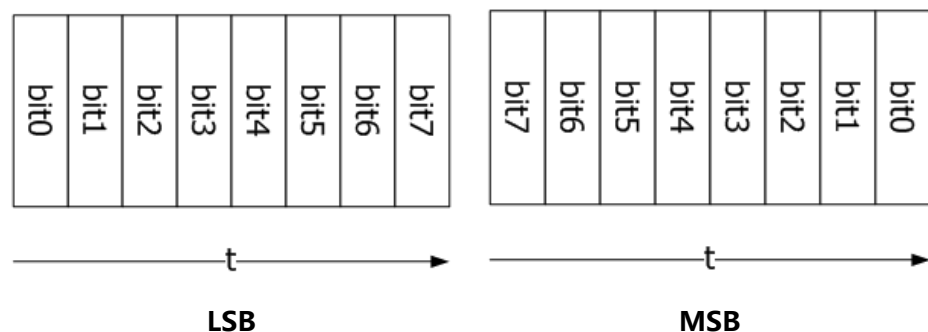

- Package

Press **Package** to enable or disable the package display in data transmission. When enabled, several data blocks will be combined based on the separator.

- Separator

Press **Separator**, and rotate the multifunction knob  to select the desired package separator in data transmission, then press down the knob to select it. You can also press **Separator** continuously or enable the touch screen to select it. It can be set to 0A(LF), 0D(CR), 20(SP), or 0(NUL).



6. Set Display-related Parameters

Press **Display** to enter the display setting menu.

- **Set the display format**

Press **Format**, rotate the multifunction knob  to select the display format of the bus data. Then, press down the knob to select it. You can also press **Format** continuously or enable the touch screen to select it. The available formats include Hex, Dec, Bin, and ASCII.

- **Adjust the vertical position of the bus**

Press **Position**, and then rotate the multifunction knob  to adjust the vertical display position of the bus. You can also rotate **Wave Vertical**  **POSITION** to adjust the vertical display position of the bus.

- **Set the label display**

Press **Label** to enable or disable the label display of the RS232 decoding bus. When enabled, the bus label "RS232-TX" and/or "RS232-RX" will be displayed at the upper-left side of the bus (when the bus display is enabled).

- **Set parameters for the event table**

Press **Event Table** to enter the event table setting menu. The event table displays the decoded data and the corresponding decoding information in time order in the form of a table. It can be used to observe relatively longer decoded data. The decoding information includes the decoded data (Tx and/or Rx), the corresponding line number, time, and error information (Tx and/or Rx).

NOTE

When the Tx and Rx source channels are set to "OFF", information of the data line is not displayed in the data table.

- Open or close the event table: Press **Event Table** continuously to enable or disable the display of the event table. You can also enable the touch screen to tap the icon  at the right-upper corner of the event table to close it.

NOTE

- When you adjust the horizontal time base, the waveform displayed on the screen will also change, and the total number of lines containing the decoding information in the event table will also be changed.
- The displayed decoded data information in the bus is related to the value of the horizontal time base. Reducing the horizontal time base can help you view the detailed information.
- Set the event table format: Press **Format**, rotate the multifunction knob  to select the display format of "Data" (Tx and/or Rx) in the event table. Then,

press down the knob to select it. You can also press **Format** continuously or enable the touch screen to select it. The available formats include Hex, Dec, Bin, and ASC.

- Set the view type: Press **View**, rotate the multifunction knob  to select the form of the event table to be viewed. Then, press down the knob to select it. You can also press **View** continuously or enable the touch screen to select it. The available choices include "Packets", "Details", and "Payload". You can also tap "Packets", "Details", or "Payload" at the top of the event table to select it.

If you select "Packets", the decoded data (Tx and/or Rx), time, and error information (Tx and/or Rx) are displayed in the event table. If you select "Details", the detailed data in the specified row will be displayed in the event table. If "..." appears in the row of data, it indicates that the decoded data are not fully displayed. At this time, you can view the details in the "Packets" view. If you select "Payload", all data in the specified column will be displayed in the event table. If "..." appears in the specified column of data, it indicates that the decoded data are not fully displayed. At this time, you can view the details in the "Packets" view.

- Export: If you select "Packets", you can export time and the corresponding decoded data. Press **Export**, then the save setting interface is displayed. You can export the data table of the packet to the internal memory or the external USB storage device (when detected) in CSV format. For detailed saving operation, refer to descriptions in "*Store and Load*".
- Jump to: Set the operating status of the oscilloscope to "STOP". Then, select the data of the specified time from the event table. Press **Jump to** and the specified data waveforms are displayed in the center of the screen.
- Decode: The setting of this menu enables you to quickly view the corresponding event tables of four decode modules (Decode1, Decode2, Decode3, and Decode4). Press **Decode**, then use the multifunction knob  to select a decode module, then press down the knob to select it. You can also press **Decode** continuously or enable the touch screen to select it.

7. Error Expressions in Decoding

In RS232 decoding, parity error and/or EOF (end of frame) error may occur.

- Parity error

When a parity error is detected during the decoding, red error report information will be displayed. For example, when "none" is chosen for the parity on the transmitter and "odd" is chosen for the parity on the decoder, the following parity error information **P** (its display form is related to the value of the horizontal time base) occurs, as shown in the figure below. Wherein, the number of 1s in the 8-digit figure (01001111, LSB) is an odd number, and the parity bit should be 0. However, the parity bit detected on the Tx is 1; thus a parity error occurs.

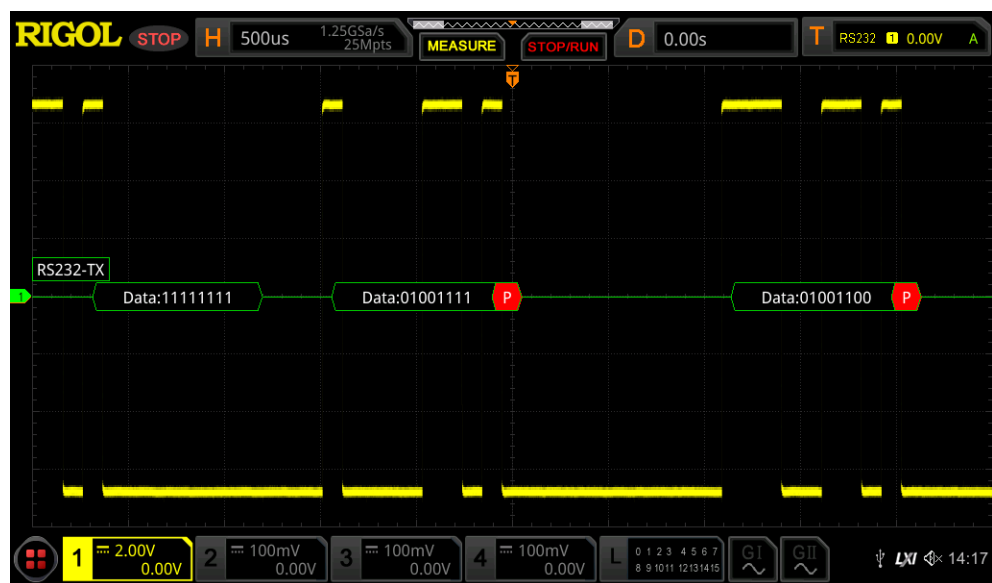

- EOF error

This error is generated when the EOF condition is not met. For example, if the **Stop Bit** is set to 1.5, but the actual stop bits is less than 1.5 bits, then the red error report information **S** (its display form is related to the value of the horizontal time base) is displayed in the following figure.

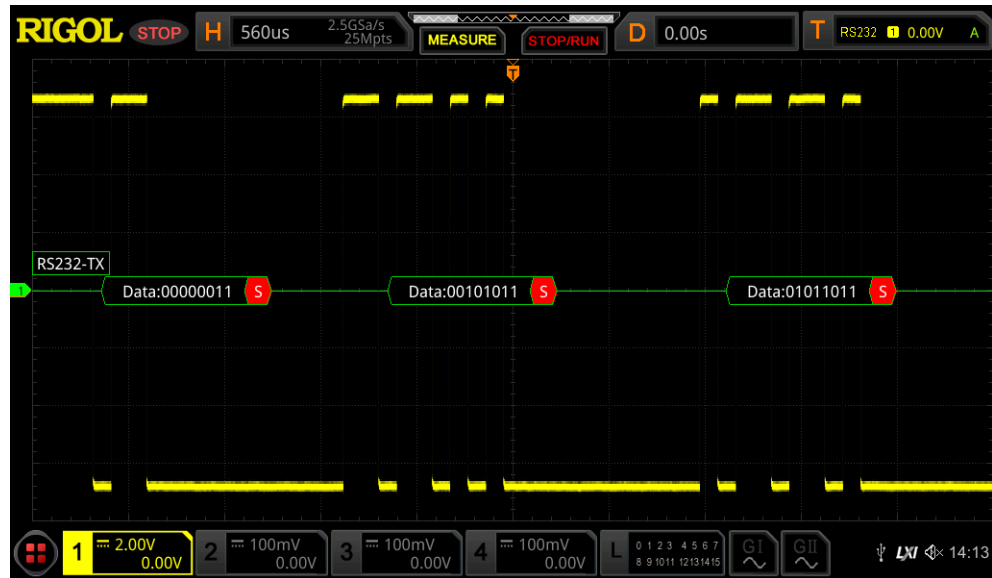

- Parity error and EOF error

When both the parity error and the EOF error are detected, the error report information (its display form is related to the value of the horizontal time base), as shown in the following figure, will be displayed.

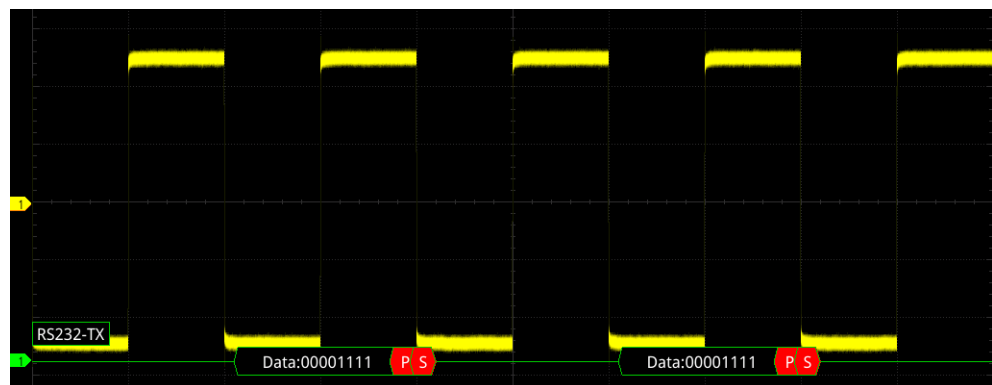

15.3 I2C Decoding (Option)

I2C serial bus consists of the clock line (SCL) and the data line (SDA).

SCL: samples SDA on the of rising or falling edge of the clock.

SDA: indicates the data channel.

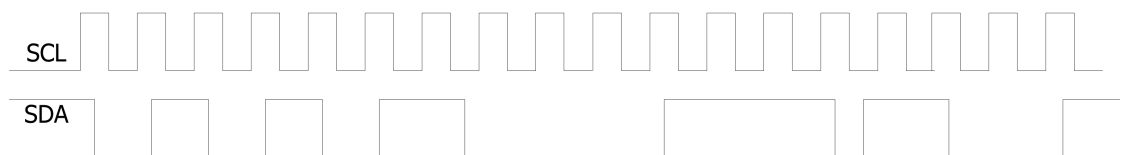



Figure 15.5 I2C Serial Bus

In the decode setting menu, press **Decode1** > **Bus Type**, then rotate the multifunction knob  to select "I2C". Press down the knob to select it. You can also press **Bus Type** continuously or enable the touch screen to select it.

1. Enable or Disable the Bus

Press **Bus Status** continuously to enable or disable the decoding function.



2. Quickly Apply I2C Trigger Settings to I2C Decoding

Press **Copy Trig** to copy the current I2C trigger settings (SCL and SDA) and apply them to I2C decoding function (SCL and SDA). For analog channels, the threshold level settings will also be copied.

3. Set the Source

Press **Sources** to enter the signal setting menu.

- Set the clock channel source and the threshold

- Press **SCL**, rotate the multifunction knob  to select the desired source of the clock channel, and then press down the knob it. You can also press **SCL** continuously or enable the touch screen to select it. You can select CH1-CH4 or D0-D15.
- When you select the analog channel (CH1-CH4), press **SCL Thre**, then rotate the multifunction knob  or use the pop-up numeric keypad to set the threshold of the clock channel. When you modify the threshold of the clock channel, a dotted line displaying the current threshold level is displayed on the screen. It disappears in about 2 s after you stop modifying the threshold.

- Set the data channel source and the threshold

Use the same method to select the source of the data channel and set the threshold (only when the source of the data channel is set to an analog channel (CH1-CH4)).

- Exchange sources

Press **Exchange** continuously to select "SCL/SDA" or "SDA/SCL" to exchange the sources of the current clock channel and data channel.

4. Specify whether to include/exclude the "R/W" bit in/from the address information

For I2C bus, each frame of data starts with the address information. The address information includes the read address and the write address. Press **R/W** continuously to select whether to include the "R/W" bit in the address information. When "With" is selected, the "R/W" bit will be included in the address information and located at the lowest bit; when "Without" is selected, the "R/W" bit will not be included in the address information.



5. Set Display-related Parameters

Press **Display** to enter the display setting menu.

- Set the display format

Press **Format**, rotate the multifunction knob  to select the display format of the bus data. Then, press down the knob to select it. You can also press Format continuously or enable the touch screen to select it. The available formats include Hex, Dec, Bin, and ASCII.

- Adjust the vertical position of the bus

Press **Position**, and then rotate the multifunction knob  to adjust the vertical display position of the bus. You can also rotate **Wave Vertical**  **POSITION** to adjust the vertical display position of the bus.

- Set the label display

Press **Label** to enable or disable the label display of the I2C decoding bus. When enabled, the bus label "I2C" will be displayed at the upper-left side of the bus (when the bus display is enabled).

- Set parameters for the event table

Press **Event Table** to enter the event table setting menu. The event table displays the decoded data and the corresponding decoding information in time order in the form of a table. It can be used to observe relatively longer decoded data. The decoding information includes the decoded data, the corresponding line number, time, R/W bit, address information, and acknowledgement information.

- Open or close the event table: Press **Event Table** continuously to enable or disable the display of the event table. When enabled, the following event table as shown in *Figure 15.6* is displayed. You can also enable the touch screen to tap the icon  at the right-upper corner of the event table to close it.

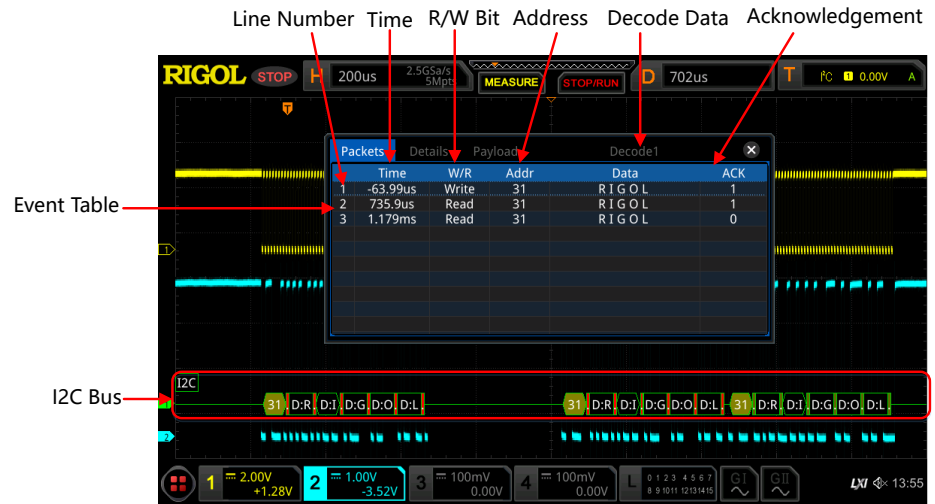



Figure 15.6 I2C Decoding Event Table

NOTE

- When you adjust the horizontal time base, the waveform displayed on the screen will also change, and the total number of lines containing the decoding information in the event table will also be changed.
- The displayed decoded data information in the bus is related to the value of the horizontal time base. Reducing the horizontal time base can help you view the detailed information.
- Set the event table format: Press **Format**, rotate the multifunction knob to select the display format of "Data" in the event table. Then, press down the knob to select it. You can also press **Format** continuously or enable the touch screen to select it. The available formats include Hex, Dec, Bin, and ASC.
- Set the view type: Press **View**, rotate the multifunction knob to select the form of the event table to be viewed. Then, press down the knob to select it. You can also press **View** continuously or enable the touch screen to select it. The available choices include "Packets", "Details", and "Payload". You can also tap "Packets", "Details", or "Payload" at the top of the event table to select it.

If you select "Packets", the decoded data, time, and other information are displayed in the event table. If you select "Details", the detailed data in the specified row will be displayed in the event table. If "..." appears in the row of

data, it indicates that the decoded data are not fully displayed. At this time, you can view the details in the "Packets" view. If you select "Payload", all data in the specified column will be displayed in the event table. If "..." appears in the specified column of data, it indicates that the decoded data are not fully displayed. At this time, you can view the details in the "Packets" view.

- Export: If you select "Packets", you can export time and the corresponding decoded data. Press **Export**, then the save setting interface is displayed. You can export the data table of the packet to the internal memory or the external USB storage device (when detected) in CSV format. For detailed saving operation, refer to descriptions in "*Store and Load*".
- Jump to: Set the operating status of the oscilloscope to "STOP". Then, select the data of the specified time from the event table. Press **Jump to** and the specified data waveforms are displayed in the center of the screen.
- Decode: The setting of this menu enables you to quickly view the corresponding event tables of four decode modules (Decode1, Decode2, Decode3, and Decode4). Press **Decode**, then use the multifunction knob  to select a decode module, then press down the knob to select it. You can also press **Decode** continuously or enable the touch screen to select it.

6. Address Information in Decoding

For I2C bus, each frame of data starts with the address information (read address and write address). In the address information, "Read" indicates the read address (**Read:0A**) and "Write" indicates the write address (**Write:4D**). You can decide whether to include or exclude the "R/W" bit for the address information.

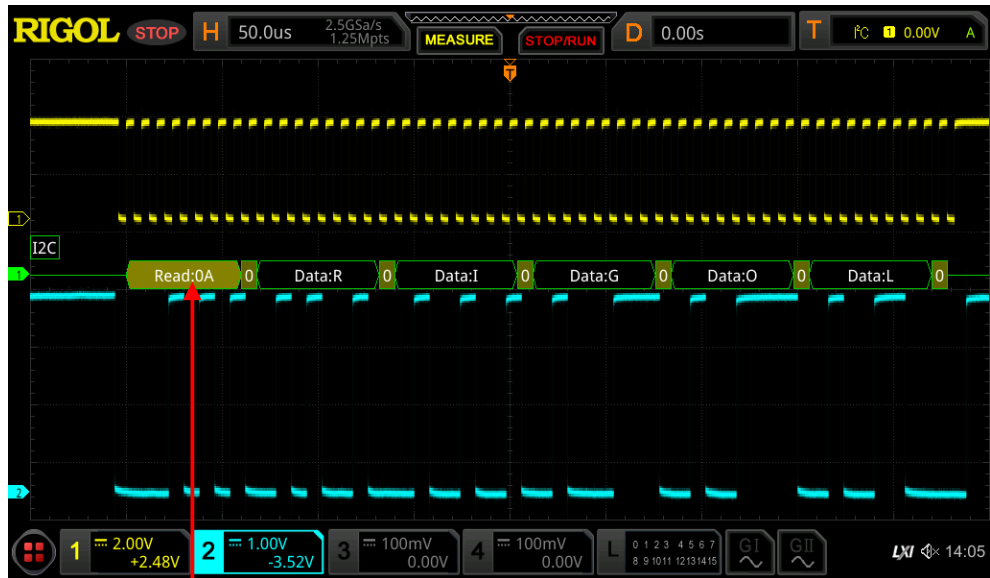

Address Information (Read Address)

7. Error Expressions in Decoding

In I2C decoding, when ACK (acknowledgment) is 1, ACK error occurs. When the detected ACK is 1, red error report information **A:1** (the display form is related to the value of the horizontal time base) is displayed.

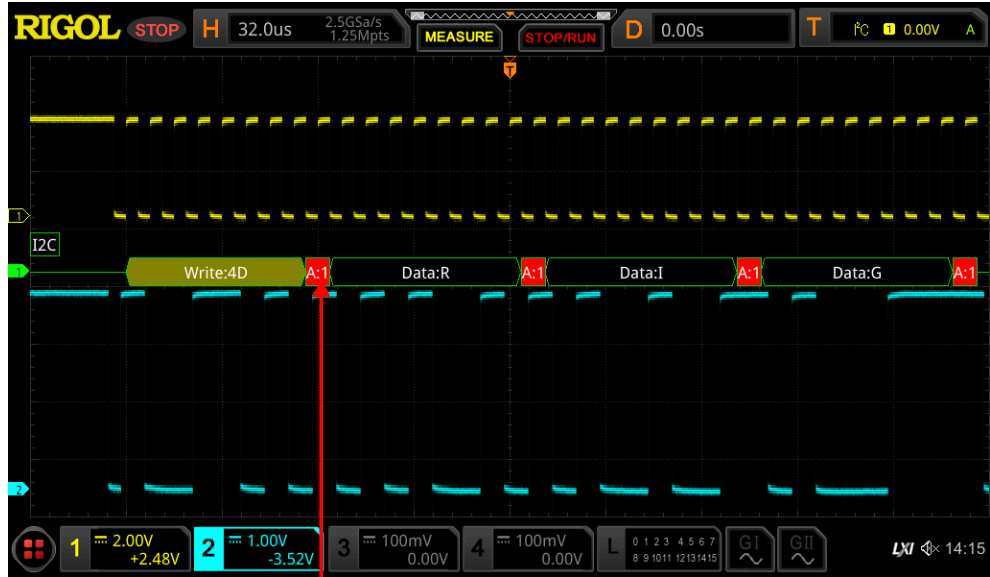

The detected ACK is 1

15.4 SPI Decoding (Option)

SPI bus is based on the master— slave configuration and usually consists of chip select line (CS), clock line (CLK), and data line (SDA). Wherein, the data lines include

the master input/slave output (MISO) data line and master output/slave input (MOSI) data line. The oscilloscope samples the channel data on the rising or falling edge of the clock signal (if the source is an analog channel, the oscilloscope will also judge each data point (logic "1" or logic "0") according to the preset threshold level).

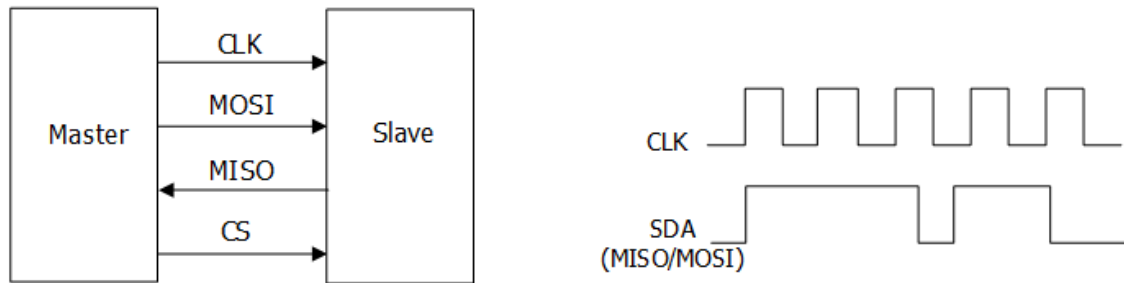



Figure 15.7 SPI Serial Bus

In the decode setting menu, press **Decode1** > **Bus Type**, then rotate the multifunction knob  to select "SPI". Press down the knob to select it. You can also press **Bus Type** continuously or enable the touch screen to select it.

1. Enable or Disable the Bus

Press **Bus Status** continuously to enable or disable the decoding function.

2. Quickly Apply SPI Trigger Settings to SPI Decoding

Press **Copy Trig** to copy the SPI trigger settings and apply them to SPI decoding function (set the corresponding SPI decoding parameters automatically). The settings that can be copied include CS/timeout mode, CLK, CLK, MISO, MOSI, Width, and etc. For analog channels, the threshold level settings will also be copied.

3. Set the Mode Press **Mode** to enter the mode setting menu.





Press **Mode** continuously to select "Timeout" or "CS".

- Timeout:

you can perform frame synchronization according to the timeout, and the timeout value must be greater than half of the clock cycle. Press **Timeout**, and then rotate the multifunction knob  or use the pop-up numeric keypad to set the timeout value. The adjustable range of the timeout value is from 8 ns to 10 s. By default, it is 1 μ s.

- CS:





contains a chip select line (CS). You can perform frame synchronization according to CS. When "CS" is selected,

- Press **CS**, then rotate the multifunction knob  to select the desired channel, and then press down the knob to select it. You can also press **CS** continuously or enable the touch screen to select it. The analog channel (CH1-CH4) or digital channel (D0-D15) can all be selected as the CS channel.
- Press **CS Polarity** continuously to select Positive  or Negative  as the polarity for CS channel.
- When you select the analog channel (CH1-CH4) as the CS channel, press **Threshold**, then rotate the multifunction knob  or use the pop-up numeric keypad to set the threshold.

4. Set the Source

Press **Sources** to enter the signal setting menu.



- Set the CLK

- Press **CLK**, then rotate the multifunction knob  to select the desired source of the clock channel, and then press down the knob to select it. You can also press **CLK** continuously or enable the touch screen to select it. The analog channel (CH1-CH4) or digital channel (D0-D15) can all be selected.
- When you select the analog channel (CH1-CH4), press **Threshold** below **CLK**, then rotate the multifunction knob  or use the numeric keypad to set the threshold of the clock channel.
- Press **Slope** to set the instrument to sample MISO and MOSI on the rising edge () or the falling edge () of CLK.

- Set MISO and MOSI

- Press **MISO**, then rotate the multifunction knob  to select the MISO data channel, and then press down the knob to select it. You can also press **MISO** continuously or enable the touch screen to select it. The available channels include OFF, analog channels (CH1-CH4), and digital channels (D0-D15). When you select the analog channel (CH1-CH4), press **Threshold** below

MISO, then rotate the multifunction knob  or use the numeric keypad to set the threshold of the MISO data channel.

- Press **MOSI**, then rotate the multifunction knob  to select the MOSI data channel, and then press down the knob to select it. You can also press **MOSI** continuously or enable the touch screen to select it. The available channels include OFF, analog channels (CH1-CH4), and digital channels (D0-D15). When you select the analog channel (CH1-CH4), press **Threshold** below **MOSI**, then rotate the multifunction knob  or use the numeric keypad to set the threshold of the MOSI data channel.

NOTE

The source channels of MISO and MOSI cannot be set to "OFF" at the same time.

5. Set the Data Parameters

Press **Settings** to enter the data setting menu.



- Set the endian

Press **Endian** to select "LSB" or "MSB". By default, it is MSB

LSB: indicates Least Significant Bit transmission sequence, i.g. the lowest bit of the data is transmitted first.

MSB: indicates Most Significant Bit transmission sequence, i.g. the highest bit of the data is transmitted first.

- Set the polarity

Press **Polarity** continuously to select Positive  or Negative  as the polarity for data decoding.

- Set the width

Press **Width**, then rotate the multifunction knob  or use the pop-up numeric keypad to set the bits of each frame of data. The setting range is from 4 to 32. By default, it is 8.



6. Set Display-related Parameters

Press **Display** to enter the display setting menu.

- Set the display format

Press **Format**, rotate the multifunction knob  to select the display format of the bus data. Then, press down the knob to select it. You can also press **Format** continuously or enable the touch screen to select it. The available formats include Hex, Dec, Bin, and ASCII.

- **Adjust the vertical position of the bus**

Press **Position**, and then rotate the multifunction knob  to adjust the vertical display position of the bus. You can also rotate **Wave Vertical**  **POSITION** to adjust the vertical display position of the bus.

- **Set the label display**

Press **Label** to enable or disable the label display of the RS232 decoding bus. When enabled, the bus label "SPI-MISO" and/or "SPI-MOSI" will be displayed at the upper-left side of the bus (when the bus display is enabled).

- **Set parameters for the event table**

Press **Event Table** to enter the event table setting menu. The event table displays the decoded data and the corresponding decoding information in time order in the form of a table. It can be used to observe relatively longer decoded data. The decoding information includes the decoded data (MISO and/or MOSI), the corresponding line number, time, and error information (MISO and/or MOSI).

NOTE

When the source channel of MISO or MOSI is set to "OFF", information of the data line is not displayed in the data table.

- Open or close the event table: Press **Event Table** continuously to enable or disable the display of the event table. When enabled, the following event table as shown in *Figure 15.8* is displayed. You can also enable the touch screen to tap the icon  at the right-upper corner of the event table to close it.

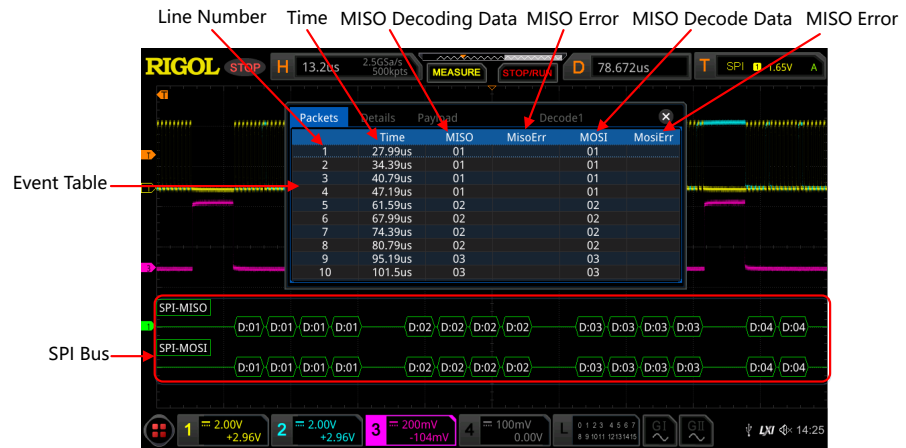





Figure 15.8 SPI Decoding Event Table

NOTE

- When you adjust the horizontal time base, the waveform displayed on the screen will also change, and the total number of lines containing the decoding information in the event table will also be changed.
- The displayed decoded data information in the bus is related to the value of the horizontal time base. Reducing the horizontal time base can help you view the detailed information.
- Set the event table format: Press **Format**, rotate the multifunction knob  to select the display format of "Data" (MISO and/or MOSI) in the event table. Then, press down the knob to select it. You can also press **Format** continuously or enable the touch screen to select it. The available formats include Hex, Dec, Bin, and ASC.
- Set the view type: Press **View**, rotate the multifunction knob  to select the form of the event table to be viewed. Then, press down the knob to select it. You can also press **View** continuously or enable the touch screen to select it. The available choices include "Packets", "Details", and "Payload". You can also tap "Packets", "Details", or "Payload" at the top of the event table to select it.

If you select "Packets", the decoded data (MISO and/or MOSI), time, and error information (MISO and/or MOSI) are displayed in the event table. If you select "Details", the detailed data in the specified row will be displayed in the event table. If "..." appears in the row of data, it indicates that the decoded data are not fully displayed. At this time, you can view the details in

the "Packets" view. If you select "Payload", all data in the specified column will be displayed in the event table. If "..." appears in the specified column of data, it indicates that the decoded data are not fully displayed. At this time, you can view the details in the "Packets" view.

- Export: If you select "Packets", you can export time and the corresponding decoded data. Press **Export**, then the save setting interface is displayed. You can export the data table of the packet to the internal memory or the external USB storage device (when detected) in CSV format. For detailed saving operation, refer to descriptions in "*Store and Load*".
- Jump to: Set the operating status of the oscilloscope to "STOP". Then, select the data of the specified time from the event table. Press **Jump to** and the specified data waveforms are displayed in the center of the screen.
- Decode: The setting of this menu enables you to quickly view the corresponding event tables of four decode modules (Decode1, Decode2, Decode3, and Decode4). Press **Decode**, then use the multifunction knob  to select a decode module, then press down the knob to select it. You can also press **Decode** continuously or enable the touch screen to select it.

15.5 LIN Decoding (Option)

The oscilloscope samples the LIN signal, and judges each data point to be logic "1" or logic "0" according to the preset threshold level. The LIN decoding is required to specify the LIN signal protocol version.

In the decode setting menu, press **Decode1** > **Bus Type**, then rotate the multifunction knob  to select "LIN". Press down the knob to select it. You can also press **Bus Type** continuously or enable the touch screen to select it.



1. Enable or Disable the Bus

Press **Bus Status** continuously to enable or disable the decoding function.

2. Quickly Apply LIN Trigger Settings to LIN Decoding

Press **Copy Trig** to copy the current LIN trigger settings and apply them to LIN decoding function (set the corresponding LIN decoding parameters automatically). For analog channels, the threshold level settings will also be copied.

3. Set the Source and the Threshold

- Press **Source**, rotate the multifunction knob  to select the desired source channel, and then press down the knob it. You can also press **Source** continuously or enable the touch screen to select it. You can select CH1-CH4 or D0-D15.
- When you select the analog channel (CH1-CH4), press **Threshold**, then rotate the multifunction knob  or use the pop-up numeric keypad to set the threshold of the source channel. When you modify the threshold of the clock channel, a dotted line displaying the current threshold level is displayed on the screen. It disappears in about 2 s after you stop modifying the threshold.

4. Set the Signal

Press **Settings** to enter the signal setting menu.

- **Set the baud rate**

Three methods are available for setting the baud rate:

- Press **Baud Rate**, then set the user-defined baud rate with the displayed numeric keypad.
- Press **Baud Rate** to select the preset baud rate. The available baud rates include 2.4 kbps, 4.8 kbps, 9.6 kbps, 19.2 kbps, and etc.
- Press **Baud Rate**, then rotate the multifunction knob  to baud rate at a small step of 1 bps.

- **Set the parity bit**

Press **Parity bit** continuously to select whether the data contain the parity bit.

- **Set the protocol version**

Press **Version**, and rotate the multifunction knob  to select a protocol version that matches the LIN bus signal. Then, press down the knob to select it. You can also press **Version** continuously or enable the touch screen to select it. The available versions include 1.X, 2.X, and Both.



5. Set Display-related Parameters

Press **Display** to enter the display setting menu.

- **Set the display format**

Press **Format**, rotate the multifunction knob  to select the display format of the bus data. Then, press down the knob to select it. You can also press **Format** continuously or enable the touch screen to select it. The available formats include Hex, Dec, Bin, and ASCII.

- **Adjust the vertical position of the bus**

Press **Position**, and then rotate the multifunction knob  to adjust the vertical display position of the bus. You can also rotate **Wave Vertical**  **POSITION** to adjust the vertical display position of the bus.

- **Set the label display**

Press **Label** to enable or disable the label display of the LIN decoding bus. When enabled, the bus label "LIN" will be displayed at the upper-left side of the bus (when the bus display is enabled).

- **Set parameters for the event table**

Press **Event Table** to enter the event table setting menu. The event table displays the decoded data and the corresponding decoding information in time order in the form of a table. It can be used to observe relatively longer decoded data. The decoding information includes the decoded data, the corresponding line number, time, frame ID, cyclic redundancy check (CRC), and error information.

- Open or close the event table: Press **Event Table** continuously to enable or disable the display of the event table. When enabled, the following event table as shown in *Figure 15.9* is displayed. You can also enable the touch screen to tap the icon  at the right-upper corner of the event table to close it.

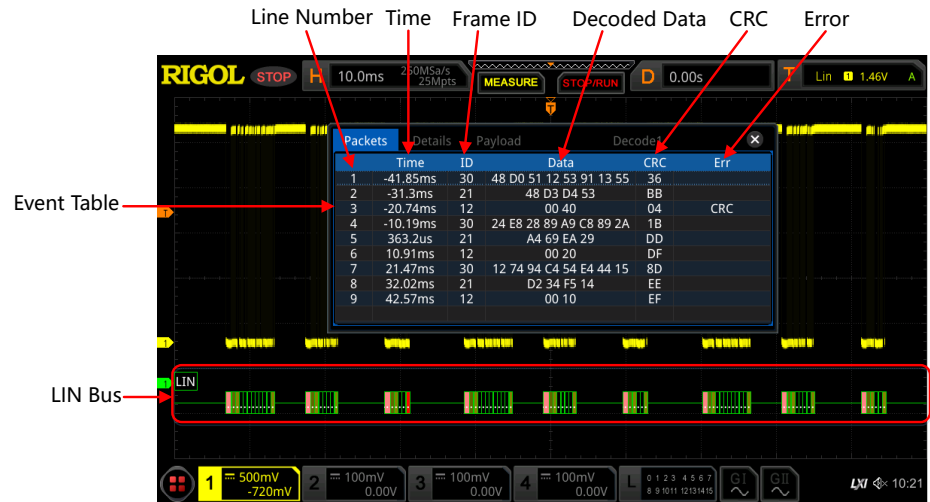





Figure 15.9 LIN Decoding Event Table

NOTE

- When you adjust the horizontal time base, the waveform displayed on the screen will also change, and the total number of lines containing the decoding information in the event table will also be changed.
- The displayed decoded data information in the bus is related to the value of the horizontal time base. Reducing the horizontal time base can help you view the detailed information.
- Set the event table format: Press **Format**, rotate the multifunction knob  to select the display format of "Data" in the event table. Then, press down the knob to select it. You can also press **Format** continuously or enable the touch screen to select it. The available formats include Hex, Dec, Bin, and ASC.
- Set the view type: Press **View**, rotate the multifunction knob  to select the form of the event table to be viewed. Then, press down the knob to select it. You can also press **View** continuously or enable the touch screen to select it. The available choices include "Packets", "Details", and "Payload". You can also tap "Packets", "Details", or "Payload" at the top of the event table to select it.

If you select "Packets", the decoded data, time, and other information are displayed in the event table. If you select "Details", the detailed data in the specified row will be displayed in the event table. If "..." appears in the row of

data, it indicates that the decoded data are not fully displayed. At this time, you can view the details in the "Packets" view. If you select "Payload", all data in the specified column will be displayed in the event table. If "..." appears in the specified column of data, it indicates that the decoded data are not fully displayed. At this time, you can view the details in the "Packets" view.

- Export: If you select "Packets", you can export time and the corresponding decoded data. Press **Export**, then the save setting interface is displayed. You can export the data table of the packet to the internal memory or the external USB storage device (when detected) in CSV format. For detailed saving operation, refer to descriptions in "*Store and Load*".
- Jump to: Set the operating status of the oscilloscope to "STOP". Then, select the data of the specified time from the event table. Press **Jump to** and the specified data waveforms are displayed in the center of the screen.
- Decode: The setting of this menu enables you to quickly view the corresponding event tables of four decode modules (Decode1, Decode2, Decode3, and Decode4). Press **Decode**, then use the multifunction knob  to select a decode module, then press down the knob to select it. You can also press **Decode** continuously or enable the touch screen to select it.

6. Interpret the Decoded LIN Data

- Break (Sync Break): expressed in Hex, displayed as a pink patch.
- SYNC (Sync): expressed in Hex, displayed as a dark green patch.
- ID (Frame ID): expressed in Hex, displayed as a blue-green patch.
- Data (Data): Its display format is the same as that of the bus data (Hex, Dec, Bin, or ASCII), displayed as a black patch.
- CRC (Cyclic Redundancy Check): expressed in Hex, displayed in light yellow-green. When errors occur, it is displayed as a red patch.

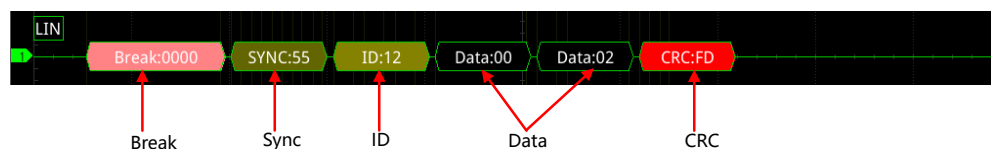

- Wakeup (wake up symbol): displayed as a tangerine patch.



7. Error Expressions in Decoding

In LIN decoding, the parity error, checksum error, or sync error may occur.

- Parity error

If the parity error is detected, frame ID and parity bit (when the signal is set to include the parity bit) will be displayed in red, as shown in the figure below.

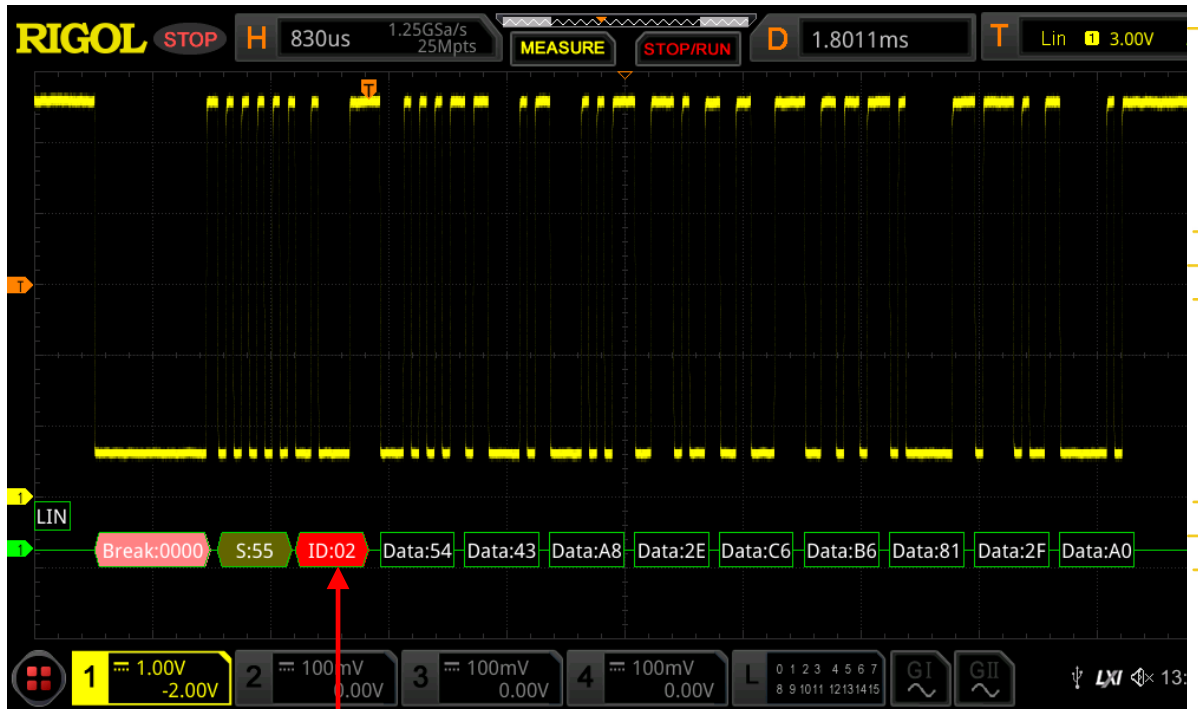

Parity Error

- Checksum error

If the checksum error is detected, CRC is displayed in red, as shown in the figure below.

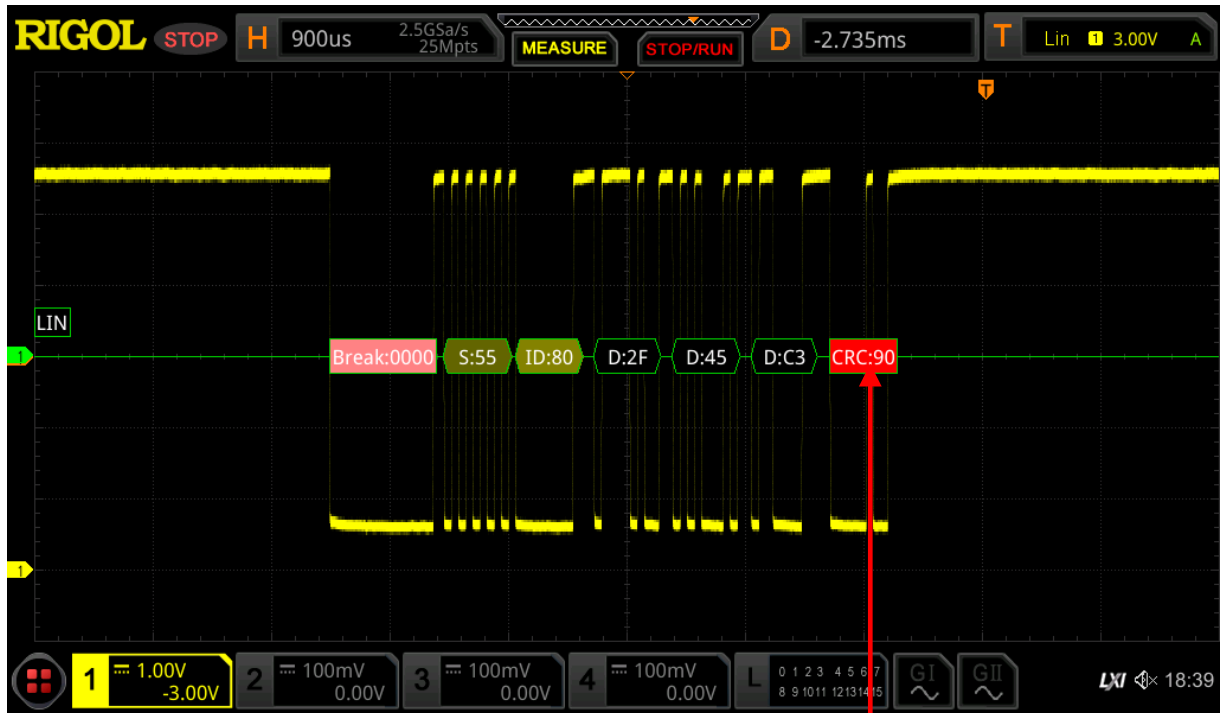

Checksum Error

- Sync error

If the sync error is detected, SYNC is displayed in red, as shown in the figure below.

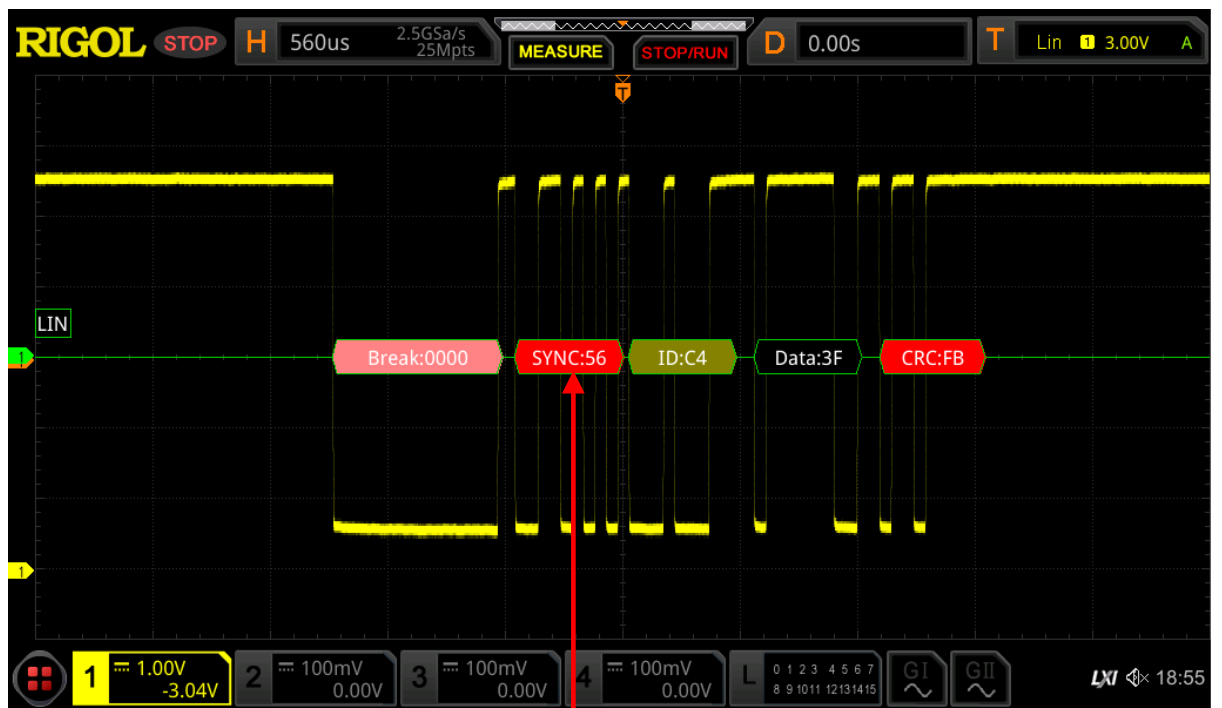

Sync Error

15.6 CAN Decoding (Option)

The oscilloscope samples the CAN signal at the specified sample position, and judges each data point to be logic "1" or logic "0" according to the preset threshold level. You need to specify the CAN signal type and sample position for CAN decoding.



In the decode setting menu, press **Decode1** > **Bus Type**, then rotate the multifunction knob  to select "CAN". Press down the knob to select it. You can also press **Bus Type** continuously or enable the touch screen to select it.

1. Enable or Disable the Bus Press **Bus Status** continuously to enable or disable the decoding function.

2. Quickly Apply CAN Trigger Settings to CAN Decoding

Press **Copy Trig** to copy the current CAN trigger settings and apply them to CAN decoding function (set the corresponding CAN decoding parameters automatically). For analog channels, the threshold level settings will also be copied.

3. Set the Source and the Threshold

- Press **Source**, rotate the multifunction knob  to select the desired source channel, and then press down the knob it. You can also press **Source** continuously or enable the touch screen to select it. You can select CH1-CH4 or D0-D15.
- When you select the analog channel (CH1-CH4), press **Threshold**, then rotate the multifunction knob  or use the pop-up numeric keypad to set the threshold of the source channel. When you modify the threshold of the clock channel, a dotted line displaying the current threshold level is displayed on the screen. It disappears in about 2 s after you stop modifying the threshold.

4. Set the Signal

Press **Settings** to enter the signal setting menu.

- Set the signal type

Press **Signal** and rotate the multifunction knob  to select a signal type that matches the CAN bus signal. Press down the knob to select it. You can also press **Signal** continuously or enable the touch screen to select it. The available signal types include CAN_H, CAN_L, Rx, Tx, and Diff.

- CAN_H: indicates the actual CAN_H bus signal.

- CAN_L: indicates the actual CAN_L bus signal.
- Rx: indicates the Receive signal from the CAN bus transceiver.
- Tx: indicates the Transmit signal from the CAN bus transceiver.
- DIFF: indicates the CAN differential bus signals connected to an analog channel by using a differential probe. Connect the differential probe's positive lead to the CAN_H bus signal and connect the negative lead to the CAN_L bus signal.

- Specify the standard signal rate

Three methods are available for setting the baud rate:

- Press **Baud**, then set the user-defined baud rate with the displayed numeric keypad.
- Press **Baud** to select the preset baud rate. The available baud rates include 10 kbps, 20 kbps, 33.3 kbps, 50 kbps, and etc.
- Press **Baud**, then rotate the multifunction knob  to adjust the baud rate at a small step.

- Sample position

Sample position is a point within a bit's time. The oscilloscope samples the bit level at this point. The sample position is represented by the proportion of "the time from the start of the bit to the sample point" to the "bit time", as shown in the figure below.

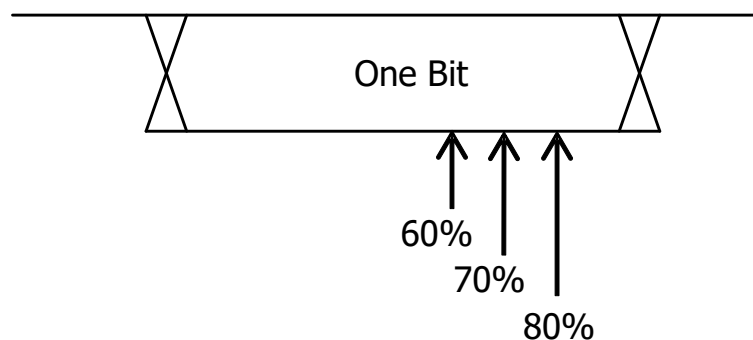



Figure 15.10 Sample Position

Press **Sample Position**, then rotate the multifunction knob  or use the pop-up numeric keypad to set the sample position. The settable range is from 10% to 90%.

- **CAN-FD baud**

Three methods are available for setting the CAN-FD baud rate:

- Press **CAN-FD Baud**, then set the user-defined baud rate with the displayed numeric keypad.
- Press **CAN-FD Baud** to select the preset CAN-FD baud rate. The available baud rates are 1 Mbps, 2 Mbps, 3 Mbps, 4 Mbps, and etc.
- Press **CAN-FD Baud**, then rotate the multifunction knob  to adjust the CAN-FD baud rate at a small step.

- **FD sample position**

FD sample position is a dedicated parameter configured for the CAN-FD decoding. Press **FD Sample Position**, then rotate the multifunction knob  or use the pop-up numeric keypad to set the FD sample position. The settable range is from 10% to 90%.



5. Set Display-related Parameters

Press **Display** to enter the display setting menu.

- **Set the display format**

Press **Format**, rotate the multifunction knob  to select the display format of the bus data. Then, press down the knob to select it. You can also press **Format** continuously or enable the touch screen to select it. The available formats include Hex, Dec, Bin, and ASCII.

- **Adjust the vertical position of the bus**

Press **Position**, and then rotate the multifunction knob  to adjust the vertical display position of the bus. You can also rotate **Wave Vertical**  **POSITION** to adjust the vertical display position of the bus.

- **Set the label display**

Press **Label** to enable or disable the label display of the CAN decoding bus. When enabled, the bus label "CAN" will be displayed at the upper-left side of the bus (when the bus display is enabled).

- **Set parameters for the event table**

Press **Event Table** to enter the event table setting menu. The event table displays the decoded data and the corresponding decoding information in time order in the form of a table. It can be used to observe relatively longer decoded data. The decoding information includes the decoded data, the corresponding

line number, time, frame ID, data length code (DLC), cyclic redundancy check (CRC), and Acknowledgement (ACK) information.

- Open or close the event table: Press **Event Table** continuously to enable or disable the display of the event table. When enabled, the following event table as shown in *Figure 15.11* is displayed. You can also enable the touch screen to tap the icon  at the right-upper corner of the event table to close it.

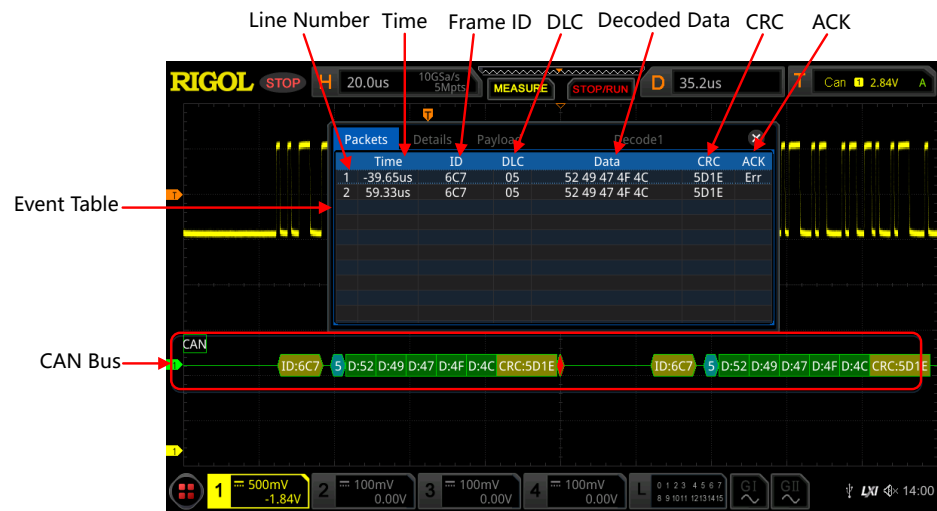





Figure 15.11 CAN Decoding Event Table

NOTE

- When you adjust the horizontal time base, the waveform displayed on the screen will also change, and the total number of lines containing the decoding information in the event table will also be changed.
- The displayed decoded data information in the bus is related to the value of the horizontal time base. Reducing the horizontal time base can help you view the detailed information.
- Set the event table format: Press **Format**, rotate the multifunction knob  to select the display format of "Data" in the event table. Then, press down the knob to select it. You can also press **Format** continuously or enable the touch screen to select it. The available formats include Hex, Dec, Bin, and ASC.
- Set the view type: Press **View**, rotate the multifunction knob  to select the form of the event table to be viewed. Then, press down the knob to select it.

You can also press **View** continuously or enable the touch screen to select it. The available choices include "Packets", "Details", and "Payload". You can also tap "Packets", "Details", or "Payload" at the top of the event table to select it.

If you select "Packets", the decoded data, time, and other information are displayed in the event table. If you select "Details", the detailed data in the specified row will be displayed in the event table. If "..." appears in the row of data, it indicates that the decoded data are not fully displayed. At this time, you can view the details in the "Packets" view. If you select "Payload", all data in the specified column will be displayed in the event table. If "..." appears in the specified column of data, it indicates that the decoded data are not fully displayed. At this time, you can view the details in the "Packets" view.

- Export: If you select "Packets", you can export time and the corresponding decoded data. Press **Export**, then the save setting interface is displayed. You can export the data table of the packet to the internal memory or the external USB storage device (when detected) in CSV format. For detailed saving operation, refer to descriptions in "*Store and Load*".
- Jump to: Set the operating status of the oscilloscope to "STOP". Then, select the data of the specified time from the event table. Press **Jump to** and the specified data waveforms are displayed in the center of the screen.
- Decode: The setting of this menu enables you to quickly view the corresponding event tables of four decode modules (Decode1, Decode2, Decode3, and Decode4). Press **Decode**, then use the multifunction knob  to select a decode module, then press down the knob to select it. You can also press **Decode** continuously or enable the touch screen to select it.

6. Interpret the Decoded CAN Data

- Frame ID: expressed in Hex, displayed as a dark yellow-green patch.
- DLC (Data Length Code): expressed in Hex, displayed as a blue-green patch.
- Data: Its display format is the same as that of the bus data (Hex, Dec, Bin, or ASCII), displayed as a green patch.

- CRC (Cyclic Redundancy Check): expressed in Hex, displayed in yellow-green. When errors occur, it is displayed as a red patch.
- ACK (Acknowledgement): when effective, displayed as a light yellow-green patch; when errors (ACK is detected to be 1) occur, displayed as a red patch.

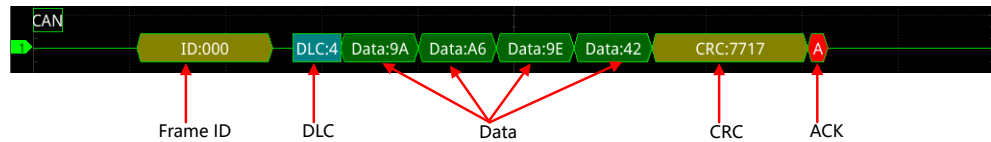

- R (remote frame): displayed as a tangerine patch.



- Stuff (Bit filling error): displayed as a red patch.



15.7 FlexRay Decoding (Option)

FlexRay is a type of differential serial bus configured with three consecutive segments (i.g. packet header, payload, and packet trailer). The oscilloscope samples the FlexRay signal at the specified sample position and judges each data point as logic "1" or logic "0" according to the preset threshold level. The FlexRay decoding is required to specify the signal type and baud rate.

In the decode setting menu, press **Decode1** > **Bus Type**, then rotate the multifunction knob  to select "FlexRay". Press down the knob to select it. You can also press **Bus Type** continuously or enable the touch screen to select it.

1. Enable or Disable the Bus

Press **Bus Status** continuously to enable or disable the decoding function.

2. Quickly Apply FlexRay Trigger Settings to FlexRay Decoding

Press **Copy Trig** to copy the current FlexRay trigger settings and apply them to FlexRay decoding function (set the corresponding FlexRay decoding parameters automatically). For analog channels, the threshold level settings will also be copied.

3. Set the Source and the Threshold

- Press **Source**, rotate the multifunction knob  to select the desired source channel, and then press down the knob it. You can also press **Source**

continuously or enable the touch screen to select it. You can select CH1-CH4 or D0-D15.

- When you select the analog channel (CH1-CH4), press **Threshold**, then rotate the multifunction knob  or use the pop-up numeric keypad to set the threshold of the source channel. When you modify the threshold of the clock channel, a dotted line displaying the current threshold level is displayed on the screen. It disappears in about 2 s after you stop modifying the threshold.

4. Set the Signal

Press **Settings** to enter the signal setting menu.

- **Select the channel**

Press **Channel** to select a channel ("A" or "B") that matches the actual FlexRay bus signal.

- **Specify the signal rate**

Press **Baud** to open the baud rate list (2.5 Mbps, 5 Mbps, and 10 Mbps), and select a preset baud rate that matches the actual FlexRay bus signal. You can also press **Baud** continuously, then rotate the multifunction knob  or use the numeric keypad to set the desired baud rate.

- **Set the signal type**

Press **Signal** and rotate the multifunction knob  to select a signal type that matches the actual FlexRay bus signal. Press down the knob to select it. You can also press **Signal** continuously or enable the touch screen to select it. The available signal types include BP, BM, and RX/TX.

- **Sample position**

Sample position is a point within a bit's time. The oscilloscope samples the bit level at this point. The sample position is represented by the proportion of "the time from the start of the bit to the sample point" to the "bit time", as shown in the figure below.

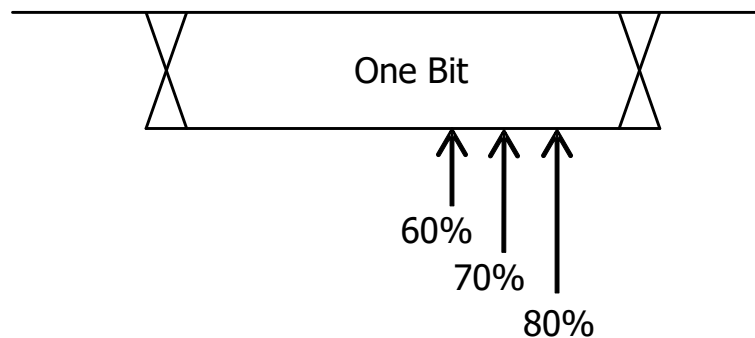



Figure 15.12 Sample Position

Press **Sample Position**, then rotate the multifunction knob  or use the pop-up numeric keypad to set the sample position. The settable range is from 10% to 90%.



5. Set Display-related Parameters

Press **Display** to enter the display setting menu.

- Set the display format

Press **Format**, rotate the multifunction knob  to select the display format of the bus data. Then, press down the knob to select it. You can also press **Format** continuously or enable the touch screen to select it. The available formats include Hex, Dec, Bin, and ASCII.

- Adjust the vertical position of the bus

Press **Position**, and then rotate the multifunction knob  to adjust the vertical display position of the bus. You can also rotate **Wave Vertical**  **POSITION** to adjust the vertical display position of the bus.

- Set the label display

Press **Label** to enable or disable the label display of the FlexRay decoding bus. When enabled, the bus label "Flexray" will be displayed at the upper-left side of the bus (when the bus display is enabled).

- Set parameters for the event table

Press **Event Table** to enter the event table setting menu. The event table displays the decoded data and the corresponding decoding information in time order in the form of a table. It can be used to observe relatively longer decoded data. The decoding information includes the decoded data, the corresponding line number, time, frame ID, and Payload Length (PL).

- Open or close the event table: Press **Event Table** continuously to enable or disable the display of the event table. When enabled, the following event table as shown in *Figure 15.13* is displayed. You can also enable the touch screen to tap the icon  at the right-upper corner of the event table to close it.

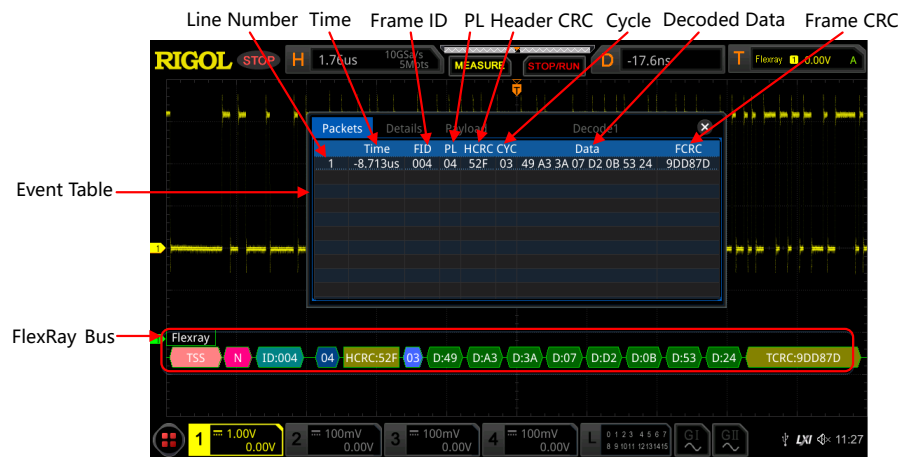





Figure 15.13 FlexRay Decoding Event Table

NOTE

- When you adjust the horizontal time base, the waveform displayed on the screen will also change, and the total number of lines containing the decoding information in the event table will also be changed.
- The displayed decoded data information in the bus is related to the value of the horizontal time base. Reducing the horizontal time base can help you view the detailed information.
- Set the event table format: Press **Format**, rotate the multifunction knob  to select the display format of "Data" in the event table. Then, press down the knob to select it. You can also press **Format** continuously or enable the touch screen to select it. The available formats include Hex, Dec, Bin, and ASC.
- Set the view type: Press **View**, rotate the multifunction knob  to select the form of the event table to be viewed. Then, press down the knob to select it. You can also press **View** continuously or enable the touch screen to select it. The available choices include "Packets", "Details", and "Payload". You can

also tap "Packets", "Details", or "Payload" at the top of the event table to select it.

If you select "Packets", the decoded data, time, and other information are displayed in the event table. If you select "Details", the detailed data in the specified row will be displayed in the event table. If "..." appears in the row of data, it indicates that the decoded data are not fully displayed. At this time, you can view the details in the "Packets" view. If you select "Payload", all data in the specified column will be displayed in the event table. If "..." appears in the specified column of data, it indicates that the decoded data are not fully displayed. At this time, you can view the details in the "Packets" view.

- Export: If you select "Packets", you can export time and the corresponding decoded data. Press **Export**, then the save setting interface is displayed. You can export the data table of the packet to the internal memory or the external USB storage device (when detected) in CSV format. For detailed saving operation, refer to descriptions in "*Store and Load*".
- Jump to: Set the operating status of the oscilloscope to "STOP". Then, select the data of the specified time from the event table. Press **Jump to** and the specified data waveforms are displayed in the center of the screen.
- Decode: The setting of this menu enables you to quickly view the corresponding event tables of four decode modules (Decode1, Decode2, Decode3, and Decode4). Press **Decode**, then use the multifunction knob  to select a decode module, then press down the knob to select it. You can also press **Decode** continuously or enable the touch screen to select it.

6. Interpret the decoded FlexRay frame data

- TSS: transmission start sequence, displayed as a pink patch.
- Sync Frame: displayed as a deep pink patch.
- ID (Frame ID): expressed in Hex, displayed as a blue-green patch.
- PL (Payload Length): expressed in Hex, displayed as a dark blue patch.
- HCRC (Header Cyclic Redundancy Check): expressed in Hex, displayed in yellow-green. When CRC errors occur, it is displayed as a red patch.
- CYC (Cycle Number): expressed in Hex, displayed as a light blue patch.

- Data: Its display format is the same as that of the bus data (Hex, Dec, Bin, or ASCII), displayed as a green patch.
- TCRC (Tail Cyclic Redundancy Check): expressed in Hex, displayed as a yellow-green patch. When CRC errors occur, it is displayed as a red patch.

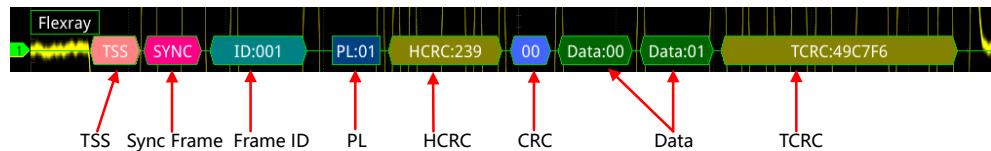

15.8 I2S Decoding (Option)

The oscilloscope samples the I2S signal, and judges each data point to be logic "1" or logic "0" according to the preset threshold level. I2S decoding is required to specify the serial clock, channel signal, and the data's source channel. You need to set Alignment, WS Low, and other parameters.

In the decode setting menu, press **Decode1** > **Bus Type**, then rotate the multifunction knob  to select "I2S". Press down the knob to select it. You can also press **Bus Type** continuously or enable the touch screen to select it.

1. Enable or Disable the Bus

Press **Bus Status** continuously to enable or disable the decoding function.



2. Quickly Apply I2S Trigger Settings to I2S Decoding

Press **Copy Trig** to copy the current I2S trigger settings and apply them to I2S decoding function (set the corresponding I2S decoding parameters automatically). For analog channels, the threshold level settings will also be copied.







3. Set the Source

Press **Sources** to enter the signal setting menu.

- Set the serial clock channel source, threshold, and clock edge

- Press **SCLK**, rotate the multifunction knob  to select the desired source channel, and then press down the knob it. You can also press **SCLK** continuously or enable the touch screen to select it. You can select CH1-CH4 or D0-D15.
- When you select the analog channel (CH1-CH4), press **SCLK Thre** below **SCLK**, then rotate the multifunction knob  or use the pop-up numeric

keypad to set the SCLK threshold. When you modify the threshold of the clock channel, a dotted line displaying the current threshold level is displayed on the screen. It disappears in about 2 s after you stop modifying the threshold.

- Press **SCLK Edge** continuously to select "Rising()" or "Falling()" as the desired clock edge.
- **Set the WS source and the threshold**
 - Press **WS**, and rotate the multifunction knob  to select the desired channel, and then press down the knob to select it. You can also press **WS** continuously or enable the touch screen to select it. You can select CH1-CH4 or D0-D15.
 - When you select the analog channel (CH1-CH4), press **WS Thre** below **WS**, then rotate the multifunction knob  or use the pop-up numeric keypad to set the threshold of the WS signal. When you modify the WS threshold, a dotted line displaying the current threshold level is displayed on the screen. It disappears in about 2 s after you stop modifying the threshold.
- **Set the data channel source and the threshold**
 - Press **Data**, then rotate the multifunction knob  to select the desired data channel source, and then press down the knob to select it. You can also press **Data** continuously or enable the touch screen to select it. You can select CH1-CH4 or D0-D15.
 - When you select the analog channel (CH1-CH4), press **Data Thre** below **Data**, then rotate the multifunction knob  or use the pop-up numeric keypad to set the threshold of the data signal. When you modify the data threshold, a dotted line displaying the current threshold level is displayed on the screen. It disappears in about 2 s after you stop modifying the threshold.

4. Set the Bus Parameters

Press **Settings** to enter the bus setting menu.

- **Set the word size** Press **Word Size**, then rotate the multifunction knob  or use the pop-up numeric keypad to set the word size.

Its range is from 4 to 32.

- **Set the receiver word size**

Press **Receive**, then rotate the multifunction knob  or use the pop-up numeric keypad to set the receiver word size. Its range is from 4 to 32.

- **Set the alignment mode**

Press **Alignment**, and rotate the multifunction knob  to select the alignment way for data signal. Then press down the knob to select it. You can also press **Alignment** continuously or enable the touch screen to select it. The available alignment ways include I2S, LJ, and RJ.



- **Set the WS Low**

Press **WS Low** continuously to select "Left" or "Right".

- **Set the endian**

Press **Endian** to select "LSB" or "MSB". By default, it is "LSB".

- **Set the polarity**

Press **Data Polarity** continuously to select Positive  or Negative  as the polarity for data decoding.



5. Set Display-related Parameters

Press **Display** to enter the display setting menu.

- **Set the display format**

Press **Format**, rotate the multifunction knob  to select the display format of the bus data. Then, press down the knob to select it. You can also press **Format** continuously or enable the touch screen to select it. The available formats include Hex, Dec, Bin, and ASCII.

- **Adjust the vertical position of the bus**

Press **Position**, and then rotate the multifunction knob  to adjust the vertical display position of the bus. You can also rotate **Wave Vertical**  **POSITION** to adjust the vertical display position of the bus.

- **Set the label display**

Press **Label** to enable or disable the label display of the I2S decoding bus. When enabled, the bus label "I2S" will be displayed at the upper-left side of the bus (when the bus display is enabled).

- Set parameters for the event table

Press **Event Table** to enter the event table setting menu. The event table displays the decoded data and the corresponding decoding information in time order in the form of a table. It can be used to observe relatively longer decoded data. The decoding information includes the decoded left channel data, right channel data, the corresponding line number, and time.

- Open or close the event table: Press **Event Table** continuously to enable or disable the display of the event table. When enabled, the following event table as shown in *Figure 15.14* is displayed. You can also enable the touch screen to tap the icon  at the right-upper corner of the event table to close it.

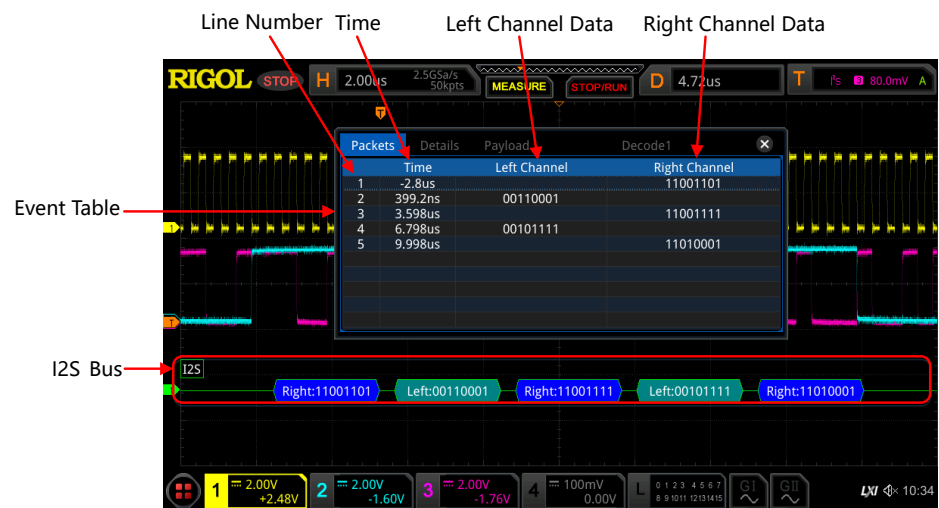



Figure 15.14 I2S Decoding Event Table

NOTE

- When you adjust the horizontal time base, the waveform displayed on the screen will also change, and the total number of lines containing the decoding information in the event table will also be changed.
- The displayed decoded data information in the bus is related to the value of the horizontal time base. Reducing the horizontal time base can help you view the detailed information.
- Set the event table format: Press **Format**, rotate the multifunction knob  to select the display format of the decoded data. Then, press down the knob

to select it. You can also press **Format** continuously or enable the touch screen to select it. The available formats include Hex, Dec, Bin, and ASC.

- Set the view type: Press **View**, rotate the multifunction knob  to select the form of the event table to be viewed. Then, press down the knob to select it. You can also press **View** continuously or enable the touch screen to select it. The available choices include "Packets", "Details", and "Payload". You can also tap "Packets", "Details", or "Payload" at the top of the event table to select it.

If you select "Packets", the decoded data, time, and other information are displayed in the event table. If you select "Details", the detailed data in the specified row will be displayed in the event table. If "..." appears in the row of data, it indicates that the decoded data are not fully displayed. At this time, you can view the details in the "Packets" view. If you select "Payload", all data in the specified column will be displayed in the event table. If "..." appears in the specified column of data, it indicates that the decoded data are not fully displayed. At this time, you can view the details in the "Packets" view.

- Export: If you select "Packets", you can export time and the corresponding decoded data. Press **Export**, then the save setting interface is displayed. You can export the data table of the packet to the internal memory or the external USB storage device (when detected) in CSV format. For detailed saving operation, refer to descriptions in "*Store and Load*".
- Jump to: Set the operating status of the oscilloscope to "STOP". Then, select the data of the specified time from the event table. Press **Jump to** and the specified data waveforms are displayed in the center of the screen.
- Decode: The setting of this menu enables you to quickly view the corresponding event tables of four decode modules (Decode1, Decode2, Decode3, and Decode4). Press **Decode**, then use the multifunction knob  to select a decode module, then press down the knob to select it. You can also press **Decode** continuously or enable the touch screen to select it.

15.9 1553B Decoding (Option)

The oscilloscope samples the 1553B signal, and judges each data point to be logic "1" or logic "0" according to the preset threshold level. 1553B decoding is required to specify the data channel source and the threshold.

In the decode setting menu, press **Decode1** > **Bus Type**, then rotate the multifunction knob  to select "1553B". Press down the knob to select it. You can also press **Bus Type** continuously or enable the touch screen to select it.



1. Enable or Disable the Bus

Press **Bus Status** continuously to enable or disable the decoding function.

2. Quickly Apply 1553B Trigger Settings to 1553B Decoding

Press **Copy Trig** to copy the current 1553B trigger settings and apply them to 1553B decoding function (set the corresponding 1553B decoding parameters automatically).

3. Set the Data Channel Source and the Threshold

- Press **Data**, then rotate the multifunction knob  to select the desired data channel source, and then press down the knob to select it. You can also press **Data** continuously or enable the touch screen to select it. The available channels include CH1-CH4.
- Press **Threshold**, then rotate the multifunction knob  or use the pop-up numeric keypad to set the threshold of the source channel. When you modify the threshold of the channel, a dotted line displaying the current threshold level is displayed on the screen. It disappears in about 2 s after you stop modifying the threshold.



4. Set Display-related Parameters

Press **Display** to enter the display setting menu.

- Set the display format

Press **Format**, rotate the multifunction knob  to select the display format of the bus data. Then, press down the knob to select it. You can also press **Format** continuously or enable the touch screen to select it. The available formats include Hex, Dec, Bin, and ASCII.

- Adjust the vertical position of the bus

Press **Position**, and then rotate the multifunction knob  to adjust the vertical display position of the bus. You can also rotate **Wave Vertical**  **POSITION** to adjust the vertical display position of the bus.

- Set the label display

Press **Label** to enable or disable the label display of the 1553B decoding bus. When enabled, the bus label "1553B" will be displayed at the upper-left side of the bus (when the bus display is enabled).

- Set parameters for the event table

Press **Event Table** to enter the event table setting menu. The event table displays the decoded data and the corresponding decoding information in time order in the form of a table. It can be used to observe relatively longer decoded data. The decoding information includes the decoded data, word type, the corresponding line number, time, and error information.

- Open or close the event table: Press **Event Table** continuously to enable or disable the display of the event table. When enabled, the following event table as shown in *Figure 15.15* is displayed. You can also enable the touch screen to tap the icon  at the right-upper corner of the event table to close it.

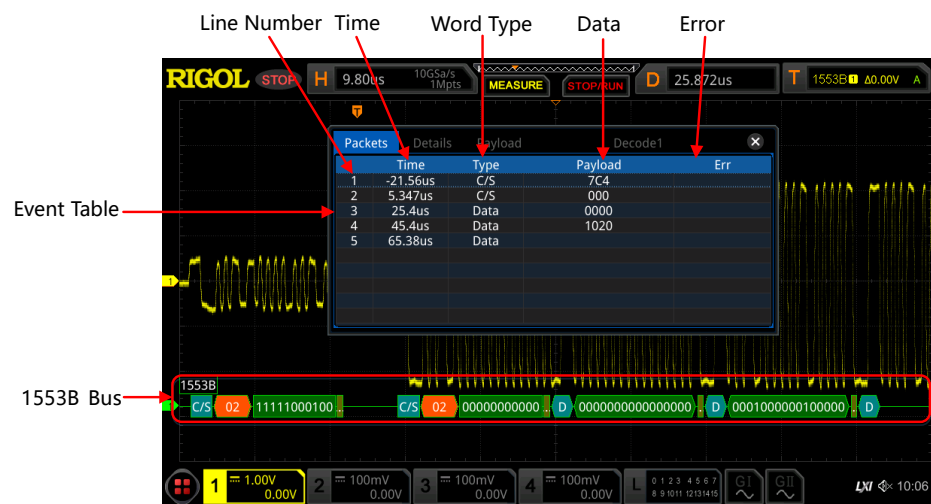





Figure 15.15 1553B Decoding Event Table

NOTE

- When you adjust the horizontal time base, the waveform displayed on the screen will also change, and the total number of lines containing the decoding information in the event table will also be changed.

- The displayed decoded data information in the bus is related to the value of the horizontal time base. Reducing the horizontal time base can help you view the detailed information.
- Set the event table format: Press **Format**, rotate the multifunction knob  to select the display format of the decoded data. Then, press down the knob to select it. You can also press **Format** continuously or enable the touch screen to select it. The available formats include Hex, Dec, Bin, and ASC.
- Set the view type: Press **View**, rotate the multifunction knob  to select the form of the event table to be viewed. Then, press down the knob to select it. You can also press **View** continuously or enable the touch screen to select it. The available choices include "Packets", "Details", and "Payload". You can also tap "Packets", "Details", or "Payload" at the top of the event table to select it.

If you select "Packets", the decoded data, time, and other information are displayed in the event table. If you select "Details", the detailed data in the specified row will be displayed in the event table. If "..." appears in the row of data, it indicates that the decoded data are not fully displayed. At this time, you can view the details in the "Packets" view. If you select "Payload", all data in the specified column will be displayed in the event table. If "..." appears in the specified column of data, it indicates that the decoded data are not fully displayed. At this time, you can view the details in the "Packets" view.

- Export: If you select "Packets", you can export time and the corresponding decoded data. Press **Export**, then the save setting interface is displayed. You can export the data table of the packet to the internal memory or the external USB storage device (when detected) in CSV format. For detailed saving operation, refer to descriptions in "*Store and Load*".
- Jump to: Set the operating status of the oscilloscope to "STOP". Then, select the data of the specified time from the event table. Press **Jump to** and the specified data waveforms are displayed in the center of the screen.
- Decode: The setting of this menu enables you to quickly view the corresponding event tables of four decode modules (Decode1, Decode2, Decode3, and Decode4). Press **Decode**, then use the multifunction knob 

to select a decode module, then press down the knob to select it. You can also press **Decode** continuously or enable the touch screen to select it.

5. Interpret the Decoded 1553B Data

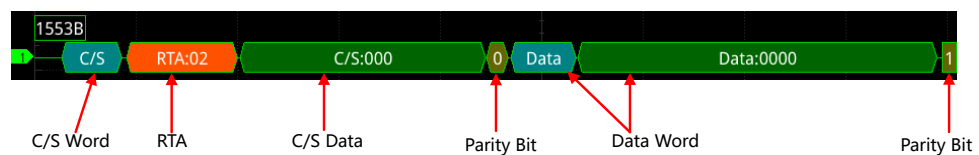

- C/S: command/status word. It is displayed as a blue-green patch.
- RTA: remote terminal address of the command/status word. It is displayed as a tangerine patch.
- C/S data: the rest data value of the command/status word. Its display format is the same as that of the bus data (Hex, Dec, Bin, or ASCII), displayed as a green patch.
- Parity bit: displayed as a yellow-green patch; when errors occur, displayed as a red patch.
- Data word data: data of the data word. Its display format is the same as that of the bus data (Hex, Dec, Bin, or ASCII), displayed as a green patch.



16 Reference Waveform

This series oscilloscope provides 10 reference waveform positions (Ref1-Ref10). In the actual test process, you can compare the signal waveform with the reference waveform to locate the failure.

16.1 To Enable the Ref Function

Press  on the front panel to enable the reference waveform function, or enable the touch screen and then tap the function navigation icon  at the lower-left corner of the screen to open the function navigation. Then, tap the "Ref" icon to enable the reference waveform function.

When the Ref function is enabled, you can select different color for each reference waveform, set the source of each reference channel, adjust the vertical scale and offset of the reference waveform, save the reference waveform to the internal or external memory, and recall it when needed.

NOTE

When the horizontal time base is set to "XY", the reference waveform function is disabled.

16.2 To Select the Reference Channel

Press **Current**, rotate the multifunction knob  to select the reference waveform channel (Ref1-Ref10). You can also press **Current** continuously or enable the touch screen to select the reference waveform channel. By default, Ref1 is enabled.

16.3 To Select the Ref Source





Press **Source**, rotate the multifunction knob  to select the desired reference waveform source (CH1-CH4, D0-D15, or Math1-Math4). You can also press **Source** continuously or enable the touch screen to select the reference waveform source.

NOTE

Only the currently enabled channel can be selected as the source channel of the reference waveform.

16.4 To Adjust the Ref Waveform Display

After pressing **SaveToRef**, you can adjust the vertical scale and offset of the reference waveform specified under **Current**.

Press **VScale**, then rotate the multifunction knob  or use the pop-up numeric keypad to set the vertical scale of the reference waveform. Press **VOffset**, then rotate the multifunction knob  or use the pop-up numeric keypad to set the vertical offset of the reference waveform. In the Ref function, You can also directly rotate **Wave Vertical**  **SCALE** and **Wave Vertical**  **POSITION** respectively to modify the vertical scale and the vertical offset.

16.5 To Save to Internal Memory

Press **SaveToRef** to save the displayed waveform for the specified source to the internal memory as the reference waveform.

NOTE

This operation only saves the reference waveform to the volatile memory, and the waveform will be cleared at power-off or restoring to the default settings.

16.6 To Clear the Display of the Reference Waveform

Press **Clear** to clear the display of the current reference waveform on the screen. Meanwhile, the **VScale** and **VOffset** menus for the reference waveform are grayed

out and disabled. You can also press  on the front panel to clear the display of the reference waveforms of all the reference channels.

NOTE

This operation only clears the display of the reference waveform on the screen, and the reference waveform is still saved in the memory.

16.7 To View Details of the Reference Waveform

Press **More** > **Details**, and the detailed information about all the reference waveforms will be displayed on the screen in the form of a list. Press **Details** again to close the details list. You can also enable the touch screen to tap the icon  at the right-upper corner of the table to close it.

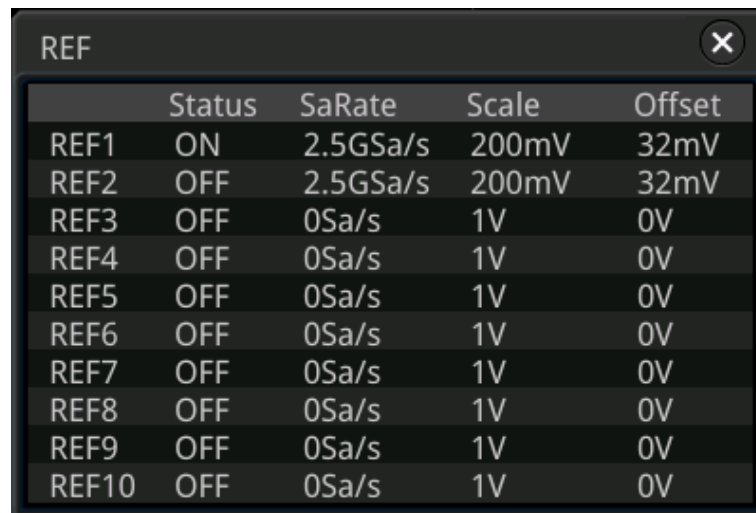



	Status	SaRate	Scale	Offset
REF1	ON	2.5GSa/s	200mV	32mV
REF2	OFF	2.5GSa/s	200mV	32mV
REF3	OFF	0Sa/s	1V	0V
REF4	OFF	0Sa/s	1V	0V
REF5	OFF	0Sa/s	1V	0V
REF6	OFF	0Sa/s	1V	0V
REF7	OFF	0Sa/s	1V	0V
REF8	OFF	0Sa/s	1V	0V
REF9	OFF	0Sa/s	1V	0V
REF10	OFF	0Sa/s	1V	0V

16.8 To Reset the Reference Waveform

Press **More** > **Reset**, and the reference waveform returns to the position where the source channel waveform is located when the Save operation was executed.

16.9 To Set the Color of the Reference Waveform

This series oscilloscope provides five colors (gray, green, blue, red, and orange) to mark the reference waveforms of different channels in order to distinguish them.

Press **Color**, and then rotate the multifunction knob  to select the color of the reference waveform of the channel. You can also press **Color** continuously or enable the touch screen to select it. The GND icon and the label at the left side of the waveform of the currently selected channel will be filled with the specified color. For example,  and .

16.10 To Set the Label

Press **More** > **Label** to enter the label setting menu. You can use the built-in label in the library or manually input a label. Three input methods are available for you to input a label name, including Chinese, English, and Traditional Chinese.

- Press **Display** continuously to enable or disable the display of the reference waveform label. If it is enabled, the label will be displayed at the left side of the waveform. If the current channel is REF n ($n=1,2, \dots,10$), then the default label of the reference waveform is REF n ($n=1, 2, \dots,10$).

- Press **Library**, and rotate the multifunction knob  to select the preset label, and then press down the knob to select it. You can also press **Library** continuously or enable the touch screen to select it. The available preset labels include Default, ACK, ADDR, BIT, CLK, and etc.
- Press **Label**, and the label editing interface is automatically displayed. You can input the label manually. For the label editing methods, refer to descriptions in "*Channel Label*".

16.11 To Export to Internal or External Memory

You can save the current reference waveform to the internal memory or external USB storage device. The file format of the reference waveform is "*.ref", "*.bin", or "*.csv".

Press **More** > **Export** to enter the reference waveform file saving interface. Please refer to descriptions in "*Store and Load*" to save the reference waveform to the internal or external memory. Only when the reference waveform is saved, can this export function be valid.



NOTE

This series oscilloscope only supports the flash memory USB storage device of FAT32 format. For the "*.bin" format file, refer to "*Binary Data Format (.bin)*".

16.12 To Import from Internal or External Memory

You can import the stored reference waveform file from the internal memory or external USB storage device to the internal instrument and display the file on the screen.

Press **More** > **Import** to enter the reference waveform file loading interface. Please refer to descriptions in "*Store and Load*" to import the reference waveform to the instrument and display it on the screen.





NOTE

This series oscilloscope only supports the flash memory USB storage device of FAT32 format.

17 Pass/Fail Test

During the product design and manufacturing process, you usually need to monitor the variations of the signal or judge whether the product is up to standard. The pass/fail test function of this series oscilloscope can accomplish this task perfectly.

17.1 To Enable or Disable the Pass/Fail Test Function

On the front panel, press  > **PassFail** to open the pass/fail test setting menu, or enable the touch screen and then tap the function navigation icon  at the lower-left corner of the screen to open the function navigation. Then, tap the "Pass/Fail" icon to open the pass/fail test setting menu.

In the "Pass/Fail" setting menu, press **Enable** continuously to enable or disable the pass/fail test function.

NOTE

The pass/fail test function cannot be enabled in the following conditions: when the time base mode is "XY" or "ROLL"; when the delay sweep is enabled.

17.2 To Start or Stop the Pass/Fail Test Operation

After the Pass/Fail test function is enabled, press **Operate** continuously to start or stop the test operation.

During the test process, the oscilloscope will test the waveforms, display the test information, and output the test information based on the current of settings. You can set the test mask, the display status of the test information, and the output form of a pass/ failed test based on the selected source channel for the test. Then save the test mask range to the internal or external memory, and then recall it when needed. For the details, please refer to the following section.

NOTE

- Only when the pass/fail test function is enabled, can you start or stop the pass/fail test operation, enable or disable the display of the test information, save and recall the test mask range.
- After starting the test operation, you can neither modify the source channel nor adjust the test mask.

17.3 To Select the Source

Before selecting the source, connect the signal under test to the analog channel input terminal of the oscilloscope. Press **Source**, and rotate the multifunction knob  to

select the desired source channel, and then press down the knob it. You can also press **Source** continuously or enable the touch screen Select to select it. The available output channels include CH1-CH4.





NOTE

Only the channels that have been enabled currently can be selected.

17.4 To Create a Mask

Press **Mask** > **Create** to self-define the mask of the pass/fail test. Press **Range**, then rotate the multifunction knob  to select the range and then press down the knob to select the range. You can also press **Range** continuously or enable the touch screen to select it. You can select "Screen" or "Cursor" as the mask region. The default is "Screen".

- If "Screen" is selected under Range, then the whole waveform display area is considered to be the mask region. Press **X Mask** and **Y Mask** respectively, then rotate the multifunction knob  or use with the pop-up numeric keypad to set the horizontal tolerance range and vertical tolerance range. During the adjustment, you can see the outline of the current mask. Then press **Create** to apply the currently created mask (the region not covered by blue within the screen).
- If "Cursor" is selected, two cursors (used to specify the current test mask range) will be displayed on the screen. Cursor A is at the left and Cursor B is at the right. Press **CursorA** and **CursorB**, and rotate the multifunction knob  to adjust the positions of both Cursor A and Cursor B, respectively. Also you can press **CursorAB** and rotate the multifunction knob  to adjust the two cursors synchronously (the horizontal spacing between Cursor A and Cursor B remains unchanged). Then refer to the above methods to adjust the horizontal and vertical tolerance ranges, as well as create a mask (the region not covered by blue within the cursor region).

17.5 To Save a Mask

When the pass/fail test function is enabled, you can save the current test mask range to the internal memory or external USB storage device (when detected) in "*.pf" format.

Press **Mask** > **Save** to enter the file saving interface. Please refer to descriptions in "*Store and Load*" to save the test mask file to the internal or external memory.

17.6 To Load a Mask

When the pass/fail test function is enabled, you can load the test mask files from the internal memory or external USB storage device (when detected) and apply them to the current pass/fail test function.

Press **Mask** > **Load** to enter the file loading interface. Please refer to descriptions in *Store and Load* to load the specified test mask files (in *.pf format) and apply them to the current pass/fail test function.

17.7 To Set the Output Form of the Test Results

In the **Option** menu, you can set what the oscilloscope will execute when test results are detected according to your needs.

- **Set the output event and Aux output**

- Press **Output Event**, then rotate the multifunction knob  to select "Fail" or "Pass". Press down the knob to select it. You can also press **Output Event** continuously or enable the touch screen to select it.



- Press **Aux Output** continuously to enable or disable the Aux output. If **Aux Output** is enabled, press  > **System**, the **AUX Out** menu is automatically set to "PassFail". When a successful or failed event test is detected, a pulse will be output from the rear-panel **[TRIG OUT]** connector.

If **Aux Output** is disabled, press  > **System**, the **AUX Out** menu is automatically set to "TrigOut", and the output of the rear-panel **[TRIG OUT]** connector is irrelevant with the pass/fail test.

- **Set the Output Polarity and Output Pulse Width**

Press **Polarity** continuously to select "Positive" or "Negative", then press **Pulse**, rotate the multifunction knob  or use the numeric keypad to set the pulse width. Its range is from 100 ns to 10 ms. By default, it is 1 μ s.

- **Set the Error Action**

Press **Err Action**, and rotate the multifunction knob  to set the operation that the oscilloscope will execute once a failed test is detected. Press down the knob to select it. You can also press **Err Action** continuously and press down the multifunction knob  to select it. Also, you can enable the touch screen to select it.

- **Stop:** indicates stopping test when a pass/fail test event is found.
- **Beeper:** indicates that the beeper sounds an alarm when a pass/fail test event is found (irrelevant with the on/off status of the beeper).
- **Screenshot:** performs the screenshot operation when a pass/fail test event is found. If an external storage device is detected, the screenshot will be saved to the external storage device directly. Otherwise, it will be saved to the local disk.

NOTE

If "Screenshot" is selected, "Stop" action will be executed forcibly. The test will be stopped automatically. After the Screenshot operation is completed, the test will continue.

17.8 To Enable or Disable the Display of the Statistics of the Test Results

Press **Information** continuously to enable or disable the display of the statistics of the test results. You can also enable the touch screen to tap the icon  at the right-upper corner of the statistics window to close it.

The test results statistics include the number of failed frames, the number of successful frames, and total number of frames, as shown in the figure below.



17.9 To Reset Statistics

Press **Reset** to clear the current test results and execute statistics on the test results again.

18 Waveform Recording and Playing



Waveform recording/playing function can play the recorded waveforms of the analog input channels (CH1-CH4) and the digital channels (D0-D15), enabling you to analyze the waveforms better.







NOTE

The horizontal time base must be set to YT mode during waveform recording.

18.1 Common Settings

Press  > **Record** to enter the waveform recording setting menu. You can also enable the touch screen and then tap the function navigation icon  at the lower-left corner of the screen to open the function navigation. Then, tap the "Record" icon to open the waveform recording setting menu.

1. Record

Press **Record** continuously to enable or disable the waveform recording function. Before recording the waveform, you can refer to descriptions in "*Record Options*" to set the waveform recording parameters. Press **Record** to start recording the waveforms. Then the record icon turns  from . During the recording, the current real-time recording information is displayed on the screen, as shown in *Figure 18.1*. In the figure, the data at the left side of the slash is the current frame. Its value changes constantly (the value under the **Current** menu is changing constantly too). The data at the right of the slash indicate the number of frames for recording. The time difference ΔT at the upper-right corner indicates the time different between the current frame and the first frame. After the recording is completed, the recording marker "" turns out to be "" and recording stops automatically. During recording, you can also press **Record** again to suspend recording manually.

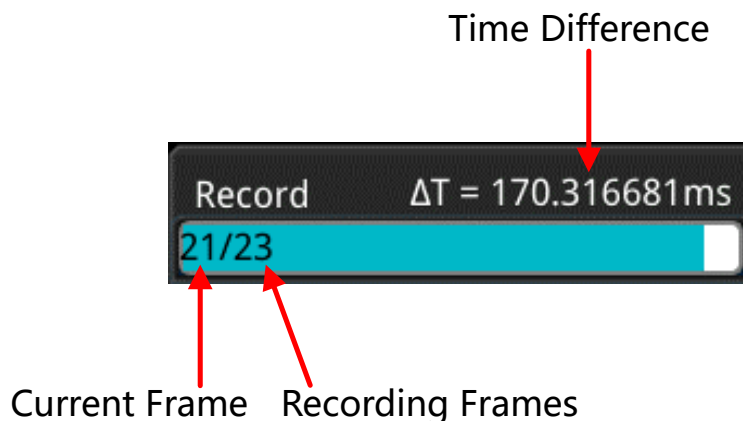



Figure 18.1 Recording Process



2. Play

Press **Playing** to start playing the recorded waveforms. "▶" automatically turns out to be "⏏". For details about playing, refer to descriptions in "*Play Options*". During waveform playing, the current frame changes accordingly (the value of the parameter **Current** changes accordingly). After playing is completed, "⏏" automatically turns out to be "▶" automatically. During playing, you can also press **Playing** again to suspend playing manually.

3. Current Frame

Press **Current**, then rotate the multifunction knob  or use the pop-up numeric keypad to set the current frame. At this time, the waveform of the current frame is displayed on the screen.

4. Set Transition

Press **Jump To** continuously to select to jump to the recorded end frame ( Last) or the recorded start frame ( First). For settings of the start and end frames, refer to descriptions in "*Play Options*".

18.2 Record Options

During the waveform recording, the oscilloscope records the waveforms of the currently enabled channel at a specified interval until you manually stops the recording operation or the number of recorded frames has reached the set value.

NOTE

Before starting the recording operation, turn on the desired channel and adjust the waveform display to the desired state. When starting the recording operation, you can neither enable/disable the channel output nor adjust the waveform display.



Before recording the waveforms, you can press **More** > **Setting** to select "Record" to set the following parameters.

1. Interval

The recording interval indicates the time interval between the frames during the recording process.

Press **Interval**, then rotate the multifunction knob  or use the pop-up numeric keypad to set the time interval between frames. The available range is from 10 ns to 10 s.

2. Frames

The recording frames refer to the number of frames that can be recorded actually. After starting the recording operation, the oscilloscope stops the recording operation automatically when the number of recorded frames reaches the set value.



Press **Frames**, then rotate the multifunction knob  or use the numeric keypad to set the number of recorded frames. The available range is from 1 to the maximum number of frames that can be recorded currently (available in the **Max Frames** menu). Press **Set to Max** to set the number of recorded waveform frames to the maximum number of frames automatically.

3. Max Frames

The menu shows the maximum number of frames that can be recorded currently. As the capacity of the waveform memory is fixed, the more the number of points each frame of waveform has, the less the number of waveform frames that can be recorded. Therefore, the maximum number of recorded frames is related to the currently selected "memory depth" (refer to "*Memory Depth*"). The current memory depth refers to the number of waveform points per frame. $\text{Memory Depth} = \text{Sample Rate} \times \text{Horizontal Time Base} \times \text{Number of Grids in the Horizontal Direction}$. Therefore, the maximum number of frames of waveform recording is also related to the "Sample Rate" and "Horizontal Time Base". This oscilloscope supports up to 450,000 frames of real-time and ceaseless waveforms recording.

4. Beeper

Press **Beeper** continuously to set whether the beeper sounds when the recording is completed.



- On : the beeper sounds at the end of recording.
- Off : the beeper does not sound at the end of recording.

18.3 Play Options



Waveform playing function can play back the waveforms currently recorded. Before playing back the waveforms, you can press **More** > **Setting** to select "Play" to set the following parameters.



1. Play Mode

Press **Mode** continuously to set the playback mode to cycle  or single .

- : plays from the start frame to the end frame, then such playback operation is repeated until you stop it manually.
- : plays from the start frame to the end frame, and then stops automatically.

2. Playback Sequence

Press **Sequence** continuously to select the playback sequence to  (playback clockwise) or  (playback counterclockwise).

- : plays from the start frame to the end frame.
- : plays from the end frame to the start frame.

3. Interval

The playback interval indicates the time interval between the frames during the playing process.

Press **Interval**, then rotate the multifunction knob  or use the pop-up numeric keypad to set the time interval between frames. The available range is from 5 ms to 10 s.

4. Start Frame

Press **Start Frame**, then rotate the multifunction knob  or use the numeric keypad to set the start frame for playing back the waveforms. The default is 1, and the maximum value is the maximum number of recorded frames.



5. End Frame

Press **End Frame**, and then rotate the multifunction knob  or use the pop-up numeric keypad to set the end frame of playback. The default is the number of frames of the recorded waveforms.

19 Search and Navigation Function

The search function allows you to search for relevant events based on the search condition that you set. The navigation function includes the recording&playing navigation, time navigation, and event navigation.

19.1 Search Function



The search function enables you to search the Edge trigger, Pulse trigger, Runt trigger, Slope trigger, RS232 trigger, I2C trigger, or SPI trigger. Press  on the front panel to enable the search setting menu. You can also enable the touch screen and then tap the function navigation icon  at the lower-left corner of the screen to open the function navigation. Then, tap the "Search" icon to open the search setting menu.





1. Enable or Disable the Search Function

Press **Search** continuously to enable or disable the search function.

2. Select the Search Type and Set the Parameters

Press **Type**, and rotate the multifunction knob  to select the desired type (Edge, Pulse, Runt, Slope, RS232, I2C, or Slope). You can also press **Type** continuously or enable the touch screen to select it.

- **Edge search:** sets the search type to "Edge". For **Edge Setup** menu settings, refer to descriptions in "*Edge Trigger*". Press **Threshold** to enter the threshold setting menu. Rotate the multifunction knob  or use the pop-up numeric keypad to set the threshold.
- **Pulse trigger search:** sets the search type to "Pulse". For **Pulse Setup** menu settings, refer to descriptions in "*Pulse Trigger*". Press **Threshold** to enter the threshold setting menu. Rotate the multifunction knob  or use the pop-up numeric keypad to set the threshold.
- **Runt search:** sets the search type to "Runt". For **Runt Setup** menu settings, refer to descriptions in "*Runt Trigger*". Press **Threshold** to enter the threshold setting menu. Rotate the multifunction knob  or use the pop-up numeric keypad to set Threshold A and Threshold B.

- **Slope trigger search:** sets the search type to "Slope". For **Slope Setup** menu settings, refer to descriptions in "*Slope Trigger*". Press **Threshold** to enter the threshold setting menu. Rotate the multifunction knob  or use the pop-up numeric keypad to set Threshold A and Threshold B.
- **RS232 trigger search:** sets the search type to "RS232". For **RS232 Setup** menu settings, refer to descriptions in "*RS232 Trigger (Option)*". Press **Threshold** to enter the threshold setting menu. Rotate the multifunction knob  or use the pop-up numeric keypad to set the threshold.
- **I2C trigger search:** sets the search type to "I2C". For **I2C Setup** menu settings, refer to descriptions in "*I2C Trigger (Option)*". Press **Threshold** to enter the threshold setting menu. Rotate the multifunction knob  or use the pop-up numeric keypad to set the SCL and SDA thresholds.
- **SPI trigger search:** sets the search type to "SPI". For **SPI Setup** menu settings, refer to descriptions in "*SPI Trigger (Option)*". Press **Threshold** to enter the threshold setting menu. Rotate the multifunction knob  or use the pop-up numeric keypad to set the CLK, MISO, and CS thresholds.

3. Copy Trigger

- **Copy to Trigger**

Press **More** > **To Trigger** to copy the selected search type settings to the same trigger type. For example, if the current search type is "Edge", press **To Trigger** to copy the edge search settings to the "*Edge Trigger*" settings.

- **Copy from Trigger**

Press **More** > **From Trigger** to copy the trigger settings of the selected search type to the search settings. For example, if the current search type is "*Edge Trigger*", press **From Trigger** to copy the Edge trigger settings to the "Edge" search settings.

NOTE

If you select "From Trigger", you need to set the search type first, and then copy the trigger type settings from the trigger menu.

4. Open or Close the Mark Table

Press **MarkTable** continuously to enable or disable the display of the mark table. The mark table is shown as below. You can also enable the touch screen to tap the icon  at the right-upper corner of the table to close it.

Total count : 0 		
Num	Time	Count
001	-9.25001ms	(1)
002	-8.25002ms	(1)
003	-7.25002ms	(1)
004	-6.25002ms	(1)
005	-5.25002ms	(1)
006	-4.25002ms	(1)
007	-3.25002ms	(1)
008	-2.24998ms	(1)
009	-1.24998ms	(1)
010	-249.980us	(1)

5. Navigation

Press **Navigation**, then rotate the multifunction knob  or use the pop-up numeric keypad to set the event No. to navigate the event. You can also use the navigation combination keys to make navigations at a step of 1. For details, refer to descriptions in "*Navigation Function*".

6. Save

You can save the event mark data to the internal memory or external USB storage device in "*.csv" format.

Press **More** > **Save events** to enter the file saving interface. Please refer to descriptions in "*Store and Load*" to save the event mark data to the internal or external memory.



NOTE



This series oscilloscope only supports the flash memory USB storage device of FAT32 format.

19.2 Navigation Function





The navigation function includes the recording&playing navigation, time navigation, and event navigation. In the horizontal control area (Horizontal) on the front panel, the navigation combination keys are shown as follow:



- **Recoding&Playing Navigation**

When you enable the waveform recording function and complete the waveform recording operation, press the navigation combination keys to play the recorded waveforms. Press  to play the recorded waveforms in reverse order; press  to play the recorded waveforms in normal order; press  to stop playing.



- **Time Navigation**

After the data acquisition stops, use the navigation combination keys to play the captured data waveforms in a fast and continuous way. Press  to play the previous recorded waveforms; press  to play the next recorded waveforms; press  to stop playing. Besides, press  or  repeatedly can accelerate the playing of the waveforms, so that you can quickly locate the acquired data waveforms.

NOTE

The time navigation function is only available when the time base mode is "YT" and the instrument stays in "STOP" status.

- **Event Navigation**

When you enable the navigation function and complete the event search, you can use the navigation combination keys to quickly navigate the specific event in the event mark table. Press  to navigate to the previous event (the serial number in the mark table decreases); press  to navigate to the next event (the serial number in the mark table increases); the  key is disabled in the event navigation.

20 Display Control

In the "display" setting menu, you can set the parameters such as the waveform display type, persistence time, intensity, grid type, grid brightness, and etc.

20.1 To Select the Display Type

Press  to enter the display control setting menu. Press **Type** continuously to set the waveform display mode to "Vector" or "Dots".

- **Vector:** the sample points are connected by lines and displayed. In most cases, this mode can provide the most vivid waveform for you to view the steep edge of the waveform (such as square waveform).
- **Dots:** the sample points are displayed directly. You can directly view each sample point and use the cursor to measure the X Value and Y values of the sample point.

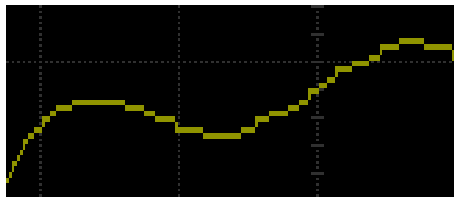

Vector Display

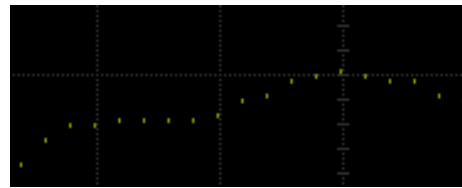

Dots Display

20.2 To Set the Persistence Time

Press **Persis.Time**, and rotate the multifunction knob  to set the persistence time for the oscilloscope and then press down the knob to select it. You can also press **Persis.Time** continuously or enable the touch screen to select it. The available values are Min, specific values (i.g. 100 ms, 200 ms, 500 ms, 1 s, 2 s, 5 s, 10 s), and Infinite.

In the following part, a frequency sweep signal of the sine waveform is used to show the waveform effects in different persistence times.

1. Min

Enables you to view waveform changing in high refresh rate.



2. Specific Values

Enables to view glitches that change relatively slowly or glitches with lower occurrence probability. The persistence time can be set to 100 ms, 200 ms, 500 ms, 1 s, 2 s, 5 s, or 10 s.

3. Infinite

In this mode, the oscilloscope displays the waveform newly acquired without clearing the waveforms acquired formerly. The waveforms acquired formerly will be displayed in relatively low-brightness color and the newly acquired waveforms will be displayed in normal brightness and color. Infinite persistence can be used to measure noise and jitter and to capture incidental events.

20.3 To Set the Waveform Intensity

Press **Intensity**, then rotate the multifunction knob  at a small step value or use the pop-up numeric keypad to set the waveform intensity. Note that in the non-menu operation mode, you can also rotate the multifunction knob  to adjust the waveform intensity of the channel. The default is 50%, and the range available is from 1% to 100%.

20.4 To Set the Screen Grid

Press **Grid**, and rotate the multifunction knob  to set the grid type and then press down the knob to select it. You can also press **Grid** continuously or enable the touch screen to select it. You can select FULL, HALF, NONE, or IRE.

- FULL: turns the background grid and coordinate on.
- HALF: turns the background grid off.
- NONE: turns the background grid and coordinate off.
- IRE: only available for testing the video signal (i.g. the trigger type is set to "Video" trigger, and the vertical scale is set to 140 mV).

When "IRE" is selected, the screen displays the vertical graticule in IRE and marks it at the left side of the screen. Its range is from -40 IRE to +100 IRE. Meanwhile, 0.35 V and 0.7 V levels are displayed at the right side of the screen, as shown in the following figure.



20.5 To Set the Grid Brightness

Press **Brightness**, then rotate the multifunction knob  at a small step value or the pop-up numeric keypad to set the grid brightness. The default is 20%, and the range available is from 1% to 100%.

20.6 Show Scale

Press **Show Scale** continuously to enable or disable the scale display on the screen. By default, it is OFF.

NOTE

When the digital channel is enabled, the scale in the vertical direction is hidden automatically.

20.7 Color Grade

Press **More** > **Color Grade** to enable or disable the color grade display of the waveforms on the screen. By default, it is OFF. When enabled, different colors are displayed on the screen to indicate the times of data acquisition or acquisition probability.

20.8 Waveform Freeze

Press **More** > **Waveform Freeze** to enable or disable waveform freeze function. When enabled, the oscilloscope displays the waveform after multiple sampling and

superposition when sampling is stopped by pressing the front-panel  key. If disabled, the last triggered waveform is displayed.

21 Function/Arbitrary Waveform Generator (Option)

With an optional configuration of built-in dual-channel, 25 MHz Function/Arbitrary Waveform Generator, this series integrates the Function/Arbitrary Waveform Generator and the oscilloscope into one, thus providing great convenience for engineers who need to use the Function/Arbitrary Waveform Generator and oscilloscope at the same time. This chapter introduces how to use the built-in Function/Arbitrary Waveform Generator option. As the functions and setting methods of the two channels of the Function/Arbitrary Waveform Generator are the same, this chapter takes GI as an example to illustrate.



21.1 To Output Basic Waveforms

Press  on the front panel or enable the touch screen to tap the GI label at the bottom of the screen to enable/disable the output of the **[GI]** connector on the front panel. Then the Function/Arbitrary Waveform Generator setting menu is displayed. The built-in Function/Arbitrary Waveform Generator can output a variety of basic waveforms, including Sine, Square, Ramp, Pulse, DC, Noise, Sinc, Exp.Rise, Exp.Fall, ECG, Gauss, Lorentz, Haversine, and Arb.

21.1.1 To Output Sine

Press **Wave**, then use the multifunction knob  to select "Sine" and then press down the knob to select the waveform. You can also press **Wave** continuously or enable the touch screen to select it. At this time, you can set the parameters for the Sine waveform.

- **Set the Frequency or Period**

First press **Frequency** or **Period**, rotate the multifunction knob  to select "Frequency" or "Period". You can also press **Frequency** or **Period** continuously or enable the touch screen to select it. Rotate the multifunction knob  or use the pop-up numeric keypad to set the frequency or period of the current signal. Different waveforms have different frequency or period (reciprocal of the frequency) ranges.

Sine: 100 mHz to 25 MHz



Square: 100 mHz to 15 MHz

Ramp: 100 mHz to 100 kHz



Pulse: 100 mHz to 1 MHz

DC and Noise: no frequency parameter

- **Set the Amplitude or High Level**

First press **Amplitude** or **High Level**, then rotate the multifunction knob  to select "Amplitude" or "High Level". You can also press **Amplitude** or **High Level** continuously to select it. Enable the touch screen to select it. Rotate the multifunction knob  or use the pop-up numeric keypad to set the amplitude or high level of the current signal. Note that if you select "Amplitude" for this menu, then the menu below Amplitude is automatically turns out to be "Offset"; if you select "High Level" for this menu, then the menu below High Level is automatically turns out to be "Low Level". When the impedance is set to HighZ, its range is from 20 mVpp to 5 Vpp; when the impedance is set to 50 Ω, its range is from 10 mVpp to 2.5 Vpp.

- **Set the Offset or Low Level**

First press **Offset** or **Low Level**, then rotate the multifunction knob  to select "Offset" or "Low Level". You can also press **Offset** or **Low Level** continuously to select it. Enable the touch screen to select it. Rotate the multifunction knob  or use the pop-up numeric keypad to set the offset or low level of the current signal. When the impedance is HighZ, its range is from (-2.5 V + the current amplitude/2) to (2.5 V - the current amplitude/2); when the impedance is set to 50 Ω, its range is from (-1.25 V + the current amplitude/2) to 1.25 V - the current amplitude/2).

- **Set the Start Phase**

Press **Start Phase**, then rotate the multifunction knob  or use the numeric keypad to set the start phase of the current signal. Its available range is from 0° to 360°.

- **Align Phase**

Pressing **Align Phase** will re-configure the two channels to output according to the preset frequency and phase. For two signals whose frequencies are the same or in multiple relationship, this operation can align their phases. Use the oscilloscope to acquire the waveforms of the two channels and stably display the waveforms. After switching the channel status, the phase deviation between the two waveforms is changed. At this time, press **Align Phase**, then the phase deviation shown on the oscilloscope will restore to the current phase deviation between the two waveforms automatically.

- **Set Other Parameters**

Press **Settings** to enter the other parameter setting menu. You can set the parameters such as modulation, sweep, burst, and impedance.

- **Modulation, sweep, and burst**

For details about modulation, sweep, and burst, refer to descriptions in "*Modulation*", "*Sweep*", and "*Burst*".

NOTE

When "Pulse", "DC", or "Noise" is selected under **Wave**, this menu is not available.

- Set the impedance

Press **Impedance** continuously to set the output impedance of the Function/Arbitrary Waveform Generator. It can be set to "HighZ" or "50Ω".

21.1.2 To Output Square

Press **Wave**, then use the multifunction knob  to select "Square" and then press down the knob to select the waveform. You can also press **Wave** continuously or enable the touch screen to select it. At this time, you can set the parameters for the Square waveform. For setting methods, refer to descriptions in "*To Output Sine*". The duty cycle of the square waveform is a fixed value 50%.

21.1.3 To Output Ramp

Press **Wave**, then use the multifunction knob  to select "Ramp", and then press down the knob to select the waveform. You can also press **Wave** continuously or enable the touch screen to select it. At this time, you can set the parameters for the ramp waveform. For setting methods, refer to descriptions in "*To Output Sine*". This section only introduces "Symmetry".

Symmetry is defined as the percentage that the rising period of ramp takes up in the whole period (as shown in the figure below).

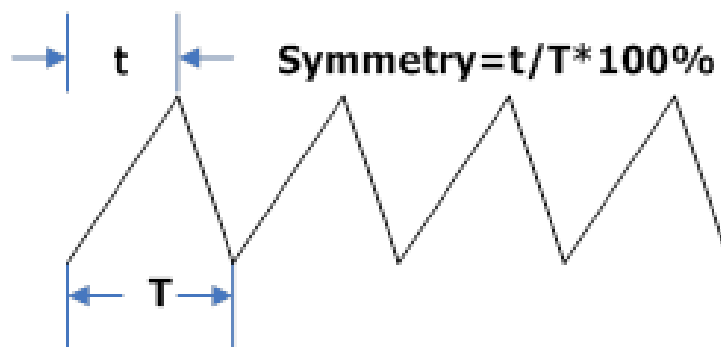



Figure 21.1 Symmetry Definition

Press **Settings** > **Symmetry**, then rotate the multifunction knob  or use the pop-up numeric keypad to set the symmetry of the ramp waveform. The settable range is from 1% to 100%.

21.1.4 To Output Pulse

Press **Wave**, then use the multifunction knob  to select "Pulse" and then press down the knob to select the waveform. You can also press **Wave** continuously or enable the touch screen to select it. At this time, you can set the parameters for the Pulse. For setting methods, refer to descriptions in "*To Output Sine*". This section only introduces "Duty Cycle".

Duty Cycle is defined as the percentage that the high level takes up in the whole pulse period.

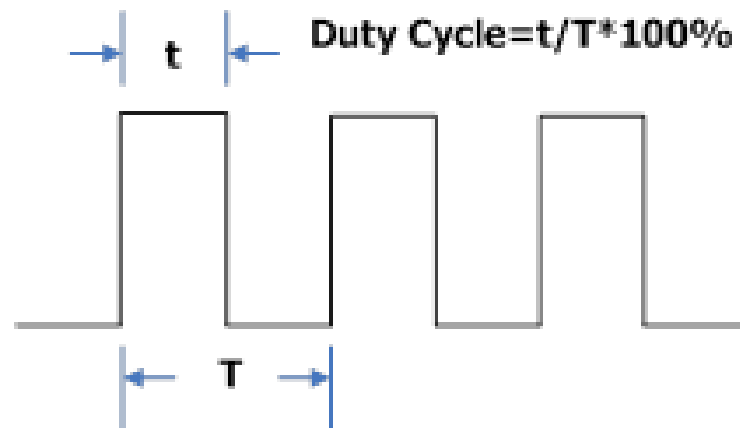





Figure 21.2 Duty Cycle Definition

Press **Settings** > **Duty Cycle**, then rotate the multifunction knob  or use the pop-up numeric keypad to set the duty cycle of the current signal. Its settable range is from 10% to 90%.

21.1.5 To Output DC

Press **Wave**, then use the multifunction knob  to select "DC" and then press down the knob to select the waveform. You can also press **Wave** continuously or enable the touch screen to select it. At this time, you can set the offset and impedance of the DC signal.

- **Set the Offset**

Press **Offset**, then rotate the multifunction knob  or use the pop-up numeric keypad to set the offset of the current signal. When the current impedance is set to HighZ, the settable range is from -2.5 V to +2.5 V; when the impedance is set to 50 Ω, the settable range is from -1.25 V to +1.25 V.



- **Set the impedance**

Press **Impedance** continuously to set the output impedance of the Function/Arbitrary Waveform Generator. It can be set to "HighZ" or "50Ω".



21.1.6 To Output Noise

Press **Wave**, then use the multifunction knob  to select "Noise" and then press down the knob to select the waveform. You can also press **Wave** continuously or enable the touch screen to select it. At this time, you can set the Amplitude/High Level, Offset/Low Level, and Impedance of the Noise signal.

1. Set the Amplitude or High Level

First press **Amplitude** or **High Level**, then rotate the multifunction knob  to select "Amplitude" or "High Level". You can also press **Amplitude** or **High Level** continuously to select it. Enable the touch screen to select it. Rotate the multifunction knob  or use the pop-up numeric keypad to set the amplitude or high level of the current signal. Note that if you select "Amplitude" for this menu, then the menu below Amplitude is automatically turns out to be "Offset"; if you select "High Level" for this menu, then the menu below High Level is automatically turns out to be "Low Level".

2. Set the Offset or Low Level

First press **Offset** or **Low Level**, then rotate the multifunction knob  to select "Offset" or "Low Level". You can also press **Offset** or **Low Level** continuously to select it. Enable the touch screen to select it. Rotate the multifunction knob  or use the pop-up numeric keypad to set the offset or low level of the current signal.

3. Set the Impedance

Press **Impedance** continuously to set the output impedance of the Function/Arbitrary Waveform Generator. It can be set to "HighZ" or "50Ω".

21.1.7 Sinc

Press **Wave**, then use the multifunction knob  to select "Sinc" and then press down the knob to select the waveform. You can also press **Wave** continuously or enable the touch screen to select it. At this time, you can set the parameters for the Sinc waveform (as shown in the figure below). For setting methods, refer to descriptions in "*To Output Sine*".

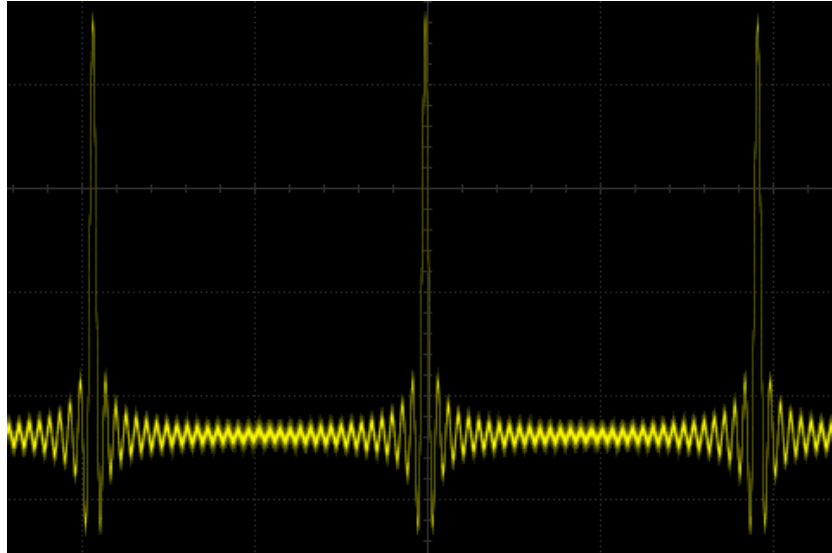



Figure 21.3 Sinc

21.1.8 Exp.Rise

Press **Wave**, then use the multifunction knob  to select "Exp.Rise" and then press down the knob to select the waveform. You can also press **Wave** continuously or enable the touch screen to select it. At this time, you can set the parameters for the Exp.Rise waveform (as shown in the figure below). For setting methods, refer to descriptions in "*To Output Sine*".

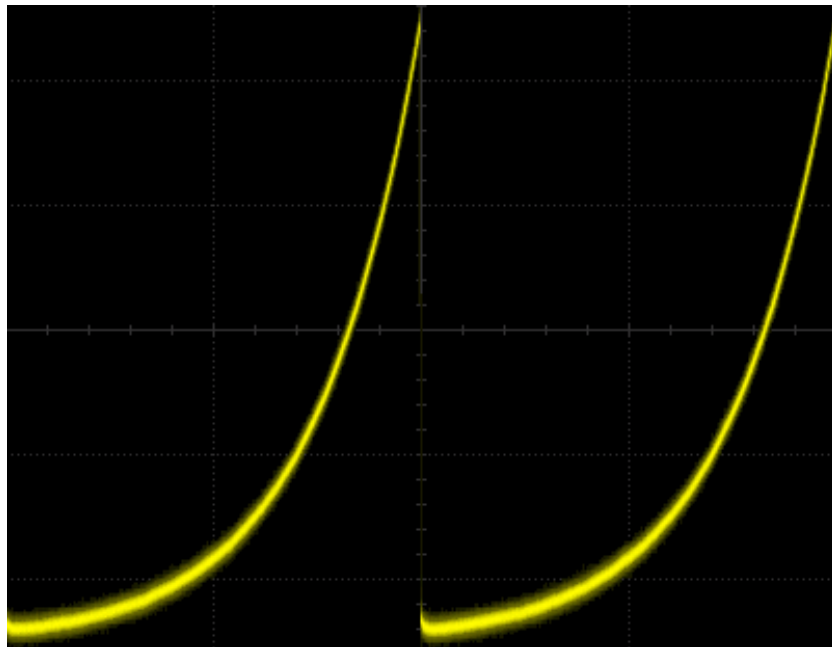

Figure 21.4 Exp.Rise

21.1.9 Exp.Fall



Press **Wave**, then use the multifunction knob  to select "Exp.Fall" and then press down the knob to select the waveform. You can also press **Wave** continuously or enable the touch screen to select it. At this time, you can set the parameters for the Exp.Fall waveform (as shown in the figure below). For setting methods, refer to descriptions in "*To Output Sine*".



Figure 21.5 Exp.Fall

21.1.10 ECG

Press **Wave**, then use the multifunction knob  to select "ECG" and then press down the knob to select the waveform. You can also press **Wave** continuously or enable the touch screen to select it. At this time, you can set the parameters for the ECG waveform (as shown in the figure below). For setting methods, refer to descriptions in "*To Output Sine*".

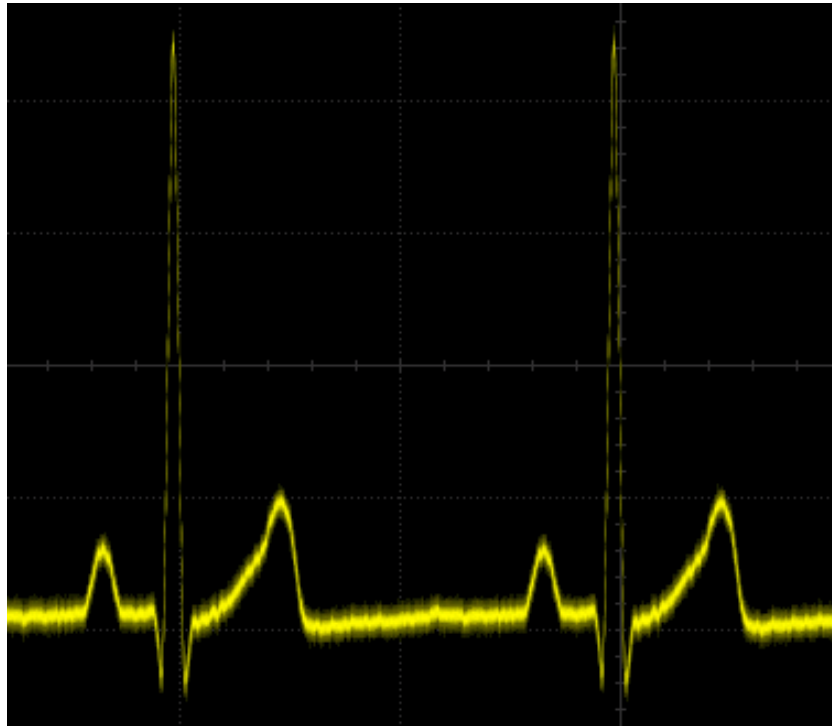



Figure 21.6 ECG

21.1.11 Gauss

Press **Wave**, then use the multifunction knob  to select "Gauss" and then press down the knob to select the waveform. You can also press **Wave** continuously or enable the touch screen to select it. At this time, you can set the parameters for the Gauss waveform (as shown in the figure below). For setting methods, refer to descriptions in "*To Output Sine*".

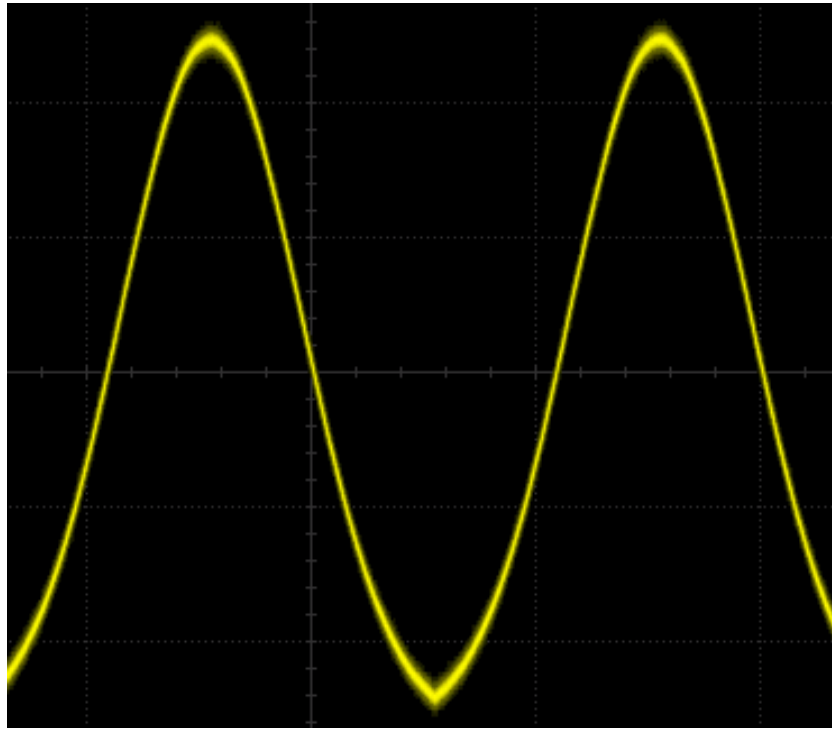



Figure 21.7 Gauss

21.1.12 Lorentz

Press **Wave**, then use the multifunction knob  to select "Lorentz", and then press down the knob to select the waveform. You can also press **Wave** continuously or enable the touch screen to select it. At this time, you can set the parameters for the Lorentz waveform (as shown in the figure below). For setting methods, refer to descriptions in "*To Output Sine*".

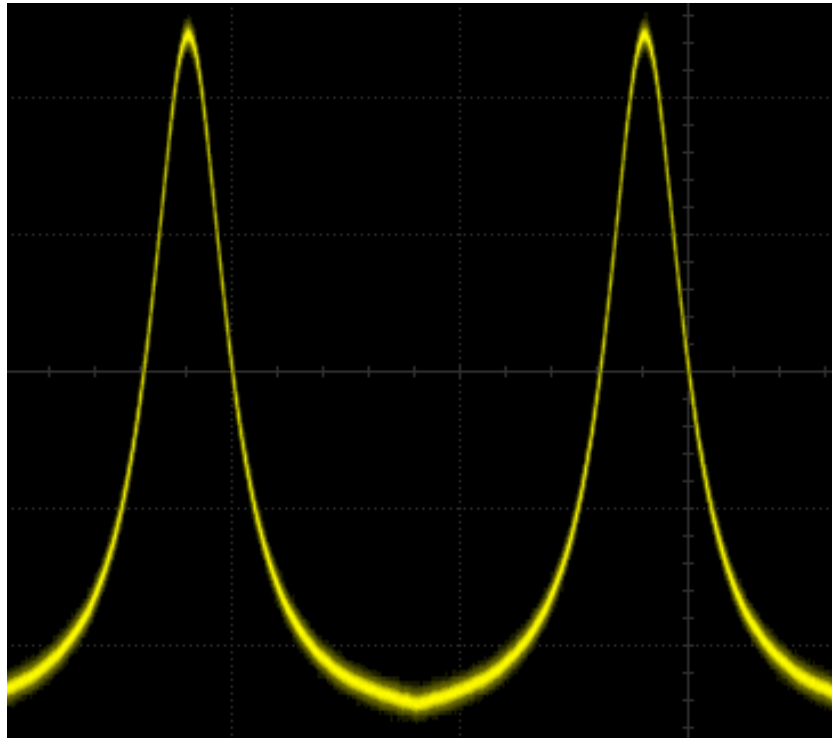

Figure 21.8 Lorentz

21.1.13 Haversine



Press **Wave**, then use the multifunction knob  to select "Haversine" and then press down the knob to select the waveform. You can also press **Wave** continuously or enable the touch screen to select it. At this time, you can set the parameters for the Haversine waveform (as shown in the figure below). For setting methods, refer to descriptions in "*To Output Sine*".



Figure 21.9 Haversine

21.2 To Output the Arbitrary Waveform

This series oscilloscope allows you to define the arbitrary waveform and save it to the internal or external memory. The user-defined waveform can contain 2 to 16,384 data points (i.g. 2 pts to 16 kpts).

Press **Wave**, then use the multifunction knob  to select "Arb", and then press down the knob to select the waveform. You can also press **Wave** continuously or enable the touch screen to select it. At this time, you can set the parameters for the arbitrary waveform.

21.2.1 To Load the Channel and Waveform



1. Load the Channel

Press **Load from CH** to enter the channel loading menu. You can set the channel signal required to be loaded.

- Channel selection

Press **Channel** and rotate the multifunction knob  to select the desired channel (CH1-CH4), and then press down the knob to select it. You can also press **Channel** continuously or enable the touch screen to select it.

- Set the waveform range

Press **Region** continuously to select to load the waveforms in the "Cursor" or "Screen" region. When "Cursor" is selected, press **Cursor A** or **Cursor B** and rotate the multifunction knob  to adjust the positions of the two cursors respectively; or press **Cursor AB** and rotate the multifunction knob  to adjust the positions of cursors A at the same time to determine the waveform range.

- Load

Press **Load** to load the set channel signal.



2. Load the Waveform

Press **Load Stored** to enter the waveform loading interface. You can select the stored waveforms from the internal memory or the external memory. The waveform file is suffixed with "*.arb". Then, press **Load** to load the selected waveform. For details, refer to descriptions in "*Store and Load*".



21.2.2 To Create the Waveforms

You can create arbitrary waveforms according to your needs. Press **Create** to enter the waveform creation menu. Meanwhile, the waveform editor is displayed on the screen.



- **Set the frequency or period**

First press **Frequency** or **Period**, rotate the multifunction knob  to select "Frequency" or "Period". You can also press **Frequency** or **Period** continuously or enable the touch screen to select it. Rotate the multifunction knob  or use the pop-up numeric keypad to set the frequency or period of the current signal.

- **Set the amplitude or high level**

First press **Amplitude** or **High Level**, then rotate the multifunction knob  to select "Amplitude" or "High Level". You can also press **Amplitude** or **High Level** continuously to select it. Enable the touch screen to select it. Rotate the multifunction knob  or use the pop-up numeric keypad to set the amplitude or high level of the current signal. Note that if you select "Amplitude" for this menu, then the menu below Amplitude is automatically turns out to be "Offset"; if you select "High Level" for this menu, then the menu below High Level is automatically turns out to be "Low Level".

- **Set the offset or low level**

First press **Offset** or **Low Level**, then rotate the multifunction knob  to select "Offset" or "Low Level". You can also press **Offset** or **Low Level** continuously to select it. Enable the touch screen to select it. Rotate the multifunction knob  or use the pop-up numeric keypad to set the offset or low level of the current signal.

- **Set the initial points**

The initial number of points indicates the number of editable points. By default, the number of editable points of arbitrary waveforms created can be preset to 2. Point 1 is fixed at 0 s and Point 2 is fixed at the middle of the period. Press **Init Points**, then rotate the multifunction knob  or use the numeric keypad to set the number of editable points for the arbitrary waveform. The arbitrary waveform can contain up to 16,384 (16 kpts) points.

- **Linear interpolation**

Press **Linear Interp** continuously to enable or disable the linear interpolation between the defined points of the waveform.

- ON: the waveform editor connects two points using a straight line.
- OFF: the waveform editor will keep a constant voltage level between two points and create a ladder-like waveform.

- **Edit points**

Press **Edit Points** to enter the point editing menu. You can specify a voltage value for each waveform point to define the waveforms.

- **Current Point**

Press **PointX**, then rotate the multifunction knob  or use the numeric keypad to select the points to be edited. The available range is from 1 to the number of initial points.

- **Voltage**

Press **Voltage**, then rotate the multifunction knob  or use the numeric keypad to set the voltage value of the current point. Its available range is from -2.5 V to +2.5 V.

- **Insert**

Press **Insert** to insert a new editable point between the current point and the next point. The number of initial points adds 1 automatically. You can press **Insert** continuously to increase the editable points gradually.

- **Delete**

Press **Delete** to delete the current point from the waveform, and connect the remaining points using the current interpolation mode.

NOTE

- **Zoom**

Press **Zoom** continuously to enable or disable the zoom function of horizontal time base.

- **Apply**

Press **Apply** to apply the current settings for the currently edited arbitrary waveforms and output the edited waveforms.



- **Save the arbitrary waveform**

Press **Save** to enter the file saving interface. Please refer to descriptions in "*Store and Load*" to save the currently edited waveform file to the internal or external memory in ".arb" format (you can overwrite the original file or save the currently edited waveform).



21.2.3 To Edit the Waveforms

You can edit the waveforms in the current volatile memory. Press **Edit** to enter the waveform editing menu.



- **Set the frequency or period**

First press **Frequency** or **Period**, rotate the multifunction knob  to select "Frequency" or "Period". You can also press **Frequency** or **Period** continuously or enable the touch screen to select it. Rotate the multifunction knob  or use the pop-up numeric keypad to set the frequency or period of the current signal.

- **Set the amplitude or high level**

First press **Amplitude** or **High Level**, then rotate the multifunction knob  to select "Amplitude" or "High Level". You can also press **Amplitude** or **High Level** continuously to select it. Enable the touch screen to select it. Rotate the multifunction knob  or use the pop-up numeric keypad to set the amplitude or high level of the current signal. Note that if you select "Amplitude" for this menu, then the menu below Amplitude is automatically turns out to be "Offset"; if you select "High Level" for this menu, then the menu below High Level is automatically turns out to be "Low Level".

- **Set the offset or low level**

First press **Offset** or **Low Level**, then rotate the multifunction knob  to select "Offset" or "Low Level". You can also press **Offset** or **Low Level** continuously to select it. Enable the touch screen to select it. Rotate the multifunction knob  or use the pop-up numeric keypad to set the offset or low level of the current signal.

- **Linear interpolation**

Press **Linear Interp** continuously to enable or disable the linear interpolation between the defined points of the waveform.

- ON: the waveform editor connects two points using a straight line.
- OFF: disables the linear interpolation. The waveform editor will keep a constant voltage level between two points and create a ladder-like waveform.

- **Edit points**

Press **Edit Points** to enter the point editing menu. You can specify a voltage value for each waveform point to define the waveforms.

- **Current Point**

Press **PointX**, then rotate the multifunction knob  or use the numeric keypad to select the points to be edited. The available range is from 1 to the number of initial points.

- **Voltage**

Press **Voltage**, then rotate the multifunction knob  or use the numeric keypad to set the voltage value of the current point. Its available range is from -2.5 V to +2.5 V.

- **Insert**

Press **Insert** to insert a new editable point between the current point and the next point. The number of initial points adds 1 automatically. You can press **Insert** continuously to increase the editable points gradually.

- **Delete**

Press **Delete** to delete the current point from the waveform, and connect the remaining points using the current interpolation mode.

NOTE

- **Zoom**

Press **Zoom** continuously to enable or disable the zoom function of horizontal time base.

- **Apply**

Press **Apply** to apply the current settings for the currently edited arbitrary waveforms and output the edited waveforms.

- **Save the arbitrary waveform**

Press **Save** to enter the file saving interface. Please refer to descriptions in "*Store and Load*" to save the currently edited waveform file to the internal or external memory in ".arb" format (you can overwrite the original file or save the currently edited waveform).

21.3 Modulation

The built-in Function/Arbitrary Waveform Generator supports amplitude modulation (AM), frequency modulation (FM), and frequency-shift keying modulation (FSK). A modulated waveform consists of a carrier waveform and a modulating waveform. The carrier waveform is the waveform output from the Function/Arbitrary Waveform Generator, and the modulating signal can be the built-in sine, square, triangle waveform, or noise signal.

Press **Settings** > **Type**, and rotate the multifunction knob  to select "Modulation" and then press down the knob to select it. You can also press **Type** continuously or enable the touch screen to select it.

Press **Type**, rotate the multifunction knob  to select the desired modulation type, and then press down the knob to select it. You can also press **Type** continuously or enable the touch screen to select it. The available modulation types include AM, FM, and FSK.

21.3.1 AM

AM (Amplitude Modulation), namely the amplitude of the carrier waveform changes with that of the modulating waveform, as shown in the figure below.

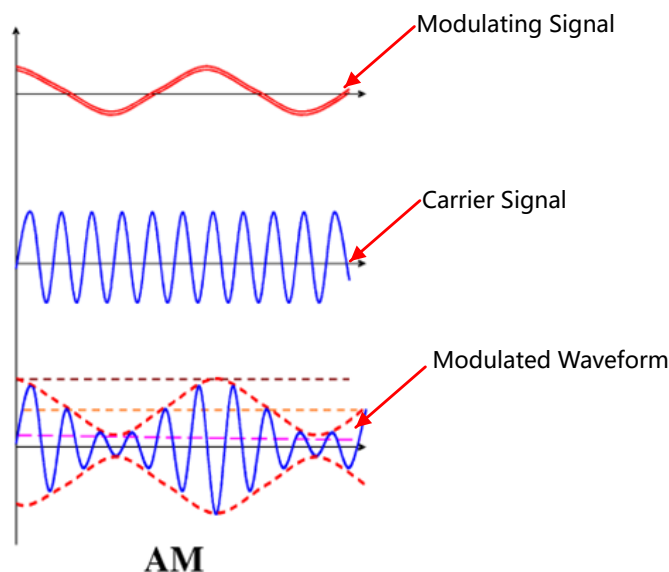



Figure 21.10 AM

1. Select the Modulating Waveform

Press **Waveform**, and rotate the multifunction knob  to select the desired modulating waveform, and then press down the knob to select it. You can also press **Waveform** continuously or enable the touch screen to select it. The available modulating waveforms include sine, square, triangle waveform, and noise.

2. Set the Modulation Frequency

Press **Frequency**, then rotate the multifunction knob  or use the pop-up numeric keypad to set the frequency of the modulation signal. The available range is from 1 Hz to 50 kHz.

3. Set the Modulation Depth

The modulation depth refers to the strength of the AM and is expressed in percentage. Press **AM Depth**, then rotate the multifunction knob  or use the pop-up numeric keypad to set the modulation depth of the modulating waveform. The available range is from 0% to 120%. When it is set to 0%, the output amplitude is half of the carrier amplitude. When it is set to 100%, the output amplitude equals the carrier amplitude. When it is set to a value greater than 100%, envelop distortion will occur which must be avoided in actual circuit; at this point, the output of the instrument will not exceed 2.5 Vpp (on the 50 Ω load).

21.3.2 FM

FM (Frequency Modulation), namely the frequency of the carrier waveform changes with that of the modulating waveform, as shown in the figure below.

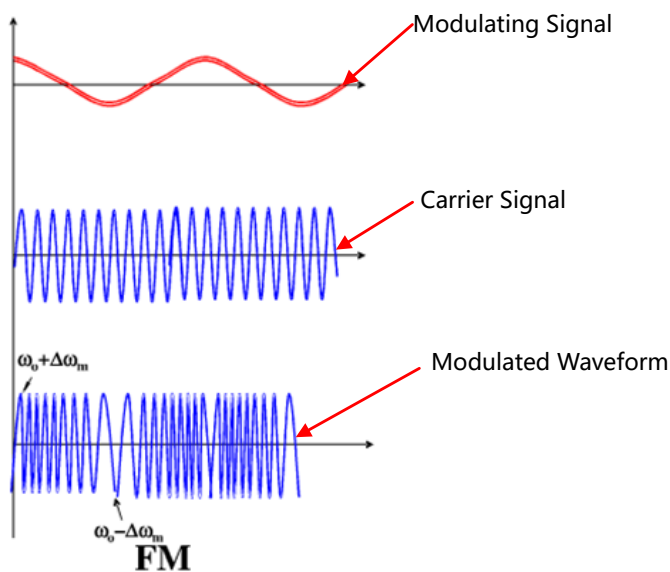



Figure 21.11 FM

1. Select the Modulating Waveform

Press **Waveform**, and rotate the multifunction knob  to select the desired modulating waveform, and then press down the knob to select it. You can also press **Waveform** continuously or enable the touch screen to select it. The available modulating waveforms include sine, square, triangle waveform, and noise.

2. Set the Modulation Frequency

Press **Frequency**, then rotate the multifunction knob  or use the pop-up numeric keypad to set the frequency of the modulation signal. The available range is from 1 Hz to 50 kHz.

3. Set the Frequency Deviation

Press **Deviation**, then rotate the multifunction knob  or use the numeric keypad to set the frequency deviation of modulating waveform from the carrier frequency. The settable frequency range is from 1 Hz to to the current frequency of the carrier waveform.

21.3.3 FSK

FSK (Frequency-shift Keying) is a modulation method that uses the digital signal to control the carrier frequency changes. It is one of the methods that have been early used in information transmission. Its advantages lie in good performance in anti-noise and anti-attenuation, and it has been widely used in in low and medium rate of data transmission.

1. Set the Modulation Polarity

Press **Polarity** continuously to select "Positive" or "Negative" of the modulating waveform to control the frequency output.

2. Set the Modulating Rate

Press **FSK Rate**, then rotate the multifunction knob  or use the pop-up numeric keypad to set the frequency of the modulation signal. The available range is from 1 Hz to 50 kHz.

3. Set the Hopping Frequency

Hopping frequency indicates the frequency of the modulating waveform. The range of the hopping frequency is from 100 MHz to the maximum frequency of the carrier waveform. By default, it is 10 kHz. Press **Hop Freq**, then rotate the multifunction knob  or use the pop-up numeric keypad to set the hopping frequency.

21.4 Sweep

The built-in Function/Arbitrary Waveform Generator supports the sweep function. In the sweep mode, the Function/Arbitrary Waveform Generator outputs from the start frequency to the end frequency at a specified sweep time. It supports three sweep modes: Linear, Log, and Step. You are allowed to set the parameters such as Start Keep, End Keep, and Return Time. Internal and Manual trigger sources are supported. The sweep output is available for Sine, Square, Ramp, and Arb waveforms (DC excluded).

Press **Settings** > **Type**, and rotate the multifunction knob  to select "Sweep" and then press down the knob to select it. You can also press **Type** continuously or enable the touch screen to select it.

1. Sets the Sweep Type

Press **Sweep Type**, and rotate the multifunction knob  to select the desired sweep type, and then press down the knob to select it. You can also press **Sweep Type** continuously or enable the touch screen to select it. The available sweep types include Linear, Log, and Step.

- Linear: the frequency of the signal changes linearly.
- Log: the frequency of the signal changes in log form.
- Step: the frequency of the signal changes with ladder-like step.



2. Sweep Settings

Press **Settings** to enter the sweep setting menu.

- Set start frequency and end frequency

Start frequency and end frequency indicate the upper and lower limits of the sweep frequency. Function/Arbitrary Waveform Generator always sweeps from the start frequency to the end frequency, and then returns back to the start frequency.

- When start frequency is smaller than the end frequency, the Function/Arbitrary Waveform Generator sweeps from low frequency to high frequency.
- When start frequency is greater than the end frequency, the Function/Arbitrary Waveform Generator sweeps from high frequency to low frequency.
- When start frequency is equal to the end frequency, the Function/Arbitrary Waveform Generator outputs at a fixed frequency.

Press **Start Freq**, then rotate the multifunction knob  or use the pop-up numeric keypad to set the start frequency. Press **End Freq**, then rotate the multifunction knob  or use the pop-up numeric keypad to set the end frequency. By default, the start frequency is 100 Hz, and the end frequency is 1 kHz. The ranges of start frequency and end frequency for different sweep waveforms are different. The generator will restart to sweep and output from the specified "Start Frequency" after "Start Frequency" or "End Freq" is modified.

- **Start Keep**

Start keep indicates the time that the output signal keeps outputting at the "Start Freq" after the sweep starts. After the start keep time expires, the generator will continue outputting with varied frequencies according to the current sweep type.

Press **Start Keep**, then rotate the multifunction knob  or use the pop-up numeric keypad to set the start keep time. The default is 0 s, and the range is from 0 s to 500 s.

- **End Keep**

End Keep indicates the time that the output signal continues outputting at the "End Freq" after the generator sweeps from "Start Freq" to "End Freq".

Press **End Keep**, then rotate the multifunction knob  or use the pop-up numeric keypad to set the end keep time. The default is 0 s, and the range is from 0 s to 500 s.

- **Set the step**

When the sweep type is set to "Step", this menu is enabled and can be settable.

Press **Step number**, then rotate the multifunction knob  or use the numeric keypad to set the step value. By default, it is 2. Its available range is from 2 to 1,000.

- **Set the trigger source**

The trigger sources of the sweep can be Internal or Manual. The generator will generate a sweep output when a trigger signal is received, and then it waits for the next trigger signal.

Press **Trig Source** and rotate the multifunction knob  to select the desired trigger source, and then press down the knob to select it. You can also press **Trig Source** continuously or enable the touch screen to select it. The available trigger sources include Internal or Manual.

- Internal: The Function/Arbitrary Waveform Generator outputs continuous sweep waveform.

- Manual: when you press **Manual Trig** one time, one sweep is immediately launched for the corresponding channel.

3. Set the Sweep Time

Press **Sweep Time**, then rotate the multifunction knob  or use the pop-up numeric keypad to set the sweep time. By default, it is 1 s. Its available range is from 1 ms to 500 s. The generator will restart to sweep and output from the specified "Start Frequency" after the sweep time is modified.

4. Set the Return Time

Return time indicates the time that the output signal restores from "End Freq" to "Start Freq" after the Function/Arbitrary Waveform Generator sweeps from "Start Freq" to "End Freq" and till the "End Keep" time expires.

Press **Return Time**, then rotate the multifunction knob  or use the pop-up numeric keypad to set the return time. By default, it is 0 s. Its available range is from 0 s to 500 s.

21.5 Burst

The built-in Function/Arbitrary Waveform Generator of this series oscilloscope supports outputting the burst waveforms with a specified number of cycles. It supports using internal and manual trigger sources to control the output of the burst waveforms. Two burst types are supported: N Cycle and Infinite.

Press **Settings** > **Type**, and rotate the multifunction knob  to select "Burst", and then press down the knob to select it. You can also press **Type** continuously or enable the touch screen to select it.

1. Set the Burst Type

Press **Burst Type**, and rotate the multifunction knob  to select the desired burst type, and then press down the knob to select it. You can also press **Burst Type** continuously or enable the touch screen to select it. The available burst types include N Cycle and Infinite.

- N Cycle: outputs the burst waveforms with a specified number of cycles once receiving the trigger signal.
- Infinite: sets the number of cycles to Infinite. It outputs continuous waveforms once receiving the trigger signal.

2. Set the Number of Cycles

When the burst type is set to "N Cycle", you need to set the number of cycles.

Press **Cycles**, then rotate the multifunction knob  or use the pop-up numeric keypad to set the cycle count. For the Infinite burst type, the Cycles menu is disabled and grayed out.

3. Set the Burst Delay

Burst delay indicates the time from when receiving the trigger signal to starting to output N Cycle of bursts or Infinite burst.

Press **Delay**, then rotate the multifunction knob  or use the pop-up numeric keypad to set the burst delay. The setting range of the delay time is related to the burst cycle count.

4. Burst Setting

Press **Settings** to enter the burst setting menu.

- Set the trigger source

The trigger sources of the burst can be Internal or Manual. The generator will generate a burst output when a trigger signal is received, and then it waits for the next trigger signal.

Press **Trig Source** and rotate the multifunction knob  to select the desired trigger source, and then press down the knob to select it. You can also press **Trig Source** continuously or enable the touch screen to select it. The available trigger sources include Internal and Manual. For the Infinite burst type, the **Trig Source** menu is disabled and grayed out. You can only perform the manual trigger.

- Internal: The Function/Arbitrary Waveform Generator outputs continuous N cycle.

- Manual: when you press **Manual Trig** one time, one burst output is immediately launched for the corresponding channel. For the Infinite burst type, the Cycles menu is disabled and grayed out.

- Set the burst period

It is defined as the time from the beginning of one burst to that of another burst.

Press **Burst Period**, then rotate the multifunction knob  or use the pop-up numeric keypad to set the burst period. The setting range is from 2 ms to 500 s. By default, it is 10 ms.

22 Store and Load

You can save the current setups, waveforms, screen image, and parameters of the oscilloscope to the internal memory or external USB storage device (such as USB storage device) in various formats and load the stored setups or waveforms when needed.

You can also copy, delete, or rename the specified type of file from the internal memory or external USB storage device via the disk management menu.



NOTE

This series oscilloscope only supports the flash memory USB storage device of FAT32 format.

22.1 Storage System

Press  on the front panel to enter the store and load setting interface. This oscilloscope provides three USB HOST interfaces on the front panel and one USB HOST interface on the rear panel, which can all be connected to the USB storage device for external storage. The USB storage devices connected are marked as "Removable USB Disk (D)", "Removable USB Disk (E)", "Removable USB Disk (F)", "Removable USB Disk (G)", and etc.

22.2 Storage Type

The file types for storage include image, waveform, and setups. The storage descriptions of each type are as follows.

1. Image

Press **Save Image** > **Format**, and then rotate the multifunction knob  to select the image type. You can also press **Format** continuously or enable the touch screen to select it. Save the screen image to the internal or external memory in ".png", ".bmp", ".jpg", or ".tif" format.

After selecting this type:

- Press **File Name** to input the file name to be saved. For filename input, refer to descriptions in "*To Create a Folder*". Press  > **More** > **Auto Name** to select "ON", then the filename is generated automatically. If the filename that you input is the same as the existing filename, a prompt message will be displayed,

reminding you that the existing file will be overwritten and asking you whether to continue or not.

- Press **Invert** to enable or disable the invert function.
- Press **Color** to select the desired storage color. It can be set to "Gray" or "Color".
- Press **NewFolder** to create a new storage folder. For details, refer to descriptions, in "*To Create a Folder*".
- Press **Window** to enable or disable the display of the disk management interface.
- Press **Save** to save the set image file. Press  > **More** > **Header** to select "ON" or "OFF". If you select "ON", the instrument model, firmware version number, serial number, and the image creation date will be displayed in the header of the image when you save the image file.

TIP

After a USB storage device (FAT32, Flash type) is connected, press  on the front panel to save the file to the internal or external USB storage device. By default, it is saved to the external storage device.

2. WavePress **Save Wave** to enter the waveform storage setting interface. Save the main setting information (e.g. "On/Off" state of the channel, vertical scale, and horizontal time base) and waveform data of all enabled channels (analog channel and digital channel) to the internal or external memory.

After selecting this type:

- Press **Data Source** to select "Screen" or "Memory".
- Press **Format** to select waveform storage, such as "*.bin", "*.cvs", and "*.wfm" (when "Memory" is selected under Data Source).
- Press **File Name** to input the file name to be saved. For filename input, refer to descriptions in "*To Create a Folder*". Press  > **More** > **Auto Name** to select

"ON", then the filename is generated automatically. If the filename that you input is the same as the existing filename, a prompt message will be displayed, reminding you that the existing file will be overwritten and asking you whether to continue or not.

- Press **Channel**, then the available storage channels include CH1-CH4 and D0-D15. Only when you select "Memory" under Data Source and the format is "*.bin" or "*.cvs", can you set the storage channel.
- Press **NewFolder** to create a new storage folder. For details, refer to descriptions, in "*To Create a Folder*".
- Press **Save** to save the set waveform file.
- Press **More** > **Window** to enable or disable the display of the disk management interface.
- Press **More** > **Time information** to enable or disable the display of the time information in the waveform data. If enabled, the time information for the waveform data will be displayed. If disabled, the time information for the waveform data will not be displayed.

3. Setup Press **Save Setup** to enter the setup setting interface.

Save the settings of the oscilloscope to the internal or external memory in "*.stp" format. When loading, the stored settings can be recalled.

After selecting this type:

- Press **File Name** to input the file name to be saved. For filename input, refer to descriptions in "*To Create a Folder*". Press  > **More** > **Auto Name** to select "ON", then the filename is generated automatically. If the filename that you input is the same as the existing filename, a prompt message will be displayed, reminding you that the existing file will be overwritten and asking you whether to continue or not.
- Press **NewFolder** to create a new storage folder. For details, refer to descriptions, in "*To Create a Folder*".

- Press **Window** to enable or disable the display of the disk management interface.
- Press **Save** to save the set setup file.

22.2.1 Binary Data Format (.bin)

Binary data format stores waveform data in binary format and provides data headers that describe these data. As data are displayed in binary format, its file size is much more smaller than that in ASCII format. If several channels are enabled, then all the displayed channels will be saved (save the first channel then save the second, and then it goes on like this until all the displayed channels are saved).

In BIN file format, the data are displayed as follows:

- CH1 Data
- CH2 Data
- CH3 Data
- CH4 Data
- Digital Channel Data
- Math Waveform Data

Binary Header Format

1. File Header

There is only one file header in a binary file. The file header contains the following information.

Cookie	Two-byte characters, RG, indicating that the file is the RIGOL binary data file format.
Version	Two-byte, indicating the file version.
File Size	A 4-byte integer, indicating the number of bytes in the file. It includes the header.
Number of Waveforms	A 4-byte integer, indicating the number of waveforms that are stored in the file.

2. Waveform Header

It is possible to store several waveforms in the file. Each stored waveform has a waveform header. When several channels are stored, each channel can be

considered as a separate waveform. The waveform header contains the information about the type of waveform data that are stored following the waveform data header.

Header Size	A 4-byte integer, indicating the number of bytes in the header.
Waveform Type	<p>A 4-byte integer, indicating the type of the waveform stored in the file.</p> <p>0 = Unknown 1 = Normal 2 = Peak Detection 3 = Average 4 = Not Used 5 = Not Used 6 = Logic</p>
Number of Waveform Buffers	A 4-byte integer, indicating the number of waveform buffers required to read the data.
Number of Points	A 4-byte integer, indicating the number of waveform points in the data.
Count	A 4-byte integer, indicating the number of hits at each time interval during waveform recording when using a certain sample mode (e.g. Average) to create the waveforms. For example, when averaging, a count of 4 indicates that each waveform data point in the waveform recording has been averaged at least 4 times. The default value is 0.
X Display Range	A 4-byte float, indicating the X-axis duration of the waveform that is displayed. For time-domain waveforms, it indicates the duration of time across the display. If the value is zero, then no data has been acquired.
X Display Origin	An 8-byte double, indicating the X-axis value at the left edge of the screen. For time-domain waveforms, it indicates the time at the start of the display. The value is treated as a double precision 64-bit float point number. If the value is zero, then no data has been acquired.
X Increment	An 8-byte double, indicating the duration between data points on the X axis.

Header Size	A 4-byte integer, indicating the number of bytes in the header.
	For time-domain waveforms, it indicates the time between points. If the value is zero, then no data has been acquired.
X Origin	An 8-byte double, indicating the X-axis value of the first data point in the data recording. For time-domain waveforms, it indicates the time of the first point. The value is treated as a double precision 64-bit float point number. If the value is zero, then no data has been acquired.
X Units	A 4-byte integer, indicating the unit of measurement for X values in the acquired data. 0 = Unknown 1 = Volts (V) 2 = Seconds (s) 3 = Constant 4 = Amps (A) 5 = dB 6 = Hz
Y Units	A 4-byte integer, indicating the unit of measurement for Y values in the acquired data. The possible values are listed above under X Units.
Date	A 16-byte character array, not used
Time	A 16-byte character array, not used
Frame	A 24-byte character array, indicating the model number and serial number of the oscilloscope in the format: MODEL#:SERIAL#.
Waveform Label	A 16-byte character array that contains the label assigned to the waveform.

3. Waveform Data Header

A waveform may have multiple data sets. Each waveform data set has a waveform data header. The waveform data header consists of information about the waveform data set. The header is stored before the data set.

Header Size	A 4-byte integer, indicating the number of bytes in the waveform data header.
Buffer Type	A 2-byte integer, indicating the type of the waveform data stored in the file. 0 = Unknown 1 = Normal 32-bit float data 2 = Maximum float data 3 = Minimum float data 4 = Not Used 5 = Not Used 6 = Digital unsigned 8-bit character data (for digital channels)
Bytes Per Point	A 2-byte short integer, indicating the number of bytes per data point.
Buffer Size	A 4-byte integer, indicating the size of the buffer required to hold the data points.

22.3 Load Type

This oscilloscope provides two load types: waveform load and setup load. The descriptions of each load type are as follows.

1. Waveform Load

Press **Load Wave** to load the waveforms from the internal memory or the external USB disk. The default file type is "*.wfm" and no other options are available. Select the file to be loaded from the memory, then press **Load** to load the selected file.







2. Load Setup

Press **Load Setup** to load the setups from the internal memory or the external USB disk. The default file type is "*.stp", and no other options are available. Select the file to be loaded from the memory, then press **Load** to load the selected file.

22.4 Internal Storage and Load



The internal memory supports the storage and load of the image file, waveform file, setup file, reference waveform file, and pass/fail test mask file.

1. Save the Specified Oscilloscope Setting to the Internal Memory (Take Save Setup as an Example)







- a. Connect a signal to the oscilloscope and obtain stable display of waveforms.
- b. Press  > **Save Setup** to enter the setup storage interface. The disk management interface is displayed automatically. By default, "Local Disk(C)" is selected.
- c. Rotate the multifunction knob  or enable the touch screen to open the internal memory storage interface.
- d. Rotate the multifunction knob  to select the desired storage location, and then press down the knob to open it. You can also enable the touch screen to select the storage location. Rotate the multifunction knob  and select , press down the knob or enable the touch screen to tap  to go to the previous location. Besides, you can also press **NewFolder** to create a new storage folder. For details, refer to descriptions in "*To Create a Folder*".
- e. Press **File Name** to name the setup file for storage. For details, refer to descriptions in "*To Create a Folder*". Press  > **More** > **Auto Name** to select "ON", then the filename is generated automatically. If the filename that you input is the same as the existing filename, a prompt message will be displayed, reminding you that the existing file will be overwritten and asking you whether to continue or not.
- f. Press **Save** to save the setup file to the selected folder in "*.stp" format.

TIP





- After saving the reference waveform, press  > **More** > **Export** to enter the disk management interface of reference waveform file storage.
- Press  > **PassFail** to enable the pass/fail test function. Then press **Mask** > **Save** to enter the disk management interface of pass/fail test mask file storage.

2. Load the Setup File from the Internal Memory (Take Load Setup as an Example)

- a. Press  > **Load Setup** to enter the setup load interface. The disk management interface is displayed automatically. By default, "Local Disk(C)" is selected.
- b. Rotate the multifunction knob  or enable the touch screen to open the internal memory storage interface.
- c. Rotate the multifunction knob  to select the desired load location, and then press down the knob to open it. You can also enable the touch screen to select the location. Rotate the multifunction knob  and select , press down the knob or enable the touch screen to tap  to go to the previous location.
- d. Rotate the multifunction knob  to select the file to be loaded (the default file type is in "*stp" format), then the **Load** menu is enabled. Press Load to load the selected file. You can also enable the touch screen to operate.



TIP





- Press  > **More** > **Import** to enter the disk management interface of reference waveform file load.
- Press  > **PassFail** to enable the pass/fail test function. Then press **Mask** > **Load** to enter the disk management interface of pass/fail test mask file load.

22.5 External Storage and Load







Before external storage and load, ensure that the USB disk is properly connected. The external memory supports image save, waveform saving, setup saving, waveform loading, and setup loading.

1. Save the Specified Type of File in the External USB Storage Device (Take Waveform Saving as an Example)



- a. Connect a signal to the oscilloscope and obtain stable display of waveforms.
- b. Press  > **Save Wave** to enter the waveform storage interface. The disk management interface is displayed automatically.

- c. Rotate the multifunction knob  to select "Removable USB Disk (D/E/F/G...)", press down the knob to open the external disk storage interface. You can also enable the touch screen to select the storage location. Rotate the multifunction knob  and select , press down the knob or enable the touch screen to tap  to go to the previous location. Besides, you can also press **NewFolder** to create a new storage folder. For details, refer to descriptions in "*To Create a Folder*".
- d. To set the waveform saving, refer to descriptions of "Wave" in "*Storage Type*".
- e. Press **Save** to save the waveform file to the selected folder in the specified save format.

2. Load the Specified Type of File from the External USB Storage Device (Take Waveform Loading as an Example)

- a. Press  > **Load Wave** to enter the waveform loading interface. The disk management interface is displayed automatically.
- b. Rotate the multifunction knob  to select "Removable USB Disk (D/E/F/G...)", press down the knob to open the external disk storage interface. You can also enable the touch screen to select the load location. Rotate the multifunction knob  and select , press down the knob or enable the touch screen to tap  to go to the previous location.
- c. Rotate the multifunction knob  to select the file to be loaded, then the **Load** menu is enabled. Press Load to load the selected file. You can also enable the touch screen to operate.

22.6 Disk Management

Press  > **Disk** to turn on the disk management interface as shown in *Figure 22.1*. Rotate the multifunction knob  to select the desired disk. The disk currently

selected is displayed in red shading. Press down the knob  to open the selected disk. You can also enable the touch screen to select the disk.

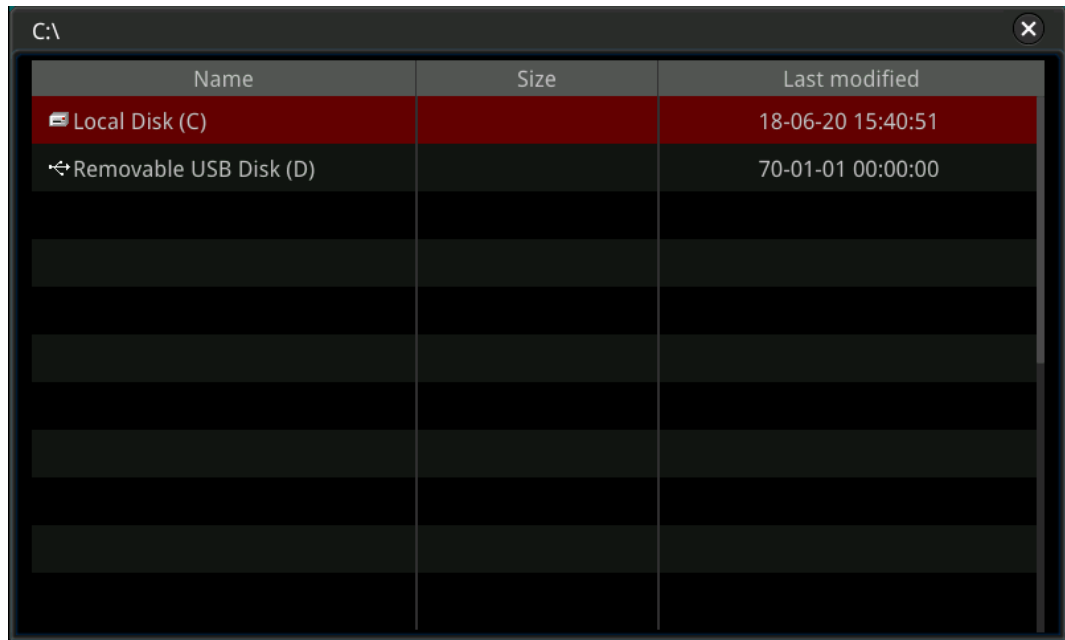



Figure 22.1 Disk Management Interface

22.6.1 To Select the File Type

Except the image storage, waveform storage, and setup storage, the oscilloscope can also display files for advanced applications,

Press  > **Disk** > **File Type**, rotate the multifunction knob  to select the desired file type. The default is "*.*". Under the current path, only the file whose suffix of its file name matches that of the file type selected will be displayed in the current path.

22.6.2 To Create a Folder

Before using the external storage device, make sure that a USB storage device (FAT32 format, flash memory) is connected correctly.

In the disk management interface, rotate the multifunction knob  or enable the touch screen to select the storage location. By default, the internal memory "Local Disk(C)" is selected. Press **NewFolder** to enter the interface, as shown in [Figure 22.2](#).

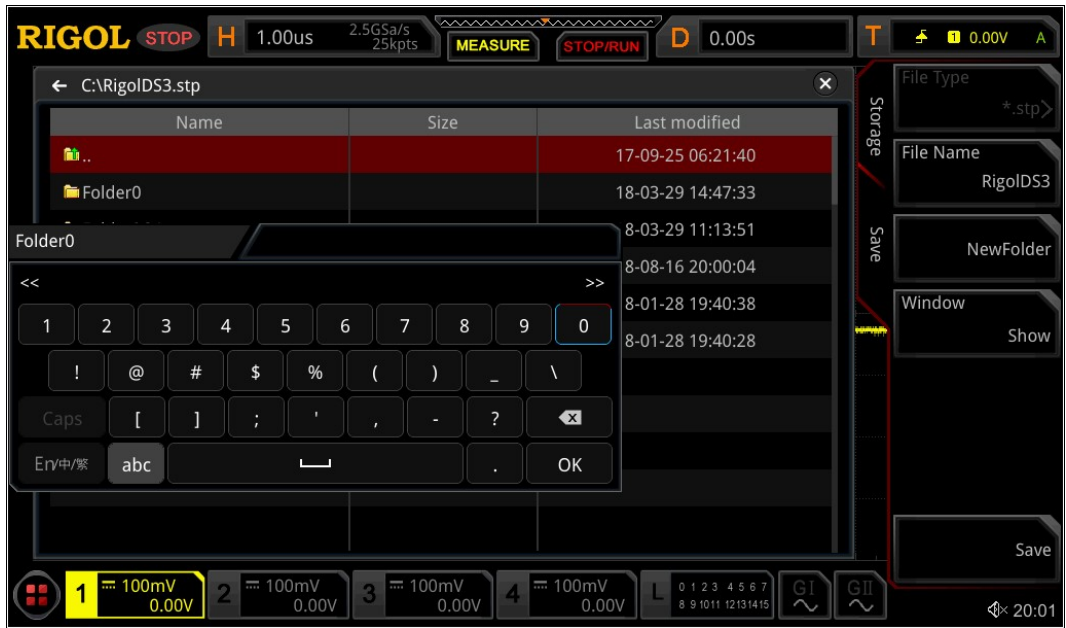



Figure 22.2 Create a Folder

This oscilloscope supports Chinese/English input method. The length of folder name is limited to 22 bytes (one Chinese character occupies two bytes). The following part introduces how to input a folder name using Chinese/English input method.



TIP

During the name input, rotate the multifunction knob  to select the desired contents. Press down the knob  to input the desired contents. You can also enable the touch screen and tap the desired contents to select it.

English Input Method

For example, create a folder with the name "Filename".

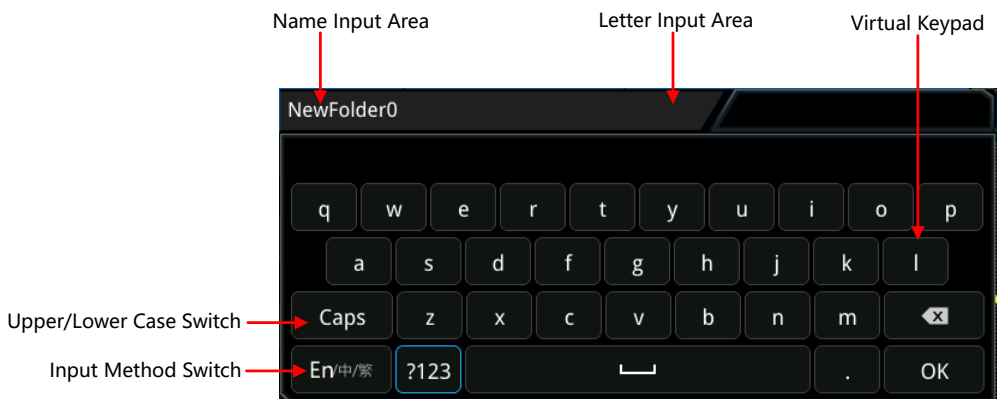



1. Select English Input Method



If the current input method is "En/中/繁", please go to Step 2. If the current input method is "中/繁/En" or "繁/En/中", rotate the multifunction knob  to select the

input switch key and press the knob  continuously to switch to "En/中/繁". "En" is located first and highlighted.

2. Clear the Name Input Area

If there is no character in the "Name Input Area", please go to Step 3. If there are characters in the "Name Input Area", rotate the multifunction knob  to select the Delete key  to delete all the characters in the name input area in order.



3. Input the First Character "F"

- a. If the current setting is uppercase input, please go to Step 2. If the current setting is lowercase input, rotate the multifunction knob  to select "Caps" and press down the knob to switch to the uppercase input.
- b. Rotate the multifunction knob  to select "F" and press down the knob. The character is displayed in the input area.

4. Input the Other Characters

Use the same method to input the remaining letters "ilename" by referring to Step 3. Pay attention to the upper-lower case of the letters when inputting them.

5. Modify or Delete the Unwanted Characters that Have Been Entered

While entering a value, you can modify or delete the unwanted character if necessary. To delete the input characters, rotate the multifunction knob  in the virtual keypad to select the delete key . Press down the key to delete the characters. To modify the characters that have been input, delete the unwanted characters first and then input the new characters. If the character to be modified is in the middle, press the delete key to delete the characters starting from the last one to the character to be modified, then input the new character again.

If the touch screen is enabled, tap to directly move the cursor to the character required to be modified or deleted, and then input the desired character again or delete the unwanted character.

TIP

If characters already exist in the letter input area, when you rotate the multifunction knob  to delete the characters in the name input area, the characters in the letter input area will be deleted first.



6. After finishing the input, rotate the multifunction knob  and press OK. The oscilloscope will create a folder or a specified type of file with this name under the current path.



Simplified Chinese (Traditional Chinese) Input Method

For example, create a file folder with the name "文件名". Note that the input method of traditional Chinese is the same as that of the simplified Chinese.



1. Select Chinese Input Method

If the current input method is "中/繁/En", please go to Step 2. If the current input method is "En/中/繁" or "繁/En/中", rotate the multifunction knob  to select the input switch key and press the knob  continuously to switch to "中/繁/En". "中" is located first and highlighted.



2. Clear the Pinyin Input Area and Name Input Area If there is no character in the "Pinyin Input Area" and "Name Input Area", please go to Step 3. If there are characters in the "Name Input Area" and "Pinyin Input Area", rotate the multifunction knob  to select the Delete key  to delete all the characters in the name input area in order.

3. Input the first Chinese character "文"

a. Input the pinyin "wen" in the "Pinyin Input Area" Rotate the multifunction knob  to select the first letter "w" in the pinyin "wen" and press down the knob to input "w" in the "Pinyin Input Area".

Use the same method to input the remaining letters "en" in the pinyin "wen". After finishing the input, the Chinese characters available are displayed in the "Chinese Character Selecting Area".



- b. Select the desired Chinese character from the "Chinese Character Selecting Area"

Rotate the multifunction knob  to select "文", and press down the knob, then "文" is input in the "Name Input Area". If the Chinese character is not found in the current page, press  to go to the next page until you find the desired character.

4. Input the Other Characters

Refer to Step 3 and use the same method to input the remaining Chinese characters "件名" in sequence.

5. Modify or delete the unwanted characters that have been entered

When inputting the name, you can modify or delete the filename characters input in the "Name Input Area" as well as delete the pinyin characters input in the "Pinyin Input Area". To delete the input characters, rotate the multifunction knob  in the virtual keypad to select the delete key . Press down the key to delete the characters. To modify the characters that have been input, delete the unwanted characters first and then input the new characters. If the character to be modified is in the middle, press the delete key to delete the characters starting from the last one to the character to be modified, then input the new character again.

If the touch screen is enabled, tap to directly move the cursor to the character required to be modified or deleted, and then input the desired character again or delete the unwanted character.



TIP

If characters already exist in the Pinyin input area, when you rotate the multifunction knob  to delete the characters in the name input area, the characters in the Pinyin input area will be deleted first.

6. After finishing the input, rotate the multifunction knob  and press OK. The oscilloscope will create a folder or a specified type of file with this name under the current path.



22.6.3 To Delete a File or Folder

1. Delete a File or Folder from the Internal Memory

- a. Press  > **Disk**, and rotate the multifunction knob  to select the internal memory "Local Disk(C)". Press down the knob to open it.

- b. Rotate the multifunction knob  to select the file or the folder to be deleted.
- c. Press **Delete**, and then a confirmation dialog box is displayed. Tap to select "Yes" to delete the file or folder.

2. Delete a File or Folder from the External Memory



- a. Press  > **Disk**, and rotate the multifunction knob  to select the external memory. Press down the knob to open it.
- b. Rotate the multifunction knob  to select the file or the folder to be deleted.
- c. Press **Delete**, and then a confirmation dialog box is displayed. Tap to select "Yes" to delete the file or folder.

TIP

- When you delete a directory where a file or a folder exists, the directory cannot be deleted.
- The touch screen function only allows you to select the folder and open it, but you are unable to delete the folder with the touch screen operation.



22.6.4 To Copy and Paste a File or Folder



1. Press  > **Disk**, and rotate the multifunction knob  to select the internal memory or external memory. Press down the knob to open it.
2. Rotate the multifunction knob  to select the file or folder to be copied and pasted.
3. Press **Copy** to copy the selected file or folder.
4. Select the destination folder, then press **Paste** to paste the selected file or folder.

TIP

- If the destination folder has the same file or folder that you want to paste, then a prompt message "File or directory exists" is displayed. You are not allowed to execute the copy and paste operation.
- The touch screen function only allows you to select the folder and open it, but you are unable to copy the folder with the touch screen operation.



22.6.5 To Rename a File or Folder



1. Press  > **Disk**, and rotate the multifunction knob  to select the internal memory or external memory. Press down the knob to open it.
2. Rotate the multifunction knob  to select the file to be renamed.
3. Press **Rename**, and then the filename input interface is displayed. For the filename input method, refer to descriptions in "*To Create a Folder*".



TIP

The touch screen function only allows you to select the folder and open it. You are unable to rename the folder with the touch screen operation.

22.6.6 To Clear the Internal Memory Safely

1. Press  > **Disk**, and rotate the multifunction knob  to select the internal memory "Local Disk(C)". Press down the knob to open it.
2. Press **SecurityClear**, and then a prompt message for confirming security clear is displayed.
3. Press **OK** to clear all the saved files from the internal disk.

22.7 Factory Settings

Press  on the front panel, then a prompt message "Restore default settings?" is displayed. Press **OK** or tap OK to restore the instrument to its factory default settings, as shown in the table below.

Table 22.4 Factory Settings

Parameter	Factory Settings
Horizontal	
Horizontal Time Base	1 μ s
Horizontal Position	0 s







Parameter	Factory Settings
Delayed Sweep	Off
Timebase Mode	YT
Fine	Off
Horizontal Expansion	Center
Vertical	
VScale	100 mV
VOffset	0 V
CH1	On
CH2	Off
CH3	Off
CH4	Off
Channel Coupling	DC
BW Limit	OFF
Attenuation	1X
Input Impedance	1 MΩ
Invert	Off
Fine	Off
Channel Unit	[V]
Display Label	Off
Ch-Ch Skew	0 s
Offset Cal	0 V
Acquire	
Acquisition Mode	Normal
Memory Depth	Auto

Parameter	Factory Settings
Anti-Aliasing	Off
Trigger	
Trigger Type	Edge Trigger
Source Selection	CH1
Edge Type	Rising
Trigger Mode	Auto
Trigger Coupling	DC
Trigger Holdoff	8 ns
Noise Rejection	Off
Display	
Display Type	Vector
Persistence Time	Min
Intensity	50%
Grid	FULL
Grid Brightness	20%
Show Scale	Off
Color Grade	Off
Waveform Freeze	On
Screen Saver	Off
Dual-channel Function/Arbitrary Waveform Generator (GI or GII)^[1]	
GI	Off
GII	Off
Status Display	Off
GI/GII	

Parameter	Factory Settings
Wave	Sine
Output	Off
Freq	1 kHz
Amplitude	500 mV
Offset	0 V
Start Phase	0°
Setting Type	Off
Impedance	HighZ
Cursor	
Mode	Off
Manual	
Select	Y
Source	CH1
AY	100 mV
BY	-100 mV
Vertical Unit	Source
Hori. Unit	s
Region	Main
Track	
AX Source	CH1
BX Source	CH1
AX	-1 μ s
BX	1 μ s
Track	X

Parameter	Factory Settings
XY	
AX	-233.3 mV
BX	100 mV
AY	-233.3 mV
BY	-100 mV
Measure	
Indicator	Off
Storage	
Auto Name	On
Header	On
Save Image	
Format	*.png
Invert	Off
Color	Color
Window	On
Save Wave	
Data Source	Screen
Format	*.csv
Window	On
Save Setup	
File Type	*.stp
Window	On
Load Wave	
File Type	*.wfm

Parameter	Factory Settings
Load Setup	
File Type	*.stp
Disk	
File Type	*.*
Utility	
Sound	Off
PassFail	
Enable	Off
Source	CH1
Operate	Stop
Range	Screen
X Mask	0.24 div
Y Mask	0.48 div
File Type for Load	*.pf
File Type for Save	*.pf
File Name	RigolDS0
Window	Show
Indicator	Off
Aux Output	Off
Output Event	Fail
Polarity	Positive
Pulse	1 μ s
Err Action	None
Record	

Parameter	Factory Settings
Waveform Recording	OFF
Record	
Play	
Record	
Interval	10 ns
Frames	1,000
Max Frames	9175
Beeper	
Current	0
Play	
Mode	
Sequence	
Interval	100 ms
Current	0
Jump To	First 

Parameter	Factory Settings
Save	
Start Frame	1
System	
Power On	Default
Power status	Switch On
AUX Out	TrigOut

Parameter	Factory Settings
Key Locker	Unlocked
HDMI Output	Off
HDMI Resolution	1280x720
SelfCal	
Window	Open
Auto Config	
Peak to Peak	Off
CH	All
Overlay	Off
Coupling	Off
Printer	
Copies	1
Paper Size	A4
Ink Saver	On
Printer	HP/Laserjet
Email	
Attachment	Screen
Quick Settings	
Operation	Save Image
Format	*.png
Invert	Off
Color	Color
Math	
Invert	Off

Parameter	Factory Settings
Expand	GND
Display Label	Off
Library	ADD
Label Editing	ADD
A+B	
Operation	Off
SourceA	CH1
SourceB	CH1
Offset	0 V
Scale	500 mV
A-B	
Operation	Off
SourceA	CH1
SourceB	CH1
Offset	0 V
Scale	500 mV
A×B	
Operation	Off
SourceA	CH1
SourceB	CH1
Offset	0 U
Scale	500 mU
A÷B	
Operation	Off

Parameter	Factory Settings
SourceA	CH1
SourceB	CH1
Offset	0 U
Scale	500 mU
FFT	
Operation	Off
Source	CH1
Offset	0 dBV
Scale	2 dBV
Unit	dBm/dBV
X	Start-End
Start Freq	0 Hz
Stop Freq	10 MHz
Window Function	Hanning
Display Label	Off
Peak Search	Off
Peak Number	5
Threshold	5.5 dB
Excursion	1.8 dB
Table Order	Amp Order
A&&B	
Operation	Off
SourceA	CH1
SourceB	CH1

Parameter	Factory Settings
Wave Size	Medium
Thre.CH1	0 V
Thre.CH2	0 V
Thre.CH3	0 V
Thre.CH4	0 V
Sensitivity	0.3 Div
A B	
Operation	Off
SourceA	CH1
SourceB	CH1
Wave Size	Medium
Thre.CH1	0 V
Thre.CH2	0 V
Thre.CH3	0 V
Thre.CH4	0 V
Sensitivity	0.3 Div
A^B	
Operation	Off
SourceA	CH1
SourceB	CH1
Wave Size	Medium
Thre.CH1	0 V
Thre.CH2	0 V
Thre.CH3	0 V

Parameter	Factory Settings
Thre.CH4	0 V
Sensitivity	0.3 Div
!A	
Operation	Off
SourceA	CH1
Wave Size	Medium
Thre.CH1	0 V
Thre.CH2	0 V
Thre.CH3	0 V
Thre.CH4	0 V
Sensitivity	0.3 Div
Intg	
Operation	Off
Source	CH1
Offset	0 v*s
Scale	500 mv*s
Bias	0
Invert	Off
Diff	
Operation	Off
Source	CH1
Offset	0 v/s
Scale	500 mv/s
Smooth	5

Parameter	Factory Settings
Invert	Off
Sqrt	
Operation	Off
Source	CH1
Offset	0 U
Scale	500 mU
Invert	Off
Lg	
Operation	Off
Source	CH1
Offset	0 U
Scale	500 mU
Invert	Off
Ln	
Operation	Off
Source	CH1
Offset	0 U
Scale	500 mU
Invert	Off
Exp	
Operation	Off
Source	CH1
Offset	0 U
Scale	500 mU

Parameter	Factory Settings
Invert	Off
Abs	
Operation	Off
Source	CH1
Offset	0 U
Scale	500 mV
Invert	Off
Low Pass	
Operation	Off
Source	CH1
Offset	0 V
Scale	500 mV
ω_c	50 MHz
Invert	Off
High Pass	
Operation	Off
Source	CH1
Offset	0 V
Scale	500 mV
ω_c	50 MHz
Invert	Off
Band Pass	
Operation	Off
Source	CH1

Parameter	Factory Settings
Offset	0 V
Scale	500 mV
$\omega c1$	50 MHz
$\omega c2$	100 MHz
Invert	Off
Band Stop	
Operation	Off
Source	CH1
Offset	0 V
Scale	500 mV
$\omega c1$	50 MHz
$\omega c2$	100 MHz
Invert	Off
AX+B	
Operation	Off
Source	CH1
Offset	0 V
Scale	500 mV
A	1
B	0
Invert	Off
Average	
Operation	Off
Source	CH1

Parameter	Factory Settings
Avg Number	2
Offset	0 V
Scale	500 mV
Invert	Off
Logic Analyzer (LA)	
Select	None
D7-D0	Off
D15-D8	Off
Wave Size	Medium
Arrange	D15-D0
Threshold	
D7-D0	1.4 V
D15-D8	1.4 V
Label	
Display	Off
Select	D0
Label	D0
Decode	
Bus Type	Parallel
Bus Status	Off
Format	Hex
Label	On
Event Table	Off

Parameter	Factory Settings
Noise Rejection	Off
CLK	Off
RS232	
Bus Status	Off
Baud	9.6 kbps
Tx	CH1
Threshold	0 V
Rx	OFF
Polarity	
Endian	LSB
Data	8 bits
Stop Bit	1 bit
Parity	None
Package	Off
Separator	0(NUT)
I2C	
Bus Status	Off
CLK	CH1
SCL Thre	0 V
SDA	CH2
SDA Thre	0 V
Exchange	SCL/SDA
R/W	Without
SPI	

Parameter	Factory Settings
Bus Status	Off
Mode	Timeout
Timeout	1 μ s
CLK	CH1
Threshold	0 V
Edge Type	Rising
MISO	CH2
Threshold	0 V
MOSI	OFF
Polarity	
Width	8
Endian	MSB
LIN	
Bus Status	Off
Source	CH1
Threshold	0 V
Baud Rate	19.2 kbps
Parity	Without
Version	Both
CAN	
Bus Status	Off
Source	CH1
Threshold	0 V

Parameter	Factory Settings
Signal	CAN_L
Baud	1 Mbps
Sample Position	50%
FlexRay	
Bus Status	Off
Source	CH1
Threshold	0 V
Channel Selection	A
Baud Rate	10 Mbps
Signal Type	BP
Sample Position	50%
I2S	
Bus Status	Off
SCLK	CH1
Threshold	0 V
SCLK Edge	Rising
WS	CH2
Threshold	0 V
Data	CH3
Threshold	0 V
Word Size	4
Receive	4
Alignment	I2S
WS Low	Left

Parameter	Factory Settings
Endian	MSB
Data Polarity	
1553B	
Bus Status	Off
Data	CH1
Threshold	0 V
Ref	
Current	Ref1
Source	CH1
VScale	1 V
VOffset	0 V
Color	Orange
Label Display	OFF
Library	Default
Label	REF1

NOTE

[1]: This function is only available for model installed with the MSO8000-AWG option.



23 System Utility Function Setting

In the system function setting menu, you can set the parameters for the remote interface and the system-related parameters.

23.1 Remote Interface Configuration

MSO8000A series can communicate with the PC via the USB, LAN, or GPIB (requiring to work with RIGOL's USB-GPIB adaptor) interface. Before using the remote interfaces, configure the corresponding interface according to the introductions in the following section.

23.1.1 LAN Configuration

Before using the LAN bus, use a network cable to connect the oscilloscope to your local area network. The network interface of the oscilloscope is on the rear panel.

Press  > **IO** > **LAN** to open the LAN setting interface, as shown in the following figure. You can view the current network settings and configure the network parameters.

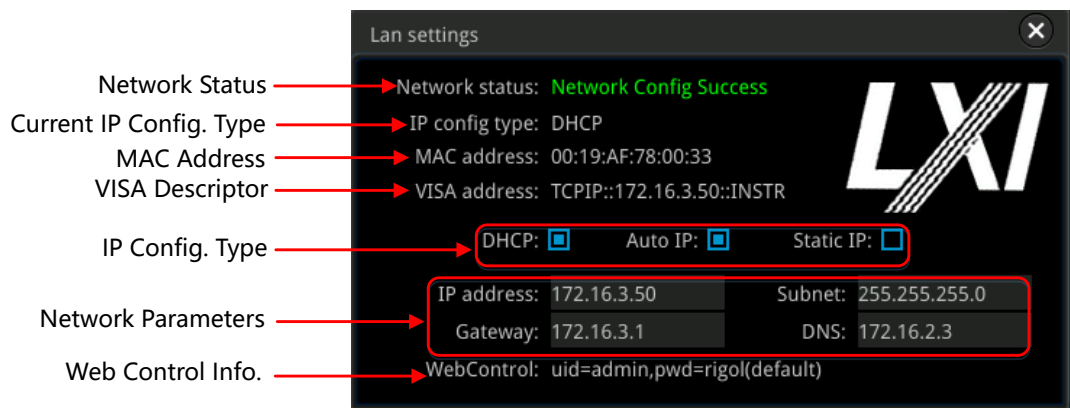

Figure 23.1 Network Connection Setting Interface

Network Status

Different prompts will be displayed according to the current network connection status.



- Network Config Succeeded!
- Acquiring IP...
- IP Conflict!
- Disconnected!

- DHCP Config Failed
- Read Status Fail!
- Connected!
- Invalid IP
- IP lost
- Please wait...



IP Configuration Type

The configuration type of the IP address can be DHCP, Auto IP, or Static IP. In different IP configuration types, the configurations for IP address and other network parameters are different.



DHCP

Press **IP Config Type**, then rotate the multi-function knob  or press **IP Config Type** continuously to select "DHCP". Press down the knob  to select it. You can also enable the touch screen to select it. When DHCP is valid, the DHCP server in the current network will assign the network parameters (e.g. IP address, Subnet, Gateway, and DNS) for the oscilloscope.

Auto IP

Press **IP Config Type**, then rotate the multi-function knob  or press **IP Config Type** continuously to select "Auto IP". Press down the knob  to select it. You can also enable the touch screen to select it. In auto IP mode, the oscilloscope will get the IP address (ranging from 169.254.0.1 to 169.254.255.254) and the subnet mask (255.255.0.0) automatically according to the current network configuration. The "Auto IP" works only when "DHCP" is not selected or connection is failed.

Static IP

Press **IP Config Type**, then rotate the multi-function knob  or press **IP Config Type** continuously to select "Static IP". Press down the knob  to select it. You can also enable the touch screen to select it. Note: when this type is valid, you need to disable DHCP and Auto IP manually. At this time, the "IP", "SubMask", "Gateway", and "DNS" menu items are added. Thus, you can self-define the network parameters (e.g. IP address) of the oscilloscope.

1. Set the IP Address

The format of the IP address is nnn.nnn.nnn.nnn. The range of the first segment (nnn) of the address is from 0 to 255 (except 127); wherein, the valid range is from 0 to 223. The range for the other three segments is from 0 to 255. You are recommended to ask your network administrator for an IP address available.

Press **IP**, and then the numeric keypad is displayed. Input the desired IP address with the numeric keypad. This setting will be saved to the non-volatile memory; if "Power On" is set to "Last", then DHCP and Auto IP are disabled at the next power-on. The oscilloscope will load the preset IP address automatically.

2. Set the Subnet Mask

The format of the subnet mask is nnn.nnn.nnn.nnn. Wherein, the range of "nnn" is from 0 to 255. You are recommended to ask your network administrator for a subnet mask available.

Press **SubMask**, and then the numeric keypad is displayed. Input the desired subnet mask with the numeric keypad. This setting will be saved in the non-volatile memory; if "Power On" is set to "Last", then DHCP and Auto IP are disabled at the next power-on. The oscilloscope will load the preset subnet mask automatically.

3. Set the Gateway

You can set this parameter in Static IP mode.

The format of the gateway is nnn.nnn.nnn.nnn. The range of the first segment (nnn) is from 0 to 223 (except 127), and the range for the other three segments is from 0 to 255. You are recommended to ask your network administrator for a gate address available.

Press **Gateway**, and then the numeric keypad is displayed. Input the desired subnet mask with the numeric keypad. This setting will be saved in the non-volatile memory; if "Power On" is set to "Last", then DHCP and Auto IP are disabled at the next power-on. The instrument will load the preset gateway automatically.

4. Set the DNS

You can set this parameter in Static IP mode.

The format of the DNS address is "nnn.nnn.nnn.nnn". The range for the first segment (nnn) of the address is from 0 to 223 (except 127); and the range for the other three segments is from 0 to 255. You are recommended to ask your network administrator for an address available.

Press **DNS**, and then the numeric keypad is displayed. Input the desired DNS address with the numeric keypad. Generally, you do not need to set the DNS, therefore this parameter setting can be ignored.

TIP

- When the three IP configuration types are all turned on, the priority of the parameter configuration from high to low is "DHCP", "Auto IP", and "Static IP".
- The three IP configuration types cannot be all turned off at the same time.

Apply the Network Parameter Setting

Press **Apply** to validate the current network parameter setting.

MACAddress



For each oscilloscope, the MAC address is unique. When assigning the IP address for the oscilloscope, the system uses the MAC address to identify the instrument.

VISA Address

Displays the VISA address currently used by the oscilloscope.

Web Control Information

Displays the user name and password for network configuration of the oscilloscope through the LXI webpage.



TIP

Connect the oscilloscope to the local area network. Start up Ultra Sigma, and then right-click the resource name and select "LXI-Web" to load the LXI webpage. You can also directly input the IP address of the oscilloscope in the address bar of the PC browser to load the LXI webpage.

23.1.2 To Set mDNS



Press **mDNS** continuously to enable or disable the multicast Domain Name System (mDNS). This system is used to provide the function of DNS server for service discovery in a small network without a DNS server.

23.1.3 To Set the Host Name

Press **Host Name** to input the host name. For the host name input method, refer to relevant descriptions in "*To Create a Folder*".

23.1.4 To Set the GPIB address

Before using the GPIB interface, use the USB-GPIB interface converter (an option that requires to be ordered separately) to extend the GPIB interface, and then use the GPIB cable to connect the instrument to the PC.

Press  > **IO** > **GPIB**, then rotate the multifunction knob  directly to set the GPIB address or use the pop-up numeric keypad to input the GPIB address. Its settable range is from 1 to 30. By default, it is 1.

23.1.5 To Set HDMI

Sets the status and parameters of the HDMI video output interface on the rear panel. Note that only when the HDMI interface is available, can this menu be enabled.

Press **HDMI** to enter the HDMI setting menu.

- Press **Output** continuously to enable or disable the video output.

- ON: You can connect the instrument to an external display via this interface to better observe the waveform display clearly from the external display.
- OFF: disables the interface.
- Press **Resolution** to set the screen resolution. The available resolution includes 640x480, 720x480, and 1280x720.

23.1.6 USB Connection



The oscilloscope can communicate with a PC via the USB DEVICE interface on the rear panel. No parameters are required to be configured.

23.2 System-related

23.2.1 Beeper



When the beeper is enabled, you can hear the sound of the beeper when you perform the following operations:

- Press a key or a menu key on front panel
- Enable the touch screen
- When a prompt message is displayed

Press  and then press **Beeper** continuously to select "ON" () or "OFF" (). By default, it is OFF.

23.2.2 Language

This oscilloscope supports menus in multiple languages. Both Chinese and English are available for the display of the help information, prompt messages, and interface.

Press  > **Language**, then rotate the multifunction knob  to select the desired language, and then press down the knob to select it. You can also press **Language** continuously to select the language or enable the touch screen to tap the desired language and select it.

23.2.3 System Information

Press  > **System** > **About** to view the system information of the oscilloscope, including the manufacturer, product model and serial number, firmware etc., etc.

You can also view the system information of the oscilloscope in the "Help" system menu.

23.2.4 Power On

You can set the system configuration to be recalled when the oscilloscope is powered on again after power-off.

Press  > **System**, and then press Power On continuously to select "Last" or "Default". By default, it is "Default".

- Last: returns to the setting of the system at last power-off.
- Default: returns to the factory setting of the system.

23.2.5 Power Status

Use the power line to connect the oscilloscope to the AC power and then turn on the power switch to power on the instrument. You can set the power status after it is powered on.

Press  > **System**, and then press **Power status** to select "Switch On" or "Switch Off".

- Switch off: after the oscilloscope is connected to power, you need to press the Power key on the front panel to power on the instrument.
- Switch On: After the the oscilloscope is connected to power, it will be powered on immediately.

NOTE

Whatever the option you select, you still can press the Power key on the front panel to turn on or off the instrument.

23.2.6 Aux Output

Users can set the type of the signal output from the **[TRIG OUT]** connector on the rear panel.

Press  > **System**, and then press **AUX Out** continuously to select "TrigOut" or "PassFail".

- **TrigOut:**

After this type is selected, at each trigger (hardware trigger), the oscilloscope outputs a signal from the **[TRIG OUT]** connector on the rear panel that can



reflect the current capture rate of the oscilloscope. If this signal is connected to a waveform display device to measure the frequency, the found measurement result is the same as the current capture rate.

- **PassFail:**

When this type is selected, the instrument can output a positive or negative pulse via the **[TRIG OUT]** connector when a successful or failed event is detected. Refer to descriptions in *To Set the Output Form of the Test Results*. When you enable the Aux output, the **AUX Out** menu is automatically set to "PassFail". When the **AUX Out** menu is set to "TrigOut", then in the pass/fail test menu, the Aux Out function is automatically disabled.

23.2.7 Ref Clock

This oscilloscope can output the internal 10 MHz sample clock signal from the rear-panel **[10M In/Out]** connector, and it can also receive the external 10 MHz clock signal from the connector. This function can be used to synchronize multiple oscilloscopes.

Press  > **System** > **Ref Clock**, then rotate the multifunction knob  to select the desired clock type. Press down the knob to select it. You can also press **Ref Clock** continuously or enable the touch screen to select it.

- OFF: disables the reference clock function.
- Clock Output. The instrument outputs the internal 10 MHz clock signal from the rear-panel **[10M In/Out]** connector.
- Clock Input. The oscilloscope receives the external 10 MHz clock signal from the rear-panel **[10M In/Out]** connector.

23.2.8 Help Menu

Press  > **System** > **Help**, and then the "Help" menu is displayed on the screen.

You can also use the touch screen function, tap the navigation icon  at the lower-left corner of the touch screen to enable the function navigation. Tap the "Help" icon, and then the "Help" menu is displayed on the screen.

- Press **About** to view the system information of the oscilloscope.
- Press **Content** to enter the built-in help system.
- Press **Option list** to view the name of the installed option and other detailed information about the option from the option list.

- Press **Option install** to install the desired option. For detailed installation procedures, refer to descriptions in "*To View the Option Information and the Option Installation*".
- Press **Online upgrade** to perform online upgrading for the system software. For the method of online upgrade, refer to "*Rear Panel Overview*".

NOTE

If you connect the oscilloscope to the network via the LAN interface, every Monday you power on the instrument, the oscilloscope will check whether the latest version of the upgrade software is available on the RIGOL official website (www.rigol.com). If yes, a red spot appears at the upper-left corner of the **Online upgrade** menu, prompting you that the latest upgrade version is available and you can perform online upgrade.

- Press **Local upgrade** or enable the touch screen to tap "Local upgrade", then a dialog box "Upgrade system firmware?" is displayed. Tap OK to perform local upgrading for the system software (required to insert the USB disk that contains the software installation package); tap Cancel to cancel local upgrading operation.

23.2.9 SelfCal

The self-calibration program can quickly make the oscilloscope to work in an optimal state to get the precise measurement results. You can perform self-calibration at any time, especially when the changes of the ambient temperature reach or above 5°C. Make sure that the oscilloscope has been warmed up or operating for more than 30 minutes before the self-calibration.

Disconnect all the input channels, and then press  > **System** > **SelfCal**, and the self-calibration interface is displayed, as shown in the following figure.

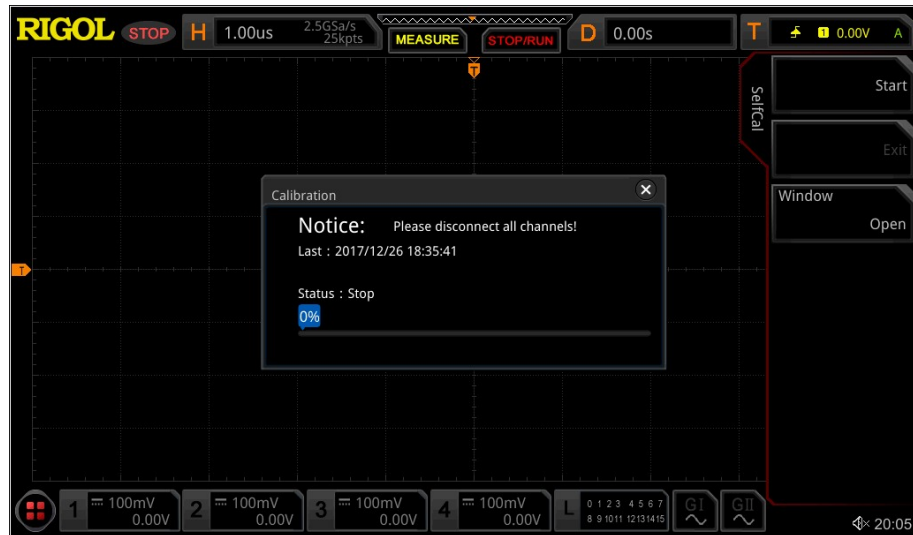



Figure 23.2 SelfCal



- Press **Start**, and then the oscilloscope will start to execute the self-calibration program.
- After starting the self-calibration program, the **Exit** menu is no longer grayed out and is enabled. Press **Exit** to cancel self-calibration operation at any time.
- Press **Window** continuously to open or close the self-calibration information window. You can also enable the touch screen to tap the icon  at the right-upper corner of the self-calibration information window to close it.

**NOTE**

During the self-calibration process, most of the keys are disabled.

23.2.10 Auto Config

You can set the parameters for the  menu.

Press  > **More** > **Auto Config**, and set the parameters for the  key. For detailed settings, refer to descriptions in "*Quick Measurement after AUTO*".

23.2.11 Print Setting

Connect the oscilloscope to the local area network via the network cable. This series supports printing the whole screen to the network printer. You can connect the oscilloscope to the printer directly via the **[USB DEVICE]** interface on the rear panel.

Then, you can set the print parameter on the oscilloscope to control the printer to output the corresponding picture.

Press  > **More** > **Printer** to enter the printer setting menu. After the printer is properly connected, you need to set the network configurations for printing, and then set the printer parameters.



1. Network Configuration

Press **Setting** to enter the network configuration menu.

- Select the printer

Press **Printer**, then rotate the multifunction knob  to select the printer model. Press down the knob to select it. You can also press **Printer** continuously or enable the touch screen to select it.

- Set the IP address

Press **Printer IP**, then rotate the multifunction knob  to set each segment of the IP address for the printer. Press down the knob to confirm the setting for each segment of the address. At this time, the cursor moves to the next segment automatically. You can also press **Printer IP** continuously to switch the segment position, and then rotate the multifunction knob  to set it. You can also enable the touch screen to switch the address segment.

- Set the port

Press **Printer Port**, then directly rotate the multifunction knob  to adjust the port number or use the pop-up numeric keypad to input the port number.

- Network test

Press **Test** to test whether the network is connected. If connected, a prompt message "Network connected" is displayed.

- Print test page

Press **Print test page** to carry out the print test. The print progress is also displayed on the screen.

2. Sets the Print Parameters

- **Print**

After the printer parameters are set, press **Print** to execute the print operation.

- **Copies**

Press **Copies**, then rotate the multifunction knob  to set the number of copies to be printed or use the pop-up numeric keypad to set it. The settable range is from 1 to 99.

- **Paper Size**

The **Paper Size** menu is grayed out and disabled. The paper size only supported by the oscilloscope is A4.

- **Ink Saver**

Press **Ink Saver** continuously to enable or disable the ink saver setting. If disabled, you need to set **Color**. Press **Color** continuously to select "Gray" or "Color".

23.2.12 Email

This oscilloscope supports sending files via emails. Press  > **More Email** to enter the email setting menu.

1. Set the Email Server

Press **Settings** to enter the email server login setting menu. The following window is displayed. After the setting, enable the touch screen to tap **OK** to complete the server login. To cancel login, tap **Cancel** to exit or tap the icon  at the upper-right corner of the window to exit. If you exit the server setting window, you can press **SMTP**, **Port**, **UserName**, or **Password** to reopen the window.

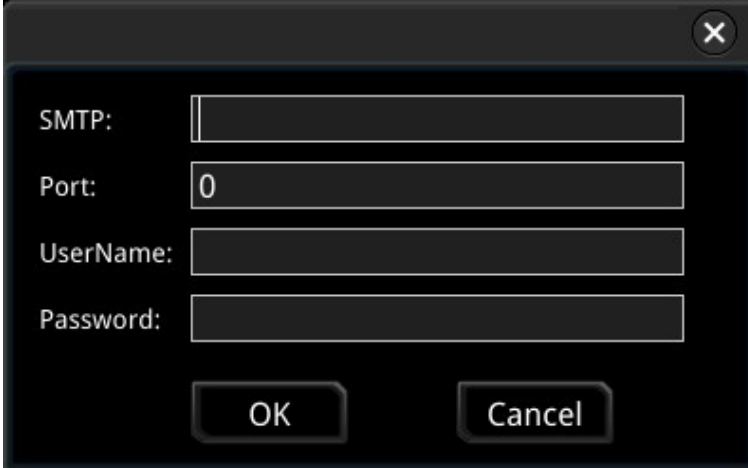

- **Set SMTP**

Press **SMTP** to set the mail transmission protocol. For detailed settings of mail transmission protocol, refer to descriptions in "*To Create a Folder*".

- **Set the port**

Press **Port** to set the protocol port with the pop-up numeric keypad. Its range is from 1 to 65,535.

- **Set the user name**

Press **UserName** to set the user name of the server. For detailed setting methods for the user name, refer to descriptions in "*To Create a Folder*".

- **Set the password**

Press **PassWord** to set the password of the server. For detailed setting methods for the password, refer to descriptions in "*To Create a Folder*".

- **Email test**



Press **Test** to test whether the e-mail server is properly set.

- **Restore default settings** Press **Default** to restore the settings of receiver and mail settings to defaults.

2. Set the Receiver

Press **Receiver** to display the receiver input interface, and you can edit the email address of the receiver. For detailed input methods of the receiver email address, refer to descriptions in "*To Create a Folder*".

3. Upload the Attachment

Press **Attachment**, then rotate the multifunction knob  to upload the attachment type, and then press down the knob  to select the type. You can also press **Attachment** continuously to select or enable the touch screen to tap the attachment. The available attachments include "Screen", "Setup", and "Other". If you select "Other", you also need to press **File Select** to select the file to be uploaded.

4. Send the Mail

Press **Send Mail** to send the edited email to the receiver.

23.2.13 Key Locker



You can set whether to lock the front-panel keys.

Press  > **More** > **Key Locker** to select "Locked" or "Unlocked".

- Locked: indicates that all menu keys of the oscilloscope (except the **Touch Lock** key) are locked.
- Unlocked: unlocks the front-panel keys.

23.2.14 Quick Operation

You can set the shortcut functions for the  key on the front panel.



Press  > **More** > **Quick settings** to enter the quick key operation menu. You can also enable the touch screen and then tap the function navigation icon  at the lower-left corner of the screen to open the function navigation. Then, tap the "Quick" icon to open the quick key setting menu.

The Quick key includes the following five shortcut functions:

1. Image Saving

When the Quick shortcut key is set to "Save Image", press  on the front panel to capture the screen.

- Operation type

Press **Operation** and then rotate the multifunction knob  to select "Save Image". Press down the knob  to select it. You can also press **Operation** continuously or enable the touch screen to select the type.

- Image format

Press **Format**, and then rotate the multifunction knob  to select the image format. You can also press **Format** continuously or enable the touch screen to select the image format. The available image formats include "*.png", "*.bmp", "*.jpg", and "*.tif".

- Invert

Press **Invert** continuously to enable or disable the invert function.



- Color

Press **Color** continuously to set the color of the saved image to "Color" or "Gray".

2. Waveform Saving

When the Quick shortcut key is set to "Save Wave", press  on the front panel to save the waveform.

- Operation type

Press **Operation** and then rotate the multifunction knob  to select "Save Wave". Press down the knob  to select it. You can also press **Operation** continuously or enable the touch screen to select the type.

- **Data source**

Press **Data Source** continuously to select "Memory" or "Screen" as the source of the saved waveform.

- **Format**



Press **Format** and then rotate the multifunction knob  to select the waveform format. Press down the knob to select it. You can also press **Format** continuously or enable the touch screen to select it. When the data source is "Memory", the available formats are "*.bin" and "*.csv". When the data source is "Screen", the available formats are "*.bin", "*.csv", and "*.wfm".

- **Storage channel**

If the data source is "Memory", you need to set the storage channel. Press **Channel**, and rotate the multifunction knob  to select the storage channel. You can also press **Channel** continuously or enable the touch screen to select the channel. The available storage channels include CH1-CH4.

3. Setup Saving



When the Quick shortcut key is set to "Save Setup", press  on the front panel to save the setup of the oscilloscope.

Press **Operation** and then rotate the multifunction knob  to select "Save Setup". Press down the knob  to select it. You can also press **Operation** continuously or enable the touch screen to select the type. You do not need to set relevant parameters.

4. All Measurement

When the Quick shortcut key is set to "All Measure", press  on the front panel to measure all the parameters of the current measurement source.

- **Operation type**

Press **Operation** and then rotate the multifunction knob  to select "All Measure". Press down the knob  to select it. You can also press **Operation** continuously or enable the touch screen to select the type.



- **All Measurement** Press **All Measure**, then rotate the multifunction knob  to select the desired measurement channel.

You can also press **All Measure** continuously to select or enable the touch screen to tap the desired channel. The available measurement channels include OFF and CH1-CH4.

5. Statistics Reset

When the Quick shortcut key is set to "Stat Reset", press  on the front panel to make statistics reset of measurement or pass/fail test reset.

- **Operation type**



Press **Operation** and then rotate the multifunction knob  to select "Stat Reset". Press down the knob  to select it. You can also press **Operation** continuously or enable the touch screen to select the type.

- **Statistics Reset**

Press **Stat Reset** and then rotate the multifunction knob  to select the function that requires statistics reset. Press down the knob to select it. You can also press **Stat Reset** continuously to select among the options, or enable the touch screen to tap the desired option. You can select "Measure" or "PassFail".



6. Print

When the Quick shortcut key is set to "Print", press  on the front panel to print the screen image of the oscilloscope.

Press **Operation** and then rotate the multifunction knob  to select "Print". Press down the knob  to select it. You can also press **Operation** continuously or enable the touch screen to select the type.



7. Email

When the Quick shortcut key is set to "Email", press  on the front panel to send the file through email.

Press **Operation** and then rotate the multifunction knob  to select "Email". Press down the knob  to select it. You can also press **Operation** continuously or enable the touch screen to select the type.

8. Record



When the Quick shortcut key is set to "Record", press  on the front panel to record the waveform.

Press **Operation** and then rotate the multifunction knob  to select "Record". Press down the knob  to select it. You can also press **Operation** continuously or enable the touch screen to select the type.



9. Save Group

When the Quick shortcut key is set to "Save Group", press  on the front panel to save group.

- Operation type



Press **Operation** and then rotate the multifunction knob  to select "Save Group". Press down the knob  to select it. You can also press **Operation** continuously or enable the touch screen to select the type.

- Group

Set the Group parameter: press **Group** and then rotate the multifunction knob  to select "Save Image", "Save Wave", or "Save Setup". Press down the knob to select the desired one. You can also press **Group** continuously to select it. You can also directly enable the touch screen and tap to select it. You can select any or all of the three items. The sign  indicates that the item has been selected, and  indicates that the item has not been selected.

23.2.15 Screen Saver

When the oscilloscope enters the idle state and holds for a certain period of time, the screen saver program will be enabled.

Press **More** > **Screen Saver** to enter the screen saver setting menu. Press **Screen Saver**, then rotate the multifunction knob  to select the screen saver type, and then press down the knob  to select it. You can also press **Screen Saver** continuously or enable the touch screen to select it. The available screen saver types include "Off", "Picture", and "Text". The screen saver program is disabled by default.

1. Select the Screen Saver

- If you select "Off" under Screen Saver, it indicates that the screen saver is disabled.

- If you select "Picture" under Screen Saver, press **Select Picture** to select the file. The available file types include "*.png", "*.bmp", "*.jpg", and "*.tif".
- If you select "Text" under Screen Saver, press **Text**, and then the filename input interface is displayed, e.g. inputting "RIGOL Scope". For details, refer to descriptions in "*To Create a Folder*".

2. Set the Wait Time

Press **Time to Start**, then directly rotate the multifunction knob  or use the pop-up numeric keypad to input the screen saver time. The range available is from 1 min to 999 min.

3. Preview

Press **Preview** to view the set screen saver.

4. Default

Press **Default** to restore the screen saver to the default settings.

23.2.16 Self-check

The oscilloscope supports a variety of self-check functions, including keyboard check, screen check, and touch screen check.

Press  > **More** > **More** > **Self Check** to enter the self-check menu.

1. Key Test

Press **Key Test** to enter the keyboard test interface (virtual keypads of the front panel). At this time, you can press the keys on the front panel to check whether the virtual keys are highlighted. If yes, it indicates that the keys work normally; if no, it indicates that there's something wrong with the keys. If the virtual key is not

illuminated, the key may fail to work. Press  for three consecutive times to exit the key test interface.

2. Screen Test

Press **Screen Test** to enter the screen test interface and check whether the



defective pixel exists. There are 15 screen test interfaces. Press  to switch to

the next screen test interface. Press  for three consecutive times to exit the screen test interface.

3. Touch Test

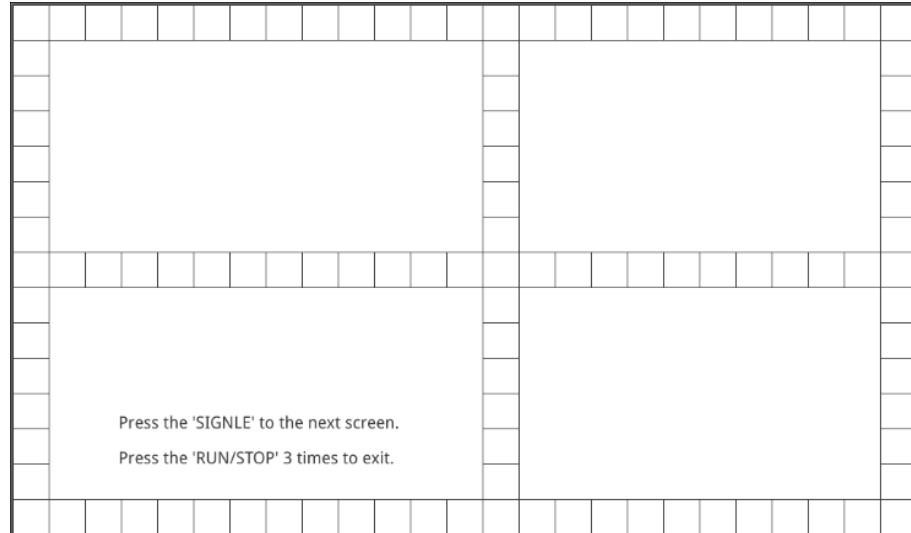
Press **Touch Test** to enter the touch screen test interface first, as shown in the figure below. Slide with your finger on the screen. If there is a line displaying at the empty area where you slide on the screen and the box that you tap turns out to be filled with green background, it indicates that the touch function of this area is normal.



Then press  to switch to the next touch screen test interface, as shown in the figure below. At this time, you can pinch or stretch the icons on RIGOL to zoom out or zoom in icons to check whether the gestures work normally. Press  for three consecutive times to exit the touch test interface.







23.2.17 System Time

The system time is displayed at the lower-right side of the screen in "hh:mm (hour:minute)" format. When you save the waveform, the output file will contain the time information.

Press  > **More** > **More** > **Time** to open the time setting menu.

1. Set the System Time

- a. Press **Show Time** continuously to open or close the system time interface.
- b. Set "year": Press **Year**, rotate the multifunction knob  directly to set it or use the pop-up numeric keypad to input the numeric value to set it.
- c. Set "month": Press **Month**, rotate the multifunction knob  directly to set it or use the pop-up numeric keypad to input the numeric value to set it.
- d. Set "day": Press **Day**, rotate the multifunction knob  directly to set it or use the pop-up numeric keypad to input the numeric value to set it.
- e. Set "hour": Press **Hour**, rotate the multifunction knob  directly to set it or use the pop-up numeric keypad to input the numeric value to set it.
- f. Set "minute": Press **Minute**, rotate the multifunction knob  directly to set it or use the pop-up numeric keypad to input the numeric value to set it.

The setting range of each item of the system time conforms to the convention.



- Year: 2017 to 2099
- Month: 01 to 12
- Date: 01 to 31 (28, 29, or 30)
- Hour: 00 to 23
- Minute: 00 to 59
- Second: 00 to 59

2. Apply the Currently Set System Time

Press **Apply** to validate the current settings. The time at the lower-right side of the screen will be updated.

23.2.18 Default Option

Used for configuring the  key.

Press  > **More** > **More** > **Default Option** to enter the default option menu. Press **Keep Impedance** to enable or disable the impedance keep function. If you select ON, after you press , the impedance value that you set remains unchanged and other settings will be restored to the default settings. If you select OFF, after you press , the impedance value will be restored to its default value 1 MΩ.

24 Remote Control

The following ways of remote control are supported:

- **User-defined Programming**

Users can program and control the instrument by using the SCPI (Standard Commands for Programmable Instruments) commands. For details about the SCPI commands and programming, refer to *Programming Guide* of this product series.

- **PC software**

Users can use the PC software to send commands to control the instrument remotely. RIGOL Ultra Sigma is recommended. You can download the software from RIGOL official website (<http://www.rigol.com>).

Operation Procedures:

- Set up communication between the instrument and PC.
- Run Ultra Sigma and search for the instrument resource.
- Open the remote command control panel to send commands.

- **Web Control**

This instrument supports Web Control. Connect the instrument to the network, then input the IP address of the instrument into the address bar of the browser of your computer. The web control interface is displayed. Click Web Control to enter the web control page. Then you can view the display of the real-time interface of the instrument. Through the Web Control method, you can migrate the device control to the control terminals (e.g. PC, Mobile, iPad, and other smart terminals) to realize remote control of the instrument. When you first log in to the Web Control, the user name is "admin" and password is "rigol".

- **VNC Control**

This instrument supports VNC control. The VNC client (VNC Viewer) can be downloaded from its official website. When the VNC client is installed and your instrument is connected to the network, open the VNC Viewer client and input the IP address of the instrument into the VNC address bar. Then, you can view the screen of the instrument and operate the instrument remotely.

This instrument can be connected to the PC via the USB, LAN, or GPIB interface to set up communication and realize remote control through the PC. The remote control can be realized by using SCPI (Standard Commands for Programmable Instruments) commands.

This chapter will illustrate how to use the RIGOL Ultra Sigma software to remotely control the instrument via various interfaces. Note: When communicating with the PC

via GPIB, the instrument does not support large data transmission operation such as screen shot and waveform reading.



CAUTION

Before setting up communication, please turn off the instrument to avoid causing damage to the communication interfaces.

24.1 Remote Control via USB

1. Connect the device

Use the USB cable to connect the rear-panel USB DEVICE interface of the instrument to the USB HOST interface of the PC.

2. Search for the device resource

Start up Ultra Sigma and the software will automatically search for the resource currently connected to the PC via the USB interface. You can also click **USB-TMC** to search for the resource.

3. View the device resource

The resources found will appear under the "RIGOL Online Resource" directory, and the model number and USB interface information of the instrument will also be displayed.

4. Control the instrument remotely

Right-click the device resource name and select "SCPI Panel Control" to open the remotely command control panel. Then you can send commands and read data through the panel. For details about the SCPI commands and programming, refer to the Programming Guide of this instrument.

24.2 Remote Control via LAN

1. Connect the device

Use the network cable to connect the instrument to your local area network (LAN).

2. Configure network parameters

Configure the network parameters of the instrument according to "*LAN Configuration*".

3. Search for Search device resource

Start up Ultra Sigma and click **LAN** to open the panel as shown in the figure below. Click **Search** and the software searches for the instrument resources currently connected to the LAN and the resources found are displayed at the right section of the window as shown in the figure below. Click **OK** to add it.

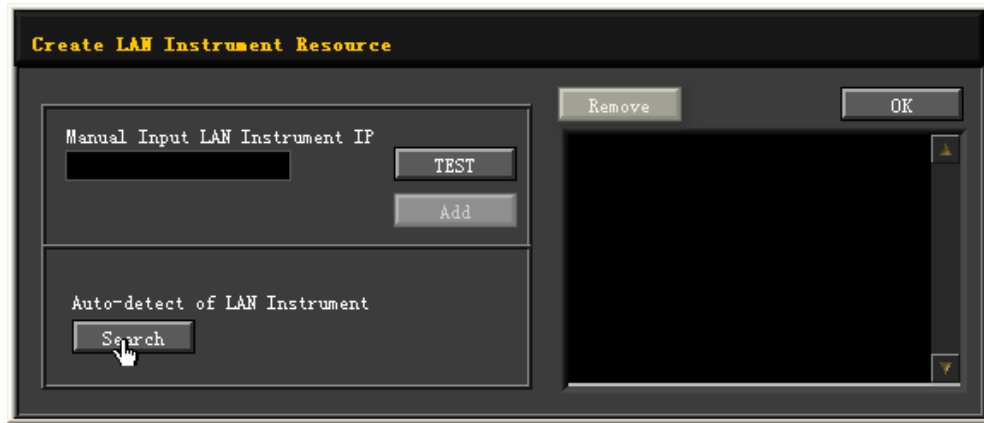

Besides, you can input the IP address of the instrument manually into the text field under "Manual Input LAN Instrument IP", then click **TEST**. If the instrument passes the test, click **ADD** to add the instrument to the LAN instrument resource list in the right section; if the instrument fails the test, please check whether the IP address that you input is correct, or use the auto search method to add the instrument resource.

4. View the device resource

The resources found will appear under the "RIGOL Online Resource" directory.

5. Control the instrument remotely

Right-click the device resource name and select "SCPI Panel Control" to open the remotely command control panel. Then you can send commands and read data through the panel.

6. Load LXI webpage

As this instrument conforms to LXI CORE 2011 DEVICE standards, you can load LXI web page through Ultra Sigma (right-click the instrument resource name and select "LXI-Web"). Various important information about the instrument (including the model, manufacturer, serial number, description, MAC address, and IP address) will be displayed on the web page. You can also directly input the IP address of the instrument in the address bar of the PC browser to load the LXI web page.

24.3 Remote Control via GPIB

1. Connect the device

Use the USB-GPIB interface converter to extend the GPIB interface for the instrument, and then use the GPIB cable to connect the instrument to the PC to realize remote control.

2. Install the driver of GPIB card

Correctly install the driver of the GPIB card which has been connected to the PC.

3. Set the GPIB address

Click or tap the Notification Area at the lower-right corner of the screen, then the **Utility** menu is displayed. Click or tap **IO**, and then click or tap the input field of **GPIB** to input the GPIB address with the pop-up numeric keypad.

4. Search for the device resource

Start Ultra Sigma, and then click **GPIB**. A window is displayed as shown in *Figure 24.1*. Click **Search** and the software searches for the instrument resource currently connected to the PC via the GPIB interface. The resource found is displayed at the right side of the window, as shown in *Figure 24.2*. Click **OK** to add it.



Figure 24.1 Search for the Available Device



Figure 24.2 Confirm the Available Device

5. View the device resource

Click **OK** to go back to the main interface of Ultra Sigma. The searched instrument resource will be displayed under the directory of "RIGOL Online Resource".

6. Control the instrument remotely

Right-click the device resource name. In the displayed menu, select "SCPI Panel Control" to open the programming command control panel. Then you can input commands to send commands and read data.

25 Troubleshooting

1. When I power on the instrument, the instrument stays black and does not display anything.

- a. Check whether the power supply has been connected correctly.
- b. Check whether the power key is really pressed.
- c. Check whether the fuse is blown. If you need to replace the fuse, use only the specified fuse that conforms to the product.
- d. Restart the instrument after finishing the above inspections.
- e. If the problem still persists, please contact RIGOL.

2. The USB storage device cannot be recognized.

- a. Check whether the USB storage device can work normally when connected to other instruments or PC.
- b. Make sure that the USB storage device is FAT32 format and flash type. The instrument doesn't support hardware USB storage device.
- c. After restarting the instrument, insert the USB storage device again to check whether it can work normally.
- d. If the USB storage device still cannot work normally, please contact RIGOL.

3. How do you set the amplitude of the waveform in dBm?

- a. Select the desired channel.
- b. In the channel setting interface, check whether HighZ under **OutputSet** is set to "On". If yes, you cannot set the amplitude of the waveform in dBm at this time. Select "Off" to disable the HighZ, and use the numeric keypad, the arrow keys, and knob to set it to a proper value.
- c. Select the desired waveform, tap the Amplitude menu label, and then input the desired value by using the numeric keypad. Then select the unit "dBm" from the pop-up menu.

4. The touch-enabled operation does not work.

- a. Check whether you have locked the touch screen. If yes, unlock the touch screen.
- b. Check whether the screen or your finger is stained with oil or sweat. If yes, please clean the screen or dry your hands.

- c. Check whether there is a strong magnetic field around the instrument. If the instrument is close to the strong magnetic field (e.g. a magnet), please move the instrument away from the magnet field.
- d. If the problem still persists, please contact RIGOL.

26 Appendix

26.1 Appendix A: Options and Accessories

Order Information	Order No.
Model	
2 GHz, 10 GSa/s, 500 Mpts, 4+16 CH MSO	MSO8204A
1.5 GHz, 10 GSa/s, 500 Mpts, 4+16 CH MSO	MSO8154A
750 MHz, 10 GSa/s, 500 Mpts, 4+16 CH MSO	MSO8074A
Standard Accessories	
USB Cable	CB-USBA-USBB-FF-150
Passive HighZ Probe x4 (500 MHz)	RP3500A
MSO8204A: Passive Low-impedance Probe x2 (1.5 GHz)	RP6150A
MSO8154A: Passive Low-impedance Probe x2 (1.5 GHz)	
Front Protective Cover	MSO8000-FPC
Power Cord Conforming to the Standard of the Destination Country	-
Recommended Accessories	
16-channel Logic Analyzer Probe	RPL2316
Active Single-ended/Differential Probe (2.5 GHz BW)	PVA7250
Active Differential Probe (1.5 GHz BW)	RP7150
Active Differential Probe (800 MHz BW)	RP7080
Active Single-ended Probe (1.5 GHz BW)	RP7150S
Active Single-ended Probe (800 MHz BW)	RP7080S
Rack Mount Kit	RM6041
Near-field Probe	NFP-3
Power Analysis Phase Difference Correction Jig	RPA246
Digital Oscilloscope Demonstration Plate	DK-DS6000
USB-GPIB Adaptor	USB-GPIB
Bandwidth Upgrade Option	
Bandwidth upgrades from 750 MHz to 1.5 GHz	MSO8000A-BW7T15
Bandwidth upgrades from 750 GHz to 2 GHz	MSO8000A-BW7T20
Bandwidth upgrades from 1.5 GHz to 2 GHz	MSO8000A-BW15T20
Single-Channel 3 GHz Bandwidth Upgrade Option	MSO8000A-BW20T30
Bundle Option	
Function and application bundle option, including MSO8000-COMP, MSO8000-EMBD, MSO8000-AUTO, MSO8000-FLEX, MSO8000-AUDIO, MSO8000-AERO, MSO8000-AWG, MSO8000-JITTER and MSO8000-PWR	MSO8000-BND
Serial Protocol Analysis Option	

Order Information	Order No.
PC Serial Bus Trigger and Analysis (RS232/UART)	MSO8000-COMP
Embedded Serial Bus Trigger and Analysis (I2C, SPI)	MSO8000-EMBD
Auto serial bus trigger and analysis (CAN, CAN-FD, LIN)	MSO8000-AUTO
FlexRay serial bus trigger and analysis (FlexRay)	MSO8000-FLEX
Audio Serial Bus Trigger and Analysis (I2S)	MSO8000-AUDIO
MIL-STD-1553 Bus Trigger and Analysis (MIL-STD-1553)	MSO8000-AERO
Measurement Application Option	
Dual-channel 25 MHz Arbitrary Waveform Generator	MSO8000-AWG
Built-in Power Analysis (Required to Purchase the RPA246 Phase Deviation Correction Jig)	MSO8000-PWR
Real-time Eye Diagram and Jitter Analysis (Option)	MSO8000-JITTER

**NOTE**

For all the accessories and options, please contact the local office of RIGOL.

26.2 Appendix B: Warranty

RIGOL TECHNOLOGIES CO., LTD. (hereinafter referred to as RIGOL) warrants that the product mainframe and product accessories will be free from defects in materials and workmanship within the warranty period. If a product proves defective within the warranty period, RIGOL guarantees free replacement or repair for the defective product.

To get repair service, please contact your nearest RIGOL sales or service office.

There is no other warranty, expressed or implied, except such as is expressly set forth herein or other applicable warranty card. There is no implied warranty of merchantability or fitness for a particular purpose. Under no circumstances shall RIGOL be liable for any consequential, indirect, ensuing, or special damages for any breach of warranty in any case.

Index

Special Characters

-Duty [174](#)

-SlewRate [180](#)

-Width [174](#)

+Duty [174](#)

+SlewRate [180](#)

+Width [174](#)

A

AM [VIII, 316](#)

Area [181](#)

Auto IP [360](#)

B

Blackman-Harris [146](#)

Burst [VIII, 321](#)

C

Channel Delay [II, 57](#)

D

Delay [176](#)

Domain Name Server [361](#)

Dots [297](#)

Duty Cycle [304](#)

E

ECG [VIII, 307](#)

End Keep [320](#)

EOF error [242](#)

Exp.Fall [VIII, 307](#)

Exp.Rise [VIII, 306](#)

F

Fall Time [174](#)

Falling Edge Count [176](#)

Flattop [147](#)

FM [VIII, 317](#)

Frequency [174](#)

Frequency Deviation [318](#)

FSK [VIII, 318](#)

G

Gauss [VIII, 308](#)

H

Hamming [146](#)

Hanning [146](#)

Haversine [VIII, 310](#)

Horizontal time base [II, 60](#)

I

I2S Trigger [IV, 126](#)

Idle Time [109](#)

Impedance [303](#)

IP Address [360](#)

L

Lorentz [VIII, 309](#)

M

MAC [361](#)

Modulating Waveform [317, 318](#)

Modulation Depth [317](#)

Modulation Frequency [317, 318](#)

N

Negative Pulse Count [175](#)

O

Offset Calibration [II, 57](#)

Overshoot [180](#)

P

Parity error [242, 259](#)

Pattern Setting [92, 95](#)

Peak [III, 70](#)

Period [174](#)

Period Area [181](#)

Phase [176](#)

Positive Pulse Count [175](#)

Preshoot [180](#)

Pulse Width Setting [85](#)

R

Rectangular [146](#)

Rise Time [174](#)

Rising Edge Count [175](#)

RMS [180](#)

S

Set the Gateway [361](#)

Sinc [VIII, 305](#)

Start keep [320](#)

Start Phase [302](#)

Static IP [360](#)

Subnet Mask [361](#)

Sweep [VIII, 319](#)

Sweep Trigger Source [320](#)

Symmetry [303](#)

Sync [90](#)

Sync error [260](#)

T

The trigger sources of the burst [322](#)

Triangle [147](#)

Trigger Condition [86](#)

Tvmax [174](#)

Tvmin [174](#)

V

Vamp [179](#)

Vavg [179](#)

Vbase [179](#)

Vector [297](#)

Vertical Scale [II, 48](#)

Video Polarity [89](#)

Video Standard [89](#)

VISA [362](#)

Vlower [179](#)

Vmax [179](#)

Vmid [179](#)

Vmin [179](#)

Vpp [179](#)

Vtop [179](#)

Vupper [179](#)

W

Waveform Aliasing [71](#)

Waveform Distortion [71](#)

Waveform Leakage [72](#)

Window Trigger [III, 101](#)

X

X Cursor [187](#)

Y

Y Cursor [187](#)

HEADQUARTER

RIGOL TECHNOLOGIES CO., LTD.
No.8 Keling Road, New District, Suzhou,
JiangSu, P.R.China
Tel: +86-400620002
Email: info@rigol.com

EUROPE

RIGOL TECHNOLOGIES EU GmbH
Carl-Benz-Str.11
82205 Gilching
Germany
Tel: +49(0)8105-27292-0
Email: info-europe@rigol.com

NORTH AMERICA

RIGOL TECHNOLOGIES, USA INC.
10220 SW Nimbus Ave.
Suite K-7
Portland, OR 97223
Tel: +1-877-4-**RIGOL**-1
Fax: +1-877-4-**RIGOL**-1
Email: info@rigol.com

JAPAN

RIGOL JAPAN CO., LTD.
5F,3-45-6,Minamiotsuka,
Toshima-Ku,
Tokyo,170-0005,Japan
Tel: +81-3-6262-8932
Fax: +81-3-6262-8933
Email: info-japan@rigol.com

RIGOL® is the trademark of **RIGOL TECHNOLOGIES CO., LTD.** Product information in this document is subject to update without notice. For the latest information about **RIGOL**'s products, applications and services, please contact local **RIGOL** channel partners or access **RIGOL** official website: www.rigol.com