



User's Manual

UNIVERSAL CALIBRATOR

PCE-MCA 50



PCE Instruments

Email: info@pce-instruments.com

Web: <http://www.pce-instruments.com>

1. Introduction	4
Foreword.....	4
Notice	4
Trademarks.....	4
Safety	4
General warnings	5
Electrical warnings.....	5
Cautions.....	5
Summary of functions.....	6
2. PCE-MCA 50 Hardware Parts & Accessories.....	7
2.1 Unpacking & Inspection.....	7
2.2 Operational Sections and Connections	8
2.2.1 The Terminal Connections	8
2.2.2 The KeyPad	17
2.2.3 The Display	18
2.2.4 The USB Connection.....	18
2.2.5 Stand for Table Top Use	18
2.3 Power Options	19
2.4 Battery.....	19
2.4.1 Charge time.....	19
2.4.2 Operating Time	20
3. Start Up & Basic Operations	21
3.1 Power ON or OFF.....	21
3.2 The User Interface	21
3.2.1 The Status Bar	22
3.2.2 The Function key Bar	23
3.2.3 Display Mode	23
3.2.4 Display Operations.....	30
3.2.5 SCR1 and SCR2 Key Option : mQUICK-SETUP Key	35
4. Menu Layout	36
4.1 MENU page	36

4.2 MEASURE Page	36
4.3 SOURCE Page	38
4.3.1 ET Setup	38
4.3.2 TC Setup	44
4.3.3 RTD Setup	47
4.3.4 Pulse Setup	53
4.4 DISPLAY Page	54
4.4.1 EM Display Settings	56
4.4.2 Switch test Display Settings	57
4.4.3 ET Display Settings	58
4.4.4 TC Display Settings	59
4.4.5 RTD Display Settings	61
4.5 DATA LOGGING Page	63
4.5.1 Transferring the Results to a Personal Computer:	65
4.6 CJC SETTING Page	66
4.7 Wire Select Page	67
4.8 Alarm Page	68
4.9 SETTING Page	69
4.9.1 HART Settings	69
4.9.2 Display Settings	70
4.9.3 Date/Time Settings	70
4.9.4 Calibration	71
4.9.5 Battery Info	71
4.9.6 Set Password	71
4.9.7 Factory Reset	72
4.9.8 About Us	72
5. Maintenance & Troubleshooting	72
5.1 Common Problems	72
5.2 Replacing the Battery	73
5.3 Related Information	73
5.3.1 Thermocouple Measurement/Simulation, Connections and troubleshooting.	74
5.3.2 Parallel Functions in PCE-MCA 50	76
6. General Specifications	77
6.1 General Specifications	78



6.2 Display & Keys	78
6.3 Special Features	78
6.4 Power Supply.....	79
6.5 Physical.....	79
6.6 Electrical Measurement Parameters and Accuracy	79
6.7 Electrical Simulation Parameters and Accuracy	80
6.8 Resistance Measurement 0 ... 4000 ohm	80
6.9 Resistance Simulation 0 ... 4000 ohm	80
6.10 RTD Measurement and Simulation.....	81
6.11 Available RTD Types	81
6.12 Thermocouple/mV Resolution and Accuracy.....	82
6.13 Frequency Measurement	82
6.14 Pulse counting.....	82
6.15 Frequency Generation	82
6.16 Pulse Generation	83
6.17 Enclosure Dimensions	84

1. Introduction

Foreword

Thank you for purchasing **Universal Calibrator** PCE-MCA 50. The PCE-MCA 50 calibrator is compact hand-held calibrator with an easy to use graphical user interface.

This manual describes the basic functions and operation methods. Please read through this user's manual carefully before using the product.

Notice

The contents of this manual are subject to change without notice as a result of continuous improvements to the instrument's performance and functions.

Every effort has been made to ensure accuracy in the preparation of this manual. Should any errors or omissions come to your attention, however, please inform PCE INSTRUMENTS Sales office or sales representative. Under no circumstances may the contents of this manual, in part or in whole, be transcribed or copied without our permission.

Trademarks

Our product names or brand names mentioned in this manual are the trademarks or registered trademarks of **PCE INSTRUMENTS** (Herein after referred to as **PCE INSTRUMENTS**).

Adobe, Acrobat, and Postscript are either registered trademarks or trademarks of Adobe Systems Incorporated. All other product names mentioned in this user's manual are trademarks or registered trademarks of their respective companies.

Safety

Before you use the instrument, make sure that you read and understand all the related data. This includes: the applicable local safety procedures, this publication, and the instructions for the accessories/options/equipment you are using it with.

General warnings

WARNING

It is dangerous to ignore the specified limits for the instrument or its related accessories.

Do not use the instrument or accessory if it is not in its normal condition.

Use the applicable protection and obey all safety precautions.

Do not use the instrument in locations with explosive gas, vapor or dust. There is a risk of an explosion

Electrical warnings

To prevent electrical shocks or damage to the instrument, do not connect more than 30V between the terminals, or between the terminals and the ground.

This instrument uses a Lithium-Ion battery pack. To prevent an explosion or fire, do not short circuit, do not disassemble, and keep it safe from damage. For operating conditions, see section 6.1 on Page-85

To prevent battery leakage or heat generation, only use the battery charger in the temperature range 0 to 45°C (32 to 113°F). For operating conditions, see section 6.1 on Page-85.

To make sure the display shows the correct data, disconnect the test leads before you set the power to on or change to another measure or source function.

Cautions

To prevent damage to the display, do not use sharp objects on the screen.

Before you start an operation or procedure in this publication, make sure that you have the necessary skills (if necessary, with qualifications from an approved training establishment). Follow good engineering practice at all times.

Summary of functions

This table gives a summary of the available functions with the PCE-MCA 50 calibrator.

Function
Easy to read liquid crystal display (LCD) in color
Rechargeable lithium Ion battery with enhanced power control for prolonged battery life.
* Measure RTD(Pt10, Pt50, Pt100, Pt200, Pt400, Pt1000, Pt100(3926),Ni100(672), Ni100(618), Ni120(672), Cu10(427), Cu50(427), Cu100(427)), Resistance (0 to 4000 ohms), mA, mA(2W), V, Thermocouple (E,J,K,T,B,R,S,N), mV(-10 to 250mV),Switch-test, Frequency, Pulse
* Simulate RTD(Pt10, Pt50, Pt100, Pt200, Pt400, Pt1000, Pt100(3926),Ni100(672), Ni100(618), Ni120(672), Cu10(427), Cu50(427), Cu100(427)), Resistance (0 to 4000 ohms),Thermocouple (E,J,K,T,B,R,S,N), mV(-10 to 250mV), mA, mA(2W), V, Frequency, Pulse
Step/Ramp functions: Automatic/Manual
Universal Serial Bus (USB) communications ports: For computer Communications, Battery Charging& Firmware Upgrade
Data Logging
Other functions: Maximum / Minimum / Average, filter, tare, adjustable backlight, alarm indication (on the display and buzzer), Glance Screen. Continuity Test, Automatic / Manual Wire Selection for RTD Measurement, RTD CJ Compensation.

* Refer to the Specification Sheet on Page: 79

2. PCE-MCA 50 Hardware Parts & Accessories

2.1 Unpacking & Inspection

At the factory each new PCE-MCA 50 passes a careful inspection. It should be free of scrapes and scratches and in proper operation order upon receipt. The receiver should, however, inspect the unit for any damage that may have occurred during transit. If there are signs of obvious mechanical damage, package contents are incomplete, or the instrument does not operate according to specifications, contact the purchasing sales office as soon as possible. The standard accessories are as follows:

If you have to return the instrument to the factory for any reason, use the original packing whenever possible. Include a detailed description of the reason for the return.

2.2 Operational Sections and Connections

All sections and connections are presented in detail on the next pages.

Note:

Keep in mind that the next picture (as well as all pictures of PCE-MCA 50 in this manual) has an example configuration of modules. The configuration of your PCE-MCA 50 may vary significantly from the one in the picture.



1	Terminal Connection For Measure & Source
2	Keypad Section
3	TFT Color Display
4	USB Connection Slot for PC Communication & Charging

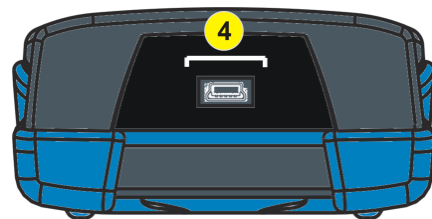

2.2.1 The Terminal Connections

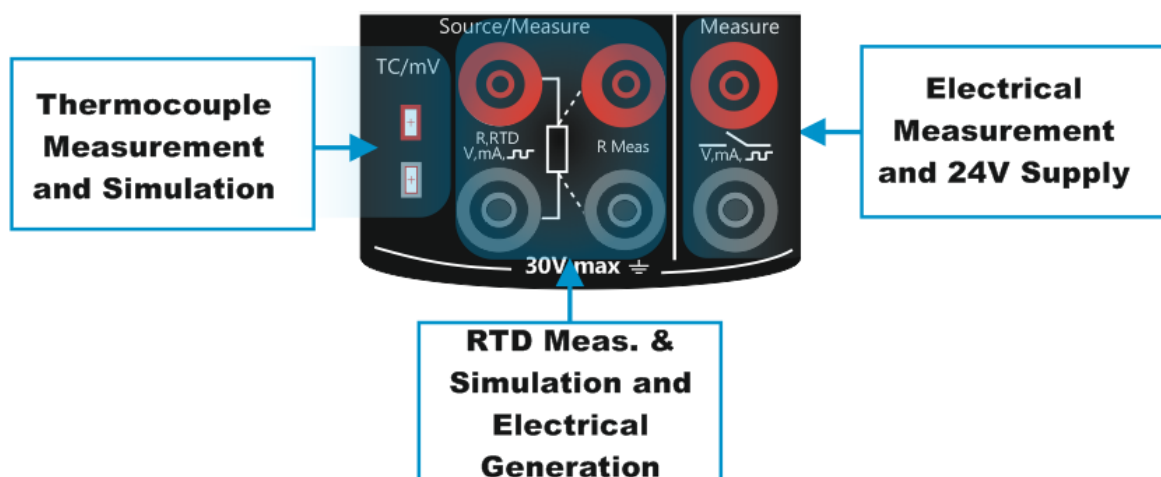

➤ EM (Electric Measurements and 24V Supply) Measure Terminals

Input Terminals for measuring voltage, current, supplying loop power, and Frequency and pulse types refer specification sheet on **page no. 79 Section 6.6 and page no. 82 Section 6.13, 6.14.**

• Current Measurement

PCE-MCA 50 supports current measurement using either PCE-MCA 50 as the loop power supply while at the same time measuring the current or simply measuring the current while an external power supply is used.

The following picture displays the connection for Current Measurement for different mode. And also different ways of providing the supply power to the loop.

➤ mA Current Measurement

In this mode PCE-MCA 50 not providing any supply voltage. For proper measurement the external device should capable of providing the voltage supply. If the external device should not capable, an external Power Supply should be connected in series.

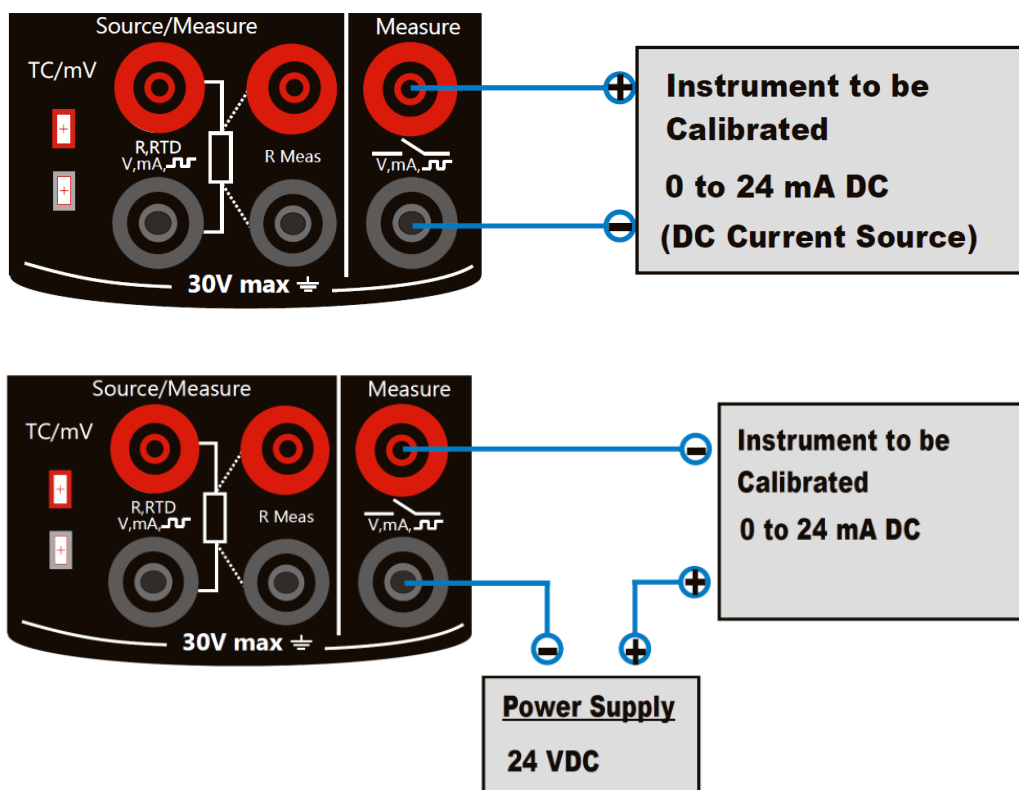

➤ mA Read Power Current Measurement

In this mode PCE-MCA 50 works as Loop Power Supply while at the same time measuring the current.

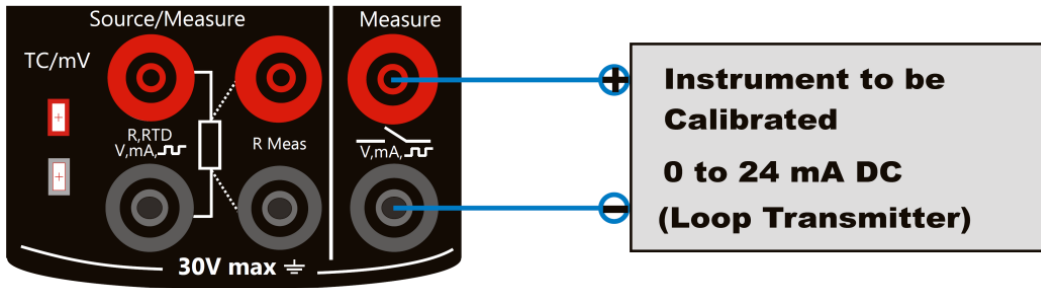

• Voltage Measurement

PCE-MCA 50 is capable of voltage measurement. The following picture displays the connection for voltage measurement.

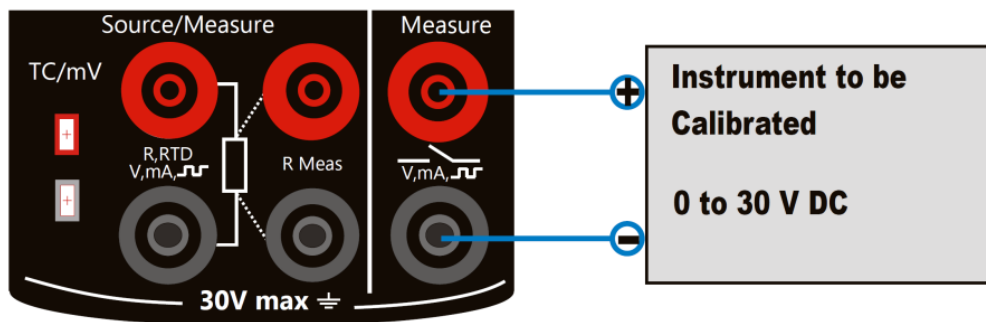

• Frequency Measurement

PCE-MCA 50 is capable of frequency measurement. The following picture displays the connection for frequency measurement.

Also check the Trigger Level setting. There you can specify the trigger level and whether to use a test voltage during the frequency measurement

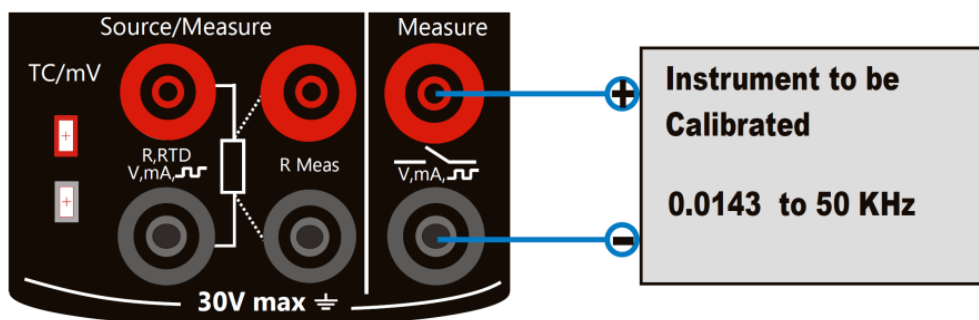

• Pulse Count Measurement

PCE-MCA 50 is capable to count number of pulses. The following picture displays the connection for pulse count measurement.

Check the Trigger Level setting to specify the trigger level and whether to use a test voltage during the pulse counting. Also check the Trigger Edge (Rising or Falling) setting so it suits your need.

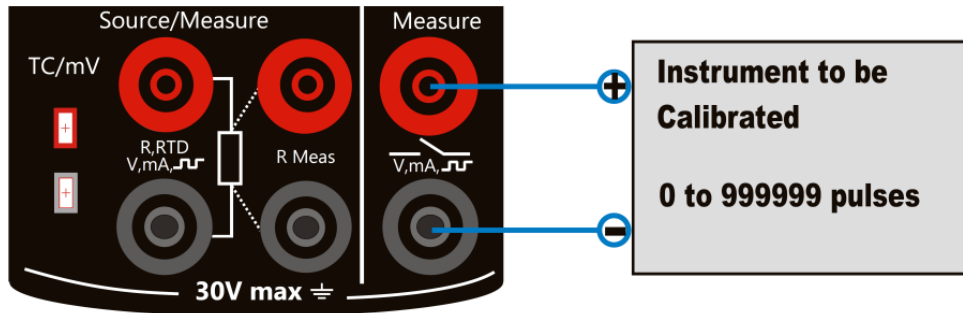

➤ ET (Electrical source Terminal) Terminals

Terminals for Simulating voltage, current, supplying loop power types refer specification sheet on **page no. 79 Section 6.7**

• Current Generation

In source mode PCE-MCA 50 provides the supply power to the loop.

The following picture displays the connection for current source for different mode.

➤ mA Current Source

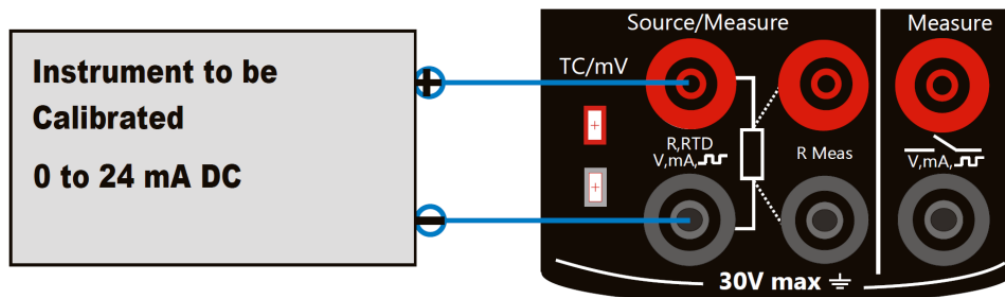

➤ mA 2-Wire Source

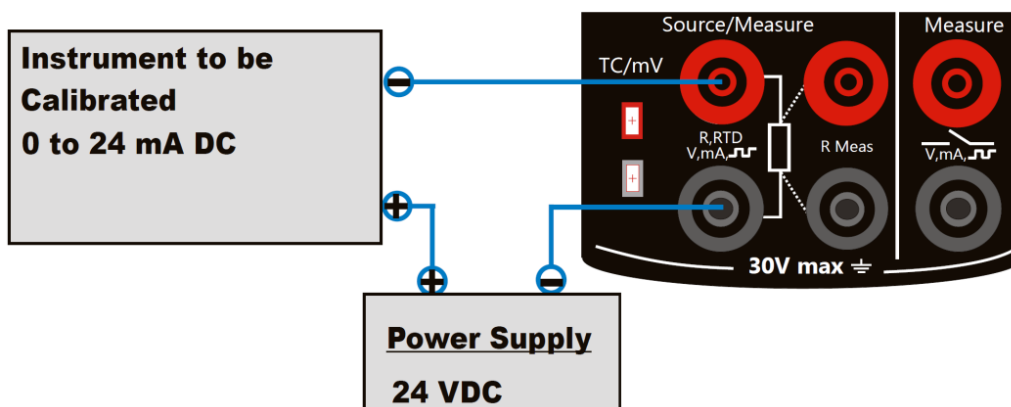

• Voltage Generation

PCE-MCA 50 is capable of voltage generation the following picture displays the connection for voltage source.

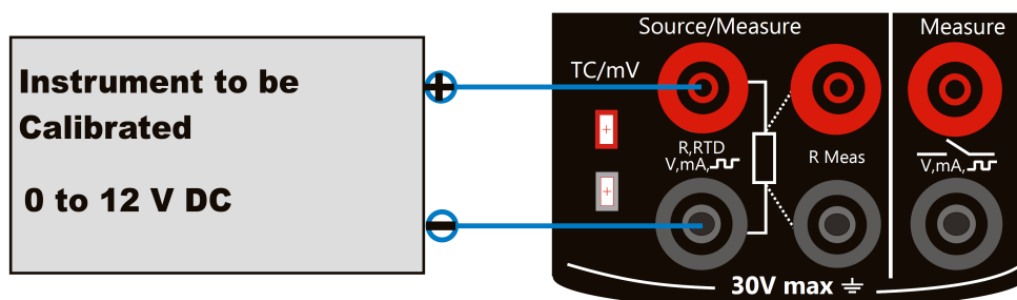

➤ RTD Terminals

Terminals for measuring & simulating RTD / Ω . For RTD/ Ω types refer specification sheet on **Page No.79- 82 Section 6.8, 6.9, 6.10, 6.11**

- RTD/Resistance Source

PCE-MCA 50 is capable of RTD/Resistance generation. The following picture displays the connection for RTD and Resistance simulation. In RTD simulation PCE-MCA 50 mimics an RTD. The instrument under test generates the current for the RTD measurement. PCE-MCA 50 controls the voltage across its terminals so that the resistance (voltage to Current ratio) corresponds to the simulated temperature. Use of 2, 3 or 4-wire connection is up to the receiver instrument. Use only the two leftmost terminals with every wiring option. Connect the possible third and fourth wire according to the Requirements of the connected instrument but use only the two leftmost terminals.

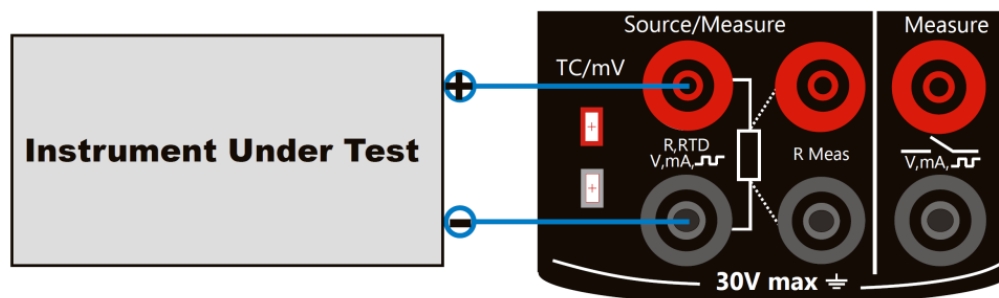

- **RTD / Resistance measurement**

PCE-MCA 50 is capable of RTD/Resistance measurement. The following picture displays the connection for RTD and Resistance measurement.

- **2-Wire RTD Measurement**

Two leftmost terminals are used in 2-wire systems. PCE-MCA 50 displays the selected wiring system in run page. PCE-MCA 50 sources current through the resistor and measure the voltage drop across same terminals. The result is acceptable, if the resistance of the connection wires is significantly smaller than actual measured resistance.

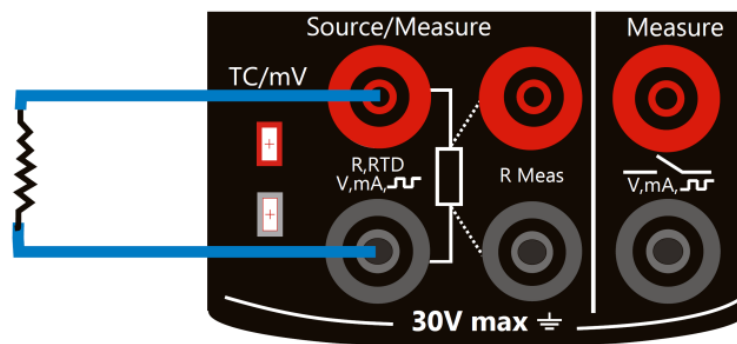

- **3-Wire RTD Measurement**

PCE-MCA 50 sources current through the resistor and measure the voltage drop across the entire current loop and across the upper side connection wire as shown in figure. If both left side connection wires are identical, PCE-MCA 50 can compensate for the resistance of the connection wires.

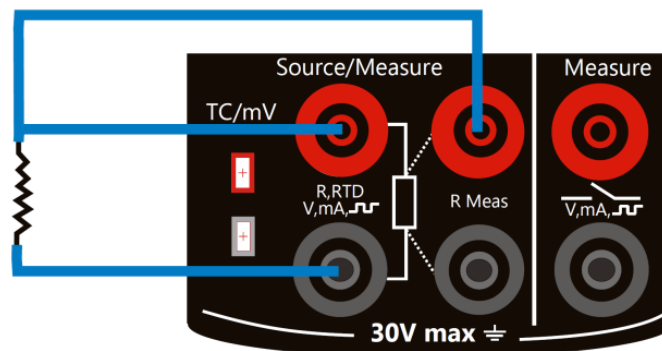

- **4-Wire RTD Measurement**

PCE-MCA 50 sources current through the resistor from two left side terminals and measure the voltage drop across the resistor from the two right side terminals. The 4-wire method gives the

resistance between the terminals of the resistor; it is insensitive to the resistance of the connection wires.

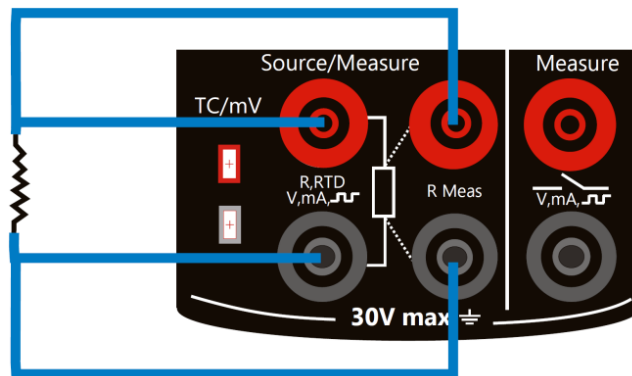

➤ TC Terminals

Terminal for measuring & simulating thermocouples and mV. This terminal accepts a miniature polarized thermocouple plug with flat, in-line blades spaced 7.9 mm (0.312 in) center to center.

For specification refer **Section 6.12**

PCE-MCA 50 supports measurement and simulation of Thermocouple and mV.

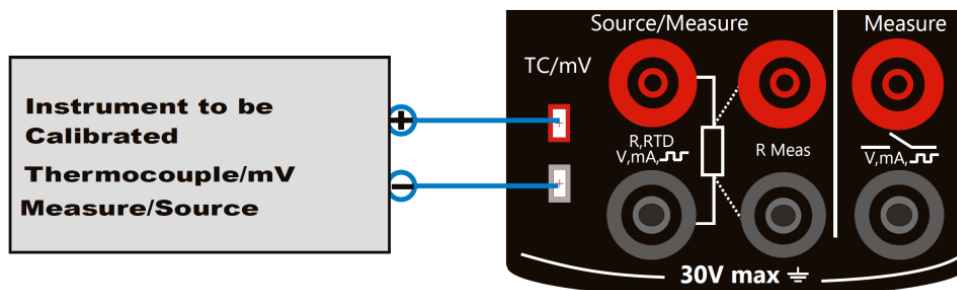

➤ Frequency Terminals

PCE-MCA 50 is capable of Frequency Generation. The following picture displays the connection for Frequency Generation.

For specification refer **Section 6.15**

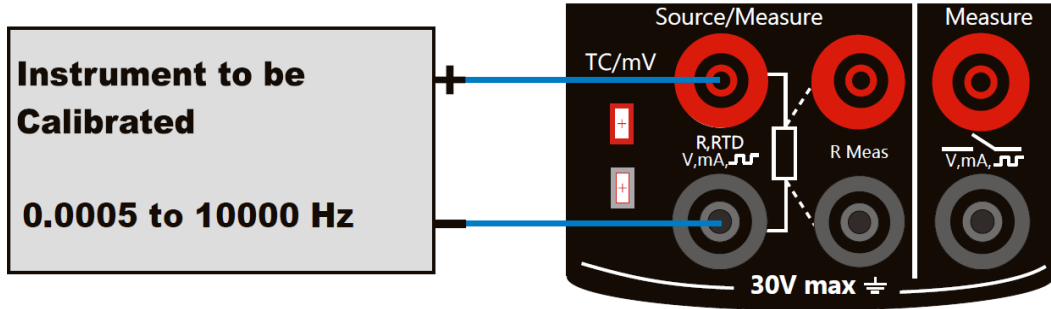

➤ Pulse Terminals



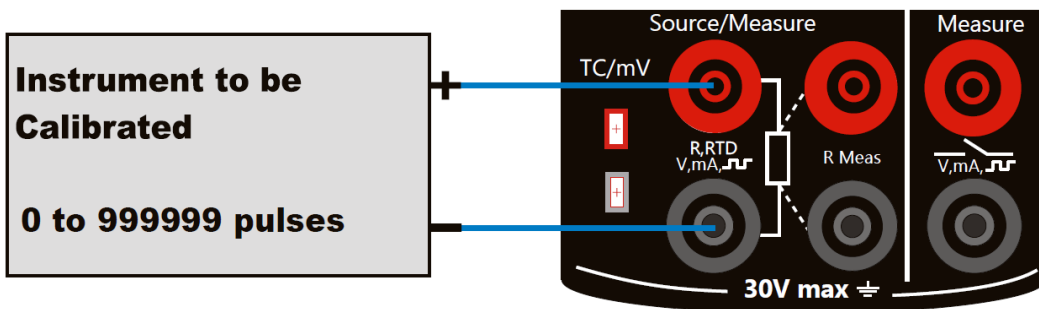



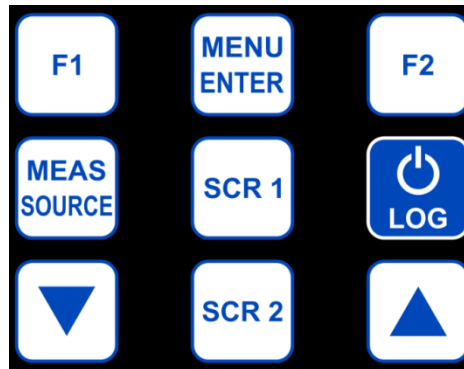

PCE-MCA 50 is capable of Pulse Generation. The following picture displays the connection for Pulse Generation. For specification refer **Section 6.16**



2.2.2 The KeyPad



PCE-MCA 50 has nine different keys. The key description is given below.

	This key has different functionalities in different menu. And that is shown on Bottom Left Part of Display. Pulse Resetting Shortcut: The counter may be cleared (zeroed) by long Pressing F1 key for 3 sec during Pulse Measurement Only.
	This key has different functionalities in different menu. And that is shown on Bottom Right Part of Display.
	This key is use to scroll down to the next parameter. And also for decrementing the value of digit in Editbox.
	This key is use to scroll up to the previous parameter. And also for incrementing the value of digit in Editbox.
	This Key is use for Entering into the MENU Page from Run Page. And Also for Saving Edited Parameter to the memory.
	This key is use to log current reading in memory if device is on Run Page& Log Mode is Manual. (In other Page than Run Mode, this key is use to come directly to Run Page. Long presses (Approx.2 Sec) on this key will ON-OFF the Unit.
	This key is used to go in Screen 1 setup menu page.
	This key is used to go in Screen 2 setup menu page.
	This key is used to switch between measure and source mode (Only applicable for T/C,mV and RTD Measure / Simulation).

2.2.3 The Display

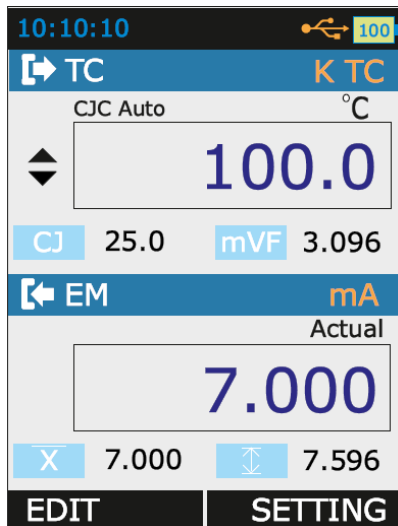

OR

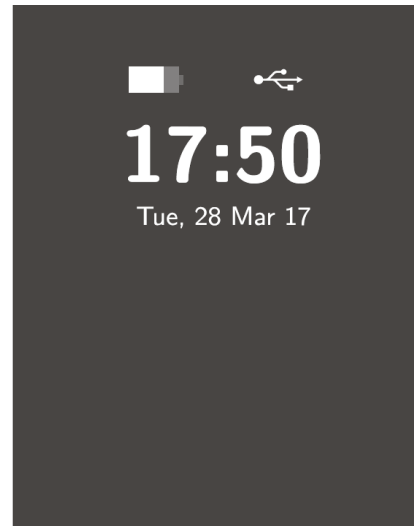



- This is a LCD with a 3.2" color display.
- The display has resolution of 240x320 pixels supporting 262K Colors.
- Refer Section 3.2.3 on Page-23 for more details on Different Display Mode and Icon Details

2.2.4 The USB Connection

- The USB Connection Connector is given at Top of the PCE-MCA 50. It's a USB A Male to USB mini B Male Connector.
- It is common for PC Communication & Charging the device.
- The USB cable given with the device is USB A-type Male to USB mini B-type male.

2.2.5 Stand for Table Top Use

- This Stand would offer the best support for table top use which gives good viewing angle when PCE-MCA 50 is placed table top
- Procedure to Open Stand
 -  is being engraved on the top of the stand. You should pull a bit first.
 -  is being engraved on the bottom of the stand. Now during first pull of above you can release this lower part easily so that you can maneuver the stand as you like.

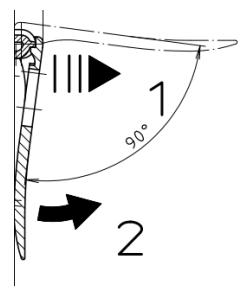

2.3 Power Options

There are three power options:

- **Lithium-Ion battery:** All the instrument functions are available with a charged battery.
- **5 V DC Charging Adaptor:** It supplies power to the instrument and charges the battery at the same time. It charges the battery when the instrument is on or off.
- **USB mini Type B connection:** This charges the battery when the instrument is off and increases the battery life when the instrument is on. Instrument cannot be charged with USB when it is ON.

2.4 Battery



The Device uses 3000mAh Lithium-Ion Battery. **Explosion or fire, do not short circuit, do not disassemble, and keep it safe from damage. For more specification refer Section 6.4**

- To prevent an explosion or fire, use only the PCE INSTRUMENTS specified battery, battery charger & USB Cable.
- To prevent battery leakage or heat generation, only use the battery charger in the temperature range 0 to 45°C (32 to 113°F).
- To get more information on Battery go to Battery Info Page in Setting Menu.

2.4.1 Charge time

	Charge Method	Charge Time (to Full Capacity)	
Note: <i>USB B</i>	External Charging Adaptor	≈ 8 hours	<i>mini Type connector</i>

charges the battery when the instrument is off and increases the battery life when the instrument is on

2.4.2 Operating Time

These are typical operating times for a new, fully charged Li-Ion battery pack with these settings:

- Backlight Intensity set to 5% (Default: 100%)
- Glance Screen Timeout set to 0 to 9999 sec.

Operation	Battery Duration
Continuous operation (measure or source)	> 17hours
Continuous operation (12mA(24V) measure)	>9 hours

Power save options: To get the best battery duration, set a low value for the Backlight Intensity (40%) and a short Timeout.

The maximum operating time without recharging varies depending on the usage and brightness setting of the display light. Also the generated output and the usage of the 24V transmitter supply affect the maximum operating time.

Notes:

- *PCE-MCA 50's memory and the internal clock/calendar use a small amount of power although the calibrator is switched off. Remember to check the capacity of the batteries from time to time although PCE-MCA 50 is not in use.*
- *Do not leave PCE-MCA 50 without a Battery Pack or an Empty Battery for a long time. PCE-MCA 50 may lose its settings if it is left without a support voltage for an extended period.*

3. Start Up & Basic Operations

3.1 Power ON or OFF

To set the instrument power ON, press and release  button until the display comes on. During the power on sequence, the instrument shows a Startup Message and then shows the applicable data.

To set the instrument power off, press and hold (≈ 2 seconds)  button again. When the power is off, the last set of configuration options stays in memory.

3.2 The User Interface

Every time PCE-MCA 50 is switched on, the startup message ends in RUN Page.

There are 5 Display Mode available in RUN Page.

1. RTD (Measure/Source) + EM Measure Mode / Switch Test Mode
2. TC (Measure/Source) + EM Measure Mode / Switch Test Mode
3. ET (Source) + EM Measure Mode / Switch Test Mode
4. Pulse Output + EM Measure Mode / Switch Test Mode
5. Frequency Output + EM Measure Mode / Switch Test Mode





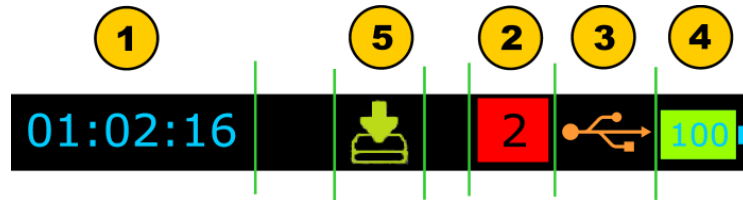

This Display Mode can be selected from MENU→DISPLAY Page.

Display Screen is divided into two parts. Which Information to be shows can be selectable in Display Mode Menu Refer Section 3.2.3 on Page-22 for more info.

3.2.1 The Status Bar



The Status Bar at the top of the display is visible only in RUN Page. It is divided into five main sections.

1	<p>Time in HH:MM:SS Format</p> <p>Available in Two Format</p> <ol style="list-style-type: none"> 1. 24 Hour (default) 2. 12 Hour <p><i>This setting is available in Date/Time in Settings Menu</i></p>																		
2	<p>Error Code Indicator</p> <p>This Icon is visible if any On-Board Peripherals like RTC, ADC, DAC, etc. not working Properly. Refer Section 5.1 on Page for Troubleshooting these Errors.</p> <p>The List of Error Code available in this device is given below.</p> <table border="1" style="width: 100%; border-collapse: collapse;"> <thead> <tr> <th style="text-align: center;">Error Code</th> <th style="text-align: center;">Description</th> </tr> </thead> <tbody> <tr> <td style="text-align: center;">0</td> <td>Memory Corrupted or Device Unable to Read/Write it.</td> </tr> <tr> <td style="text-align: center;">1</td> <td>RTC Not working Properly</td> </tr> <tr> <td style="text-align: center;">2</td> <td>Device unable to Read battery Information.</td> </tr> <tr> <td style="text-align: center;">3</td> <td>Measure Mode Not Working</td> </tr> <tr> <td style="text-align: center;">5</td> <td>Data Log Memory Corrupt</td> </tr> <tr> <td style="text-align: center;">6</td> <td>Source Mode Not Working</td> </tr> <tr> <td style="text-align: center;">7</td> <td>Secondary controller communication error</td> </tr> <tr> <td style="text-align: center;">9</td> <td>More than one Errors from above list is occurring.</td> </tr> </tbody> </table>	Error Code	Description	0	Memory Corrupted or Device Unable to Read/Write it.	1	RTC Not working Properly	2	Device unable to Read battery Information.	3	Measure Mode Not Working	5	Data Log Memory Corrupt	6	Source Mode Not Working	7	Secondary controller communication error	9	More than one Errors from above list is occurring.
Error Code	Description																		
0	Memory Corrupted or Device Unable to Read/Write it.																		
1	RTC Not working Properly																		
2	Device unable to Read battery Information.																		
3	Measure Mode Not Working																		
5	Data Log Memory Corrupt																		
6	Source Mode Not Working																		
7	Secondary controller communication error																		
9	More than one Errors from above list is occurring.																		
3	<p>USB Connection Status Icon</p> <p>Icon is visible if USB Charger Adaptor or USB Data Cable is connected to the Device. Icon is different for both indication & this stated below.</p> <table border="1" style="width: 100%; border-collapse: collapse;"> <tbody> <tr> <td style="text-align: center;"></td> <td>USB Data Cable is connected & Communication with PC is available.</td> </tr> <tr> <td style="text-align: center;"></td> <td>USB Charger Adaptor is connected. Battery starts Charging.</td> </tr> </tbody> </table>		USB Data Cable is connected & Communication with PC is available.		USB Charger Adaptor is connected. Battery starts Charging.														
	USB Data Cable is connected & Communication with PC is available.																		
	USB Charger Adaptor is connected. Battery starts Charging.																		
4	<p>Battery Charge Percentage Indicator.</p> <p>Always visible in Run page. Battery % is shown in the center of the icon. And the icon background is filled with Green, Yellow & Red color if Battery % is $\geq 50\%$, $\geq 20\%$ & $< 20\%$ respectively.</p>																		
5	<p>Data Logging Enable Status Indicator.</p> <p>Icon is visible if Data Logging is enabled and also it will blink when a Datalog is stored to memory.</p>																		

3.2.2 The Function key Bar









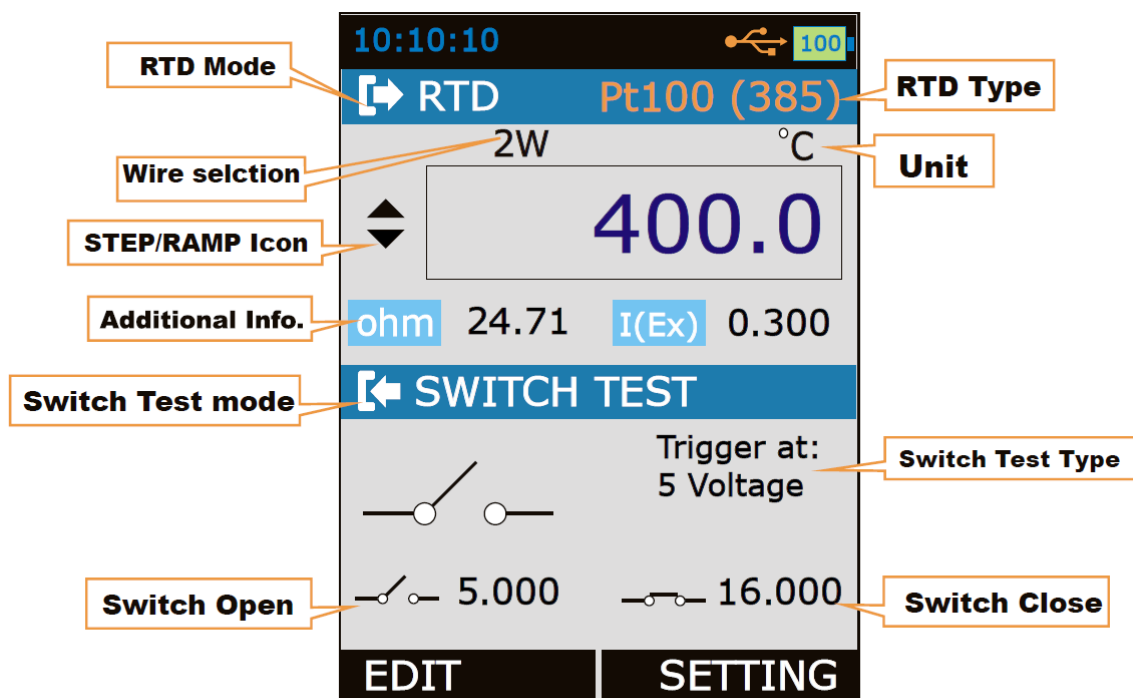



















The Function Key Bar at the bottom of the display is visible all the time. There are 2 Function Key Available. The meaning of the Function Keys varies depending on the situation. A Blank Function key text means that the function is disabled at the moment.

3.2.3 Display Mode

i. RTD (Measure/Source) + EM Measure Mode / Switch Test Mode

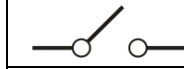
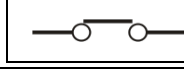
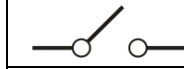
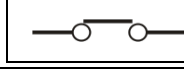
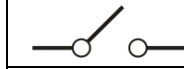
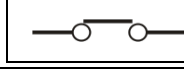

Display Mode																	
RTD Mode	Shows the Current RTD Mode <table border="1" style="margin-left: 20px;"> <tr> <td></td> <td>RTD Measure Mode</td> </tr> <tr> <td></td> <td>RTD Source Mode</td> </tr> </table>		RTD Measure Mode		RTD Source Mode												
	RTD Measure Mode																
	RTD Source Mode																
RTD Type	Shows the current RTD Type.																
Wire Selection	Wire connection for RTD and Resistance Measurement / Source <table border="1" style="margin-left: 20px;"> <tr> <td>2W</td> <td>2 wire connection</td> </tr> <tr> <td>3W</td> <td>3 wire connection</td> </tr> <tr> <td>4W</td> <td>4 wire connection</td> </tr> </table>	2W	2 wire connection	3W	3 wire connection	4W	4 wire connection										
2W	2 wire connection																
3W	3 wire connection																
4W	4 wire connection																
Reading	Shows the RTD reading according to RTD Type.																
STEP/RAMP Icon	Shows the Icon indicating STEP/RAMP mode. Only applicable if RTDmode is <i>SOURCE</i> . <table border="1" style="margin-left: 20px; width: 100%;"> <tr> <td></td> <td>Manual Step</td> <td></td> <td>Rising Ramp</td> </tr> <tr> <td></td> <td>Step UP</td> <td></td> <td>Falling Ramp</td> </tr> <tr> <td></td> <td>Step DOWN</td> <td></td> <td>Ramp Hold @ 0%</td> </tr> <tr> <td></td> <td></td> <td></td> <td>Ramp Hold @ 100%</td> </tr> </table>		Manual Step		Rising Ramp		Step UP		Falling Ramp		Step DOWN		Ramp Hold @ 0%				Ramp Hold @ 100%
	Manual Step		Rising Ramp														
	Step UP		Falling Ramp														
	Step DOWN		Ramp Hold @ 0%														
			Ramp Hold @ 100%														
Additional Info.	Shows the Addition Information according to RTD Mode & Additional Info selected in <i>MENU → DISPLAY → RTD terminal</i> .																
Bar Graph	Horizontal Bar graph according to RTD Percentage Value (0.00% - 100.00%). The value scales according to RTD reading and Input 0% & 100% value as set in <i>MENU → DISPLAY → RTD terminal</i> Menu.																
Percentage Value	The Percentage Value in according to RTD Reading.																
Wire Select	Shows which RTD configuration is used. (2-wire, 3-wire, 4-wire)																
Source Display Mode	Shows which display mode is selected either percentage or actual.																
Actual Value	When display mode percentage Actual value bar display the actual source value.																
I (EX)	When RTD is in source mode it shows the excitation current which comes from the measure device.																

Measure Window					
Switch Status	Switch Status Icon <table border="1" style="margin-left: 20px;"> <tr> <td></td> <td>Switch OPEN (OFF)</td> </tr> <tr> <td></td> <td>Switch CLOSE (ON)</td> </tr> </table>		Switch OPEN (OFF)		Switch CLOSE (ON)
	Switch OPEN (OFF)				
	Switch CLOSE (ON)				
Switch OPEN	Displays the Source Reading value after the switch OPEN was detected.				
Switch CLOSE	Displays the Source Reading value after the switch CLOSE was detected.				

ii. TC (Measure/Source) + EM Measure Mode / Switch Test Mode

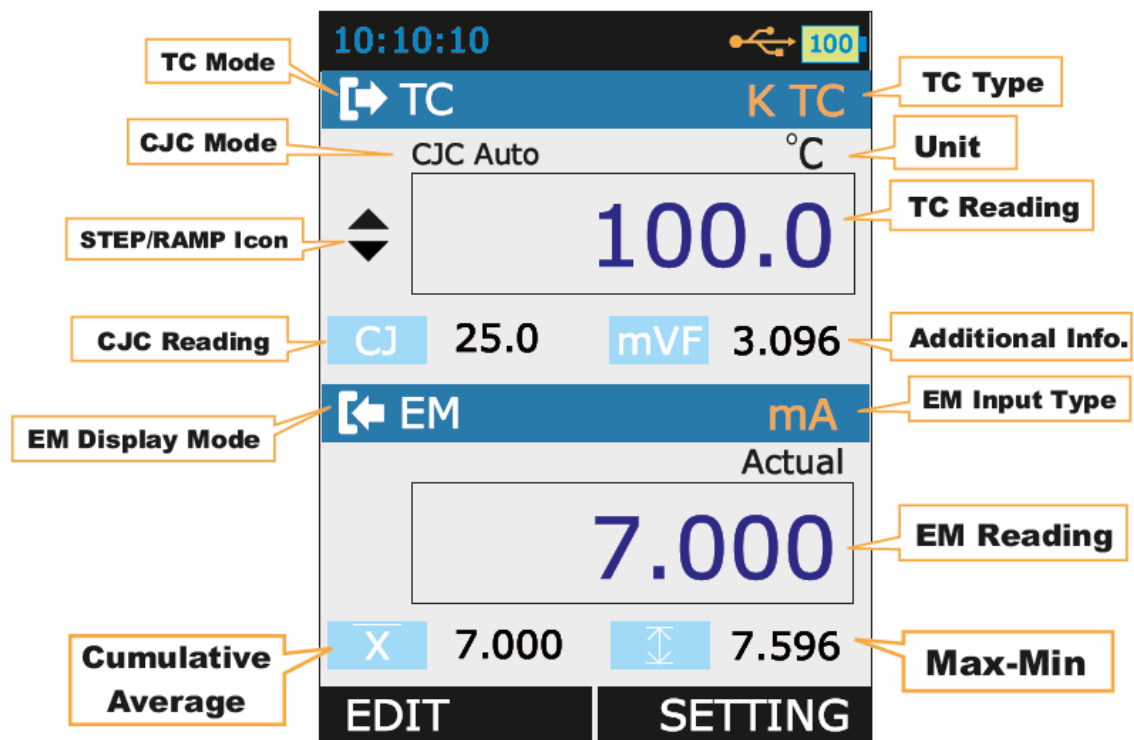

Display Mode				
Input Type	The Input Type.			
Display Mode	The Measure Reading Display Mode.			
	<table border="1"> <tr> <td>Actual</td> <td>Displays the Raw Input Value without any scaling</td> </tr> <tr> <td>Percentage</td> <td>Displays the Percentage Value.</td> </tr> </table>	Actual	Displays the Raw Input Value without any scaling	Percentage
Actual	Displays the Raw Input Value without any scaling			
Percentage	Displays the Percentage Value.			
Reading	The Reading as per the Measure Display Mode			
Bar Graph	Horizontal Bar graph according to Input Percentage Value (0.00% - 100.00%).			
Percentage Value	The Percentage Value in Percentage according to Input Value.			
Tare	The Tare Value Set from <i>MENU</i> → <i>DISPLAY</i> → <i>EM Terminal-Tare</i> page			
Actual Value	The Raw Input Value without any scaling This will appear only if Main Display in <i>MENU</i> → <i>DISPLAY</i> → <i>EM Terminal</i> is set to PERCENTAGE/SCALED .			
Min	Displays the minimum value found after a measurement was started or minimum was reset.			
Max	Displays the maximum value found after a measurement was started or maximum was reset.			
Max-Min	Displays the Maximum-Minimum value found after a measurement was started or Maximum-Minimum was reset.			
Cumulative Average	Displays the Cumulative Average value found after a measurement was started or Cumulative Average was reset.			

Measure Window							
Input Type	The Input Type. <table border="1"> <tr> <td>mA</td> <td>mA Current Input</td> </tr> <tr> <td>mA(24V)</td> <td>mA Current (Read Power-24V) Input</td> </tr> <tr> <td>V</td> <td>V Voltage Input</td> </tr> </table>	mA	mA Current Input	mA(24V)	mA Current (Read Power-24V) Input	V	V Voltage Input
mA	mA Current Input						
mA(24V)	mA Current (Read Power-24V) Input						
V	V Voltage Input						
Measure Display Mode	The Measure Reading Display Mode. <table border="1"> <tr> <td>Actual</td> <td>Displays the Raw Input Value without any scaling</td> </tr> <tr> <td>Percentage</td> <td>Displays the Percentage Value in (0.00% - 100.00%)</td> </tr> <tr> <td>Scaled</td> <td>Displays the Scaled Value</td> </tr> </table>	Actual	Displays the Raw Input Value without any scaling	Percentage	Displays the Percentage Value in (0.00% - 100.00%)	Scaled	Displays the Scaled Value
Actual	Displays the Raw Input Value without any scaling						
Percentage	Displays the Percentage Value in (0.00% - 100.00%)						
Scaled	Displays the Scaled Value						
Measure Reading	The Reading as per the Measure Display Mode						
Measure Info 1	Shows the One of the available Addition Information. This can be selected by Additional Info. 1 List in <i>MENU → DISPLAY → MEASURE</i> page.						
Measure Info 2	Shows the One of the available Addition Information. This can be selected by Additional Info. 2 List in <i>MENU → DISPLAY → MEASURE</i> page. This will disable if Bargraph is selected as Additional Info1 in <i>MENU → DISPLAY → MEASURE</i> page.						
HART Icon	HART Enable Status Icon.						

iii. ET (Measure/Source) + EM Measure Mode / Switch Test Mode

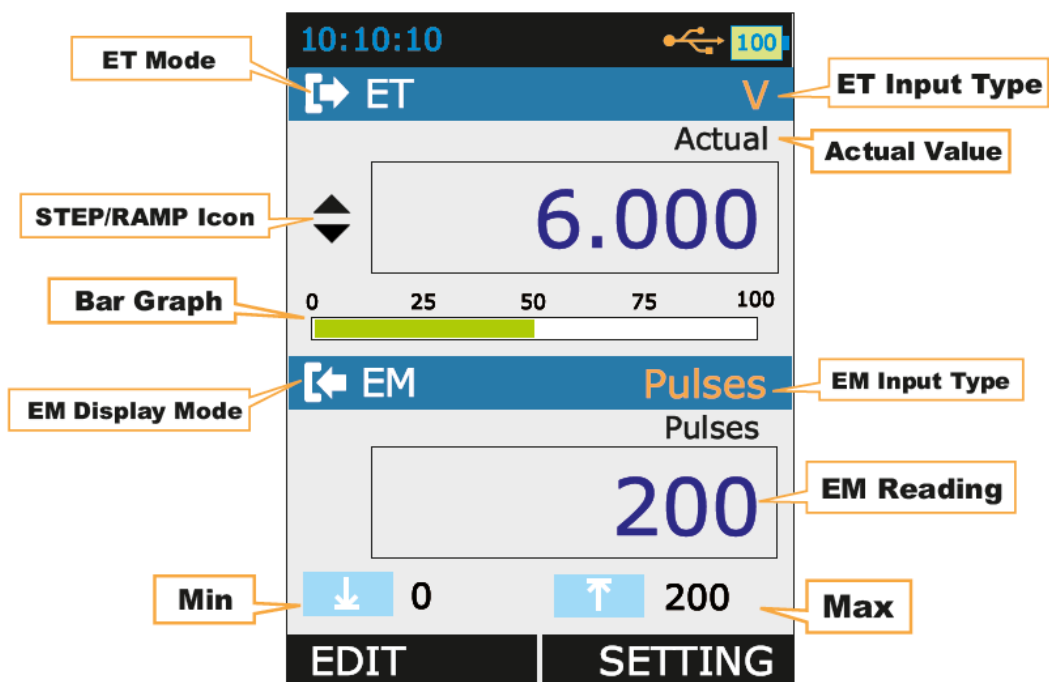



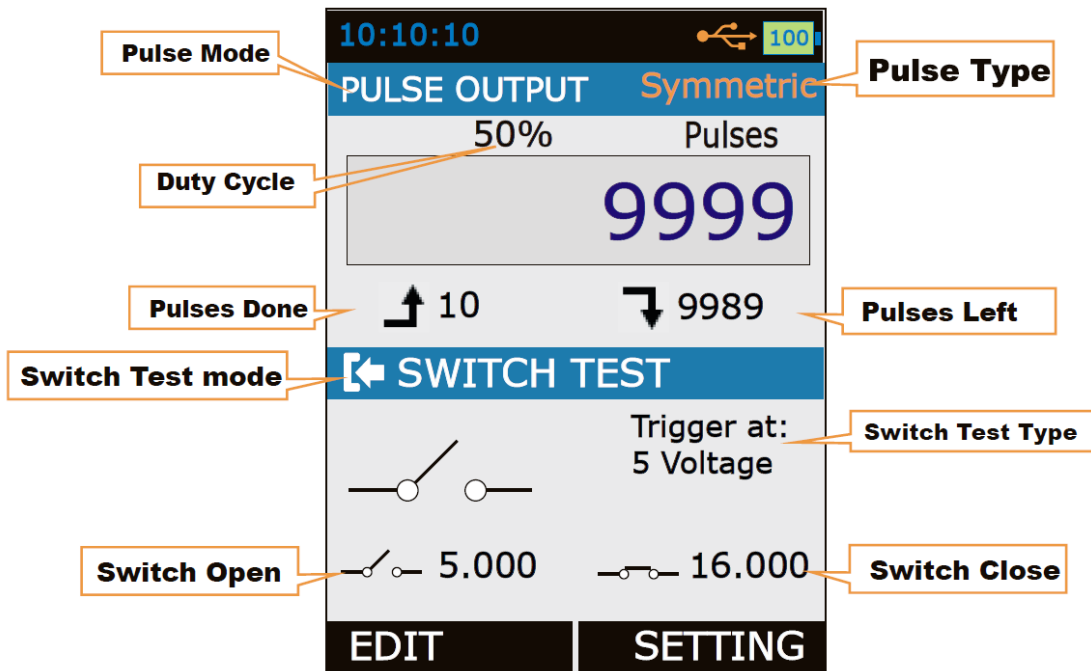

Display Mode	
Input Type	The Input Type.
	mA mA Current Input
	mA(24V) mA Current (Read Power-24V) Input
	V V Voltage Input
Display Mode	The Measure Reading Display Mode.
	Actual Displays the Raw Input Value without any scaling
	Percentage Displays the Percentage Value.
	Scaled Displays the Scaled Value
Reading	The Reading as per the Measure Display Mode
Bar Graph	Horizontal Bar graph according to Input Percentage Value (0.00% - 100.00%).
Percentage Value	The Percentage Value in Percentage according to Input Value.
Tare	The Tare Value Set from <i>MENU</i> → <i>DISPLAY</i> → <i>EM Terminal-Tare</i> page
Actual Value	The Raw Input Value without any scaling This will appear only if Main Display in <i>MENU</i> → <i>DISPLAY</i> → <i>EM Terminal</i> is set to PERCENTAGE/SCALED .
Min	Displays the minimum value found after a measurement was started or minimum was reset.
Max	Displays the maximum value found after a measurement was started or maximum was reset.
Max-Min	Displays the Maximum-Minimum value found after a measurement was started or Maximum-Minimum was reset.
Cumulative Average	Displays the Cumulative Average value found after a measurement was started or Cumulative Average was reset.

Measure Window	
Input Type	The Input Type.
	mA mA Current Input
	mA(24V) mA Current (Read Power-24V) Input
	V V Voltage Input
	Pulse Pulse Input
	Frequency Frequency Input
Measure Display Mode	The Measure Reading Display Mode.
	Actual Displays the Raw Input Value without any scaling
	Percentage Displays the Percentage Value in (0.00% - 100.00%) only for mA, mA(24V),V
	Scaled Displays the Scaled Value only for mA, mA(24V),V
Measure Reading	The Reading as per the Measure Display Mode
Measure Info 1	Shows the One of the available Addition Information. This can be selected by Additional Info. 1 List in <i>MENU</i> → <i>DISPLAY</i> → <i>MEASURE</i> page.
Measure Info 2	Shows the One of the available Addition Information. This can be selected by Additional Info. 2 List in <i>MENU</i> → <i>DISPLAY</i> → <i>MEASURE</i> page. This will disable if Bar graph is selected as Additional Info1 in <i>MENU</i> → <i>DISPLAY</i> → <i>MEASURE</i> page.

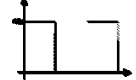
iv. Pulse Output + EM Measure Mode / Switch Test Mode

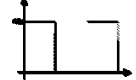

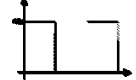
Pulse Output					
Pulse mode	The Input Type.				
Pulse type	The Pulse type. <table border="1"> <tr> <td>Symmetric</td> <td> Displays the symmetric pulse type</td> </tr> <tr> <td>Positive</td> <td> Displays the Positive Pulse type</td> </tr> </table>	Symmetric	 Displays the symmetric pulse type	Positive	 Displays the Positive Pulse type
Symmetric	 Displays the symmetric pulse type				
Positive	 Displays the Positive Pulse type				
Duty Cycle	Duty Cycle Percentage Value (the ratio of the output high time to the total cycle time)				
Reading	The Reading as per the Display Mode				
UP Counter	Displays the pulses currently done during Pulse Generation				
Down Counter	Displays the pulses currently left to be done during Pulse Generation				

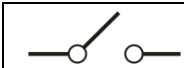
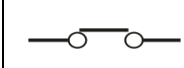
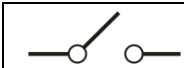
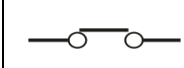
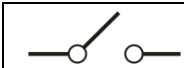
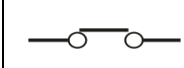
Measure Window					
Switch Status	Switch Status Icon <table border="1"> <tr> <td></td> <td>Switch OPEN (OFF)</td> </tr> <tr> <td></td> <td>Switch CLOSE (ON)</td> </tr> </table>		Switch OPEN (OFF)		Switch CLOSE (ON)
	Switch OPEN (OFF)				
	Switch CLOSE (ON)				
Switch OPEN	Displays the Source Reading value after the switch OPEN was detected.				
Switch CLOSE	Displays the Source Reading value after the switch CLOSE was detected.				

v. Frequency Output + EM Measure Mode / Switch Test Mode

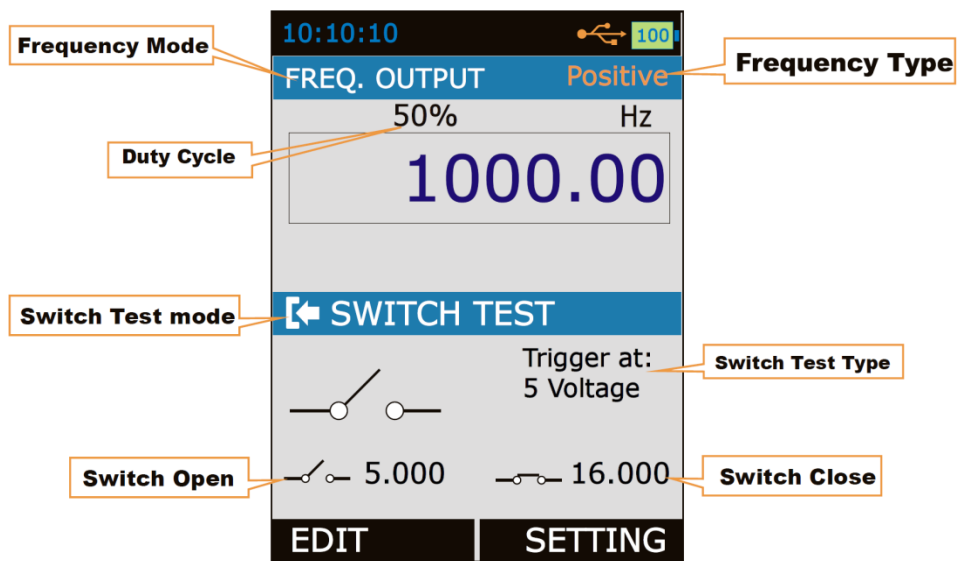

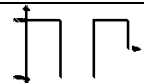
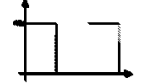
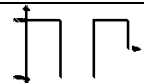
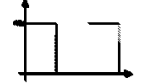
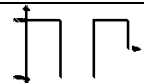
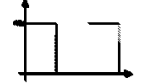
Frequency Output							
Frequency mode	The Input Type.						
Frequency type	The Frequency type. <table border="1" style="width: 100%;"> <tr> <td>Symmetric</td> <td></td> <td>Displays the symmetric pulse type</td> </tr> <tr> <td>Positive</td> <td></td> <td>Displays the Positive Pulse type</td> </tr> </table>	Symmetric		Displays the symmetric pulse type	Positive		Displays the Positive Pulse type
Symmetric		Displays the symmetric pulse type					
Positive		Displays the Positive Pulse type					
Duty Cycle	Duty Cycle Percentage Value (the ratio of the output high time to the total cycle time)						
Reading	The Reading as per the Display Mode						

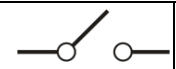
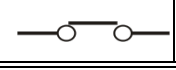
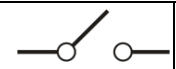
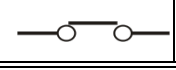
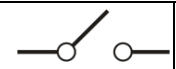
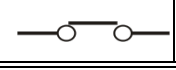
Measure Window					
Switch Status	Switch Status Icon <table border="1" style="width: 100%;"> <tr> <td></td> <td>Switch OPEN (OFF)</td> </tr> <tr> <td></td> <td>Switch CLOSE (ON)</td> </tr> </table>		Switch OPEN (OFF)		Switch CLOSE (ON)
	Switch OPEN (OFF)				
	Switch CLOSE (ON)				
Switch OPEN	Displays the Source Reading value after the switch OPEN was detected.				
Switch CLOSE	Displays the Source Reading value after the switch CLOSE was detected.				

3.2.4 Display Operations

There are mainly four types of widgets available in the Device Menu Style.

- i. ListBox
- ii. EditText
- iii. CheckBox
- iv. RadioButtonBox

The below section will show how to change the value of different widgets.

- **ListBox**

ListBox are used when there is a limited amount of preset values. You have to select one of the available options. The list of available options is displayed in the Centre part.

A ListBoxList opens when you press the **F1** key. Use **UP/DOWN** key to scroll through the available options. Select one of the options with the **ENTER** key.

Example: How to change of Input Type (I/P Type) from mA to V.
This Option is available in *MENU*→*EM SETUP* Page.

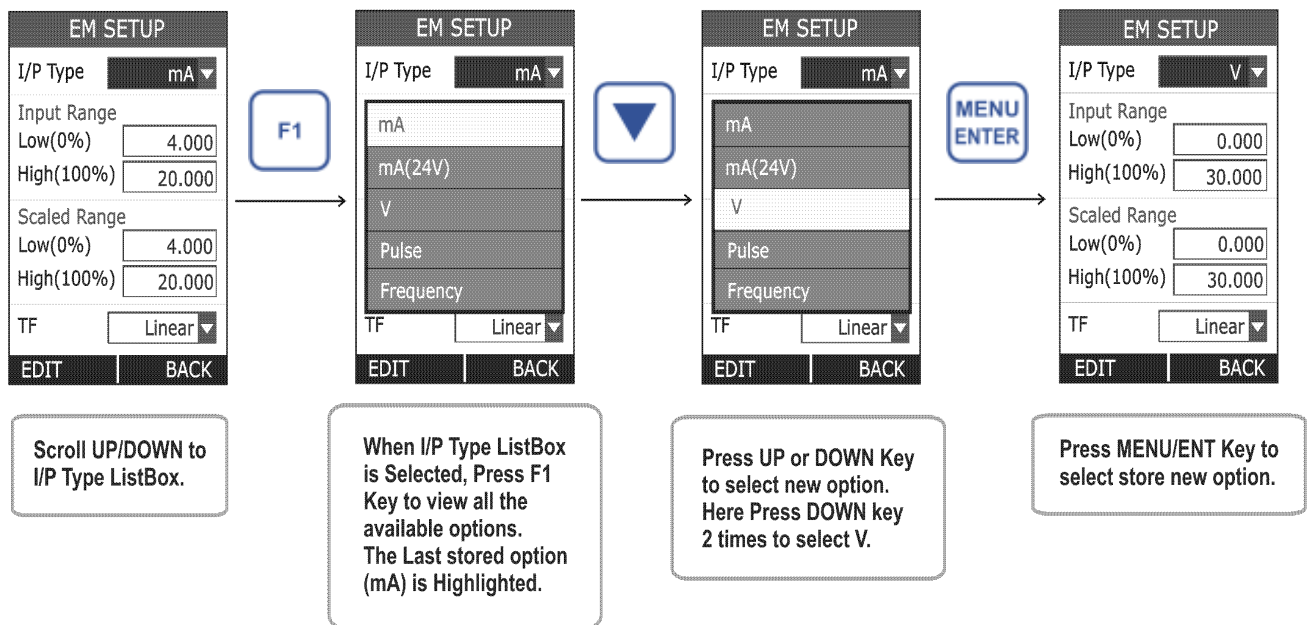

- **EditBox**

Edit Box is used where a large range of value can be possible for a parameter.

To edit the value of an EditBox press **F1** key. After that EditBox enters into the Edit mode where **F1&F2** keys are works as shifter. User can shift to desired digit and using **UP** or **DOWN** key digit value can be increment or decrement. The modified value can be save using **MENU/ENT** key.

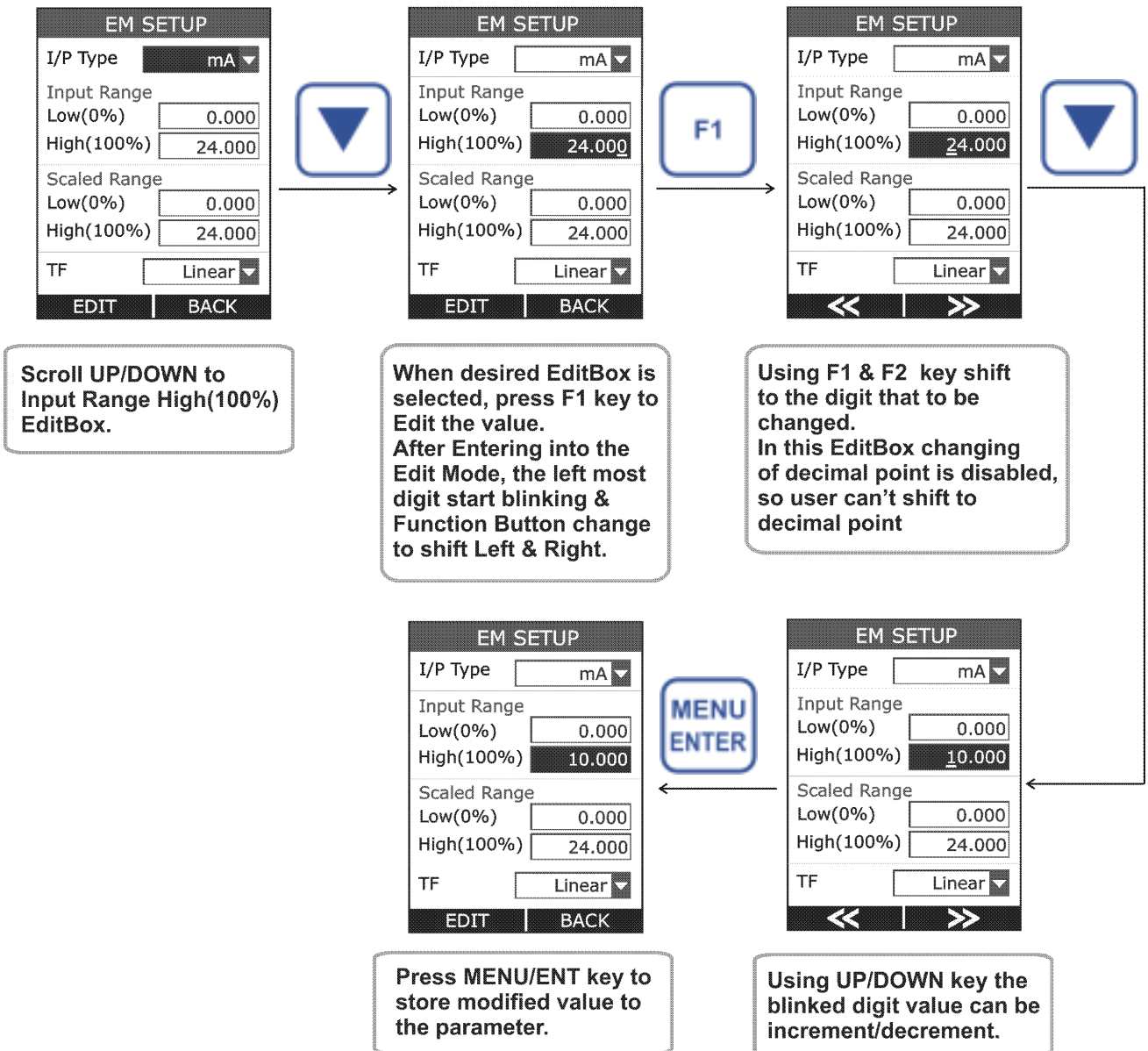

The above figure shows the example how to change Input High (100%) Range from 24.000 to 10.000 mA.

There are mainly 2 types of EditText in this device. In most of the EditText changing of decimal point & changing of sign is not allowed. But there are few EditText, where these are allowed. Examples Scaled Low (0%) & High (100%) etc.

The below figure shown the example how to change decimal point of the Input Scaled High (100%) Range.

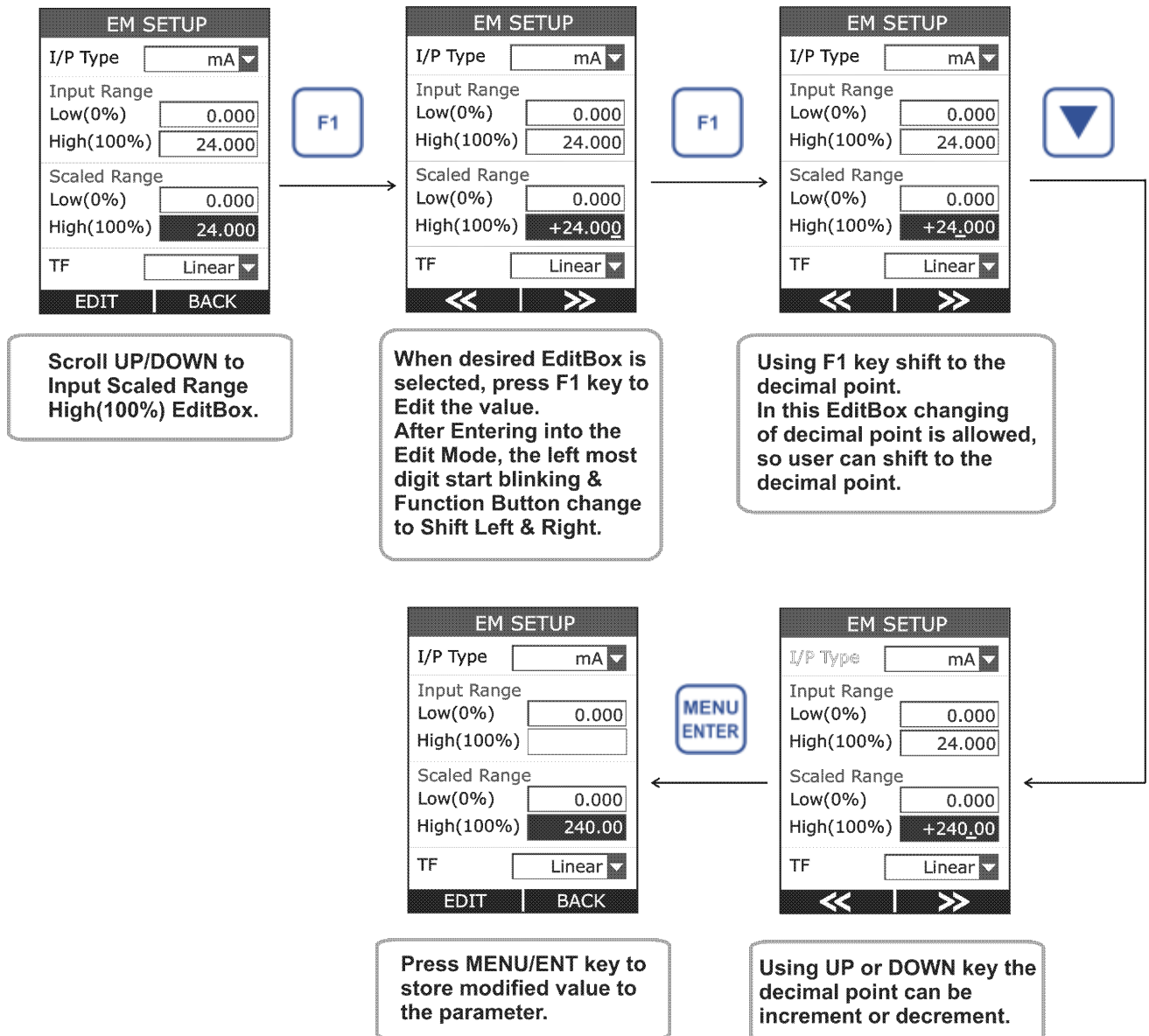

To change the sign of the value, shift to the sign digit and pressing UP or DOWN key will toggle the sign.

- Checkbox

CheckBox is used where Binary Value (1/0, True/False) is available for any parameter.

To change the CheckBox status press **F1** key. This will enter into the edit mode. In this mode status can be toggled by pressing **F1** key. Press **MENU/ENT** key to store new status.

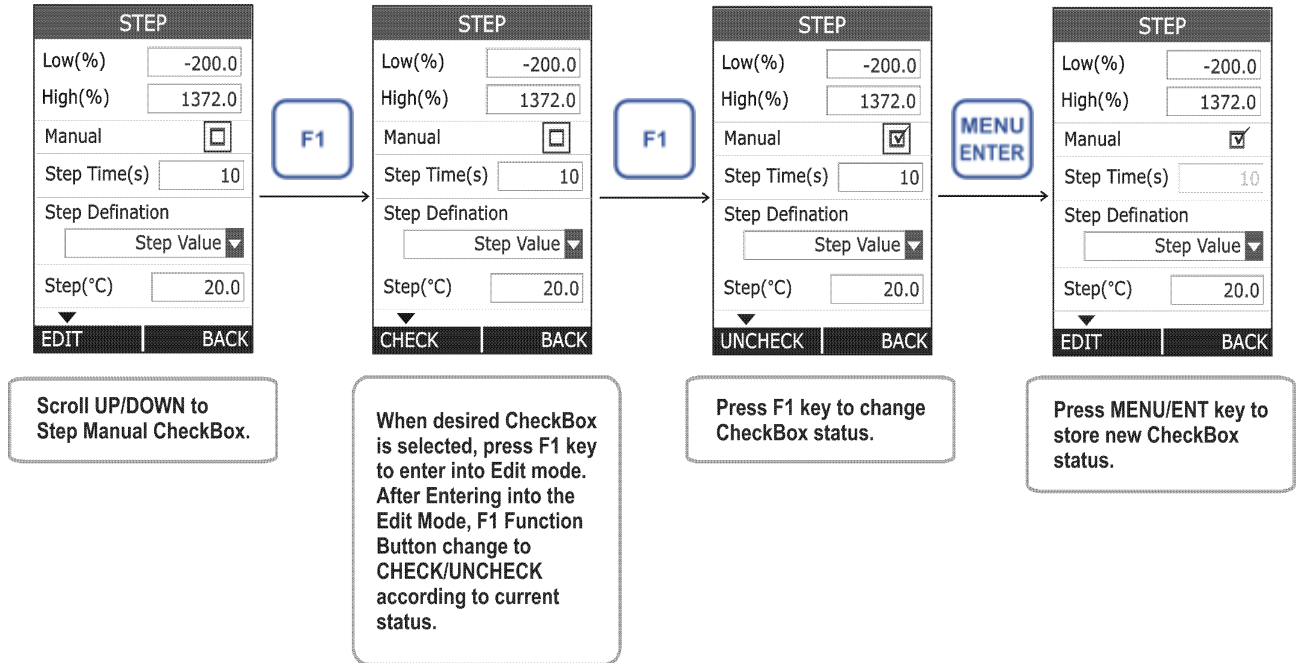

- **RadioButtonBox**

RadioButtonBox is used where very few values can be possible and all the available values need to be visible.

In this device, two types of RadioButtonBox are available. One with 1 value can be selectable & the other where 1 or 2 values can be selectable at a time.

In RadioButtonBox the other option can be selected by pressing MENU/ENT key on that option. When pressing this key the new option will be selected and the other option will be disabled.

Below an example is given, How to change RTD Source Mode from STEP to RAMP.

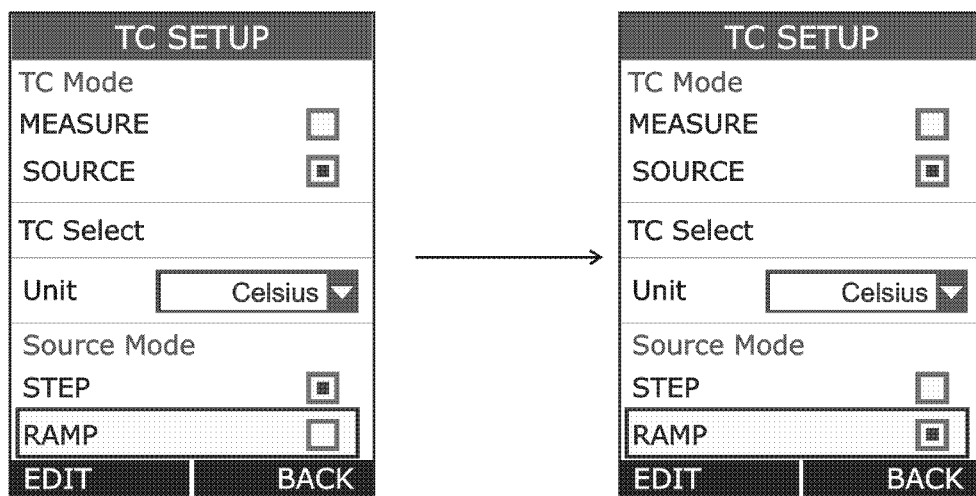

**Scroll UP/DOWN to
Desired RadioButtonBox
option.**

**Press MENU/ENT key
to select the option.
Now the new option is
selected and other
option will be disabled.**

3.2.5 SCR1 and SCR2 Key Option : mQUICK-SETUP Key

PCE-MCA 50 has divided the RUN Screen into Two Parts: SCR1 and SCR2 as shown in below figure. Both windows can independently be configured to display a measurement value.

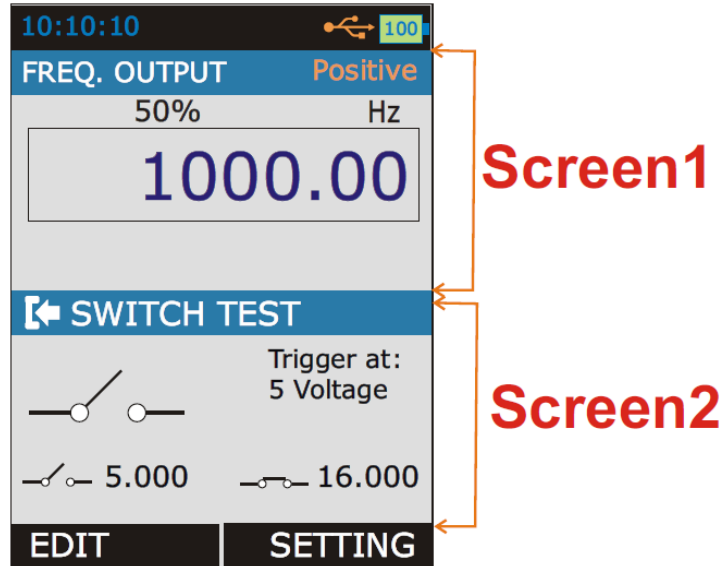

i. SCR1 Display

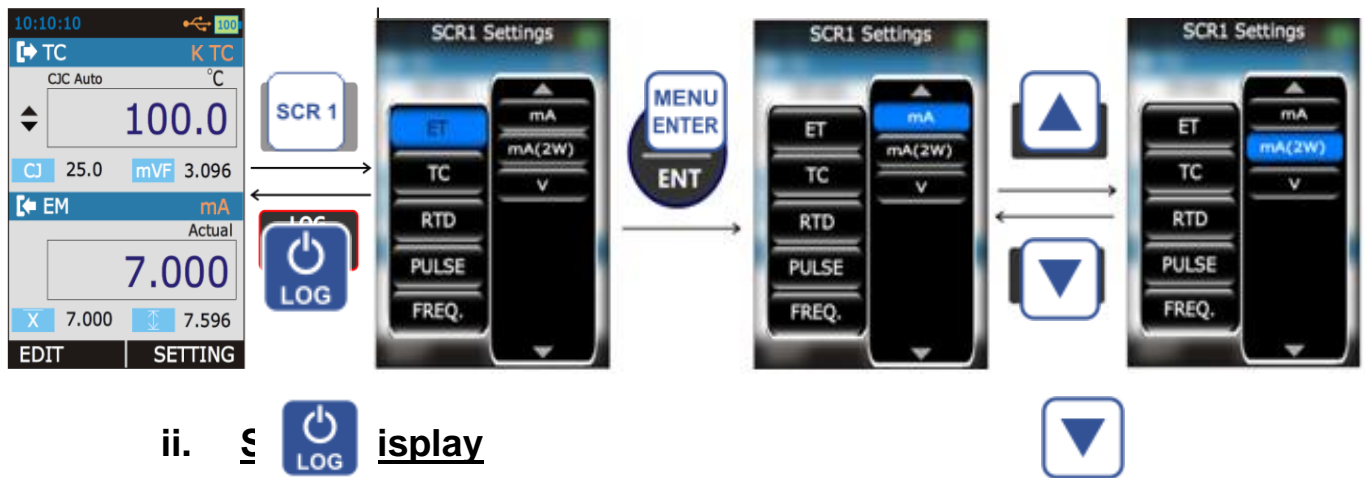

ii. SCR2 Display



4. Menu Layout

4.1 MENU page

There are mainly eight Menus in this device.

To enter into the MENU page press **MENU/ENT** key & press **F2** key to come out from Menu page.

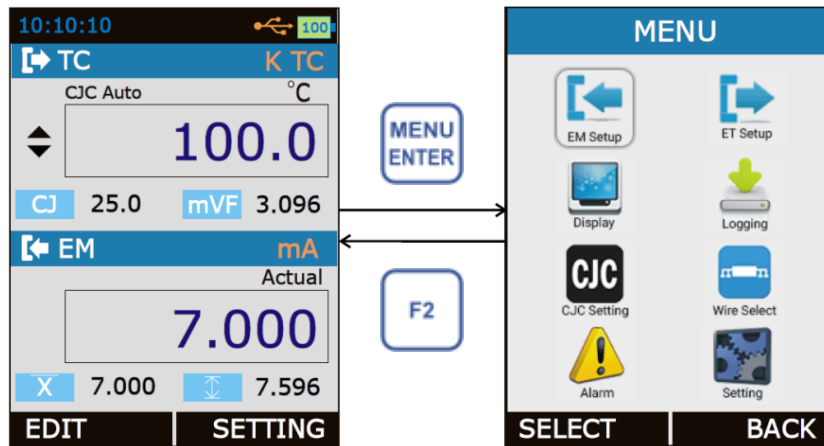

EM SETUP	Contains Parameters related to EM Measure Mode like Input Type, Range etc.
ET/TC/RTD SETUP	Contains Parameters related to RTDlikeRTD Mode, RTD Type etc.
DISPLAY	Contains Parameters related to different display mode for RUN page
LOGGING	Contains Parameters related to Data Logging.
CJC Setting	Contains Parameters related to CJC setting
Wire Select	Contains Parameters related to wire selection mode
Alarm	Contains Parameters related to Alarm
Setting	Contains Parameters related to General Settings of the device like display, Date/Time, Calibration, Reset, etc.

4.2 MEASURE Page

This Page is appears in *RUN* → *MENU* → *EM SETUP*.

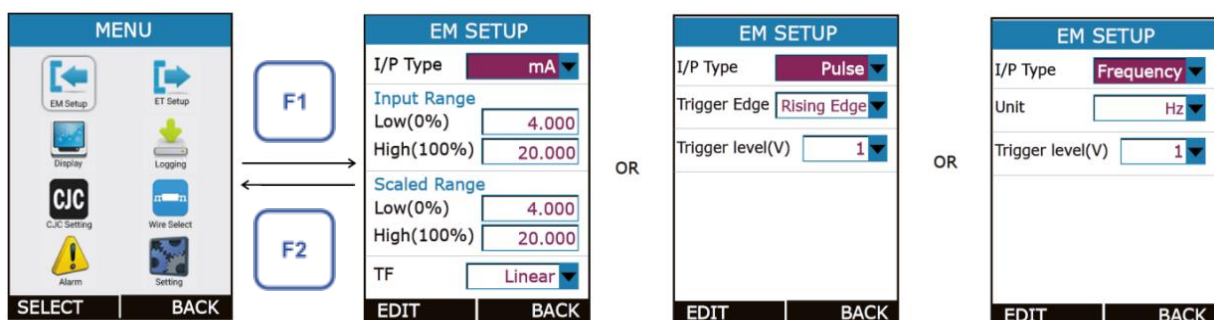

This page contains parameters related to EM Measure like Input Type, Input Range, Scaling and Transfer Function. The Description of the Parameters appear on this page is given below.

Parameter Name	Description / Options
I/P Type (Input Type)	Measure Input Type <u>Available Options:</u> mA : 0.000 to 24.000 mA DC mA(24V) : 0.000 to 24.000 mA DC V : 0.000 to 30.000 V DC Pulse : 0 to 999999 Pulses Frequency : 0.0143 to 50000Hz
Input Range Low (0%)	Low Range for Measure Input. Only for mA, mA(24V) and V <u>Range:</u> Default Input Low to Input Range High (100%) This parameter is enabled, if Main Display in <i>MENU → DISPLAY → EM SETUP</i> is set to Percentage or Scaled .
Input Range High (100%)	High Range for Measure Input. Only for mA, mA(24V) and V <u>Range:</u> Input Range Low(0%) to Default Input High This parameter is enabled, if Main Display in <i>MENU → DISPLAY → EM SETUP</i> is set to Percentage or Scaled .
Scaled Input Range Low (0%)	Scaling Low Range for Measure Input. Only for mA, mA(24V) and V <u>Range:</u> -99999 to Scaled Input Range High (100%) Decimal Point for this EditBox can be changeable. This parameter is enabled, if Main Display in <i>MENU → DISPLAY → EM SETUP</i> is set to Scaled .
Scaled Input Range High (100%)	Scaling High Range for Measure Input. Only for mA, mA(24V) and V <u>Range:</u> Scaled Input Range Low(0%) to 99999 Decimal Point for this EditBox can be changeable. This parameter is enabled, if Main Display in <i>MENU → DISPLAY → EM SETUP</i> is set to Scaled .
TF (Transfer Function)	Transfer Function for Scaling. Only for mA, mA(24V) and V <u>Available Options:</u> Linear x^2 (x^2) $x^{1/2}$ (\sqrt{x}) This parameter is enabled, if Main Display in <i>MENU → DISPLAY → EM SETUP</i> is set to Scaled .
Trigger Edge	Trigger Edge for Pulse Measure input

	<u>Available Options:</u> Rising Edge Falling Edge
Unit	Unit for Frequency Measure input <u>Available Options:</u> Hz KHz cph cpm 1/Hz (s) 1/KHz (ms)
Trigger Level (V)	Trigger level for Pulse and Frequency Measure input <u>Available Options:</u> 0 to 7 V

4.3 SOURCE Page

4.3.1 ET Setup

This Page is appears in *RUN* → *MENU* → *ET SETUP*.

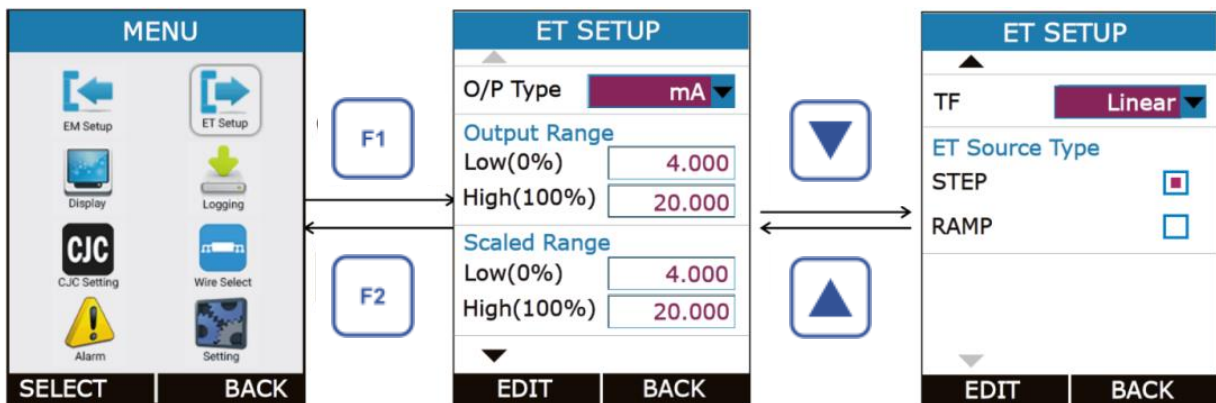

This page contains parameters related to ET like Output Type, Output Range, Scaling, Transfer Function Step and Ramp. The Description of the Parameters appear on this page is given below.

Parameter Name	Description / Options
O/P Type (Output Type)	Source Output Type <u>Available Options:</u> mA : 0.000 to 24.000 mA DC mA(2W) : 0.000 to 24.000 mA DC V : 0.000 to 12.000 V DC

<p>Output Range Low (0%)</p>	<p>Low Range for Source Output.</p> <p><u>Range:</u> Default Output Low to Output Range High (100%)</p> <p>This parameter is enabled, if Main Display in <i>MENU</i> → <i>DISPLAY</i> → <i>SOURCE</i> is set to Percentage or Scaled.</p>
<p>Output Range High (100%)</p>	<p>High Range for Source Output.</p> <p><u>Range:</u> Output Range Low(0%) to Default Output High</p> <p>This parameter is enabled, if Main Display in <i>MENU</i> → <i>DISPLAY</i> → <i>SOURCE</i> is set to Percentage or Scaled.</p>
<p>Scaled Output Range Low (0%)</p>	<p>Scaling Low Range for Source Output.</p> <p><u>Range:</u> -99999 to Scaled Output Range High (100%)</p> <p>Decimal Point for this EditBox can be changeable.</p> <p>This parameter is enabled, if Main Display in <i>MENU</i> → <i>DISPLAY</i> → <i>SOURCE</i> is set to Scaled.</p>
<p>Scaled Output Range High (100%)</p>	<p>Scaling High Range for Source Output</p> <p><u>Range:</u> Scaled Output Range Low(0%) to 99999</p> <p>Decimal Point for this EditBox can be changeable.</p> <p>This parameter is enabled, if Main Display in <i>MENU</i> → <i>DISPLAY</i> → <i>SOURCE</i> is set to Scaled.</p>
<p>TF (Transfer Function)</p>	<p>Transfer Function for Scaling</p> <p><u>Available Options:</u> Linear x^2 (x^2) $x^{(1/2)}$ (\sqrt{x})</p> <p>This parameter is enabled, if Main Display in <i>MENU</i> → <i>DISPLAY</i> → <i>SOURCE</i> is set to Scaled.</p>
<p>Source Type</p>	<p>Source Output Format</p> <p><u>Available Options:</u> STEP RAMP</p> <p>At a time one can be selectable. Press F1 key on the one of the option for more settings.</p>

- **STEP Page:**

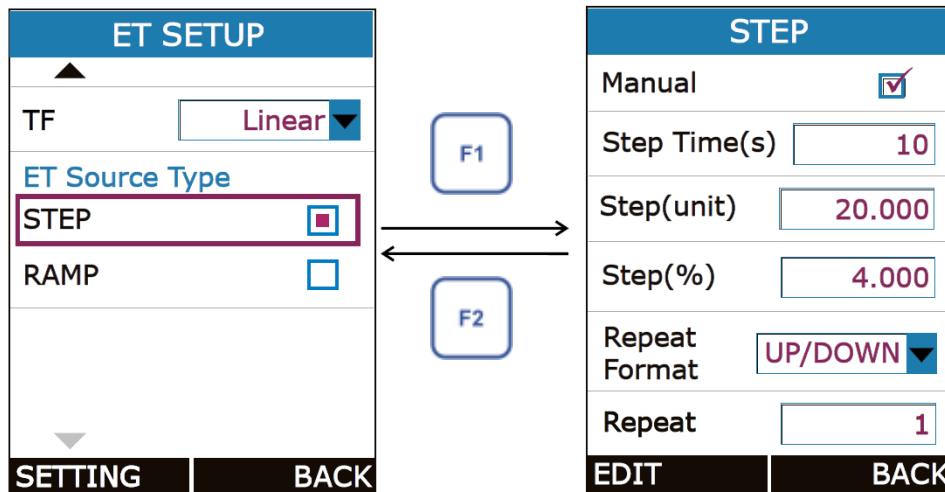

Parameter Name	Description / Options
Manual (Output Type)	Step Manual Mode Selection CheckBox. Ticking this checkbox will enable Step Manual Mode. And Un-ticking will enable Auto Step Mode.
Step Time (s)	Enter the time for a single step in seconds, <u>Range:</u> 1 to 9999 This parameter is enabled only for Auto Step Mode (Manual CheckBox is Un-Checked)
Step(unit) Step Size in unit	Step Size in unit, where unit is changed according to current Output Type and Source Display Mode. Only Specify one Step (unit) or Step (%), the other will automatically change according to the changed parameter. <u>Range:</u> In accordance with Output Range & Source Display Mode. This parameter is disabled, if Main Display in <i>MENU</i> → <i>DISPLAY</i> → <i>SOURCE</i> is set to Percentage .
Step (%) Step Size in Percentage	Step Size in Percentage. Only Specify one Step (unit) or Step (%), the other will automatically change according to the changed parameter. <u>Range:</u> 0.00 to 100.00
Repeat Format	How the stepping should be done. <u>Available Options:</u> UP

	DOWN UP/DOWN DOWN/UP This parameter is enabled only for Auto Step Mode (Manual CheckBox is Un-Checked)
Repeat Repeat Counts	Defines how many times the steps are repeated <u>Range:</u> 1 to 9999 This parameter is enabled only for Auto Step Mode (Manual CheckBox is Un-Checked)

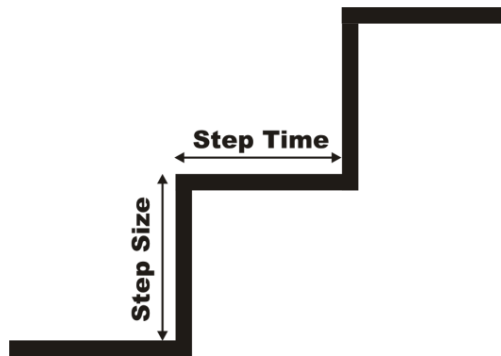

➤ Manual Stepping

To Enable Manual Stepping, select Source Type as STEP & Check the Manual CheckBox.

If this mode is enabled, ▲ ▼ icon will appear in Source Display Window in RUN Page.

Pressing UP or DOWN key in RUN Page will Increment or Decrement Source Value by Step Size specified in STEP Page.

In RUN Page, Source Value can directly change by Pressing **F1** key (EDIT) and modifying value like in EditBox. & STEP Setting can be accessed directly by **F2** key (SETTING).

➤ Auto Stepping

To Enable Auto Stepping, select Source Type as STEP & Un-Check the Manual CheckBox.

If this mode is enabled, ⏏ (Step UP) or ⏏ (Step Down) icon will appear in Source Display Window in RUN Page and F1 & F2 Button change to **START&SETTING** respectively.

Automated Step can be started by Pressing **F1** key (START). After that F1 & F2 key will change to **PAUSE&STOP** respectively. So by pressing F1 & F2 key running STEP can be PAUSE or STOP at any time in RUN Page.

STEP Setting can be accessed directly by **F2** key (SETTING).

Note:

While STEP is running STEP settings can't be accessible and Source Page Parameter settings can't be change. Stop STEP before changing any settings

- **RAMP Page:**

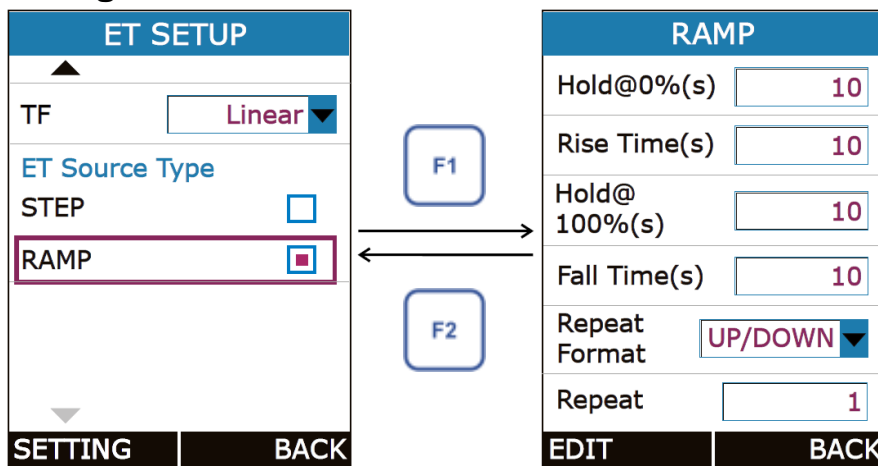



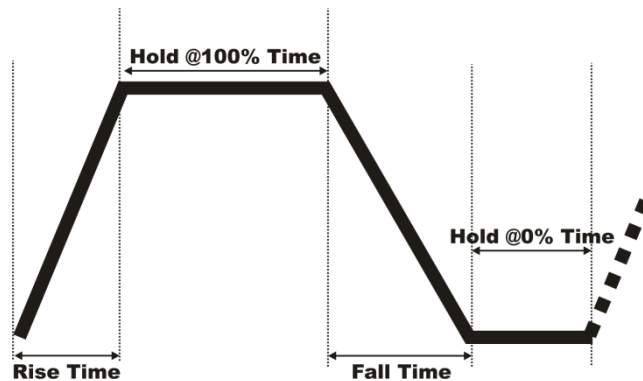

Parameter Name	Description / Options
Hold@0%(s)	Time to wait at Low (0%) level in second. This parameter is use for Repeat Format UP/DOWN or DOWN/UP. Range: 0 to 9999
Rise Time (s)	Time to Increase from Low to High Level. Range: 1 to 9999
Hold@100%(s)	Time to wait at High (100%) level in second. This parameter is use for Repeat Format UP/DOWN or DOWN/UP. Range: 0 to 9999
Fall Time (s)	Time to decrease from High to Low Level. Range: 1 to 9999
Repeat Format	How the Ramp should be done.

	<u>Available Options:</u> UP DOWN UP/DOWN DOWN/UP
Repeat Repeat Counts	Defines how many times the steps are repeated <u>Range:</u> 1 to 9999



➤ **Starting the RAMP**

To Enable Ramp, select Source Type as RAMP.

If this mode is enabled,  (Rising Ramp) or  (Falling Ramp) or  (Ramp Hold @ 100%) or  (Ramp Hold @ 0%) icon will appear in Source Display Window according to current RAMP mode in RUN Page and F1 & F2 Button change to **START&SETTING** respectively.

RAMP can be started by Pressing **F1** key (START). After that F1 & F2 key will change to **PAUSE&STOP** respectively. So by pressing F1 & F2 key running RAMP can be PAUSE or STOP at any time in RUN Page.

Note:

While RAMP is running RAMP settings can't be accessible and Source Page Parameter settings can't be change. Stop RAMP before changing any settings.

4.3.2 TC Setup

This Page is appears in *RUN* → *MENU* → *TC SETUP*.

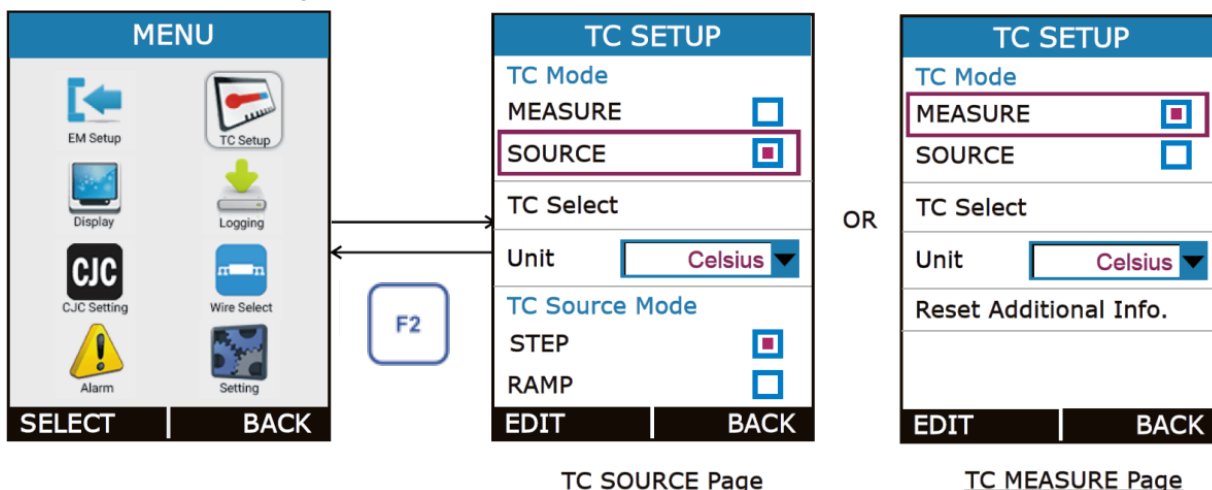

This page contains parameters related to Thermocouple like TC Mode Type, TC Type, Unit, TC Source Mode etc. The Description of the Parameters appear on this page is given below.

Parameter Name	Description / Options																										
TC Mode	Thermocouple Mode <u>Available Options:</u> MEASURE SOURCE																										
TC Select	Select the Thermocouple/mV Type for Measurement / Simulation <u>Available Options:</u> <table border="1" style="width: 100%; border-collapse: collapse;"> <thead> <tr> <th>TC Type</th> <th>Range</th> <th>Resolution</th> </tr> </thead> <tbody> <tr> <td>E TC</td> <td>-200.0 to 1000.0 °C</td> <td rowspan="7" style="text-align: center; vertical-align: middle;">0.1 °C</td> </tr> <tr> <td>J TC</td> <td>-200.0 to 1200.0 °C</td> </tr> <tr> <td>K TC</td> <td>-200.0 to 1372.0 °C</td> </tr> <tr> <td>T TC</td> <td>-200.0 to 400.0 °C</td> </tr> <tr> <td>B TC</td> <td>450.0 to 1800.0 °C</td> </tr> <tr> <td>R TC</td> <td>0.0 to 1750.0 °C</td> </tr> <tr> <td>S TC</td> <td>0.0 to 1750.0 °C</td> </tr> <tr> <td>N TC</td> <td>-200.0 to 1300.0 °C</td> <td rowspan="3" style="text-align: center; vertical-align: middle;">0.001 mV</td> </tr> <tr> <td>-10 to 80 mV</td> <td>-10.000 to 80.000 mV</td> </tr> <tr> <td>-10 to 250 mV</td> <td>-10.00 to 250.00 mV</td> <td style="text-align: center; vertical-align: middle;">0.01 mV</td> </tr> </tbody> </table> Refer section 6 on page 74 for more details on TC type and its available range.	TC Type	Range	Resolution	E TC	-200.0 to 1000.0 °C	0.1 °C	J TC	-200.0 to 1200.0 °C	K TC	-200.0 to 1372.0 °C	T TC	-200.0 to 400.0 °C	B TC	450.0 to 1800.0 °C	R TC	0.0 to 1750.0 °C	S TC	0.0 to 1750.0 °C	N TC	-200.0 to 1300.0 °C	0.001 mV	-10 to 80 mV	-10.000 to 80.000 mV	-10 to 250 mV	-10.00 to 250.00 mV	0.01 mV
TC Type	Range	Resolution																									
E TC	-200.0 to 1000.0 °C	0.1 °C																									
J TC	-200.0 to 1200.0 °C																										
K TC	-200.0 to 1372.0 °C																										
T TC	-200.0 to 400.0 °C																										
B TC	450.0 to 1800.0 °C																										
R TC	0.0 to 1750.0 °C																										
S TC	0.0 to 1750.0 °C																										
N TC	-200.0 to 1300.0 °C	0.001 mV																									
-10 to 80 mV	-10.000 to 80.000 mV																										
-10 to 250 mV	-10.00 to 250.00 mV		0.01 mV																								
TC Unit Unit	Measure/Source Reading Unit <u>Available Options:</u> Celsius Fahrenheit Kelvin																										

Source Mode	TC Source Output Format This option appear only if TC Mode is <i>SOURCE</i> . <u>Available Options:</u> STEP RAMP At a time one can be selectable. Press F1 key on the one of the option for more settings.
Reset Additional Info.	Reset the Additional Information of Measure mode like Minimum & Maximum This option appear only if TC Mode is <i>MEASURE</i> .

• **STEP Page:**

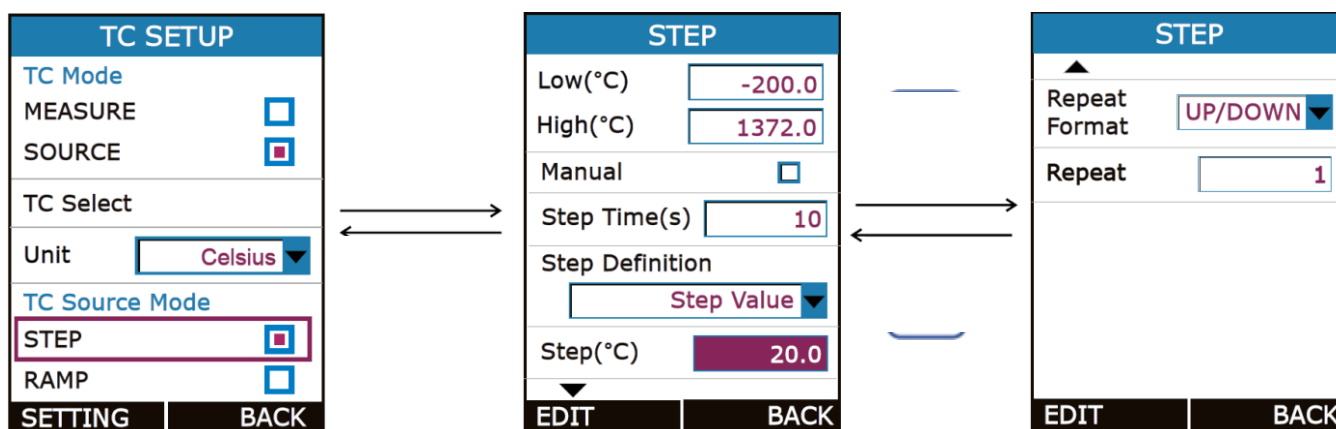

Parameter Name	Description / Options
Low	Starting Value of Step. Enter value according to TC Display Mode. If display mode is actual enter value in temperature/mV and if display mode is % enter value in %.
High	Ending Value of Step. Enter value according to TC Display Mode. If display mode is actual enter value in temperature/mV and if display mode is % enter value in %.
Manual (Output Type)	Step Manual Mode Selection CheckBox. Ticking this checkbox will enable Step Manual Mode. And Un-ticking will enable Auto Step Mode.
Step Time (s)	Enter the time for a single step in seconds, <u>Range:</u> 1 to 9999 This parameter is enabled only for Auto Step Mode (Manual CheckBox is Un-Checked)

Step Definition	<p>Step Definition for the Step function.</p> <p><u>Available Options:</u> Temperature (Appear only if TC Display mode is Actual) Percentage (Appear only if TC Display mode is Percentage) User Defined</p>
Step	<p>Step Value in Temperature/mV/% according to TC Display Mode and TC unit. Only appear if Step Definition is Temperature or Percentage.</p>
Define Steps	<p>User Defined Step value for Manual and Auto Step Mode. This option appear only if Step Definition is User Defined. Maximum 10 step value can be configured. First enter the no of step and then define step value in serial order.</p>
Repeat Format	<p>How the stepping should be done.</p> <p><u>Available Options:</u> UP DOWN UP/DOWN DOWN/UP</p> <p>This parameter is enabled only for Auto Step Mode (Manual CheckBox is Un-Checked)</p>
Repeat Repeat Counts	<p>Defines how many times the steps are repeated</p> <p><u>Range:</u> 1 to 9999</p> <p>This parameter is enabled only for Auto Step Mode (Manual CheckBox is Un-Checked)</p>

Note:-

For Manual Stepping and Auto Stepping refer ET Setup Section 4.3.1.

• **RAMP Page:**

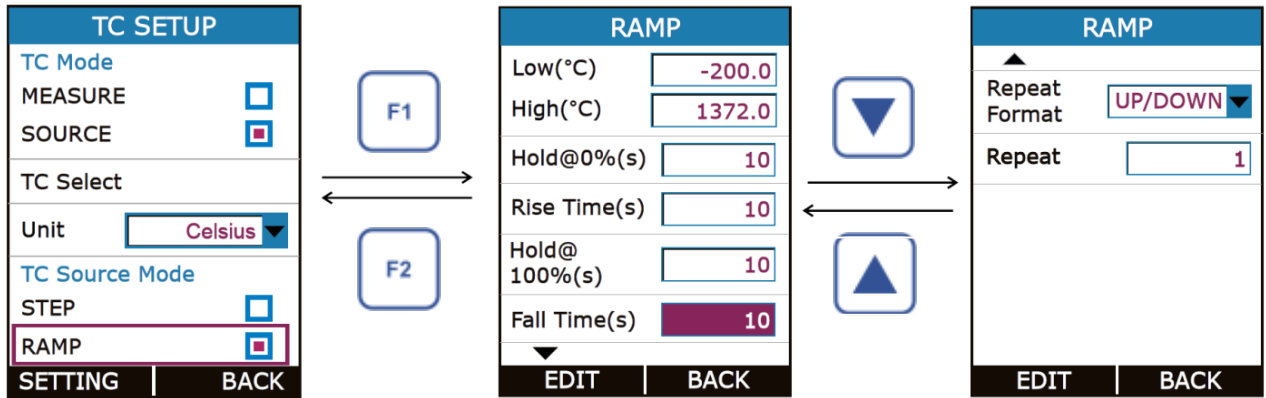

Parameter Name	Description / Options
Low	Starting Value of Ramp. Enter value according to TC Display Mode. If display mode is actual enter value in temperature/mV and if display mode is % enter value in %.
High	Ending Value of Ramp. Enter value according to TC Display Mode. If display mode is actual enter value in temperature/mV and if display mode is % enter value in %.
Hold@0%(s)	Time to wait at Low (0%) level in second. This parameter is use for Repeat Format UP/DOWN or DOWN/UP . <u>Range:</u> 0 to 9999
Rise Time (s)	Time to Increase from Low to High Level. <u>Range:</u> 1 to 9999
Hold@100%(s)	Time to wait at High (100%) level in second. This parameter is use for Repeat Format UP/DOWN or DOWN/UP . <u>Range:</u> 0 to 9999
Fall Time (s)	Time to decrease from High to Low Level. <u>Range:</u> 1 to 9999
Repeat Format	How the Ramp should be done. <u>Available Options:</u> UP DOWN UP/DOWN DOWN/UP
Repeat Repeat Counts	Defines how many times the steps are repeated <u>Range:</u> 1 to 9999

Note:-

For Starting the RAMP refer Page no 41 of ET Setup Section

4.3.3 RTD Setup

This Page is appears in *RUN → MENU → RTD SETUP*.

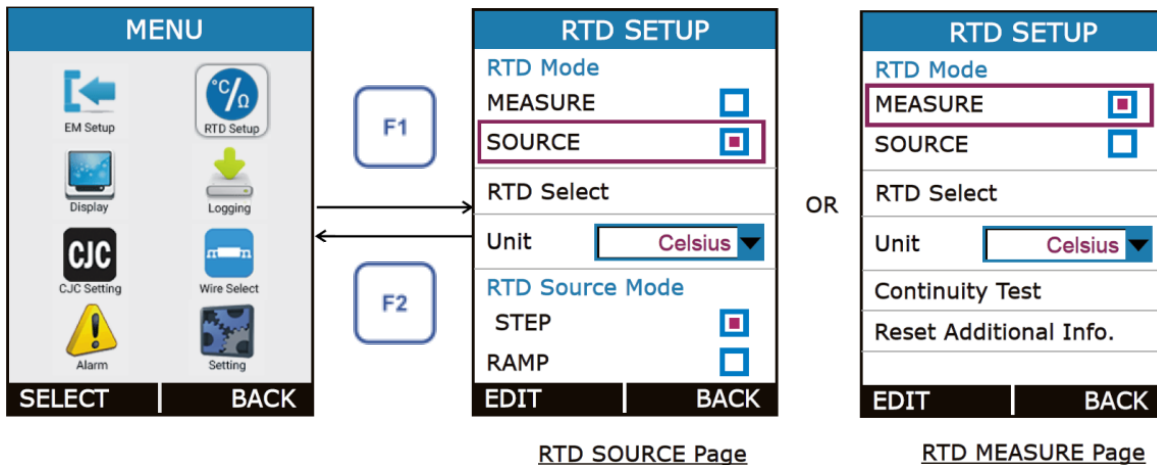

This page contains parameters related to RTD like RTD ModeType, RTD select, Unit, RTD Source Mode etc. The Description of the Parameters appear on this page is given below.

Parameter Name	Description / Options
RTD Mode	RTD Mode <u>Available Options:</u> MEASURE SOURCE
RTD Select	Select the RTD Type for Measurement / Simulation Refer section 6 on page 48 for more details on RTD type and its available range.
Unit	Measure/Source Reading Unit <u>Available Options:</u> Celsius Fahrenheit Kelvin
Continuity Test	To test continuity. This Option appear only if RTD Mode is MEASURE.
Reset Additional Info.	Reset the Additional Info Like Min, Max of RTD. This option appears only if RTD Mode is <i>MEASURE</i> .
RTD Source Mode	RTD Source Output Format This option appears only if RTD Mode is <i>SOURCE</i> . <u>Available Options:</u> STEP RAMP At a time one can be selectable. Press F1 key on the one of the option for more settings.

STEP Page:

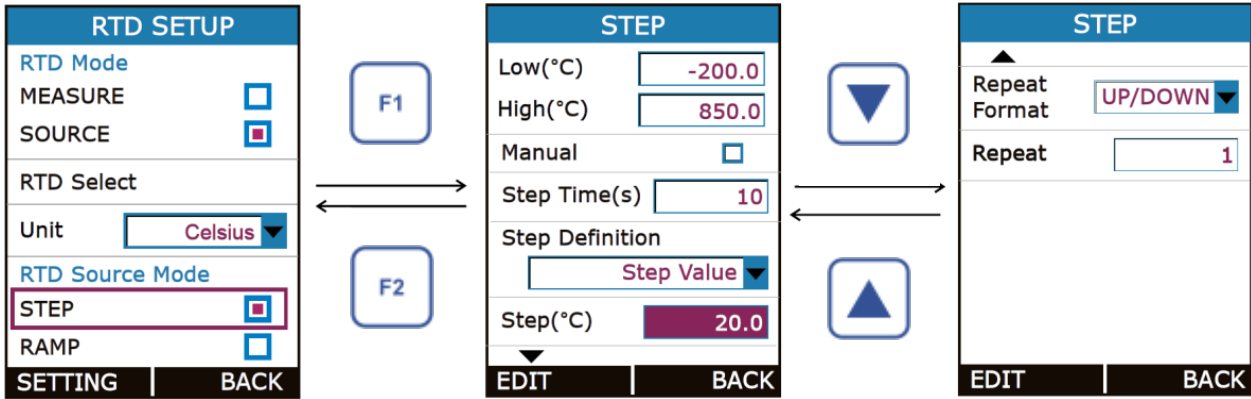

Parameter Name	Description / Options
Low	Starting Value of Step. Enter value according to RTD Display Mode. If display mode is actual enter value in ohms/°C and if display mode is % enter value in %.
High	Ending Value of Step. Enter value according to RTD Display Mode. If display mode is actual enter value in ohms/°C and if display mode is % enter value in %.
Manual (Output Type)	Step Manual Mode Selection CheckBox. Ticking this checkbox will enable Step Manual Mode. And Un-ticking will enable Auto Step Mode.
Step Time (s)	Enter the time for a single step in seconds, <u>Range:</u> 1 to 9999 This parameter is enabled only for Auto Step Mode (Manual CheckBox is Un-Checked)
Step Definition	Step Definition for the Step function. <u>Available Options:</u> Step Value User Defined
Step	Step Value in Temperature/Ohms/% according to RTD Display Mode and RTD unit. Only appears if Step Definition is Step Value.
Define Steps	User Defined Step value for Manual and Auto Step Mode. This option appear only if Step Definition is User Defined. Maximum 10 step value can be configured. First enter the no of step and then define step value in serial order.

Repeat Format	<p>How the stepping should be done.</p> <p><u>Available Options:</u> UP DOWN UP/DOWN DOWN/UP</p> <p>This parameter is enabled only for Auto Step Mode (Manual CheckBox is Un-Checked)</p>
Repeat Repeat Counts	<p>Defines how many times the steps are repeated</p> <p><u>Range:</u> 0 to 9999 (0=infinity)</p> <p>This parameter is enabled only for Auto Step Mode (Manual CheckBox is Un-Checked)</p>

Note:-

For Manual Stepping and Auto Stepping refer Page no – 39, 40 of ET Setup Section.

• **RAMP Page :**

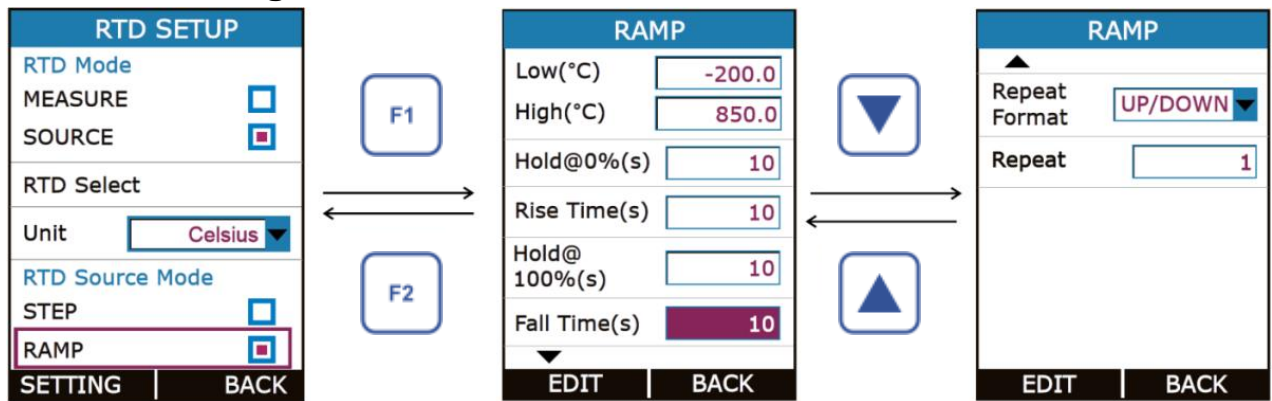

Parameter Name	Description / Options
Low	Starting Value of Ramp. Enter value according to RTD Display Mode. If display mode is actual enter value in ohms and if display mode is % enter value in %.
High	Ending Value of Ramp. Enter value according to RTD Display Mode. If display mode is actual enter value in ohms and if display mode is % enter value in %.
Hold@0%(s)	Time to wait at Low (0%) level in second. This parameter is use for Repeat Format UP/DOWN or DOWN/UP . <u>Range:</u> 0 to 9999
Rise Time (s)	Time to Increase from Low to High Level. <u>Range:</u> 1 to 9999
Hold@100%(s)	Time to wait at High (100%) level in second. This parameter is use for Repeat Format UP/DOWN or DOWN/UP . <u>Range:</u> 0 to 9999
Fall Time (s)	Time to decrease from High to Low Level. <u>Range:</u> 1 to 9999
Repeat Format	How the Ramp should be done. <u>Available Options:</u> UP DOWN UP/DOWN DOWN/UP
Repeat Repeat Counts	Defines how many times the steps are repeated <u>Range:</u> 0 to 9999 (0=infinity)

Note:-For Starting the RAMP refer ET Setup Section 4.3.1

- **Continuity Test:**

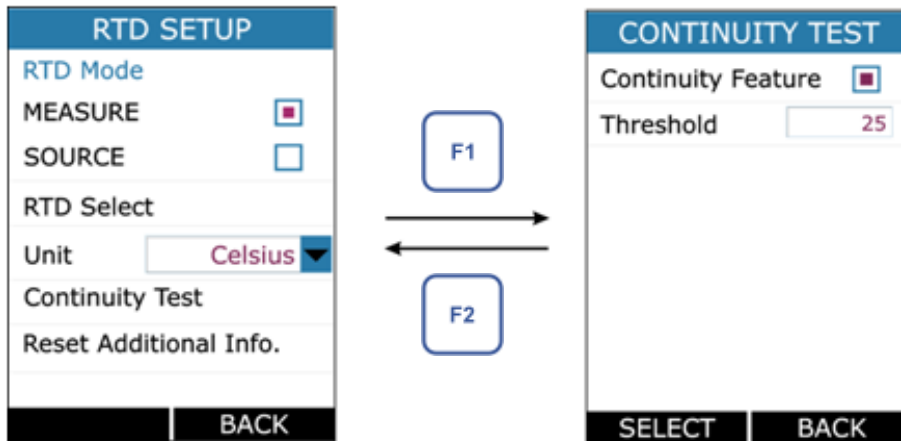

Parameter Name	Description / Options
Continuity Feature	Continuity Feature Selection Radiobuttonbox. Selecting radiobuttonbox will enable continuity feature for RTD Measure Mode.
Threshold	Enter the threshold value of resistance up to which continuity test is applied. <u>Range:</u> 0 to 100

When Testing Continuity Beep sounds and continuity symbol appear on run page as shown in below figure. When resistance between the Ω Measure terminal is less than 25Ω (or defined in threshold parameter). To test the continuity remove power from the circuit to be tested.

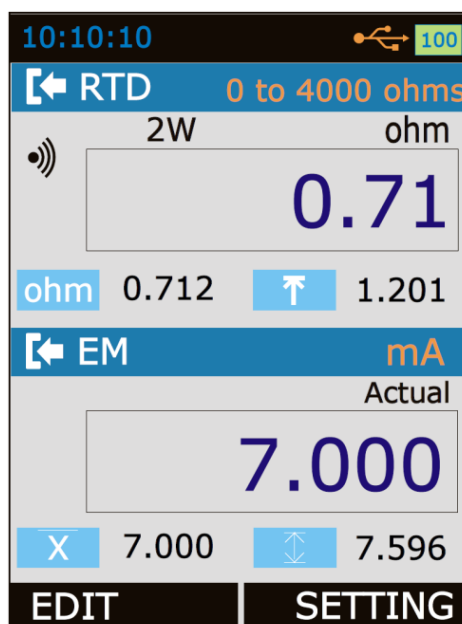





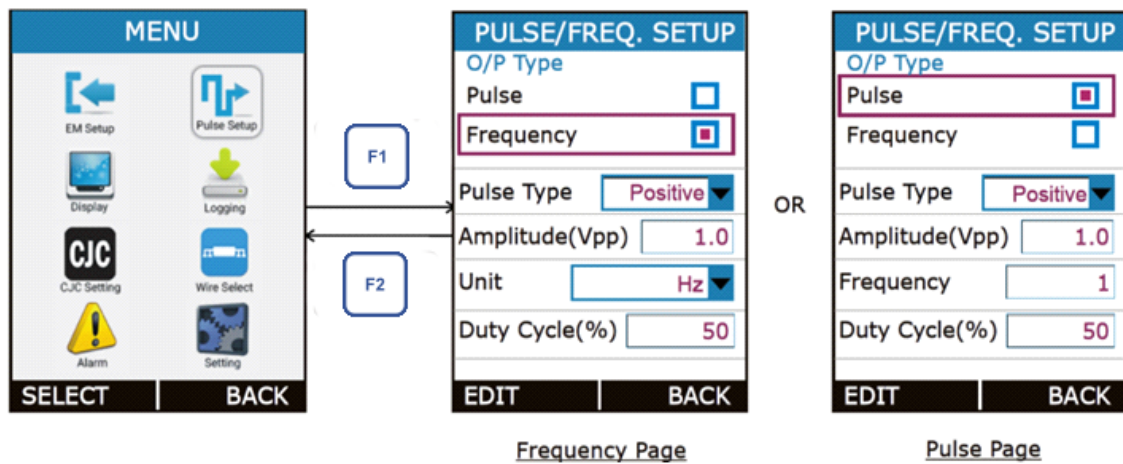
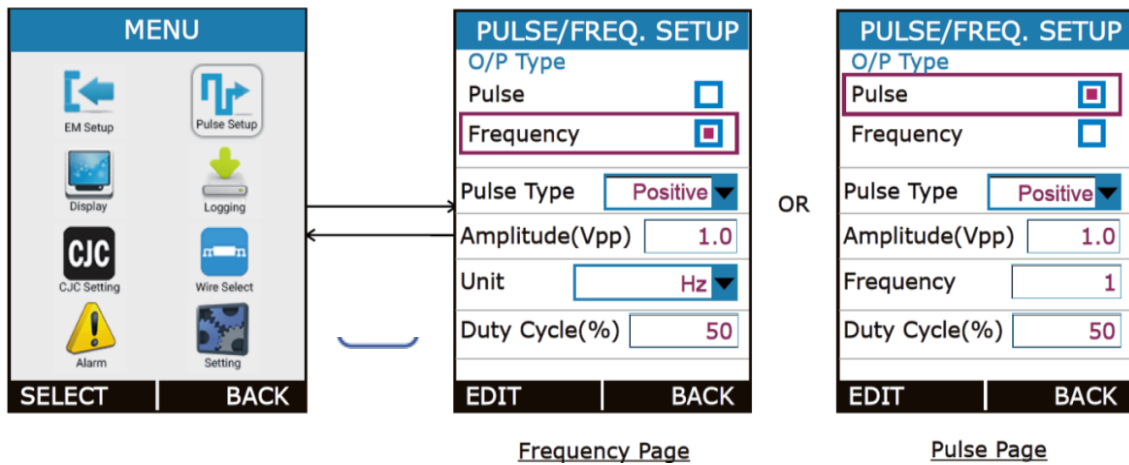

4.3.4 Pulse Setup

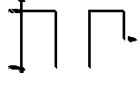
This Page is appears in *RUN* → *MENU* → *PULSE SETUP*.

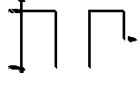

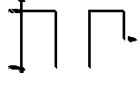
This page contains parameters related to Pulse and Frequency like Pulse type, Amplitude (Vpp), Unit, Frequency, Duty Cycle (%) etc. The Description of the Parameters appear on this page is given below.

Parameter Name	Description / Options						
Pulse Type	<p>Pulse Type</p> <p>Available Options:</p> <table border="1"> <tr> <td>Symmetric</td> <td></td> <td>Displays the symmetric pulse type</td> </tr> <tr> <td>Positive</td> <td></td> <td>Displays the Positive Pulse type</td> </tr> </table>	Symmetric		Displays the symmetric pulse type	Positive		Displays the Positive Pulse type
Symmetric		Displays the symmetric pulse type					
Positive		Displays the Positive Pulse type					
Amplitude(Vpp)	Select the Amplitude of Pulse or Frequency						
Unit	<p>Frequency Unit</p> <p>Available Options:</p> <p>Hz KHz Cpm Cph 1/Hz (s) 1/KHz (ms)</p> <p>This Option appear only if Frequency mode is selected.</p>						
Frequency	To set Frequency. This Option appear only if Pulse mode is selected.						
Duty Cycle (%)	To set the Duty Cycle for Pulse and Frequency (01 – 99% 0 to 999999 pulses)						

4.4 DISPLAY Page

This Page is appears in *RUN* → *MENU* → *DISPLAY*.

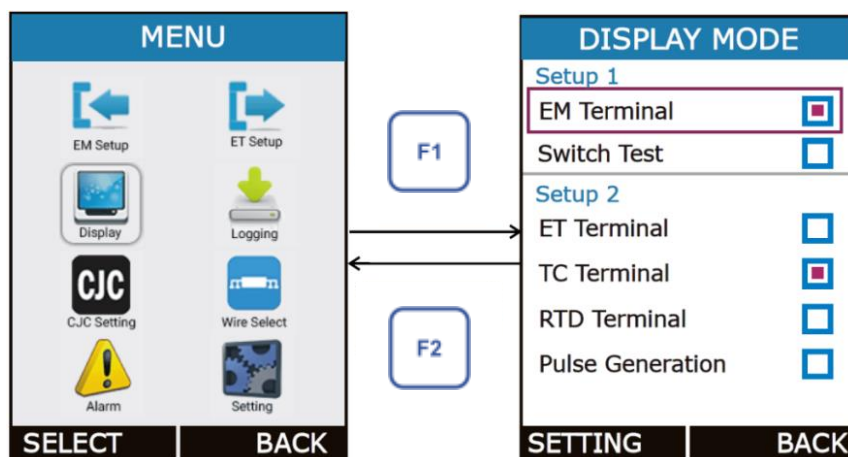

There is mainly six RUN Display Mode possible in this device. And this mode can be selected from the above Page. What information to be shown in each RUN Display Mode can be defined by this page

In this page there is one RadioButtonBox. At a time two option can be selected. The possible combinations are given below.

1	EM + ET
2	EM + TC
3	EM + RTD
4	EM + Pulse Generation
5	Switch Test + ET
6	Switch Test + TC
7	Switch Test + RTD
8	Switch Test + Pulse Generation

4.4.1 EM Display Settings

This Page is appears in *RUN* → *MENU* → *DISPLAY* → *EM Terminal*.

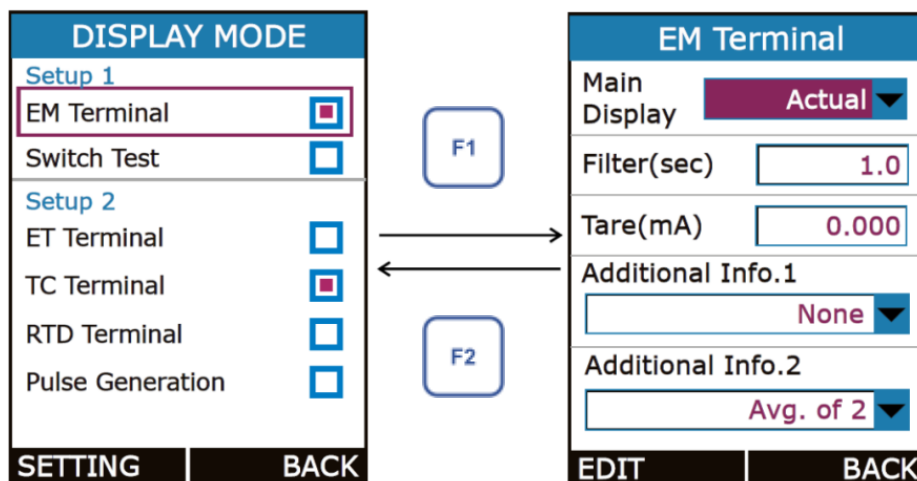

Parameter Name	Description / Options						
Main Display	<p>Select which Reading to be display as a Main Reading (Reading Displays in Box in RUN Page).</p> <p><u>Available Options:</u></p> <table border="1"> <tr> <td>Actual</td> <td>Display the Actual Input Value</td> </tr> <tr> <td>Percentage</td> <td>Display the Percentage Value of the Input. The Value depends on Input Range. These settings are available from <i>MENU</i> → <i>EM SETUP</i>.</td> </tr> <tr> <td>Scaled</td> <td>Display the Scaled Value of the Input. The Scale Value depends on Input Range, Input Scaled Range & Transfer Function. These settings are available from <i>MENU</i> → <i>EM SETUP</i>.</td> </tr> </table>	Actual	Display the Actual Input Value	Percentage	Display the Percentage Value of the Input. The Value depends on Input Range. These settings are available from <i>MENU</i> → <i>EM SETUP</i> .	Scaled	Display the Scaled Value of the Input. The Scale Value depends on Input Range, Input Scaled Range & Transfer Function. These settings are available from <i>MENU</i> → <i>EM SETUP</i> .
Actual	Display the Actual Input Value						
Percentage	Display the Percentage Value of the Input. The Value depends on Input Range. These settings are available from <i>MENU</i> → <i>EM SETUP</i> .						
Scaled	Display the Scaled Value of the Input. The Scale Value depends on Input Range, Input Scaled Range & Transfer Function. These settings are available from <i>MENU</i> → <i>EM SETUP</i> .						
Filter(sec)	<p>1st Order IIR Low Pass Filter for Input Reading. Filter is useful when a measurement signal contains unwanted noise.</p> <p><u>Range:</u> 0.0 to 60.0 sec</p>						
Tare(unit)	<p>The Tare value is subtracted from the reading of the measured value. Here unit is changed according to current Input Type and Measure Display Mode.</p> <p><u>Range:</u> In accordance with Input Range & Measure Display Mode.</p> <p>Note: Beware of the problems that may result in not seeing the true measurement value.</p>						

4.4.2 Switch test Display Settings

This Page is appears in *RUN* → *MENU* → *DISPLAY* → *SWITCH TEST*.

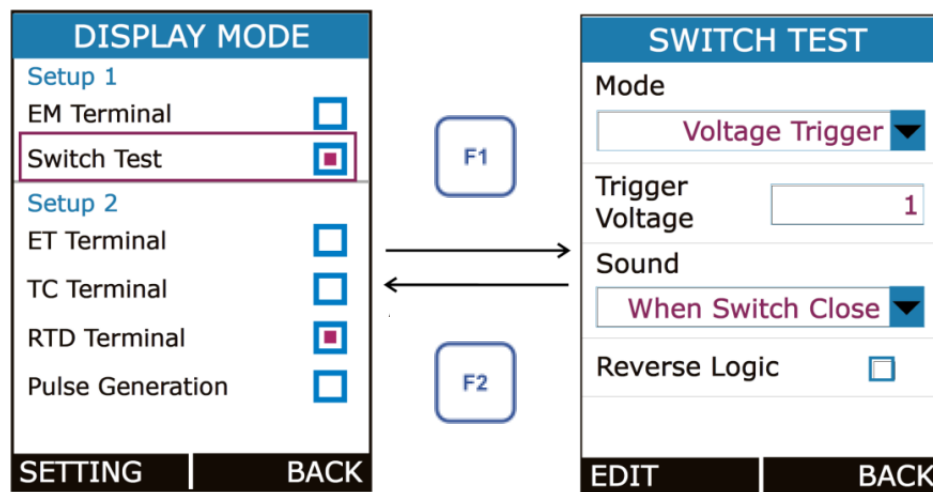

Parameter Name	Description / Options				
Mode	<p>Switch Test Operation Mode</p> <p><u>Available Options:</u></p> <table border="1"> <tr> <td>2V(24Vdc,26mA)</td> <td>Switch Close when External Switch (Potential Free Contacts) short & Switch Open is External Switch open.</td> </tr> <tr> <td>Voltage Trigger</td> <td>Switch Close when Input Voltage > Trigger Voltage Switch Open when Input Voltage < Trigger Voltage</td> </tr> </table> <p>All the MEASURE Page parameters are disabled if Switch Test Display Mode is selected.</p>	2V(24Vdc,26mA)	Switch Close when External Switch (Potential Free Contacts) short & Switch Open is External Switch open.	Voltage Trigger	Switch Close when Input Voltage > Trigger Voltage Switch Open when Input Voltage < Trigger Voltage
2V(24Vdc,26mA)	Switch Close when External Switch (Potential Free Contacts) short & Switch Open is External Switch open.				
Voltage Trigger	Switch Close when Input Voltage > Trigger Voltage Switch Open when Input Voltage < Trigger Voltage				
Trigger Voltage	<p>Trigger Voltage value for Voltage Trigger Switch Test Mode.</p> <p><u>Range:</u> 0 to 30 V</p> <p>Enable only for Switch Test Mode as Voltage Trigger.</p>				
Sound	<p>Sound Setting for Switch Test Mode</p> <p><u>Available Options:</u> Off When Switch Close When Switch Open</p>				
Reverse Logic	<p>Switch Test Switch Logic Reverse Selection.</p> <p>Switch Open-Close Logic Reverse if this CheckBox is Checked.</p>				

4.4.3 ET Display Settings

This Page is appears in *RUN* → *MENU* → *DISPLAY* → *ET Terminal*.

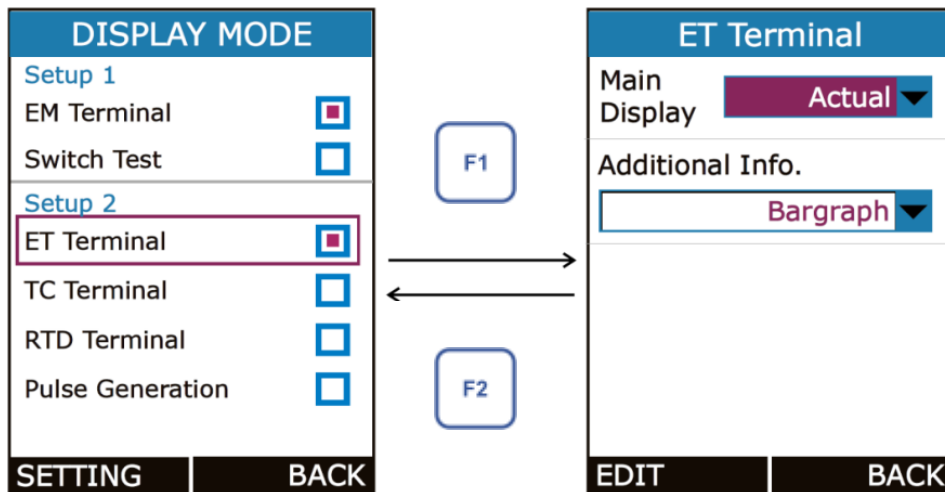

Parameter Name	Description / Options												
Main Display	<p>Select which Reading to be display as a Main Reading (Reading Displays in Box in RUN Page).</p> <p><u>Available Options:</u></p> <table border="1"> <tr> <td>Actual</td> <td>Display the Actual Output Value</td> </tr> <tr> <td>Percentage</td> <td> Display the Percentage Value of the Output. The Value depends on Output Range. These settings are available from <i>MENU</i> → <i>SOURCE</i>. </td> </tr> <tr> <td>Scaled</td> <td> Display the Scaled Value of the Output. The Scale Value depends on Output Range, Output Scaled Range & Transfer Function. These settings are available from <i>MENU</i> → <i>SOURCE</i>. </td> </tr> </table>	Actual	Display the Actual Output Value	Percentage	Display the Percentage Value of the Output. The Value depends on Output Range. These settings are available from <i>MENU</i> → <i>SOURCE</i> .	Scaled	Display the Scaled Value of the Output. The Scale Value depends on Output Range, Output Scaled Range & Transfer Function. These settings are available from <i>MENU</i> → <i>SOURCE</i> .						
Actual	Display the Actual Output Value												
Percentage	Display the Percentage Value of the Output. The Value depends on Output Range. These settings are available from <i>MENU</i> → <i>SOURCE</i> .												
Scaled	Display the Scaled Value of the Output. The Scale Value depends on Output Range, Output Scaled Range & Transfer Function. These settings are available from <i>MENU</i> → <i>SOURCE</i> .												
Additional Info.1	<p>Choose which information to be shown in Bottom Right side of the Source Window on RUN Page.</p> <p><u>Available Options:</u></p> <table border="1"> <thead> <tr> <th>Options</th> <th>Icon</th> <th>Description</th> </tr> </thead> <tbody> <tr> <td>None</td> <td>-</td> <td>No info is visible.</td> </tr> <tr> <td>Bar graph</td> <td>-</td> <td>Shows the Horizontal bar Graph in 0% to 100% scale. The value in Bar Graph depends on the Display Mode and Source settings</td> </tr> <tr> <td>Actual Value</td> <td>AV</td> <td>Shows the Actual Output Value. This option is not appear if Main Display is Actual.</td> </tr> </tbody> </table>	Options	Icon	Description	None	-	No info is visible.	Bar graph	-	Shows the Horizontal bar Graph in 0% to 100% scale. The value in Bar Graph depends on the Display Mode and Source settings	Actual Value	AV	Shows the Actual Output Value. This option is not appear if Main Display is Actual .
Options	Icon	Description											
None	-	No info is visible.											
Bar graph	-	Shows the Horizontal bar Graph in 0% to 100% scale. The value in Bar Graph depends on the Display Mode and Source settings											
Actual Value	AV	Shows the Actual Output Value. This option is not appear if Main Display is Actual .											

4.4.4 TC Display Settings



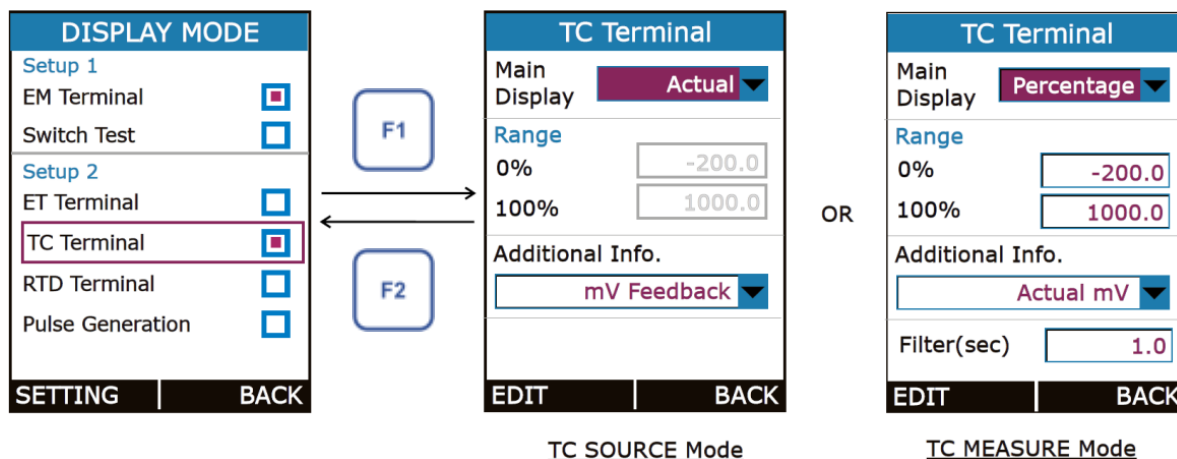



This Page is appears in *RUN* → *MENU* → *DISPLAY* → *TC Terminal*.



Parameter Name	Description / Options																					
Main Display	Select which Reading to be display as a Main Reading (Reading Displays in Box in RUN Page). <u>Available Options:</u> <table border="1"> <tr> <td>Actual</td> <td>Display the Actual Thermocouple/mV Value</td> </tr> <tr> <td>Percentage</td> <td>Display the Percentage Value of Thermocouple/mV according to value set in 0% & 100%.</td> </tr> </table>	Actual	Display the Actual Thermocouple/mV Value	Percentage	Display the Percentage Value of Thermocouple/mV according to value set in 0% & 100%.																	
Actual	Display the Actual Thermocouple/mV Value																					
Percentage	Display the Percentage Value of Thermocouple/mV according to value set in 0% & 100%.																					
0%	Low Value in Temperature/mV for (0-100%) scaling.																					
100%	High Value in Temperature/mV for (0-100%) scaling.																					
Additional Info.1	Choose which information to be shown as TC Mode Additional Information on RUN Page. <u>Available Options for TC Measure Mode:</u> <table border="1"> <thead> <tr> <th>Options</th> <th>Icon</th> <th>Description</th> </tr> </thead> <tbody> <tr> <td>None</td> <td>-</td> <td>No info is visible.</td> </tr> <tr> <td>Actual Value</td> <td>AV</td> <td>Shows the Actual Thermocouple Temperature/mV value without any scaling. This option is available only if TC Display Mode is Percentage.</td> </tr> <tr> <td>mV</td> <td>mV</td> <td>Shows the Thermovoltage which is measured through TC terminals.</td> </tr> <tr> <td>mV w/o CJC</td> <td>mV₀</td> <td>Shows the Thermovoltage according to TC Temperature with adding CJ Temperature mV.</td> </tr> <tr> <td>Maximum</td> <td>↑</td> <td>Shows the Maximum measured reading from the time when info last reset.</td> </tr> <tr> <td>Minimum</td> <td>↓</td> <td>Shows the Minimum measured reading from the time when info last reset.</td> </tr> </tbody> </table>	Options	Icon	Description	None	-	No info is visible.	Actual Value	AV	Shows the Actual Thermocouple Temperature/mV value without any scaling. This option is available only if TC Display Mode is Percentage.	mV	mV	Shows the Thermovoltage which is measured through TC terminals.	mV w/o CJC	mV ₀	Shows the Thermovoltage according to TC Temperature with adding CJ Temperature mV.	Maximum	↑	Shows the Maximum measured reading from the time when info last reset.	Minimum	↓	Shows the Minimum measured reading from the time when info last reset.
Options	Icon	Description																				
None	-	No info is visible.																				
Actual Value	AV	Shows the Actual Thermocouple Temperature/mV value without any scaling. This option is available only if TC Display Mode is Percentage.																				
mV	mV	Shows the Thermovoltage which is measured through TC terminals.																				
mV w/o CJC	mV ₀	Shows the Thermovoltage according to TC Temperature with adding CJ Temperature mV.																				
Maximum	↑	Shows the Maximum measured reading from the time when info last reset.																				
Minimum	↓	Shows the Minimum measured reading from the time when info last reset.																				

Min & Max		Shows the Minimum (in place of mV_0) and Maximum value both together. This option available only for only TC Display mode.
-----------	---	---

Available Options for TC Source Mode:

Options	Icon	Description
None	-	No info is visible.
Actual Value		Shows the Actual Thermocouple Temperature/mV value without any scaling. This option is available only if TC Display Mode is Percentage.
mV		Shows the Thermovoltage according to Temperature including CJ temperature mV. The mV which is sourced through TC Terminal.
Reading Feedback		Shows the Feedback Temperature/mV Reading. When PCE-MCA 50 generate mV, it uses its own measurement function to control the generated value. This feedback measurement is shows if this option is selected.
%Error		Shows the error in % between the Desired Source Value and Feedback value.
mV Feedback		Shows the Feedback mV Reading.
mV w/o CJC		Shows the Thermovoltage according to Temperature (for CJ Temperature = 0 °C)

Filter(sec)

1st Order IIR Low Pass Filter for TC Measure Reading. This option is available only for TC mode is Measure. Filter is useful when a measurement signal contains unwanted noise.

Range:
0.0 to 60.0 sec

4.4.5 RTD Display Settings

This Page is appears in *RUN* → *MENU* → *DISPLAY* → *RTD Terminal*.

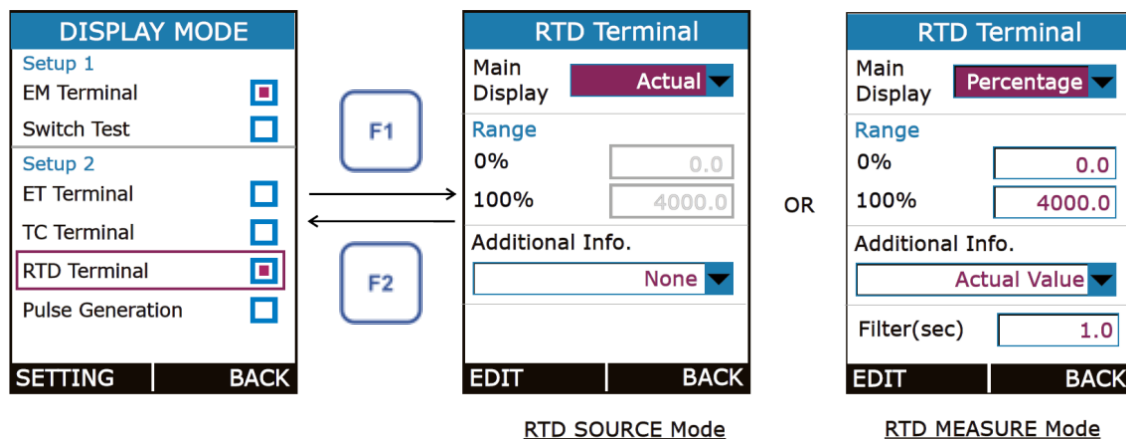

Parameter Name	Description / Options																		
Main Display	<p>Select which Reading to be display as a Main Reading (Reading Displays in Box in RUN Page).</p> <p><u>Available Options:</u></p> <table border="1"> <tr> <td>Actual</td> <td>Display the Actual RTD/Resistance Value</td> </tr> <tr> <td>Percentage</td> <td>Display the Percentage Value of RTD/Resistance according to value set in 0% & 100%.</td> </tr> </table>	Actual	Display the Actual RTD/Resistance Value	Percentage	Display the Percentage Value of RTD/Resistance according to value set in 0% & 100%.														
Actual	Display the Actual RTD/Resistance Value																		
Percentage	Display the Percentage Value of RTD/Resistance according to value set in 0% & 100%.																		
0%	Low Value in Temperature/ohms for (0-100%) scaling.																		
100%	High Value in Temperature/ohms for (0-100%) scaling.																		
Additional Info.1	<p>Choose which information to be shown as RTD Mode Additional Information on RUN Page.</p> <p><u>Available Options for RTD Measure Mode:</u></p> <table border="1"> <thead> <tr> <th>Options</th> <th>Icon</th> <th>Description</th> </tr> </thead> <tbody> <tr> <td>None</td> <td>-</td> <td>No info is visible.</td> </tr> <tr> <td>Actual Value</td> <td>AV</td> <td>Shows the Actual RTD Temperature/ohms value without any scaling. This option is available only if RTD Display Mode is Percentage.</td> </tr> <tr> <td>Maximum</td> <td>↑</td> <td>Shows the Maximum measured reading from the time when info last reset.</td> </tr> <tr> <td>Minimum</td> <td>↓</td> <td>Shows the Minimum measured reading from the time when info last reset.</td> </tr> <tr> <td>Min & Max</td> <td>↑↓</td> <td>Shows the Minimum and Maximum value both together. This option available only for RTDDisplay mode.</td> </tr> </tbody> </table> <p><u>Available Options for RTD Source Mode:</u></p>	Options	Icon	Description	None	-	No info is visible.	Actual Value	AV	Shows the Actual RTD Temperature/ohms value without any scaling. This option is available only if RTD Display Mode is Percentage.	Maximum	↑	Shows the Maximum measured reading from the time when info last reset.	Minimum	↓	Shows the Minimum measured reading from the time when info last reset.	Min & Max	↑↓	Shows the Minimum and Maximum value both together. This option available only for RTDDisplay mode.
Options	Icon	Description																	
None	-	No info is visible.																	
Actual Value	AV	Shows the Actual RTD Temperature/ohms value without any scaling. This option is available only if RTD Display Mode is Percentage.																	
Maximum	↑	Shows the Maximum measured reading from the time when info last reset.																	
Minimum	↓	Shows the Minimum measured reading from the time when info last reset.																	
Min & Max	↑↓	Shows the Minimum and Maximum value both together. This option available only for RTDDisplay mode.																	



	<table border="1"> <thead> <tr> <th data-bbox="464 185 683 230">Options</th> <th data-bbox="683 185 826 230">Icon</th> <th data-bbox="826 185 1406 230">Description</th> </tr> </thead> <tbody> <tr> <td data-bbox="464 230 683 275">None</td> <td data-bbox="683 230 826 275">-</td> <td data-bbox="826 230 1406 275">No info is visible.</td> </tr> <tr> <td data-bbox="464 275 683 427">Actual Value</td> <td data-bbox="683 275 826 427">AV</td> <td data-bbox="826 275 1406 427">Shows the Actual RTD Temperature/ohms value without any scaling. This option is available only if RTD Display Mode is Percentage.</td> </tr> <tr> <td data-bbox="464 427 683 506">Excitation Current</td> <td data-bbox="683 427 826 506">I (EX)</td> <td data-bbox="826 427 1406 506">Shows the current which is sourced by instrument under test.</td> </tr> </tbody> </table>	Options	Icon	Description	None	-	No info is visible.	Actual Value	AV	Shows the Actual RTD Temperature/ohms value without any scaling. This option is available only if RTD Display Mode is Percentage.	Excitation Current	I (EX)	Shows the current which is sourced by instrument under test.
Options	Icon	Description											
None	-	No info is visible.											
Actual Value	AV	Shows the Actual RTD Temperature/ohms value without any scaling. This option is available only if RTD Display Mode is Percentage.											
Excitation Current	I (EX)	Shows the current which is sourced by instrument under test.											
Filter(sec)	<p data-bbox="451 533 1358 633">1st Order IIR Low Pass Filter for RTD Measure Reading. This option is available only for RTD mode is Measure. Filter is useful when a measurement signal contains unwanted noise.</p> <p data-bbox="451 667 651 734"><u>Range:</u> 0.0 to 60.0 sec</p>												

4.5 DATA LOGGING Page

This section gives examples of how to log Readings with time and date over a set time period or on a key press. Logged data is stored in a user defined file in internal memory.

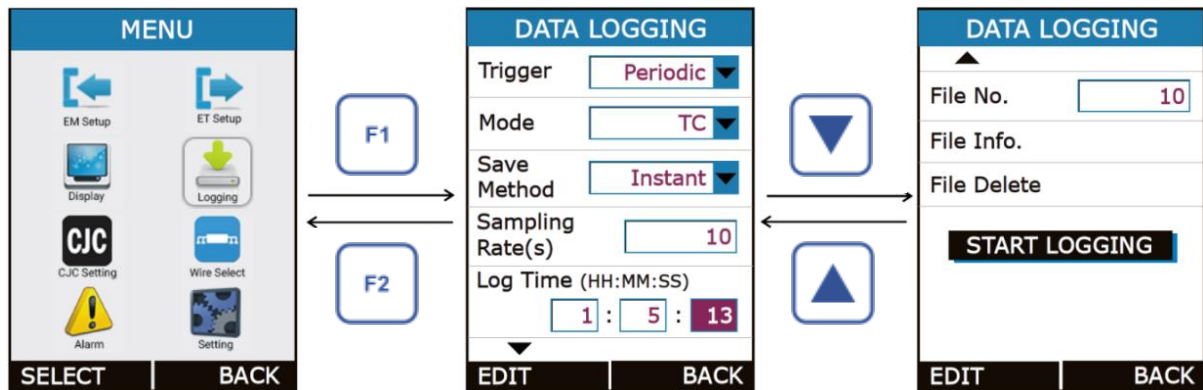
This Page is appears in *RUN* → *MENU* → *LOGGING*.



Parameter Name	Description / Options						
Trigger	<p>Data Logging Trigger Mode Selection.</p> <p><u>Available Options:</u></p> <table border="1"> <tr> <td>Key Press</td> <td>Log Data on pressing  from RUN key Page.</td> </tr> <tr> <td>Periodic</td> <td>Log Data periodically at every Sampling Rate for total time specified by Logging Time.</td> </tr> </table>	Key Press	Log Data on pressing  from RUN key Page.	Periodic	Log Data periodically at every Sampling Rate for total time specified by Logging Time.		
Key Press	Log Data on pressing  from RUN key Page.						
Periodic	Log Data periodically at every Sampling Rate for total time specified by Logging Time.						
Mode	<p>Data Mode Selection for Logging</p> <p><u>Available Options:</u></p> <table border="1"> <tr> <td>EM</td> <td>Log only EM Measure Readings.</td> </tr> <tr> <td>RTD</td> <td>Log only RTD Terminal Readings.</td> </tr> <tr> <td>EM+RTD</td> <td>Log EM Measure and RTD Terminal both Readings.</td> </tr> </table> <p>This parameter is enabled only for Periodic Trigger.</p>	EM	Log only EM Measure Readings.	RTD	Log only RTD Terminal Readings.	EM+RTD	Log EM Measure and RTD Terminal both Readings.
EM	Log only EM Measure Readings.						
RTD	Log only RTD Terminal Readings.						
EM+RTD	Log EM Measure and RTD Terminal both Readings.						
Save Method	<p>Reading Type selection for Logging</p> <p><u>Available Options:</u> Instant Min Max Average All</p> <p>This parameter is enabled only for Periodic Trigger.</p>						

Sampling Rate(s)	Sampling Rate for Periodic Data Logging in seconds. <u>Range:</u> 1 to 9999 This parameter is enabled only for Periodic Trigger.
Logging Time (HH:MM:SS)	Total Logging Time in HH:MM:SS Format for Periodic Logging. This parameter is enabled only for Periodic Trigger.
File No.	File Number. <u>Range:</u> 1 to 25 This parameter is enabled only for Periodic Trigger.
File Info.	Shows the information of stored files. This information contains Logging Start Time & Date and No of Samples stored in the file.
File Delete	Delete stored file.
START LOGGING	Press F1 key while selecting this button to start the Logging.

Notes:

- *Maximum No of Reading that can be stored in,*

Logging Mode	Max. Reading
Periodic	150000
Key Press	430

- *In Periodic mode, changing of any Measure or Source parameter is not allowed. So While Periodic Logging is Running, User can't enter into MEASURE, SOURCE and DISPLAY menu. But in Key Press Logging mode, there is no restriction.*
- *In Periodic Mode, if error message like "Not Sufficient Memory" comes while starting the Logging. Try to Reduce Logging Time or Increase Sampling Period or try deleting some existing files.*
- *In Key Press Mode, If No of Samples reach its maximum limit that is 484, the next sample will start from the first overwriting the memory.*
- *While Logging is running, entering into the LOGGING menu shows below page.*

for Periodic Mode

for Key Press Mode

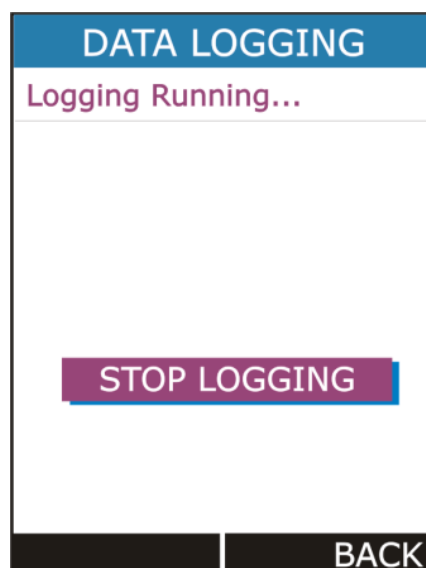
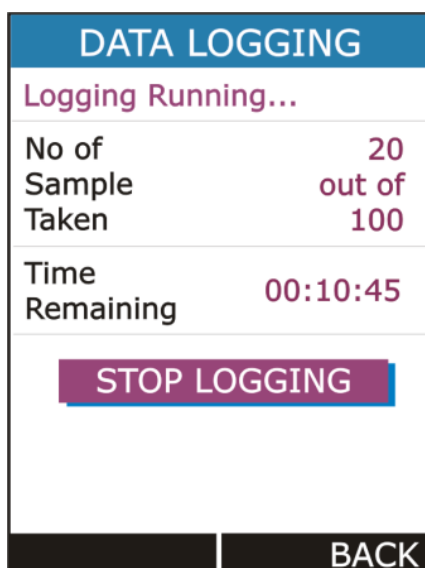

For Periodic Mode, this page contains information of Number of Samples Taken and Time Remaining for Logging in HH:MM: SS.

- *Both Periodic and Key Press logging can be stop manually by pressing F1 key on STOP LOGGING Button. For Periodic Mode, Logging will automatically stopped when defined log time ends and a message "LOGGING DONE" pop ups.*

4.5.1 Transferring the Results to a Personal Computer:

A 32-bit Windows® software called **mCAL+.exe** is shipped together with PCE-MCA 50 if you bought the Data Logging option. Start this software just as any other Windows® software.

All communication between the PC and PCE-MCA 50 is initiated from **mCAL+.exe**.

More information of the software in mM12Im401_00.pdf document available in software CD.

4.6 CJC SETTING Page

This Page is appears in *RUN → MENU → CJC Settings*.

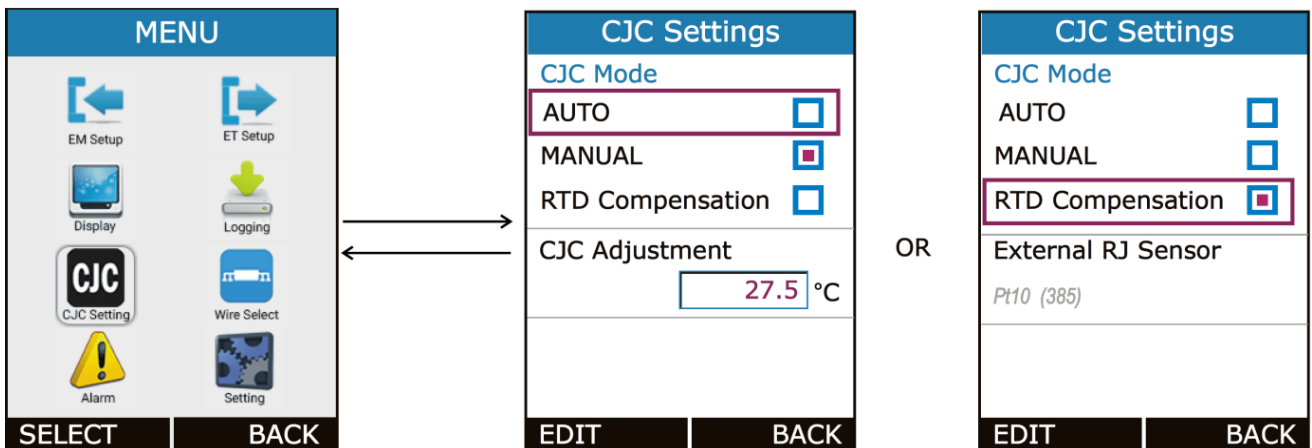

Parameter Name	Description / Options					
CJC Mode	CJ (Cold Junction) Temperature Mode					
	<u>Available Options:</u>					
	<table border="1"> <tbody> <tr> <td>AUTO</td> <td>CJ Temperature is TC Terminal's temperature.</td> </tr> <tr> <td>MANUAL</td> <td>CJ Temperature is user selectable irrespective of TC Terminal temperature.</td> </tr> <tr> <td>RTD COMPENSATION</td> <td>When using an external Reference Junction, PCE-MCA 50 measures or simulates the thermovoltage.</td> </tr> </tbody> </table>	AUTO	CJ Temperature is TC Terminal's temperature.	MANUAL	CJ Temperature is user selectable irrespective of TC Terminal temperature.	RTD COMPENSATION
AUTO	CJ Temperature is TC Terminal's temperature.					
MANUAL	CJ Temperature is user selectable irrespective of TC Terminal temperature.					
RTD COMPENSATION	When using an external Reference Junction, PCE-MCA 50 measures or simulates the thermovoltage.					
CJC Adjustment	CJ Temperature adjustment for Manual CJC Temperature.					
External RJ Sensor	The Reference Junction temperature is measured using and RTD sensor connected to RTD terminals					

4.7 Wire Select Page

This Page is appears in *RUN* → *MENU* → *WIRE SELECT*.

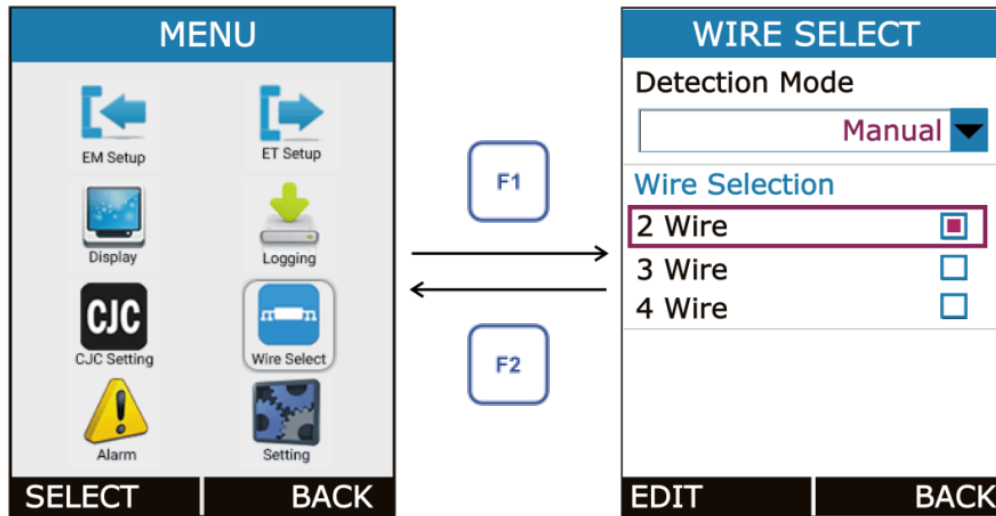

Parameter Name	Description / Options				
Detection Mode	Wire Detection Mode <u>Available Options only for Measure:</u> <table border="1" data-bbox="459 1111 1390 1196"> <tr> <td>AUTO</td> <td>Automatic detect the wire connection.</td> </tr> <tr> <td>MANUAL</td> <td>Manually Select the wire connection</td> </tr> </table>	AUTO	Automatic detect the wire connection.	MANUAL	Manually Select the wire connection
AUTO	Automatic detect the wire connection.				
MANUAL	Manually Select the wire connection				
Wire Selection	Manually Select the wire connection <u>Available Options:</u> 2 Wire 3 Wire 4 Wire				

4.8 Alarm Page

This Page is appears in *RUN* → *MENU* → *ALARM*.

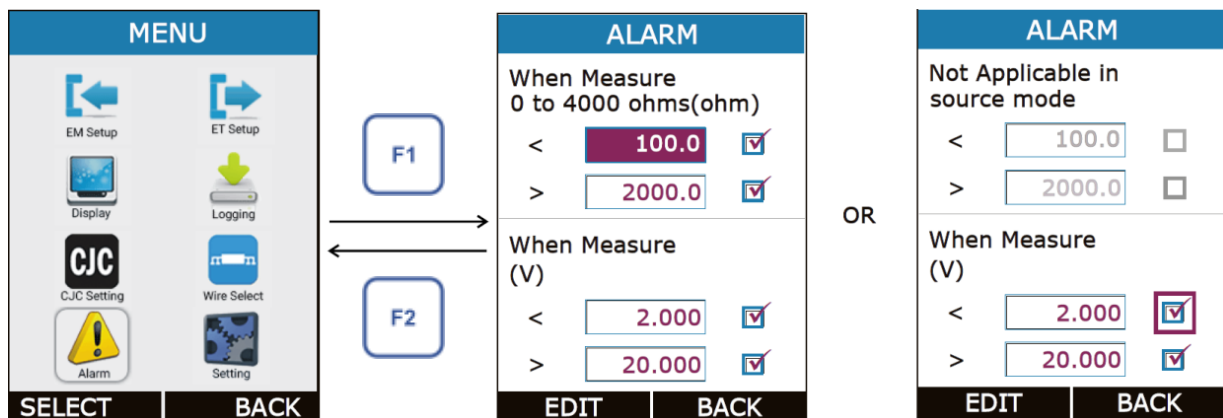

Individual alarm limit values may also be enabled/disabled using the check box preceding the alarm limit value.

When an alarm limit is exceeded, PCE-MCA 50 emits an audible alarm and the Main Reading is shown with RED Color.

To stop alarm uncheck the appropriate alarm checkbox.

Parameter Name	Description / Options
<	Alarm Low Limit Value <u>Range:</u> In accordance with Input Range & Measure Display Mode. And also it can't be greater than Alarm High Limit when High Alarm is enabled.
>	Alarm High Limit Value <u>Range:</u> In accordance with Input Range & Measure Display Mode. And also it can't be less than Alarm Low Limit when Low Alarm is enabled.

4.9 SETTING Page

This Page is appears in *RUN* → *MENU* → *SETTING*.

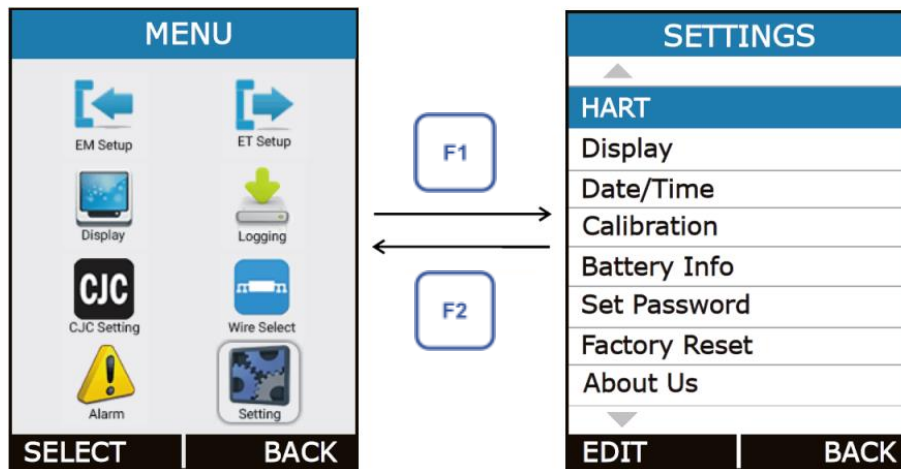

All the available Settings Options are given below.

- i. HART
- ii. Display
- iii. Date/Time
- iv. Calibration
- v. Battery Info.
- vi. Set Password
- vii. Factory Reset
- viii. About Us

Press F1 key to Enter into the settings of any option.

Description of all settings given below.

The screenshot shows the HART settings screen. The title is "HART". Below the title, it says "HART (250 ohms)". There are two options: "NO" with a checked checkbox and "YES" with an unchecked checkbox. The bottom of the screen has "EDIT" and "BACK" buttons.

4.9.1 HART Settings

Select YES to add a Series resistor (250Ω) into the mA circuit.

You can then use this instrument together with a HART® communicator to set up and calibrate HART® devices.

This option is applicable for mA (24V) Read Power Input Type Only.

DISPLAY	
Display Intensity(%)	<input type="text" value="100"/>
Screen Mode	<input type="text" value="Glance Screen"/>
Glance Screen Time out	<input type="text" value="100"/>
<i>Keeping Glance Screen On uses less Battery Power</i>	
EDIT	BACK

4.9.2 Display Settings

Display Intensity	Display Brightness Settings. <u>Range:</u> 5 to 100
Screen Mode	Screen Mode <u>Available options:</u> Glance screen Always on
Glance Screen Time Out	Standby Time in second after which display will turn Off. To turn the display on press any key. <u>Range:</u> 0 to 9999 sec

DATE/TIME	
Date	<input type="text" value="1"/> / <input type="text" value="5"/> / <input type="text" value="13"/> <small>DD MM YY</small>
Date Format	<input type="text" value="DD/MM/YY"/>
Time	<input type="text" value="1"/> : <input type="text" value="5"/> : <input type="text" value="13"/> <small>HH MM SS</small>
	<input type="text" value="AM"/>
Time Format	<input type="text" value="12 Hour"/>
EDIT	BACK

4.9.3 Date/Time Settings

To set the Time + Date of the device.

There are 2 Date Format supported in this device **DD/MM/YY&MM/DD/YY**. This is useful only in Data Logging, to decide in which format Date to be stored.

There are 2 Time format supported in this device **24 Hour&12 Hour**. This is to select in which format the time should be displayed on Run page & time to be stored in Data Logging. AM/PM selection is enabled only for 12 Hour Time Format.

4.9.4 Calibration

Each PCE-MCA 50 comes factory calibrated. To have the meter re-calibrated, please get in touch with PCE Instruments.

Unintended changes made in the internal calibration menu can cause problems / inaccuracies.

BATTERY INFO.	
Level(%)	90
Voltage(mV)	4100
Current(mA)	500
Status	Charging
Time to Full(min)	30
Time to Empty(min)	-
BACK	

4.9.5 Battery Info.

This page shows the basic battery Information.

- Battery Level (Percentage)
- Battery Voltage (in mV)
- Current (in mA)
- Battery Status
- Time to Full (in min)
- Time to Empty (in min)

SET PASSWORD	
Current Password	<input type="password" value="0"/>
New Password	<input type="password" value="0"/>
EDIT BACK	

4.9.6 Set Password

Change Device Password.

This password has to be entered before Calibrating & Resetting Configuration Parameters.

To change password Enter Current Password. If the entered password is correct then New Password EditText will be enabled. Then enter the New Password and press **MENU/ENT** key to store it.

4.9.7 Factory Reset

To Reset PCE-MCA 50 Parameters to its Default Value.

To Reset Enter Current Password. If the entered password is correct then Configuration RESET Radiobuttonbox will be enabled. Then select YES option and press **MENU/ENT** Key to reset Configuration.

4.9.8 About Us

This Page illustrates the Connection diagrams for valid connections to this device.

5. Maintenance & Troubleshooting

5.1 Common Problems

Problem	Possible Causes
Device Not Starting Up	<ul style="list-style-type: none"> • Battery Discharged • Battery Connection Loose
Reading Fluctuation/ Reading OPEN	<ul style="list-style-type: none"> • Wrong / Loose Connections
Error Code on status bar	<ul style="list-style-type: none"> • One of the peripheral not working properly. (Solution: Restart the Device if still error code showing contact factory)
Calibration Out	<ul style="list-style-type: none"> • Distortion in due to external noise connection (Solution: Check connection. If still out contact factory or Recalibrate Device in authorized cal-lab.)
Battery Not Charging	<ul style="list-style-type: none"> • Battery Connection Loose • Battery Dead

5.2 Replacing the Battery

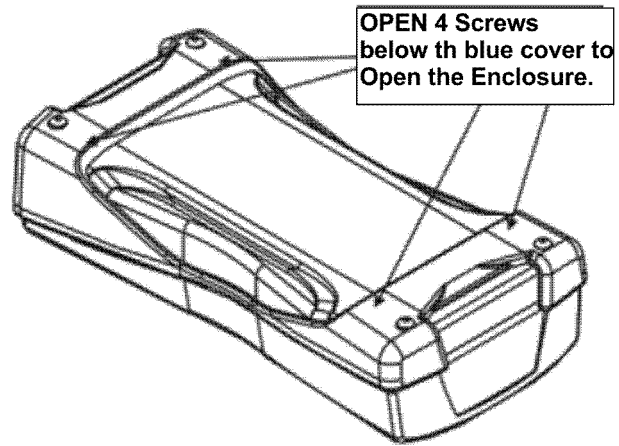

1

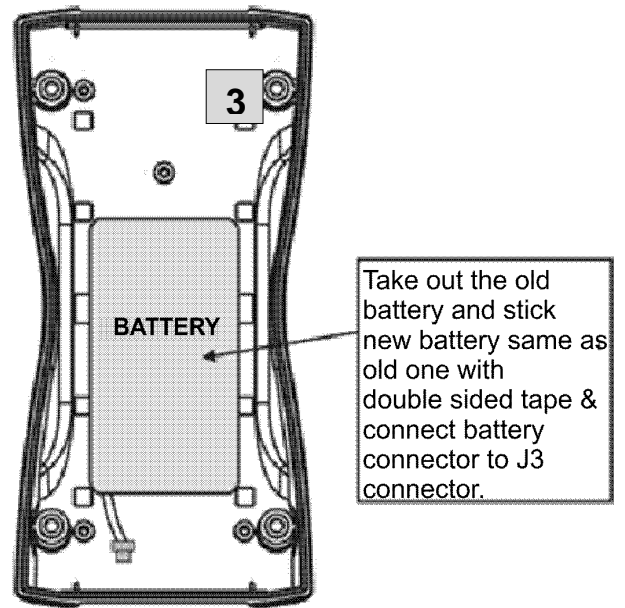
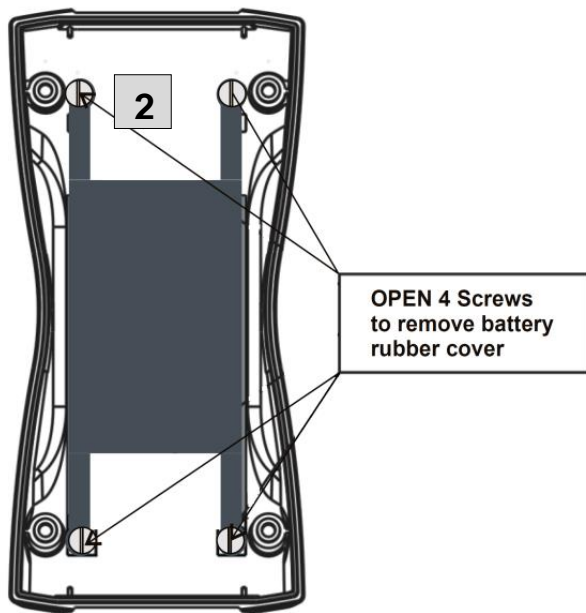

5.3 Related Information

Most of the measurements, generations and simulations presented in this manual are straight forward: Just make the required window settings and connect the instrument under test to the active terminals and that's it!

Some cases require additional settings and things to check before you can be certain that the measurement, generation or simulation works as expected. A typical example of this is temperature measurement using a thermocouple. It is not enough to select the correct function in PCE-MCA 50. The Sensor type and the Reference Junction Mode have to be set accordingly, too. Wrong settings give erroneous results.

Whenever this additional information may be of use in a measurement, generation or simulation, text describing the function refers to one of the following chapters. An experienced may skip this supplemental text, but for a beginner we highly recommend it.

The subjects described here are:

- **Thermocouple Measurement/Simulation, Connections and troubleshooting** on page no 86.
- **Parallel Functions** in PCE-MCA 50 on page no 89.

5.3.1 Thermocouple Measurement/Simulation, Connections and troubleshooting.

To accurately measure the thermo-voltage caused by the temperature to be measured, the second thermo-voltage caused by the Reference Junction needs to be compensated. This is done using one of the Reference Junction compensation methods described in the subsequent chapters.

The Reference Junction compensation method has to be chosen both when measuring and simulating thermocouples.

➤ **Internal Reference Junction**

PCE-MCA 50's Internal Reference Junction makes thermocouple measurement / simulation easy. No external connections are required, just connect the thermocouple or a thermo-voltage receiver directly to PCE-MCA 50's "T/C" terminals. To select this compensation method, set the SCR1 field "T/C Sensor Measurement" or "T/C Sensor Simulation", make sure the Unit is a temperature unit and set the CJC Mode to "Auto".

Connection when measuring/simulating thermocouples using Internal Reference Junction Mode:

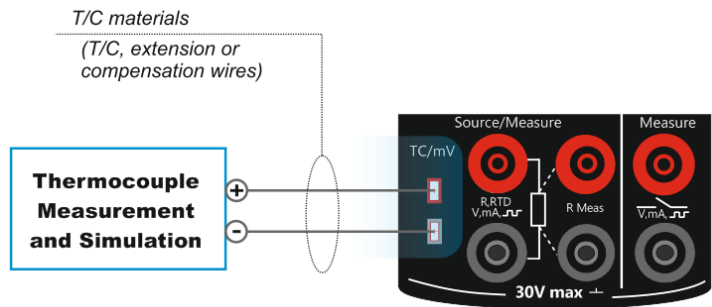

➤ **External Reference Junction**

When using an external Reference Junction, PCE-MCA 50 measures or simulates the thermo-voltage using the “T/C” terminals. The following external Reference Junction compensation methods are available, To select this compensation method, set the SCR1 field “T/C Sensor Measurement” or “T/C Sensor Simulation”, make sure the Unit is a temperature unit and set the CJC Mode to “RTD Compensation”.

➤ **External RTD:**

To be used when The Reference Junction temperature is measured using an RTD sensor connected to PCE-MCA 50’s RTD terminals.

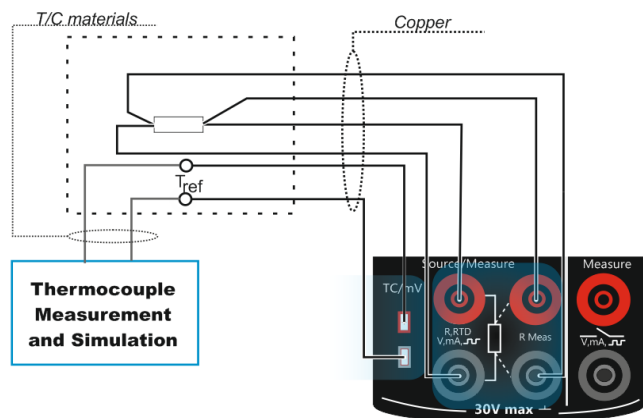

Connection when measuring/simulating thermocouples using Reference Junction compensation method “External RTD”:

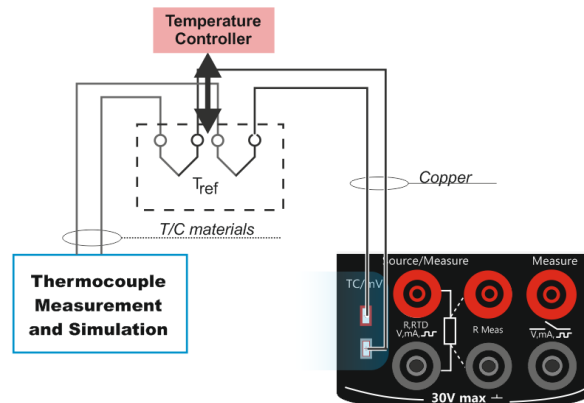

Note: If you connect an RTD sensor to the RTD connectors, there is no galvanic isolation between the thermocouple and the RTD sensor.

➤ **Manually Entered:**

To be used when The Reference Junction temperature is fixed to a temperature. The Reference Junction temperature is controlled and the controller's set point to desired temperature.

Note: this method is of use only if the accuracy of the controller is better than PCE-MCA 50's own Reference Junction.

A compensation box is used and the Reference Junction temperature setting is set to desired temperature.

There is no Reference Junction compensation in the measuring/simulation circuit, but you want to manually enter another Reference Junction temperature.

Connection when measuring/simulating

Thermo-voltages using a temperature controller and either of the following Reference Junction compensation method: "Manually Entered"

➤ **Error situations**

The easiest way to avoid errors in thermocouple measurement and simulation is to check carefully the used wiring and the Reference Junction mode. The following table describes the typical error situations and possible causes/corrections when working with thermocouples:

PROBLEMS	CAUSE
PCE-MCA 50 (or the instrument under test when simulating thermovoltages) measures the temperature/millivolt signal, but the displayed temperature reading is all wrong. <i>(The error may vary from 0 to about $\pm 50^{\circ}\text{C}$ depending on the type of the error)</i>	<ul style="list-style-type: none"> • The thermocouple type selected in PCE-MCA 50 does not correspond with the used Thermocouple. • The selected Reference Junction mode is not in accordance with the used wiring. • Extension or compensation cable type or connections are incorrect. • The polarity of the cables are incorrect.
PCE-MCA 50 (or the instrument under test) displays random readings during Thermocouple measurement.	<ul style="list-style-type: none"> • Incorrect connections. • The wiring is broken. • Interference from a mobile phone or a radio transmitter affects the measurement.

This chapter explains what kind of simultaneous duties PCE-MCA 50 can do.

All of the following tasks may run independently, but the window settings decide what is shown:

- One measurement in the measurement terminals. Electrical Measurement terminals in PCE-MCA 50.
- Either one measurement or one Source/Measure in the *Source/Measure* terminals of PCE-MCA 50.

Also: During thermocouple measurement/simulation the RTD terminals may be used for measuring the reference junction temperature (**CJC Mode** field set to **External RTD**).

Additionally, all of the connectors on the left side of PCE-MCA 50 may have an independent task. Below illustrate the Possible Parallel Functions of PCE-MCA 50.

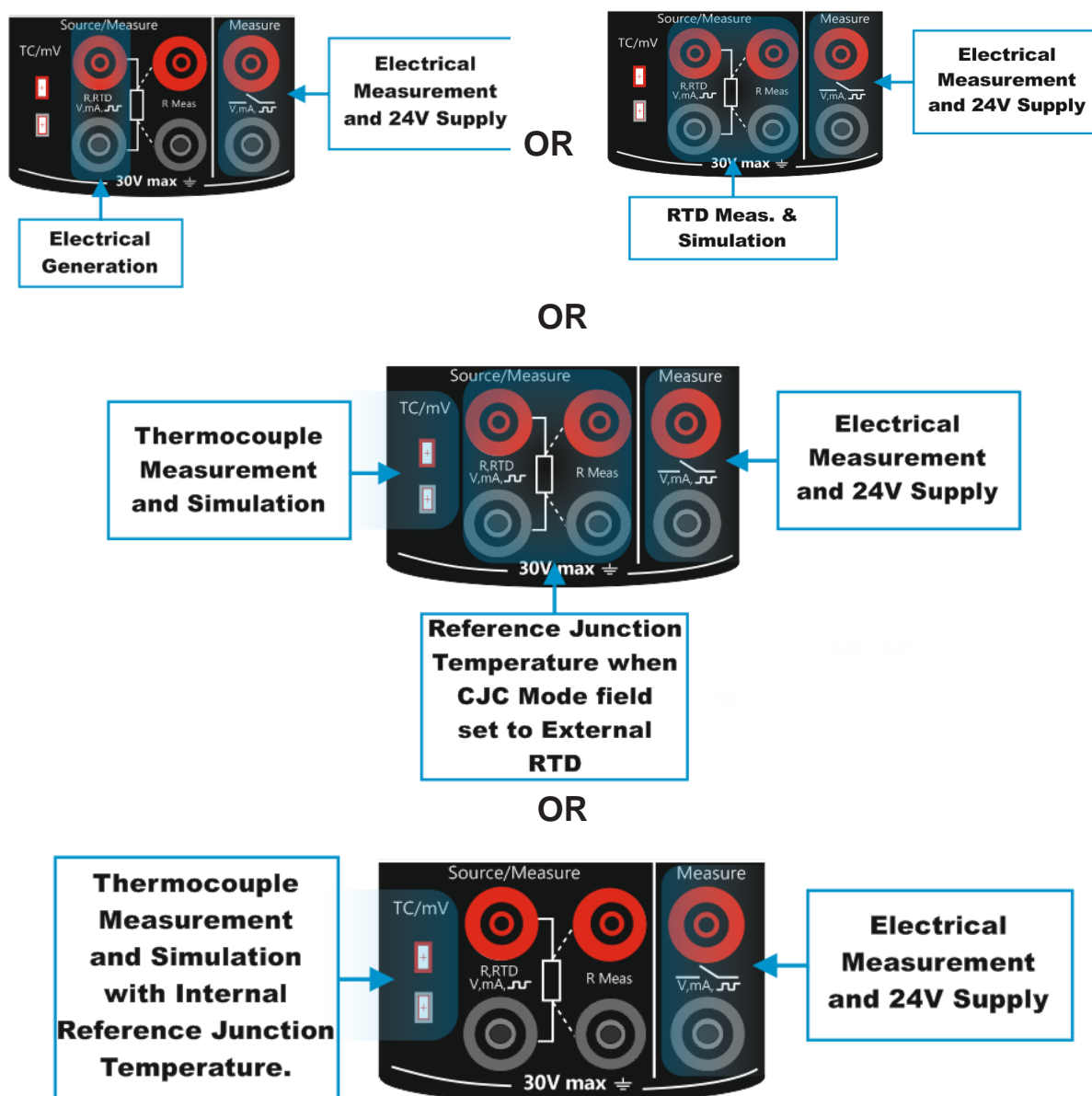

6. General Specifications

6.1 General Specifications

Display Mode	Measure: mA/V/mV/mA(2W)/Switch-test /RTD/TC/Frequency/Pulse Source: mA/V/mV/mA(2W)/Resistance/RTD/TC/Frq./Pulse
Supported units for RTD/TC type	°C/°F/°K
RTD Measurement Current	300 uA
Maximum Resistance excitation current (simulation)	3 mA (0...650 Ω measure/source with I exec 2.0V/ Rsim (650....4000Ω)
Settling time (pulsed currents RTD simulation)	>1 ms
CJC error (For Thermocouple) Internal Reference Junction	≤± 0.5 °C
CJC selection	Manual / Internal / External *
Max. input voltage(EM Terminal)	30 VDC
Temperature Coefficient	≤30 ppm
Input Impedance Measure (EM & TC Terminal)	TC/mV/V >1MΩ mA =10 Ω
Response time	Input <100ms Output <100ms
Load impedance	>4.7KΩ for TC/mV/V/Pulse/frequency O/P <750Ω for mA O/P
Display update rate	10 readings/ second
Isolation	500VDC between mA/V Measure and RTD/Ω/TC/mV/V/mA/Frq./pulse
Data logging	Logged data is stored in a user defined file in internal memory Periodic logging: 150000 readings max
Communication Interface	USB 2.0
Operating temperature	0° to 55° C
Operating temperature when charging batteries	0° to 45° C
Storage temperature	-20° to 60° C
Relative Humidity	30% to 90% non-condensing
Warm-up time	5 Minutes

*with RTD sensor at RTD terminal for External CJC

6.2 Display & Keys

Display	3.2" TFT LCD, 262K Color, Graphical 48.6 mm x 64.8, 240x320 pixels, White LED Backlight
Keys	9 Membrane Keys

6.3 Special Features

Loop power output	24V DC, $\pm 10\%$ (24mA maximum)
HART mA Loop Resistor	250 $\Omega \pm 20\%$
Special Function	Step/Ramp functions: Automatic/Manual. \sqrt{x} , x^2 : for mA/V measure/source
Continuity Test	Audible sounds when resistance measure value crosses the specified threshold. (selectable up to 100 Ω)
Automatic Wire detection	Automatic detection RTD measure wire connection. (2-wire, 3-wire or 4-wire)
Switch Test	<ul style="list-style-type: none"> • Potential free contacts Trigger level : 24V, 24mA (2V) • Voltage level detection Trigger level : 0 to 30V in 1V steps

6.4 Power Supply

Battery Type	Rechargeable Li-ion battery pack, 3000mAh 3.7V
Charging Time	<8 hours
Charger supply	100-240 VAC, 50/60 Hz; Output 5V DC@1A
Battery Life on full charge	>17 hours for RTD/ Ω /TC/V/mV measure/source with minimum backlight. >9 hours for mA generation with minimum backlight.(24VDC @12mA)
Battery Status Indication	Battery symbol displayed with % power remaining

6.5 Physical

Dimensions	185.6 mm (L) x 97.1 mm (W) x 41.3 mm (H)
Housing Material	ABS Plastic
Electrical Terminals: measure:- V/mA/mA(24V)/switch/Frq/Pulse	Two nos. , 4 mm safety sockets
RTD Terminals/Electrical Terminals: Source:- V/mA/mA(24V)/Freq./Pulse measure /Source:- Resistance/RTD	Four nos. , 4 mm safety sockets
TC Terminals:- TC/mV (measure /Source)	Thermocouple minijack socket (cu type)
Weight	<500 grams
Protection	IP20

6.6 Electrical Measurement Parameters and Accuracy

Parameter	Range	Resolution	Accuracy
V	0-30.00 VDC	0.001 V	$\pm 0.02\%$ of reading ± 2 count

mA	0-24.00 mA	0.001 mA	$\pm 0.02\%$ of reading ± 2 count
-----------	------------	----------	---------------------------------------

6.7 Electrical Simulation Parameters and Accuracy

Parameter	Range	Resolution	Accuracy
V	0-12.00 VDC	0.001 V	$\pm 0.02\%$ of reading ± 2 count
mA	0-24.00 mA	0.001 mA	$\pm 0.02\%$ of reading ± 2 count

6.8 Resistance Measurement 0 ... 4000 ohm

Range	Resolution	Accuracy
0...1600 Ω	10 m Ω	4 Wire Connection: 0.02% of reading $\pm 0.01 \Omega$ 3 Wire Connection: 0.02% of reading $\pm 0.015 \Omega$
1600...4000 Ω	100 m Ω	4 Wire Connection: 0.02% of reading $\pm 0.1 \Omega$ 3 Wire Connection: 0.02% of reading $\pm 0.15 \Omega$

6.9 Resistance Simulation 0 ... 4000 ohm

Range	Resolution	Accuracy*
0...400 Ω	10 m Ω	0.02% of reading $\pm 0.02 \Omega$
400...4000 Ω	100 m Ω	0.02% of reading $\pm 0.15 \Omega$

6.10 RTD Measurement and Simulation

1) Pt10 Pt1000, -200 850 °C

Range	Resolution	Accuracy
-200....200 °C	Pt10...Pt400: 0.01 °C Pt500,Pt1000: 0.1 °C	4 wire Measurement: 0.15°C Simulation*: 0.15 °C
200....600 °C		4 wire Measurement: 0.2 °C Simulation*: 0.25 °C
600....850 °C		4 wire Measurement: 0.3 °C Simulation*: 0.35 °C

2) Ni100, -60 180 °C

Range	Resolution	Accuracy
-60....180 °C	0.01 °C	4 wire Measurement: 0.1 °C Simulation*: 0.15 °C

3) Ni120, -80 260 °C

Range	Resolution	Accuracy
-80....260 °C	0.01 °C	4 wire Measurement: 0.1 °C Simulation*: 0.15 °C

4) Cu10, -200 260 °C

Range	Resolution	Accuracy
-200....260 °C	0.01 °C	4 wire Measurement: 0.2 °C Simulation*: 0.8 °C

Note: * Specification valid with an excitation current >0.2 mA (0...400 ohm), >0.1 mA (400...4000 ohm)

** Read accuracy is based on 4-wire input. For 3-wire RTD measurements, assuming all three

RTD leads are matched, add 1.0 °C (Pt10 and Cu10), 0.6 °C (Pt50 and Cu50), and 0.4 °C

(Other RTD types) to the specifications.

6.11 Available RTD Types

- | | | |
|----------------|-----------------|-----------------|
| 1) Pt10 (385) | 6) Pt500 (385) | 11) Ni120 (672) |
| 2) Pt50 (385) | 7) Pt1000 (385) | 12) Cu10 (427) |
| 3) Pt100 (385) | 8) Pt100 (3926) | 13) Cu50 (427) |
| 4) Pt200 (385) | 9) Ni100 (672) | 14) Cu100 (427) |
| 5) Pt400 (385) | 10) Ni100 (618) | |

6.12 Thermocouple/mV Resolution and Accuracy

TC Terminal (Measure and Source)			
TC Type	Range	Resolution	Accuracy
E	-200.0 to 1000.0 °C	0.1 °C	0.3 °C
J	-200.0 to 1200.0 °C	0.1 °C	0.3 °C
K	-200.0 to 1372.0 °C	0.1 °C	0.3 °C
T	-200.0 to 400.0 °C	0.1 °C	0.3 °C
B	450.0 to 1800.0 °C	0.1 °C	0.5 °C
R	0.0 to 1750.0 °C	0.1 °C	0.5 °C
S	0 to 1750.0 °C	0.1 °C	0.5 °C
N	-200.0 to 1300.0°C	0.1 °C	0.3 °C
mV	-10 to 80 mV	0.001 mV	$\pm 0.02\%$ of reading $\pm 4\mu\text{V}$
	-10 to 250 mV	0.01mV	$\pm 0.02\%$ of reading $\pm 0.02\text{mV}$

Note: temperature standard ITS-90

6.13 Frequency Measurement

Range	Resolution
0.0143 to 9.9999	0.0001 Hz
10 to 99.999Hz	0.001 Hz
100 to 999.99Hz	0.01 Hz
1000 to 9999.9 Hz	0.1 Hz
10000 to 50000 Hz	1 Hz

Feature	Specification
Input Impedance	>1Mohm
Trigger Level	0 to 12V in 1 V Steps
Accuracy	0.01% of Reading ± 1 count
Supported units	Hz, KHZ, cph, cpm, sec, msec, usec

6.14 Pulse counting

Feature	Specification
Range	0 to 999999 pulses
Input Impedance	>1 Mohm
Trigger level	0 to 12V in 1 V Steps

6.15 Frequency Generation

Range	Resolution
0.0005 to 0.5Hz	0.00001 Hz
0.5 to 50 Hz	0.0001 Hz
50 to 500 Hz	0.001 Hz
500 to 5000 Hz	0.01 Hz
5000 to 10000 Hz	0.1 Hz

Feature	Specification
Output Amplitude positive Square wave	0 to 12VPP ($\pm 0.25V + 5\%$)
Output Amplitude symmetric Square wave	0 to 6 VPP ($\pm 0.25V + 5\%$)
Accuracy	0.01% of Reading ± 1 count
Duty Cycle	1 to 99 % (0.0009 to 500Hz), High to low time: minimum 25us. Maximum 1165s
Supported units	Hz, KHZ, cph, cpm, sec, msec, usec

6.16 Pulse Generation

Feature	Specification
Range Resolution	0 to 999999 pulses
Resolution	1 Pulse
Output Amplitude positive Square wave	0 to 12VPP ($\pm 0.25V + 5\%$)
Output Amplitude symmetric Square wave	0 to 6 VPP ($\pm 0.25V + 5\%$)
Pulse Frequency	0.0005 to 10000Hz
Duty Cycle	1 to 99%(0.0009 to 500Hz), High to low time: minimum 25us. Maximum 1165s

6.17 Enclosure Dimensions

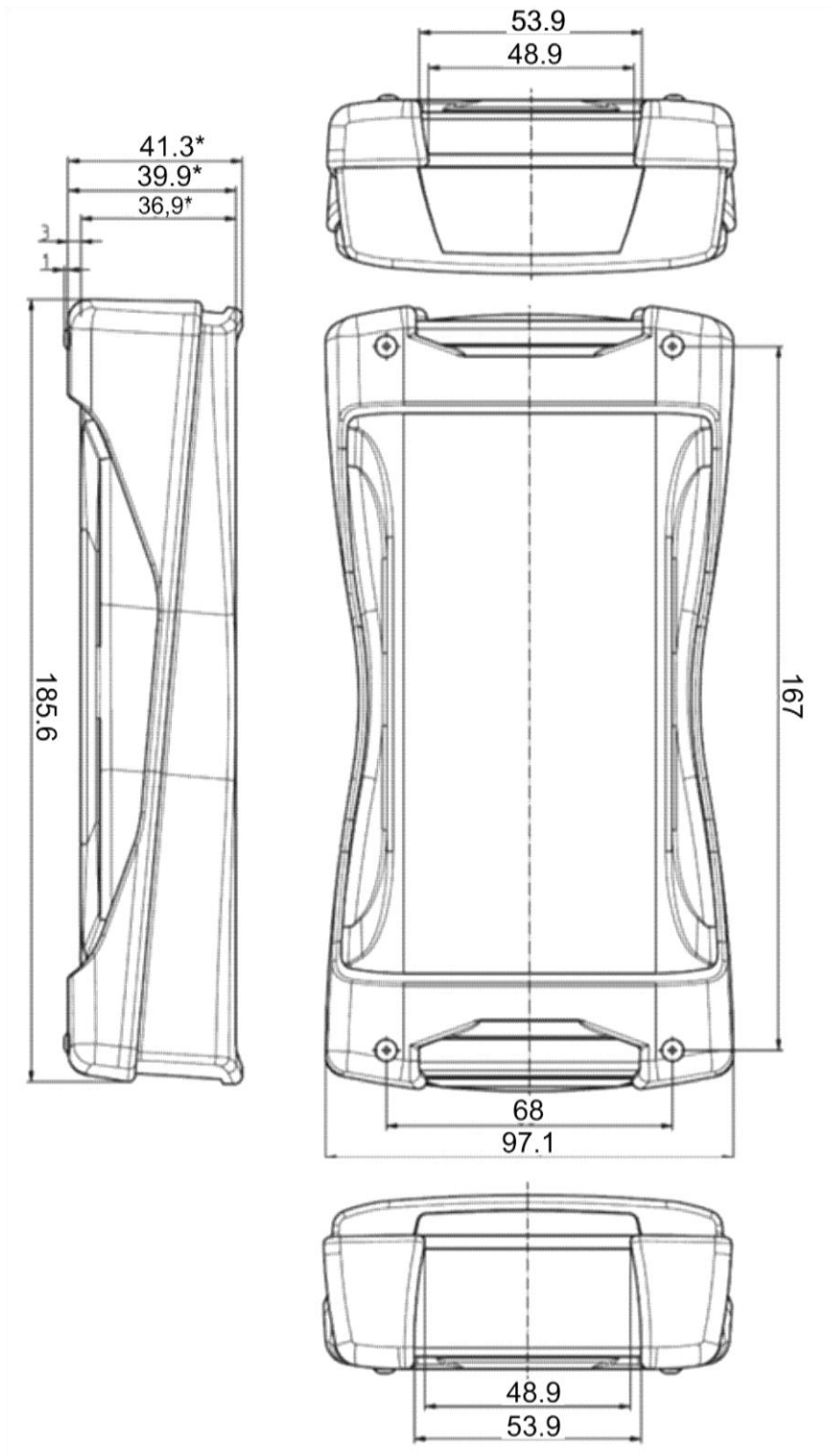

*All dimensions are in mm.