



User Manual

PCE-IT100 Insulation Tester



User manuals in various languages (français, italiano, español, português, nederlands, türk, polski, русский, 中文) can be found by using our product search on: www.pce-instruments.com

Last change: 7 October 2019
v1.0



Contents

1	Safety notes	1
1.1	Safety symbols.....	2
1.2	Safety categories	3
2	Delivery contents	4
3	Specifications	4
4	Device description	7
5	Turn on meter	8
6	Connect the test leads	8
6.1	Set zero point.....	8
7	Insulation measurement	8
7.1	Measuring AC motors.....	8
7.2	Measuring DC motors	8
7.3	Measuring insulated cables	8
8	Continuity test/resistance measurement	9
9	Voltage measurement AC/DC	9
10	Automatic Power Off function	9
11	Keys	9
11.1	Hold reading.....	9
11.2	MAX/MIN.....	9
11.3	Freehand measurement (LOCK key).....	9
12	Backlight	10
13	Replace the batteries	10
14	Replace the fuse	10
15	Contact	10
16	Disposal	10

1 Safety notes

Please read this manual carefully and completely before you use the device for the first time. The device may only be used by qualified personnel and repaired by PCE Instruments personnel. Damage or injuries caused by non-observance of the manual are excluded from our liability and not covered by our warranty.

- The device must only be used as described in this instruction manual. If used otherwise, this can cause dangerous situations for the user and damage to the meter.
- The instrument may only be used if the environmental conditions (temperature, relative humidity, ...) are within the ranges stated in the technical specifications. Do not expose the device to extreme temperatures, direct sunlight, extreme humidity or moisture.
- Do not expose the device to shocks or strong vibrations.
- The case should only be opened by qualified PCE Instruments personnel.
- Never use the instrument when your hands are wet.
- You must not make any technical changes to the device.
- The appliance should only be cleaned with a damp cloth. Use only pH-neutral cleaner, no abrasives or solvents.
- The device must only be used with accessories from PCE Instruments or equivalent.
- Before each use, inspect the case for visible damage. If any damage is visible, do not use the device.
- Do not use the instrument in explosive atmospheres.
- The measurement range as stated in the specifications must not be exceeded under any circumstances.
- Non-observance of the safety notes can cause damage to the device and injuries to the user.
- Remove the batteries when the meter is not used for more than 60 days.
- Turn off the meter when not in use.
Do not use the full measurement range.
- Set your meter before connecting the test leads.
- Before replacing the batteries or the fuse, turn off the meter and remove the test leads.
- Be particularly careful with voltages over 30V AC RMS, 42 V AC peak or 60V DC to avoid electric shocks.
- Make sure the test object does not carry any voltage when making a resistance or diode test.
- Do not touch the measuring tips.
- Always use personal protective equipment when measuring live wires to avoid an electric arc.
- Do not use the meter when it no longer works flawlessly.





We do not assume liability for printing errors or any other mistakes in this manual.

We expressly point to our general guarantee terms which can be found in our general terms of business.

If you have any questions please contact PCE Instruments. The contact details can be found at the end of this manual.

1.1 Safety symbols

There are several icons on the meter which mean the following:

	<p>This icon can be found next to another symbol or a connection and is a reference to the user manual.</p>
	<p>This icon indicates that high voltage could be present. Shock hazard!</p>
	<p>Double insulation</p>
	<p>Earth (ground)</p>
	<p>DC (direct current)</p>

1.2 Safety categories

Category	Short description	Typical applications
CAT II	One-phase measurements, e. g. of sockets or cables	Household appliances, electric power tools, measuring points 10 m away from a CAT III source, measuring points 20 m away from a CAT IV source
CAT III	Three-phase measurements or one-phase measurements, e. g. of light circuits in commercial buildings	Motors, switches, sub-distributors in a three-phase circuit, light circuits in commercial buildings, supply cables for industrial plants, electrical appliances or connections near a CAT III source

The measuring category (CAT) arise from the combination of the meter, the test leads and the accessories. To know what CAT to work with, you must find out what component has the lowest CAT and use this CAT.

Important: When you have removed the insulation from the test leads, these will correspond to CAT II.

Insulated Tip On

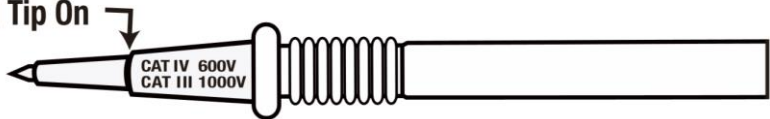

Fig. 1: Insulated tip

Insulated Tip Removed

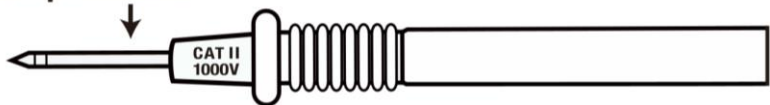

Fig. 2: Uninsulated tip



2 Delivery contents

- 1 x insulation tester PCE-IT100
- 1 x set of test leads
- 1 x alligator clip with 1 m cable
- 6 x 1.5 V AA battery
- 1 x carrying strap
- 1 x user manual
- 1 x carrying case

3 Specifications

The accuracies have been determined at an ambient temperature of 23 °C ±5 °C and 80 % RH.

Resistance measurement	
Measurement range	40.00 Ω 400.0 Ω
Resolution	0.01 Ω 0.1 Ω
Accuracy	±(1.2 % + 3 digits)
Overvoltage protection 250 V RMS Measuring voltage max. 5.8 V	
Continuity test	
Icon	••)
Resolution	0.01 Ω
Audible signal	≤35 Ω
Short circuit current	≥200 mA
Overvoltage protection 250 V RMS Measuring voltage max. 5.8 V	
DC voltage measurement	
Measurement range	1000 V
Resolution	1 V
Accuracy	±(0.8 % 3 digits)
Input resistance	10 MΩ
Overvoltage protection 1000 V RMS	
AC voltage measurement (40 ... 400 Hz)	
Measurement range	750 V
Resolution	1 V
Accuracy	±(1.2 % 10 V)
Input resistance	10 MΩ
Overvoltage protection 750 V RMS	

Insulation measurement at 125 V (0 ... ±10 %)	
Measurement range	0.125 ... 4.000 MΩ 4.001 ... 40.00 MΩ 40.01 ... 400.0 MΩ 400.1 ... 4000 MΩ
Resolution	0.001 MΩ 0.01 MΩ 0.1 MΩ 1 MΩ
Accuracy	±(2 % + 10 digits) ±(2 % + 10 digits) ±(4 % + 5 digits) ±(5 % + 5 digits)
Test current	1 mA at 125 kΩ
Short circuit current	≤1 mA
Insulation measurement at 250 V (0 ... ±10 %)	
Measurement range	0.250 ... 4.000 MΩ 4.001 ... 40.00 MΩ 40.01 ... 400.0 MΩ 400.1 ... 4000 MΩ
Resolution	0.001 MΩ 0.01 MΩ 0.1 MΩ 1 MΩ
Accuracy	±(2 % + 10 digits) ±(2 % + 10 digits) ±(5 % + 5 digits) ±(4 % + 5 digits)
Test current	1 mA at 125 kΩ
Short circuit current	≤1 mA
Insulation measurement at 500 V (0 ... ±10 %)	
Measurement range	0.500 ... 4.000 MΩ 4.001 ... 40.00 MΩ 40.01 ... 400.0 MΩ 400.1 ... 4000 MΩ
Resolution	0.001 MΩ 0.01 MΩ 0.1 MΩ 1 MΩ
Accuracy	± (2 % + 10 digits) ± (2 % + 10 digits) ± (2 % + 5 digits) ± (4 % + 5 digits)
Test current	1 mA at 500 kΩ
Short circuit current	≤1 mA

Insulation measurement at 1000 V (0 ... ±10 %)	
Measurement range	1.000 ... 4.000 MΩ 4.001 ... 40.00 MΩ 40.01 ... 400.0 MΩ 400.1 ... 4000 MΩ
Resolution	0.001 MΩ 0.01 MΩ 0.1 MΩ 1 MΩ
Accuracy	±(3 % + 10 digits) ±(2 % + 10 digits) ±(2 % + 5 digits) ±(4 % + 5 digits)
Test current	1 mA at kΩ
Short circuit current	≤1 mA
General specifications	
Continuity test	Audible signal at resistance <35 Ω
Battery indication	„  “ is displayed when battery voltage is no longer sufficient
Excess of measurement range	“OL“ is displayed
Sampling rate	2.5 measurements/s (0.4 Hz)
Zero point	Manual adjustment possible
Power supply	6 x 1.5 V AAA
Fuse	10 A / 600 V (5 x 20 mm)
Operating conditions	0 ... +40 °C, <80 % RH 32 ... 104 °F
Storage conditions	-10 ... +60 °C, <70 % RH 14 ... 140 °F
Operating altitude	2000 m
Dimensions	200 x 92 x 50 mm
Weight	700 g with batteries
Standards	IEC10101, CAT III 1000 V, pollution degree 2

4 Device description

1. LCD
2. MAX/MIN, HOLD key
3. LOCK key
4. Zero point and backlight key
5. TEST key
6. Rotary function switch
7. V Ω input jack
8. Ground input jack
9. Strap holder
10. Battery compartment

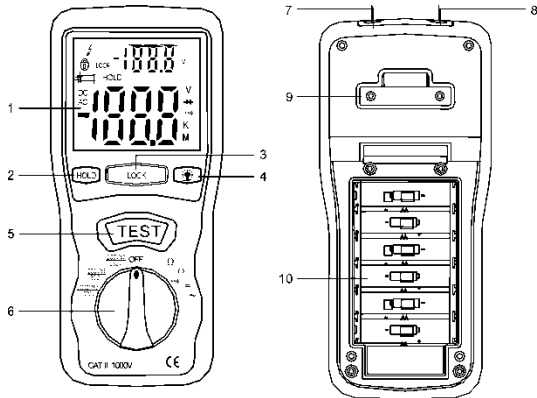



5 Turn on meter

To turn on the meter, select the desired function by turning the rotary switch. The meter will power on directly. To turn off the meter, select "OFF" with the rotary switch.

6 Connect the test leads

Connect the red test lead to the V Ω input jack. Connect the black test lead to the COM input jack.

6.1 Set zero point

To reset the zero point, choose "400 Ω " with the rotary switch. Now hold the measuring tips against each other. Then press "ZERO". The zero point has been reset.

Note: Zeroing is only valid for the "400 Ω " measurement and expires when you select a different measuring function.

7 Insulation measurement

To make an insulation measurement, select the desired voltage with the rotary switch. Here you can select a test voltage of 125 V, 250 V, 500 V or 1000 V. Now connect the test leads to your sample. Press the TEST key to generate the desired test voltage directly. To make a measurement, press and hold the TEST key. The measurement is finished when you release the key. Bear in mind that some residual voltage may be present in the meter.

The reading will be shown in the upper part of the display. The test voltage is shown in the lower part of the display. The measurement range is selected by the meter automatically.

Note: If the sample carries a voltage of at least 30 V, the meter will display ">30 V" and "⚡", a beep sound will be audible and the meter will not make a measurement. Therefore, it is important to remove any external voltages before each measurement.

7.1 Measuring AC motors

Interrupt the voltage supply of the motor by disconnecting the connection cable of the motor. In case there are switches on the motor, these must be turned on. To measure the insulation now, connect one test lead to the supply cable and the other one to the motor.

7.2 Measuring DC motors

Interrupt the voltage supply of the motor by disconnecting the connection cable of the motor. In case there are switches on the motor, these must be turned on. Now connect one test lead to the PE connection of the connection cable and the second one to, for example, the carbon brushes to measure the insulation.

7.3 Measuring insulated cables

To measure the insulation of a cable, make sure that the cable ends are open. Now make a measurement by measuring each cable core with every other cable core.

8 Continuity test/resistance measurement

To make a continuity test or resistance measurement, select "400 Ω " with the rotary switch. You can now connect the test leads to your sample and measure the resistance. The measurement range is set automatically. The continuity test takes place at the same time.

Note: If the sample carries a voltage of at least 30 V, the meter will display ">30 V" and "", a beep sound will be audible and the meter will not make a measurement. Therefore, it is important to remove any external voltages before each measurement.

9 Voltage measurement AC/DC

To measure alternating current, select "750V" with the rotary switch. Now you can connect the test leads to your sample. The present voltage will directly be shown in the upper part of the display. The current battery voltage will be shown in the lower part of the display.

To measure direct current, turn the rotary switch to the "1000V" position. Then connect the test lead to the sample. The reading will be shown directly in the upper part of the display.

The measurement range is determined automatically for both functions.

10 Automatic Power Off function

The meter turns off automatically after 10 minutes of inactivity. This function cannot be disabled. To turn on the meter again after auto power off, turn the rotary switch back to "OFF" and then turn it to the desired position.

11 Keys

The meter has four keys which have the following functions:

11.1 Hold reading

Press the HOLD key to freeze the reading. "HOLD" will be displayed. Press the HOLD key again to continue with the measurement. "HOLD" will now disappear.

11.2 MAX/MIN

Press and hold the MAX/MIN key to start the MAX/MIN function. "MAX" will appear in the display first. This function will display the maximum reading. Press the key again to view the lowest value. "MIN" will be displayed. Press and hold this key to return to normal measuring mode.

Note: This function is only available with the measuring functions "400 Ω ", "1000VDC" and "750VAC".

11.3 Freehand measurement (LOCK key)

Press the LOCK key. A lock icon will appear in the display. Now press the TEST key. An audible signal indicates that voltage is now present in the measuring tips. This voltage will be shown as a reading in the lower part of the display. The currently measured resistance value is shown in the upper part of the display. The high voltage is discharged as soon as the TEST key is pressed again. This procedure can be followed by looking at the lower part of the display. When the discharge is completed, the beep sound will be muted and the measuring tips can be removed safely.



12 Backlight

To enable the backlight, press and hold the ZERO key until the backlight is activated. To turn off the backlight, press and hold the ZERO key again. The backlight will turn off automatically after 15 seconds.

13 Replace the batteries

If the battery power is no longer sufficient, the battery icon will be displayed. To replace the batteries, first remove the test leads from the meter and turn it off. Now open the battery compartment at the rear side the cover of which is affixed with four screws. After opening the battery compartment, insert six 1.5 V AA batteries. Close the battery compartment.

14 Replace the fuse

To replace the fuse, first remove the test leads from the meter and turn it off. Open the battery compartment at the rear side the cover of which is affixed with four screws. Remove all batteries. You can now replace the fuse. Only use an FF 500 mA 1000 V fuse.

15 Contact

If you have any questions, suggestions or technical problems, please do not hesitate to contact us. You will find the relevant contact information at the end of this user manual.

16 Disposal

For the disposal of batteries in the EU, the 2006/66/EC directive of the European Parliament applies. Due to the contained pollutants, batteries must not be disposed of as household waste. They must be given to collection points designed for that purpose.

In order to comply with the EU directive 2012/19/EU we take our devices back. We either re-use them or give them to a recycling company which disposes of the devices in line with law.

For countries outside the EU, batteries and devices should be disposed of in accordance with your local waste regulations.

If you have any questions, please contact PCE Instruments.



PCE Instruments contact information

Germany

PCE Deutschland GmbH
Im Langel 4
D-59872 Meschede
Deutschland
Tel.: +49 (0) 2903 976 99 0
Fax: +49 (0) 2903 976 99 29
info@pce-instruments.com
www.pce-instruments.com/deutsch

Germany

PCE Produktions- und
Entwicklungsgesellschaft mbH
Im Langel 26
D-59872 Meschede
Deutschland
Tel.: +49 (0) 2903 976 99 471
Fax: +49 (0) 2903 976 99 9971
info@pce-instruments.com
www.pce-instruments.com/deutsch

The Netherlands

PCE Brookhuis B.V.
Institutenweg 15
7521 PH Enschede
Nederland
Telefoon: +31 (0)53 737 01 92
info@pcebenelux.nl
www.pce-instruments.com/dutch

United States of America

PCE Americas Inc.
711 Commerce Way suite 8
Jupiter / Palm Beach
33458 FL
USA
Tel: +1 (561) 320-9162
Fax: +1 (561) 320-9176
info@pce-americas.com
www.pce-instruments.com/us

France

PCE Instruments France EURL
23, rue de Strasbourg
67250 Soultz-Sous-Forets
France
Téléphone: +33 (0) 972 3537 17
Numéro de fax: +33 (0) 972 3537 18
info@pce-france.fr
www.pce-instruments.com/french

United Kingdom

PCE Instruments UK Ltd
Unit 11 Southpoint Business Park
Ensign Way, Southampton
Hampshire
United Kingdom, SO31 4RF
Tel: +44 (0) 2380 98703 0
Fax: +44 (0) 2380 98703 9
info@pce-instruments.co.uk
www.pce-instruments.com/english

China

PCE (Beijing) Technology Co., Limited
1519 Room, 6 Building
Zhong Ang Times Plaza
No. 9 Mentougou Road, Tou Gou District
102300 Beijing, China
Tel: +86 (10) 8893 9660
info@pce-instruments.cn
www.pce-instruments.cn

Turkey

PCE Teknik Cihazları Ltd.Şti.
Halkalı Merkez Mah.
Pehlivan Sok. No.6/C
34303 Küçükçekmece - İstanbul
Türkiye
Tel: 0212 471 11 47
Faks: 0212 705 53 93
info@pce- cihazlari.com.tr
www.pce-instruments.com/turkish

Spain

PCE Ibérica S.L.
Calle Mayor, 53
02500 Tobarra (Albacete)
España
Tel. : +34 967 543 548
Fax: +34 967 543 542
info@pce-iberica.es
www.pce-instruments.com/espanol

Italy

PCE Italia s.r.l.
Via Pesciatina 878 / B-Interno 6
55010 Loc. Gragnano
Capannori (Lucca)
Italia
Telefono: +39 0583 975 114
Fax: +39 0583 974 824
info@pce-italia.it
www.pce-instruments.com/italiano

Hong Kong

PCE Instruments HK Ltd.
Unit J, 21/F., COS Centre
56 Tsun Yip Street
Kwun Tong
Kowloon, Hong Kong
Tel: +852-301-84912
jyi@pce-instruments.com
www.pce-instruments.cn