



PCE Americas Inc.
711 Commerce Way
Suite 8
Jupiter
FL-33458
USA
From outside US: +1
Tel: (561) 320-9162
Fax: (561) 320-9176
info@pce-americas.com

PCE Instruments UK Ltd.
Units 12/13
Southpoint Business Park
Ensign way
Hampshire / Southampton
United Kingdom, SO31 4RF
From outside UK: +44
Tel: (0) 2380 98703 0
Fax: (0) 2380 98703 9
info@pce-instruments.com

www.pce-instruments.com/english
www.pce-instruments.com

Manual

Colorimeter PCE-CSM 3



Version 1.0
Date of creation: 25.09.2015
Date of last change: 08.02.2017

Contents

1	Introduction	3
2	Safety notes	3
3	Specification	4
3.1	Technical specifications	4
3.2	Contents of delivery	4
4	System description	5
4.1	Button description	5
4.2	Interfaces	5
4.3	Battery	6
5	Operation	7
5.1	Turn on the device	7
5.2	Take a measurement	7
5.3	Additional functions	8
5.3.1	Records	8
5.3.2	Calibration	9
5.3.3	Connection to a PC or printer	10
5.3.4	Tolerances	10
5.3.5	Delete recorded data	10
5.3.6	Averaging	10
5.3.7	Display mode	11
5.3.8	Language	11
6	Settings	11
6.1	Auto save	11
6.2	Time setting	12
6.3	Print settings	12
6.4	Backlight time	12
6.5	Brightness setting	12
6.6	Battery capacity	12
6.7	Restore factory	12
7	Optional Accessories	13
7.1	Powder test box PCE-CSM PTB	13
7.1.1	Build-up	13
7.1.2	Operation	13
7.2	Measuring device for liquids, pastes and powders PCE-CSM UTC	14
7.2.1	Build-up	14
7.2.2	Operation	15
8	Contact	17
8.1	PCE Instruments UK	17
8.2	PCE Americas	17

1 Introduction

Thank you for purchasing a colorimeter from PCE Instruments.

The colorimeter PCE-CSM 3 is an ideal measuring device for application in the range of quality control and offers a high accuracy. When using the colorimeter, there are two different colour spaces available (CIE L*a*b*C*h, CIE L*a*b*). After a measurement with the PCE-CSM 3, the reading can be used as a standard value. Other readings can be recorded as a sample and later be compared to the reference value. In addition to the individual colour space coordinates, the deviation between the readings is also displayed. On the internal memory of the colorimeter, you can store up to 100 reference values and up to 20000 samples. The measured data can also be transferred to a PC via USB and analysed with the included PC software.

2 Safety notes

Please read this manual carefully and completely before you use the device for the first time. The device may only be used by qualified personnel and repaired by PCE Instruments personnel. There is no warranty of damages or injuries caused by non-observance of the manual.

- This colorimeter is a precise measuring device. Please avoid strong changes in the environmental conditions. This includes flickering lights as well as changes of the air temperature or air humidity.
- The device may only be used in the approved temperature range.
- Make sure the device is standing right on the measuring spot. Do not move it while the measuring procedure is in progress. Avoid shocks.
- Do not expose the device to water. Only use it in areas which fulfil the permitted environmental conditions.
- Keep the device clean and prevent dust or other particles from entering the measuring aperture.
- To clean the device, use a damp cloth. Do not use solvent-containing materials for cleaning.
- The case should only be opened by qualified personnel of PCE Instruments.
- You must not make any technical changes to the device.
- The instrument should never be placed with the user interface facing an object (e. g. keyboard side on a table).
- Only use the battery which is included in the package (3.7 V, 0.5 A).
- If you do not need the device for a longer period of time, please reset the white calibration and store it in the carrying case.

This user's handbook is published from PCE Instruments without any guarantee.

We expressly point to our general guarantee terms, they can be found in our general terms of business.

If you have any questions please contact PCE Instruments.

3 Specification

3.1 Technical specifications

Measuring aperture	Ø 8 mm
Measuring geometry	8°/d
Sensor	Silicon photoelectric diode
Colour spaces	CIE L*a*b*C*h CIE L*a*b
Colour difference formula	ΔE^*ab ΔL^*ab ΔE^*C^*h
Errors between each equipment	$\leq 0,50 \Delta E^*ab$
Repeatability	average of 30 measurements of standard white plate
Light source	Blue LED (D65)
Lamp life	3 years, more than 1 million measurements
Storage	100 reference values (standards), 20,000 samples
Interface	USB / RS-232
Power supply	Rechargeable lithium-ion battery 3.7 V at 3,200 mAh
Charging time	2 h (8 h at first use)
Battery life	> 3,000 measurements
Operating conditions	Temperature: 0 ... +40 °C Humidity: 0 ... 85 % RH, non-condensing
Dimensions	200 x 70 x 100 mm
Weight	500 g

3.2 Contents of delivery

- 1 x colorimeter PCE-CSM 3
- 1 x USB cable
- 1 x lithium-ion battery
- 1 x mains adaptor
- 1 x calibration plate (white)
- 1 x PC software
- 1 x instruction manual

4 System description

4.1 Button description

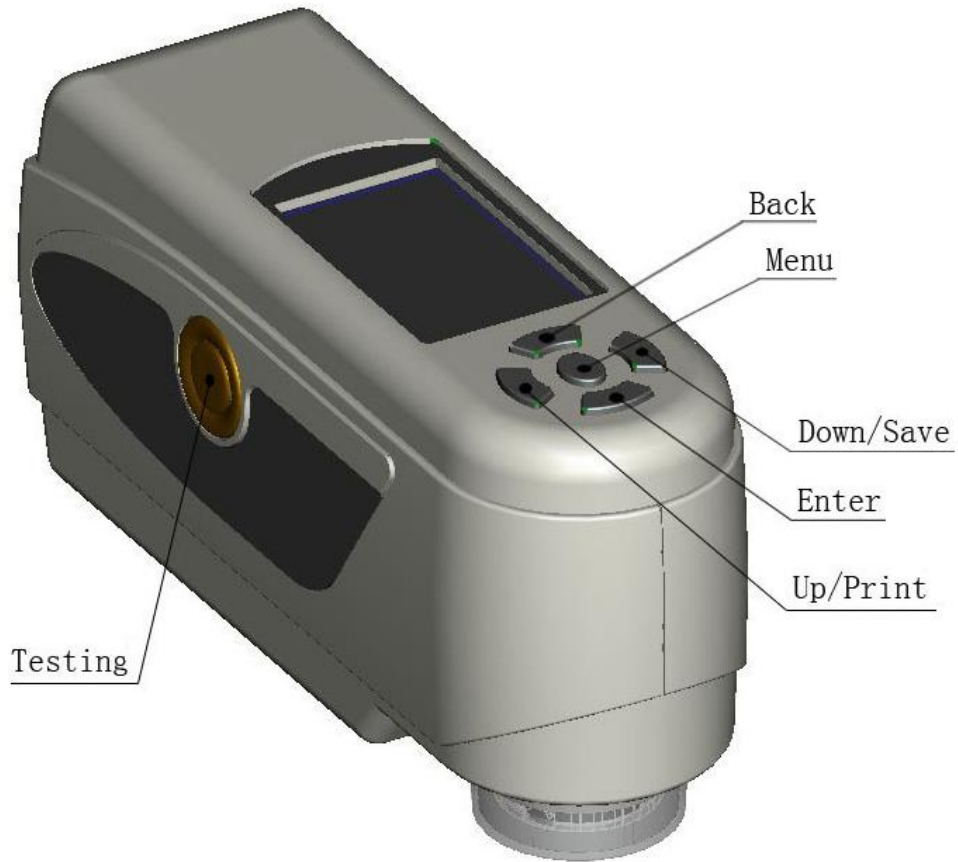

4.2 Interfaces



- Power button: Press this button to turn the device on (button lock in place). Press the button again to turn the device off (button unlocks).
- DC interface: Only use the mains adaptor included in the package. If it breaks down, only use substitutions with the following characteristics: output 5 V DC, 2 A.
- USB/RS-232 interface: By using the USB interface, you can transfer data from the colorimeter to a PC. The baud rate is 115,200 bps.

4.3 Battery

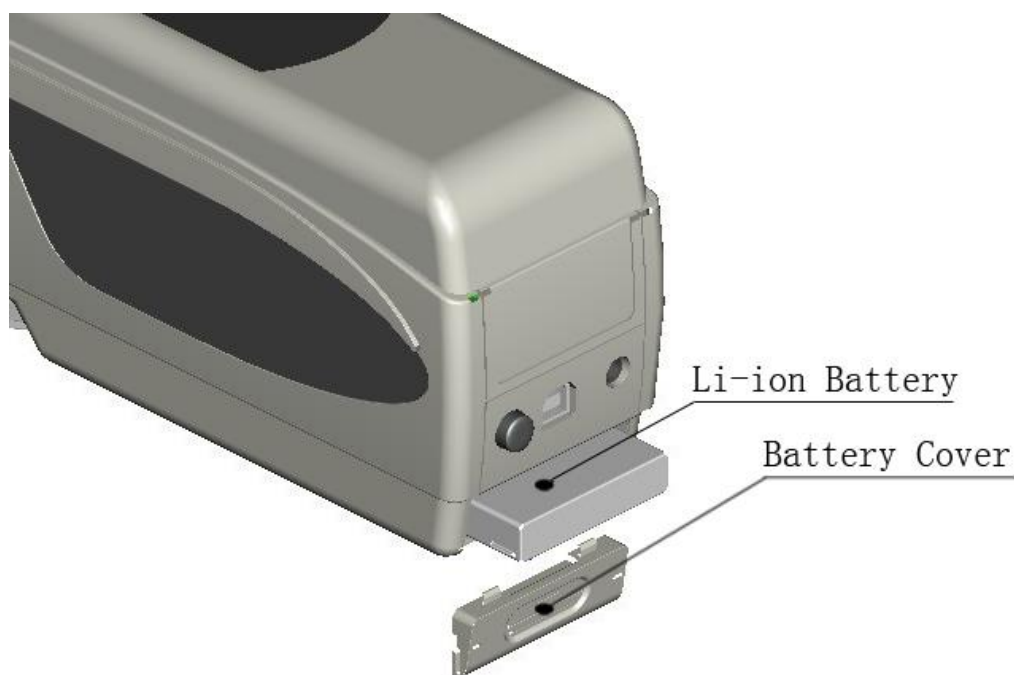

Installing the battery

1. Make sure that the colorimeter is turned off.
2. Open the cover of the battery compartment.
3. Insert the battery into the allocated space.
4. Close the cover of the battery compartment.

Charging the battery

The battery can only be charged when the colorimeter is connected to a PC or to the mains adaptor.

Note: If the battery is damaged, the device can still be used via an external power source (PC / mains adaptor).

5 Operation

5.1 Turn on the device

1. Make sure the battery is installed or the device is connected to an external power source.
2. Turn on the device by pressing the power button. After a few seconds, you are automatically directed to the “Standard Measurement” screen. The default setting for this measuring mode is $L^*a^*b^*C^*h$.

5.2 Take a measurement

If you turn on the device, you are directed to the “Standard Measurement” screen. To take a measurement, follow these steps:

1. Press and hold the testing button (see chapter 4.1). Next, a light cone appears to help you aim at the measuring point.
2. Move the device as close to the measuring point as possible.
3. Release the testing button. The colorimeter now takes a measurement.

After the measuring procedure is finished, you can see the results on the following screen:

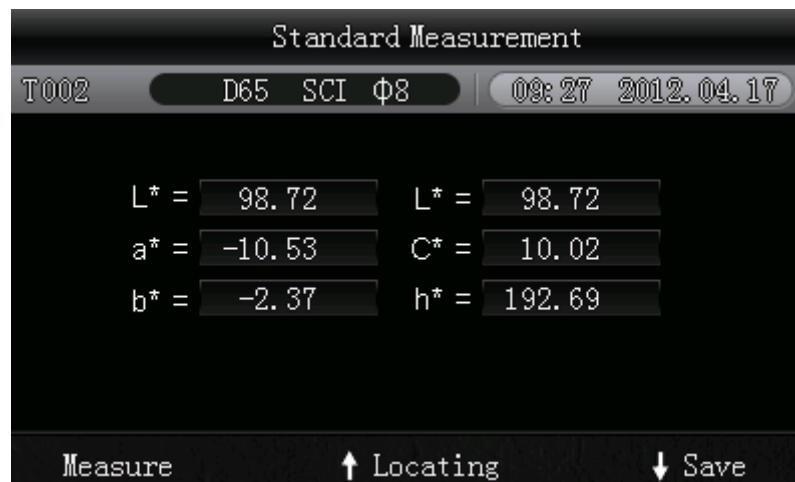

A reading which has been determined by using the “Standard Measurement” automatically serves as a reference value. You can add one or more sample measurements to this reading. To do so, you have to switch to the “Sample Measurement” screen:

1. Press the Enter button \blacktriangleright , if you are in the result screen of the standard measurement function. Now you get to the “Sample Measurement” screen.
2. Take a measurement (just like in you took the standard measurement).
3. Now you can see the results and the deviation to the standard in the following screen:

Sample Measurement		
Na. 001 T002	D65 SCI ϕ 8	09:32 2012.04.17
$L^* =$ 98.72	$\Delta L^* =$ 0.62	White++
$a^* =$ -10.53	$\Delta a^* =$ 0.82	Red++
$b^* =$ -2.37	$\Delta b^* =$ 0.56	Yellow++
$C^* =$ 10.02	$\Delta C^* =$ 0.32	
$h^* =$ 192.69	$\Delta H^* =$ -0.41	
	$\Delta E^* =$ 1.24	Fail
\blacktriangleleft Standard Measure	\blacktriangleup Locating	\blacktriangledown Save

Note: While the measurement is in progress (time duration: ~ 1 second), all buttons are inactive.

To go back to the standard measurement screen, press Back \blacktriangleleft .









5.3 Additional functions

5.3.1 Records



All measuring results are recorded and saved to the internal memory of the colorimeter (if auto save is active). To view the recorded data, press the Menu button \equiv , select “Record” and press Enter to confirm. Now, you get to the following screen:

Standard Record		
T002	D65 SCI ϕ 8	17:12 2012.04.20
$L^* =$ 98.72	$L^* =$ 98.72	
$a^* =$ -10.53	$C^* =$ 10.02	
$b^* =$ -2.37	$h^* =$ 192.69	
\blacktriangleleft Sample Record	MENU: Entering	\blacktriangleleft Delete*



Here you can navigate between the different readings by using the arrow keys (\blacktriangleup and \blacktriangledown)

- If there are any samples attached to a standard, you can view those by pressing Enter . If there is more than one sample, you can use the arrow keys ( and ) for selection.
- If you want to delete a sample, select it and hold the Back button  for ca. 3 seconds. If you press Back  shortly, you get back to the main screen of the record function.
- If you want to subsequently add samples to an existing standard, select the standard and press the Menu button . You are now redirected to the standard measurement screen. Press Enter  to go to the sample measurement screen. Now you can perform a sample measurement, which will be automatically added to the selected standard.
- If you want to turn a sample into a standard, select the standard which the sample is attached to and press Enter . Now, select the sample and press the Menu button . The sample has now turned into a standard.

5.3.2 Calibration

To get to the calibration menu, press the Menu button , select “Calibrate” and press Enter .



Here you can select between white and black calibration. Use the arrow keys ( and ) to select and press Enter  to confirm. A confirmation screen with instructions will appear.

White calibration



If you want to perform a white calibration, place the white calibration plate on the measuring aperture. After that, press the Testing button to start the calibration.

Black calibration

If you wish to perform a black calibration, remove the calibration plate and place the device with the measuring aperture oriented upwards. Make sure that this calibration is carried out in a dark environment. Additionally, keep the device away at least 1 meter from reflecting objects like walls, tables or other objects. To start the calibration process, press the Testing button.

Note: A calibration is only reasonable in the following cases: when first using the device, after strong changes in the environmental conditions, when the device has been used for a long time or when the measurement results are inaccurate.

5.3.3 Connection to a PC or printer



To connect the device to a PC or printer, press the Menu button , select “Comm” and press Enter . Now, you will get to the communication screen.



After that, use the USB cable to connect the device to a PC and press Enter . If the connection was successful, the screen shows “Communicating...”





The device can also be connected to a printer. In this case, all measuring results are printed automatically.



5.3.4 Tolerances

To set up or adjust tolerances, press the Menu button , select “Tolerance” and press Enter . Now, you get to the tolerance screen.





Here you can set up tolerances. To do so, use the arrow keys ( and ) to adjust the selected digit.

Press Enter  to go to the next digit. After confirming the last digit by pressing Enter , the tolerance is set up.

5.3.5 Delete recorded data

To delete the recorded data, press the Menu button , select “Delete” and press Enter . Now, you get to the deletion screen.



Here you have two different options. You can either delete all sample measurements (“Delete ALL Samples”) or all records (“Delete ALL Records”).





Select the desired option by using the arrow keys ( and ) and press Enter . A confirmation screen appears. Press Enter  to confirm or Back  to cancel.

Note: If you delete all records, all sample measurements will be deleted as well.

5.3.6 Averaging

You can set the number of measurements which are performed during the measuring procedure. From these particular measurement results, the average value is generated.

To get to the averaging settings, press the Menu button , select “Average” and press Enter .

Here, you can set the number of measurements. Use the arrow keys ( and ) to adjust the selected digit. Press Enter  to go to the next digit. After confirming the last digit by pressing Enter , the averaging is set.

Note: If you set “00” or “01”, there will be no averaging.

5.3.7 Display mode

To change the display mode, press the Menu button \equiv , select “Display” and press Enter \leftarrow . Now, you get to the display mode settings.

Here you have three different options: “CIE L*a*b*C*H*”, “CIE L*a*b*” and “CIE XYZ”. Use the arrow keys (\uparrow and \downarrow) to select the desired option and press Enter \leftarrow to confirm.



*Note: CIE L*a*b*C*H* is set by default.*

5.3.8 Language

To adjust the language of the colorimeter, press the Menu button \equiv , select “Language” and press Enter \leftarrow . Now you get to the language selection. You can choose between English and Chinese. Select an option by using the arrow keys (\uparrow and \downarrow) and press Enter \leftarrow to confirm.

6 Settings

To get to the settings, press the Menu button \equiv , select “Setting” and press Enter \leftarrow .

Here you have different options. Use the arrow keys (\uparrow and \downarrow) to navigate and confirm the selection by pressing Enter \leftarrow .

6.1 Auto save

Here you choose if the measured data is recorded automatically or not. Choose the desired option by using the arrow keys (\uparrow and \downarrow) and press Enter \leftarrow to confirm. If auto save is inactive, you can manually save the data by pressing the Down/Save button \downarrow .

6.2 Time setting

Here you can set the time (“Set time”), date (“Set date”) and how time and date are displayed (“Time format” / “Date format”). Select the desired option by using the arrow keys (↑ and ↓) and press Enter ↵ to confirm.

Set time / date

Here you can set the individual digits of the time and date. Adjust the selected digit by using the arrow keys (↑ and ↓) and press Enter ↵ to get to the next digit. After confirming the last digit by pressing Enter ↵, the time / date is set.

Time format

Here you can choose between 24 h format and 12 h format. Use the arrow keys (↑ and ↓) for selection and press Enter ↵ to confirm.

Date format

Here you can choose between year-month-day, month-day-year and day-month-year. Use the arrow keys (↑ and ↓) for selection and press Enter ↵ to confirm.

6.3 Print settings

Here you can choose if the measurement results are printed automatically or not when a printer is connected to the colorimeter. Choose the desired option by using the arrow keys (↑ and ↓) and press Enter ↵ to confirm. If automatic printing is turned off, you can print the data by pressing and holding the Up/Print button ↑ .

6.4 Backlight time

Here you can choose how long the backlighting shall be active. Choose the desired option by using the arrow keys (↑ and ↓) and press Enter ↵ to confirm.

6.5 Brightness setting

Here you can adjust the brightness of the display. Use the arrow keys (↑ and ↓) to select an option and press Enter ↵ to confirm.

6.6 Battery capacity

Here you can check the battery status.

6.7 Restore factory

Here you can restore the factory settings. To do so, press Enter ↵ in the confirmation screen. Press Back ↶ to cancel.

7 Optional Accessories

7.1 Powder test box PCE-CSM PTB

With the optional powder test box PCE-CSM PTB you can determine the colorimetric parameters of powders.

7.1.1 Build-up

The PCE-CSM PTB is built up of a base plate (1), a measuring plate with a powder compartment (2), a lens (3) and a mounting ring (4).

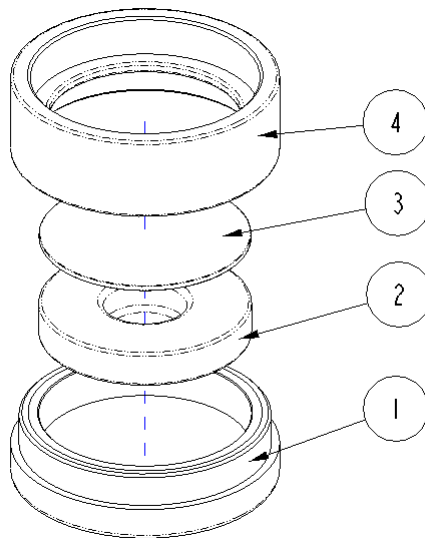

7.1.2 Operation

1. **Calibration:** Put the lens on the white calibrations plate and perform a white calibration. After that, perform a black calibration.
2. **Fill in the powder:** Fill the powder into the powder compartment of the measuring plate.

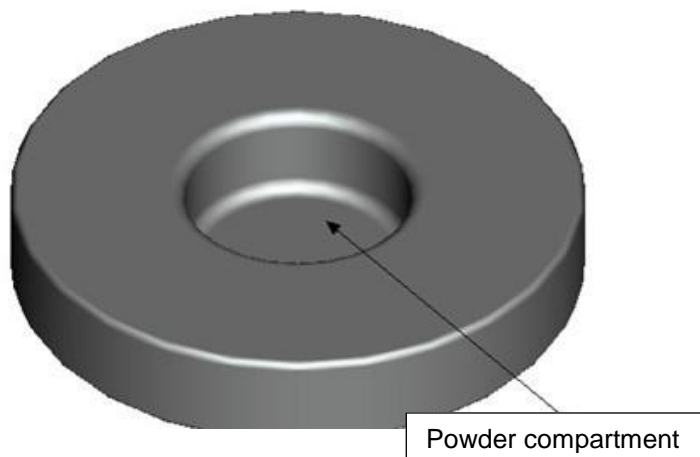

After that, put the powder test box back together (see 7.1.1). Make sure the screw joint is straight.

3. **Measure:** Place the measuring hole of the colorimeter on the hole of the powder test box and perform a measurement. Make sure the colorimeter is stable.
4. **Clean the test box:** After using the powder test box, disassemble and clean it. If needed, you can use alcohol for cleaning. After the cleaning, let the box dry and store it properly until the next use.

7.2 Measuring device for liquids, pastes and powders PCE-CSM UTC

With the optional measuring device PCE-CSM UTC, you can determine the colorimetric parameters of liquids, pastes and powders.

7.2.1 Build-up

The PCE-CSM UTC is built up of a base plate (1), an alignment plate for the colorimeter (2), a measuring chamber (3) with a measuring hole (31), a tank with filling level indication (4), a cover plate (5) and an adjuster plate (6) with safety screws (7).

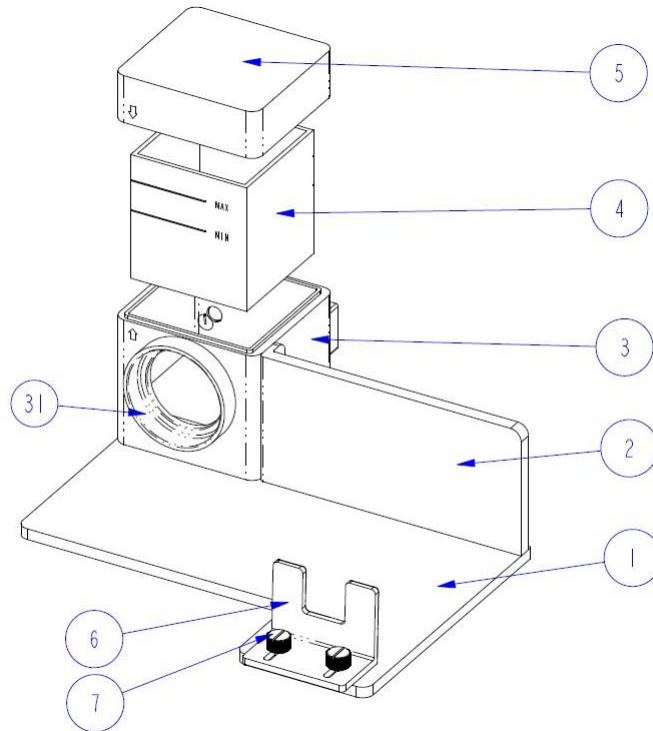

7.2.2 Operation

1. Put the colorimeter in the measuring device PCE-CSM UTC (as seen on the picture below) and tighten it by using the adjuster plate (6) and the safety screws (7). The Measuring hole should align with the measuring hole of the measuring chamber (3). Make sure that the colorimeter is in the right place and tightened properly before moving on.

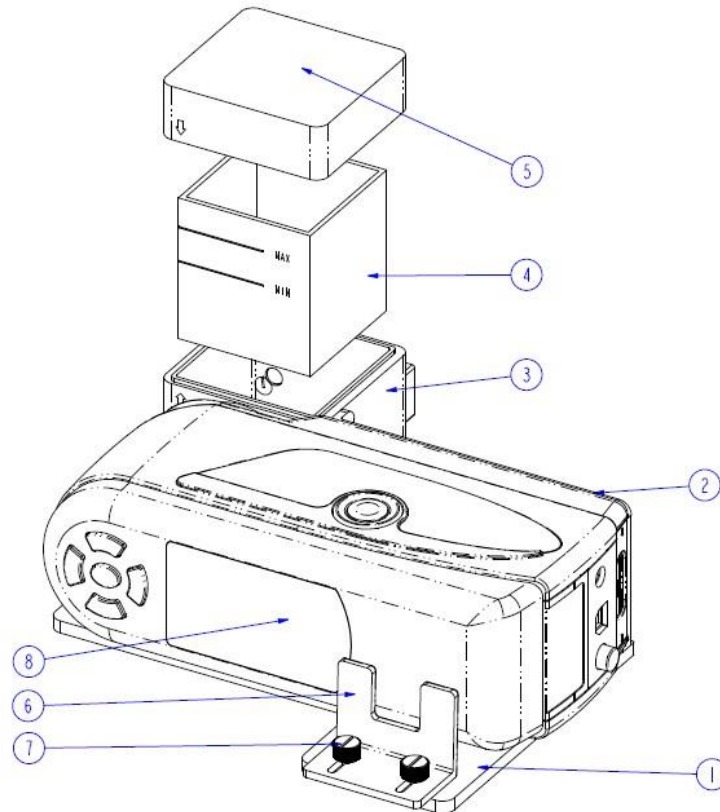

2. Fill the tank (4) with the desired medium and put it into the measuring chamber (3). Make sure the filling level lies between the MIN and the MAX indication of the tank. The tank has two sides with a dull surface. Only touch it on those two sides to prevent measurement errors due to dirt.

- Put the cover plate (5) on the measuring chamber of the PCE-CSM UTC. There is an indication on the cover plate, as well as on the measuring chamber. Please make sure that these indications are aligned properly (see picture below).

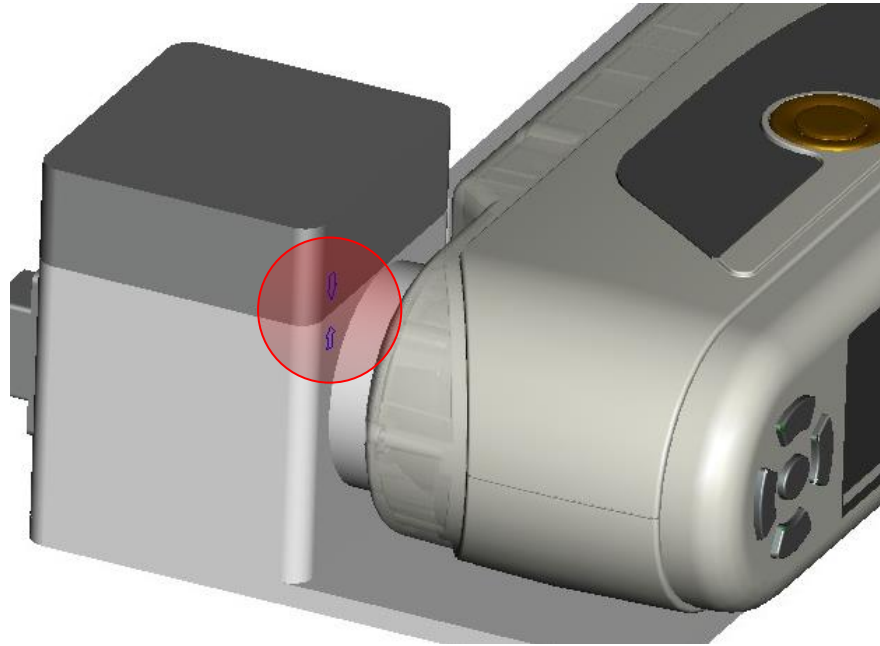

- Perform a measurement with the colorimeter.
- Clean the measuring device before each use. Do not use abrasive or corrosive materials to prevent tank from being scratched.
After cleaning, put the cover plate back on the measuring chamber to keep it clean during storage.

8 Contact

If you have any questions about our range of products or measuring instruments please contact PCE Instruments.

8.1 PCE Instruments UK

By post:

PCE Instruments UK Ltd.
Units 12/13 Southpoint Business Park
Ensign Way, Southampton
Hampshire

United Kingdom, SO31 4RF

By phone:

02380 987 035

8.2 PCE Americas

By post:

PCE Americas Inc.
711 Commerce Way
Suite 8
Jupiter
33458 FL
USA

By phone:

561 320 9162

