

# specifications

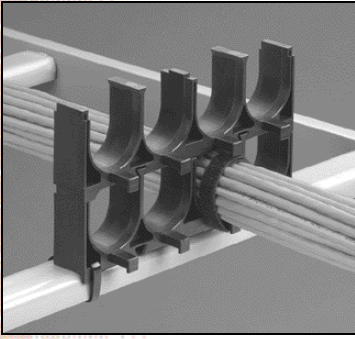

Stackable cable rack spacers shall be utilized to route bulk fiber optic cable or communication cable bundles. Stackable cable rack spacers shall be utilized in communication closets and other interior locations where cables and cable bundles are routed along traditional ladder racks that consist of rungs and stringers. The stackable cable rack spacers shall be applied on every rung up to a recommended maximum stack height. Dovetail slots and a positive latching mechanism shall provide a secure locking feature.



ELECTRICAL GROUP

# SPEC SHEET

## STACKABLE CABLE RACK SPACERS

### technical information

<b>Dimension:</b>	CRS6-X	H x W x D	1.12" x 5.25" x 1.19"
	CRS1-X	H x W x D	1.12" x 1.12" x 1.19"
	CRS4-125-X	H x W x D	1.54" x 5.20" x 1.19"
	CRS1-125-X	H x W x D	1.54" x 1.55" x 1.19"
<b>Capacity:</b>	CRS6-X	6 cavities that will accept cable or cable bundles up to 0.8" in diameter. (12 CAT 5 cables or 72 strand fiber optic cable)	
	CRS1-X	1 cavity that will accept cable or cable bundles up to 0.8" in diameter. (12 CAT 5 cables or 72 strand fiber optic cable)	
	CRS4-125-X	4 cavities that will accept cable or cable bundles up to 1.25" in diameter. (24 CAT 5 cables)	
	CRS1-125-X	1 cavity that will accept cable or cable bundles up to 1.25" in diameter. (24 CAT 5 cables)	
<b>Packaging:</b>	Packaged 10 per bag.		
<b>Standards:</b>	CRS1-125-X and CRS4-125-X are manufactured from a material that meets UL94-V0 specifications.		

### key features and...benefits

<b>Easy Installation</b>	Secures to ladder rack with standard cross section cable ties (PLT1.5S-C0 or PLT2S-M60).
<b>Cable Retaining Posts</b>	Allows user to secure cable to spacer to prevent movement of cable.
<b>Available in Multiple Widths</b>	Use multiple 6-position or 4-position parts placed horizontally to fill the majority of the rack. Use single position parts to fill capacity of ladder rack.
<b>Eliminates Pinch Points</b>	Product separates and supports cable and prevents pinch points between the bottom row of cable and the rung as a result of the weight of multiple cable layers applied on top of each other.
<b>Stackable</b>	Maximize rack space by stacking product for maximum cable capacity.

### applications

PANDUIT's cable rack spacers are designed to eliminate pinch points and provide an aesthetically pleasing installation. When multiple cable layers are applied on the ladder rack, the rungs may cause pinch points where pressure is applied on a point of the cable. Cable rack spacers can make an attractive installation and keep cables segregated to allow installers to quickly identify the location of the cable.

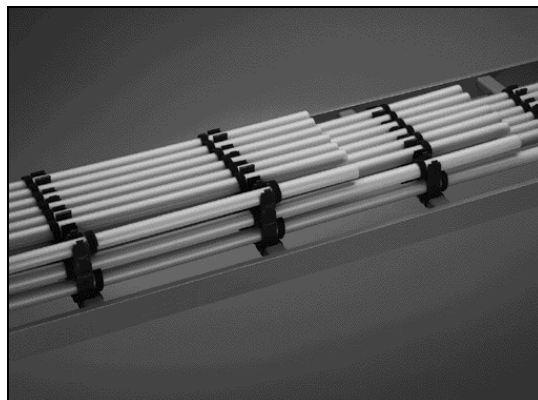

### TAK-TY™ Hook & Loop Cable Ties

Part Number:	Application:
HLM-15R0	To secure cable to retaining posts
HLSP1.5S-X0	Flame Rated Tie to secure cable to retaining posts

### Nylon Cable Ties

PLT1.5S-C0	To secure spacer to ladder
ILT1.5S-C0	To secure cable to retaining posts
PLT2S-M60	Flame Rated Tie to secure spacer to ladder

### Waterfall Accessories

CMW-KIT	Waterfall Kit
CMWB	Waterfall Base
CMWW	Waterfall Wing

### Other Accessories

CMVDR1	1" Vertical D-ring
CMVDR2	2" Vertical D-ring
CMVDR2S	2" Vertical D-ring Short
CMVDRC	Center Vertical D-ring
BR2-1.3-A	2" Bundle Retainer
BR2-1.3	2" Bundle Retainer
PPF2S-S25-V	Flat Pan-Post
PF2SV-S25-V	Flame Rated Flat Pan-Post
PPF2S-S25-V69	Flame Rated Flat Pan-Post
PPF2SV-S25-V69	Flame Rated Flat Pan-Post

### installer tip

Use GTS Cable Tie Installation Tool to install cable ties when installing the first layer of cable rack spacers. The GTS tool allows for correct tensioning and cable tie cut-off.

# PANDUIT® Stackable Cable Rack Spacers

## General Installation Instructions for Stackable Cable Rack Spacers

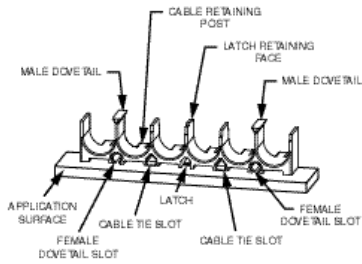

View 1 (CRS6-X)

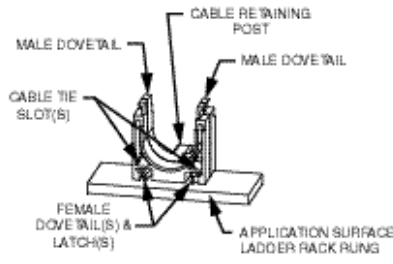

View 2 (CRS1-X and CRS1-125-X)

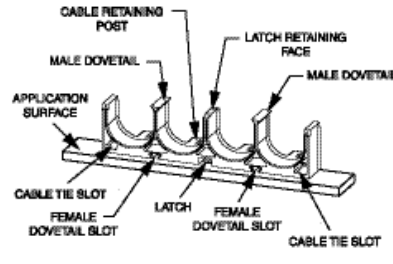

View 3 (CRS4-125-X)

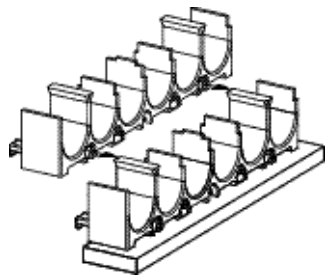

View 4

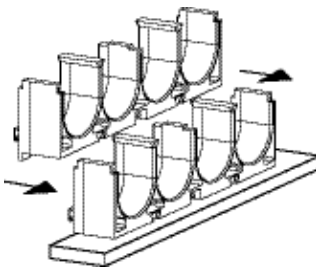

View 5

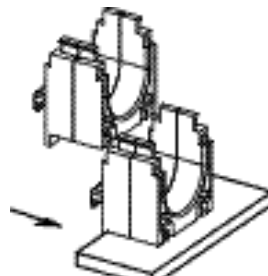

View 6

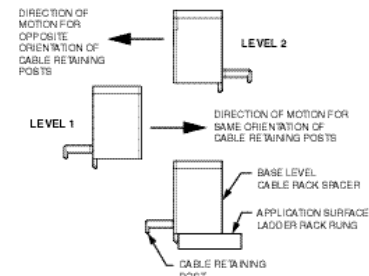

View 7

1. Secure bottom level of Stackable Cable Rack Spacer to the application surface, i.e. ladder rung with two standard cross-section *PANDUIT*® *PAN-TY*™ Cable Ties (View 1, 2, and 3).
2. Install cable or cable bundles into each of the cable retaining areas (View 1, 2, and 3).
3. Secure cable to the cable retaining posts (View 1, 2, and 3) with *PANDUIT* *PAN-TY* Cable Ties, *BELT-TY*™ IN-LINE Cable Ties, or *TAK-TY*™ Hook & Loop Cable Ties up to 0.33" in width.
4. Installation of the next level of Stackable Cable Rack Spacers is accomplished by sliding the male dovetail into the female dovetail slot (View 4, 5, and 6). The latch/latches will lock the parts into position. To unlock these parts, use a screwdriver or a small tool to release latch/latches and slide in opposite direction.
5. Repeat steps 2, 3, and 4 until a maximum stack height is achieved. *PANDUIT* recommends a maximum stack height of five for the CRS6-X and CRS1-X. A maximum stack height of four is recommended for the CRS4-125-X, and CRS1-125-X. Stackable Cable Rack Spacers are reversible to allow cable retaining posts to be alternated (View 7).

- A typical *PANDUIT* *PAN-TY*® Cable Tie part number is PLT2S-C0 or PLT2S-M60.
- A typical *PANDUIT* *BELT-TY*™ IN-LINE Cable Tie part number is ILT2S-M0.
- A typical *PANDUIT* *TAK-TY*™ Hook & Loop part number is HLM-15R0.
- Refer to *PANDUIT* Network Connectivity Systems Catalog (SA101N423A-OP) for more information.

Our products are warranted to be free from defects in material and workmanship at the time of sale but our obligation under this warranty is limited to the replacement of any product proved to be defective within 6 months (for product) or 90 days (for tools) from the date of delivery. Tool warranty is void if Panduit tools are modified, altered or misused in any way. Use of Panduit tooling with any product other than the specified Panduit products for which the tool was designed, constitutes misuse. Before using, user shall determine the suitability of the product for his intended use and user assumes all risk and liability whatsoever in connection therewith.

This warranty is made in lieu of and excludes all other warranties, expressed or implied. THE IMPLIED WARRANTIES OF MERCHANTABILITY AND FITNESS FOR A PARTICULAR USE ARE SPECIFICALLY EXCLUDED. Neither seller nor manufacturer shall be liable for any other injury, loss or damage, whether direct or consequential, arising out of the use of, or the inability to use, the product. The information contained in this literature is based on our experience to date and is believed to be reliable. It is intended as a guide for use by persons having technical skill at their own discretion and risk. We do not guarantee favorable results or assume any liability in connection with its use. Dimensions contained herein are for reference purposes only. For specific dimensional requirements consult the factory. This publication is not to be taken as a license to operate under, or a recommendation to infringe any existing patents. This supersedes and voids all previous literature, etc.



WORLD HEADQUARTERS  
PANDUIT CORP.  
Tinley Park, Illinois, USA  
Phone: 800-777-3300  
Fax: 708-532-1811  
Email: info@panduit.com  
Internet: www.panduit.com

**For Pricing and Further Information –  
Contact your local authorized  
PANDUIT Distributor or Sales Office**

PANDUIT CANADA  
Div. of PANDUIT CORP.  
Markham, Ontario  
Phone: 905-475-6922

EUROPEAN HEADQUARTERS  
PANDUIT EUROPE LTD.  
London, UK  
Phone: 44 (0) 208-601-7200

ASIAN HEADQUARTERS  
PANDUIT SINGAPORE PTE. LTD.  
Republic of Singapore  
Phone: (65) 379 6700

PANDUIT MEXICO/ LATIN AMERICA &  
CARIBBEAN  
Phone: (52) 3 666-2501