

PANDUIT P/N	WEIGHT
P08D09M	5.8kg

NOTES:

1. IDENTIFICATION:

UNIT TYPE:	MONITORED INPUT
ORIENTATION:	HORIZONTAL, 1U
OUTLET QTY&TYPE:	(8) 5-20R
BREAKER QTY&TYPE:	N/A
INPUT VOLTAGE:	100-120VAC
INPUT CURRENT:	16A (12A DERETED)
INPUT PHASE:	SINGLE-PHASE
RATED POWER:	1.9kVA
INPUT PLUG:	NEMA 5-15P
INPUT CORD LENGTH:	3m [10']

2. ACCESSORIES:

- POCKET GUIDE
- QTY: (4) M6 X 12 PAN HEAD MACHINE SCREWS
- QTY: (4) M6 CAGED NUT

3. RoHS COMPLIANT

4. VISIT PANDUIT'S ON-LINE CATALOG AT WWW.PANDUIT.COM FOR ADDITIONAL PRODUCT INFORMATION CONTAINED IN THE SPECIFICATION SHEET AS WELL AS A CURRENT LIST OF PRODUCTS APPLICABLE FOR USE WITH THIS PART

5. MAXIMUM ALLOWABLE INPUT POWER = 1.9kW

6. INSTALLATION SHALL COMPLY WITH ALL APPLICABLE NATIONAL, STATE, AND LOCAL CODES

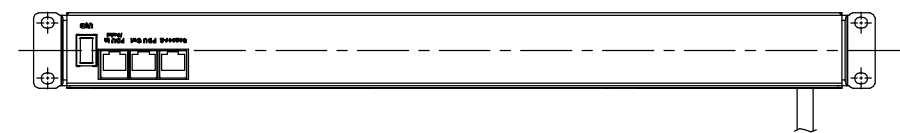

REAR VIEW

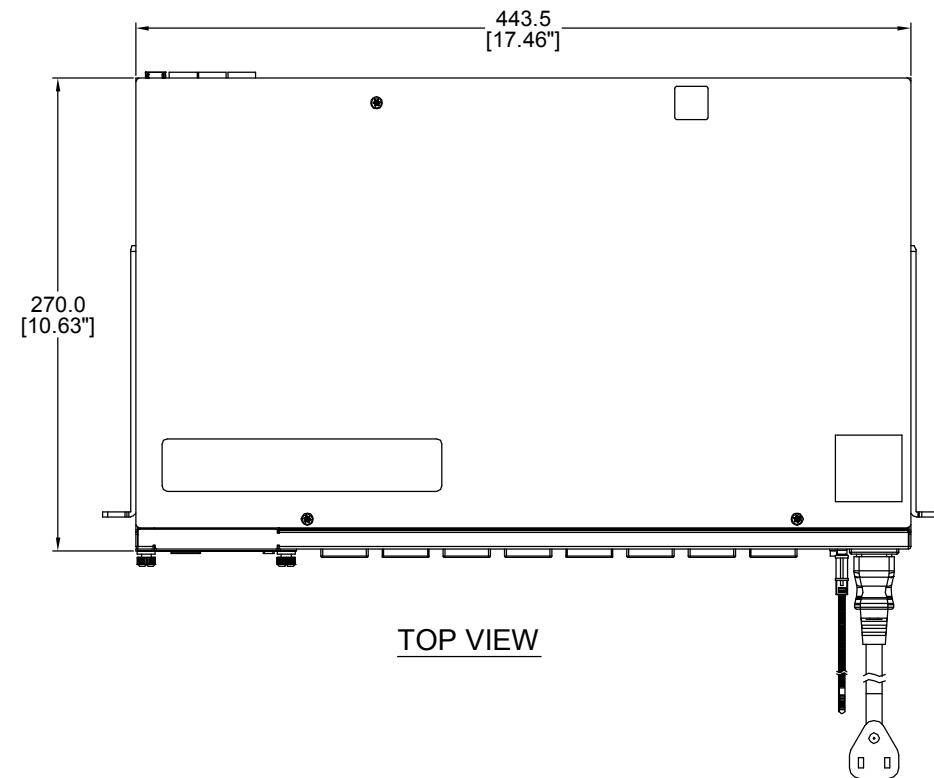

TOP VIEW

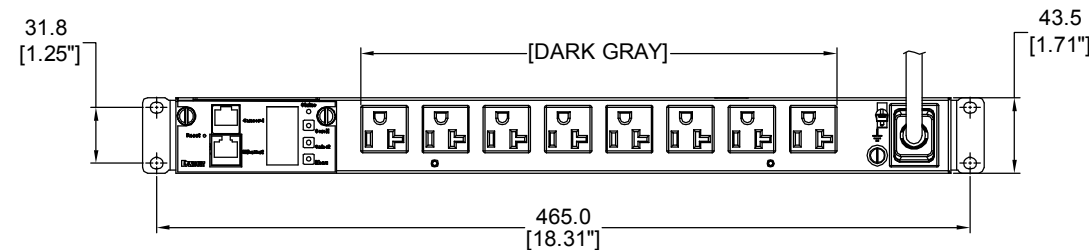

FRONT VIEW

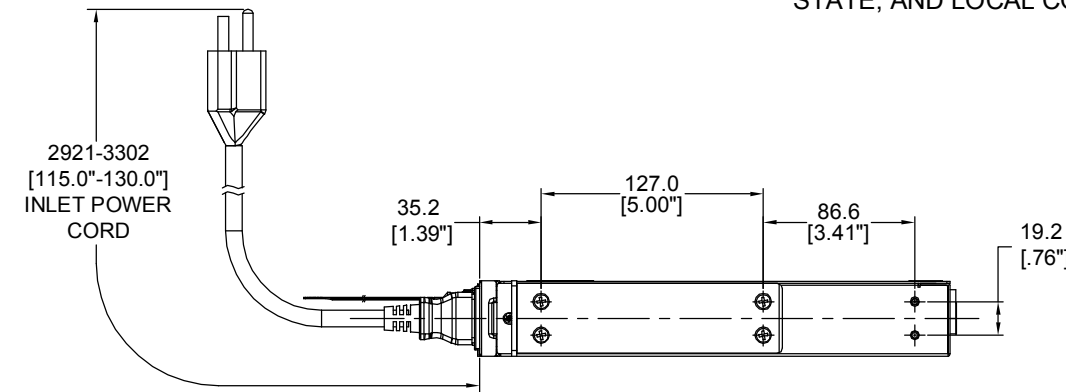

SIDE VIEW

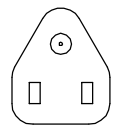

PLUG
15 AMP, 125V
STRAIGHT BLADE
NEMA 5-15P

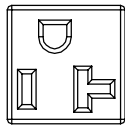

EIGHT (8)
RECEPTACLES
20 AMP, 125V
STRAIGHT BLADE
NEMA 5-20R

REV	DATE	BY	CHK	APR	DESCRIPTION	ECN
01A	07/19/2017	WSJ	MIM	EDM	INITIAL RELEASE	P08D09M

WE ASK THAT YOU CHECK FULLY THE DIMENSIONS, NOTES, AND SIGN THE CLIENT SIGNATURE BOX. THE JOB WILL NOT PROGRESS WITHOUT SIGNED APPROVAL. PLEASE DO NOT DELAY IN RETURNING PROOF AS IT WILL AFFECT DELIVERY		SIGN
		DATE
		PRINT
TITLE		
INTELLIGENT SERIES PDU P08D09M CUSTOMER DRAWING		
ITEM REVISION NAME		PANDUIT
DATASHEET FILE NAME:		
UNLESS OTHERWISE SPECIFIED DIMENSIONAL TOLERANCE ARE: mm [IN]		MATERIAL/COLOR:
 THIRD ANGLE PROJECTION		N/A
		DRAWING NUMBER: P08D09M_DC
DRAWN BY	DATE	CHK
WSJ	07/19/2017	SEAN
SCALE	NONE	
SHT 1 OF 1		SCALE B