

Net-Contain™ and Net-Direct™ Thermal Management Solution

*Improved Energy Efficiency in the Data Center while
Increasing kW per Cabinet Density*

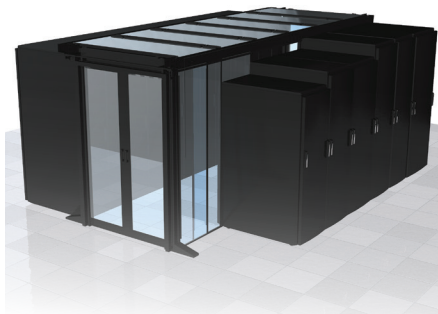

Rising energy consumption in the data center is increasing energy costs to the point where facility and IT managers are forced to focus on addressing this challenge. To face this growing concern, the American Society of Heating, Refrigerating and Air-Conditioning Engineers (ASHRAE) has changed the recommended data

center operating temperature from 77°F to 80°F. This temperature change allows for a lighter energy load by reducing the impact on IT equipment, which decreases costs.

To accommodate the ASHRAE recommendations and allow the data center to fully benefit from the energy savings, Panduit offers a complete solution that provides greater thermal management and energy efficiency as well as accessibility and flexibility while managing and protecting equipment.

This application guide provides an overview of key design considerations and applications for thermal management and energy efficiency within the data center. These considerations will provide a better understanding of why the use of thermal management systems is important.

Introduction

User Guide	2
----------------------	---

Solutions

Net-Contain™ Aisle Containment Systems	3 – 6
Applications and Key Selection Criteria	7
Cabinet Containment Sealing Scenarios	8
Net-Direct™ Passive In-Cabinet Ducting	9
Net-Direct™ Passive In-Cabinet Top of Rack Ducting	10
Ducting Versus No Ducting	11
Thermal Management Accessories	12 – 14
Key Advantages and Competitive Analysis	14
Sealing Proof Point	15

***Brownfield
Data Centers***

***Greenfield
Data Centers***

Introduction

User Guide

This section includes product recommendations for high density applications on raised or slab floors. When considering product recommendations, it is important to always verify product suitability based on your specific requirements and key selection criteria.

Consider Panduit thermal management products to enable high-density, high heat load data center designs while reducing energy costs of a typical data center. The complete solution includes Panduit® Net-Access™ N-Type and S-Type Cabinets and thermal products and accessories. These systems significantly reduce total cost of ownership by increasing network availability, mitigating risk, and minimizing power consumption.

Net-Access™ N-Type Cabinets are designed for applications that require maximum thermal management capability and the capacity to manage high cable densities. Net-Access™ S-Type Cabinets incorporate integral thermal sealing and cable management options that provide cost effective solutions to meet the diverse application needs of today's data centers. Both cabinet types are available in black, white, and gray.

Panduit Thermal Management Systems

Energy savings:

Separate hot and cold air to deliver higher return air temperatures to the cooling system and allow higher room set points. Lower PUE to maintain thermal efficiency.

Increased reliability of IT equipment:

Lower the fan speed of the switches because they are not required to operate as vigorously.

Ability to follow ASHRAE standards:

Deploying thermal management solutions automatically allows you to meet standards requirements.



Solutions

Net-Contain™ Aisle Containment Systems

Data Center Managers, challenged to maximize the utilization of available rack space and cooling capacity, often increase the power density per cabinet. As cabinet power densities rise, containment architectures are the optimal approach, ensuring uniform cooling air temperature is delivered to equipment in high density PODs, which allow full utilization of available cabinet space and cooling capacity.

Choosing the right aisle containment solution depends upon a number of factors, including:

- Channeling cold air directly into the switch intake
- Data center density
- Uniformity of racks and aisles
- Whether “raised floor” cooling is employed
- Availability of a ceiling plenum to accept hot air
- Room height

Net Contain™ Passive Cold Aisle Containment

The Net-Contain™ Passive Cold Aisle Containment (CAC) System provides a physical separation between the cold air and the hot exhaust air by enclosing the cold aisle. The goal of a CAC system is to supply cold air to the cold aisle where the equipment air intakes are located to optimize airflow distribution and improve cooling system thermal performance. As a result, a cold aisle system is typically used in high-density data centers because it is more efficient to direct cold air onto densely populated racks than to cool the entire room.

This integrated system is compatible with numerous Panduit product lines including; Net-Access™ N-Type and S-Type Cabinets, FiberRunner®, and Wyr-Grid® Overhead Cable Routing Systems.

Benefits

Energy Efficiency:

Prevents hot spots and allows installation of high-density server cabinets close together in new builds or existing data centers, reducing the need for extra real estate and CRAH units lowering operating costs.

Optimized Airflow Distribution:

Prevents mixing of cold and hot air streams; eliminates recirculation of hot air to cabinet inlets; provides uniform temperature at the inlets of IT equipment; prevents cold air bypass optimizing cool air delivery.

Improves Thermal Performance:

Allows raising supply air set point temperature; higher return air temperature increases the thermal efficiency of cooling units, reducing cooling energy cost up to 25 – 30%.

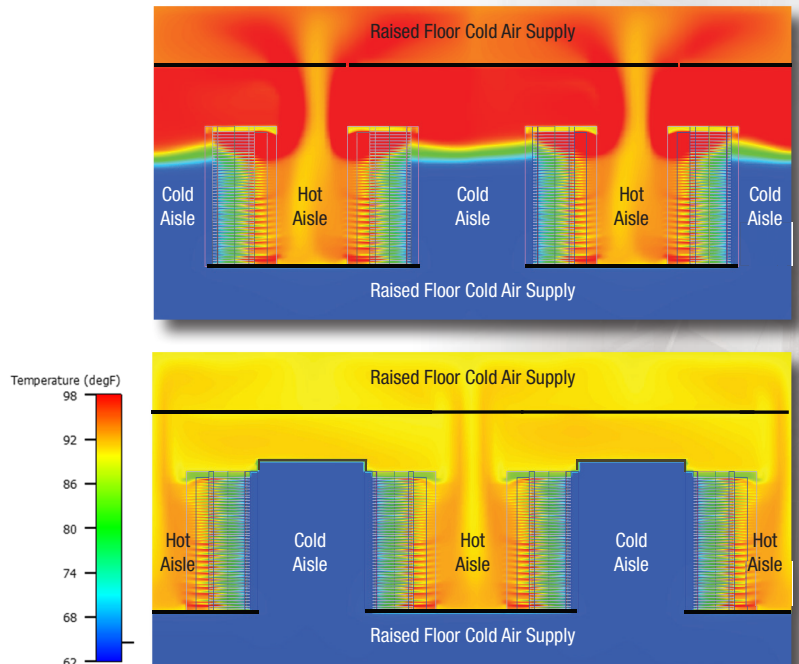
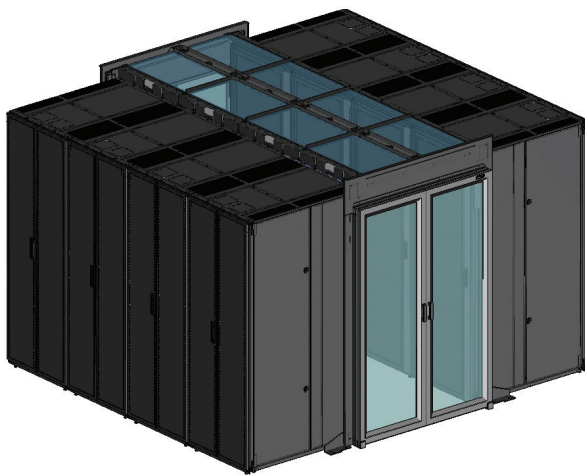

Net Contain™ Passive Hot Aisle Containment

The Net-Contain™ Passive Hot Aisle Containment (HAC) System provides a physical separation between the cold air and the hot exhaust air by enclosing the hot aisle. The goal of a HAC system is to capture all of the cabinet exhaust air and return it to the cooling units. HAC optimizes airflow distribution and cooling system performance. The remaining area outside of the HAC becomes a cold room with ambient air temperature close to the supply air temperature.

This integrated system is compatible with numerous Panduit product lines including: Net-Access™ N-Type and S-Type Cabinets, FiberRunner®, and Wyr-Grid® Overhead Cable Routing Systems.

Benefits

Energy Efficiency:

Prevents hot spots and allows installation of high-density server cabinets close together in new builds or existing data centers, reducing the need for extra real estate and CRAH units lowering operating costs.

Optimized Airflow Distribution:

Prevents mixing of cold and hot air streams; eliminates recirculation of hot air to cabinet inlets; provides uniform temperature at the inlets of IT equipment; prevents cold air bypass, optimizing cool air delivery.

Improves Thermal Performance:

Allows raising supply air set point temperature; higher return air temperature increases the thermal efficiency of cooling units, reducing cooling energy cost up to 25 – 30%.

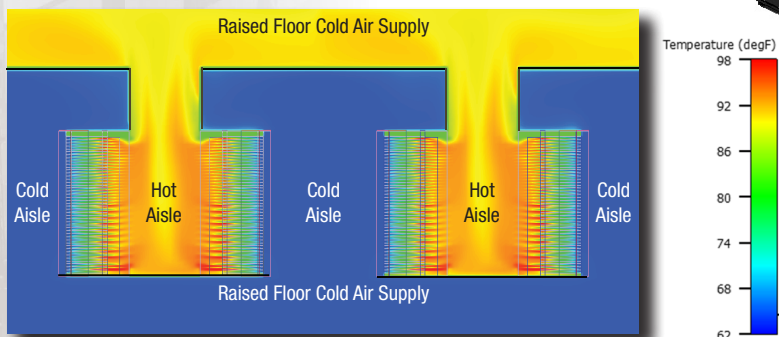
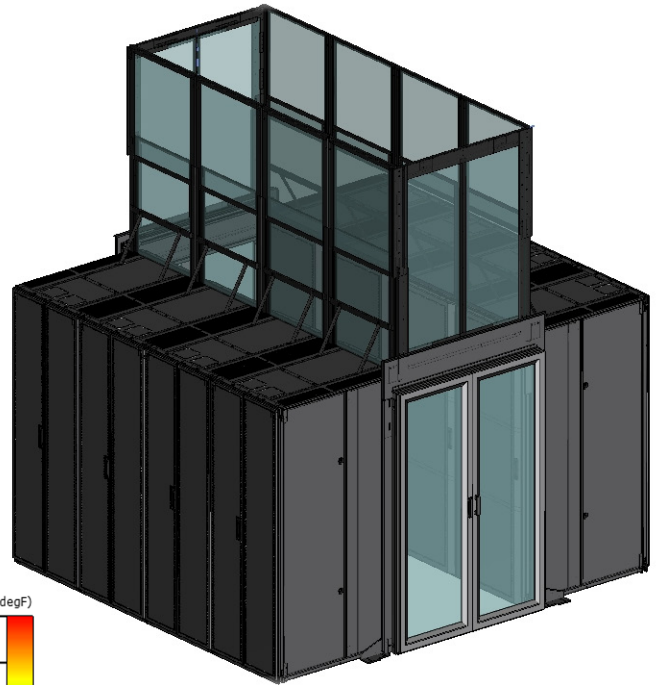

Net-Contain™ Universal Aisle Containment System

The Net-Contain™ Universal Containment System allows you to reclaim underutilized cooling capacity, reduce energy expense and reduce CapEx by retrofitting your existing data center with an innovative containment system. The system includes independent support structure, sliding doors, vertical blanking panels and roof structure. This offering can be configured in Hot Aisle and Cold Aisle containment and allows the addition of cabinets (Panduit or non-Panduit) of varying sizes and design as your needs dictate, reducing deployment time and capital investment.

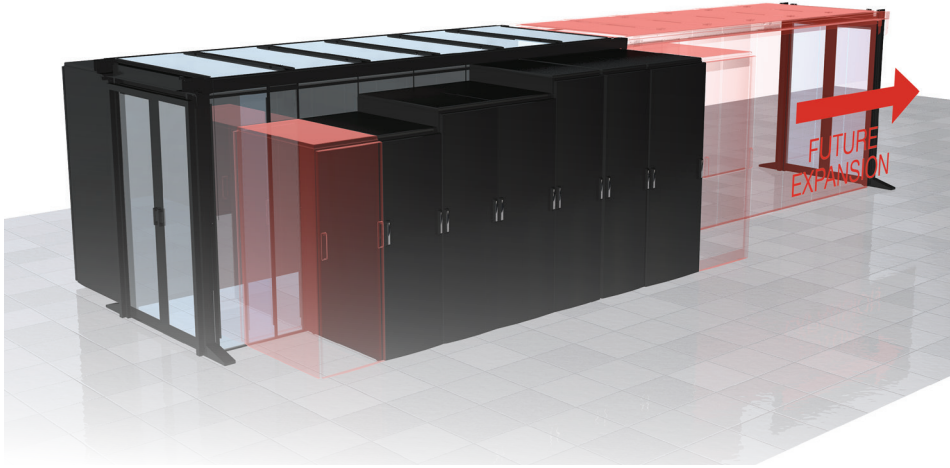

Application: Retrofit in Brownfield or deploy in Greenfield application.

Benefits

Reclaim Cooling Capacity:

Retrofitting the Universal Aisle Containment System into your existing data center allows you to optimize the separation of hot and cold air, enabling higher per cabinet density, reclaiming 10% of existing cooling capacity and saving up to 27% on operational expenses (OpEx).

Reduce Operational Expenses (OpEx):

Containment reduces cooling energy consumption by as much as 40%. In addition, the Universal Aisle Containment System seamlessly integrates with the SmartZone™ DCIM offering allowing you to effectively monitor and manage your assets.

Reduce Capital Expenses (CapEx):

The Universal Aisle Containment System provides you with the flexibility to build a containment system and then add cabinets of varying sizes and design as your needs dictate reducing time and capital investment.

Net-Contain™ Vertical Exhaust System

VEDs separate the hot exhaust air from the cool air and direct the hot exhaust directly into the hot air return system, allowing a higher return air temperature which improves Computer Room Air Handler (CRAH) and heat exchanger efficiency. The Net-Contain™ Vertical Exhaust Duct (VED) can be installed on top of Net-Access™ Switch and Server Cabinets, allowing the support of heat loads up to 30kW per cabinet.

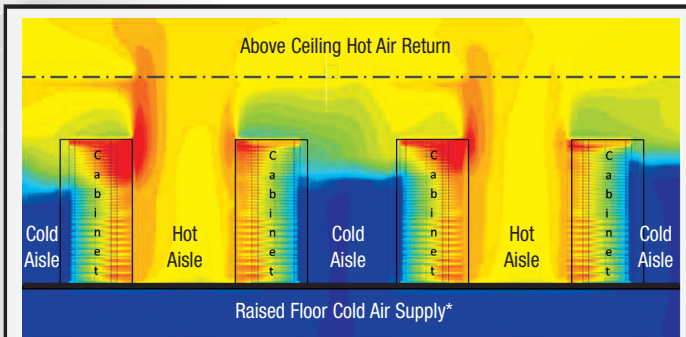

Typical Data Center

- Cool air does not reach the top portions of the cabinets, making servers in the top rack units vulnerable to overheating
- Hot exhaust air follows complex airflow path back to CRAH units

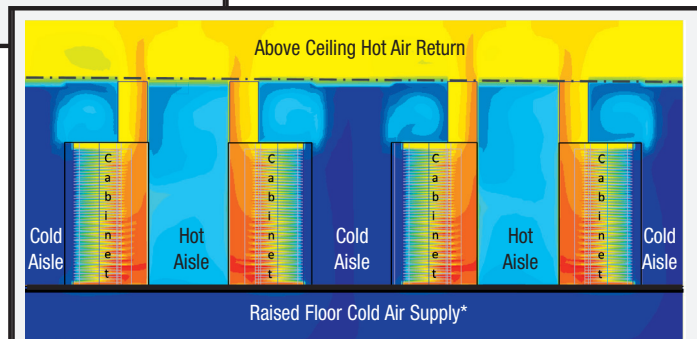

Data Center Utilizing Panduit® Net-Contain™ Vertical Exhaust Duct

- Uniform distribution of cool air reaching the top of the cabinet
- Hot exhaust air is isolated and ducted directly to CRAH units

Applications

Key Selection Criteria/Compliance with Industry Standards

Panduit thermal management solutions are engineered to the highest standards. Our products meet or exceed the most stringent industry standards including ASHRAE and fire code standards (NFPA).

Selection criteria for Standard Hot Aisle/Cold Aisle (HA/CA) vs. VED vs. CAC vs. HAC

Selection Criteria	Traditional Hot Aisle/Cold Aisle (HA/CA)	Panduit® Net-Contain™ Vertical Exhaust Duct (VED)	Panduit® Net-Contain™ Cold Aisle Containment (CAC)	Panduit® Net-Contain™ Hot Aisle Containment (HAC)
Return Airflow Path	Does not require any special provisioning for the return of hot exhaust air.	Requires either a high ceiling with tall chimneys or a drop ceiling for return airflow path.	Similar to HA/CA, does not require any special provisioning for the return of hot exhaust air.	Requires special provisioning for the return of hot exhaust air, with the exception of an application with row level cooling
Water Cooled vs. Refrigeration Based Cooling System	Compatible with refrigeration and chilled water based systems because of the low return air temperatures.	Refrigeration based systems may not be compatible with very high return air temperatures that may be produced.		
Economizers	Compatible	Increased hours of economizer utilization due to high return air temperatures.	Increased hours of economizer utilization due to high return air temperatures.	Increased hours of economizer utilization due to high return air temperatures.
Cooling System Failure Tolerance	Hot aisle air will be quickly drawn to the cold aisle. The average room temperature factors into the time to critical alarms in IT equipment.	Provides large mass of cold air in case of cooling system airflow failure.	Provides relatively small thermal mass in case of cooling system airflow failure.	Provides large mass of cold air in case of cooling system airflow failure.
Room Height	Requires sufficient height for raised floor or overhead supply ducting.	Requires high ceiling for chimney and allowance for return plenum or hot air stratification.	Requires sufficient height for raised floor or overhead supply ducting.	Requires sufficient height for ceiling return plenum or return ducting.
Comfort	The hot aisle is relatively warm due to mixing of cold and hot air.	The entire room is within a few degrees of the supply air temperature (assuming VED on all cabinets).	All areas outside the cold aisle are typically at a very high temperature, which may not be an acceptable working condition.	The entire room is within a few degrees of the supply air temperature. However, hot aisle temperatures may not be acceptable for working conditions.
Retrofitting/Brownfield	Minimal challenges, but limited thermal density.	May be challenging to fit VED into existing overhead pathways (power, structured cable, etc.). Addition of drop ceiling may be required.	Can be built on existing raised floors with minimal changes.	In most cases, it is difficult to install HAC in Brownfield applications, where containment systems are an afterthought.
Fire Suppression	Depending on local codes, fewer sprinkler heads may be needed than for VEDs or CACs.	Depending on local codes, sprinkler heads may be needed in both the hot and cold aisles.	Depending on local codes, both fire detection devices and sprinkler heads might need to penetrate each containment system.	Depending on local codes, sprinkler heads may be needed in both the hot and cold aisles.
Lighting	Regular room lighting system is sufficient.	Chimneys will prevent light from traveling between aisles. Lighting fixtures are likely needed in both the hot and cold aisles.	Containment solutions may block light provided by overhead fixtures. Transparent roof sections or internal light fixtures may be required. Lighting fixtures are likely needed over each aisle.	Containment solutions may block light provided by overhead fixtures and transparent roof sections or internal light fixtures may be required. Lighting fixtures are likely needed over each aisle.



Net-Contain™ Vertical Exhaust Duct (VED)

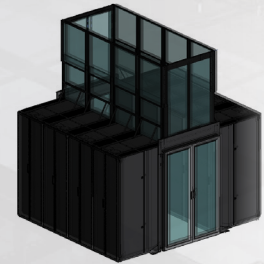

Net-Contain™ Hot Aisle Containment (HAC)

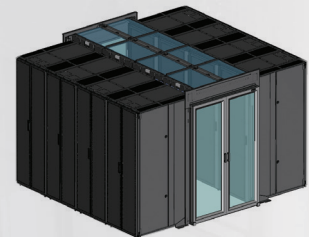

Net-Contain™ Cold Aisle Containment (CAC)

Cabinet Containment Sealing Scenarios

When using a containment solution, it is important that the front, top, rear, and end-of-row areas of Net-Access™ Cabinets are all properly sealed. The following charts show the cabinet seal scenario needed when deploying each of the three different containment solutions.

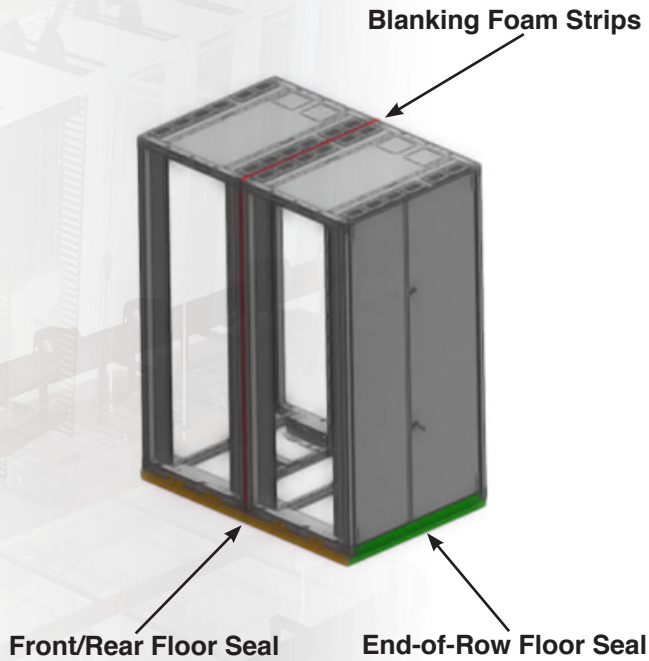

Vertical Exhaust Duct (VED) Seal Application		Middle Cabinet (W or W/O Side Panel)	End of Row
Front and Rear Cabinet to Floor Seal	Server – S-Type	Front and Rear	Front and Rear
	Switch – N-Type	Rear	Rear
End of Row Cabinet Seal	Server or Switch	N/A	Need
Middle of Row Cabinet to Cabinet	Server-Server	Front, Top, Rear	N/A
	Switch-Switch	Top	N/A
	Server-Switch	Front	N/A

Cold Aisle Containment (CAC) Seal Application		Middle Cabinet (W or W/O Side Panel)	End of Row
Front and Rear Cabinet to Floor Seal	Server – S-Type	Front	Front
	Switch – N-Type	N/A	N/A
End of Row Cabinet Seal	Server or Switch	N/A	Need
Middle of Row Cabinet to Cabinet	Server-Server	Front	N/A
	Switch-Switch	Top	N/A
	Server-Switch	Front	N/A

Hot Aisle Containment (HAC) Seal Application		Middle Cabinet (W or W/O Side Panel)	End of Row
Front and Rear Cabinet to Floor Seal	Server – S-Type	Front	Front
	Switch – N-Type	N/A	N/A
End of Row Cabinet Seal	Server or Switch	N/A	Need
Middle of Row Cabinet to Cabinet	Server-Server	Front, Top	N/A
	Switch-Switch	Front, Top	N/A
	Server-Switch	Front, Top	N/A

Net-Direct™ Passive In-Cabinet Ducting

Inlet Ducting

Net-Direct™ Passive In-Cabinet Ducting delivers cooling air directly from the cold aisle into the intake fans of switches with side-to-side cooling airflow. Inlet ducting prevents hot air recirculation within the cabinet and enables reduced inlet temperature for improved performance and cooling efficiency. Inlet ducting is used for containment systems such as VED, CAC, and HAC.

Application: Use for a containment application in Greenfield and Brownfield environments without disrupting existing in-cabinet equipment and cabling.

Benefits:

- Switch Inlet Ducts enable containment strategies:
 - Effectively managing airflow on side-to-side airflow devices
 - Channeling cold air directly into the switch intake
- Switch Inlet Ducts enable reduced energy consumption:
 - Lowering fan speeds on the switch
 - Allowing higher data center supply air temperature
 - Allowing higher chilled water temperature

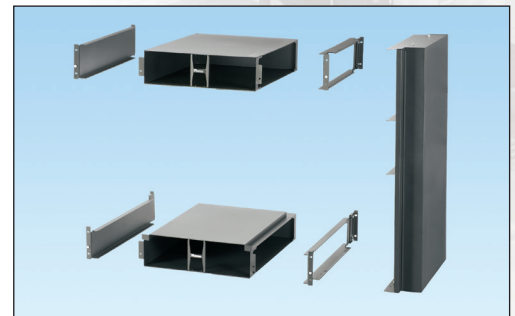

Exhaust Ducting

Net-Direct™ Passive Cabinet Exhaust Ducting routes exhaust air from the side exhaust of the switch into the hot aisle, preventing hot air from mixing with cooling air within the cabinet for improved switch performance and cooling efficiency. Exhaust ducts are used for traditional hot and cold aisle applications. Net-Direct™ Passive Cabinet Inlet and Exhaust Ducting are Cisco certified.

Application: Use for a non-containment application in Greenfield and Brownfield environments without disrupting existing in-cabinet equipment and cabling.

Benefits:

- Channels hot exhaust air directly to the hot aisle away from the cold air inlet of adjacent switches
- Completely passive solution requiring no energy to operate, eliminating a point of failure
- Reduces fan power energy by allowing lower fan speeds, improving switch reliability



Net-Direct™ Passive In-Cabinet Top of Rack

Top of Rack Ducting

Top of Rack (TOR) Inlet Ducts effectively manage airflow when placed either on side-to-side airflow devices or when used to extend the inlet duct to receive incoming cold air. These ducts channel cold air directly into the switch intake and create a front-to-back airflow pattern. They also enable reduced energy consumption by lowering the fan speeds on the switch, allowing higher data center supply air temperatures and higher chilled water temperatures.

Application: Use for both containment and non-containment applications in Greenfield and Brownfield environments without disrupting existing in-cabinet equipment and cabling. Mainly use for one or two RU switches.

Benefits:

- Effectively manages airflow when placed either on side-to-side airflow devices or when used to extend the inlet duct to receive incoming cold air
- Channels cold air directly into the switch intake
- Creates a front-to-back airflow pattern
- Enables reduced energy consumption:
 - Lowers fan speeds on the switch
 - Allows higher data center supply air temperature
 - Allows higher chilled water temperature

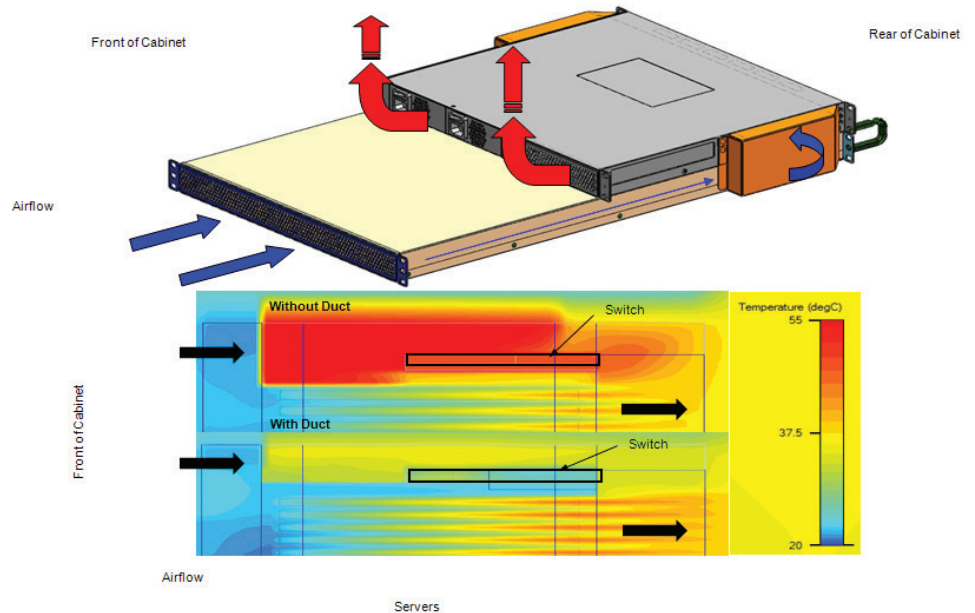
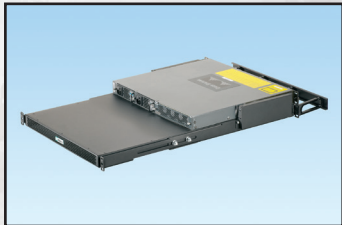
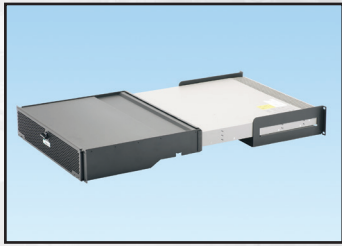

Net-Direct™ Passive In-Cabinet Ducting

Ducting Versus No Ducting

Research conducted in the Panduit thermal laboratory validates that a thermal ducting solution along with containment allows you to prevent recirculation inside the cabinet and increase the temperature per ASHRAE standards. The improved thermal performance enabled by the ducting allows switches to operate at higher cold aisle temperatures. The increase in supply air temperature can improve the efficiency of traditional chiller-based HVAC systems or increase the hours of operation for economizer systems, which decreases the amount of energy required to cool the data center. The Panduit® Net-Direct™ Passive In-Cabinet Ducting System is comprised of thermal management products that provide the optimum thermal performance and energy cost savings.

The following chart illustrates the cost savings achieved when using inlet ducting in the 80° or 90° environment. The recommended ASHRAE data center operating temperature is 80°. The maximum allowable temperature for short time periods is 90°. *When using the recommended 80° temperature, with a ducting solution, the cost savings is over \$124,000. When using the maximum allowable temperature, the cost is over \$54,000.*

Panduit® Net-Contain™ With vs. Without Inlet Ducting

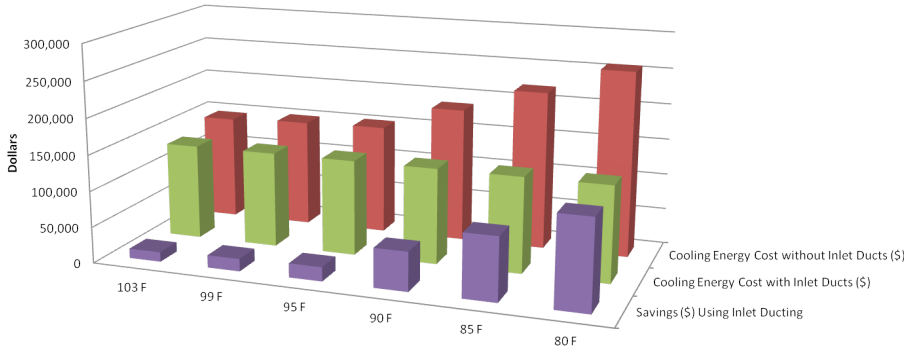

	103 F	99 F	95 F	90 F	85 F	80 F
■ Savings (\$) Using Inlet Ducting	13,409	17,316	19,561	54,044	87,484	124,784
■ Cooling Energy Cost with Inlet Ducts (\$)	132,817	132,817	132,817	132,817	132,817	132,817
■ Cooling Energy Cost without Inlet Ducts (\$)	146,226	150,133	152,378	186,861	220,301	257,601

Room has a total heat load of approximately 1mW; 182 cabinets, 23 housing the 28 side breathing switches; All unused RU spaces in the cabinets are blanked off; all CRAH units run at the same speed.

Thermal Management Accessories

Thermal management accessories prevent the mixing of hot and cold air and increase thermal efficiency by eliminating leakage through cabinet and floor openings, which contribute to energy savings.

Cool Boot® Raised Floor Air Sealing Grommet

The Panduit® Cool Boot® Raised Floor Grommet minimizes bypass air in raised floor applications where power and data cable pass through a cutout into a rack or cabinet. The Cool-Boot® Grommet forces the cold air through perforated tiles in the cold aisle to optimize the cooling efficiency. This assembly can be used in new or retrofit applications.

Application: Used in applications that require cable bundles, such as data and power, to be separated as well as applications that create one cable bundle.

The Cool-Boot® Raised Floor Air Sealing Grommet prevents 58% loss of effectiveness when utilized in a CAC environment. The investment of the RFG8X8Y has a simple payback of 0.2 years when installed in this environment.

Selection Criteria:

- Can be utilized in new or retrofit applications to reduce bypass airflow, improving the cooling of network equipment, and to prevent debris from falling below the raised floor
- Designed for 3" or 5" round openings as well as a variety of rectangular shaped openings
- Suitable to allow multiple cable bundles to pass and allows communication cables to be separated from power cables where both cable types pass through the same opening
- Electrostatic dissipating properties provide a pathway to ground.
- Compatible with Panduit vertical cable managers and openings in the base of Panduit cabinets



Full Length Blanking Shade

The full length blanking shade provides a blanking solution for racks and cabinets that have a large number of consecutive open rack units. When new cabinets are positioned, or when equipment is being serviced, the shade can be deployed to easily and efficiently blank out unused rack units. An impermeable fabric material coiled on a spring roller can be deployed or retracted to accommodate the required open rack units. The blanking shade provides an easy solution to reduce bypass air, thereby decreasing energy costs.

Application: Suitable for a large number of consecutive rack units because it easily adjusts as adjacent equipment is installed or removed. *The full length blanking shade prevents 51% loss of effectiveness when utilized in a CAC environment. The investment of the FLBSIMS product has a simple payback of 0.4 years when installed in this environment.*

Selection Criteria:

- Suitable to blank out 4 RU up to 45 RU in round or cage nut style EIA-compliant cabinet rails
- Variable floating fasteners and locator pins allow for variability in horizontal spacing of vertical mounting rails
- Electrostatic dissipating materials with grounding capabilities reduce the chance of corrupting the network equipment with electrical shock

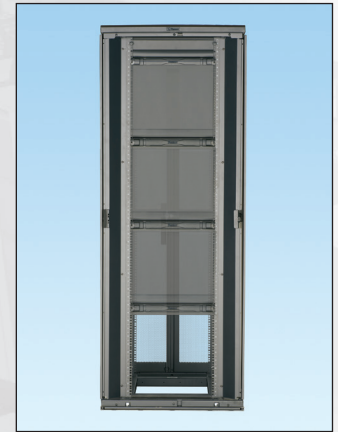

Blanking Foam Strips

Panduit blanking foam strips prevent recirculated or bypass air in cabinets where sealing of air gaps is critical to the function of network equipment. The blanking foam strips are typically installed in CAC, HAC, or VED applications to improve efficiency of these solutions. Panduit blanking foam strips can be stacked, folded, rolled, or manipulated in ways that allow it to seal various size openings that are not typically filled by tool-less blanking panels or other blanking options.

Application: Suitable in preventing recirculated or bypass air in cabinets where sealing of air gaps is critical to the function of the network equipment. Typically installed in a CAC, HAC, or VED application to improve the efficiency of these solutions. *The blanking foam strip product prevents 8% loss of effectiveness when utilized in a CAC environment. The investment of the BFS100X2000 product has a simple payback of 1.0 years when installed in this environment.*

Selection Criteria:

- The 4" x 100" roll of 1/16" thick foam is perforated every 1" in width and every 20" in length to allow for the product to be customized for common applications without the need for scissors or other tools
- Can be stacked, folded, rolled, or manipulated in ways that allow the product to seal various size openings

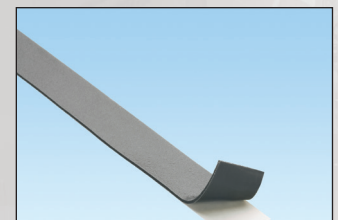
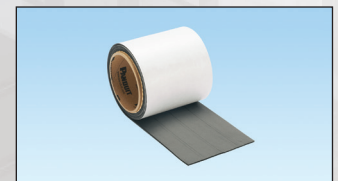

Tool-Less Blanking Panels

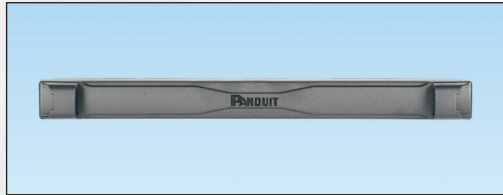
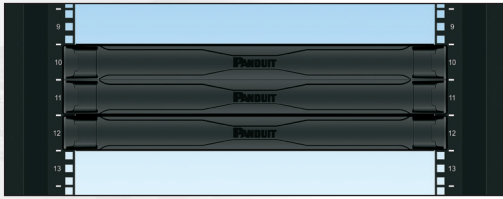

1 RU Panel

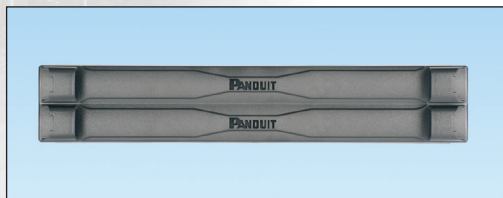

2 RU Panel



1 RU (Pass-through) Panel

The tool-less blanking panels force the cold air to be transferred through the active equipment rather than being transferred directly to the hot aisle. Panduit Tool-less Blanking Panels minimize bypass airflow in racks and cabinets, optimizing cooling efficiency. These blanking panels are available in 1 RU or 2 RU configurations that can be deployed to fill any number of open rack units within the cabinet.

A one rack unit pass-through blanking panel is also available that incorporates sliding pass-through windows with foam that allows power cables to pass from the front of the cabinet to the back of the cabinet, while still maintaining a suitable sealing solution.

Application: Designed to speed installation, and are part of the complete range of cooling accessories available from Panduit to help maximize management and control of the physical infrastructure.

The tool-less blanking panel prevents 39% loss of effectiveness when utilized in a CAC environment. The investment of the TLBP1S-V product has a simple payback of 0.04 years when installed in this environment.

Selection Criteria:

- Designed to fill 1 RU or 2 RU openings in EIA-compliant racks or cabinets
- Non-metallic construction with snap-in features allow for easy installation without the need for installation tools
- A selection of product is available to provide solutions for round or cage nut mounting rails
- Designed to stack easily to minimize the space required for the storage of products not currently being used
- Pass-through blanking panels allow cables to pass from the front to the back of cabinets

Key Advantages and Competitive Analysis

Through airflow bench testing in our thermal laboratory, we have demonstrated and validated that the integral cabinet sealing features of the Panduit® Net-Access™ S-Type VED cabinet reduce air leakage by up to 20% over the competitors' cabinets. The improved sealing has a significant impact on hot air recirculation and IT equipment inlet temperatures, as the VED cabinet IT loads increase from 15 kW to 33 kW¹.

¹Conditions of Experiment: 20 Panduit cabinets with containment compared to two major cabinet competitors with their containment; Electricity @ \$.10/kWh; ASHRAE allowable max inlet air temperature of 90°F used threshold limit; 13°F approach temperature for CRAH; 42°F SWT = 55F Supply Air Temp. (SAT); Chiller SWT range 42°F to 65°F; CRAH SAT 55°F to 78°F; .02 increase in chiller eff. For every 1 degree F increase in chiller set point temperature.

Sealing Proof Point

Example – Panduit® Net-Access™ Cabinet with VED vs. Competition with VED

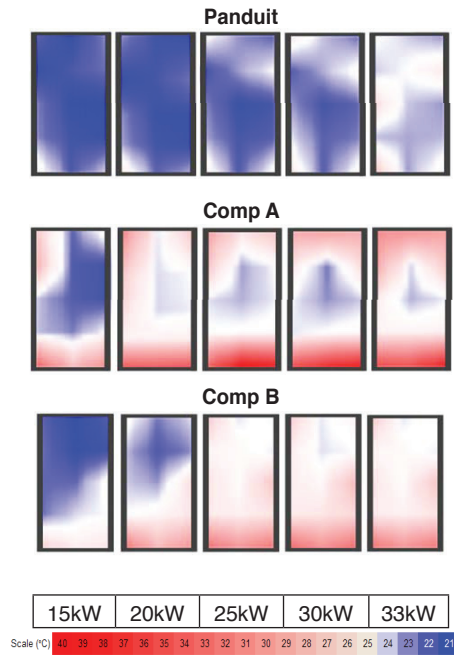

Net-Access™ Cabinet with Net-Contain™ System vs. Competition with Containment

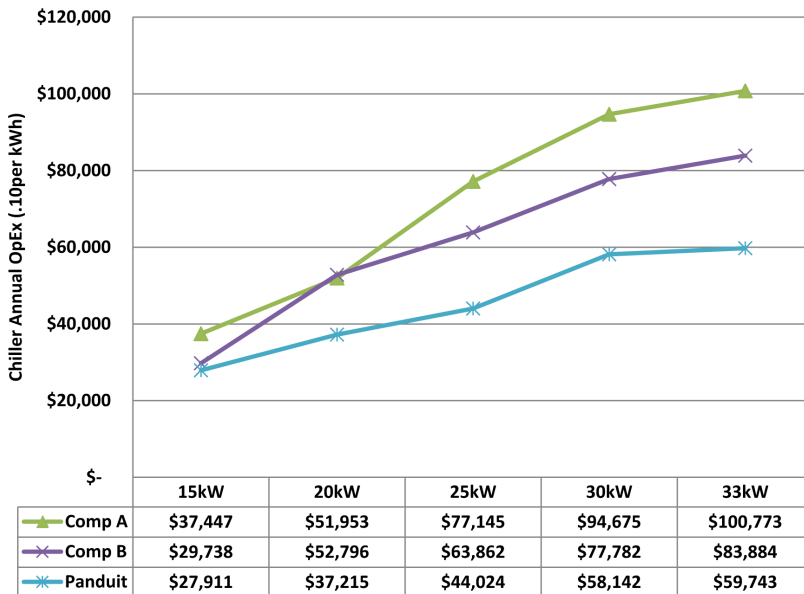

Panduit provides better thermal efficiency with containment compared to two main competitors. The image on the top illustrates the capabilities of the Panduit solution and the image on the bottom illustrates the dollar amount savings of the Panduit solution.

For the 15kW heat load, Panduit® Net-Access™ Cabinets with VED allow a savings of up to \$10,000. For the 33kW head load, Panduit® Net-Access™ Cabinets with VED allow a savings of approximately \$40,000.

Please refer to Panduit White Paper WP-20: Impact of Air Containment Systems for further information about reducing energy consumption in the data center.



Complete Solutions from Panduit

Panduit cabinet and rack systems offer a portfolio of innovative products with modular designs for greater thermal management, with energy efficiency and effective space utilization while managing, showcasing, and protecting equipment.

Panduit Difference

Panduit is committed to delivering a consistently high level of quality and service the world over. With a presence in more than 100 countries, local Panduit sales representatives and technical specialists offer guidance and support that bring value to your business. Our global supply chain, which includes manufacturing, customer service, logistics, and distribution partners, provides prompt response to your inquiries and streamlines delivery to any worldwide destination.

WORLDWIDE SUBSIDIARIES AND SALES OFFICES

Panduit Canada
Markham, Ontario
cs-cdn@panduit.com
Phone: 800.777.3300

Panduit Europe Ltd.
London, UK
cs-emea@panduit.com
Phone: 44.208.601.7200

Panduit Singapore Pte. Ltd.
Republic of Singapore
cs-ap@panduit.com
Phone: 65.6305.7575

Panduit Japan
Tokyo, Japan
cs-japan@panduit.com
Phone: 81.3.3767.7011

Panduit Latin America
Guadalajara, Mexico
cs-la@panduit.com

Phone: 52.33.3777.6000
Panduit Australia Pty. Ltd.
Victoria, Australia
cs-aus@panduit.com
Phone: 61.3.9794.9020

For a copy of
Panduit product warranties,
log on to www.panduit.com/warranty

For more information
Visit us at www.panduit.com

Contact Customer Service by email:
cs@panduit.com
or by phone: 800-777-3300