

All Stainless Steel Transducer/Transmitter Multimedia Compatibility High-Performance Silicon Technology Imperial Model



**New!
Vacuum and
Compound Range
Models**

**0-1 to 0-10,000 psi
0-0.07 to 0-690 bar
100 mV, 0 to 5 V, 0 to 10 V,
and 4 to 20 mA Outputs**

PX309 Series



- ✓ 1, 2 & 5 psi Low Pressure Ranges!
- ✓ All Stainless Steel Construction
- ✓ Gage, Absolute, Compound Gage or Vacuum Pressure
- ✓ Rugged Solid State Design
- ✓ High Stability, Low Drift
- ✓ 0.25% Static Accuracy
- ✓ IP65 Protection Class
- ✓ Stocked for Fast Delivery

We provide a complete range of services—from product inception, through design and prototypes, to manufacturing and testing. Our application engineers work closely with our customers to **customize, design** or create entirely **new products**. Call us—whether you're an OEM, manufacturer, or end user.

PX319-100GV

mini DIN style.



Cable style.

PX309-100GV.



Twist-lock style.

PX329-100GV



PX359-100GV

M12 connector style



All models shown smaller than actual size.



Rugged, General Purpose Transducer



Common Specifications for 100 mV, 0 to 5 Vdc, and 0 to 10 Vdc, 4 to 20 mA Outputs

- ✓ 1, 2 & 5 psi Low Pressure Ranges!
- ✓ All Stainless Steel Construction
- ✓ Gage or Absolute Pressure
- ✓ Rugged Solid State Design
- ✓ High Stability, Low Drift
- ✓ 0.25% Static Accuracy
- ✓ IP 65 Protection Class

Omega's PX309 Series models below 100 psi use a high-accuracy silicon sensor protected by an oil-filled stainless steel diaphragm. Units 100 psi and above use silicon strain gages molecularly bonded to the stainless steel diaphragm.

Common Specifications

Ranges: -15 to 50 psig, 0 to 1000 psia, 100 to 10,000 psig

Accuracy (Combined Linearity, Hysteresis and Repeatability): ±0.25% BSL, max

Minimum Resistance Between Pressure Transducer Body and Any Wire: 1M Ω @ 25 Vdc

Calibration: In vertical direction with fitting down, Compound range units are calibrated from Vac to FSO

Pressure Cycles: 10 million, minimum

Pressure Overload: -15 to 50 psig and 0 to 1000 psia: 3 times rated pressure or 20 psi whichever is greater, 100 to 10,000 psig: 2 times rated pressure

Burst Pressure: -15 to 50 psig and 0 to 1000 psia: 4 times rated pressure or 25 psi whichever is greater, 100 to 10,000 psig: 5 times rated pressure

Long Term Stability (1 Year): ±0.25% of FS, typical

Operating Temperature: -40 to 85°C (-40 to 185°F)

Pressure Port: ¼-18 MNPT

Pressure Port Material: -15 to 50 psig and 0 to 1000 psia: 316 SS, 100 to 10,000 psig: SS 316 or 17-4

(0 to 500 PSI may contain HNBR O-ring in wetted pressure port assembly)

Bandwidth: DC to 1 kHz (typical)

CE Compliant

Shock: 50 g, 11 ms half-sine

Vibration: ±20 g

Response Time: <1 millisecond

Weight: PX309/PX319/PX329/PX359: <90 grams

IP Rating: IP65

RoHS: Compliant

Order a snubber to protect your pressure transducer!



PS-4G, shown actual size.
Snubbers protect sensors from fluid hammers/spikes.

mV Output Wiring			
Wiring	Cable	M12 and mini DIN	Twist-Lock
Excitation (+)	Red	Pin 1	Pin A
Output (+)	White	Pin 3	Pin C
Output (-)	Green	Pin 4	Pin D
Excitation (-)	Black	Pin 2	Pin B
Spare	—	—	Pin E
Vent	—	—	Pin F

5 and 10 Vdc Output Wiring			
Wiring	Cable	M12 and mini DIN	Twist-Lock
Excitation (+)	Red	Pin 1	Pin A
Excitation (-)	Black	Pin 2	Pin B
Output (+)	White	Pin 3	Pin C
N/C†	—	Pin 4	Pin D
Spare	—	—	Pin E
Vent	—	—	Pin F

mA Output Wiring			
Wiring	Cable	M12 and mini DIN	Twist-Lock
Supply (+)	Red	Pin 1	Pin A
Supply (-)	Black	Pin 2	Pin B
N/C†	—	Pin 3	Pin C
N/C†	—	Pin 4	Pin D
Spare	—	—	Pin E
Vent	—	—	Pin F

† N/C: Do not connect any wires to this pin.

Dimensions: mm (inch)
ø = diameter

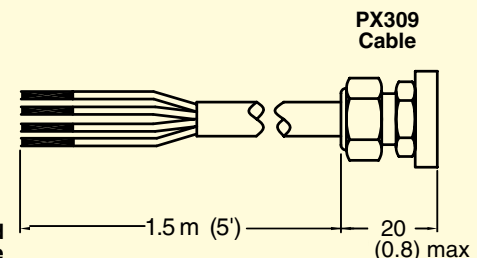
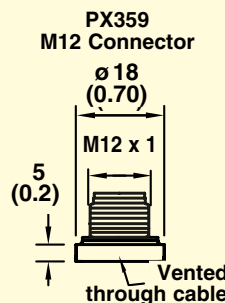
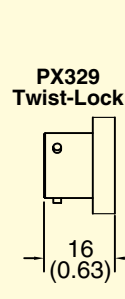
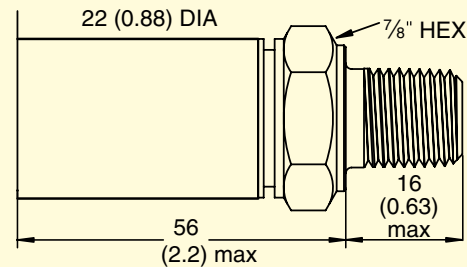
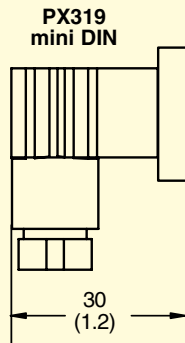

How to Order PX309 Series with 100 mV Outputs



100 mV Output
0-1 to 0-10,000 psi
0-70 mbar to 0-690 bar

PX309 Series



Standard

100 mV Output Specifications (In Addition to Common Specifications on page 2)

Setting Accuracy Zero and Span:
±2% FS (±4% FS for 1 and 2 psi)

Supply Voltage:

-15 to 50 psig and 0 to 1000 psia: 10 Vdc, 100 to 10,000 psig: 5 Vdc typical

100 mV Outputs		
Range	Output	Excitation*
200psia	66.7 mV	10 Vdc
1 psig	20 mV	10 Vdc
2 psig	40 mV	10 Vdc
5 to 50 psig	100 mV	10 Vdc
100 to 10,000 psig	100 mV	5 Vdc
0 to -15 psig	0 to 100 mV	10 Vdc
-15 to 0 to +15 psig	-100 to 0 to +100 mV	10 Vdc
-15 to 30/50 psig	0 to 100 mV	10 Vdc
-15 to 100/150 psig	0 to 100 mV	5 Vdc

* Ratiometric Excitation Range: 2 to 10 or 1 to 5 Vdc

Input Impedance: 3k Ohms Min
Output Impedance: 3k Ohms Min

Zero Shift:

-15 to 50 psig and 0 to 1000 psia: ±0.03%/°C (0 to 5 psig/psia is ±0.06%/°C, 0 to 2 psig is ±0.08%/°C, 0 to 1 psig is ±0.1%/°C). 100 to 10,000 psig: ±2% over compensated range ref 25°C

Span Shift:

-15 to 50 psig and 0 to 1000 psia: ±0.03%/°C (0 to 5 psig/psia is ±0.04%/°C, 0 to 2 psig is ±0.05%/°C, 0 to 1 psig is ±0.06%/°C). 100 to 10,000 psig: ±2% over compensated range ref 25°C

Compensated Temperature:

-15 to 50 psig and 0 to 1000 psia: 0 to 50°C, 100 to 10,000 psig: 0 to 55°C

Metric Versions of PX309 also available from Omega. Please see PXM309 series.

PX319-050GV, mini DIN connector included, shown smaller than actual size.



mini DIN style.

To Order

Range		1.5 m Cable Connection	mini DIN Connection	Twist-Lock Connection	M12 Connection
psi	bar				
Absolute Pressure					
0 to 5	0 to 0.34	PX309-005AV	PX319-005AV	PX329-005AV	PX359-005AV
0 to 15	0 to 1	PX309-015AV	PX319-015AV	PX329-015AV	PX359-015AV
0 to 30	0 to 2.1	PX309-030AV	PX319-030AV	PX329-030AV	PX359-030AV
0 to 50	0 to 3.4	PX309-050AV	PX319-050AV	PX329-050AV	PX359-050AV
0 to 100	0 to 6.9	PX309-100AV	PX319-100AV	PX329-100AV	PX359-100AV
0 to 200	0 to 14	PX309-200AV	PX319-200AV	PX329-200AV	PX359-200AV
0 to 300	0 to 21	PX309-300AV	PX319-300AV	PX329-300AV	PX359-300AV
0 to 500	0 to 34	PX309-500AV	PX319-500AV	PX329-500AV	PX359-500AV
0 to 1000	0 to 69	PX309-1KAV	PX319-1KAV	PX329-1KAV	PX359-1KAV
Gage Pressure					
0 to 1	0 to 0.07	PX309-001GV	PX319-001GV	PX329-001GV	PX359-001GV
0 to 2	0 to 0.14	PX309-002GV	PX319-002GV	PX329-002GV	PX359-002GV
0 to 5	0 to 0.34	PX309-005GV	PX319-005GV	PX329-005GV	PX359-005GV
0 to 15	0 to 1	PX309-015GV	PX319-015GV	PX329-015GV	PX359-015GV
0 to 30	0 to 2.1	PX309-030GV	PX319-030GV	PX329-030GV	PX359-030GV
0 to 50	0 to 3.4	PX309-050GV	PX319-050GV	PX329-050GV	PX359-050GV
0 to 100	0 to 6.9	PX309-100GV	PX319-100GV	PX329-100GV	PX359-100GV
0 to 150	0 to 10	PX309-150GV	PX319-150GV	PX329-150GV	PX359-150GV
0 to 200	0 to 14	PX309-200GV	PX319-200GV	PX329-200GV	PX359-200GV
0 to 300	0 to 21	PX309-300GV	PX319-300GV	PX329-300GV	PX359-300GV
0 to 500	0 to 34	PX309-500GV	PX319-500GV	PX329-500GV	PX359-500GV
0 to 1000	0 to 69	PX309-1KGV	PX319-1KGV	PX329-1KGV	PX359-1KGV
0 to 2000	0 to 138	PX309-2KGV	PX319-2KGV	PX329-2KGV	PX359-2KGV
0 to 3000	0 to 207	PX309-3KGV	PX319-3KGV	PX329-3KGV	PX359-3KGV
0 to 5000	0 to 345	PX309-5KGV	PX319-5KGV	PX329-5KGV	PX359-5KGV
0 to 7500	0 to 517	PX309-7.5KGV	PX319-7.5KGV	PX329-7.5KGV	PX359-7.5KGV
0 to 10,000	0 to 690	PX309-10KGV	PX319-10KGV	PX329-10KGV	PX359-10KGV
Vacuum and Compound Gage Pressure					
-0 to -15	—	PX309-015VV	PX319-015VV	PX329-015VV	PX359-015VV
-15 to 0 to +15	—	PX309-015CGV	PX319-015CGV	PX329-015CGV	PX359-015CGV
-15 to 30	-1.03 to 2.1	PX309-V030GV	PX319-V030GV	PX329-V030GV	PX359-V030GV
-15 to 50	-1.03 to 3.4	PX309-V050GV	PX319-V050GV	PX329-V050GV	PX359-V050GV
-15 to 100	-1.03 to 6.9	PX309-V100GV	PX319-V100GV	PX329-V100GV	PX359-V100GV
-15 to 150	-1.03 to 10.3	PX309-V150GV	PX319-V150GV	PX329-V150GV	PX359-V150GV

Comes complete with 5-point NIST-traceable calibration.

Notes: 1. Units 100 psig and above may be subjected to vacuum on the pressure port without damage. 2. For alternative performance specifications to suit your application, contact Engineering.

Ordering Examples: PX309-100GV, 100 psi gage pressure transducer with 100 mV output at 5 Vdc excitation and 1.5 m cable termination. PX319-015AV, 15 psi absolute pressure transducer with 100 mV output @ 10 Vdc excitation and mini DIN termination.

PX329-3KGV, 3000 psi gage pressure transducer with 100 mV output @ 5 Vdc excitation and twist-lock 6 pin connector termination. Mating connector sold separately, order PT06V-10-6S-R, Consult Sales for OEM pricing.

How to Order PX309 Series with 0 to 5 Vdc Output

0 to 5 Vdc Output
0-1 to 0-10,000 psi
0-70 mbar to 0-690 bar



PX329-015G5V
shown smaller than
actual size.



Twist-lock
style.

PX309 Series



Standard

5V Output Specifications

(In Addition to Common
Specifications on page 2)

Total Error Band (Includes
Linearity, Hysteresis,
Repeatability, Thermal
Hysteresis and Thermal Errors,
Not Including Zero and Span
Setting Accuracy): $\pm 1.0\%$
(5 psig/psia is $\pm 1.5\%$, 2 psig
is 3.0% and 1 psig is 4.5%)

Supply Voltage: 9 to 30 Vdc,
Supply Current < 10 mA

0 to 5 Vdc Outputs		
Range	Output	Excitation*
5 to 1000 psia	0 to 5 Vdc	9 to 30 Vdc
1 to 10,000 psig	0 to 5 Vdc	9 to 30 Vdc
-15 to 30/50/100/ 150 psig	0 to 5 Vdc	9 to 30 Vdc
0 to -15 psig	0 to 5 Vdc	9 to 30 Vdc
-15 to 0 to +15 psig	-5 to 0 to +5 Vdc	9 to 30 Vdc

* Supply Current < 10 mA

Compensated Temperature:

-20 to 85°C (≤ 5 psig/psia
is 0 to 50°C)

To Order

Range		1.5 m Cable Connection	mini DIN Connection	Twist-Lock Connection	M12 Connection
psi	bar				
Absolute Pressure					
0 to 5	0 to 0.34	PX309-005A5V	PX319-005A5V	PX329-005A5V	PX359-005A5V
0 to 15	0 to 1	PX309-015A5V	PX319-015A5V	PX329-015A5V	PX359-015A5V
0 to 30	0 to 2.1	PX309-030A5V	PX319-030A5V	PX329-030A5V	PX359-030A5V
0 to 50	0 to 3.4	PX309-050A5V	PX319-050A5V	PX329-050A5V	PX359-050A5V
0 to 100	0 to 6.9	PX309-100A5V	PX319-100A5V	PX329-100A5V	PX359-100A5V
0 to 200	0 to 14	PX309-200A5V	PX319-200A5V	PX329-200A5V	PX359-200A5V
0 to 300	0 to 21	PX309-300A5V	PX319-300A5V	PX329-300A5V	PX359-300A5V
0 to 500	0 to 34	PX309-500A5V	PX319-500A5V	PX329-500A5V	PX359-500A5V
0 to 1000	0 to 69	PX309-1KA5V	PX319-1KA5V	PX329-1KA5V	PX359-1KA5V
Gage Pressure					
0 to 1	0 to 0.07	PX309-001G5V	PX319-001G5V	PX329-001G5V	PX359-001G5V
0 to 2	0 to 0.14	PX309-002G5V	PX319-002G5V	PX329-002G5V	PX359-002G5V
0 to 5	0 to 0.34	PX309-005G5V	PX319-005G5V	PX329-005G5V	PX359-005G5V
0 to 15	0 to 1	PX309-015G5V	PX319-015G5V	PX329-015G5V	PX359-015G5V
0 to 30	0 to 2.1	PX309-030G5V	PX319-030G5V	PX329-030G5V	PX359-030G5V
0 to 50	0 to 3.4	PX309-050G5V	PX319-050G5V	PX329-050G5V	PX359-050G5V
0 to 100	0 to 6.9	PX309-100G5V	PX319-100G5V	PX329-100G5V	PX359-100G5V
0 to 150	0 to 10	PX309-150G5V	PX319-150G5V	PX329-150G5V	PX359-150G5V
0 to 200	0 to 14	PX309-200G5V	PX319-200G5V	PX329-200G5V	PX359-200G5V
0 to 300	0 to 21	PX309-300G5V	PX319-300G5V	PX329-300G5V	PX359-300G5V
0 to 500	0 to 34	PX309-500G5V	PX319-500G5V	PX329-500G5V	PX359-500G5V
0 to 1000	0 to 69	PX309-1KG5V	PX319-1KG5V	PX329-1KG5V	PX359-1KG5V
0 to 2000	0 to 138	PX309-2KG5V	PX319-2KG5V	PX329-2KG5V	PX359-2KG5V
0 to 3000	0 to 207	PX309-3KG5V	PX319-3KG5V	PX329-3KG5V	PX359-3KG5V
0 to 5000	0 to 345	PX309-5KG5V	PX319-5KG5V	PX329-5KG5V	PX359-5KG5V
0 to 7500	0 to 517	PX309-7.5KG5V	PX319-7.5KG5V	PX329-7.5KG5V	PX359-7.5KG5V
0 to 10,000	0 to 690	PX309-10KG5V	PX319-10KG5V	PX329-10KG5V	PX359-10KG5V
Vacuum and Compound Gage Pressure					
0 to -15	—	PX309-015V5V	PX319-015V5V	PX329-015V5V	PX359-015V5V
-15 to 0 to +15	—	PX309-015CG5V	PX319-015CG5V	PX329-015CG5V	PX359-015CG5V
-15 to 30	-1.03 to 2.1	PX309-V030G5V	PX319-V030G5V	PX329-V030G5V	PX359-V030G5V
-15 to 50	-1.03 to 3.4	PX309-V050G5V	PX319-V050G5V	PX329-V050G5V	PX359-V050G5V
-15 to 100	-1.03 to 6.9	PX309-V100G5V	PX319-V100G5V	PX329-V100G5V	PX359-V100G5V
-15 to 150	-1.03 to 10.3	PX309-V150G5V	PX319-V150G5V	PX329-V150G5V	PX359-V150G5V

Comes complete with 5-point NIST-traceable calibration.

*Notes: 1. Units 100 psig and above may be subjected to vacuum on the pressure port without damage.
2. For alternative performance specifications to suit your application, contact Engineering.

Ordering Examples: PX309-100G5V, 100 psi gage pressure transducer with 0 to 5 Vdc output and 1.5 m cable termination.

PX319-015A5V, 15 psi absolute pressure transducer with 0 to 5 Vdc output and mini DIN termination.

PX329-3KG5V, 3000 psi gage pressure transducer with 0 to 5 Vdc output and twist-lock 6 pin connector termination. Mating connector sold separately; order PT06V-10-6S-R. Consult Sales for OEM pricing.

Metric Versions of PX309
also available from Omega.
Please see PXM309 series.

How to Order PX309 Series with 0 to 10 Vdc Output

0 to 10 Vdc Output
0-1 to 0-10,000 psi
0-70 mbar to 0-690 bar



PX329-015G10V
shown smaller than
actual size.

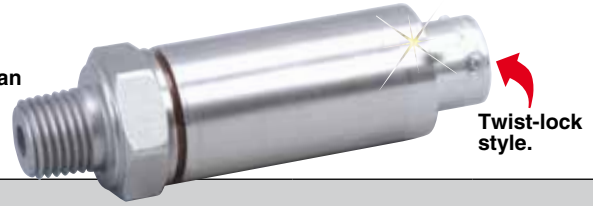

Twist-lock
style.

PX309 Series



Standard

10V Output Specifications

(In Addition to Common
Specifications on page 2)

**Total Error Band (Includes
Linearity, Hysteresis,
Repeatability, Thermal
Hysteresis and Thermal Errors,
Not Including Zero and Span
Setting Accuracy):** ±1.0%
(5 psig/psia is ±1.5%, 2 psig
is 3.0% and 1 psig is 4.5%)

Supply Voltage: 9 to 30 Vdc,
Supply Current < 10 mA

0 to 10 Vdc Outputs		
Range	Output	Excitation*
5 to 1000 psia	0 to 10 Vdc	9 to 30 Vdc
1 to 10,000 psig	0 to 10 Vdc	9 to 30 Vdc
-15 to 30/50/100/ 150 psig	0 to 10 Vdc	9 to 30 Vdc
0 to -15 psig	0 to 10 Vdc	9 to 30 Vdc
-15 to 0 to +15 psig	0 to 5 to +10 Vdc	9 to 30 Vdc

* Supply Current < 10 mA

Compensated Temperature:

-20 to 85°C (≤ 5 psig/psia
is 0 to 50°C)

To Order

Range		1.5 m Cable Connection	mini DIN Connection	Twist-Lock Connection	M12 Connection
psi	bar				
Absolute Pressure					
0 to 5	0 to 0.34	PX309-005A10V	PX319-005A10V	PX329-005A10V	PX359-005A10V
0 to 15	0 to 1	PX309-015A10V	PX319-015A10V	PX329-015A10V	PX359-015A10V
0 to 30	0 to 2.1	PX309-030A10V	PX319-030A10V	PX329-030A10V	PX359-030A10V
0 to 50	0 to 3.4	PX309-050A10V	PX319-050A10V	PX329-050A10V	PX359-050A10V
0 to 100	0 to 6.9	PX309-100A10V	PX319-100A10V	PX329-100A10V	PX359-100A10V
0 to 200	0 to 14	PX309-200A10V	PX319-200A10V	PX329-200A10V	PX359-200A10V
0 to 300	0 to 21	PX309-300A10V	PX319-300A10V	PX329-300A10V	PX359-300A10V
0 to 500	0 to 34	PX309-500A10V	PX319-500A10V	PX329-500A10V	PX359-500A10V
0 to 1000	0 to 69	PX309-1KA10V	PX319-1KA10V	PX329-1KA10V	PX359-1KA10V
Gage Pressure					
0 to 1	0 to 0.07	PX309-001G10V	PX319-001G10V	PX329-001G10V	PX359-001G10V
0 to 2	0 to 0.14	PX309-002G10V	PX319-002G10V	PX329-002G10V	PX359-002G10V
0 to 5	0 to 0.34	PX309-005G10V	PX319-005G10V	PX329-005G10V	PX359-005G10V
0 to 15	0 to 1	PX309-015G10V	PX319-015G10V	PX329-015G10V	PX359-015G10V
0 to 30	0 to 2.1	PX309-030G10V	PX319-030G10V	PX329-030G10V	PX359-030G10V
0 to 50	0 to 3.4	PX309-050G10V	PX319-050G10V	PX329-050G10V	PX359-050G10V
0 to 100	0 to 6.9	PX309-100G10V	PX319-100G10V	PX329-100G10V	PX359-100G10V
0 to 150	0 to 10	PX309-150G10V	PX319-150G10V	PX329-150G10V	PX359-150G10V
0 to 200	0 to 14	PX309-200G10V	PX319-200G10V	PX329-200G10V	PX359-200G10V
0 to 300	0 to 21	PX309-300G10V	PX319-300G10V	PX329-300G10V	PX359-300G10V
0 to 500	0 to 34	PX309-500G10V	PX319-500G10V	PX329-500G10V	PX359-500G10V
0 to 1000	0 to 69	PX309-1KG10V	PX319-1KG10V	PX329-1KG10V	PX359-1KG10V
0 to 2000	0 to 138	PX309-2KG10V	PX319-2KG10V	PX329-2KG10V	PX359-2KG10V
0 to 3000	0 to 207	PX309-3KG10V	PX319-3KG10V	PX329-3KG10V	PX359-3KG10V
0 to 5000	0 to 345	PX309-5KG10V	PX319-5KG10V	PX329-5KG10V	PX359-5KG10V
0 to 7500	0 to 517	PX309-7.5KG10V	PX319-7.5KG10V	PX329-7.5KG10V	PX359-7.5KG10V
0 to 10,000	0 to 690	PX309-10KG10V	PX319-10KG10V	PX329-10KG10V	PX359-10KG10V
Vacuum and Compound Gage Pressure					
0 to -15	—	PX309-015V10V	PX319-015V10V	PX329-015V10V	PX359-015V10V
-15 to 0 to +15	—	PX309-015CG10V	PX319-015CG10V	PX329-015CG10V	PX359-015CG10V
-15 to 30	-1.03 to 2.1	PX309-V030G10V	PX319-V030G10V	PX329-V030G10V	PX359-V030G10V
-15 to 50	-1.03 to 3.4	PX309-V050G10V	PX319-V050G10V	PX329-V050G10V	PX359-V050G10V
-15 to 100	-1.03 to 6.9	PX309-V100G10V	PX319-V100G10V	PX329-V100G10V	PX359-V100G10V
-15 to 150	-1.03 to 10.3	PX309-V150G10V	PX319-V150G10V	PX329-V150G10V	PX359-V150G10V

Comes complete with 5-point NIST-traceable calibration.

*Notes: 1. Units 100 psig and above may be subjected to vacuum on the pressure port without damage.
2. For alternative performance specifications to suit your application, contact Engineering.

Ordering Examples: PX309-100G10V, 100 psi gage pressure transducer with 0 to 10 Vdc output and 1.5 m cable termination.

PX319-015A10V, 15 psi absolute pressure transducer with 0 to 10 Vdc output and mini DIN termination.

PX329-3KG10V, 3000 psi gage pressure transducer with 0 to 10 Vdc output and twist-lock 6 pin connector termination. Mating connector sold separately; order PT06V-10-6S-R. Consult Sales for OEM pricing.

Metric Versions of PX309
also available from Omega.
Please see PXM309 series.

How to Order PX309 Series with 4 to 20 mA Output



4 to 20 mA Output
0-1 to 0-10,000 psi
0-70 mbar to 0-690 bar

PX309-030GI
shown smaller than
actual size.



PX309 Series



Standard

4 to 20 mA Output Specifications

(In Addition to Common Specifications on page 2)

Total Error Band (Includes Linearity, Hysteresis, Repeatability, Thermal Hysteresis and Thermal Errors, Not Including Zero and Span Setting Accuracy):
±1.0% (5 psig/psia is ±1.5%, 2 psig is 3.0% and 1 psig is 4.5%)
Supply Voltage: 9 to 30 Vdc

4 to 20 mA Outputs		
Range	Output	Excitation
All models (psia, psig)	4 to 20 mA	9 to 30 Vdc
-15 to 0 to +15 psig	4 to 12 to 20 mA	9 to 30 Vdc

Compensated Temperature:
-20 to 85°C (≤ 5 psig/psia is 0 to 50°C)

Reverse Polarity Protected
Over Voltage Protection

Metric Versions of PX309 also available from Omega. Please see PXM309 series.

To Order

Range		1.5 m Cable Connection	mini DIN Connection	Twist-Lock Connection	M12 Connection
psi	bar				
Absolute Pressure					
0 to 5	0 to 0.34	PX309-005AI	PX319-005AI	PX329-005AI	PX359-005AI
0 to 15	0 to 1	PX309-015AI	PX319-015AI	PX329-015AI	PX359-015AI
0 to 30	0 to 2.1	PX309-030AI	PX319-030AI	PX329-030AI	PX359-030AI
0 to 50	0 to 3.4	PX309-050AI	PX319-050AI	PX329-050AI	PX359-050AI
0 to 100	0 to 6.9	PX309-100AI	PX319-100AI	PX329-100AI	PX359-100AI
0 to 200	0 to 14	PX309-200AI	PX319-200AI	PX329-200AI	PX359-200AI
0 to 300	0 to 21	PX309-300AI	PX319-300AI	PX329-300AI	PX359-300AI
0 to 500	0 to 34	PX309-500AI	PX319-500AI	PX329-500AI	PX359-500AI
0 to 1000	0 to 69	PX309-1KAI	PX319-1KAI	PX329-1KAI	PX359-1KAI
Gage Pressure					
0 to 1	0 to 0.07	PX309-001GI	PX319-001GI	PX329-001GI	PX359-001GI
0 to 2	0 to 0.14	PX309-002GI	PX319-002GI	PX329-002GI	PX359-002GI
0 to 5	0 to 0.34	PX309-005GI	PX319-005GI	PX329-005GI	PX359-005GI
0 to 15	0 to 1	PX309-015GI	PX319-015GI	PX329-015GI	PX359-015GI
0 to 30	0 to 2.1	PX309-030GI	PX319-030GI	PX329-030GI	PX359-030GI
0 to 50	0 to 3.4	PX309-050GI	PX319-050GI	PX329-050GI	PX359-050GI
0 to 100	0 to 6.9	PX309-100GI	PX319-100GI	PX329-100GI	PX359-100GI
0 to 150	0 to 10	PX309-150GI	PX319-150GI	PX329-150GI	PX359-150GI
0 to 200	0 to 14	PX309-200GI	PX319-200GI	PX329-200GI	PX359-200GI
0 to 300	0 to 21	PX309-300GI	PX319-300GI	PX329-300GI	PX359-300GI
0 to 500	0 to 34	PX309-500GI	PX319-500GI	PX329-500GI	PX359-500GI
0 to 1000	0 to 69	PX309-1KGI	PX319-1KGI	PX329-1KGI	PX359-1KGI
0 to 2000	0 to 138	PX309-2KGI	PX319-2KGI	PX329-2KGI	PX359-2KGI
0 to 3000	0 to 207	PX309-3KGI	PX319-3KGI	PX329-3KGI	PX359-3KGI
0 to 5000	0 to 345	PX309-5KGI	PX319-5KGI	PX329-5KGI	PX359-5KGI
0 to 7500	0 to 517	PX309-7.5KGI	PX319-7.5KGI	PX329-7.5KGI	PX359-7.5KGI
0 to 10,000	0 to 690	PX309-10KGI	PX319-10KGI	PX329-10KGI	PX359-10KGI
Vacuum and Compound Gage Pressure					
0 to -15	—	PX309-015VI	PX319-015VI	PX329-015VI	PX359-015VI
-15 to 0 to +15	—	PX309-015CGI	PX319-015CGI	PX329-015CGI	PX359-015CGI
-15 to 30	-1.03 to 2.1	PX309-V030GI	PX319-V030GI	PX329-V030GI	PX359-V030GI
-15 to 50	-1.03 to 3.4	PX309-V050GI	PX319-V050GI	PX329-V050GI	PX359-V050GI
-15 to 100	-1.03 to 6.9	PX309-V100GI	PX319-V100GI	PX329-V100GI	PX359-V100GI
-15 to 150	-1.03 to 10.3	PX309-V150GI	PX319-V150GI	PX329-V150GI	PX359-V150GI

Comes complete with 5-point NIST-traceable calibration.

Notes: 1. Units 100 psig and above may be subjected to vacuum on the pressure port without damage. 2. For alternative performance specifications to suit your application, contact Engineering.

Ordering Examples: **PX309-100GI**, 100 psi gage pressure transducer with 4 to 20 mA output and 1.5 m cable termination. **PX319-015AI**, 15 psi absolute pressure transducer with 4 to 20 mA output and mini DIN termination. **PX329-3KGI**, 3000 psi gage pressure transducer with 4 to 20 mA output and twist-lock 6 pin connector termination. Mating connector sold separately; order **PT06V-10-6S-R**. Consult Sales for OEM pricing.

PX309 Series Accessories



DP8PT, shown smaller than actual size.

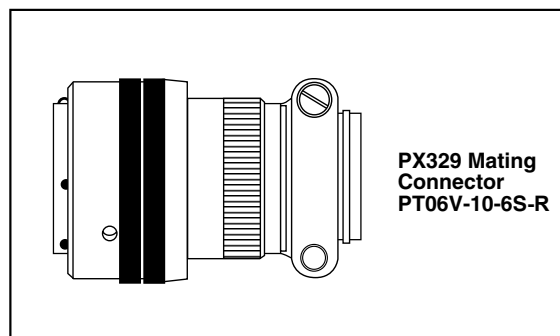
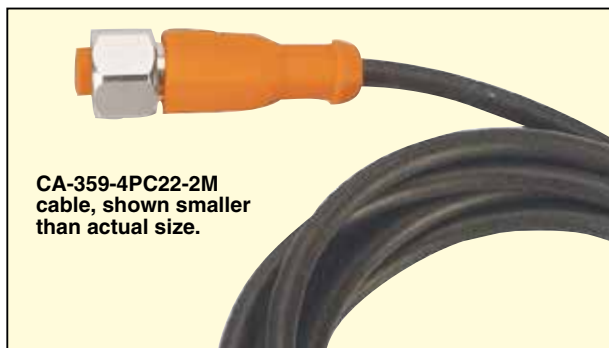

Accessories

Model No.	Description
CAL-3	Recalibration with 5 point NIST traceable documentation
PT06V-10-6S-R*	Vented mate connector for PX329
PT06F10-6S-R*	Sealed mate for PX329
CA-329-4PC24-005	4-conductor mating twist-lock 6 pin connector with 1.5 m (5') cable for PX329
CX5302	Extra mini DIN connector for PX319
CA-359-4PC22-2M	2 m (6') vented cable with M12 connector for PX359 for gage ranges ≤ 500 psi
CA-359-4PC22-5M	5 m (16') vented cable with M12 connector for PX359 for gage ranges ≤ 500 psi
M12C-PVC-4-S-F-5	5 m (16') PVC cable, straight 4-pin M12 female connector one end, flying leads one end, for all PX359 absolute ranges and gage ranges > 500 psi
DP8PT*	4-digit meter for both mV/V and amplified PX3*9 models
DP25B-S*	4-digit strain meter for mV/V PX3*9 models
DP25B-E*	4-digit process meter for amplified PX3*9 models

* See the Installation Notes for cable assemblies.

Note: Complete meter specifications can be found at Omega.



On the PX3*9 Series 0 to 5 Vdc output, do not short the Output(+) to Excitation(+) as permanent damage to the electronics will occur.

PX319-100GV



PX309-100GV.



All models shown smaller than actual size.

PX329-100GV



PX359-100GV



Installation Notes

PX309 Series

All PX309 (gage and absolute) use a vented cable. Gage PX309 sensors up to 500 PSIG must be terminated in a clean dry area that is open to atmosphere for correct operation. All other sensors (> 500 psig and all psia ranges) must be terminated in a dry area but do not need to be vented to atmosphere. These cables should be sealed (e.g. RTV) to protect the sensor from moisture getting in to the sensor through the cable.

PX319 Series

All PX319 are vented through a hole in the connector and through the mating connector. A vented cable must be used for low pressure gage sensors up to 500 PSIG and must be terminated in a clean dry area that is open to atmosphere for correct operation. The gasket for the DIN mating connector has a special stiffener (included) between the mating surfaces and is used to maintain the IP65 rating (Spare Gaskets are Part number P002612). Search cable assembly CA-319 with a "WP" on the end for gage pressure under 500 psi. All other PX319 sensors can use standard cable without the "WP" but must be terminated in a dry location or sealed to prevent water from getting into the cable/sensor.

PX329 Series

All PX329 are vented through Pin F of the twist-lock connector. Gage PX329 up to 500 PSIG must be vented for correct operation and must use the connector PT06V-10-6S-R which has no socket on pin F. Cables for these sensors must use a vented cable, be sealed at the back of the mating connector and be terminated in a dry clean area open to the atmosphere. Search cable assembly CA-329 with "WP" for gage pressure under 500 psi. All other PX329 can use the standard PT06F10-6S-R connector or cables (See cable assembly CA-329 without "WP" ending).

PX359 Series

All PX359 are vented through a hole in the connector. Gage PX359 up to 500 psig suggested vented for correct operation and must use either the CA-359-4PC22-2M or CA-359-4PC22-5M or similar cable. They also must be terminated in a clean dry area open to the atmosphere. All other PX359 can use a standard M12 mating cable like the M12C-PVC-4-S-F-5.