

1 YEAR
WARRANTY



Ω OMEGA™ **User's Guide**

***Shop online at
omega.com***

e-mail: info@omega.com
***For latest product manuals:
www.omegamanual.info***

FMA-1600A Series Mass Flow Meters



omega.com info@omega.com

Servicing North America:

**U.S.A.
Headquarters:**

Omega Engineering, Inc.
800 Connecticut Ave. Suite 5N01, Norwalk, CT 06854
Toll-Free: 1-800-826-6342 (USA & Canada only)
Customer Service: 1-800-622-2378 (USA & Canada only)
Engineering Service: 1-800-872-9436 (USA & Canada only)
Tel: (203) 359-1660 Fax: (203) 359-7700
e-mail: info@omega.com

For Other Locations Visit omega.com/worldwide

Introduction

Your flow meter has a variety of innovative features:

- **High-accuracy performance for all your gases.** Use your flow meter with any of the 98+ gases included with Gas Select™, [page 13](#).
- **1000 readings per second** guarantees high resolution data, [page 10](#).
- **Monitor live pressure and temperature** during flow control, [page 10](#).
- **Backlit display with adjustable contrast** is easy to read even in direct sunlight. In dimly lit areas, press the logo to turn on the backlight, [page 17](#).
- **Change your STP** (standard temperature and pressure) to match any standard temperature and pressure reference, [page 15](#).
- **Connection to a computer** for control and data logging to capture all pressure data for logging and analysis, [page 18](#).

This manual covers the following instruments:

- Gas mass flow meters
- High-pressure gas mass flow meters
- Anti-corrosive gas mass flow meters
- Low pressure drop gas mass flow meters
- Portable gas mass flow meters
- Portable high-pressure gas mass flow meters
- Portable anti-corrosive gas mass flow meters
- Portable low pressure drop gas mass flow meters

For support or questions regarding the use or operation of this device, please use the contact information on [page 2](#).

Contents

Introduction	3	Serial Communication	18
Quick Start Guide	5	Modbus RTU Communication	18
Getting Started	6	Establishing Communication	18
Getting to Know Your Mass Flow Meter	6	Polling Mode.....	18
The Flow Meter Display.....	6	Streaming Mode.....	19
Status Messages.....	6	Taring	19
Mounting	6	Collecting Data	19
Filters	6	Using Gas Select™ and COMPOSER™	20
Device Ports	7	Quick Command Guide	21
Connecting Your Gas Flow Meter	7	Troubleshooting	22
Option: Charging Your Portable Meter	8	General Use	22
Power and Signal Connections	8	Flow Readings	22
Analog Signals.....	9	Serial Communications	23
Displaying Live Data	10	Maintenance	23
Option: Color TFT Display	11	Cleaning	23
Option: Collecting Totalized Flow Data	11	Recalibration	23
Device Information	12	Reference Information	24
Setup	13	Engineering Units	24
Gas Selection	13	Gas List by Number	25
Gas Select™.....	13	Gas List by Category	26
Using COMPOSER™ Gas Mixes.....	13	Pinouts	27
Creating New Mixes in COMPOSER™.....	14	8-Pin Mini-DIN (Default).....	27
Viewing, Deleting, and Creating Similar Mixes.....	14	Locking Industrial Connector Pinout.....	27
Sensor Setup	15	9-Pin D-Sub Connector Common Pinouts.....	28
Choosing Engineering Units.....	15	15-Pin D-Sub Connector Common Pinouts.....	28
Defining STP/NTP Reference Values.....	15	M12 Connector Common Pinouts.....	29
Flow and Pressure Averaging.....	15		
Zero Band.....	15		
Configuring Serial Communications	16		
Unit ID.....	16		
Modbus RTU Address.....	16		
Baud Rate.....	16		
Display Setup	17		
Main Screen Options.....	17		
Screen Lighting.....	17		
Display Rotation.....	17		
Advanced Setup	17		

Quick Start Guide

Setup

- **Connect your flow meter.** Ensure that flow will pass through your device in the same direction as the arrow on the flow body (usually left to right).
- **Choose your engineering units.** You can choose the measurement units by selecting **MAIN MENU** → **SETUP** → **Sensor** → **Engineering Units**, see [page 15](#) for more details.

Operation: Flow Verification

- **Monitor live flow, temperature, and pressure readings.** Readings are updated and displayed on your device in real time. See [page 6](#).
- (Optional) **Capture totalized readings.** The totalizer option displays the total flow that has passed through the device since the last time the totalizer was reset. If your device has a totalizer, press **NEXT** from the main live data display to access the totalizer. See [page 11](#).

Connectors and Buttons

The drawing to the right represents a typical configuration of a standard mass flow meter.

Your device's appearance and process connections may differ. See [page 12](#) for more examples.

Backlight

The monochrome display comes equipped with a backlight. **To toggle the backlight power, press the logo on the front of your device.**

For optional color TFT displays, pressing this button will turn off the display to conserve power. See [page 11](#).

Maintenance and Care

- Flow meters do not require cleaning when flowing clean, dry gases. Read more on [page 23](#).
- Calibrate your flow meter annually. To schedule a calibration, please contact support ([page 2](#)).

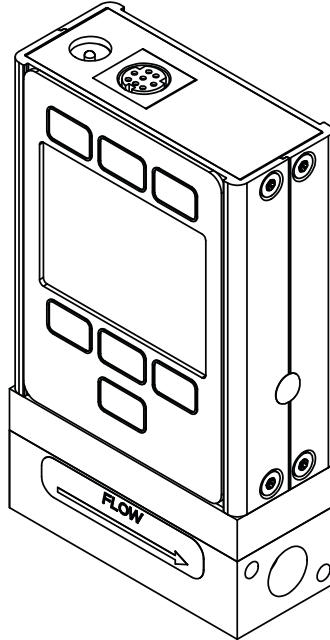

This M-20SLPM-D model mass flow meter is a typical unit. The flow body can vary significantly, generally depending on full-scale flow rate.

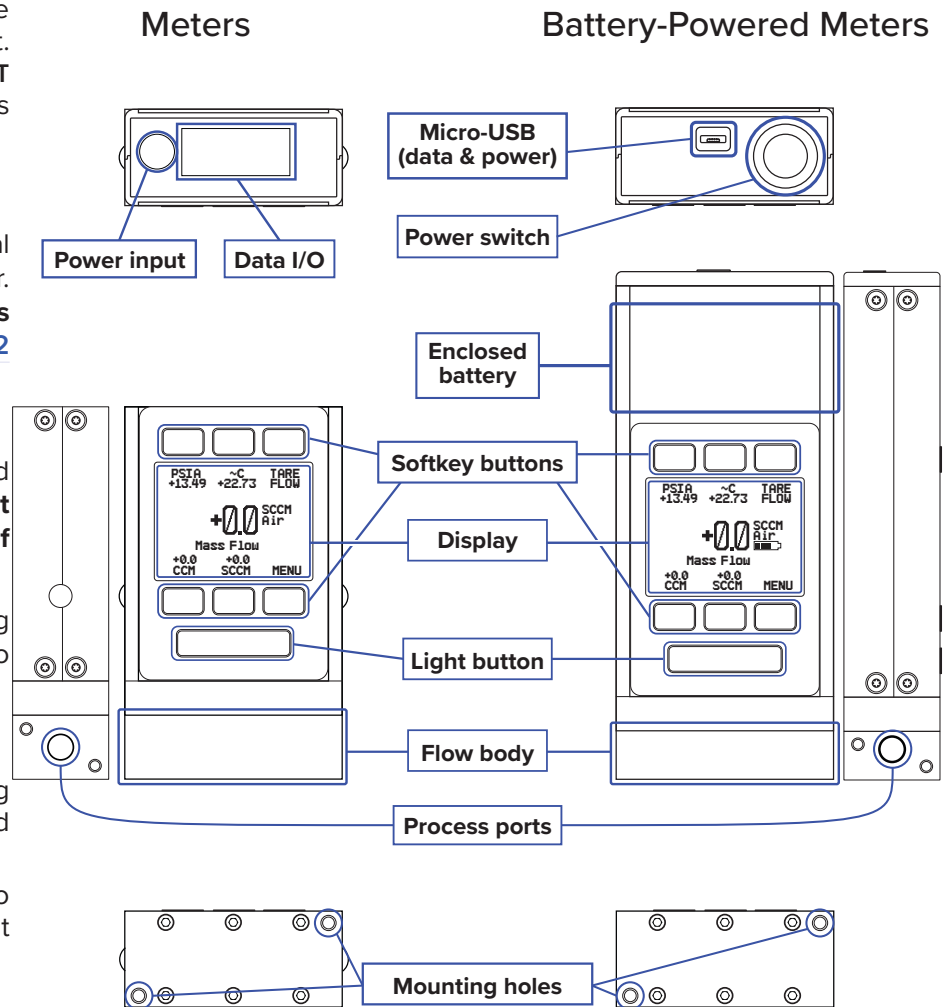

Getting Started

Getting to Know Your Mass Flow Meter

The Flow Meter Display

The figure to the right identifies the various features of the flow meter display.

- 1 Highlights **pressure** in the center of the device.
- 2 Highlights **temperature** in the center of the device.
- 3 **Tares** the device's flow measurement ([page 10](#)).
- 4 Highlights **volumetric (actual) flow** rate in the center of the device.
- 5 Highlights **mass flow** rate in the center of the device (default).
- 6 **MENU** enters the **main menu** system.
NEXT accesses the optional **flow totalizer** ([page 11](#)).
- 7 Toggles the backlight.

Status Messages

Status messages are shown to the right of the main readout number. In the example to the right the **OVR** message shows that the totalizer rolled over to zero.

ADC Analog-digital converter error
LCK Front display is locked
MOV Mass flow over range of device
OVR Totalizer rolled over to zero

POV Pressure over range of device
TMF Totalizer missed out-of-range flow
TOV Temperature over range of device
VOV Volumetric flow over range of device

Mounting

Flow meters do not require straight runs of pipe upstream or downstream. Most flow meter models can be mounted in any position, including upside-down. Corrosive-resistant flow meters use media-isolated sensors that must be tared after changing orientation.

Filters

When pressure drop is not a concern, use in-line sintered filters to prevent large particulates from entering the flow body of the meter. Suggested maximum particulate sizes are as follows:

- **5 microns** for units with flow ranges ≤ 1 SCCM.
- **20 microns** for units with flow ranges between 1 SCCM and 1 SLPM.
- **50 microns** for units with flow ranges ≥ 1 SLPM.

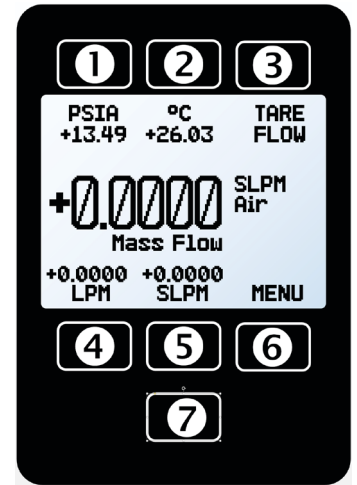

The *main display*. Note the button behind the logo, which toggles the device backlight.

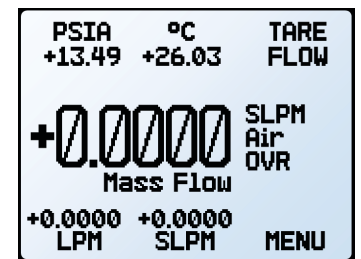

The *main display* with barometer (PSIG) and an **OVR** status message.

Device Ports

Your meter has been shipped with plastic plugs fitted into its ports. To decrease the chance of contaminating the flow stream, do not remove these plugs until you are ready to install the device.

Standard gas flow meters have female inlet and outlet ports. VCR®-compatible and other specialty fittings may have male connections.

- If you are using a fitting that does not have a face seal, use thread-sealing Teflon tape to prevent leakage around the port threads, but do not wrap the first two threads entering the device. This will minimize the possibility of getting tape into the flow stream and clogging the laminar flow elements.
- Face seal fittings do not need Teflon tape applied to the threads.

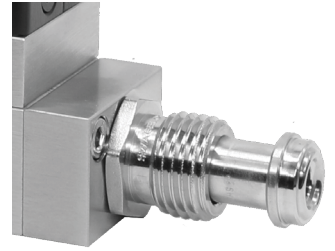

A mass flow meter with male VCR®-compatible connections.

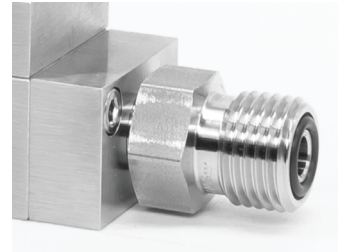

A mass flow meter with male VCO®-compatible connections.

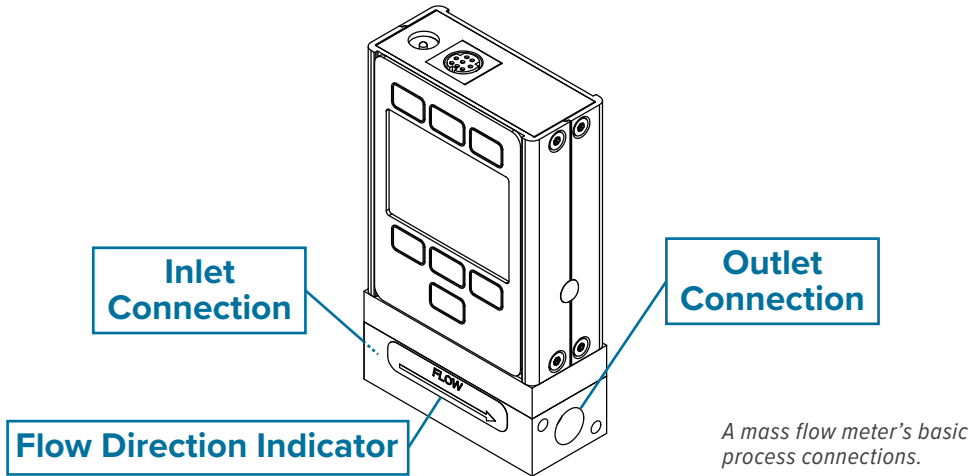

Warning: It is not recommended to use pipe dopes or sealants on the process connections as these compounds can cause permanent damage to the meter should they get into the flow stream.

Connecting Your Gas Flow Meter

Your flow meter can measure flow generated by positive pressure and/or suction. Connect the meter so that the flow travels in the same direction as the flow arrow, usually from left to right from the front of the device.



Warning: Using the flow meter above the maximum specified common mode or differential pressure will result in permanent damage to the internal pressure sensors.

A common cause of this problem is the instantaneous application of high-pressure gas, as from a snap-acting solenoid valve either upstream or downstream of the flow meter. If you suspect that your pressure sensor is damaged, please discontinue use of the device and contact support ([page 12](#)). See the chart below for pressure limits.

Model	Maximum Common Mode Pressure	Maximum Differential Pressure
Standard meters	175 PSIA	75 PSID
Low-pressure-drop meters	80 PSIA	10 PSID
High-pressure meters	400 PSIA	75 PSID

Option: Charging Your Portable Meter

Portable meters' batteries are partially charged before shipping. When fully charged, typical battery life is 18 hours with a monochrome display, or 8 hours with a TFT color display. Dimming the backlight will increase battery life. When the battery indicator displays it is completely empty, about 15 minutes of battery life remain.

Charge the device using the supplied USB cable (micro-B to type A) or a similar cable. Any USB outlet on a computer or portable power supply may be used, but charging will be fastest (approximately 3.5 hours) when connected to the supplied 2.0 A power supply.

The red indicator LED on top of the device lights up to indicate that the unit is charging, and turns off when the battery is charged.

Your meter may be used while it is charging. If the battery has been fully depleted, you may need to charge the pressure gauge for a full minute before the device can be turned on.

Warning: The safe charging temperature range is 0–45°C (32–113°F). If internal sensors detect temperatures outside of this range, the battery will not charge.

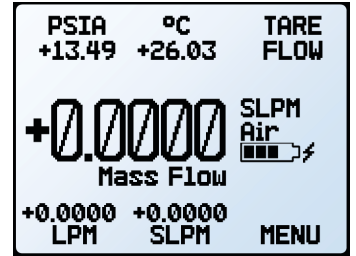

The main display with battery information and an active charging indicator (the lightning bolt).

Power and Signal Connections

Power can be supplied to your meter through either the power jack or the multi-pin connector on top of your device.

Note: Power requirements vary based on analog configuration and valve type. Please reference the associated specification sheet for power requirements.

Standard 8-Pin Mini-DIN Pinout

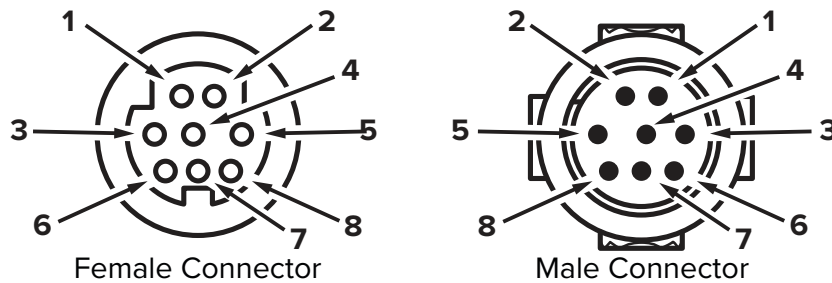

Pin	Function
1	Not Connected <i>Optional: 4–20 mA primary output signal</i>
2	Static 5.12 Vdc <i>Optional: secondary analog output (4–20 mA, 0–5 Vdc, 1–5 Vdc, 0–10 Vdc) or basic alarm</i>
3	Serial RS-232RX / RS-485(-) input signal (receive)
4	Remote tare (ground to tare)
5	Serial RS-232TX / RS-485(+) output signal (send)
6	0–5 Vdc <i>Optional: 1–5 Vdc or 0–10 Vdc output signal</i>
7	Power In (as described above)
8	Ground (common for power, digital communications, analog signals and alarms)

The above pinout is applicable to all devices with the Mini-DIN connector. The availability of different output signals depends on the options ordered. Optional configurations are noted on the unit's calibration sheet.

Caution: Do not connect power to pins 1 through 6, as permanent damage can occur. It is common to mistake pin 2 (labeled 5.12 Vdc Output) as the standard 0–5 Vdc analog output signal. Pin 2 is normally a constant 5.12 Vdc.

For more pinout configurations, see [page 27](#).

Analog Signals

Primary Analog Output Signal

Most devices include a primary analog output signal, which is linear over its entire range. For ranges that start at 0 Vdc, a zero-pressure condition is indicated at approximately 0.010 Vdc. Full scale pressure is indicated by the top of the range: 5 Vdc for 0–5 Vdc, 20 mA for 4–20 mA signals, and so on.

Option: Secondary Analog Output Signal

The default 8-pin Mini-DIN connector places the primary analog output on pin 6 for voltage signals, and Pin 1 for 4–20 mA current signals. Ground for these signals is common on pin 8.

Using Ground to Tare

You can tare your pressure gauge remotely by momentarily grounding pin 4. When the switch is closed, the device will tare. Operation will resume when the switch is released. You can also tare with the front controls ([page 6](#)) or serial commands ([page 18](#)). This should only be done in a true zero-flow condition.

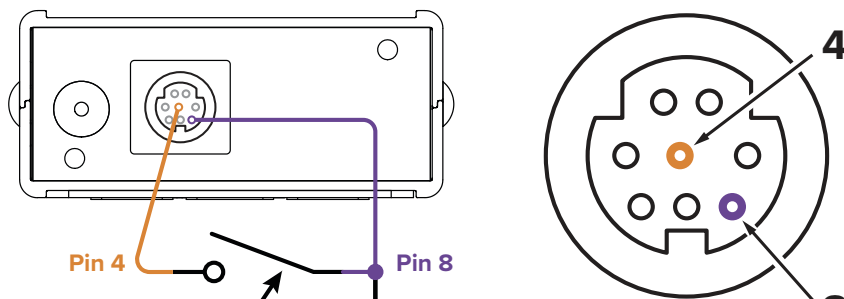

Option: Second Analog Output Signal

The default 8-pin Mini-DIN connector places the secondary analog output on pin 2 for both voltage and current signals. Your device's secondary analog signal may differ from its primary output signal.



Note: See the calibration sheet that shipped with your meter to determine which output signals were ordered.

Option: 4–20 mA Current Output Signal

If your meter has a 4–20 mA current primary or secondary output signal, your flow meter will require 12–24 Vdc power.



Caution: Do not connect 4–20 mA devices to “loop powered” systems, as this will damage portions of the circuitry beyond repair and void the warranty. If you must interface with existing loop powered systems, always use a signal isolator and a separate power supply.

Displaying Live Data

Main Display

The **main display** has these primary functions:

- Displaying live temperature, pressure, and flow data
- Accessing the **main menu (MENU)** or the optional totalizer (**NEXT**) ([page 11](#))
- Taring the flow measurement ([page 10](#))

This screen displays live data for all flow parameters simultaneously. Live data is measured 1000 times per second and the LCD display is updated 10 times per second. The button next to the measurements highlight their values in the center.

Taring Your Flow Meter

MENU → **TARE FLOW** or **TARES**

Taring ensures your flow meter provides its most accurate measurements. This function gives the flow meter a zero reference for flow measurements. For meters with a barometer, the absolute pressure reading can also be tared when the device is exposed to the local barometric pressure.

How to Tare

Taring Flow

MENU → **TARES** → **TARE FLOW**

Flow tares should take place at the expected process pressure, with no flow. A message, "ENSURE NO FLOW BEFORE PRESSING TARE" will be displayed. Press **TARE** to complete the taring process.

Optional: Taring Pressure

MENU → **TARES** → **TARE PRESS**

Absolute pressure tares require an optional barometer, and the meter open to atmosphere. A message, "PRESS TARE WHEN VENTED TO AMBIENT WITH NO FLOW". The offset between the absolute pressure sensor in the flow body and the internal barometer will also be displayed.

When to Tare

- Before every new flow measurement cycle
- After significant changes in temperature or pressure
- After dropping or bumping the flow meter
- After changing the device's orientation

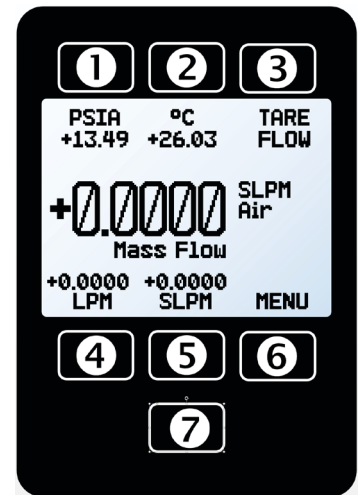

The *main display*.

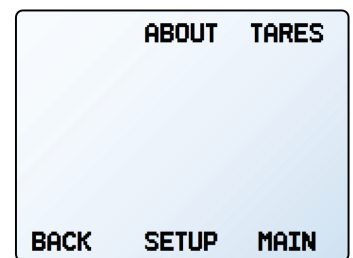

Tare mass flow by selecting **TARES** from the *main menu*.

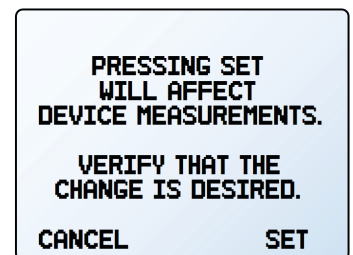

The *tare confirmation screen*.

Option: Color TFT Display

Instruments ordered with a color display are functionally the same as standard backlit monochrome instruments. The color enables additional on-screen information.

Multi-Color Display Indicators

- **GREEN:** Parameter labels and adjustments associated with the button directly above or below the label are presented in green.
- **WHITE:** The color of each parameter will be displayed in white when the device is operating within device specifications.
- **RED:** The color of a parameter will be displayed in red when its value exceeds 128% of the device's specifications.
- **YELLOW:** Menu items that are ready to be selected appear in yellow. This color replaces the > symbol in selections on monochrome display.



Note: Press the logo to turn off the color display backlight. The flow meter remains in operation while the backlight is off.



Note: Color displays will require an additional 40 mA when using a 12 Vdc power supply. All other device specifications from your device's specification sheet remain in effect.



A typical TFT display.

Option: Collecting Totalized Flow Data

MAIN DISPLAY → NEXT (totalizer menu)

The optional flow totalizer displays the total amount of mass or volume that has flowed through the instrument since its last reset, similar to a gasoline pump.

- **TOTAL/TIMER** toggles between totalized flow and elapsed time as the highlighted parameter in the center.
- **SLPM** (or another measurement of mass flow) displays the live flow rate. Press to change engineering units.
- **(Optional) M AVG** or **V AVG:** Shows totalizer averaging, which displays average flow rate since last reset, updated live.
- **SL** (in this example): Alternating display of selected engineering units for flow or time ([page 15](#)) and the selected gas ([page 13](#)).
- **RESET** clears all totalized data and immediately resets the timer to 0.
- **MENU** enters the main menu.

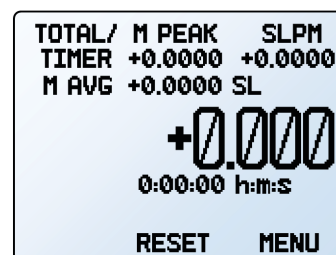

The totalizer displaying a mass flow average.

Totalizer Rollover Functions

The totalizer will report a maximum of 7 digits. By default, the placement of the decimal is the same as the live flow rate. The totalizer can be configured at the time of order for the following behaviors:

- **Rollover (Default):** Totalizer resumes counting from zero as soon as the maximum count has been reached.
- **Freeze:** Totalizer stops counting at max count, until it is reset manually.
- **Error (Default):** Displays **OVR** status message when maximum count has been reached; compatible with the rollover and freeze functions.

The elapsed time counter has a maximum value of 9999:59:59 (h:m:s) (416 days, 16 hours). If flow is still being totalized at that point, the timer freezes, regardless of the behavior chosen above for the totalized flow readings.

Device Information

The **ABOUT** menu (**MENU** → **ABOUT**) contains useful information for setup, configuration, and troubleshooting.

Basic Device Information

ABOUT → **About Device**

This includes information on the following:

- **MODEL**: Device model
- **SERIAL NO**: Serial number
- **DATE MFG**: Manufacturing date
- **DATE CAL**: Most-recent calibration date
- **CAL BY**: Initials of the person who calibrated the device
- **SW**: Firmware version
- **Display SW** (color displays only): Firmware version of the display

Device Full-Scale Ranges

ABOUT → **Full Scale Ranges**

This displays the maximum calibrated range of available flow and pressure readings. Most will include mass flow, volumetric flow, and absolute pressure. Devices equipped with an optional barometer will also show gauge and barometric pressures.

Manufacturer Information

ABOUT → **About Manufacturer**

About Manufacturer usually includes:

- Manufacturer name
- Web address
- Phone number
- Email address

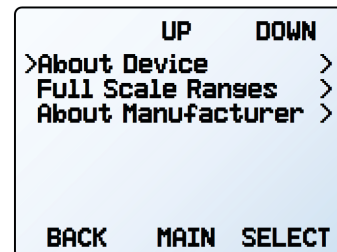

The about menu.

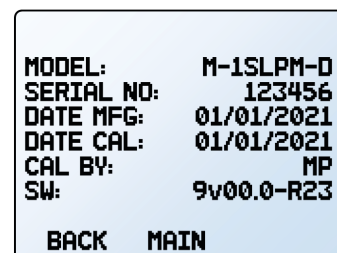

The about device screen.

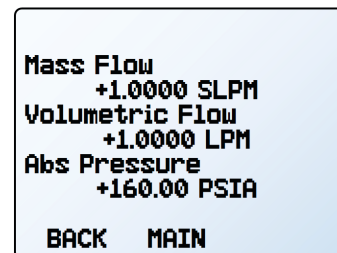

The full scale ranges screen.

Setup

Gas Selection

MENU → SETUP → Active Gas

Gas Select™

Most flow meters are physically calibrated at the factory using air. Gas Select™ allows you to reconfigure the flow meter to flow a different gas without any need to send it back for a physical recalibration.

Within this menu, there are a variety of categories (such as **Standard**, **Chromatography** and **Welding**), as well as recent selections, and COMPOSER™ mixes (see below). Each category will list a subset of available gases and preconfigured mixtures.

As soon as you press **SET** from the gas list, your flow meter will reconfigure its flow rate calculations to the newly selected gas's properties. There is no need to restart the device.

Your current gas selection appears just below the unit's indicator on the right side of the main display ([page 10](#)).

Category and Gas List Controls

- **PAGE** advances the view to the next page of categories or gases.
- **SELECT** (in the category list) opens a list of gases in that category.
- **SET** (in the gas list) immediately loads the gas measurement properties and exits to the setup menu.

Using COMPOSER™ Gas Mixes

SETUP → Active Gas → COMPOSER Mixes

To provide accurate measurements, your flow meter needs to reference the viscosity of the gas you are flowing through it. The closer you can get to defining your actual gas composition, the more accurate your flow readings will be. COMPOSER™ is an included feature of Gas Select™ that lets you define new mixed gas compositions to reconfigure your flow meter whenever needed.

Wilke's semi-empirical method is used to define a new gas mixture based on the molar (volumetric) ratios of the gases in the mixture. You can define these gas compositions to within 0.01% for each of up to five constituent gases in the mixture. Once you define and save a new COMPOSER™ gas mix, it becomes part of the Gas Select™ system and is accessible under the gas category **COMPOSER User Mixes**. You can store up to 20 COMPOSER™ gas mixes on your flow meter simultaneously.



Note: The COMPOSER™ device firmware does not physically mix gases. It only configures the device's calculations to report flow readings more accurately based on the constituent gases of your defined mixture.

Select any existing mix and press **SET** to immediately configure your device to measure that gas mixture. To create new mixes, see the next section.

	UP	DOWN
>Active Gas: Air		>
Sensor		>
RS-232 Serial		>
Display		>
Advanced		>
BACK	MAIN	SELECT

The setup menu.

	PAGE	UP	DOWN
>Recent			>
Standard			>
COMPOSER Mixes			>
Bioreactor			>
Breathing			>
Chromatography			>
Fuel			>
BACK	MAIN	SELECT	

The first page of the Gas Select™ category list.

	PAGE	UP	DOWN
>Air			
Ar Argon			
CH4 Methane			
CO Carbon Monoxide			
CO2 Carbon Dioxide			
C2H6 Ethane			
H2 Hydrogen			
BACK	INFO	SELECT	

The Gas Select™ standard gas list.

Creating New Mixes in COMPOSER™

SETUP → Active Gas → COMPOSER Mixes → Create Mix

Give the Mix a Short and Long Name

UP/DOWN will change the character. Valid characters include A–Z, 0–9, punctuation (., -), and space. CANCEL exits to the mix settings menu. SET accepts the name.



Note: Using a space in the short name can cause the serial data frame to be read incorrectly by some programs.

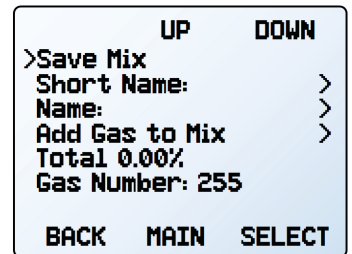

The mix settings menu.

Define the Mix.

- **Add Gas to Mix** enters the Gas Select™ category listing. Once you find the correct gas, press **SET**. Enter the composition percentage and press **SET**.
- As gases are added, the total used percentage will be shown on the **mix settings menu**.
- When adding the last gas, COMPOSER™ can change the gas percentage to fill the remaining portion to 100% by selecting the component gas, then selecting **Set % to Balance**.
- Once the gases total 100%, the mixture can be saved by selecting **Save Mix**. Selecting **BACK** will permanently discard the mix.
- After a few gases have been added, the list will push the menu to a second page; use the **PAGE** button to see the remaining list.

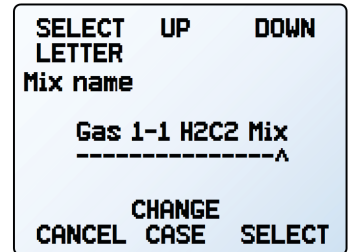

Defining a mixture's long name.

Viewing, Deleting, and Creating Similar Mixes

SETUP → Active Gas → COMPOSER Mixes → [Select mix] → INFO

The current configuration of any existing COMPOSER™ mix can be viewed by selecting **INFO** instead of **SET** in the mix list. It will show:

- Options to delete the mix, or to create a similar mix.
- Short and long names.
- The gas number.
- The composition, which may extend to a second page; if so, pressing the **PAGE** button will move to the next page.

Sensor Setup

MENU → SETUP → Sensor

Choosing Engineering Units

SETUP → Sensor → Engineering Units

Changing device engineering units alters both the display and the data frame. Choose the parameter whose unit you want to change, and then select your desired engineering unit, confirming the change on the last screen.

Defining STP/NTP Reference Values

SETUP → Sensor → STP Flow Ref or NTP Flow Ref

Standardized flow rates are reported in “standard” or “normal” volumetric flow units that reference a given temperature and pressure combination. This reference is called STP (standard temperature and pressure) or NTP (normal temperature and pressure). Depending on the engineering units selected, either STP or NTP will be editable from this menu.

Reference options:

- **Stan T:** Standard Temperature
- **Stan P:** Standard Pressure
- **Norm T:** Normal Temperature
- **Norm P:** Normal Pressure
- **Ref temp units** changes the temperature units used for STP and NTP calculations.
- **Ref pressure units** changes the pressure units used for STP and NTP calculations

Unless otherwise requested, your flow meter ships with a default STP of 25°C and 1 atm (which affects flow units beginning with “S”), and an NTP of 0°C and 1 atm (which affects flow units beginning with “N”).



Warning: Changes to STP or NTP references will alter your mass flow readings.

Flow and Pressure Averaging

SETUP → Sensor → Flow Averaging

SETUP → Sensor → Pressure Averaging

Averaging the flow and pressure over a longer time may be useful in smoothing fluctuating readings. This menu changes the time constants of the geometric running averages for flow and pressure. Values roughly correspond to the time constant (in milliseconds) of the averaged values. Higher numbers generate a greater smoothing effect, to a maximum of 255 ms.

Zero Band

SETUP → Sensor → Zero Band

The zero band threshold is an amount of flow under which flow values are displayed as 0. The maximum zero band is 6.38%. This function also applies to gauge pressure readings when using the optional barometer. For example, a 20 SLPM meter with a zero band value of 0.25% would display all readings below 0.05 SLPM as 0 SLPM.

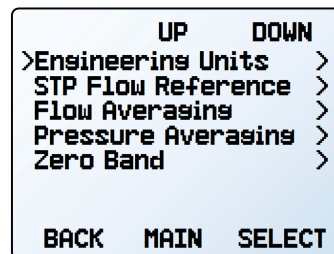

The sensor setup menu.

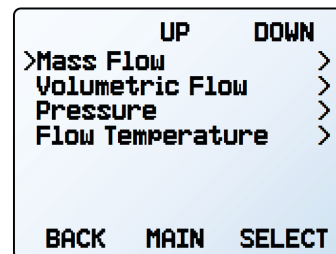

The engineering units menu (page 11).

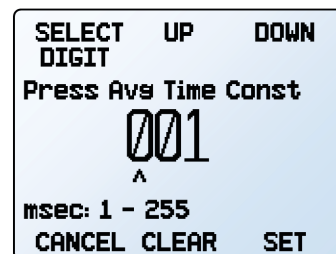

Adjusting the flow averaging time constant.

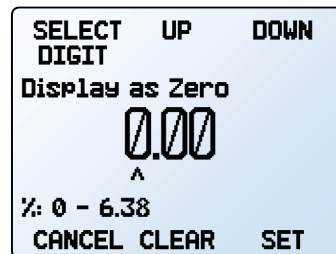

Configuring the zero band.

Configuring Serial Communications

MENU → SETUP → RS-232 Serial or RS-485 Serial or Serial Comm

You can operate the flow meter remotely via its data connection for easy streaming and logging of all data. Before connecting the flow meter to a computer, ensure that it is ready to communicate with your PC by checking the options in this menu.

For more on how to issue commands from a computer, see [page 18](#).

Unit ID

SETUP → RS-232 Serial or RS-485 Serial → Unit ID

The unit ID is the identifier that a computer uses to distinguish your device from other, similar devices when connected to a network. Using the unit ID letters A–Z, you can connect up to 26 devices to a computer at the same time via a single COM port. This is called **polling mode** ([page 19](#)). Unit ID changes take effect when you select **SET**.

If you select “@” as the Unit ID, the flow meter will enter **streaming mode** when you exit the menu ([page 19](#)).

Modbus RTU Address

SETUP → RS-232 Serial or RS-485 Serial → Modbus Address

The Modbus address is the identifier that a computer or programmable logic computer (PLC) uses to distinguish your device from other devices when connected to a Modbus network. Values of 1–247 are available for use.

Baud Rate

SETUP → RS-232 Serial or RS-485 Serial → Baud Rate

Baud rate is the speed at which digital devices transfer information. The flow meter has a default baud rate of 19200 baud (bits per second). If your computer or software uses a different baud rate, you must change the flow meter’s baud rate in the **BAUD** menu to ensure they match. Alternatively, you can change your computer’s baud rate in Windows® Device Manager. Baud rate changes take effect once you press **SET**, but you may need to restart the software for it to recognize the change.

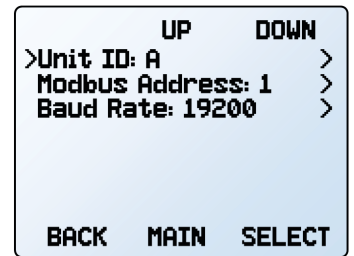

The serial communication menu.

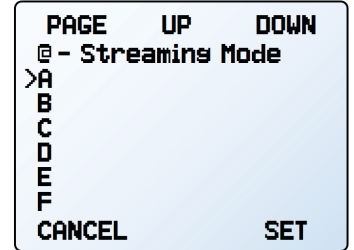

Choosing a unit ID, or streaming.

Display Setup

MENU → SETUP → Display

The options in the **display setup menu** adjust the contrast/brightness of the display and enable screen rotation.

Main Screen Options

SETUP → Display → MAIN Screen

- **Any Key Press** changes what happens when any of the parameter buttons on the **main display** ([page 10](#)) are pressed (pressure or temperature, for example). By default, these buttons highlight their measurement in the center of the display. If this option is set to **Show Actions Menu**, an option to change that parameter's engineering units will be shown, as well as an option to highlight the parameter.
- **Top Left Key Value** will show if the device has an optional barometer installed. This option configures which type of pressure (barometric, gauge, absolute) is displayed.

Screen Lighting

SETUP → Display → Screen Lighting

The options and wording in the **screen lighting menu** will vary for monochrome versus color displays.

- On monochrome displays, press **LESS CONTRAST** or **MORE CONTRAST** to adjust the contrast levels and move the contrast indicator left or right. **POWER UP Lit** or **Dark** toggles whether the backlight of the unit will be on when the device powers on.
- On color displays, press **DIMMER** or **BRIGHTER** to adjust the brightness level and move the brightness indicator left or right.

Display Rotation

SETUP → Display → Display Rotation

The device has the option of inverting (flipping) the screen upside-down, as configured in this menu.

Advanced Setup

MENU → SETUP → Advanced

The **advanced setup menu** contains settings and detailed information that are useful when troubleshooting with customer support.

Factory Restore

SETUP → Advanced → Factory Restore

This will immediately take you to a confirmation screen. When troubleshooting, an applications engineer may recommend doing a **Factory Restore**. If something is not acting as expected, please contact support ([page 2](#)) prior to doing a **Factory Restore**.

Register Status

SETUP → Advanced → Register Status

The **Register Status** screen displays live values for the internal device registers. Many of these values can help an applications engineer diagnose operational issues over the phone. Some register values clearly distinguish between hardware and operational problems, which speeds up the troubleshooting process.

Edit Register and Device Properties

SETUP → Advanced → Edit Register

SETUP → Advanced → Device Properties



Warning: Editing these settings may cause the device to become inoperable. Do not modify them without working with an applications engineer.

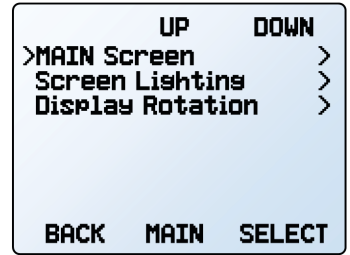

The *display setup menu*.

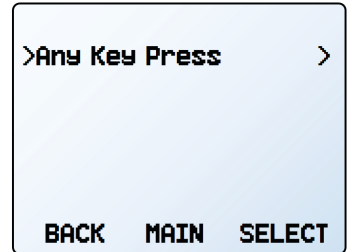

The options for pressing buttons on the *main display*.

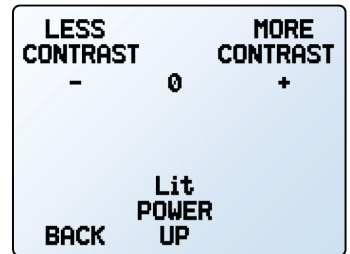

The *monochrome contrast menu*.

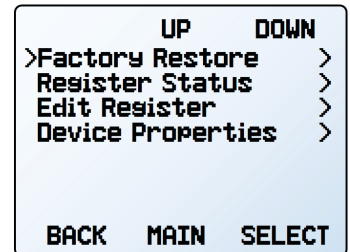

The *advanced setup menu*.

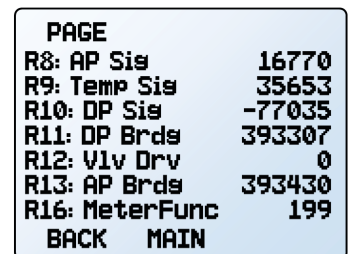

The *register status list*.

Serial Communication

Connecting your device to a computer allows you to log the data that it generates. The device communicates digitally through its communications connector and cable using a real or virtual COM port on your computer. This section of the manual shows you how to operate the flow meter using ASCII commands.

Modbus RTU Communication

For details on Modbus commands, please contact support ([page 2](#)).

Establishing Communication

After connecting your device using a communications cable, you will need to establish serial communications through a real or virtual COM port on your computer or programmable logic computer (PLC).

- If you have connected your device to a serial port, note its COM port number, which can be found in the Windows® Device Manager program.
- If you have used a USB cable to connect your device to your computer, then in most cases it will recognize your USB as a virtual COM port. If it does not, contact support ([page 2](#)) with the COM port number as found in Windows® Device Manager.

The meter will be configured with the following settings:

- **Baud:** 19200 (by default; others can be used if the computer, computer software, and the meter are all set to the same rate)
- **Data bits:** 8
- **Parity:** none
- **Stop bits:** 1
- **Flow control:** none

Communication Programs

Although the device will communicate with any compatible terminal program over RS-232, PuTTY is a common option. A USB port or COM port will not supply enough power to your device to function. Please use another power source.

Configuring PuTTY

1. Download PuTTY from putty.org and run the installer.
2. Open PuTTY; it will start on the Configuration screen.
3. Click on the Terminal category. The changes we make here will cause PuTTY to act like a normal serial terminal, such that pressing enter will move the cursor to the next line and both what you type and what gets returned stay on the screen:
 - Check the box that says “Implicit LF in every CR.”
 - Select the “Force on” radio button in the “Local echo” section.
4. Click Connection, and then the Serial subcategory.
 - Set the Speed (baud) to 19200.
 - Set the Data bits to 8.
 - Set the Stop bits to 1
 - Ensure “None” is selected for both Parity and Flow control.
5. Click on the Session category.
 - Select the “Serial” radio button under “Connection type”.
 - Check that the COM port and baud rate (Speed) are correct.

Save your settings so they can be recalled again later.

Polling Mode

Polling mode and a unit ID of A is default, unless otherwise requested. Polling the device returns a single line of data for each request. To poll your device, simply enter its unit ID.

Poll the device: [unit ID]↵

Example: a↵ (polls unit A)

You can change the unit ID of a polling device by typing:

Change the unit ID: [current unit ID]@[desired unit ID]↵

Example: a@=b↵ (changes unit A to unit B)

The unit ID can be changed via the device's front panel ([page 16](#)). Valid unit IDs are letters A–Z, and up to 26 devices may be connected, as long as each unit ID is unique.

Streaming Mode

In streaming mode, your device automatically sends a line of live data at regular intervals. Only one unit on a given COM port may be in streaming mode at a time. To put your device into streaming mode, type:

Begin streaming: [unit ID]@=@↵

Example: a@=@↵ (puts device A into streaming mode)

This is equivalent to changing the unit ID to “@”. To take the flow meter out of streaming mode, assign it a unit ID by typing:

Stop streaming: @@=[desired unit ID]↵

Example: @@=a↵ (stops and assigns unit ID of A)

When sending a command to a device in streaming mode, the flow of data will not stop while the user is typing. This may make the commands you type unreadable. If the device does not receive a valid command, it will ignore it. If in doubt, simply hit ↵ and start again.

The default streaming interval is 50 ms, but this can be increased by changing Register 91 while the device is in polling mode:

Set streaming interval: [unit ID] w91=[number of ms]↵

Example: aw91=500↵ (streams new data every 500 ms)

Taring

Before collecting flow data, be sure to tare your meter.

Manual taring can be accomplished through two separate commands for flow and pressure. Taring flow sets the zero flow reading and must be done when no flow is passing through the flow meter:

Tare flow: [unit ID]v↵

Example: av↵ (sets flow reading to zero)

For devices equipped with a barometer, the second tare aligns the internal absolute pressure sensor with the barometer reading and must be done with the flow meter open to atmosphere:

Tare absolute pressure: [unit ID]pc↵

Example: apc↵ (requires optional barometer)

Collecting Data

Collect live flow data by typing the [unit ID] ↵ command or by setting your flow meter to streaming. Each line of data for live flow measurements appears in the format below, but the unit ID is not present in streaming mode.

A	+13.542	+24.57	+16.667	+15.444	N2
ID	Absolute Pressure	Temperature	Volumetric Flow	Mass Flow	Gas

Single spaces separate each parameter, and each value is displayed in the chosen device engineering units ([page 15](#)). You can query the engineering units of the serial data frame by typing:

Query live data info: [unit ID]??d*↵

Example: a??d*↵ (returns the data frame descriptions)

Additional columns, including status codes ([page 6](#)), may be present after the last number. The unit ID appears in the data frame only when the flow meter is in polling mode.

Using Gas Select™ and COMPOSER™

To reconfigure your flow meter to flow a different gas, look up its gas number ([page 24](#)). For more information on how Gas Select™ and COMPOSER™ work, see [page 13](#). Here are the commands:

Choose a gas: [unit ID]g[Gas Number]↵

Example 1: ag8↵ (reconfigures to flow nitrogen)

Example 2: ag206↵ (reconfigures to flow P-10)

User mixes are selected in the same way. All COMPOSER™ gas mixes have a mix number between 236 and 255.

Choose a user mix: [unit ID]g[Gas Number]↵

Example: ag255↵ (reconfigures for user mix 255)

Defining a new COMPOSER™ gas mix is faster using serial commands than using the front panel. The basic formula for this is:

[unit ID]gm [Mix Name] [Mix Number] [Gas1 %] [Gas1 Number] [Gas2 %] [Gas2 Number]...↵

[Mix Name] Use a maximum of 6 letters (upper and/or lower case), numbers and symbols (period or hyphen only). This is equivalent to the short name when creating a mix via the front panel ([page 14](#)).

[Mix Number] Choose a number from 236 to 255. If a user mix with that number already exists, it will be overwritten. Use the number 0 to assign the next available number to your new gas. Gas numbers are assigned in descending order from 255.

[Gas1 %] [Gas1 Number]... For each gas, enter its molar percentage up to 2 decimal places, then its gas number ([page 24](#)). 2–5 gases are required, and the sum of all gas constituent percentages must equal 100.00%. After creating a mix, the meter will confirm the new gas:

Example 1: Create a mix of 71.35% helium, 19.25% nitrogen, and 9.4% carbon dioxide as Gas 252, called “MyGas1”.

Command:

agm MyGas1 252 71.35 7 19.25 8 9.4 4↵

Response: A 252 71.35% He 19.25% N2 9.40% C02

Example 2: Create a mix of 93% methane, 3% ethane, 1% propane, 2% nitrogen, and 1% CO2, using the next available gas number, called “MyGas2”.

Command: agm MyGas2 0 93 2 3 5 1 12 2 8 1 4↵

Response: A 253 93.00% CH4 3.00% C2H6 1.00% C3H8 2.00% N2 1.00% C02

Quick Command Guide

Serial commands are not case-sensitive.

Change the unit ID: [unit ID]@[desired ID]↵
Tare flow: [unit ID]v↵
Tare absolute pressure
with barometer: [unit ID]pc↵ (requires optional barometer)
Poll the live data frame: [unit ID]↵
Begin streaming data: [unit ID]@=@↵
Stop streaming data: @@=[desired unit ID]↵
Set streaming interval: [unit ID]w91=[# of ms]↵
Query gas list info: [unit ID]??g*↵
Choose a different gas: [unit ID]g[Gas Number]↵
New COMPOSER mix: [unit ID]gm [Mix Name] [Mix #] [Gas1 %] [Gas1 #] [Gas2 %] [Gas2 #]...↵
Delete COMPOSER mix: [unit ID]gd [Mix #]↵
Query live data info: [unit ID]??d*↵
Manufacturer info: [unit ID]??m*↵
Firmware version: [unit ID]??m9↵ or ave↵
Lock the front display: [unit ID]l↵
Unlock the display: [unit ID]u↵

Troubleshooting

If you run into trouble with installation or operation, get in touch with support ([page 12](#)).

General Use

Issue: *My device does not turn on, or has trouble staying on.*

Action: Check power and ground connections. Please reference the technical specifications to ensure you have the proper power for your model.

Issue: *The buttons do not work, and the screen shows LCK.*

Action: The flow meter buttons were locked out via a serial command ([unit ID]1←). Press and hold all four outer buttons to unlock the interface.

Issue: *I can't read the display easily.*

Action: During the day, you can increase the visibility of the display by increasing the contrast or brightness ([page 17](#)). For monochrome displays under low-light conditions, push the bottom central button (located below the display) to turn on the backlight.

Issue: *The analog output signal indicates values lower than what appears on my instrument's display.*

Action: Analog signal voltage degrades over long distances. You can minimize this effect by using wires with a heavier gauge, especially in the ground wire.

Issue: *How often do I need to calibrate my device?*

Action: Annual recalibrations are recommended. Check your device's last calibration date by selecting MENU → ABOUT → About Device. If it is time to recalibrate, request a recalibration from customer support ([page 2](#)).

Issue: *I dropped my device. Is it OK? Do I need to recalibrate?*

Action: If it turns on and appears to respond normally, then it is probably OK. It may or may not need a recalibration. Give it a tare, and compare it against a known-good flow standard. If it checks out, keep using it, but tell us about the drop at your next annual recalibration so we can check it out for you.

Issue: *How can I see readings in different units?*

Action: From the main menu, select SETUP → Sensor → Engineering Units. From this menu, you can adjust any variable's units. For more information, see [page 15](#).

Flow Readings

Issue: *The live flow readings won't settle down.*

Action: The device is very fast, so it can detect subtle variations in flow that may go unnoticed by your other devices. This sensitivity can help detect problems with pumps or flow meters. You can lessen this sensitivity by increasing the flow averaging ([page 15](#)).

Issue: *My flow readings are negative.*

Action: Under conditions of no flow, a negative flow reading can indicate a poor tare.

Issue: *Does the meter work if it is laying down? Will it be accurate?*

Action: Yes to both! The flow meter is internally compensated for any changes in orientation and can be used sideways, on its back, or upside-down. Corrosive-resistant devices should be tared again after changing orientation.

Issue: *Can I put the flow meter on top of a vibrating device? Will it be accurate?*

Action: Yes. The device is internally compensated for any changes in orientation; however, sensor noise will increase if the flow meter is vibrating.

Issue: *My meter does not agree with another mass flow meter I have in line.*

Action: Check the STP or NTP settings (MENU → SETUP → Sensor → STP / NTP Flow Ref) to ensure that your standardized temperature and pressure references match those of your other flow calibrator. Also check that your device's Gas Select™ is set to the right gas or mixture.

Issue: *My flow readings won't change when flow changes.*

Action: If your flow readings won't change regardless of actual flow, your flow sensor may be damaged. Please contact support to troubleshoot ([page 2](#)).

Issue: *Can I use the meter with other gases?*

Action: Yes! Your flow meter is designed specifically to work with many different gases. Gas Select™ (MENU → SETUP → Active Gas) includes up to 130 preloaded gases and gas mixes, or you can define your own using COMPOSER™ (page 13). If your desired gas is not listed on page 24, please contact support to ensure compatibility (page 2).

Serial Communications

Issue: *I can't communicate to the device when it is connected to my PC.*

Action:

1. Make sure the baud rate your software and COM port required is the one your flow meter is using (MENU → SETUP → RS-232 Serial or RS-485 Serial → Baud Rate).
2. Check the flow meter unit ID (MENU → SETUP → RS-232 Serial or RS-485 Serial → Unit ID) to make sure you are addressing it properly with your serial commands.
3. Check the pinout (common pinouts are listed starting from "Pinouts" on page 27).
4. Make sure the COM number matches the one your software is using to connect to the flow meter.
5. On the external serial communications device (computer, PLC, etc.), be sure that the flow control (handshaking) settings are set as on page 18.

Still experiencing issues? Please contact support (page 2).

Maintenance

Cleaning

Your flow meter does not require cleaning, provided that it has been flowing clean, dry gas. If necessary, the outside of the device can be cleaned with a soft dry cloth.



Caution: *If you suspect that debris or other foreign material has entered your device, do not take apart the flow body to clean it, as this will negate its NIST-traceable calibration. Please contact support for cleaning (page 12).*

Recalibration

The recommended period for recalibration is once every year. A label located on the back of the device lists the most recent calibration date. This date is also stored inside your flow meter and is visible by selecting MENU → ABOUT → About Device.

When it is time for your device's annual recalibration, contact support (page 2) with your device's serial number and your contact information.

Reference Information

Engineering Units

For more information on engineering units, see [page 15](#).

Pressure Units

Absolute or Barometric		Gauge	Notes
PaA	PaG		Pascal
hPaA	hPaG		Hectopascal
kPaA	kPaG		Kilopascal
MPaA	MPaG		Megapascal
mbarA	mbarG		Millibar
barA	barG		Bar
g/cm ² A	g/cm ² G		Gram force per square centimeter [†]
kg/cm ² A	kg/cm ² G		Kilogram force per square centimeter [*]
PSIA	PSIG		Pound force per square inch
PSFA	PSFG		Pound force per square foot
mTorrA	mTorrG		Millitorr
torrA	torrG		Torr
mmHgA	mmHgG		Millimeter of mercury at 0°C
inHgA	inHgG		Inch of mercury at 0°C
mmH ₂ O A	mmH ₂ O G		Millimeter of water at 4°C (NIST conventional) [†]
mmH ₂ O A	mmH ₂ O G		Millimeter of water at 60°C [†]
cmH ₂ O A	cmH ₂ O G		Centimeter of water at 4°C (NIST conventional) [†]
cmH ₂ O A	cmH ₂ O G		Centimeter of water at 60°C [†]
inH ₂ O A	inH ₂ O G		Inch of water at 4°C (NIST conventional) [†]
inH ₂ O A	inH ₂ O G		Inch of water at 60°C [†]
atm			Atmosphere
m asl			Meter above sea level
ft asl			Foot above sea level
V			Volt
count	count		Setpoint count, 0–64000
%	%		Percent of full scale

Temperature Units

Label	Notes
°C	Degrees Celsius
°F	Degrees Fahrenheit
K	Kelvin
°R	Degrees Rankine

^{*} Displayed as kg/cmA and kg/cmG.

[†] Superscript and subscript numerals are displayed as lining (normal) numerals.

[‡] Instances of μ are displayed as a lower-case *u*.

Flow Units

Volumetric	Standard	Normal	Notes
μ L/m	S μ L/m	N μ L/m	Microliter per minute [‡]
mL/s	SmL/s	NmL/s	Milliliter per second
mL/m	SmL/m	NmL/m	Milliliter per minute
mL/h	SmL/h	NmL/h	Milliliter per hour
L/s	SL/s	NL/s	Liter per second
LPM	SLPM	NLPM	Liter per minute
L/h	SL/h	NL/h	Liter per hour
US GPM			US gallon per minute
US GPH			US gallon per hour
CCS	SCCS	NCCS	Cubic centimeter per second
CCM	SCCM	NCCM	Cubic centimeter per minute
cm ³ /h	Scm ³ /h	Ncm ³ /h	Cubic centimeter per hour [†]
m ³ /m	Sm ³ /m	Nm ³ /m	Cubic meter per minute [†]
m ³ /h	Sm ³ /h	Nm ³ /h	Cubic meter per hour [†]
m ³ /d	Sm ³ /d	Nm ³ /d	Cubic meter per day [†]
in ³ /m	Sin ³ /m		Cubic inch per minute [†]
CFM	SCFM		Cubic foot per minute
CFH	SCFH		Cubic foot per hour
CFD	SCFD		Cubic foot per day
	kSCFM		1000 cubic feet per minute
count	count	count	Setpoint count, 0–64000
%	%	%	Percent of full scale

True Mass Flow Units

Label	Notes
mg/s	Milligram per second
mg/m	Milligram per minute
g/s	Gram per second
g/m	Gram per minute
g/h	Gram per hour
kg/m	Kilogram per minute
kg/h	Kilogram per hour
oz/s	Ounce per second
oz/m	Ounce per minute
lb/m	Pound per minute
lb/h	Pound per hour

Time Units

Label	Notes
h:m:s	Hours:Minutes:Seconds
ms	Milliseconds
s	Seconds
m	Minutes
hour	Hours
day	Days

Total Units

Label	Notes
μ L	MicroLiter [‡]
mL	MilliLiter
L	Liter
US GAL	US gallon
cm ³	Cubic centimeter [†]
m ³	Cubic meter [†]
in ³	Cubic inch [†]
ft ³	Cubic foot [†]
μ P	Micropoise, a measure of viscosity [*]
mg	Milligrams
g	Grams
kg	Kilograms
oz	US ounces
lb	US pounds

Gas List by Number

To use any of these gases in your device, use Gas Select™ (page 13).

Short #	Short Name	Long Name
0	Air	Air (Clean Dry)
1	Ar	Argon
2	CH4	Methane
3	CO	Carbon Monoxide
4	CO2	Carbon Dioxide
5	C2H6	Ethane
6	H2	Hydrogen
7	He	Helium
8	N2	Nitrogen
9	N2O	Nitrous Oxide
10	Ne	Neon
11	O2	Oxygen
12	C3H8	Propane
13	nC4H10	Normal Butane
14	C2H2	Acetylene
15	C2H4	Ethylene (Ethene)
16	iC4H10	Isobutane
17	Kr	Krypton
18	Xe	Xenon
19	SF6	Sulfur Hexafluoride ¹
20	C-25	25% CO ₂ , 75% Ar
21	C-10	10% CO ₂ , 90% Ar
22	C-8	8% CO ₂ , 92% Ar
23	C-2	2% CO ₂ , 98% Ar
24	C-75	75% CO ₂ , 25% Ar
25	He-25	25% He, 75% Ar
26	He-75	75% He, 25% Ar
27	A1025	90% He, 7.5% Ar, 2.5% CO ₂
28	Star29	Stargon CS (90% Ar, 8% CO ₂ , 2% O ₂)
29	P-5	5% CH ₄ , 95% Ar
30	NO	Nitric Oxide ²
31	NF3	Nitrogen Trifluoride ²
32	NH3	Ammonia ²
33	Cl2	Chlorine ²
34	H2S	Hydrogen Sulfide ²
35	SO2	Sulfur Dioxide ²
36	C3H6	Propylene ²
80	1Buten	1-Butylene ²
81	cButen	Cis-Butene (cis-2-Butene) ²
82	iButen	Isobutene ²
83	tButen	Trans-2-Butene ²
84	COS	Carbonyl Sulfide ²
85	DME	Dimethylether (C ₂ H ₆ O) ²
86	SiH4	Silane ²
100	R-11	Trichlorofluoromethane (CCl ₃ F) ^{2,3}

Short #	Short Name	Long Name
101	R-115	Chloropentafluoroethane (C ₂ ClF ₅) ^{2,3}
102	R-116	Hexafluoroethane (C ₂ F ₆) ²
103	R-124	Chlorotetrafluoroethane (C ₂ HClF ₄) ^{2,3}
104	R-125	Pentafluoroethane (CF ₃ CHF ₂) ^{2,3}
105	R-134A	Tetrafluoroethane (CH ₂ FCF ₃) ^{2,3}
106	R-14	Tetrafluoromethane (CF ₄) ²
107	R-142b	Chlorodifluoroethane (CH ₃ CClF ₂) ^{2,3}
108	R-143a	Trifluoroethane (C ₂ H ₃ F ₃) ^{2,3}
109	R-152a	Difluoroethane (C ₂ H ₄ F ₂) ²
110	R-22	Difluoromonochloromethane (CHClF ₂) ^{2,3}
111	R-23	Trifluoromethane (CHF ₃) ^{2,3}
112	R-32	Difluoromethane (CH ₂ F ₂) ^{2,3}
113	R-318	Octafluorocyclobutane (C ₄ F ₈) ²
114	R-404A	44% R-125, 4% R-134A, 52% R-143A ^{2,3}
115	R-407C	23% R-32, 25% R-125, 52% R-143A ^{2,3}
116	R-410A	50% R-32, 50% R-125 ^{2,3}
117	R-507A	50% R-125, 50% R-143A ^{2,3}
140	C-15	15% CO ₂ , 85% Ar
141	C-20	20% CO ₂ , 80% Ar
142	C-50	50% CO ₂ , 50% Ar
143	He-50	50% He, 50% Ar
144	He-90	90% He, 10% Ar
145	Bio5M	5% CH ₄ , 95% CO ₂
146	Bio10M	10% CH ₄ , 90% CO ₂
147	Bio15M	15% CH ₄ , 85% CO ₂
148	Bio20M	20% CH ₄ , 80% CO ₂
149	Bio25M	25% CH ₄ , 75% CO ₂
150	Bio30M	30% CH ₄ , 70% CO ₂
151	Bio35M	35% CH ₄ , 65% CO ₂
152	Bio40M	40% CH ₄ , 60% CO ₂
153	Bio45M	45% CH ₄ , 55% CO ₂
154	Bio50M	50% CH ₄ , 50% CO ₂
155	Bio55M	55% CH ₄ , 45% CO ₂
156	Bio60M	60% CH ₄ , 40% CO ₂
157	Bio65M	65% CH ₄ , 35% CO ₂
158	Bio70M	70% CH ₄ , 30% CO ₂
159	Bio75M	75% CH ₄ , 25% CO ₂
160	Bio80M	80% CH ₄ , 20% CO ₂
161	Bio85M	85% CH ₄ , 15% CO ₂
162	Bio90M	90% CH ₄ , 10% CO ₂
163	Bio95M	95% CH ₄ , 5% CO ₂
164	EAN-32	32% O ₂ , 68% N ₂
165	EAN-36	36% O ₂ , 64% N ₂
166	EAN-40	40% O ₂ , 60% N ₂
167	HeOx20	20% O ₂ , 80% He
168	HeOx21	21% O ₂ , 79% He
169	HeOx30	30% O ₂ , 70% He
170	HeOx40	40% O ₂ , 60% He
171	HeOx50	50% O ₂ , 50% He
172	HeOx60	60% O ₂ , 40% He

Short #	Short Name	Long Name
173	HeOx80	80% O ₂ , 20% He
174	HeOx99	99% O ₂ , 1% He
175	EA-40	Enriched Air-40% O ₂
176	EA-60	Enriched Air-60% O ₂
177	EA-80	Enriched Air-80% O ₂
178	Metab	Metabolic Exhalant (16% O ₂ , 78.04% N ₂ , 5% CO ₂ , 0.96% Ar)
179	LG-4.5	4.5% CO ₂ , 13.5% N ₂ , 82% He
180	LG-6	6% CO ₂ , 14% N ₂ , 80% He
181	LG-7	7% CO ₂ , 14% N ₂ , 79% He
182	LG-9	9% CO ₂ , 15% N ₂ , 76% He
183	HeNe-9	9% Ne, 91% He
184	LG-9.4	9.4% CO ₂ , 19.25% N ₂ , 71.35% He
185	SynG-1	40% H ₂ , 29% CO, 20% CO ₂ , 11% CH ₄
186	SynG-2	64% H ₂ , 28% CO, 1% CO ₂ , 7% CH ₄
187	SynG-3	70% H ₂ , 4% CO, 25% CO ₂ , 1% CH ₄
188	SynG-4	83% H ₂ , 14% CO, 3% CH ₄
189	NatG-1	93% CH ₄ , 3% C ₂ H ₆ , 1% C ₃ H ₈ , 2% N ₂ , 1% CO ₂
190	NatG-2	95% CH ₄ , 3% C ₂ H ₆ , 1% N ₂ , 1% CO ₂
191	NatG-3	95.2% CH ₄ , 2.5% C ₂ H ₆ , 0.2% C ₃ H ₈ , 0.1% C ₄ H ₁₀ , 1.3% N ₂ , 0.7% CO ₂
192	CoalG	50% H ₂ , 35% CH ₄ , 10% CO, 5% C ₂ H ₄
193	Endo	75% H ₂ , 25% N ₂
194	HHO	66.67% H ₂ , 33.33% O ₂
195	HD-5	LPG: 96.1% C ₃ H ₈ , 1.5% C ₂ H ₆ , 0.4% C ₃ H ₆ , 1.9% n-C ₄ H ₁₀
196	HD-10	LPG: 85% C ₃ H ₈ , 10% C ₃ H ₆ , 5% n-C ₄ H ₁₀
197	OCG-89	89% O ₂ , 7% N ₂ , 4% Ar
198	OCG-93	93% O ₂ , 3% N ₂ , 4% Ar
199	OCG-95	95% O ₂ , 1% N ₂ , 4% Ar
200	FG-1	2.5% O ₂ , 10.8% CO ₂ , 85.7% N ₂ , 1% Ar
201	FG-2	2.9% O ₂ , 14% CO ₂ , 82.1% N ₂ , 1% Ar
202	FG-3	3.7% O ₂ , 15% CO ₂ , 80.3% N ₂ , 1% Ar
203	FG-4	7% O ₂ , 12% CO ₂ , 80% N ₂ , 1% Ar
204	FG-5	10% O ₂ , 9.5% CO ₂ , 79.5% N ₂ , 1% Ar
205	FG-6	13% O ₂ , 7% CO ₂ , 79% N ₂ , 1% Ar
206	P-10	10% CH ₄ , 90% Ar
210	D-2	Deuterium

¹ Sulfur hexafluoride is a highly potent greenhouse gas monitored under the Kyoto Protocol.

² Corrosive-resistant units only

³ Under the Montreal Protocol and Kigali Amendment, the production and consumption of these ozone-depleting substances (ODS) is being or has been phased out. It is recommended you ensure compliance with this universally ratified treaty before attempting to use these gases, in addition to R113, R-123, and R-141b.

Gas List by Category

See previous page for Gas Select™ index numbers, or [page 13](#) to configure these gases.

Pure Non-Corrosive Gases

Acetylene (C₂H₂)
Air (clean, dry)
Argon (Ar)
Isobutane (i-C₄H₁₀)
Normal Butane (n-C₄H₁₀)
Carbon dioxide (CO₂)
Carbon monoxide (CO)
Deuterium (D₂)
Ethane (C₂H₆)
Ethylene (Ethene) (C₂H₄)
Helium (He)
Hydrogen (H₂)
Krypton (Kr)
Methane (CH₄)
Neon (Ne)
Nitrogen (N₂)
Nitrous Oxide (N₂O)
Oxygen (O₂)
Propane (C₃H₈)
Sulfur Hexafluoride (SF₆)¹
Xenon (Xe)

Breathing Gases

Metabolic Exhalant
EAN-32
EAN-36
EAN-40
EA-40
EA-60
EA-80
Heliox-20
Heliox-21
Heliox-30
Heliox-40
Heliox-50
Heliox-60
Heliox-80
Heliox-99

Bioreactor Gas Mixes

5%–95% CH₄/CO₂ in 5% increments

Refrigerants²

R-11³
R-14
R-22³
R-23³
R-32³
R-115³
R-116
R-124³
R-125³
R-134a³
R-142b³
R-143a³
R-152a
R-318
R-404A³
R-407C³
R-410A³
R-507A³

Welding Gases

C-2
C-8
C-10
C-15
C-20
C-25
C-50
C-75
He-25
He-50
He-75
He-90
A 1025
Stargon CS

Chromatography Gas Mixes

P-5
P-10

Oxygen Concentrator Gas Mixes

89% O₂, 7.0% N₂, 4.0% Ar
93% O₂, 3.0% N₂, 4.0% Ar
95% O₂, 1.0% N₂, 4.0% Ar

Stack/Flue Gas Mixes

2.5% O₂, 10.8% CO₂, 85.7% N₂, 1.0% Ar
2.9% O₂, 14% CO₂, 82.1% N₂, 1.0% Ar
3.7% O₂, 15% CO₂, 80.3% N₂, 1.0% Ar
7.0% O₂, 12% CO₂, 80% N₂, 1.0% Ar
10% O₂, 9.5% CO₂, 79.5% N₂, 1.0% Ar
13% O₂, 7.0% CO₂, 79% N₂, 1.0% Ar

Laser Gas Mixes

4.5% CO₂, 13.5% N₂, 82% He
6.0% CO₂, 14% N₂, 80% He
7.0% CO₂, 14% N₂, 79% He
9.0% CO₂, 15% N₂, 76% He
9.4% CO₂, 19.25% N₂, 71.35% He
9.0% Ne, 91% He

Fuel Gas Mixes

Coal Gas 50% H₂, 35% CH₄, 10% CO, 5% C₂H₄
Endothermic Gas 75% H₂, 25% N₂
HHO 66.67% H₂, 33.33% O₂
LPG HD-5 96.1% C₃H₈, 1.5% C₂H₆, 0.4% C₃H₆, 1.9% n-C₄H₁₀
LPG HD-10 85% C₃H₈, 10% C₃H₆, 5% n-C₄H₁₀

Natural Gases

93.0% CH₄, 3.0% C₂H₆, 1.0% C₃H₈, 2.0% N₂, 1.0% CO₂
95.0% CH₄, 3.0% C₂H₆, 1.0% N₂, 1.0% CO₂
95.2% CH₄, 2.5% C₂H₆, 0.2% C₃H₈, 0.1% C₄H₁₀, 1.3% N₂, 0.7% CO₂

Synthesis Gases

40% H₂, 29% CO, 20% CO₂, 11% CH₄
64% H₂, 28% CO, 1.0% CO₂, 7.0% CH₄
70% H₂, 4.0% CO, 25% CO₂, 1.0% CH₄
83% H₂, 14% CO, 3.0% CH₄

Pure Corrosive Gases²

Ammonia (NH₃)
Butylene (1-Buten)
Cis-Butene (c-Buten)
Isobutene (i-Buten)
Trans-Butene (t-Buten)
Carbonyl Sulfide (COS)
Chlorine (Cl₂)
Dimethylether (DME)
Hydrogen Sulfide (H₂S)
Nitrogen Trifluoride (NF₃)
Nitric Oxide (NO)
Propylene (C₃H₆)
Silane (SiH₄)
Sulfur Dioxide (SO₂)

¹ Sulfur hexafluoride is a highly potent greenhouse gas monitored under the Kyoto Protocol.

² Corrosive-resistant units only

³ Under the Montreal Protocol and Kigali Amendment, the production and consumption of these ozone-depleting substances (ODS) is being or has been phased out. It is recommended you ensure compliance with this universally ratified treaty before attempting to use these gases, in addition to R113, R-123, and R-141b.

Pinouts

Check the calibration data sheet and pinout for your device.

See [page 18](#) for additional important information about connecting your device to a computer for serial commands.

8-Pin Mini-DIN (Default)

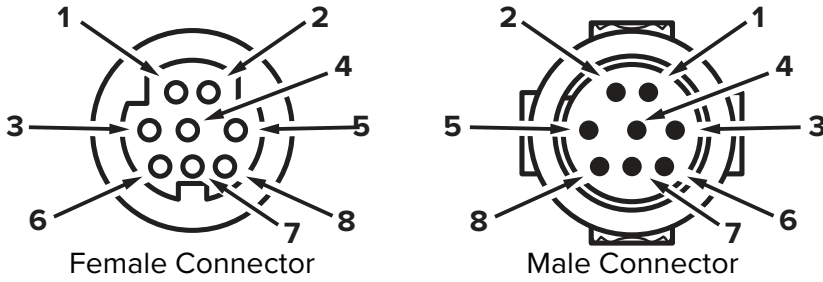

Pin	Function
1	Not Connected <i>Optional: 4–20 mA primary output signal</i>
2	Static 5.12 Vdc <i>Optional: secondary analog output (4–20 mA, 0–5 Vdc, 1–5 Vdc, 0–10 Vdc) or basic alarm</i>
3	Serial RS-232RX Input Signal <i>Optional: RS-485 A</i>
4	Remote tare (ground to tare)
5	Serial RS-232TX Output Signal <i>Optional: RS-485 B</i>
6	0–5 Vdc Analog Out <i>Optional: 1–5 Vdc or 0–10 Vdc output signal</i>
7	Power In
8	Ground (common for power, digital communications, analog signals, and alarms)

Warning: Do not connect power to pins 1 through 6, as permanent damage can occur. It is common to mistake pin 2 (labeled 5.12 Vdc Output) as the standard 0–5 Vdc analog output signal. Pin 2 is normally a constant 5.12 Vdc.

Locking Industrial Connector Pinout

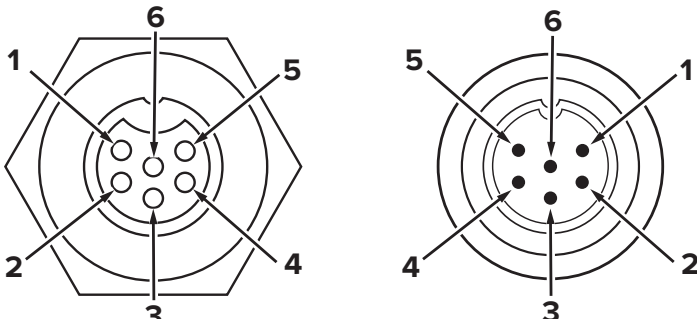

Pin	Function
1	Power In (+)
2	RS-232TX / RS-485 B
3	RS-232RX / RS-485 A
4	Remote tare (ground to tare)
5	Ground (common for power, communications, and signals)
6	Analog Out (voltage or current as ordered)

Note: The availability of different output signals depend on the options ordered.

9-Pin D-Sub Connector Common Pinouts

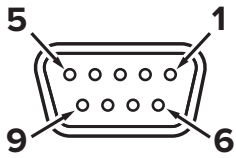

Female Connector

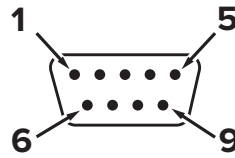

Male Connector

Pin	DB9 (F) DB9M (M)	DB9A and DB9K	DB9R	DB9T	DB9U	DB9B	DB9G	DB9H	DB9I	DB9N
1	Current Out	NC	TX or B	TX or B	RX or A	Analog Out 2	RX or A	TX or B	NC	Power In
2	Analog Out 2	Analog Out	Analog Out	Analog Out	Analog Out	Analog Out	Analog Out	Analog Out	Analog Out	Analog In
3	RX or A	Power In	Analog In	Power In	Power In	Power In	Ground	Analog In	Power In	Analog Out
4	Analog In	Ground	Ground	Ground	Ground	Ground	Power In	RX or A	Ground	NC
5	TX or B	TX or B	NC	NC	NC	Ground	Ground	Analog Out 2	NC	Ground
6	Analog Out	Analog In	RX or A	Analog In	Analog In	Analog In	TX or B	NC	Analog In	Ground
7	Power In	Ground	Power In	Ground	Ground	Ground	Analog In	Power In	Ground	RX or A
8	Ground	Ground	Ground	Ground	Ground	TX or B	Current Out	Ground	RX or A	TX or B
9	Ground	RX or A	Ground	RX or A	TX or B	RX or A	Ground	Ground	TX or B	NC5

15-Pin D-Sub Connector Common Pinouts

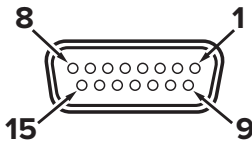

Female Connector

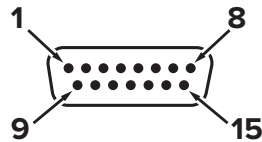

Male Connector

Pin	DB15	DB15A	DB15B	DB15H	DB15K	DB15O	DB15S
1	Ground	Ground	Ground	NC	NC	Ground	Ground
2	Analog Out	Analog Out	Analog Out	RX or A	Analog Out	NC	Analog Out
3	Ground	Analog In	NC	NC	NC	NC	NC
4	NC	Ground	NC	NC	NC	Analog Out	NC
5	Power In	Ground	Power In	Ground	Ground	Power In	Ground
6	NC	Ground	NC	Analog Out	NC	NC	NC
7	NC	Power In	NC	Ground	Power In	Analog In	NC
8	Analog In	TX or B	Analog In	NC	Analog In	NC5	Analog In
9	Ground	Ground	Ground	NC	Analog Out 2	Ground	Ground
10	Ground	NC	Ground	Analog Out 2	NC	Ground	Ground
11	Analog Out 2	NC	Analog Out 2	Power In	Ground	Analog Out 2	Analog Out 2
12	NC	Analog Out 2	NC	Ground	Ground	NC	RX or A
13	RX or A	NC	NC	NC	RX or A	NC	Power In
14	Ground	NC	RX or A	Analog In	TX or B	RX or A	TX or B
15	TX or B	RX or A	TX or B	TX or B	Ground	TX or B	Ground

Key of Terms:

Analog In

Remote tare (ground to tare)

Analog Out

0–5 Vdc output signal
(1–5, 0–10 Vdc optional)

Analog Out 2

5.12 Vdc or optional secondary
analog output

Current Out

Not connected

NC Not connected

Power In (+Vdc)

RX or A

Serial RS-232RX or RS-485 A

TX or B

Serial RS-232TX or RS-485 B

Ground

Common for power, digital
communications, analog signals, alarms

M12 Connector Common Pinouts

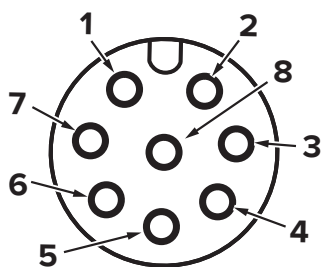

Female Connector

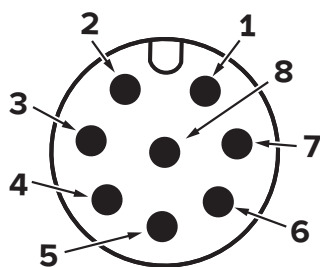

Male Connector

Pin	M12	M12MD
1	0–5 Vdc Output Signal <i>Optional: 1–5 or 0–10 Vdc</i>	Not Connected <i>Optional: 4–20 mA primary output signal</i>
2	Power In	Static 5.12 Vdc <i>Optional: Secondary analog output (4–20 mA, 0–5 Vdc, 1–5 Vdc, 0–10 Vdc) or basic alarm</i>
3	Serial RS-232 RX signal <i>Optional: RS-485 A</i>	Serial RS-232 RX Signal <i>Optional: RS-485 A</i>
4	Remote tare (ground to tare)	Remote tare (ground to tare)
5	Serial RS-232 TX signal <i>Optional: RS-485 B</i>	Serial RS-232 TX Signal <i>Optional: RS-485 B</i>
6	Static 5.12 Vdc <i>Optional: Secondary analog output (4–20 mA, 0–5 Vdc, 1–5 Vdc, 0–10 Vdc) or basic alarm</i>	0–5 Vdc Output Signal <i>Optional: 1–5 or 0–10 Vdc</i>
7	Ground (common for power, digital communications, analog signals, and alarms)	Power in
8	Inactive <i>Optional: 4–20 mA primary output signal</i>	Ground (common for power, digital communications, analog signals, and alarms)

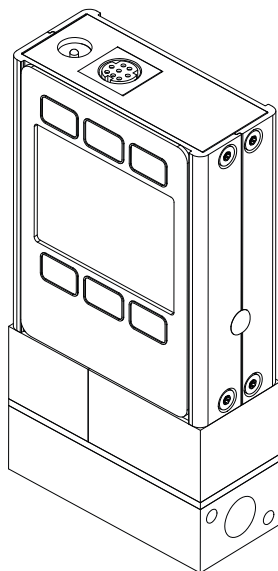

Ω OMEGA™

WARRANTY/DISCLAIMER

OMEGA ENGINEERING, INC. warrants this unit to be free of defects in materials and workmanship for a period of **13 months** from date of purchase. OMEGA's WARRANTY adds an additional one (1) month grace period to the normal **one (1) year product warranty** to cover handling and shipping time. This ensures that OMEGA's customers receive maximum coverage on each product.

If the unit malfunctions, it must be returned to the factory for evaluation. OMEGA's Customer Service Department will issue an Authorized Return (AR) number immediately upon phone or written request. Upon examination by OMEGA, if the unit is found to be defective, it will be repaired or replaced at no charge. OMEGA's WARRANTY does not apply to defects resulting from any action of the purchaser, including but not limited to mishandling, improper interfacing, operation outside of design limits, improper repair, or unauthorized modification. This WARRANTY is VOID if the unit shows evidence of having been tampered with or shows evidence of having been damaged as a result of excessive corrosion; or current, heat, moisture or vibration; improper specification; misapplication; misuse or other operating conditions outside of OMEGA's control. Components in which wear is not warranted, include but are not limited to contact points, fuses, and triacs.

OMEGA is pleased to offer suggestions on the use of its various products. However, OMEGA neither assumes responsibility for any omissions or errors nor assumes liability for any damages that result from the use of its products in accordance with information provided by OMEGA, either verbal or written. OMEGA warrants only that the parts manufactured by the company will be as specified and free of defects. OMEGA MAKES NO OTHER WARRANTIES OR REPRESENTATIONS OF ANY KIND WHATSOEVER, EXPRESSED OR IMPLIED, EXCEPT THAT OF TITLE, AND ALL IMPLIED WARRANTIES INCLUDING ANY WARRANTY OF MERCHANTABILITY AND FITNESS FOR A PARTICULAR PURPOSE ARE HEREBY DISCLAIMED. LIMITATION OF LIABILITY: The remedies of purchaser set forth herein are exclusive, and the total liability of OMEGA with respect to this order, whether based on contract, warranty, negligence, indemnification, strict liability or otherwise, shall not exceed the purchase price of the component upon which liability is based. In no event shall OMEGA be liable for consequential, incidental or special damages.

CONDITIONS: Equipment sold by OMEGA is not intended to be used, nor shall it be used: (1) as a "Basic Component" under 10 CFR 21 (NRC), used in or with any nuclear installation or activity; or (2) in medical applications or used on humans. Should any Product(s) be used in or with any nuclear installation or activity, medical application, used on humans, or misused in any way, OMEGA assumes no responsibility as set forth in our basic WARRANTY/DISCLAIMER language, and, additionally, purchaser will indemnify OMEGA and hold OMEGA harmless from any liability or damage whatsoever arising out of the use of the Product(s) in such a manner.

RETURN REQUESTS/INQUIRIES

Direct all warranty and repair requests/inquiries to the OMEGA Customer Service Department. BEFORE RETURNING ANY PRODUCT(S) TO OMEGA, PURCHASER MUST OBTAIN AN AUTHORIZED RETURN (AR) NUMBER FROM OMEGA'S CUSTOMER SERVICE DEPARTMENT (IN ORDER TO AVOID PROCESSING DELAYS). The assigned AR number should then be marked on the outside of the return package and on any correspondence.

The purchaser is responsible for shipping charges, freight, insurance and proper packaging to prevent breakage in transit.

FOR **WARRANTY** RETURNS, please have the following information available BEFORE contacting OMEGA:

1. Purchase Order number under which the product was PURCHASED,
2. Model and serial number of the product under warranty, and
3. Repair instructions and/or specific problems relative to the product.

FOR **NON-WARRANTY** REPAIRS, consult OMEGA for current repair charges. Have the following information available BEFORE contacting OMEGA:

1. Purchase Order number to cover the COST of the repair,
2. Model and serial number of the product, and
3. Repair instructions and/or specific problems relative to the product.

OMEGA's policy is to make running changes, not model changes, whenever an improvement is possible. This affords our customers the latest in technology and engineering.

OMEGA is a trademark of OMEGA ENGINEERING, INC.

© Copyright 2019 OMEGA ENGINEERING, INC. All rights reserved. This document may not be copied, photocopied, reproduced, translated, or reduced to any electronic medium or machine-readable form, in whole or in part, without the prior written consent of OMEGA ENGINEERING, INC.

Where Do I Find Everything I Need for Process Measurement and Control? **OMEGA...Of Course!** *Shop online at omega.com*

TEMPERATURE

- Thermocouple, RTD & Thermistor Probes, Connectors, Panels & Assemblies
- Wire: Thermocouple, RTD & Thermistor
- Calibrators & Ice Point References
- Recorders, Controllers & Process Monitors
- Infrared Pyrometers

PRESSURE, STRAIN AND FORCE

- Transducers & Strain Gages
- Load Cells & Pressure Gages
- Displacement Transducers
- Instrumentation & Accessories

FLOW/LEVEL

- Rotameters, Gas Mass Flowmeters & Flow Computers
- Air Velocity Indicators
- Turbine/Paddlewheel Systems
- Totalizers & Batch Controllers

pH/CONDUCTIVITY

- pH Electrodes, Testers & Accessories
- Benchtop/Laboratory Meters
- Controllers, Calibrators, Simulators & Pumps
- Industrial pH & Conductivity Equipment

DATA ACQUISITION

- Communications-Based Acquisition Systems
- Data Logging Systems
- Wireless Sensors, Transmitters, & Receivers
- Signal Conditioners
- Data Acquisition Software

HEATERS

- Heating Cable
- Cartridge & Strip Heaters
- Immersion & Band Heaters
- Flexible Heaters
- Laboratory Heaters

ENVIRONMENTAL MONITORING AND CONTROL

- Metering & Control Instrumentation
- Refractometers
- Pumps & Tubing
- Air, Soil & Water Monitors
- Industrial Water & Wastewater Treatment
- pH, Conductivity & Dissolved Oxygen Instruments