

**5 YEAR**  
WARRANTY



**RoHS**



**PLATINUM™**  **Series**



# **Ω OMEGA™** **User's Guide**

## **CS8DPT/CS8EPT** **Universal Benchtop** **Digital Controller**

**Ω OMEGA™**

Omega.com info@omega.com

**Servicing North America:**

**U.S.A.:**

**Omega Engineering, Inc.**

**Toll-Free: 1-800-826-6342 (USA & Canada only)**

**Customer Service: 1-800-622-2378 (USA & Canada only)**

**Engineering Service: 1-800-872-9436 (USA & Canada only)**

**Tel: (203) 359-1660 Fax: (203) 359-7700**

**e-mail: info@omega.com**

**For Other Locations Visit [omega.com/worldwide](http://omega.com/worldwide)**

The information contained in this document is believed to be correct, but OMEGA accepts no liability for any errors it contains, and reserves the right to alter specifications without notice.

## TABLE OF CONTENTS

<b>1 INTRODUCTION</b> .....	<b>3</b>
1.1 Safety and Precautions .....	3
1.2 Cautions and IEC Symbols .....	3
1.3 Statement on CE Marking .....	3
1.4 Available Models.....	3
1.5 Communication Options .....	4
1.6 Reference Manuals .....	4
<b>2 UNPACKING</b> .....	<b>4</b>
2.1 Inspection.....	4
2.2 Power Cords.....	5
<b>3 HARDWARE SETUP</b> .....	<b>5</b>
3.1 Front Panel.....	5
3.2 10-PIN Connector Wiring Diagrams .....	6
3.3 Universal Thermocouple Connector .....	7
3.4 Rear Panel .....	8
3.5 Isolated Analog Output .....	8
<b>4 CONFIGURATION AND PROGRAMMING</b> .....	<b>9</b>
4.1 PLATINUM Series Navigation .....	9
4.2 Selecting an Input (INIt>INPt) .....	10
4.3 Set the Setpoint 1 Value (PRoG > SP1).....	10
4.4 Set up the Control Output .....	11
4.4.1 Select an Output Channel (PRoG > StR1/dC1/IAN1) .....	11
4.5 On/Off Control Mode (PRoG > {Output} > ModE > oN.oF).....	11
4.6 PID Control .....	12
4.6.1 PID Configuration (PRoG > PId.S) .....	12
4.6.2 Follow these steps to run an Autotune procedure:.....	12
4.7 Retransmission Using the Analog Output .....	13
4.7.1 Select an Output Type.....	13
4.7.2 Set Mode to Retransmission .....	13
4.7.3 Set Scaling .....	13
<b>5 SPECIFICATIONS</b> .....	<b>14</b>
<b>6 MAINTENANCE</b> .....	<b>15</b>
6.1 Cleaning.....	15
6.2 Calibration.....	15
6.3 Fuse Specifications and Replacement.....	15

## 1 INTRODUCTION

The Platinum™ Series Universal Benchtop Digital Controller, is ideal for laboratory and other applications requiring portable, temperature, process or strain, measurement and control. It features a universal input which reads most temperature, process and bridge type inputs. The Benchtop Digital Controller has excellent accuracy and is factory calibrated to give optimum performance over its full operating range.

### 1.1 Safety and Precautions



It is important to read and follow all precautions and instructions in this manual and other referenced manuals, before operating or commissioning this device, as it contains important information relating to safety and EMC.

- Do not exceed the voltage rating.
- Always disconnect the power before changing the signal and power connections.
- Do not operate in flammable or explosive environments.
- Never operate with a power cord that is not properly rated for use with this unit.
- Remove and or disconnect main power cord before attempting any maintenance or fuse replacement.
- Do not connect and/or operate this unit to a non-grounded or non-polarized outlet or power source.

**Note** There are no user serviceable parts inside the unit. Attempting to repair or service the unit may void the warranty.  
This product is not designed for medical applications.

### 1.2 Cautions and IEC Symbols

This device is marked with international safety and hazard symbols shown in the table below, in accordance with 2014/35/EU Low Voltage Directive. It is important to read and follow all precautions and instructions in this manual before operating or commissioning this device as it contains important information relating to safety and EMC. Failure to follow all safety precautions may result in injury and/or damage to the controller. Use of this device in a manner not specified by the manufacturer may impair protection devices and safety features provided by the unit.

IEC Symbol	Description
	<b>CAUTION</b> , risk of electrical shock
	<b>CAUTION</b> , refer to accompanying documents

### 1.3 Statement on CE Marking

OMEGA's policy is to comply with all worldwide safety and EMI/EMC regulations that apply to CE Certification standards, including **EMC Directive** 2014/30/EU Low Voltage Directive (Safety) Directive 2014/35/EU, and **EEE RoHS II Directive** 2011/65/EU. OMEGA is constantly pursuing certification of its products to the European New Approach Directives. OMEGA will add the marking to every applicable device upon verification of compliance.

### 1.4 Available Models

Model	Features
<b>CS8DPT-C24-EIP-A</b>	Benchtop Controller with 4-Digit Display, Embedded Ethernet, Serial Communication, and Isolated Analog Output
-EIP	Ethernet
-C24	Isolated RS232 and RS485
-A	Isolated Analog Output
<b>CS8DPT</b>	Benchtop Controller, Universal input with 4-Digit Display
<b>CS8EPT</b>	Benchtop Controller, Universal input with 6-Digit Display
<b>CS8EPT-C24-EIP-A</b>	Benchtop Controller with 6-Digit Display, Embedded Ethernet, Serial Communication, and Isolated Analog Output

## 1.5 Communication Options

The Platinum Series Benchtop Digital Controller comes with a USB port standard. Optional Serial and Ethernet connectivity is also available. All communication channels can be used with the Omega Platinum Configurator software and support both the Omega ASCII protocol and the Modbus Protocol. Refer to the Reference Manuals below for supporting documentation. The Platinum Configurator software (**M5461**), user manuals and more are available from the [Omega website](#).

## 1.6 Reference Manuals

Number	Title
<a href="#">M5461</a>	Platinum Series Configurator Software Manual
<a href="#">M5451</a>	Platinum Series Temperature and Process Controllers Manual
<a href="#">M5452</a>	Serial Communication Protocol Manual
<a href="#">M5458</a>	Platinum Series User Manual - Modbus Interface

## 2 UNPACKING

Read the packing list, it is important to verify all equipment shipped has been delivered as shown in **Figure 1** and **Table 1**. If there are any questions about the shipment, please email or call the Customer Service Department listed in this manual.

### 2.1 Inspection

Inspect the shipment container and equipment for any signs of damage. Record any evidence of rough handling in transit and report any damage immediately to the shipping agent.

**Note** Save packaging material and carton in the event that returns are necessary. The carrier will not honor any damage claims unless all original shipping material is saved for inspection.

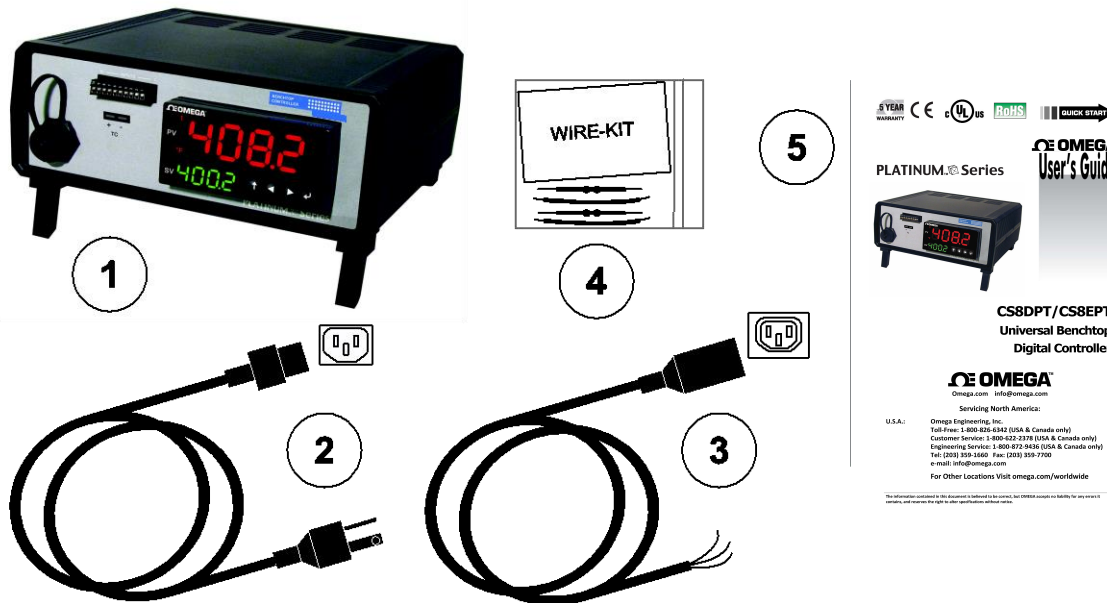

**Figure 1. Accessories Packaged with CS8DPT/CS8EPT Unit.**

**Table 1. Packing Contents.**

Item	Name	Description
1	Unit	Universal Benchtop Digital Controller
2	Power Cord	AC Power Cord (Ordered Separately; Refer to <b>Table 2</b> )
3	Output Cord	Output Cords for Wiring Equipment (QTY 2)
4	Wire Kit	Accessories for RTD and Bridge Inputs
5	Guide	MQS5451 (Quick Start Guide)

## 2.2 Power Cords

Electrical power is delivered to the Benchtop Digital Controller by an AC power cord which plugs into the IEC 60320 C-13 power socket located on the rear panel of the unit. Refer to

**Figure 7** for detailed connections.



The input power is fused on the Line terminal.  
Output connectors are fused on the Line terminal.

The Benchtop Digital Controller operates from 90 to 240 VAC @ 50-60 Hz. A main power cord may be ordered with the unit. Select the appropriate power cord for your region from **Table 2**.

**Table 2. Power Cords**

PWR Cord Type	Part Number	PWR Rating
United Kingdom, Ireland	Power Cord-UK	240V
Denmark	Power Cord-DM	230V, 16A
USA, Canada, Mexico	Power Cord-Molded	120V
Italy	Power Cord-IT	230V, 16A
Continental Europe	Power Cord E-10A	240V, 10A
Europe	Power Cord E-16A	240V, 16A

## 3 HARDWARE SETUP

This section details the parts of the Benchtop Controller and includes wiring diagrams to connect common inputs.

### 3.1 Front Panel

The controls, indicators and input connections of the Benchtop Digital Controller are located on the front of the controller as shown in **Figure 2**.

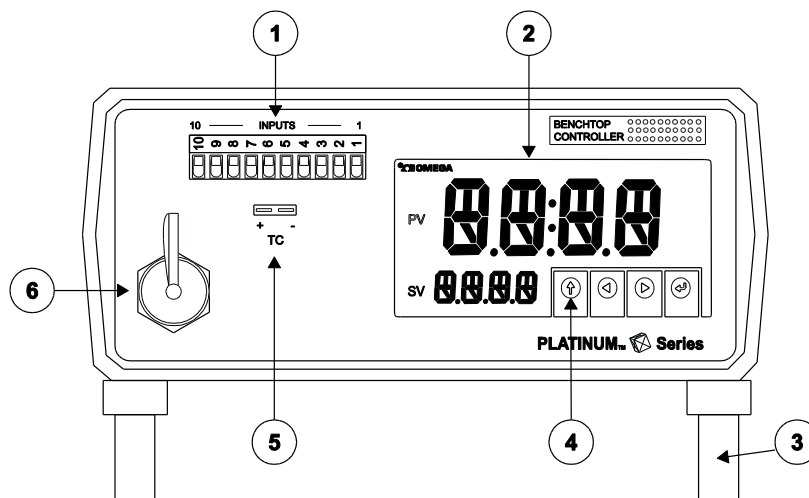

**Figure 2. Front Panel.** (Not to scale)

**Table 3. Front Panel Components List.**

Item	Name	Description
1	10-Pin Input Connector	Process, Strain, RTD and Thermistor Inputs
2	Display	Four-digit, three-color, LED Display
3	Adjustable Feet	Adjusts viewing angle
4	Push Buttons	Menu Navigation
5	Thermocouple Input	Miniature Thermocouple Connector input
6	USB Port	USB Port, Type A Female

### 3.2 10-PIN Connector Wiring Diagrams

The 10-pin universal input connector pin assignments are summarized in **Table 4**.

**Table 4. 10-Pin Input Connector Wiring**

Pin No.	Code	Description
1	ARTN	Analog return signal (analog ground) for sensors and remote Setpoint
2	AIN+	Analog positive input
3	AIN-	Analog negative input
4	APWR	Analog power reference
5	AUX	Auxiliary analog input for remote Setpoint
6	EXCT	Excitation voltage output referenced to ISO GND
7	DIN	Digital input signal (latch reset, etc.), Positive at > 2.5V, ref. to ISO GND
8	ISO GND	Isolated ground for serial communications, excitation, and digital input
9	RX/A	Serial communications receive
10	TX/B	Serial communications transmit

**Table 5** summarizes the universal input pin assignments for different sensor inputs. All sensor selections are firmware-controlled and no jumper settings are required when switching from one type of sensor to another.

**Table 5. Sensor Pin Assignments**

Pin	Diff Voltage	Process Voltage	Process Current	2-Wire RTD	3-Wire RTD	4-Wire RTD	Thermistor	Remote <sup>(1)</sup> Setpoint
1	Vref - <sup>(2)</sup>	Rtn		<sup>(3)</sup>	RTD2-	RTD2+		Rtn
2	Vin +	Vin +/-	I+	RTD1+	RTD1+	RTD1+	TH+	
3	Vin -		I-			RTD2-	TH-	
4	Vref + <sup>(2)</sup>			RTD1-	RTD1-	RTD1-		
5								V/I In

<sup>(1)</sup> Remote Setpoint cannot be used with RTD inputs.

<sup>(2)</sup> Reference voltage required for Ratio-metric mode only.

<sup>(3)</sup> 2 Wire RTD Requires external connection of Pin 1 and Pin 4.

**Figure 3** shows the wiring diagram for connecting RTD sensors. For 2 wire RTD sensors use a jumper wire, included in the provided wire kit, to connect pins 1 and 4.

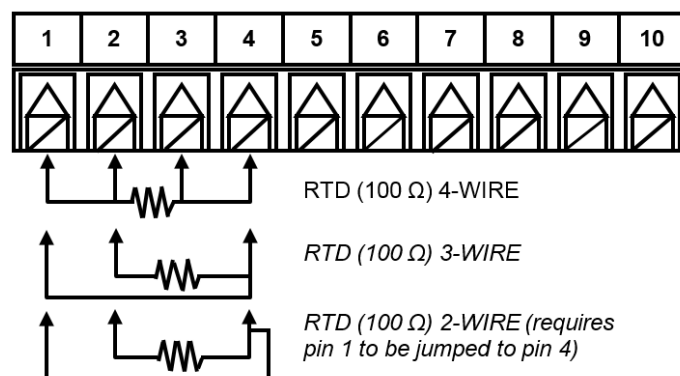

**Figure 3. RTD Wiring Diagram**

**Figure 4** shows the wiring diagram for the process current input using either internal or external excitation. The benchtop unit provides 5V excitation by default and can also output 10V, 12V or 24V excitation voltages. Refer to the Platinum Series User's Manual ([M5451](#)) for more information on selecting the excitation voltage.

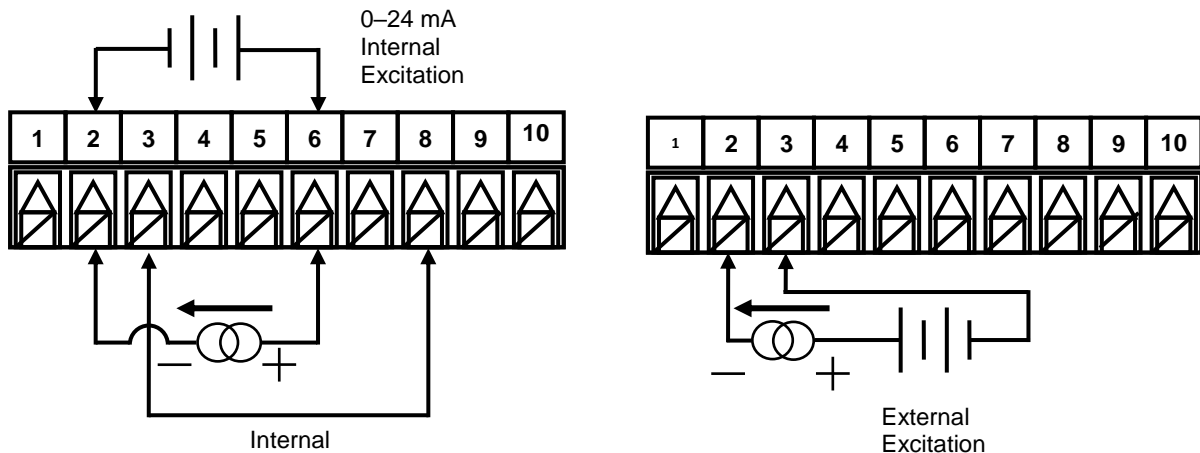

**Figure 4. 4-20 mA Sensor Wiring Diagram.**

**Figure 5** shows the wiring for ratio-metric bridge inputs. Connect the resistors R1 and R2, included in the provided Wire Kit, across terminals 4 and 6 and terminals 1 and 8 respectively. This allows the Bridge voltage to be measured.

When powering a bridge from the unit use an internal excitation voltage of either 5V or 10V. External excitation may also be used but must be kept between 3V and 10V and be ground isolated from the unit.

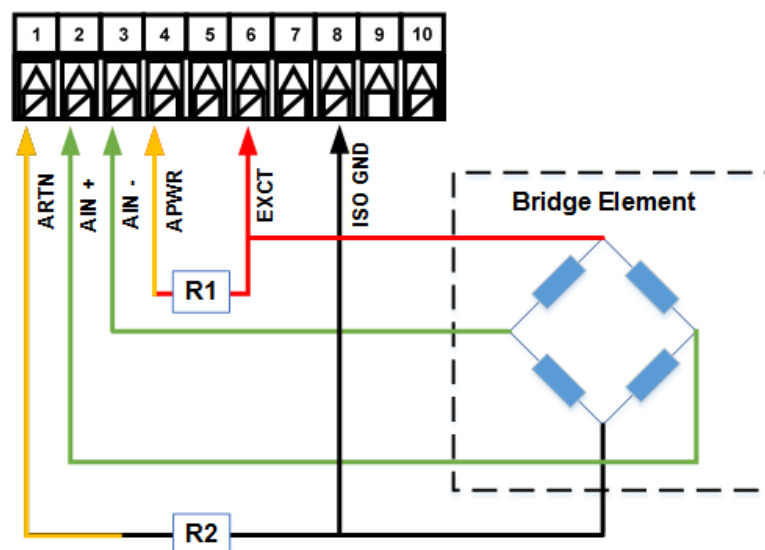

**Figure 5. Bridge Wiring Diagram.**

### 3.3 Universal Thermocouple Connector

The Benchtop Digital Controller accepts miniature thermocouple connectors. Ensure the polarity of the connector is correct as indicated in **Figure 6**. The wide terminal of the miniature connector is negative.

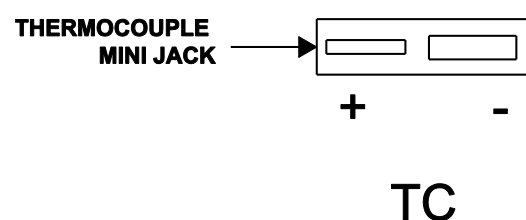

**Figure 6. Thermocouple Input.**

### 3.4 Rear Panel

The power, fuses and outputs are located on the rear panel of the Benchtop Digital Controller. The optional Ethernet port is also located at the rear of the unit.

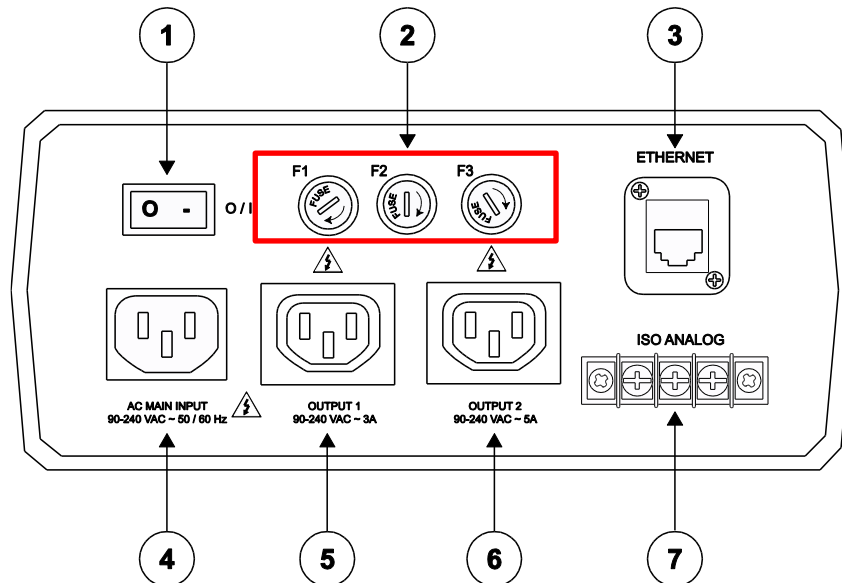

Figure 7. Rear Panel. (Not to scale)

Table 6. Rear Panel Components List.

Item	Name	Description
1	ON/OFF Switch	
2	AC Power Fuses	90 to 240 Vac, 50/60 Hz, Time Lag
	F1 (Fuse)	Protects the AC power input
	F2 (Fuse)	Protects Output 1
	F3 (Fuse)	Protects Output 2
3	Ethernet Port (RJ45)	10/100Base-T (Optional)
4	AC Main Input Plug	IEC60320 C13, Power Socket. 90 to 240 Vac, 50/60 Hz
5	Output 1	Relay Output, 90-240 VAC ~ 3A Max
6	Output 2	SSR Output, 90-240 VAC ~ 5A Max
7	Isolated Analog Terminal	0-10V or 0-24mA Output (Optional)



Single Phase AC Input Only. Neutral line is not fused or switched.  
Outputs 1 and 2 are sourced directly from the Main AC Input.

### 3.5 Isolated Analog Output

Table 7 shows the wiring of the optional Isolated Analog Output terminals.

Table 7. Analog Output Terminals.

Terminal	Description
1	Analog Output
2	Not Connected
3	Analog Return

0-24mA OUTPUT SOURCE  
0-10V OUTPUT SOURCE

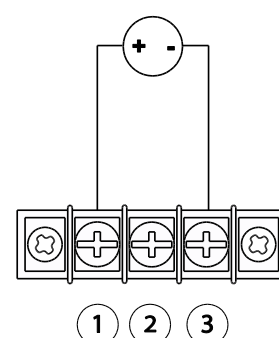

Figure 8. Analog Output Terminals



## 4 CONFIGURATION AND PROGRAMMING

This section outlines the initial programming and configuration of the Benchtop Digital Controller. It gives a brief outline on how to setup the inputs and outputs, and how to configure the setpoint and control modes. Refer to the Platinum Series User’s Manual ([M5451](#)) for more detailed information on all the controller’s functions.

### 4.1 PLATINUM Series Navigation

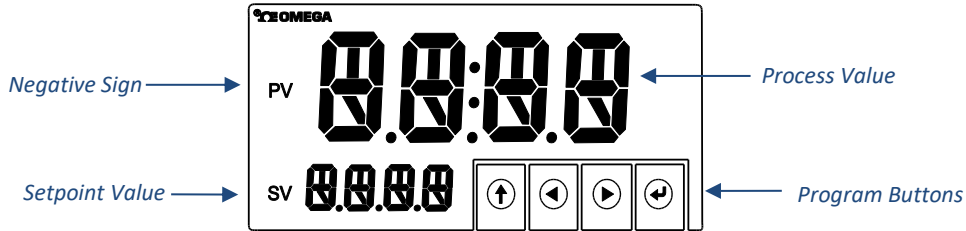





Figure 9. Example of CS8DPT Series Display.

#### Description of Button Actions

-  The **UP** button moves up a level in the menu structure. Pressing and holding the UP button navigates to the top level of any menu (**oPER**, **PRoG**, or **INIt**). This can be useful if you get lost in the menu structure.
-  The **LEFT** button moves across a set of menu choices at a given level. When changing numerical settings, press the LEFT button to make the next digit (one digit to the left) active.
-  The **RIGHT** button moves across a set of menu choices at a given level. The RIGHT button also scrolls numerical values up with overflow to 0 for the flashing digit selected.
-  The **ENTER** button selects a menu item and goes down a level, or it saves a numerical value or parameter choice.

#### Level 1 Menu

- INIt** **Initialization Mode:** These settings are rarely changed after initial setup. They include transducer types, calibration, etc. These settings can be password-protected.
- PRoG** **Programming Mode:** These settings are frequently changed. They include Set points, Control Modes, Alarms, etc. These settings can be password-protected.
- oPER** **Operating Mode:** This mode allows users to switch between Run Mode, Standby Mode, Manual Mode, etc.

Figure 10 shows how to use the LEFT and RIGHT buttons to navigate around a menu.

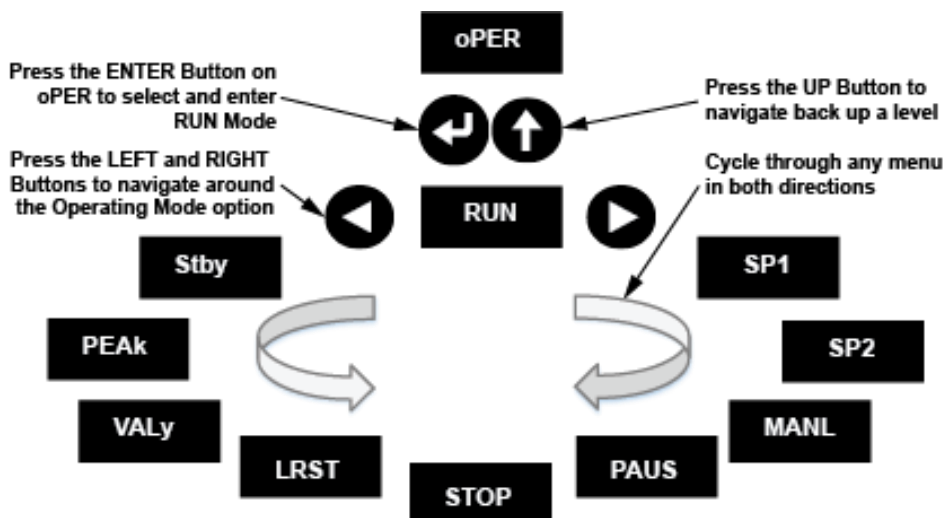

Figure 10. Circular Menu Flow.

## 4.2 Selecting an Input (INIt>INPt)

The Benchtop Digital Controller features a Universal Input. The input type is selected in the Initialization Menu. Select the input type by navigating to the Input sub-menu (INIt>INPt). Available Input types are shown in **Table 8**.



**Table 8. Input Menu.**

Level 2	Level 3	Level 4	Level 5	Level 6	Level 7	Description
INPt	t.C.	k				Type K thermocouple
		J				Type J thermocouple
		t				Type T thermocouple
		E				Type E thermocouple
		N				Type N thermocouple
		R				Type R thermocouple
		S				Type S thermocouple
		b				Type B thermocouple
		C				Type C thermocouple
	Rtd	N.wIR	3 wl			3-wire RTD
			4 wl			4-wire RTD
			2 wl			2-wire RTD
		A.CRV	385.1			385 calibration curve, 100 Ω
			385.5			385 calibration curve, 500 Ω
			385.t			385 calibration curve, 1000 Ω
			392			392 calibration curve, 100 Ω
			3916			391.6 calibration curve, 100 Ω
	tHRM	2.25k				2250 Ω thermistor
		5k				5000 Ω thermistor
		10k				10,000 Ω thermistor
	PRoC	4–20				Process input range: 4 to 20 mA
The Manual and Live Scaling submenus are the same for all process ranges.						
		MANL	Rd.1	___		Low display reading
			IN.1	___		Manual input for Rd.1
			Rd.2	___		High display reading
			IN.2	___		Manual input for Rd.2
		LIVE	Rd.1	___		Low display reading
			IN.1	___		Live Rd.1 input, ENTER for current
			Rd.2	___		High display reading
			IN.2	___		Live Rd.2 input, ENTER for current
		0–24				Process input range: 0 to 24 mA
		+10				Process input range: -10 to +10 V
		+1				Process input range: -1 to +1 V
The Type selection submenu is available for 1V, 100mV and 50mV ranges.						
		tYPE	SNGL*			Ground Referenced to Rtn
			dIFF			Differential between AIN+ and AIN-
			RtLO			Ratiometric between AIN+ and AIN-
		+0.1				Process input range: -100 to +100 mV
		+0.05				Process input range: -50 to +50 mV

\*SNGL selection not available for +/-0.05V range.

## 4.3 Set the Setpoint 1 Value (PRoG > SP1)

Setpoint 1 is the main setpoint used for control and is displayed on the front of the unit. The unit will try to maintain the input value at the setpoint using the selected outputs.

In the program menu, using the return  button, select the **SP1** parameter. Use left  and right  buttons to set the process goal value for **PID** and **oN.oF** control modes.

Refer to **Section 4.5** and **Section 4.6** for more information on setting up control modes.

## 4.4 Set up the Control Output

The outputs and control parameters of the unit are set up in the Programming (**PRoG**) Menu. The unit is configured with a 3A Mechanical Relay and a 5A Solid State Relay. An optional Isolated Analog Output is also available.

### 4.4.1 Select an Output Channel (PRoG > StR1/dC1/IAN1)

In the Program Menu, navigate and select an Output Type to configure.

Menu	Output Type
<b>StR1</b>	Single Throw Mechanical Relay number 1. (Output 1)
<b>dC1</b>	DC Pulse output number 1 (Controls the 5A SSR). (Output 2)
<b>IAN1</b>	Isolated Analog output number 1 (Optional ISO Analog terminals)

Each Output Type has the following submenus:

Setting	Parameters
<b>ModE</b>	Allows the output to be set up as a control, Alarm, Retransmission, or Ramp/Soak event output; the output can also be turned off.
<b>CyCL</b>	PWM pulse width in seconds for StR1 and dC1. (PID Control Mode Only)
<b>RNGE</b>	Sets the voltage or current output range (For IAN1 only)

For safety, all outputs modes are set to **OFF** by default. To use an output, select the appropriate control mode setting from the Mode Menu. **PID** mode and **On/Off** mode can be used for process control. The other modes are event based and can be used to activate the outputs during certain events.

Setting	Parameters
<b>oFF</b>	Turn off the output channel (factory default).
<b>PId</b>	Set the output to Proportional-Integral-Derivative (PID) Control.
<b>oN.oF</b>	Set the output to On/Off Control Mode.
<b>RtRN</b>	Set up the output for Retransmission (IAN1 Only).
<b>RE.oN</b>	Turn on the output during Ramp events.
<b>SE.oN</b>	Turn on the output during Soak events.

## 4.5 On/Off Control Mode (PRoG > {Output} > ModE > oN.oF)

For simple applications On/Off control mode can be used to maintain a rough temperature. This mode can be used with either the SSR or Mechanical Relay but not with the Analog Output.

On/Off control mode turns an output On or Off based on if the process value is above or below the setpoint. In On/Off control mode the direction of control is set in the Action (**ACtn**) menu and a Deadband is set in the (**dEAd**) menu.

For **ACtn**, select the correct setting:

Setting	Parameters
<b>RVRS</b>	Reverse: Output remains <b>On</b> until (Process Value > Setpoint) then Output remains <b>Off</b> until (Process Value < Setpoint – Deadband)
<b>dRCt</b>	Direct: Output remains <b>On</b> until (Process Value < Setpoint) then Output remains <b>Off</b> until (Process Value > Setpoint + Deadband)

The Deadband represents how much the process value must revert, after reaching the setpoint, before the output will activate gain. It prevents the output from rapidly cycling on and off. Use the (**dEAd**) menu to set the desired value. The default deadband is 5.0. A deadband of zero will turn the output back on immediately after it crosses the setpoint.

## 4.6 PID Control

PID control mode is required for Ramp and Soak applications or for finer process control. For Mechanical Relay and SSR outputs, the output will be on a percentage of time based on the PID control values. The frequency of switching is determined by the (**CyCL**) parameter for each output.

For the optional analog output, the PID control changes the output to a percentage of the full scale selected in the (**RNGE**) menu.



The SSR is synchronous and can only switch ON or OFF at the 0V AC.

PID mode may cause relay chattering when used with **StR.1**. For this reason, the cycle time for **StR.1** is limited to a minimum of 1 second.

### 4.6.1 PID Configuration (PRoG > PId.S)

The PID tuning parameters must be set before PID control can be used. These parameters can either be set by hand in the (**PRoG>PId.S>GAIN**) menu or the controller can try to determine these values for you using the Autotune option.

### 4.6.2 Follow these steps to run an Autotune procedure:

1. Hook up the controller in its desired configuration with the inputs and outputs connected.
2. Set the desired Setpoint as detailed in **Section 4.3**.
3. Set the desired output to PID mode as detailed in **Section 4.4**.
4. Set the action (**ACtN**) parameter (**PRoG>PID.S>ACtn**) as detailed below.

Setting	Description
<b>RVRS</b>	Reverse: Output increases the process value
<b>dRct</b>	Direct: Output decreases the process value

5. Set the Autotune Timeout (**A.to**) parameter (**PRoG>PID.S>A.to**).
  - (**A.to**) sets the amount of time before the Autotune process gives up and times out in Minutes and Seconds (**MM.SS**). Note that slowly responding systems should have a longer time out setting.
6. Ensure the process value is stable. If the process value is changing, the Autotune will fail.
7. Select the Autotune (**AUto**) command (**PRoG>PID.S>AUto**).
  - Confirm Autotune activation. Using return button.
  - The current Process value is displayed flashing.
  - The unit optimizes the P, I, and d settings by turning the output on and measuring the input response. This may take several minutes depending on the system.
  - When the Autotune operation completes the unit displays the message “**doNE**”.
8. If Autotune fails an error code is displayed. Refer to the table below to determine the cause.

Error Code	Description
<b>E007</b>	Displays if the system does not change enough within the Autotune timeout period. Check that the output is hooked up and configured correctly or increase the timeout.
<b>E016</b>	Displays if the signal is not stable before starting an Autotune. Wait for the system to stabilize before trying to Autotune again.
<b>E017</b>	Displays if the process value is beyond the setpoint. Adjust the Setpoint or the Action.

## 4.7 Retransmission Using the Analog Output

The optional Analog Output can be configured to transmit a Voltage or current signal proportional to the Input. Select the output type in the **PRoG > IAN.1 > RNGE** menu.

For a more detailed discussion of setting up and configuring the Analog Output refer to the Platinum Series User’s Manual (**M5451**).

### 4.7.1 Select an Output Type

The scaling of input readings to output voltage or current is fully user configurable.

Type	Description
<b>0-10</b>	0 to 10 Volts (factory default)
<b>0-5</b>	0 to 5 Volts
<b>0-20</b>	0 to 20 mA
<b>4-20</b>	4 to 20 mA
<b>0-24</b>	0 to 24 mA

### 4.7.2 Set Mode to Retransmission

Enable the output by setting the mode to Retransmission (**PRoG. > IAN.1 > Mode > RtRN**).

### 4.7.3 Set Scaling

The Retransmission signal is scaled using the following 4 parameters. The unit will display the first scaling parameter, Rd1, after RtRN is selected.

Setting	Parameters
<b>Rd1</b>	Process reading 1; the process reading that corresponds to the output signal oUt1.
<b>oUt1</b>	The output signal that corresponds to the process value Rd1.
<b>Rd2</b>	Process reading 2; the process reading that corresponds to the output signal oUt2.
<b>oUt2</b>	The output signal that corresponds to the process value Rd2.

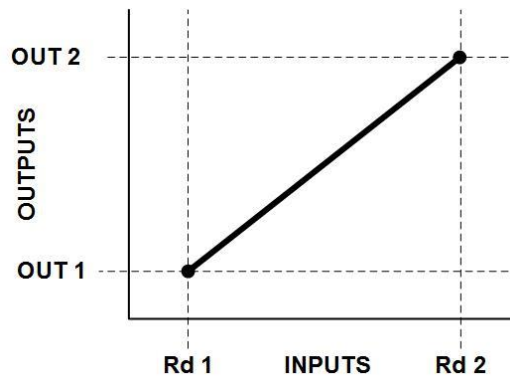

**Figure 11. Output Scaling**

## 5 SPECIFICATIONS

**Table 9** is a summary of the specifications unique to the Benchtop Digital Controller. It take precedence where applicable. For detailed specifications refer to the Platinum Series User's Manual ([M5451](#)).

**Table 9. Benchtop Digital Controller Specifications Summary.**

Model CS8DPT/CS8EPT	
<b>Display</b>	4 or 6-Digit
<b>Sensor Input(s) Channel</b>	Single-Channel, Universal Input
<b>Power All Models: Fused:</b>	90 to 240 VAC 50/60 Hz (Single Phase Only) Time-Lag, 0.1A, 250 V
<b>All Outputs Output 1: Output 2:</b>	90 to 240 VAC 50/60 Hz (Single Phase Only) Fast-Blow, 3A, 250 V Fast-Blow, 5A, 250 V
<b>Enclosure: Material: Size:</b>	Case - Plastic (ABS) 236mm W x 108mm H x 230mm D (9.3" W x 4.3" H x 9.1" D)
<b>Weight:</b>	1.14 kg (2.5 lb)

### Approval Information



This product conforms to the **EMC: 2014/30/EU (EMC Directive)**

#### Electrical Safety: 2014/35/EU (Low Voltage Directive)

Safety requirements for electrical equipment for measurement, control, and laboratory.

#### Double Insulation; Pollution Degree 2 Dielectric withstand Test per 1 min

- Power to Input/Output: 2300 Vac (3250 Vdc)
- Power to Relays/SSR Output: 2300 Vac (3250 Vdc)
- Ethernet to Inputs: 1500 Vac (2120 Vdc)
- Isolated RS232 to Inputs: 500 Vac (720 Vdc)
- Isolated Analog to Inputs: 500 Vac (720 Vdc)

#### EMC Measurement Category I

Category I includes measurements performed on circuits not directly connected to the Mains Supply (power). Maximum Line-to-Neutral working voltage is 50Vac/dc. This unit should not be used in Measurement Categories II, III, and IV.

#### Transients Overvoltage Surge (1.2 / 50uS pulse)

- Input Power: 2000 V
- Input Power: 1000 V
- Ethernet: 1000 V
- Input/Output Signals: 500 V

#### ADDITIONAL INFORMATION:

**FCC:** This device complies with Part 15, Subpart B, Class B of the FCC rules, for option –EIP only.

**RoHS II:** The above product has been declared by the original supplier as Compliant. The manufacturer of this item declares that the product complies with the EEE RoHS II Directive 2011/65/EC.

**UL File Number: E209855**

## 6 MAINTENANCE

These are the maintenance procedures required to keep the Benchtop Digital Controller in optimal performance.

### 6.1 Cleaning

Lightly dampen a soft clean cloth with a mild cleaning solution and gently clean the Benchtop Digital Controller.



Remove all electrical connections and power before attempting any maintenance or cleaning.  
Do not insert any foreign objects into the Benchtop Digital Controller.

### 6.2 Calibration

This unit is calibrated to give optimum performance over its full operating range. Additional user calibration is available with adjustable gain and offset as well as ice point calibration. Refer to the Platinum Series User's Manual ([M5451](#)) for additional information on user calibration options.

Optional NIST traceable calibration is available. Please contact Customer Service to enquire.

### 6.3 Fuse Specifications and Replacement



Disconnect all power from source before attempting fuse replacement.  
For continued protection against the risk of fire, replace fuses with only the same size, type, rating and safety approvals indicated here and on the rear panel of your unit.

**Table 10. Replacement Fuses**

Fuse*	Type
<b>F1</b>	0.1A 250V, 5x20mm, Fast Acting
<b>F2</b>	3.15A 250V, 5x20mm, Fast Acting
<b>F3</b>	5.0A 250V, 5x20mm, Fast Acting

\*Use only UL/CSA/VDE Approved Fuses.



## WARRANTY/DISCLAIMER

OMEGA ENGINEERING, INC. warrants this unit to be free of defects in materials and workmanship for a period of **61 months** from date of purchase. OMEGA's WARRANTY adds an additional one (1) month grace period to the normal **five (5) year product warranty** to cover handling and shipping time. This ensures that OMEGA's customers receive maximum coverage on each product.

If the unit malfunctions, it must be returned to the factory for evaluation. OMEGA's Customer Service Department will issue an Authorized Return (AR) number immediately upon phone or written request. Upon examination by OMEGA, if the unit is found to be defective, it will be repaired or replaced at no charge. OMEGA's WARRANTY does not apply to defects resulting from any action of the purchaser, including but not limited to mishandling, improper interfacing, operation outside of design limits, improper repair, or unauthorized modification. This WARRANTY is VOID if the unit shows evidence of having been tampered with or shows evidence of having been damaged as a result of excessive corrosion; or current, heat, moisture or vibration; improper specification; misapplication; misuse or other operating conditions outside of OMEGA's control. Components in which wear is not warranted, include but are not limited to contact points, fuses, and triacs.

**OMEGA is pleased to offer suggestions on the use of its various products. However, OMEGA neither assumes responsibility for any omissions or errors nor assumes liability for any damages that result from the use of its products in accordance with information provided by OMEGA, either verbal or written. OMEGA warrants only that the parts manufactured by the company will be as specified and free of defects. OMEGA MAKES NO OTHER WARRANTIES OR REPRESENTATIONS OF ANY KIND WHATSOEVER, EXPRESSED OR IMPLIED, EXCEPT THAT OF TITLE, AND ALL IMPLIED WARRANTIES INCLUDING ANY WARRANTY OF MERCHANTABILITY AND FITNESS FOR A PARTICULAR PURPOSE ARE HEREBY DISCLAIMED. LIMITATION OF LIABILITY: The remedies of purchaser set forth herein are exclusive, and the total liability of OMEGA with respect to this order, whether based on contract, warranty, negligence, indemnification, strict liability or otherwise, shall not exceed the purchase price of the component upon which liability is based. In no event shall OMEGA be liable for consequential, incidental or special damages.**

CONDITIONS: Equipment sold by OMEGA is not intended to be used, nor shall it be used: (1) as a "Basic Component" under 10 CFR 21 (NRC), used in or with any nuclear installation or activity; or (2) in medical applications or used on humans. Should any Product(s) be used in or with any nuclear installation or activity, medical application, used on humans, or misused in any way, OMEGA assumes no responsibility as set forth in our basic WARRANTY/DISCLAIMER language, and, additionally, purchaser will indemnify OMEGA and hold OMEGA harmless from any liability or damage whatsoever arising out of the use of the Product(s) in such a manner.

## RETURN REQUESTS/INQUIRIES

Direct all warranty and repair requests/inquiries to the OMEGA Customer Service Department. BEFORE RETURNING ANY PRODUCT(S) TO OMEGA, PURCHASER MUST OBTAIN AN AUTHORIZED RETURN (AR) NUMBER FROM OMEGA'S CUSTOMER SERVICE DEPARTMENT (IN ORDER TO AVOID PROCESSING DELAYS). The assigned AR number should then be marked on the outside of the return package and on any correspondence.

The purchaser is responsible for shipping charges, freight, insurance and proper packaging to prevent breakage in transit.

FOR **WARRANTY** RETURNS, please have the following information available BEFORE contacting OMEGA:

1. Purchase Order number under which the product was PURCHASED,
2. Model and serial number of the product under warranty, and
3. Repair instructions and/or specific problems relative to the product.

FOR **NON-WARRANTY** REPAIRS, consult OMEGA for current repair charges. Have the following information available BEFORE contacting OMEGA:

1. Purchase Order number to cover the COST of the repair,
2. Model and serial number of the product, and
3. Repair instructions and/or specific problems relative to the product.

OMEGA's policy is to make running changes, not model changes, whenever an improvement is possible. This affords our customers the latest in technology and engineering.

OMEGA is a trademark of OMEGA ENGINEERING, INC.

© Copyright 2017 OMEGA ENGINEERING, INC. All rights reserved. This document may not be copied, photocopied, reproduced, translated, or reduced to any electronic medium or machine-readable form, in whole or in part, without the prior written consent of OMEGA ENGINEERING, INC.