

# BARRIER STRIPS

## 25-B100 Series Solder Lug Type

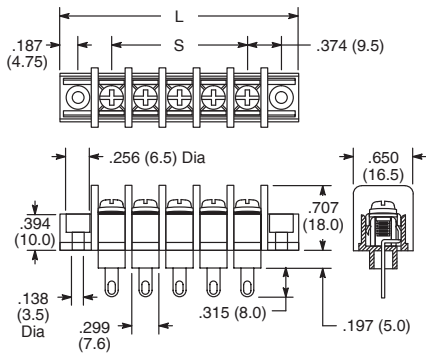

Note:  $L = .374 (9.5) \times (P+1) + .374 (9.5)$   
 $S = .374 (9.5) \times (P-1)$

Pitch: 9.5mm

### Specifications

Approval	c  us
Rated Voltage	300V
Rated Current	25A
Solid Wire (AWG)	22 - 12
Stranded Wire (AWG/mm <sup>2</sup> )	22 - 12
Torque (Kg-cm)	13.8
Screw Type	M3.5

### Ordering Information

Number of Poles	NTE Part Number
02	25-B100-02
03	25-B100-03
04	25-B100-04
06	25-B100-06
08	25-B100-08
10	25-B100-10
12	25-B100-12

## 25-B200 Series PC Mount

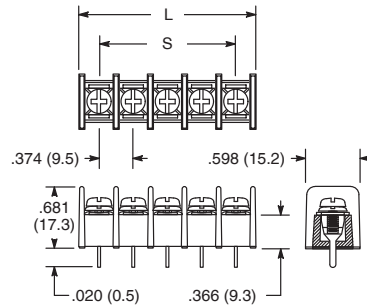

Note:  $L = .374 (9.5) \times (P-1) + .441 (11.2)$   
 $S = .374 (9.5) \times (P-1)$

Pitch: 9.5mm

### Specifications

Approval	c  us
Rated Voltage	300V
Rated Current	25A
Solid Wire (AWG)	22 - 12
Stranded Wire (AWG/mm <sup>2</sup> )	22 - 12
Torque (Kg-cm)	13.8
Screw Type	#6-32

### Ordering Information

Number of Poles	NTE Part Number
02	25-B200-02
04	25-B200-04
06	25-B200-06
08	25-B200-08
10	25-B200-10
12	25-B200-12

## 25-B300 Series Tri-Barrier PC Mount

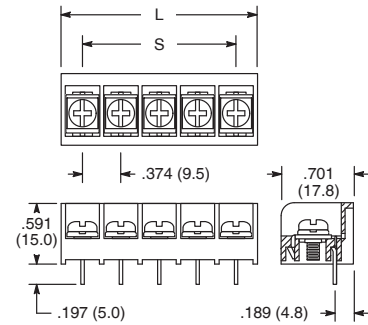

Note:  $L = .374 (9.5) \times (P-1) + .421 (10.7)$   
 $S = .374 (9.5) \times (P-1)$

Pitch: 9.5mm

### Specifications

Approval	c  us
Rated Voltage	300V
Rated Current	25A
Solid Wire (AWG)	22 - 12
Stranded Wire (AWG/mm <sup>2</sup> )	22 - 12
Torque (Kg-cm)	13.8
Screw Type	#6-32

### Ordering Information

Number of Poles	NTE Part Number
02	25-B300-02
03	25-B300-03
04	25-B300-04
06	25-B300-06
08	25-B300-08
10	25-B300-10
12	25-B300-12

# BARRIES STRIPS

## 25-B500 Series Dual Row Panel Mount

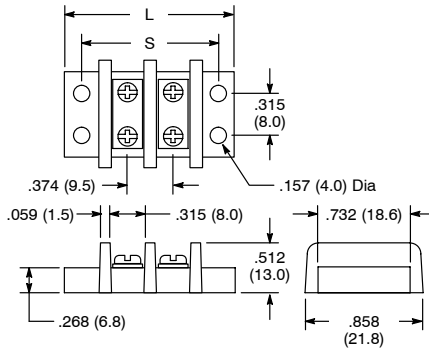

Note:  $L = .374 (9.5) \times (P+1) + .295 (7.5)$   
 $S = .374 (9.5) \times (P+1) + .020 (0.5)$

Pitch: 9.5mm

### Specifications

Approval	c  US
Rated Voltage	300V
Rated Current	20A
Solid Wire (AWG)	22 - 14
Stranded Wire (AWG/mm <sup>2</sup> )	22 - 14
Torque (in-lb)	12
Screw Type	M3.5

### Ordering Information

Number of Poles	NTE Part Number	Number of Poles	NTE Part Number
02	25-B500-02	11	25-B500-11
03	25-B500-03	12	25-B500-12
04	25-B500-04	14	25-B500-14
05	25-B500-05	15	25-B500-15
06	25-B500-06	16	25-B500-16
07	25-B500-07	18	25-B500-18
08	25-B500-08	20	25-B500-20
09	25-B500-09	22	25-B500-22
10	25-B500-10	24	25-B500-24

## 25-B400 Series PC Mount

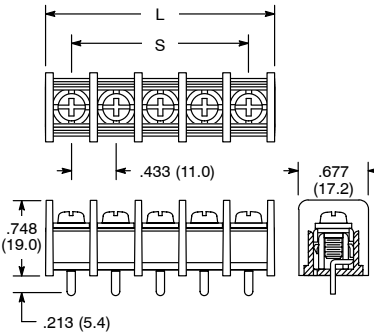
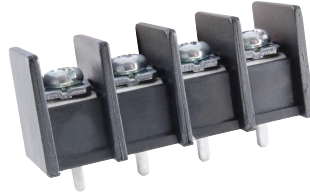

Note:  $L = .433 (11.0) \times (P-1) + .512 (13.0)$   
 $S = .433 (11.0) \times (P-1)$

Pitch: 11mm

### Specifications

Approval	c  US
Rated Voltage	300V
Rated Current	25A
Solid Wire (AWG)	22 - 12
Stranded Wire (AWG/mm <sup>2</sup> )	22 - 12
Torque (Kg-cm)	18.4
Screw Type	M4

### Ordering Information

Number of Poles	NTE Part Number
02	25-B400-02
03	25-B400-03
04	25-B400-04
06	25-B400-06
08	25-B400-08
10	25-B400-10
12	25-B400-12

## 25-B600 Series Dual Row Panel Mount

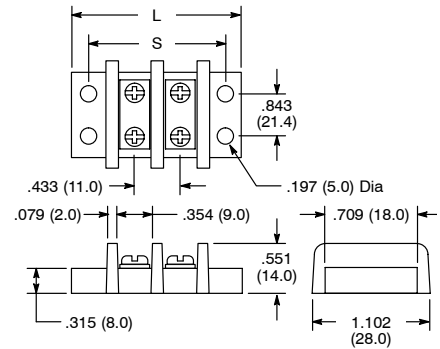

Note:  $L = .433 (11.0) \times (P-1) + 1.197 (30.4)$   
 $S = .433 (11.0) \times (P-1) + .866 (22.0)$

Pitch: 11mm

### Specifications

Approval	c  US
Rated Voltage	300V
Rated Current	25A
Solid Wire (AWG)	22 - 12
Stranded Wire (AWG/mm <sup>2</sup> )	22 - 12
Torque (in-lb)	12
Screw Type	M3.5

### Ordering Information

Number of Poles	NTE Part Number	Number of Poles	NTE Part Number
02	25-B600-02	12	25-B600-12
03	25-B600-03	14	25-B600-14
04	25-B600-04	15	25-B600-15
05	25-B600-05	16	25-B600-16
06	25-B600-06	20	25-B600-20
07	25-B600-07	22	25-B600-22
08	25-B600-08	24	25-B600-24
09	25-B600-09		
10	25-B600-10		

# EURO-STYLE BARRIER STRIPS

## 25-E2000 Series

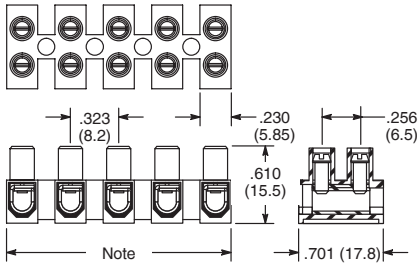
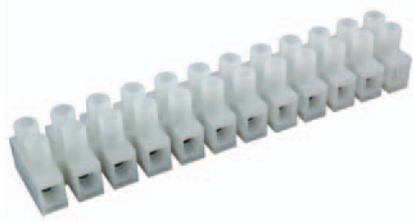

Note: .323 (8.2) x (P-1) + .230 (5.85)

**Pitch: 8.2mm**

### Specifications

Approval	
Rated Voltage	300V
Rated Current	20A
Wire Range	-
Solid Wire (AWG)	20 - 12
Stranded Wire (AWG/mm <sup>2</sup> )	20 - 12
Rated Surge Voltage	6kV
Torque (Lb-in)	3.5
Screw Type	M2.5
Wire Strip Length	.315 (8mm)

### Ordering Information

Number of Poles	NTE Part Number
12	25-E2000-12

## 25-E2100 Series

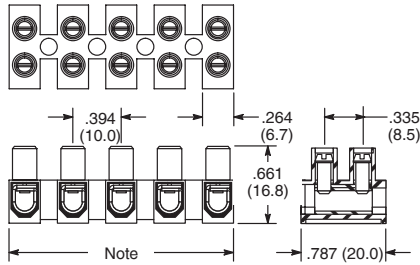
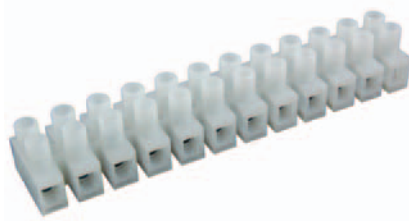

Note: .394 (10.0) x (P-1) + .264 (6.7)

**Pitch: 10mm**

### Specifications

Approval	
Rated Voltage	300V
Rated Current	30A
Wire Range	-
Solid Wire (AWG)	18 - 10
Stranded Wire (AWG/mm <sup>2</sup> )	18 - 10
Rated Surge Voltage	6kV
Torque (Lb-in)	4.4
Screw Type	M3
Wire Strip Length	.315 (8mm)

### Ordering Information

Number of Poles	NTE Part Number
12	25-E2100-12

## 25-E2200 Series

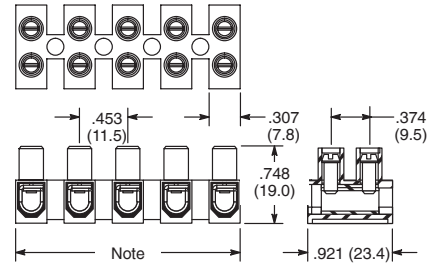
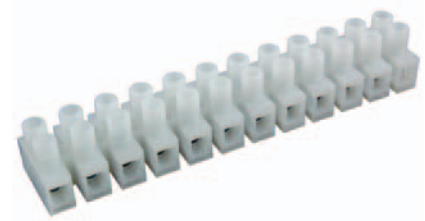

Note: .453 (11.5) x (P-1) + .307 (7.8)

**Pitch: 11.5mm**

### Specifications

Approval	
Rated Voltage	300V
Rated Current	50A
Wire Range	-
Solid Wire (AWG)	14 - 8
Stranded Wire (AWG/mm <sup>2</sup> )	14 - 8
Rated Surge Voltage	6kV
Torque (Lb-in)	7.1
Screw Type	M3.5
Wire Strip Length	.315 (8mm)

### Ordering Information

Number of Poles	NTE Part Number
12	25-E2200-12

# EURO-STYLE BARRIER STRIPS

## 25-E2300 Series

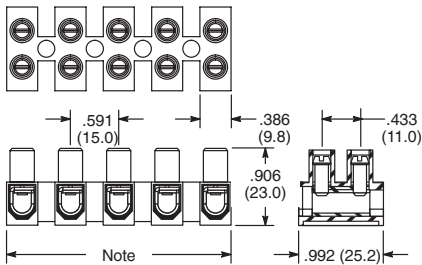
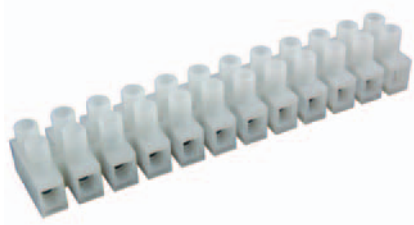

Note:  $.591 (15.0) \times (P-1) + .386 (9.8)$

**Pitch: 15mm**

### Specifications

Approval	
Rated Voltage	300V
Rated Current	30A
Wire Range	-
Solid Wire (AWG)	12 - 10
Stranded Wire (AWG/mm <sup>2</sup> )	12 - 10
Rated Surge Voltage (UL/Max.)	6kV
Torque (Lb-in)	10.6
Screw Type	M4
Wire Strip Length	.315 (8mm)

### Ordering Information

Number of Poles	NTE Part Number
12	25-E2300-12