



AIRCHECK™ G3

User Guide

Tap a [link](#) to go directly to the app's chapter.
Scroll down to view the full list of Contents.



NetAlly Network Testing Apps



AutoTest



Ping/TCP



Capture



Discovery



Wi-Fi



Path Analysis



AirMapper™



Spectrum



iPerf



Link-Live



App Store

Contents

Contact Us	13
Introduction	14
How to Use this Guide	15
Differences Between Models	19
Buttons and Ports	20
Charging and Power	23
Safety and Maintenance	25
Legal Notification	28
Home and System Interface	29
Home Screen	30
Navigating the System	32
System Status Bar and Notifications ...	36
Notification Panel	36
Apps Screen and Store	39
Device Settings	42
Quick Settings Panel	43
Connecting to Wi-Fi	47
Captive Portals	51
Configuring Wi-Fi Connections With Enterprise Security	52
Sharing	60

Sharing Files to Link-Live	61
Sharing from the Files App	63
Saving a Screenshot	65
Changing the Device Language	66
AirCheck G3 Settings and Tools	68
Navigation Drawer	69
About Screen	70
Exporting Logs	71
Test and Management Ports	72
Test Ports	73
Selecting Ports	78
Test and Port Status Notifications	81
Test Port Notifications	82
Management Port Notifications	83
Discovery Notifications	84
VNC/Link-Live Remote	84
AirCheck G3 General Settings	86
Wi-Fi	87
Management	91
Preferences	94
Trending Graphs	95
Common Icons	99

Floating Action Button (FAB) and Menu	100
Common Tools	102
Web Browser/Chromium	102
Telnet/SSH	102
External Camera	103
Software Management	107
Managing Files	108
Files Application	108
How to Move or Copy a File	111
Using a USB Drive	111
Ejecting Storage Media	112
Using a USB Type-C to USB Cable	113
Updating Software	115
Remote Access	120
Using VNC	121
Using Link-Live Remote	122
Managing NetAlly App Settings	124
Resetting Testing App Defaults	124
Saving App Settings and Configurations	129
Exporting and Importing Settings	132
Resetting AirCheck G3 Factory Defaults	143
AirCheck G3 Testing Applications	146

AutoTest App and Profiles	147
AutoTest Overview	149
Managing Profiles and Profile Groups	152
Factory Default Profiles	152
Adding New Profiles	153
Profile Groups	159
Creating New Profile Groups	164
Importing and Exporting AutoTest Profiles	167
Main AutoTest Screen	168
Periodic AutoTest	170
Periodic AutoTest Settings	170
Running Periodic AutoTest	172
Wi-Fi AutoTest Profiles	175
Wi-Fi Profile Test Results	179
Wi-Fi Link Test Results	182
Connect Log	190
Channel Test Results	191
Wi-Fi Profile FAB	197
Wi-Fi Profile Settings	201
Wi-Fi Connection Settings	203
Advanced (Wi-Fi Connection) Settings	215
Channel Test Settings	218

HTTP Proxy	221
DHCP, DNS, and Gateway Tests	223
DHCP or Static IP Test	224
DNS Test	236
Test Targets for Wi-Fi AutoTests	245
Adding and Managing Test Targets ...	246
Target Test Results Screens	250
AutoTest TCP Connect Test	258
FTP Test	272
Air Quality AutoTest Profiles	282
Air Quality Profile Results	284
Air Quality Profile FAB	289
Air Quality Profile Settings	290
Ping/TCP Test App	295
Ping/TCP Settings	296
Populating Ping/TCP from Another App	296
Configuring Ping/TCP Settings Manually	299
Running Ping/TCP Tests	303
Capture App	307
Capture Settings	308

Running and Viewing Captures	313
Discovery App	318
Introduction to Discovery	320
Main Discovery List Screen	322
Searching the Discovery List	325
Filtering the Discovery List	327
Sorting the Discovery List	330
Security Auditing – Batch Authorization	332
Refreshing Discovery	337
Uploading Discovery Results to Link- Live	338
Discovery Details Screens	340
Top Details Card	342
Lower Cards in Device Details	348
Problems	350
Addresses	351
TCP Port Scan	353
VLANs	355
Interfaces	356
SNMP	362
Connected Devices	364

Resources	365
SSIDs	366
Discovery App Floating Action Menu .	368
Device Types	374
Routers	375
Switches	376
Unknown Switches	377
Network Servers	378
Hypervisors	379
Virtual Machines	380
Wi-Fi Controllers	381
Access Points (APs)	382
Wi-Fi Clients	383
VoIP Phones	384
Printers	385
SNMP Agents	386
NetAlly Tools	387
Hosts/Clients	388
Discovery Settings	391
SNMP Configuration	394
Active Discovery Ports	402
Extended Ranges	403

Devices Discovered Through Other	
Devices	407
Device Health Interval	411
ARP Sweep Rate	412
SNMP Query Delay	413
Auto AP Grouping Rules	413
Problem Settings	418
TCP Port Scan Settings	421
Wi-Fi Analysis App	424
Wi-Fi Analysis and Discovery	426
Wi-Fi App List Screens	427
Wi-Fi App List Screens	428
Filtering in the Wi-Fi App	432
Sorting in the Wi-Fi App	437
Clearing All Problems	439
Setting Authorization	440
Uploading Wi-Fi Results to Link-Live ..	442
Wi-Fi Details Screens	444
Wi-Fi Problems Screen	447
RF and Traffic Statistics Overview	449
Locating Wi-Fi Devices	454
Assigning a Name and Authorization ..	464

to a Device	
Channels Map	477
Map and Map 6E Tabs	478
Channels	486
SSIDs	491
APs	496
BSSIDs	500
Clients	512
Path Analysis App	521
Introduction to Path Analysis	522
Path Analysis Settings	523
Populating Path Analysis from Another App	523
Configuring Path Analysis Manually ..	523
Running Path Analysis	526
Path Analysis Results and Source AirCheck G3 Cards	528
Layer 3 Hops	531
Layer 2 Devices	536
Uploading Path Analysis Results to Link-Live	542
AirMapper™ App	544

AirMapper Settings	545
Configuring an AirMapper Survey	546
Collecting AirMapper Data	555
Starting a New Survey	567
Spectrum Test App	568
Using the Spectrum Views	569
Uploading Spectrum Results to Link- Live	576
Spectrum Settings	578
Changing Spectrum Views	578
Saving Settings	578
Changing Spectrum Settings	579
iPerf Test App	582
iPerf Settings	584
Saving Custom iPerf Settings	584
Test Accessories in Discovery	585
Configuring iPerf Settings	588
Running an iPerf Test	592
Uploading iPerf Results to Link-Live ..	596
Link-Live Cloud Service	598
Getting Started in Link-Live Cloud Service	600

Claiming the Unit	600
After Claiming	602
Unclaiming	603
AllyCare Code	604
Private Link-Live Settings	605
Link-Live App Features	606
Saving Locally Only	610
Job Comment	612
Link-Live and Testing Apps	615
Link-Live Sharing Screens	616
Sharing a Text File to Link-Live	619
Specifications and Compliance	628
AirCheck G3 Specifications	629
General	629
Tri-band Wireless	630
Environmental Specifications	636
Certifications and Compliance	
Statements	637

Contact Us

Online: NetAlly.com

Phone: (North America) 1-844-TRU-ALLY
(1-844-878-2559)

NetAlly

2075 Research Parkway, Suite 190

Colorado Springs, CO 80920

For additional product resources, visit

NetAlly.com/Products/AirCheckG3.

For customer support, visit

NetAlly.com/Support.

Register your AirCheck G3

Registering your product with NetAlly gives you access to valuable information on product updates, troubleshooting procedures, and other services.

Register on the [NetAlly Support Page](#).

Introduction

The AirCheck G3 Portable Network Expert is a rugged, hand-held tool for testing and analyzing Wi-Fi networks. It features applications developed by NetAlly for network discovery, measurement, and validation, which are available from the [Home](#) and [Apps](#) screens.

All NetAlly hand-held testers include access to Link-Live Cloud Service at Link-Live.com. Link-Live is an online system for collecting, organizing, analyzing, and reporting your test results. Test data is automatically uploaded once your tester is properly configured. Visit Link-Live.com and "Claim" your AirCheck G3 to access these features.

How to Use this Guide

This user guide describes the AirCheck G3's testing functionality and basic elements of the system interface.

The guide is meant for users who are knowledgeable about network operations, tests, and measurements.

The AirCheck G3 is also referred to as just AirCheck G3 or the "unit" in this guide.

- Tap **blue links** to go to their destinations. [Underlined blue links](#) open external websites.
- Tap bookmarks in the list on the left to go to the corresponding section.
- Tap headings in the **Contents** list that starts on page 2 to go to the corresponding sections.
- To search for a word or phrase:
 1. Tap the browser menu  icon in the upper right.
 2. Select **Find in Page** from the menu.

3. Enter the search text.
4. Tap the find icon . This displays the text at the top of the screen. Tap the up and down arrows to search forwards and backwards for the text. In the image below, the user has searched on "LAN". Tap the highlight bars on the right to go to the corresponding manual text.

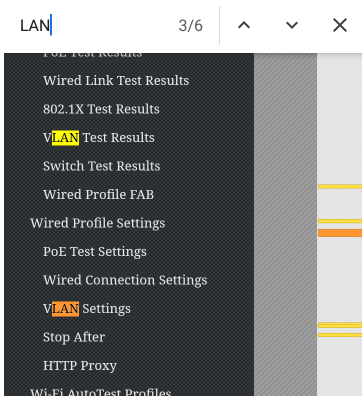

Online and Local Versions of This Guide

- Manuals are also available for download at: <https://www.netally.com/support/user-guides/>
- To view the User Guide on your AirCheck G3's, you must have a network connection with access to the internet (see [Connecting to Wi-Fi](#)). When you tap on **Guides > User Guide** on the "Home Screen" on page 30, this user guide is downloaded and displays on your unit.
- After you have downloaded the User Guide to your unit, the guide is stored in a local cache for the browser. You do not have to repeat the download unless you [change the device language](#) or clear the browser cache.

International Versions of This Guide

A Chinese or English AirCheck G3 user guide is available if you [change the device language](#) to

one of those languages. If you choose Japanese, the English user manual is used.

Differences Between Models

The Model number of your AirCheck G3 is printed on the back panel of your unit and on the [About Screen](#). This manual covers all models by identifying features specific to each model in the text. In general:

- AirCheck-G3-PRO: Supports 2.4 GHz, 5 GHz and 6 GHz frequency bands; supports 802.11a/b/g/n/ac/ax Wi-Fi standards; does not support 802.11d specification.
- AirCheck-G3E-PRO: Supports 2.4 GHz, 5 GHz and 6 GHz frequency bands; supports 802.11a/b/g/n/ac/ax Wi-Fi standards; supports 802.11d specification.
- AirCheck-G3C-PRO: Supports 2.4 GHz, 5 GHz frequency band; does not support 802.11d specification.

For more information, see [AirCheck G3 Specifications](#).

Buttons and Ports

Button and port functions on your AirCheck G3 unit are described below.

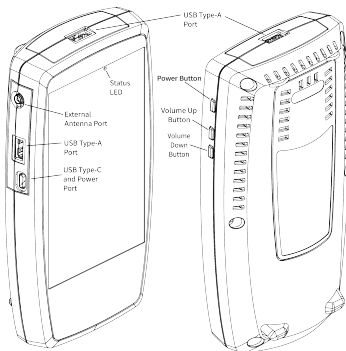

FEATURE	DESCRIPTION
Status LED	<p>Red: unit off, USB-C power adapter connected</p> <p>Green: unit on, screen off (with or without power adapter)</p> <p>Rate of blinking LED (red or green) shows % battery charge:</p> <ul style="list-style-type: none"> • 2 blinks per second: battery low, 0-24% charged

FEATURE	DESCRIPTION
	<ul style="list-style-type: none"> • 1 blink per second: 25-49% charged • 1 blink per 2 seconds: 50-74% charged • 1 blink per 4 seconds: 75-99% charged • No blinks: 100% charged
USB Type-A Ports (2)	Connects to any USB device. (FAT32-formatted device required only for manual software updates.)
USB Type-C On-the-Go Port	Connects to a USB Type-C connector for file transfer and to charge unit with the included AC adapter
Volume Buttons	Increase or decrease the audio volume
Power Button	Press and hold to display menu for Power off or Restart

See [Test and Management Ports](#) for detailed explanations of the port functions.

See [Updating Software](#) for requirements on updating system software.

Refer to the product [Specifications](#) if needed.

Using a Kensington Lock

The back panel of the unit has two rows of six vent slots on either side of the serial number label. You can use a Kensington Lock with any slot in these two rows.

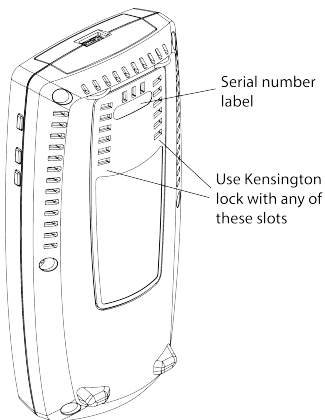

Charging and Power

Your AirCheck G3 includes a USB-C 15V/3A power adapter.

 **CAUTION:** Only the NetAlly-supplied power adapter is supported.

To begin charging the internal lithium-ion battery, plug the included power adapter into an AC outlet and the USB-C charging port on the left side of the unit. The Power LED button turns red when the unit is in charging mode and turns off at full charge. The unit fully charges in 2-4 hours via AC power.

When in charging mode (meaning the unit is off but plugged into an AC power source), the unit turns on once every 24 hours and top off the battery charge, then power off again.

Tap the power button briefly to view the battery level on the screen while the unit is in charging mode.

On battery power only, the unit runs for 3-4 hours, depending on the type of testing being conducted.

Powering On

- To start up the unit, hold down the power button for approximately one second, until the power button LED turns green.
- When the display goes into Sleep mode, the power LED remains on. Tap the power button briefly to wake up the display. Set the timing for display sleep and auto power off in the  [Device Settings](#).
- To shut down or restart, hold the power button for one second until the “Power off” and “Restart” dialog box appears on the touchscreen, and then tap **Power off** or **Restart**.
- If the unit is unresponsive to a normal power off, press and hold the power button for five seconds to perform a hard shutdown.

Safety and Maintenance

Observe the following safety information:

Use only the Adapter provided to charge the battery.

Ensure that the Adapter is easily accessible.

Use the proper terminals and cables for all connections.

 **CAUTION:** To avoid possible electric shock or personal injury, follow these guidelines:

- Do not use the product if it is damaged. Before using the product, inspect the case, and look for cracked or missing plastic.
- Do not operate the product around explosive gas, vapor, or dust.
- Do not try to service the product. There are no serviceable parts.
- Do not replace the battery. There is risk of explosion if the battery is replaced by an incorrect battery type.
- Dispose of battery packs and electronics in compliance with your institution's disposal instructions.

- Use as directed. If this product is used in a manner not specified by the manufacturer, the protection provided by the product may be impaired.

Safety Symbols



Warning or Caution: Risk of damage to or destruction of equipment or software.



Warning: Risk of electrical shock.



Not for connection to a public telephone system.

Cleaning

To clean the display, use a lens cleaner and a soft, lint-free cloth.

To clean the case, use a soft cloth that is moist with water or a weak soap.

Scratches on the dark-colored plastic can be removed by *lightly* scrubbing a 1:2 mixture of toothpaste to water onto the affected surface with a bristled brush.

 **CAUTION:** Do not use solvents or abrasive materials that may damage the product.

Legal Notification

Use of this product requires acceptance of the Terms and Conditions available at <http://NetAlly.com/terms-and-conditions> or which accompanies the product at the time of shipment or, if applicable, the legal agreement executed by and between NetAlly and the purchaser of this product.

Open-Source Software Acknowledgment: This product may incorporate open-source components. NetAlly will make available open-source code components of this product, if any, at Link-Live.com/OpenSource.

NetAlly reserves the right, at its sole discretion, to make changes at any time in its technical information, specifications, service, and support programs.

© 2019-2022 NetAlly

Home and System Interface

This chapter explains how to use the features of the system Home screen and user interface to navigate and organize your device.

The AirCheck G3 interface supports many of the operations typical of any hand-held device. Use dragging and **swiping** motions on the touchscreen to navigate through apps, open side menus, drag down the **Notification Panel** from the Status Bar at the top of the Home screen, or drag up the **Apps** screen from the bottom.

Home Screen

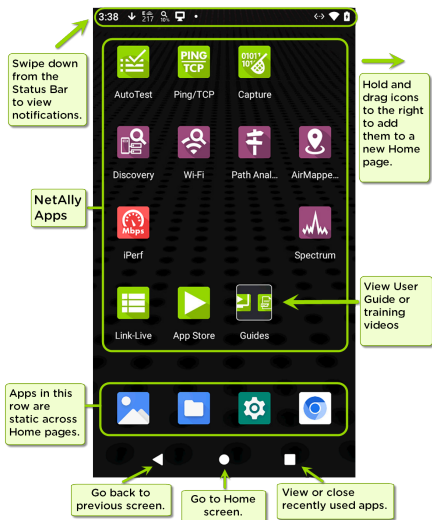

Like other hand-held devices, your AirCheck G3 Home screen is customizable. The image above shows the default configuration, but you can

add, remove, and reorganize app icons and widgets to serve your purposes.

You can also create more Home pages by tapping, holding, and dragging an app icon to the right from the main Home screen.

See the [Apps screen](#) section for instructions on adding more apps to your Home pages.

Navigating the System

The navigation actions you can perform to move through screens and panels on the AirCheck G3 are the same as those you would use to navigate many other phone or tablet devices.

The main device navigation buttons appear at the bottom of the touch screen.



The back icon returns to the previous screen.



The circle icon opens the Home screen.



The square icon displays your recently used applications for easily switching between them. This is also the screen where you can close, or stop, the open applications.

TIP: Double tap the square icon to switch back to the previous app you were using and to switch back and forth between two app screens (like a testing app and this User Guide).

Swiping

Touch and drag your finger or "swipe" up, down, left, and right to move through pages of the [Home screen](#) and applications, scroll up or down, and pull out navigation drawers and panels.

Long Pressing

Touch and hold or "long press" files or application icons to reveal additional operations.

For example, you can long press a file name in the [Files Application](#) to reveal the top toolbar with options for [sharing](#) , deleting, or moving the file.

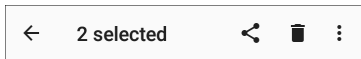

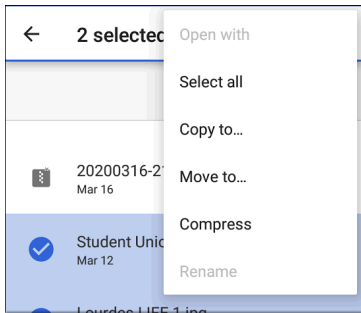

Additional options often appear in an overflow menu, designated by the action overflow icon .



You can also long press on text on most screens to open options for copying and [sharing](#) the text.

Left-Side Navigation Drawer

In the [Files](#)  app, tap the Menu icon  or swipe right to open the navigation drawer. It displays the folders in your file system.

Open from



AirCheck G3



USB3



NOTE: In the Files app, you may need to tap the action overflow icon  at the top right and select **Show Internal Storage** to navigate to the **AirCheck-G3** folder and sub-folders, as shown above.

See the [Navigation Drawer](#) topic for more.

System Status Bar and Notifications

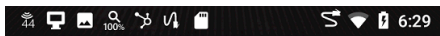

The Status Bar across the top of the screen displays notification icons from the system as well as AirCheck G3-specific icons related to your network connections and test statuses.

See [Test and Port Status Notifications](#) for details about the icons and notifications related to AirCheck G3 network connections, testing, and management.

Tap and swipe down on the Status Bar to open the Notification Panel.

Notification Panel

The Notification Panel contains notifications from your device, such as downloads and installs, inserted hardware, captured screenshots, app and connection statuses, and updates. The panel also displays common system settings icons for quick access.

Swipe (touch and drag) downwards on the Status Bar at very top of the screen to slide down the Notification Panel.

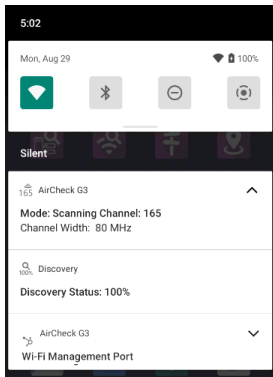

- Tap the title and down arrow ∇ on a notification (or swipe down on it) to expand the box and view more details or options.
- Tap the middle of a notification to open the related app, image, or device settings or to perform other related actions.
- Swipe left on a notification to dismiss it.

NOTE: Because they are essential to the AirCheck G3 testing functions, you cannot dismiss the [test and management port-related test and port status notifications](#).

- Tap **CLEAR ALL** at the lower right of the panel to dismiss all system notifications.

Apps Screen and Store

To access the apps that are not shown on the Home screen, swipe up on the Home screen or tap the up arrow icon .

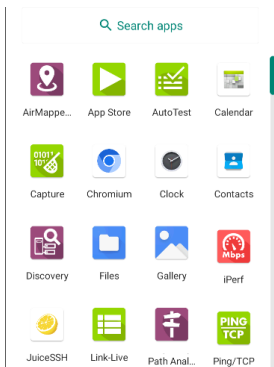

The Apps screen displays all the apps on your device. The image above is an example. Your Apps screen may contain different third-party apps.

- Tap an app's icon to open the app.
- Hold and drag an icon upwards to add it to your Home screens.
- Touch and hold (long press) an icon to view App Info or access widgets you can add to the Home screen and other actions you can perform.

App Store

From the Home Screen or Apps Screen, open the NetAlly  App Store to download third-party system applications to use on your AirCheck G3.

NOTE: Your unit must be "claimed" to [Link-Live Cloud Service](#) at Link-Live.com to access the App Store.

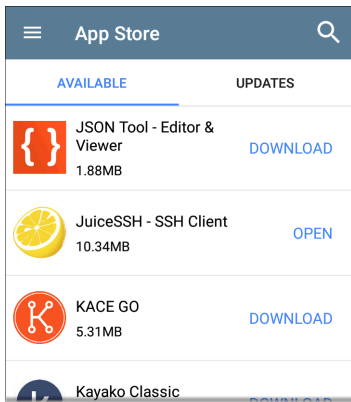

Tap the search icon to search for an

App.

Tap **UPDATES** to view available updates of installed apps.

To request that an App be added to the App Store, visit the Apps ► page at Link-Live.com, and select the floating action button (FAB) at the lower right corner to **Request** or **Upload an App**.

Device Settings

To access the system device settings, tap the Settings  icon at the bottom of the [Home screen](#).



Search settings



Network & internet

Wi-Fi



Connected devices

Bluetooth



Apps & notifications

Recent apps, default apps



Battery

100%



Display

Wallpaper, screen timeout, font size



Sound

Volume, vibration, Do Not Disturb



Storage

52% used - 7.60 GB free

Use the device settings screen to adjust the display, sound, and date/time; view installed applications and memory devices; [connect to Wi-Fi](#); or [reset to factory defaults](#).

Quick Settings Panel

You can also access some of the most common device settings, like Wi-Fi, from the Quick Settings Panel by swiping down from the [Status Bar](#) at the top of the touchscreen.

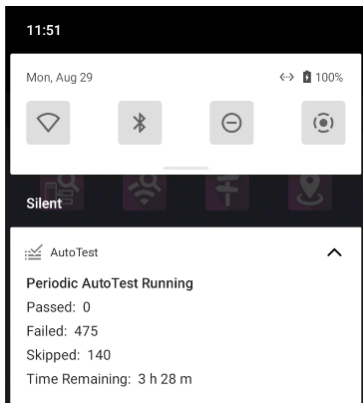

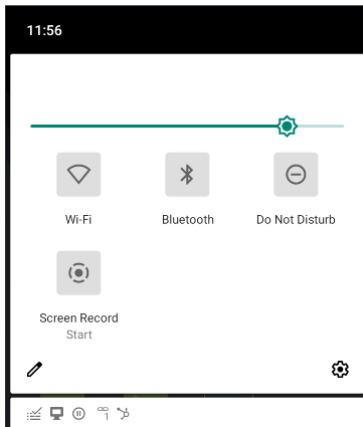

Swipe down twice to open the full Quick Settings Panel.



- Touch and drag the slider control at the top of the panel to adjust the screen's brightness.
- Tap an icon in the panel to enable or disable the corresponding feature. For example, you

can turn the unit's **Wi-Fi**  functions on or off from the quick settings.

- Touch and hold an icon to open the relevant device setting screen, if there is one. For example, touch and hold the Wi-Fi icon  to open system's Wi-Fi settings.
- Tap the pencil icon  at the bottom of the Quick Settings Panel to configure the icon controls that appear in the panel.

Auto Power Off

Activating the Auto Power Off function helps to extend the battery run time.

1. From the Device Settings , select **Display**.
2. On the Display settings screen, tap **Device auto power off**.
3. In the pop-up dialog box, select how long you want the unit to remain On with no activity occurring. The unit automatically powers off after the selected period of inactivity has passed.

Similarly, you can adjust the setting that controls when the display goes into **Sleep** mode from the **Display** settings screen.

Language

Your device supports English, Japanese, and Chinese language displays. See "[Changing the Device Language](#)" on page 66 for information on changing the language.

Connecting to Wi-Fi

Basic connectivity to Wi-Fi is done using the Wi-Fi Management Port, which is configured in the system network settings. The [Wi-Fi Management Port](#) is separate from the Wi-Fi test port. It can access the internet, be used by other system applications, upload test results to the Link-Live web site, and be used for remote control. The management port also provides a more stable network connection than the test port, which can change connections during AutoTests or be disconnected during Wi-Fi scanning. See [Test and Management Ports](#) for more information.

NOTE: NetAlly testing apps use the Wi-Fi Test Ports and Wi-Fi AutoTest Profiles to connect to Wi-Fi networks during testing. See [Test and Management Ports](#) for more information.

To connect your AirCheck G3 to a Wi-Fi network, access the system Wi-Fi Device Settings using either method below:

- Open the device Wi-Fi settings from the main [Device Settings](#) screen by tapping the Settings icon  and selecting **Network &**

Internet > Wi-Fi.

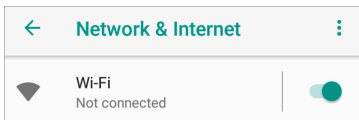

- Open device Wi-Fi settings from the [Quick Settings panel](#) by dragging down the top Status Bar and tapping and holding (long pressing) the Wi-Fi icon.

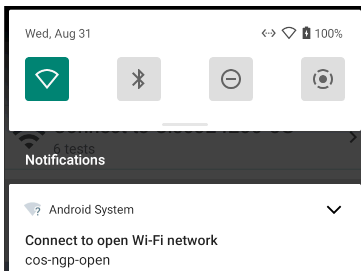

Either path opens the Wi-Fi settings screen.

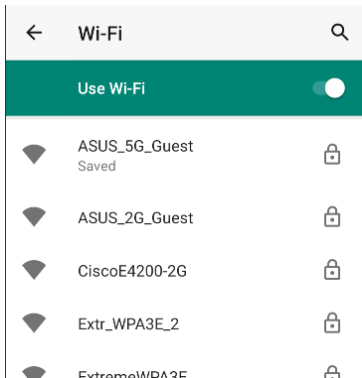

1. Ensure the Wi-Fi feature is **On**.
2. Tap an available Wi-Fi network in the list.

3. Enter the network's security credentials.

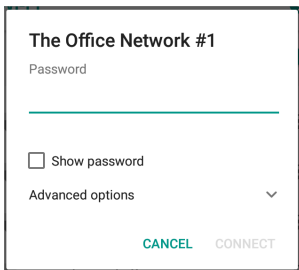

The screenshot shows a dialog box titled "The Office Network #1". It contains a "Password" label above a text input field. Below the input field is a checkbox labeled "Show password" which is currently unchecked. Underneath is the text "Advanced options" with a downward-pointing chevron icon. At the bottom of the dialog are two buttons: "CANCEL" in red and "CONNECT" in grey.

Most networks only require a password, but depending on the security settings, some may also require a company username, EAP type, authentication type, certificate, or other credentials.

4. After entering credentials, tap **CONNECT**.

The network you selected moves to the top of the list, and your connection status is displayed below its name in device and quick settings.



LRG

Connected

The Status Bar displays the Wi-Fi status icon  at the top right of the screen.

Captive Portals

When you try to connect to a network with a Captive Portal requirement, this system notification icon  appears in the top [Status Bar](#). Drag down from the top of the screen to open the notification.

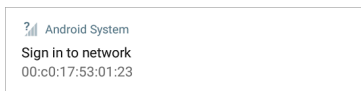

Tap the notification to open a web browser window where you can enter the required information for the captive portal. When finished, you can access the internet through the connected network.

If you are trying to connect to a network with a captive portal, but the system notification is not appearing, check that the **Captive Portal Detection** setting is enabled in [Device Settings](#)  > **Network & Internet**.

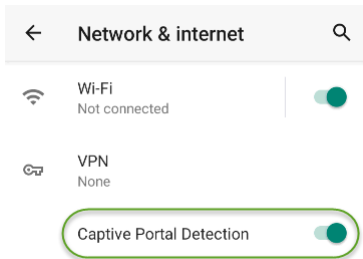

Configuring Wi-Fi Connections With Enterprise Security

Enterprise security requirements for WPA/WPA2/WPA3 Enterprise now require a CA certificate file to be imported to your unit. Some EAP types also require a client certificate and key. This procedure assumes that you are trying to connect to an AP using WPA2-E with PEAP.

- [Before You Begin](#)
- [Import the Certificate Authority File](#)
- [Test Wi-Fi Management Using WPA2-E with PEAP](#)

- [Import the Client Certificate](#)

Before You Begin

You may depend on your IT department to provide authorization certificates, which may be created by a Trusted Root Authority like VeriSign or DigiCert. If so, contact your IT department for the certificate resources. You will need:

- CA certificate in .pem format
- Client certificate in .p12 format with private key (EAP TLS only)
- Common name, domain name, username, and password for the server you to which you want to connect.

If you have the ability to generate your own self-signed certificates, such as a FreeRADIUS server, you can create these resources as needed. This procedure uses examples generated by a FreeRADIUS server as a certificate source, although other sources are available.

Import the Certificate Authority File

1. Copy the self-signed Certificate Authority (CA) file (in .pem format) onto a USB thumb drive.
2. Transfer the USB thumb drive to your AirCheck G3, and then copy the .pem file to the **Downloads** folder.
3. Open the Settings app.
4. Navigate to **Security > Encryption & credentials > Install a certificate > Wi-Fi certificate**. This opens the file picker.
5. Navigate to the Downloads folder, and select the .pem file that contains your CA certificate.
6. Rename this certificate (for example, **CA FreeRadius self-signed**). A message confirms that the Wi-Fi certificate has been installed.
7. (Optional) Verify the CA certificate installed correctly:

- a. Tap the system **BACK** button to return to Encryption & credentials.
 - b. Tap **User credentials**.
 - c. Verify that the name of your CA file (for example, **CA FreeRadius self-signed**) is displayed.
8. If you are creating your own certificate:
- a. Verify the common name for the enterprise server. For example, using a FreeRADIUS server, create a common name of Example Server Certificate by entering:

```
sudo -s
cd /etc/freeradius/certs
openssl x509 -in server.pem
-text | grep Subject | grep
CN
Subject: C=FR, ST=Radius,
O=Example Inc., CN=Example
Server Certificate/
emailAddress=
admin@example.org
```

- b. On the same server, create a user login to access the enterprise server. For example, using a FreeRADIUS, you would edit `/etc/freeradius/users`, locate the section for "`# The canonical testing user`", and then create the new user by inserting 2 lines:

```
entuser1 Cleartext-Password
:= "randompw"
Reply-Message := "Hello, %
{User-Name} "
```

This creates a user login called **entuser1** with a password of **randompw**.

Test Wi-Fi Management Using WPA2-E with PEAP

1. Open the Settings app on your unit and navigate to **Network & internet**.
2. Toggle the Wi-Fi button to On/Enabled.
3. Tap **Wi-Fi** to view available networks.
4. Scroll down to and then select the SSID of the enterprise server you wish to connect to

using WPA2-E (for example, **TEST-Ruckus-WPA2-E**).

5. Configure the following WPA2-E options in the pop-up dialog:

- EAP method: **PEAP**
- Phase 2 authentication: **MSCHAPV2**
- CA certificate: (use whatever name you chose for your CA certificate, for example, **CA FreeRadius self-signed**)
- Online Certificate Status: **Do not validate**
- Domain: (enter the Common Name recorded above, for example, **Example Server Certificate**)
- Identity: (enter whatever test user name was set up for the server, for example, **entuser1**)
- Anonymous identity: (leave blank)
- Password: (enter the password set up for the server)

6. Tap the **CONNECT** button to apply settings and close the configuration page.
7. Verify that the test SSID appears at the top of the list with a status of Connected.

Import the Client Certificate

NOTE: Applies to EAP TLS only.

1. Obtain a client certificate in .p12 format. Be sure it includes the private key.

NOTE: While the imported CA certificate was a .pem file, NetAlly recommends that the client certificate use a .p12 file.

2. Rename the certificate file, for example, **client.p12**.
3. Copy the .p12 file to a USB thumb drive.
4. Transfer the USB thumb drive to your AirCheck G3, and then copy the .p12 file to the **Downloads** folder.
5. Open the Settings app.
6. Navigate to **Security > Encryption & credentials > Install a certificate > Wi-Fi certificate**. This opens the file picker.

7. Navigate to the **Downloads** folder, and select the .p12 file that contains your client certificate (for example, **client.p12**). A message prompts you to enter the password.
8. Enter the client certificate password to extract the certificate.
9. Rename the certificate, for example, **FreeRadius client**. A message confirms that the Wi-Fi certificate has been installed.
10. (Optional) Verify the client certificate installed correctly:
 - a. Tap the system **BACK** button to return to Encryption & credentials.
 - b. Tap **User credentials**.
 - c. Verify that the name of your client certificate file (for example, **FreeRadius client**) is displayed.
11. Press the system **BACK** button to return to Encryption & credentials. You can now securely connect to your enterprise server.

Sharing

AirCheck G3 allows you to share images and files on other devices. When you see the Share icon , tap it to view your configured sharing options.

For example, the image below shows an expanded Screenshot notification from the top notification panel.

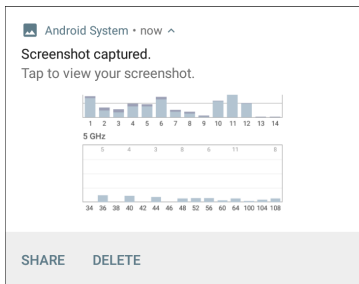

Tap **SHARE** to open the “Share with” pop-up dialog, where you can choose a sharing method, such as email, messaging, or uploading to [Link-Live Cloud Service](#) online.

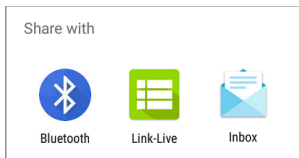

Sharing Files to Link-Live

From the “Share with” dialog box (and other screens on the AirCheck G3), tap the  **Link-Live** option to share (upload) a file to Link-Live Cloud Service at Link-Live.com.

Files can be attached to a test result or uploaded individually to the Uploaded Files  page on Link-Live.

The example below shows the Link-Live sharing screen for a screenshot image.



Link-Live

by NetAlly

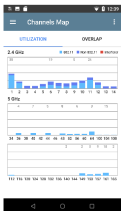

Comment

2nd Floor South

Job Comment

Union Hall



SAVE TO LAST TEST RESULT



SAVE TO UPLOADED FILES



The **SAVE TO LAST TEST RESULT** option attaches the image to your most recently run AutoTest or iPerf results on Link-Live.com.

Sharing from the Files App

Files from internal or external storage can also be shared to Link-Live.com from the system [Files](#) app. You can upload one selected file or multiple files at once.

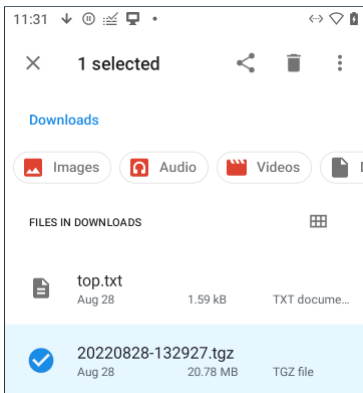
1. With the Files app opened, navigate to the folder containing the files you want to share using the [left-side navigation drawer](#).
2. Long press on one or multiple files to select it.



3. Tap the  share icon in the top toolbar.
4. If prompted, tap the  **Link-Live** option.

**Link-Live**

by NetAlly



File Name

20220828-132927

Comment

Logs

Job Comment

QA-Colo-ACKG3 App-2.1.0.93



SAVE TO LAST TEST RESULT



SAVE TO UPLOADED FILES

5. Enter any **Comments** you would like attached to your file.
6. Select **SAVE TO LAST TEST RESULT** or **SAVE TO UPLOADED FILES**.

Your files are uploaded and viewable on Link-Live.com.

See the [Link-Live](#) chapter for more information on using Link-Live with your AirCheck G3.

Saving a Screenshot



On the AirCheck G3 unit, press and hold the **Power** button and the **Volume Down** button at the same time for one second to save a screenshot of the current screen. (See [Buttons and Ports](#) for button locations).

When a screenshot is taken, the unit beeps and displays the captured screenshot notification in the [Notification Panel](#). Open the notification to share the image using Link-Live, Bluetooth, or another configured application.

Changing the Device Language

The AirCheck G3 supports Chinese, English, and Japanese language displays.

To change the device's interface language:

1. Go to the [Device Settings](#) screen by tapping the Settings  icon at the bottom of the Home screen.
2. Scroll to and select **System**.
3. Select **Languages & input** and then **Languages**. This displays the Language preferences screen.
4. On the Language preferences screen, select **+ Add a language**.
5. Tap the language option you want. This returns you to the Language preferences screen.
6. Touch and hold the icon  to the right of the language, and then drag the language to

the top (number 1) place on the list.



The AirCheck G3 displays the chosen languages, as available, in the priority order shown on the Language preferences screen.



NOTE: The AirCheck G3 supports Chinese, English, and Japanese. This user guide supports Chinese and English. If you choose Japanese as the device language, the system uses the English user guide. See [How to Use this Guide](#) for more information about the user guide.

NOTE: Manuals are also available for web download at: <https://www.net-ally.com/support/user-guides/>

AirCheck G3 Settings and Tools

The AirCheck G3 features a common set of tools and [General Settings](#) that apply to multiple NetAlly apps and testing behaviors. This chapter covers settings, icons, and notifications *specific to AirCheck G3*.

(See the [Device Settings](#) topic for information on the system settings.)

Access common settings and informational screens for the NetAlly testing apps (like AutoTest or Capture) by opening the left-side Navigation Drawers  or Settings .

Navigation Drawer

Many system apps, including the NetAlly test apps, contain additional settings, tools, and information in a "navigation drawer" that slides out from the left side of the screen.

To open the navigation drawer:

- Tap the menu icon  at the top left of one of the testing application screens.
- Touch and drag (swipe) to the right from the very left side of the app screens.

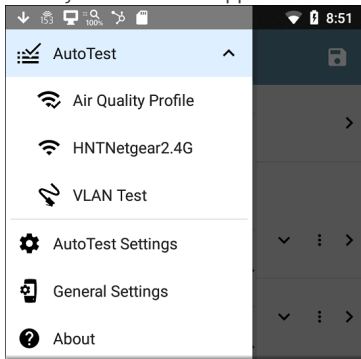

As an example, the AutoTest navigation drawer (above) provides access to the enabled [AutoTest profiles](#), AutoTest Settings, [General Settings](#), and the About screen.

Settings for each specific app are described in the chapter for the app.

About Screen

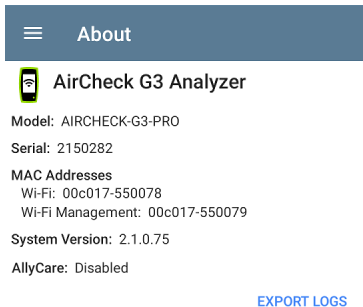

☰ About

 **AirCheck G3 Analyzer**

Model: AIRCHECK-G3-PRO

Serial: 2150282

MAC Addresses

- Wi-Fi: 00c017-550078
- Wi-Fi Management: 00c017-550079

System Version: 2.1.0.75

AllyCare: Disabled

[EXPORT LOGS](#)

The About screen displays the model number, serial number, MAC addresses, software versions, SFP details, and current AllyCare contract status for your AirCheck G3.

If a **User-Defined MAC** is enabled in an NetAlly apps' [General Settings](#), (User-defined) appears next to the MAC address on the About screen.

Exporting Logs

The About screen contains the Export Logs function, which allows you to save your unit's logs for analysis by NetAlly's technical support team.

Tap the **EXPORT LOGS** link to download a .tgz file to the Downloads folder on your unit. Open the [Files](#) app to transfer the file using email or another method. (See [Managing Files](#).)

Test and Management Ports

The AirCheck G3 has: two USB Type A ports; a single USB Type C port for charging and On-the-Go; and two Wi-Fi radio ports.

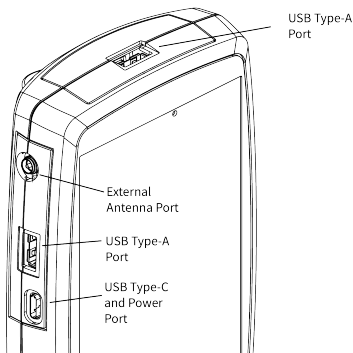

The Wi-Fi ports give the AirCheck G3 two network interfaces: 1) Wireless Test, and 2) Wireless Management.

See the sections below for more information on the ports. Also see [Buttons and Ports](#) and the technical [Specifications](#) if needed.

Test Ports

 **Wi-Fi Test Port:** The internal Wi-Fi test adapter is a 2x2 Tri-band 802.11ax wireless radio. (To disable, see [General Settings](#) in the testing apps' left-side navigation drawer.)

AirCheck G3 runs Wi-Fi AutoTests, Captures, Discovery, and other comprehensive network analysis apps over the test port. The Wi-Fi test radio is primarily controlled by the settings in applications, especially AutoTest.

You use the [AutoTest](#) app to set up and run an [AutoTest Wi-Fi Profile](#) to establish a link on the Wi-Fi test port. (By default, the AirCheck G3 starts in the Wi-Fi App passive scanning mode). Note that the [General Settings](#) affect how you can use the test port. (The General Settings are accessible from the left-side navigation drawer from most NetAlly testing apps.)

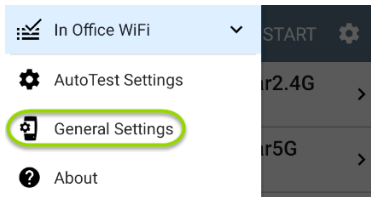

The **Use Wi-Fi test port** option must be enabled for the test port to function. (Enabled is the default setting.)

General Settings

- Use Wi-Fi test port
Enabled
- Country
United States (US)
- Wi-Fi Bands and Channels
2.4 GHz, 5 GHz, 6 GHz, 98 Channels
- Custom Signal Adjustments
Disabled
- User-Defined MAC
Disabled
- Management
- VNC
Allow VNC connections: Enabled

NetAlly also recommends that you enable all Wi-Fi Bands and Channels before setting up Wi-Fi Test Profiles:

1. Tap the **Wi-Fi Bands and Channels** option to open the Wi-Fi Bands and Channels screen.
2. Tap the Wi-Fi band(s) option to open a selection screen, and then enable all available bands.
3. Tap the option for each frequency band to open a selection screen, and then enable all available channels for each band.

This process makes it easier to set up the Wi-Fi Test Profiles, which you can limit to specific channels, APs, SSIDs, etc. See [AutoTest Wi-Fi Profile](#) for more information.

See [General Settings](#) for more information about all General Settings options.

Management Port

 **Wi-Fi Management Port:** The internal Wi-Fi management port runs on the main system's 1x1 Dual-band 802.11ac + Bluetooth 5.0 wireless adapter, which is configured in the system Device Settings. See ["Connecting to Wi-Fi" on page 47](#) to configure this connection.

The Wi-Fi management radio is set up by the system network settings. The full Internet access and a more stable network connection than the Test Port, which may frequently drop links and reconnect or resume scanning.

AirCheck G3 can run Discovery, Ping/TCP Connect tests, and Path Analysis on the management port, but not AutoTests, or packet captures.

 **USB Wired Management Port:** You can use a USB to Ethernet adapter to run an alternative wired management port for your AirCheck G3. This option allows you to set up a stable wired connection for [system updates](#), [Updating Software](#), communicating with [Link-Live](#), and for running basic wired tests that can help with diagnosing problems that may affect Wi-Fi devices.

NOTE: NetAlly has tested many USB-to-Ethernet adapters with the AirCheck G3, but not all adapters have been tested for compliance. Contact [NetAlly support](#) for more details if needed.

To set up the adapter interface:

1. Plug the adapter into one of the USB Type A ports on your device.
2. Connect the adapter to a network RJ45 cable.
3. Verify that the LEDs on the adapter are on. This indicates that the connection is active.
4. Verify that the USB Wired Management Port is now listed as a management port in the [Test and Port Status Notifications](#).

You can now use the USB Wired Interface in the following applications:

- Discovery (Active Discovery Ports and TCP Port Scan)
- Ping
- Path Analysis

See [Selecting Ports](#) below for more information.

Selecting Ports

Some of the individual NetAlly testing apps let you select which port interface to use for tests or analysis. For example:

- You may want to verify that you are getting a reliable connection to the Internet and the Link-Live cloud service while you are actively using the Wi-Fi Test port to perform an AirMapper survey. To check connectivity, you can configure the Ping/TCP app to use the Wi-Fi Management port to run a continuous background ping to the Internet.
- Each port can connect to different networks. For example, an organization might have one network for visitors and another for staff. You can use the management and the test port to check connectivity on each network without the need to link and relink through a single interface.

To change the port, tap an app's settings icon  to display the settings screen. Then tap **Interface** to select the port.

Interface

Any Port

Wi-Fi Port

Wired Management Port (USB)

Wi-Fi Management Port

[CANCEL](#) [OK](#)

- The top Wi-Fi Port refers to the test port.
- The Wired Management Port (USB) option refers to the [optional USB-to-Ethernet interface](#) for the management port.
- An [AutoTest Wi-Fi Profile](#) must run to establish test port links.
- The last listed Wi-Fi Profile runs automatically when a Wi-Fi connection is available.

Test and Port Status Notifications

AirCheck G3 shows notifications from the NetAlly testing apps and unit ports in the top Status Bar and [Notification Panel](#). Swipe down on the Status Bar to view the notifications.

On each notification, you can tap the title and down arrow to expand the box and view more details or options.

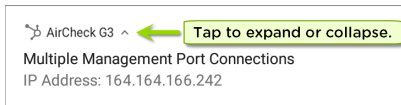



Various AirCheck G3 icons appear in your Status Bar, as listed in the following sections.

NOTE: Read [Test and Management Ports](#) for descriptions of the port functions.

See [General Settings](#) for settings that control port functions.

Test Port Notifications

Active network connections on the test ports are established using the [AutoTest](#) app.

 or  The **Wi-Fi Test Port** status displays with the wireless channel number under a Wi-Fi or Link icon. Channels in the 6 GHz band display with an E by the Wi-Fi or Link icon.

 When the AirCheck G3 unit is dwelling on a Wi-Fi channel (in this case channel 64), the channel number is static. When the AirCheck G3 is scanning for discovery, Wi-Fi analysis, or air quality measurements, the channel number changes dynamically to show which channel is currently being scanned.

 **Periodic AutoTest** is running or has completed. When [Periodic AutoTest](#) is running, the Wi-Fi Test Port may not be available to other testing apps.

 AutoTest ^
Periodic AutoTest Running

Passed: 3

Failed: 2

Skipped: 1

Time Remaining: 54 m

Management Port Notifications



A **Management Port** connection is established through the main system Wi-Fi adapter.

 AirCheck G3 ^
Multiple Management Port Connections

Wi-Fi Management Port

IP Address: 192.65.49.83

SSID: NSVisitor

Channel: 52



A **Wired Management Port** connection is established through the [optional USB-to-Ethernet interface](#) for the management port. Its details are displayed under the system Management Port notifications.

If your Management connection is lost, the following notification displays.

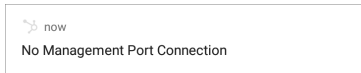

Discovery Notifications

The Discovery notifications show the progress of the discovery process. See the [Discovery](#) app chapter for more information.

 The active discovery process is running and has progressed to the specified percentage.

 No links are currently available for active discovery, either because none of the ports enabled for discovery are connected or AutoTest is running. Discovery is temporarily disabled when AutoTest is running.

VNC/Link-Live Remote

 A remote VNC connection is active through a standalone VNC client and/or the Remote function in [Link-Live Cloud Service](#).



AirCheck G3 ^

Remote Connected

Clients

172.24.0.219

Link-Live Remote: Angela Tech Writer

AirCheck G3 General Settings

AirCheck G3's General Settings control test and management-related connections that affect multiple test apps.

Access the General Settings from the [left-side navigation drawer](#)  in the NetAlly testing apps, such as AutoTest, Discovery, Capture, iPerf, etc.

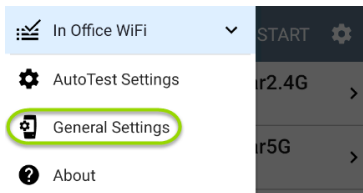

See also [Test and Management Ports](#) and [Test and Port Status Notifications](#) for related information on port functionality and status icons.

 **Wi-Fi** 

The Wi-Fi General Settings control functions of the [Wi-Fi Test Port](#) functions.

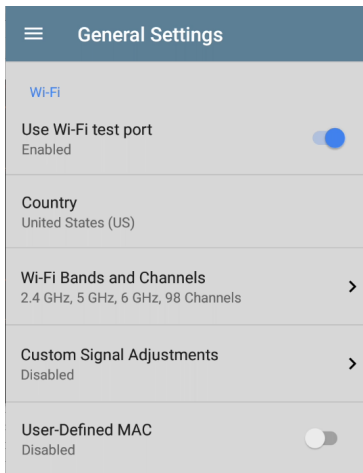

Use Wi-Fi test port: Enable or disable Wi-Fi tests, connections, and measurements in the testing apps, including [AutoTest Wi-Fi Profiles](#) and the [Wi-Fi](#) analysis app.

NOTE: This setting does not disable the main system device Wi-Fi function, which controls the Wi-Fi Management port connection. See [Device Settings](#) to disable the system Wi-Fi.

Country: Set the country code for your unit. This setting controls which channels can be scanned and which channels are reported as illegal or which may have Dynamic Frequency Selection (DFS).

Wi-Fi Bands and Channels: Select the wireless frequency bands and channels the unit scans for devices and measurements such as utilization.

Tap each band or channel setting to open a selection dialog.

Unchecking a Wi-Fi Band prevents any linking to, or scanning of, channels in that band.

Unchecking a Channel means the channel still links but does not get scanned.

Channel changes affect these apps: Air Quality scans, Wi-Fi results (scanning), Discovery, AirMapper (passive surveys)

Channel changes do *not* affect these apps:
AutoTest results (linking), Wi-Fi Capture,
AirMapper (active surveys)

Tap the **Dwell Time** field to adjust the amount of time the AirCheck G3 stays on each channel to gather data.

☰ Wi-Fi Bands and Channels	
Wi-Fi Band(s)	2.4 GHz, 5 GHz, 6 GHz
2.4 GHz Channels	All
5 GHz Channels	All
6 GHz Channels	All
Dwell Time	210 ms

Custom Signal Adjustments: Tap this setting and then tap the **Signal Adjustments** toggle to open an adjustment panel for each frequency band. You can adjust the signal strength for each band from -20 dB to +20 dB.

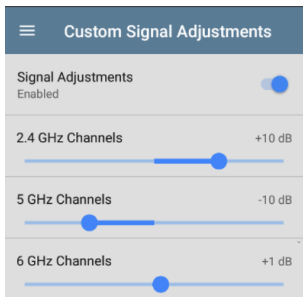

User-Defined MAC: This setting affects the [Wi-Fi Test Port](#) only. Tap the toggle switch to enable a user-defined MAC address. When enabled, an additional **User-Defined MAC** field appears under the toggle setting. Tap the lower field to enter your desired MAC address for the AirCheck G3. When a User-Defined MAC is enabled, **(User-defined)** appears next to the MAC address on the [About](#) screen and on relevant test result screens.

Management

These settings affect management-related functions on the AirCheck G3, including remote access.

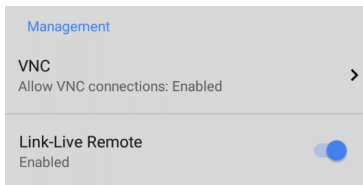

The screenshot shows a settings menu with a grey background. At the top, the word "Management" is written in blue. Below it, there are two settings items. The first is "VNC" with a right-pointing chevron. Underneath "VNC" is the text "Allow VNC connections: Enabled". The second item is "Link-Live Remote" with a blue toggle switch to its right. Underneath "Link-Live Remote" is the text "Enabled".

VNC

Tap **VNC** to open the VNC settings screen and configure your unit's VNC connections for remote operation.

See [Remote Access](#) for more information about connecting to a VNC client or Link-Live Remote.

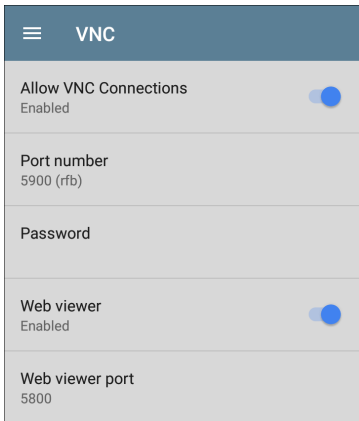

Allow VNC Connections: Tap the toggle button to enable or disable remote connections from VNC clients.

Port number: Tap to enter a port number other than the default.

Password: Tap to enter a password, which a VNC user must enter to access the AirCheck G3 interface remotely.

NOTE: If you set a **Password** here in the **VNC** settings, the password is required to connect to both a standalone VNC client and the Remote feature at Link-Live.com.

Web viewer: Tap the toggle to enable or disable web viewer access.

Web viewer port: Tap to enter a port number other than the default.

Link-Live Remote

This setting enables or disables the AirCheck G3's remote control function in [Link-Live Cloud Service](#) at [Link-Live.com](#).

NOTE: The Link-Live Remote feature is only available to customers with an active **AllyCare** subscription. Your AirCheck G3 must be [claimed](#). See [NetAlly.com/Support](#) for more information.

Access the Remote function on the **Units**  page at Link-Live.com by selecting the claimed AirCheck G3.

Preferences

Preferences

Distance Unit

Feet

Distance Unit: This is the unit AirCheck G3 uses for distance measurements in the testing apps, specifically [AirMapper](#). Tap the field to switch between Feet and Meters.

Save Locally Only: Tap this toggle field to change the unit default behavior for savings files. (The default is to give you the option to save to [Link-Live](#) or locally.)

Trending Graphs

Many of the AirCheck G3 testing apps feature time-based line graphs of recorded measurements, which you can pan and zoom to view different time intervals. For example, the image below shows the Signal and Utilization graphs from the [AutoTest Wi-Fi Link Screen](#).

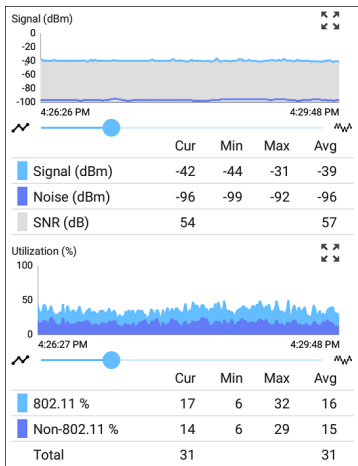

The graphs update in real time and then save and display data for up to 24 hours (depending on test type and/or link status).

A legend indicates the measurements that correspond to each plotted color.

For another example, the image below shows the **Capture** app graph.

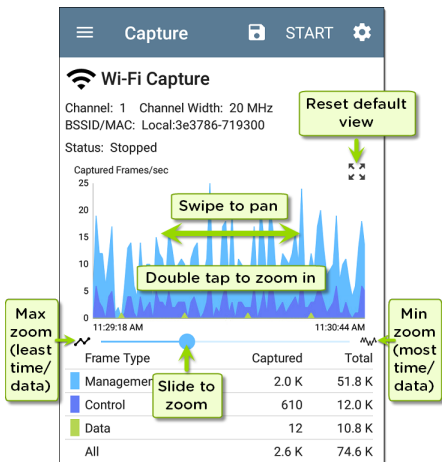

- To pan, or move backward and forward in time, touch and drag (swipe) left and right on each graph.
- To zoom in on a specific point, double tap the point on the graph. The view zooms in 2x (or displays half the amount of time) for each double tap.
- To zoom in or out, decreasing or increasing the time interval displayed, drag the slider or tap the slider bar below the graphs.
 - The largest time interval (maximum zoom out) is the total time data has accumulated.
- To reset the graph to the default time interval, tap the zoom reset icon .
- The zoom reset icon appears *after* you zoom or pan on the graph.
- The default time interval varies across different apps.

The following apps and screens contain trending graphs:

- [AutoTest Wi-Fi Profiles – Link and Channel](#)
- [Ping/TCP – Ping Test](#)

- Capture
- Discovery – Interface Statistics
- Wi-Fi – RF and Traffic Statistics
- iPerf

Common Icons

The icons below appear in multiple NetAlly test and system apps.



Menu Icon - opens the left navigation drawer or other menus



Refresh Icon - restarts testing and measuring on the current screen



Settings Icon - opens configuration options for the current app



Save Icon - saves settings or files or loads saved configurations



Floating Action Button (FAB) - opens the Floating Action Menu, which contains additional actions



Action Overflow Icon - contains additional actions



Directional Arrows (or Carets) - indicate the ability to "drill in," open a screen, or expand a panel for more detailed information, or to change the order of a list

For explanations of the AirCheck G3 icons that appear in the Status Bar at the top of the screen, see [Test and Port Status Notifications](#).

Floating Action Button (FAB) and Menu

Many system applications, including NetAlly's AutoTest and Discovery apps, feature a Floating Action Button or "FAB"  that opens a floating action menu with more options for analysis.

The FAB on the main AutoTest app screen allows you to add a new Wi-Fi or Air Quality Profiles.

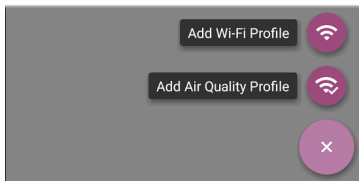

The FAB on the Discovery app's Details screen opens other apps for further testing of the selected device.

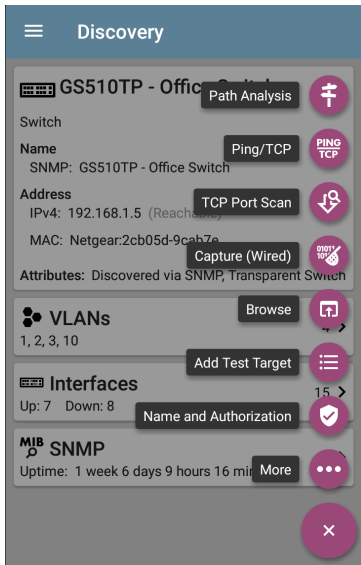

See the chapter for each app for descriptions of the FABs specific to that app. For example, see [Discovery App Floating Action Menu](#) describes the Discovery FAB in more detail.

Common Tools

Web Browser/Chromium

Some of the testing apps, like AutoTest, Ping/TCP, and Discovery, give you the option to **Browse** to internet addresses using a web browser application. AirCheck G3 has Google Chromium pre-installed.

Telnet/SSH

Starting with v1.1, AirCheck G3 has the JuiceSSH  application pre-installed. Both the AutoTest and Discovery apps provide options to start a Telnet or SSH session using the current device address. Selecting these options opens JuiceSSH and starts a session. You can also open JuiceSSH from the [Apps](#) screen.

The JuiceSSH app maintains a list of previous connections. When opened from a NetAlly app, JuiceSSH uses the first connection in the list that matches the IPv4 address or device name and type. If no match is found, a new connection entry is created and used.

As a third-party app, JuiceSSH contains its own tutorials. For additional help, tap the action overflow button  at the top right of the JuiceSSH app screen, and select **View our FAQ**.

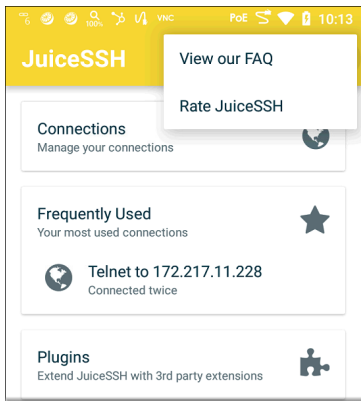

External Camera

The AirCheck G3 does not have a built-in camera, but you can use an external USB camera to take pictures to accompany Link-Live

data. The pictures can be shared or uploaded to the [Link-Live](#) cloud service with test data. You can also edit or annotate pictures in the Gallery app. NetAlly has verified that the following cameras work with the app:

- Logitech C270 HD Webcam
- EMEET 1080P Webcam
- NexiGo N660
- Microsoft LifeCam HD-3000

Set Up

To begin using the camera app:



1. Make sure your AirCheck G3 is [claimed to Link-Live](#).
2. Plug your USB camera into either the top or side USB 2.0 Type-A ports of your AirCheck G3.
3. From the Android home desktop, tap the **App Store** application.
4. Scroll down to the **USB Camera (AirCheck G3)** app from NetAlly.

5. Tap the blue **DOWNLOAD** button. Wait for the download to finishes and the blue button changes to show OPEN.
6. Verify the Download completes and the blue button changes to show OPEN.
7. Tap the **OPEN** button to launch the USB Camera app. The app then prompts you to set several options.
8. When prompted to allow the USB camera to take pictures and record video, select **WHILE USING THE APP**. The app launches and shows a preview image.
9. (Optional) To move the camera app icon to the system home desktop:
 - a. Tap the circular Home button at the very bottom of the system screen to view the desktop.
 - b. Swipe up from the bottom of the screen to view all installed applications.
 - c. Find the **USB Camera** icon.

- d. Press and hold the icon, and then drag it up into the home desktop icons area.

To Share an Image

To share an image to Link-Live:

1. From the system home desktop, launch the **USB Camera** app. The app opens and a live preview image appears in landscape mode.
2. Point the camera and press the circular **Shutter** button to take a picture. The **Share**  and **Delete**  icons appear on screen.
3. Tap the **Share**  icon to display the [Link-Live sharing screen](#).
4. Enter any a File Name, [comment](#), or [job comment](#) as needed.
5. Tap **SAVE TO LAST TEST RESULT** to attach the image to the last uploaded test result, or tap **SAVE TO UPLOADED FILES** to save the image to your Uploaded Files folder on Link-Live. (You can then view your uploaded files from a PC logged into Link-Live.)

Software Management

This chapter explains how to save and transfer files, reset app and device defaults, update your software, and remotely access your AirCheck G3.

Tap a link below to skip to your desired topic:

[Managing Files](#)

[Updating Software](#)

[Remote Access](#)

[Resetting App Defaults](#)

[Restoring Factory Defaults](#)

Managing Files

In AirCheck G3's operating system, images, documents, and other files reside in a folder system, where you can copy, move, and paste them between folders or to external storage locations.

See also [Navigating AirCheck G3](#).



Files Application

The Files app allows you to access the files saved on your AirCheck G3. Tap the  icon at the bottom of the Home Screen (or from the [Apps](#) screen) to manage your files.

NOTE: In the Files app, you may need to tap the action navigation icon  at the top left and select the **ACKG3** folder to show the device sub-folders, as shown below.



Downloads



Downloads



Images



Audio



Videos



E

FILES IN DOWNLOADS



CaptureFiles





20220000_101627.tgz

- Tap a folder or file to open it.
- **Long press** on folders or files to select multiple and to view additional file management operations in the top toolbar, including the **Share**  and Delete buttons.

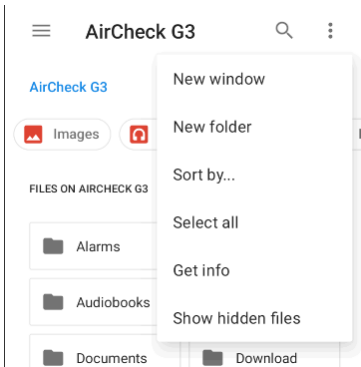

- Tap the action overflow icon  to see even more actions, such as to create a new folder, move a file, delete an item, and to show or hide the main internal storage folder.



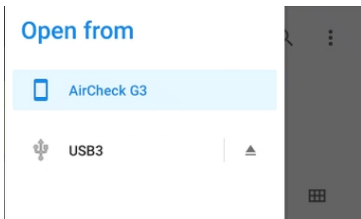

- Open the left-side navigation drawer  to easily navigate through the top-level folders and attached storage devices.

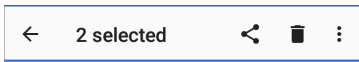

How to Move or Copy a File

1. Long press on a file to select it. You can then select more files as needed by tapping them.



2. Tap the overflow icon  at the top right.
3. Select **Copy to...** or **Move to....** Your selected action button appears at the bottom of the screen.





4. Navigate to the folder where you want to move or copy the file.
5. Tap the **Move** or **Copy** button at the bottom of the screen.

Using a USB Drive

Insert a USB flash drive into the [USB port](#) on the top of the AirCheck G3.

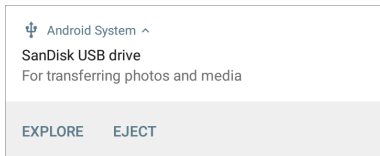
A USB icon  appears in the Status Bar at the top of the screen. Pull down the top [Notification Panel](#) to reveal the USB drive notification.



The **USB storage** location is now available from the [Files](#)  application.

 **CAUTION:** Use the system **EJECT** function before physically removing your USB drive from the USB port to avoid potential corruption of your storage device's file system.

Ejecting Storage Media

You can eject storage media from the expanded system notification (as shown above) in the Notification Panel or from the left-side navigation drawer in the Files app (below).

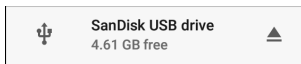

Using a USB Type-C to USB Cable

1. Plug a USB-C cable into the **USB-C** port on the left side of the AirCheck G3, and connect to a PC or tablet.
2. On the AirCheck G3 Unit, open the system device settings by tapping the Settings  icon at the bottom of the **Home screen**.
3. Select **Connected devices**.

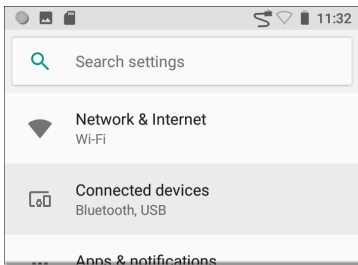

4. On the Connected devices screen, select **USB**.
5. In the pop-up dialog, tap **Transfer files** to enable file transfer.

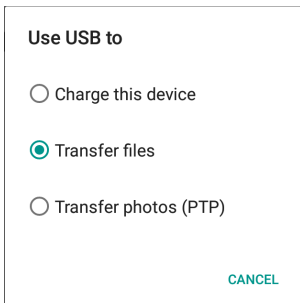

NOTE: AirCheck G3 does not charge through a USB cable connected to a PC.

6. On a PC or tablet, navigate to the AirCheck G3 folder, and then move, copy, and paste files to and from the AirCheck G3's file system.

 **CAUTION:** Use the system **EJECT** function before physically disconnecting the USB cable from your PC or AirCheck G3 to avoid potential corruption of your storage device's file system. See [Ejecting Storage Media](#) above.

Updating Software

Your AirCheck G3 accesses software updates from the Link-Live Cloud Service "Over-the-Air" (OTA). However, you can also manually download and install updates if you do not want to claim your unit to Link-Live. See [Manual Updates](#) below.

Over-the-Air Updates



For an OTA update, you must create an account and "claim" your AirCheck G3 unit at Link-Live.com. Then your AirCheck G3 can find and download software updates. See [Getting Started in Link-Live](#).

The first time you claim your AirCheck G3 to Link-Live, a software update may be available. If so, an update icon  appears in the Status Bar. Slide down the [Top Notification Panel](#), and then select the notification to update your unit.

 Link-Live

Software Update Notification

Software update available.

1. To check for available software updates at any time, open the [Link-Live App](#)  from the [Home screen](#).
2. In the Link-Live App, tap the menu icon  or swipe right to open the left-side [Navigation Drawer](#).

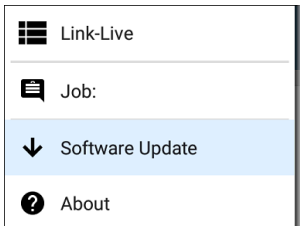

3. Tap **Software Update**.
The Software Update screen opens and displays the version number of any available updates.

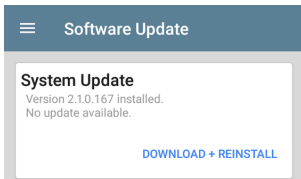

4. Tap **Download + Install** (or **Download + Reinstall**) to update the operating system and NetAlly applications. The update downloads and installs automatically. When finished, the unit restarts.
5. After updating, check the Software Update screen again in case another update is still required.

Manual Updates

You can acquire update files by contacting NetAlly's Technical Support at NetAlly.com/Support or by downloading them from Link-Live.com as follows:

1. Log in to the Link-Live web site.
2. Open the left-side navigation drawer by clicking the menu icon , and then select **Support > Software Downloads**.
3. Locate and select the update file for your unit (g3-ota-user.zip).
4. Save the update file to a PC.

Updating the System Software

Reference [Buttons and Ports](#) if needed.

1. From your PC, copy the .zip file to a FAT32-formatted Type A **USB drive**, and then insert the drive into your AirCheck G3.
2. Power off your AirCheck G3 unit.
3. Press and hold the **Volume Up** button, and then press the **Power** button. Continue to hold the **Volume Up** button until the Recovery screen appears. (You can release the **Volume Up** button a few seconds after this screen appears.)
4. In Recovery Mode, use the volume buttons to highlight **apply update from USB drive**,

and then press the **Power** button to confirm the selection.

5. Use the volume buttons to highlight the correct update file on the USB drive, and then press the **Power** button to confirm. The AirCheck G3 opens the Updater, installs the update, and then restarts with the update installed. This process can take 5 to 10 minutes. When complete, the message 'Install from USB drive completed with status 0.' should show on the install line.
6. Use the volume keys and **Power** button to select **reboot system now**. Your unit should boot normally.

Remote Access

AirCheck G3 supports remote access and control using either a standalone VNC client or the Link-Live Remote feature, which uses a VNC client through the Link-Live website.

NOTE: The Link-Live Remote feature is only available to customers with an active **AllyCare** subscription. Your AirCheck G3 must be **claimed**. See [NetAlly.com/Support](https://www.netally.com/support) for more information.

You can establish remote connections using the Wi-Fi Test Port. However, the Management Port provides a more stable link for remote control because the test port may disconnect and reconnect frequently.

See [Test and Management Ports](#).

The top [notifications](#) are the quickest way to find assigned IP addresses for your AirCheck G3 ports. Swipe down from the [Status Bar](#) to view them.

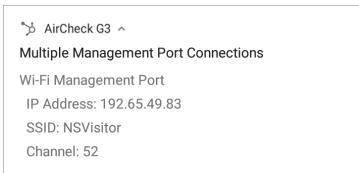

For a Wi-Fi Management Port connection, you must have the main [System Wi-Fi settings](#) configured to connect to a wireless network.

When a remote session is active, the remote icon  appears in the top Status bar, along with a notification.

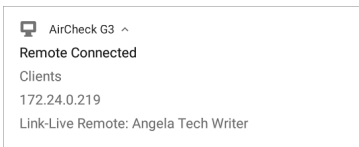

Using VNC

Remotely access the AirCheck G3 using a peer-to-peer VNC client installed on a PC or other machine.

See [General Settings > VNC](#) to enable and configure VNC connections.

To connect to AirCheck G3 using a VNC client:

1. Get the IP address of a connected port (preferably a management port) by swiping down from the Status Bar at the top of the screen to view the [notification panel](#).
2. Provide the Wi-Fi Test or Management Port's IP address to your chosen VNC client application.
3. Connect using your VNC client.
4. If needed, enter the password that is set in the [VNC settings](#).



Using Link-Live Remote

The Link-Live Remote feature uses end-to-end encryption, allowing secure remote control of your AirCheck G3.

On your AirCheck G3, go to [General Settings > Link-Live Remote](#) to ensure the feature is enabled.

NOTE: If a Password is enabled in the [VNC General Settings](#), you must also enter the

same password to access the Remote feature in Link-Live.

1. If you have AllyCare, sign in to Link-Live.com to access the Link-Live Remote feature. Your AirCheck G3 must be **claimed**.
2. Navigate to the **Units**  page at Link-Live.com.
3. Select the AirCheck G3 you want to remote control from the list of claimed units.
4. Click or tap the **REMOTE** icon  at the top right of the page to open an embedded window containing the AirCheck G3 interface.
5. If necessary, at the top of the window, enter the Password set in **General Settings > Management > VNC** on the AirCheck G3 unit.

To use the Link-Live website while your remote session is active, you must open a new Link-Live tab or window.

Managing NetAlly App Settings

This topic explains how to reset, [load](#), [save](#), [import](#), and [export](#) the test settings for individual NetAlly testing apps, such as AutoTest and Discovery.

For instructions on restoring factory defaults to the entire EtherScope unit, see [Restoring AirCheck G3 Factory Defaults](#).

Resetting Testing App Defaults

After you adjust settings in the NetAlly apps, you may need to reset an app's settings to the defaults. The following process resets all app-specific settings to the factory defaults.

 **CAUTION:** This operation deletes all saved settings, including testing profiles and other application data.

The Discovery app is used as an example in the following steps:

1. Access the **App Info** screen by long pressing (touch and hold) on an app's icon on the

Home or Apps screen.

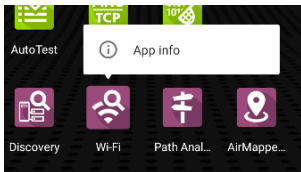

2. Tap **App info**.

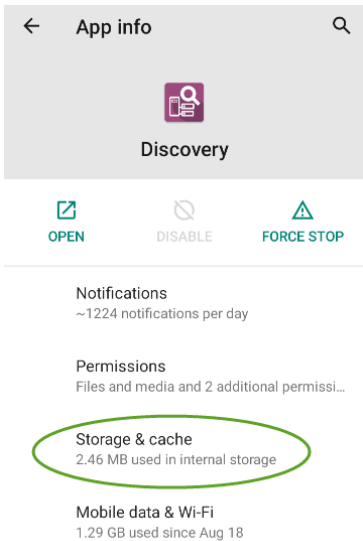

3. On the App info screen, select **Storage & cache**.
(You can also access the App Storage screen

from [Device Settings](#)  > **Storage** > **Internal shared storage** > **Other apps.**)

4. On the Storage screen for the app you selected, tap **CLEAR STORAGE**.

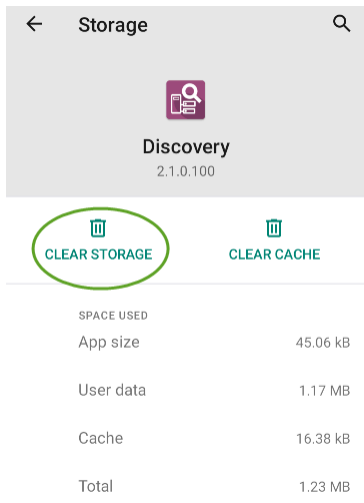

5. When a dialog prompts you to delete the data, tap **OK**.

All of the app's settings are reset to factory defaults.

Saving App Settings and Configurations

Many of the NetAlly testing applications allow you to save and reload configured settings by selecting the save button  that appears at the top right within the app's main screen.

The following apps enable you to save and load settings configurations:

- [AutoTest, including Profile Groups](#)
- [Discovery](#)
- [Discovery Problem Settings](#)
- [iPerf](#)
- [Spectrum](#)

The iPerf app is shown below as an example.

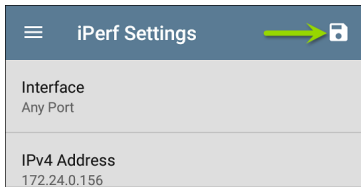

The following options display in a drop-down menu:

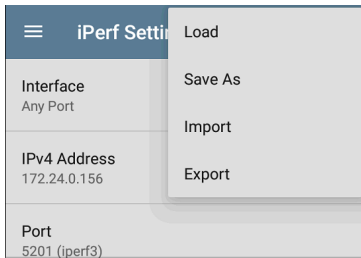

- **Load:** Open a previously saved and named settings configuration.

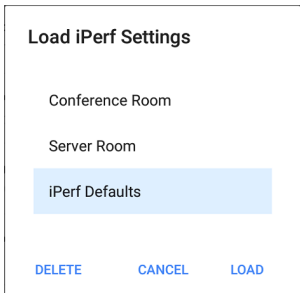

- **Save As:** Save the current settings with an existing name, or enter a new custom name.

Save iPerf Settings

Conference Room

Server Room

iPerf Defaults

Server Room



CANCEL SAVE

- **Import:** Import a previously exported settings file.
- **Export:** Create an export file of the current settings, and save it to internal or connected external storage.

See [Exporting and Importing App Settings](#) (below) for more details.

Saving a Default Test App Configuration

If you find you are frequently resetting app defaults, you can save  the default configuration of settings for later use within the NetAlly testing apps. Loading a saved default configuration within an app allows you to access the default settings without deleting other configurations. This strategy can be most useful for [Discovery Settings](#) and [Problem Settings](#).

1. Go to an app's settings  screen.
2. With all settings set to the defaults, tap the save button  and **Save As**.
3. Save a default configuration with an obvious name like "Default Profiles" or "Discovery Defaults."
4. Do not change the settings in your default configuration to non-defaults without also saving a new, custom-named configuration.

Exporting and Importing Settings

AirCheck G3 provides functionality for exporting and importing saved test app settings for transfer to additional units.

The following apps enable you to import and export settings configurations:

- [AutoTest Settings, including Profile Groups](#)
- [Discovery Settings](#)
- [Discovery > Problem Settings](#)
- [iPerf Settings](#)

The AutoTest Settings are shown as an example in the images below.

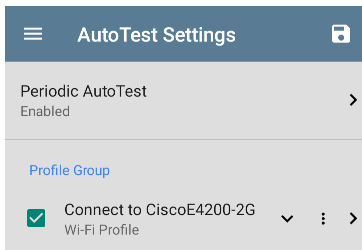

- Tap the save button  to import new app settings or export the *currently active and selected* app settings.

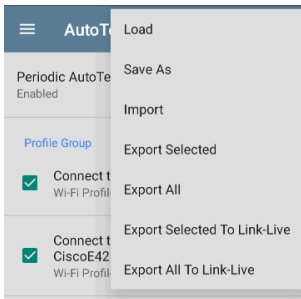

- Selected (checked) items in shared lists of configurations are the only ones exported when you choose **Export Selected**. This can include any checked items in submenus (such as AutoTest Test Targets or Community Strings in [Discovery Settings](#)). You can also select **Export All** to export all selected and unselected items.
- Unsaved configurations without a custom name are auto-named with the app name and date:

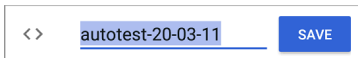

- Saved configurations are auto-named with the app name and custom settings name:

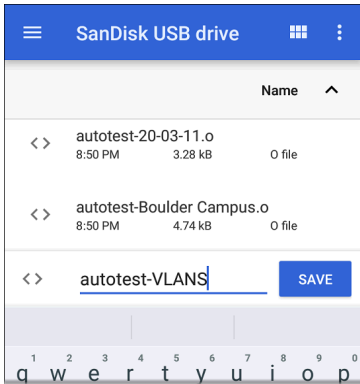

- You can rename the export file as needed.
- Settings can be saved to any connected external or internal storage. See [Managing Files](#) for instructions on accessing folders and moving files.
- Settings are saved with the **.o** file extension.

SanDisk USB...			
	Name		
<>	autotest-Boulder Campus.o	8:50 PM	4.74 kB
			0 file
<>	autotest-VLANS.o	8:53 PM	4.74 kB
			0 file
<>	iperf-Server Room.o	8:46 PM	234 B
			0 file
<>	lrpt-Ally Office Network.o	9:27 PM	1.41 kB
			0 file

- Selecting **Import** from an app opens the [Files](#) app, where you can navigate to and select the .o file you want to import.
- Imported settings configurations overwrite existing saved configurations with the same name that are already in the app.

Transferring AutoTest Settings to Other Devices Using Link-Live

You can use the Link-Live cloud service to transfer AutoTest settings with other AirCheck

G3 devices.



- Do some setup before you begin.
- Export the settings file(s) that you want to share to Link-Live.
- Use Link-Live to select other devices to which you want to transfer the settings.
- Use each selected unit to import the settings.

Before You Begin

- Make sure that you have access to the following:
 - a. The device from which you will get the settings
 - b. A PC-based browser
 - c. The devices to which you will transfer the settings file
- Make sure that you have claimed and updated the software for all AirCheck G3 devices to which you want to transfer the settings. (You can use the Link-Live app or web site to do the claiming. See ["Claiming the Unit" on page 600](#) for instructions.)

Export the Settings File(s)

This procedure is done on the device from which you are transferring the settings.

1. In the AutoTest app main page, tap the settings icon  in the top right. This opens the list of profiles.
2. If you plan to export only selected profiles, use the checkboxes to choose those profiles from the list.
3. Tap on the save icon  in the top right to display the save menu options.

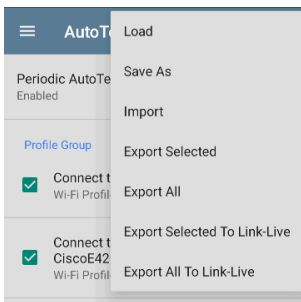

4. Tap **Export Selected To Link-Live** (if you selected profiles) or **Export All To Link-Live** on the menu. This opens the save screen for Link-Live.

**Link-Live**
by NetAlly

Settings File Name

autotest-shared settings

Comment

Update for all units

Job Comment

New profiles

EXPORT TO LINK-LIVE

5. (Optional) Edit the file name, add a comment, or add a job comment on the screen.
6. Tap **Export To Link-Live**. This uploads the file to Link-Live.

Use Link-Live to Select Other Devices

This procedure is best performed on a PC-based browser.

1. Use a PC-based browser to log in to the Link-Live web site.
2. Click the main menu icon .
3. Click on **Settings** to open the settings menu.
4. Select **AirCheck G3** to list the .o settings files available for your devices.
5. Select the settings file you want to transfer.
6. Follow the screen instructions to transfer the file to specific units or to all units that you have claimed.

Use Each Selected Unit to Import the Settings

This procedure is performed on the device to which you want to apply the settings.

1. Wait for up to 30 seconds after the file was pushed from Link-Live.
2. Swipe (touch and drag) downwards from the Status Bar at the very top of the home screen to display the Notification Panel.
3. Locate the notification that says there are new AutoTest settings from Link-Live and lists the profile name.

 AutoTest

New settings from Link-Live
autotest-autotest trial.o

4. Tap on that notification to open the AutoTest application.
5. Tap on the save icon  in the top right.
6. Tap on **Import** and navigate to Downloads.

7. Select the downloaded .o file to apply the new profile settings.

Resetting AirCheck G3 Factory Defaults

 **CAUTION:** Resetting your device to factory defaults can delete *all* test results, user-installed applications, testing app settings, and saved files.

1. Make sure to [back up any files](#) you wish to keep before resetting.
2. Open the system [Device Settings](#) by tapping the Settings  icon at the bottom of the Home Screen.
3. On the Settings screen, scroll down to and tap on the **System** section.
4. On the System screen, tap **Reset options**.

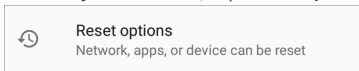

5. On the Reset options screen, select an option based on the defaults you want to reset. Your AirCheck G3 displays a list of the items that will be reset based on the option

and a confirmation button.

Reset Wi-Fi, mobile & Bluetooth: resets all network settings for Wi-Fi (test and management), mobile data, and Bluetooth.

Reset app preferences: resets any preferences or settings for applications, although app data is not lost.

Erase all data (factory reset):

 **CAUTION:** Erases *all* user data from your tester's internal storage, including: system and app data and settings; downloaded apps; test profiles; credentials; packet information; and screen captures.

6. Tap the confirmation button to begin the reset.
7. Your unit may ask you to confirm a final time before resetting. If so, tap the final confirmation button to reset your AirCheck G3's defaults. The unit then restarts with the factory default settings you selected.
8. Data on removable drives is not included in the reset. To be thorough, you may also

want to use the [Files application](#) to delete any application settings, preferences, or other data that you have saved on a USB thumb drive. (Do not delete your backup files.)



AirCheck G3 Testing Applications

This section of the User Guide describes the NetAlly-developed network testing apps. Each app is specially designed for fast analysis and intuitive operation to enhance and simplify your network tasks.

Open the testing apps by selecting their icons from the Home screen or the Apps screen.



AutoTest App and Profiles

AutoTest is the most comprehensive NetAlly testing application on AirCheck G3. You can quickly run a variety of test types and save their configurations and network credentials for access whenever you need them. The app is fully customizable with test "Profiles" for [Wi-Fi](#) and wireless [Air Quality](#) network connections, as well as individual [Test Targets](#)

AutoTest establishes the [Wi-Fi Test Port connections](#) used by other testing apps, like Ping/TCP and Capture.

AutoTest results are automatically uploaded to [Link-Live Cloud Service](#) after you claim your AirCheck G3.

AutoTest Chapter Contents

This chapter describes AutoTest Profiles, screens, settings, and test results.

[AutoTest Overview](#)

[Managing Profiles and Profile Groups](#)

[Main AutoTest Screen](#)

[Periodic AutoTest](#)

[Wi-Fi AutoTest Profiles](#)

[DHCP, DNS, and Gateway Tests](#)

[Test Targets](#)

AutoTest Overview

AutoTest consists of three distinct testing levels: **Test Targets**, **Profiles**, and **Profile Groups**. You can create as many Profile Groups, Profiles, and Test Targets as you need.

Profile Groups

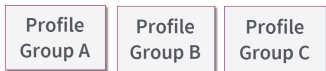

Profiles

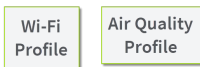

Test Targets

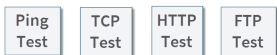

At the bottom level is a set of individual **Test Targets** that connect to network services, such as a web app or FTP site. A Test Target defines parameters including type, target URL/IP address, port number, and Pass/Fail thresholds. More complex tests, like HTTP, allow further Pass/Fail criteria, such as strings that must or must not be contained in the HTTP body.

A Test Target can be added to and used in any number of **Profiles**.

A **Profile** contains a series of individual network tests. There are two Profile types: Wi-Fi and Air Quality. Wi-Fi Profiles include connection tests and credentials for a Wi-Fi network. Air Quality is a passive scan of your wireless environment. Profiles provide an automated and consistent way to verify a network from layer 1 through layer 7.

A Profile can be added to and used in any number of **Profile Groups**.

A **Profile Group** is a custom-named collection of Profiles. Profile Groups are designed to allow further automation for testing multiple networks or network elements with a single tap of the START button.

A Test Target can be in any number of Profiles, and a Profile can be in any number of Profile Groups.

For example, you can:

- Test multiple Wi-Fi SSIDs from a single location.
- Test Wi-Fi access from a conference room.

Managing Profiles and Profile Groups

Profiles are a series, or suite, of tests designed to analyze the different characteristics of your networks. The AirCheck G3 AutoTest app features two types of test profile:

Wi-Fi Profiles test wireless connections.

Air Quality Profiles measure channel utilization and interference.

Factory Default Profiles

The AirCheck G3 begins with a default version of the AutoTest profile types, which you can customize, delete, or replace for your purposes.

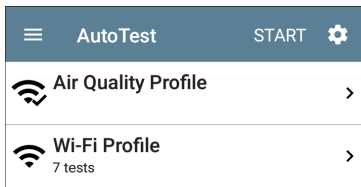

To customize each Profile with the required network settings and a custom name, tap the

Profile name *first*, and then select the settings  icon.

NOTE: Tapping the settings icon on the main AutoTest screen (shown above) opens the [AutoTest Settings and Profile Group](#) screen, not the individual Profile settings.

The default **Air Quality Profile** runs when you tap **START** on the main AutoTest screen or the Air Quality screen.

For the default **Wi-Fi Profile** to run successfully, you must select an SSID and enter security credentials before the AirCheck G3 can connect to a network.

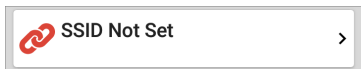

See [Wi-Fi Profile Connection Settings](#).

Adding New Profiles

To add new test profiles to the current AutoTest, tap the floating action button (FAB) on the AutoTest screen.

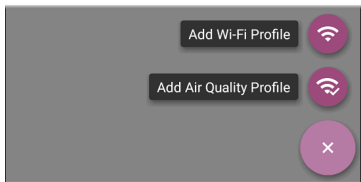

The profile's configuration screen appears after you select the type of profile you want to add. See the topic for each profile type for a description of its settings.

After you configure the profile settings, tap the back button  at the bottom of the screen to open and run the new test profile.

Creating a Wi-Fi Profile from the Wi-Fi Analysis App

You can also create an AutoTest Wi-Fi Profile from the [Wi-Fi Analysis](#) app's [SSID](#) or [BSSID](#) Details screen. This is a quick and easy way to add a Profile to connect to a Wi-Fi network in your vicinity.

Open the [Wi-Fi app](#)  from the Home screen.

Tap the menu button  to select the **SSIDs** or **BSSIDs** list screen.

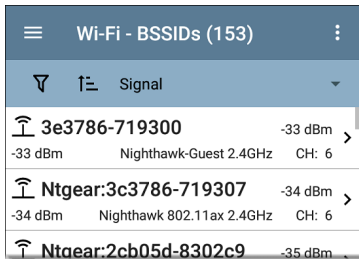

Tap an SSID or BSSID's card to open its Details screen.

Tap the FAB (floating action button)

 to open the floating action menu.

Wi-Fi - BSSID

 **Ntgear:3c3786-719307**
BSSID

SSID: **Nighthawk 802.11ax**

AP: **192.168.1.1**

BSSID: 3c3786-719307

802.11

Channel: 1

Types: ax, n, g, b

Signal: -30 dBm

SNR: 64 dB

Security Type: WPA2-E

Last Seen: 11:38:24 PM

Locate 

Connect 

Capture (Wi-Fi) 

Clients **Name and Authorization** 

RF and Traffic Statistics 

CH: 1 Utilization: 7%

In the floating action menu, tap **Connect**.

A Wi-Fi Profile called "Connect to [SSID/BSSID]" is created in AutoTest.

Profile 'Connect to Ntgear:
3c3786-719307' created.

Do you want to configure credentials
now?

NO

YES

The SSID, BSSID (if applicable), and Authentication Type are auto-populated in the [Wi-Fi Connection settings](#) for the new profile.

Tap **YES** in the pop-up dialog to review and configure additional credentials.

Wi-Fi Connection	
SSID	Nighthawk 802.11ax 2.4GHz
Authentication	WPA2 Personal
Encryption	Auto
Password	
Advanced	BSSID: Ntgear:3c3786-719307 >

Enter any additional credentials, like the network Password.

After configuring, tap the back button  to return to and run the new Profile.

Profile Groups

AirCheck G3 also allows you to save Profile Groups. Profile Groups are simply **the included list of test Profiles and the order in which they run** when you start an AutoTest. (See [AutoTest Overview](#) for more explanation of Profile Groups.) You can configure and select Profiles and Profile Groups for different locations, jobs, networks, or other purposes.

To manage your Profiles and Profile Groups, tap the Settings  button on the main AutoTest screen (with the list of Profiles).

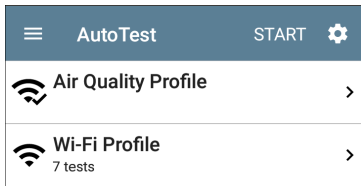

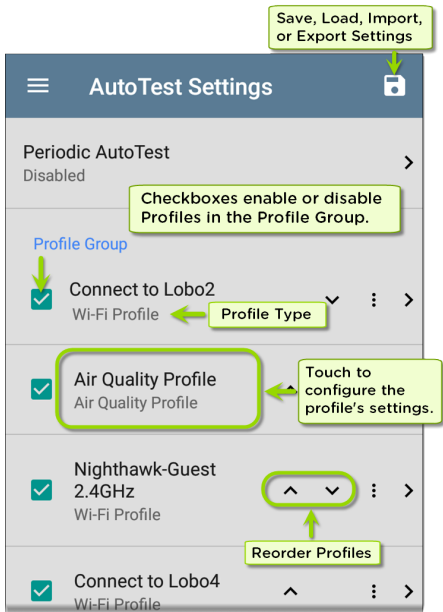

AutoTest Settings Screen

The AutoTest Settings screen contains the [Periodic AutoTest](#) and Profile Group settings.



You can perform these actions on the AutoTest Settings screen:

- Check or uncheck the boxes to include or exclude a test Profile from the currently active Profile Group.
- Tap the up and down arrows  to reorder the test Profiles on this and the main AutoTest screen for the Profile Group.
- Tap the action overflow icon  to **Duplicate** or **Delete** a Profile.

CAUTION: When you delete a Profile, it is deleted from all Profile Groups. To remove a Profile from the current group, simply uncheck it.

- Tap any Profile's name to open the test and connection settings for the Profile.
- Tap the save icon  to perform the following actions:
 - **Load:** Open a previously saved settings configuration, which includes the Profile Group.
 - **Save As:** Save the current settings and Profile Group with an existing name or a new custom name.

See also [Saving App Settings Configurations](#).

- **Import:** Import a previously exported settings file.
- **Export:** Create an export file of the current settings, and save it to internal or connected external storage.

See [Exporting and Importing App Settings](#) for more details.

Each Profile Group can run one or many of the three Profiles types. Your saved Profiles are available across all of your Profile Groups.

Custom AutoTest Settings/Profile Group Names

By default, the AutoTest app screen shows "AutoTest" in the header, and the AutoTest Settings screen header is "AutoTest Settings." Once you save a custom name, the name displays in the AutoTest app header and in the AutoTest Settings screen header.

In the example below, the user saves a custom AutoTest configuration named "Springs Campus."

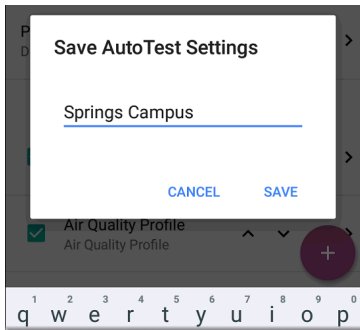



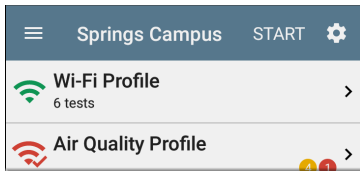

The main AutoTest app screen now displays the custom name in the header.





Creating New Profile Groups

To create a new Profile Group, follow these steps:

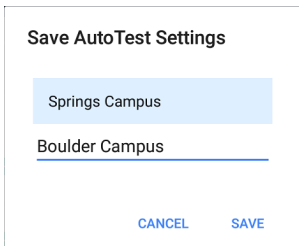



1. Go to the AutoTest Settings and Profile Group screen by tapping  on the main AutoTest screen.
2. Uncheck the boxes for any Profiles you do not want included in the new Profile Group.
3. Tap the **FAB**  to add new test Profiles to be included in your new Profile Group.
4. Tap the up and down arrows  to change the order in which the test Profiles run. Unchecked profiles automatically move to the bottom of the list once you leave and revisit this screen.
5. Tap , and select **Save As**. A dialog box opens, where you can enter the new name.







6. Enter a new Profile Group name, and tap **SAVE**. The AirCheck G3 returns to the Profile Group screen with the new group name shown as the title.



 **Boulder Campus** 

Periodic AutoTest 
Enabled

Air Quality Profile    
Air Quality Profile

Connect to The Office Network #1   
Wi-Fi Profile

Nighthawk 802.11 ax 5GHz  
Wi-Fi Profile

LRC  
Wi-Fi Profile



When running the "Boulder Campus" configuration shown above, AutoTest first scans the wireless channels for Air Quality results, then connects to "The Office Network #1", and remains connected to that network. This Profile Group will *not* connect to or test the "Nighthawk..." or "LRC" networks.

Importing and Exporting AutoTest Profiles

In addition to creating new profiles or using defaults, you can also:

- Import and export profile settings to any connected external or internal storage. See ["Exporting and Importing Settings" on page 132.](#)
- Use the Link-Live cloud service to transfer profile settings to other devices in near-real time. See ["Transferring AutoTest Settings to Other Devices Using Link-Live" on page 136.](#)

Main AutoTest Screen

To open the AutoTest app, tap the AutoTest icon  on the [Home screen](#).

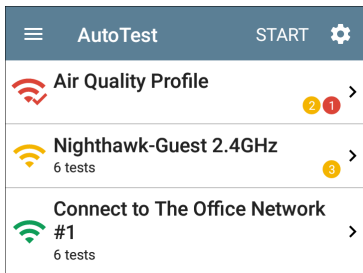

Tap the **START** button on the main AutoTest screen to run all the Profiles in the currently active [Profile Group](#).



The AutoTest screens display icons that correspond to the type of profile, test, or measurement. After running, these icons change color to indicate the status of the test:

- **Green** indicates a successful test or measurement within the set threshold.
- **Yellow** indicates a Warning condition.

- **Red** indicates test Failure.

The number of warnings or failures within each test profile is also displayed in a colored circle to the right of each profile card:   (2 Warnings, 1 Failure). The thresholds that control the colored test gradings are adjustable in the settings  screens for each profile and test type.

The green link icon  indicates an active network connection.

Each profile and test is summarized on a card. Tap a profile's or individual test's card to open and view test result details, including the causes of any Warnings or Failures.

Periodic AutoTest

The Periodic AutoTest feature allows you to run AutoTests at set time intervals.

Periodic AutoTest Settings

To enable and configure Periodic AutoTest, open the [AutoTest Settings and Profile Group](#) screen, and tap **Periodic AutoTest**.

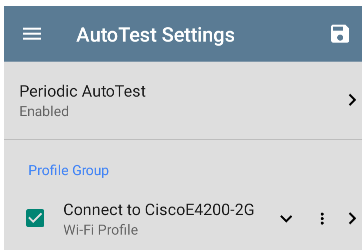

The Periodic AutoTest settings screen displays.

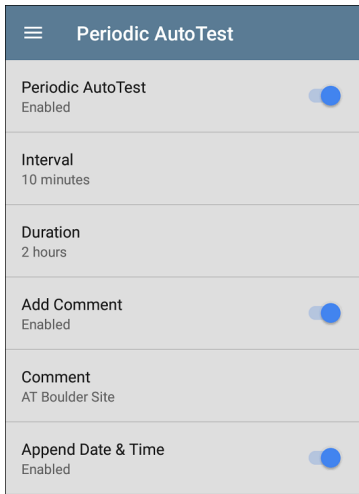

Tap the **Periodic AutoTest** field to enable, and adjust the settings below as needed.

Interval: Amount of time between each AutoTest run

Duration: Total length of time Periodic AutoTests run

Add Comment: Enabling this setting allows you to attach a comment to the Periodic AutoTest result in Link-Live Cloud Service. The comment appears as a label on the [Link-Live.com](https://link-live.com) Results page. This setting and the **Comment** setting below are enabled by default.

Comment: This field appears if the **Add Comment** setting is enabled. Enter the label you want to be attached to the uploaded Periodic AutoTest result on Link-Live. The default is "Periodic AutoTest."

Append Date & Time: This field appears if the **Add Comment** setting is enabled and adds a numeric date and time to the end of the **Comment** above.

Running Periodic AutoTest

Tap **START** on the main AutoTest screen to begin Periodic AutoTests. AutoTests continues to run at the set Interval for the selected Duration or until you tap **STOP** in AutoTest.

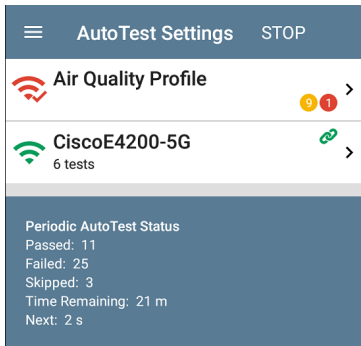

The Periodic AutoTest Status is summarized at the bottom of the AutoTest screens. Passes and failures are reported for each run of the entire Profile Group, rather than individual Profiles. Periodic AutoTests are skipped if the previous interval's test is still running when the next time interval occurs, such that the next run could not start.

The Periodic AutoTest icon  appears in the top [Status Bar](#) when Periodic AutoTest is running or has completed. Drag down on the

Status Bar to view the corresponding notification.

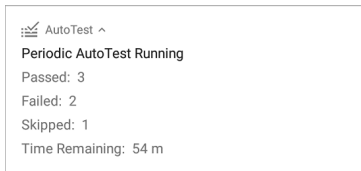

NOTE: AutoTest has priority control of the [Test Ports](#), so other apps, including [Discovery](#), [Wi-Fi](#), [Wi-Fi Capture](#), and [AirMapper](#), are paused while AutoTest completes.

Wi-Fi AutoTest Profiles

A Wi-Fi Profile runs a series of tests by connecting to a selected wireless network.

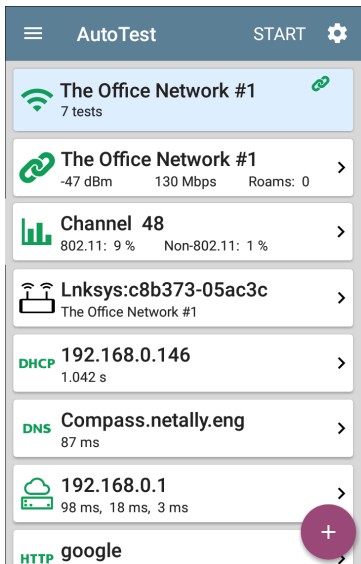

The screenshot shows the AutoTest app interface. At the top, there is a blue header with a hamburger menu icon on the left, the text "AutoTest" in the center, and "START" with a gear icon on the right. Below the header is a list of items:

- The Office Network #1** (7 tests) - highlighted in light blue, with a chain link icon on the right.
- The Office Network #1** - includes details: -47 dBm, 130 Mbps, Roams: 0, and a right arrow.
- Channel 48** - includes details: 802.11: 9 %, Non-802.11: 1 %, and a right arrow.
- Lnksys:c8b373-05ac3c** (The Office Network #1) - includes a router icon and a right arrow.
- DHCP 192.168.0.146** (1.042 s) - includes a right arrow.
- DNS Compass.netally.eng** (87 ms) - includes a right arrow.
- 192.168.0.1** (98 ms, 18 ms, 3 ms) - includes a cloud and server icon and a right arrow.
- HTTP google** - includes a right arrow.

A purple circular button with a white plus sign is located at the bottom right of the list.

Like the main AutoTest screen, Wi-Fi Profile tests are summarized on cards. Tap a card to view individual test screens.

Each test icon (except the AP) displays green, yellow, or red to indicate the status (or grade) of the completed test step: **Success/Warning/Fail**. The AP Test card shows the name and SSID of the connected AP. The AP test is not graded, so the icon stays black.

Wi-Fi Profiles do not run automatically. The factory default Wi-Fi Profile cannot run until you have configured an SSID with the proper credentials. (By default, AutoTest starts in Wi-Fi passive scanning mode if you do not have a profile set up.)



See the [Wi-Fi Profile Settings](#) topic for instructions.

After connecting to a network during a Wi-Fi connection test, AirCheck G3 remains connected until you run another Wi-Fi or [Air Quality](#) Profile or open the [Wi-Fi app](#). Wi-Fi Test Port linkage is

indicated in the top **Status Bar** with this notification icon, , which also shows the connected channel.

NOTE: When running an AutoTest Profile that connects to a network with a **Captive Portal**, a system notification icon  appears in the top Status Bar. Open and select the notification to open a web browser window where you can enter the required information for the captive portal.

Wi-Fi-Profile-Specific AutoTests

The tests that are specific to a Wi-Fi Profile include the wireless Link, Channel, and AP tests.

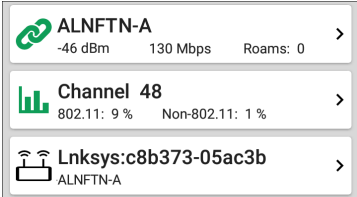

The screenshot shows three stacked cards for Wi-Fi profile-specific tests:

- Link Card:** Features a green link icon, the profile name **ALNFTN-A**, and real-time metrics: **-46 dBm**, **130 Mbps**, and **Roams: 0**. A right-pointing chevron is on the right.
- Channel Card:** Features a green bar chart icon, the title **Channel 48**, and channel usage statistics: **802.11: 9 %** and **Non-802.11: 1 %**. A right-pointing chevron is on the right.
- AP Card:** Features a Wi-Fi router icon, the AP name **Lnksys:c8b373-05ac3b**, and the profile name **ALNFTN-A** below it. A right-pointing chevron is on the right.

The link and channel cards update in real time to display the connection measurements for as

long as AirCheck G3 remains connected to the wireless network.

Link (Connection), Channel, and AP Results are described next.

Skip to [Wi-Fi Profile Settings](#).

Skip to [DHCP, DNS, and Gateway Tests](#).

Skip to [Test Targets](#).

Wi-Fi Profile Test Results

The image below shows a completed AutoTest Wi-Fi Profile.





The screenshot displays the AutoTest app interface with a dark blue header. The header contains a hamburger menu icon, the text "AutoTest", the word "START", and a gear icon for settings. Below the header, the test results are presented in a list of white cards with light blue borders. The first card, "Connect to The Office Network #1", has a Wi-Fi icon, a link icon, and a yellow circle with the number "1". The second card, "The Office Network #1", includes a link icon, signal strength (-42 dBm), speed (130 Mbps), and roaming status (Roams: 0). The third card, "Channel 6", features a bar chart icon and shows channel usage (802.11: 36%, Non-802.11: 5%). The fourth card, "Lnksys:c8b373-05ac3b", has a router icon and identifies the network as "The Office Network #1". The fifth card, "DHCP 192.168.0.140", shows a response time of <1 ms. The sixth card, "DNS cosopendns1.net.com", shows a response time of 34 ms. The seventh card, "192.168.0.1", shows response times of 23 ms, -, and 18 ms. The eighth card, "PING google", is partially visible. A purple circular button with a white plus sign is located at the bottom right of the list.

AutoTest START

- Connect to The Office Network #1**
7 tests
- The Office Network #1**
-42 dBm 130 Mbps Roams: 0
- Channel 6**
802.11: 36 % Non-802.11: 5 %
- Lnksys:c8b373-05ac3b**
The Office Network #1
- DHCP 192.168.0.140**
<1 ms
- DNS cosopendns1.net.com**
34 ms
- 192.168.0.1**
23 ms, -, 18 ms
- PING google**

This Profile connects to SSID "The Office Network #1." The Profile is displaying one **Warning** condition from a timeout of the second Gateway ping.

On the Wi-Fi Profile screens, you can perform these actions:

- Tap any of the test result cards, like  Link ,  Channel, or  AP, to open the individual test result screens.
- From any individual test screen, tap the settings icon  to go directly to the settings for the current test.
- On individual test screens, tap [blue underlined links](#) to open a [Wi-Fi](#) app Details screen showing the selected device or ID.
- Tap other **BLUE LINKS** or the action overflow icon  at the bottom of test results screens for additional actions.

NOTE: Blue links and action icons do not appear on every test screen, and if the network connection is dropped, you may need to rerun the Profile to re-establish link and enable additional actions.

The rest of this topic describes the individual test cards and screens using the Wi-Fi Profile results for the "LRG" SSID shown below.

The screenshot shows the AutoTest application interface. At the top, there is a status bar with various icons and the time 3:05. Below the status bar is a dark blue header with a hamburger menu icon, the text "AutoTest", the word "START", and a gear icon for settings. The main content area consists of several test result cards, each with a green icon on the left and a chevron on the right. The cards are as follows:

- LRG** (Wi-Fi icon): 8 tests
- LRG** (Link icon): -33 dBm, 486 Mbps, Roams: 3
- Channel 153** (Bar chart icon): Utilization: 12 %
- Sonicw:18b169-c84385** (Router icon): LRG
- DHCP 10.24.8.225** (DHCP icon): 18 ms
- DNS dns.google** (DNS icon): 14 ms
- 10.24.8.1** (Cloud icon): 2 ms, <1 ms, <1 ms
- HTTP google** (HTTP icon):

A purple circular button with a white plus sign is located in the bottom right corner of the test results list.



Wi-Fi Link Test Results

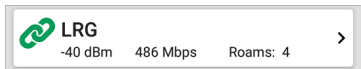

The Wi-Fi link test card indicates whether you can connect to the configured network at your current location. The Wi-Fi Link card displays the SSID, current signal strength (dBm), link speed (Mbps), and number of roams.

Refer to [Wi-Fi Connection Settings](#) if needed.

Tap the card to open the Link test screen.

Wi-Fi Link Test Screen



CoFC-GuestNet

-47 dBm

130 Mbps

Roams: 4

SSID: [CoFC-GuestNet](#)

Security: Open

Roams: 4

AP: [10.10.0.5](#)

BSSID: [RuckusWi:543d37-299cb8](#)

Channel: 11

Last Roam From

AP: [543d372c7ed8](#)

BSSID: [RuckusWi:543d37-2c7ed8](#)

Channel: 11

Results

Signal (dBm)



The Wi-Fi Link test screen shows these results:

SSID

Security: Security protocol in use on the network

Roams: Number of times the unit has disconnected from the previous AP and

connected to a different AP with a better signal strength. This behavior is partly controlled by the **Roam Threshold** in the [Wi-Fi Connection](#) settings.

AP: Name, IP, or MAC address of the AP to which the Tester is connected, depending on the information AirCheck G3 can see about the AP. This field shows the custom User Name if one has been entered. See [Assigning a Name and Authorization to a Device](#) in the Wi-Fi app chapter.

BSSID: BSSID of the access point

Channel: Channel number on which the AP is operating

Last Roam From: If the AirCheck G3 has roamed to a new AP, the previous AP's name, BSSID, and Channel display.

AP: Channel number on which the AP is operating

BSSID: BSSID of the access point

Channel: Channel number on which the AP is operating

Wi-Fi Link Trending Graphs

AirCheck G3's trending graphs operate similarly across different testing apps, allowing you to pan and zoom to view different time intervals. Swipe, double tap, and move the slider to adjust the graph views. See the [Trending Graphs](#) topic for an overview of the controls.

Results



	Cur	Min	Max	Avg
Signal (dBm)	-38	-79	-23	-48
Noise (dBm)	-92	-98	-89	-92
SNR (dB)	54			44



	Cur	Min	Max	Avg
802.11 %	7	1	29	7
Non-802.11 %	2	0	21	3
Total	9			10

The Wi-Fi Link Test graphs save and display data for up to 24 hours in the past if the unit stays linked. The default time interval shown is 2 minutes.

Under each graph, a legend table displays the Current, Minimum, Maximum, and Average measurements. The Current column contains measurements from the last second. Min, Max, and Avg columns show cumulative measurements.

Signal (dBm) graph: Plots the signal strength in dBm of the connected AP.

- Green vertical bars - The tester roamed to a new AP.
- Signal - The AP's signal strength in dBm.
- Noise - The noise level in dBm on the channel used.
- SNR - The network's signal-to-noise ratio in decibels (dB).

Results

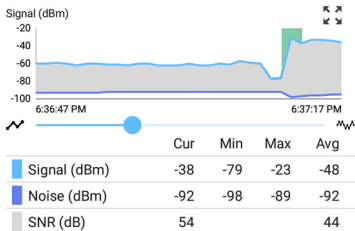

Utilization (%) graph: Plots percentage of the connected channel's capacity being used by 802.11 devices and by non-802.11 interference.

- Green vertical bars - The tester roamed to a new AP.

Retries (% of packets) graph: Plots percentage of transmitted packets that are retry packets

- Retry Rate % - The percentage of total packets that are retry packets.
- Retry Pkts - The number of retry packets seen in the current sample cycle.
- Total Pkts - The total number of packets transmitted in the current sample cycle.

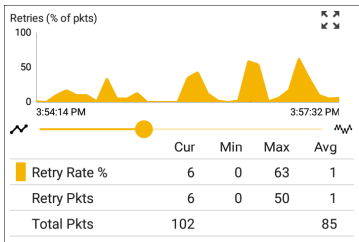

PHY TX Rate (Mbps) graph: Plots the physical transmission rate. The green horizontal dotted line shows the AP's maximum TX rate.

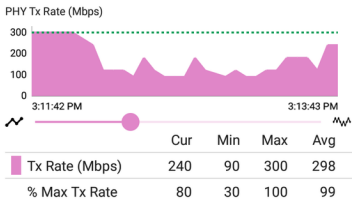

Ping or TCP Connect Response Time graph:

This graph displays on the Link test screen if you run a Ping or TCP Connect test, using the

Ping/TCP app, over the Wi-Fi test port connection while the Profile is linked.

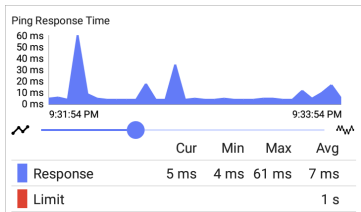

Follow these steps to view the Response Time graph:

1. Tap the blue **PING** hyperlink at the bottom of the Link test screen. This opens the Ping/TCP app with the **Interface** set to Wi-Fi Port and **Protocol** set to Ping.
2. Access and adjust the Ping/TCP settings as desired.
3. **START** the Ping or TCP Connect test.
4. Tap back  to go back to the AutoTest Wi-Fi Link screen. The Response Time graph appears near the bottom of the screen and

updates in real time along with the other graphs for the duration of the Ping/TCP test.



Result Codes: Final status of the test (Success or Failure)

Tap the blue links at the bottom of the link test screen to open the [Ping/TCP](#) app, view the **CONNECT LOG**, or run a Wi-Fi packet [CAPTURE](#) on the connected channel and AP.

Connect Log

Connect Log	
4:52:26.734 PM	Wireless: SSID LRG
4:52:27.100 PM	WPA2 Personal
4:52:29.892 PM	Link Down
4:52:29.892 PM	Connecting to AP: 18:b1:69:c8:43:8d Chan 1
4:52:29.893 PM	Send Open Authentication Request
4:52:30.317 PM	Authentication Timeout
4:52:30.319 PM	Connecting to AP: 18:b1:69:c8:43:8d Chan 1
4:52:30.319 PM	Send Open Authentication Request
4:52:30.320 PM	Receive Open Authentication Success
4:52:30.320 PM	Send Association Request
4:52:30.320 PM	Wireless: WPA2 Info Element: Mcast=([4] AES-CCMP) Ucast=([4] AES-CCMP) Auth=([2] PSK)
4:52:30.321 PM	Receive Association Success

The Connect Log shows the Wi-Fi connections, including driver activity, supplicant, and the DHCP process. The Connect Log can be especially helpful for identifying linking or roaming problems.

Select the action overflow icon  at the top right on the Connect Log screen to attach the log to its associated AutoTest result on the [Link-Live](#) website, or attach the Connect Log from the [floating action menu](#)  on the main Profile screen. See [Wi-Fi Profile FAB](#) below.

Channel Test Results

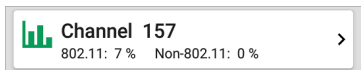

The Channel card shows the channel on which the AP is operating and the current 802.11 and Non-802.11 utilization.

Refer to [Channel Test Settings](#) if needed.

Channel Test Screen

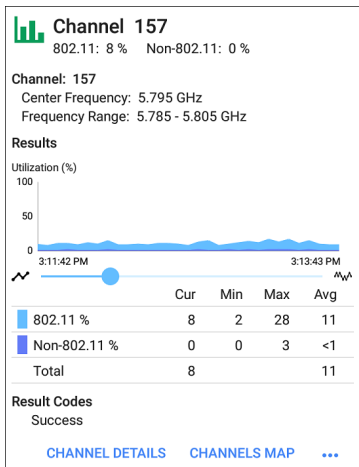

The Channel Test results screen indicates the **Center Frequency** and **Frequency Range** of the connected channel along with a real-time Utilization graph.

Results: The channel Utilization (%) graph updates in real time for as long as the unit is still

connected to the network. The graph saves and displays data for up to 24 hours if the unit stays linked.

To pan and zoom on the graphs, you can swipe, double tap, and move the slider. See the [Trending Graphs](#) topic for an overview of the graph controls.

Utilization (%) graph: Plots percentage of the connected channel's capacity being used by 802.11 devices and by non-802.11 interference

- **802.11 %:** Percentage of channel capacity being used by 802.11 devices
- **Non-802.11 %:** Percentage of channel capacity being used by non-802.11 interference
- **Total:** Total percentage of both 802.11 and non-802.11 channel utilization

Results Codes: Final status of the test (Success or Failure)

Tap the blue links at the bottom of the channel test results to open the Wi-Fi app's [CHANNEL DETAILS](#) or [CHANNELS MAP](#) screens, or to run a

Wi-Fi packet **CAPTURE** on the connected channel.

AP (Access Point) Test



The AP card shows the AP's name and the SSID of the network it is supporting. The AP name or address shown is based on what the AirCheck G3 is able to gather from the device and network. If the AP has a **custom user name**, that name is shown on the card and test screen.

The AP test is not graded, so the icon remains black.

AP Test Screen

AutoTest

10.24.8.29
LRG

Device Name: [10.24.8.29](#)

IP Address: 10.24.8.29
MAC Address: Sonicw:18b169-c84603

SSID: [LRG](#)

Security: WPA2-P
Roams: 0

802.11
Channels: **157**, 159
Type: n
Supported Types: b, g, n

Client Associations: 3
Roam Scans: 3

[CONNECT LOG](#) [PATH ANALYSIS](#) ...

In addition to the AP name and SSID, the AP test screen shows the following:

Device Name: AP's name or address

IP Address: The AP's assigned IP address. If none could be determined, the field displays dashes --.

MAC Address: The AP's MAC address

SSID: Name of the network on which the AP is operating

Security: Security protocol in use on the network

Roams: Number of times the unit has roamed and connected to a different AP

802.11

Channel(s): Channel or channels the AP is operating on. If the BSSID is on multiple channels, the **bold** channel number indicates the primary channel.

Type: 802.11 type in use on the current link

Supported Types: 802.11 types that the BSSID supports. If none could be determined, the field displays dashes --.

Client Associations: The number of client devices connected to the AP

Tap the blue links at the bottom of the link test screen to view the [CONNECT LOG](#) or run a [PATH ANALYSIS](#) to the AP.

Open the overflow menu **•••** for additional actions, such as to run a Wi-Fi packet [CAPTURE](#)

on the connected channel and AP, or start a [Telnet or SSH](#) session using the AP's IP address.

DHCP, DNS, and Gateway Results

See [DHCP, DNS, and Gateway Tests](#).

PING FTP TCP HTTP Target Tests

See the [Test Targets](#) topic for information on target test results.

Wi-Fi Profile FAB

The floating action button (FAB) on the Wi-Fi Profile AutoTest Profile screens allows you to attach comments, an image, and the [Connect Log](#) to this AutoTest result on the [Link-Live](#) website.

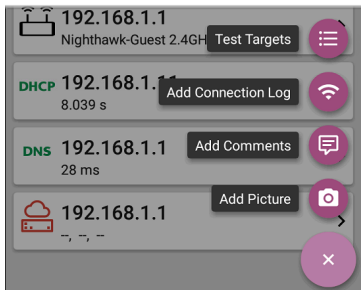

- The **Test Targets** option opens the [Test Targets](#) screen, where you can add Ping, TCP Connect, HTTP, and FTP target tests to the current profile.
- **Add Connection Log** opens a Link-Live sharing screen that allows you to custom name the log file before saving to the test result.



Connection Log Name

20191022_122355



SAVE TO TEST RESULT

Tap the field to enter your desired log name, and tap **SAVE TO TEST RESULT** to upload.

- **Add Comments** also opens a Link-Live [sharing](#) screen where you can enter comments.

Comment

Conference Room

Job Comment

North Office



SAVE TO TEST RESULT

Tap the fields to enter your desired comments, and tap **SAVE TO LAST TEST RESULT** to upload them.

See the [Link-Live App](#) chapter to learn about Link-Live and uploading.

Wi-Fi Profile Settings

These settings control which network is tested, how the AirCheck G3 connects, thresholds for **Success/Warning/Fail** results, and any user-added test targets.

To configure the profile settings, tap the settings icon  on the Wi-Fi Profile screen, or [add a new Wi-Fi Profile](#) to AutoTest.

Tap the links below to skip to later sections in this topic:

- [Wi-Fi Connection Settings](#)
- [Certificates](#)
- [Advanced Wi-Fi Connection Settings](#)
- [Channel Test Settings](#)

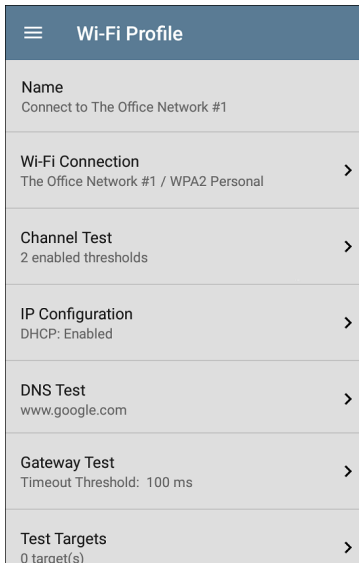

On the **Wi-Fi Profile** settings screen, tap each field described below as needed to configure the profile. Changed settings are automatically applied.

NOTE: If you add a new Wi-Fi profile from the [Wi-Fi Analysis](#) app, the Profile Name, SSID, and Authentication type are auto-populated. See [Creating a Wi-Fi Profile from the Wi-Fi Analysis App](#).

When you finish configuring, tap the back button  to return to the profile.

Name

Tap the **Name** field to enter a custom name for the profile. This name appears on the main AutoTest screen profile card and the Wi-Fi profile screen header.

Wi-Fi Connection Settings

Open **Wi-Fi Connection** settings to configure network IDs, security credentials, and test thresholds for the Link  test. These settings control the [Wi-Fi Test Port](#) connection.

Wi-Fi Connection	
SSID	QA-Ruckus-WPA2-E
Authentication	WPA2 Enterprise
Encryption	Auto
EAP Type	EAP TLS
Username	TestUser
Certificate	client_cert_freeradius.p12 >
Advanced	BSSID: Any, Wi-Fi Band: Auto >

SSID

Tap to enter an **SSID** or select from the list of discovered SSIDs. If you do not enter a custom

Name for the Profile, the SSID is displayed as the Wi-Fi Profile's name.

Authentication

If you selected an **SSID** from the drop-down list of discovered SSIDs in the setting above, or created a "Connect to [SSID]" profile from the Wi-Fi app, the Authentication type is automatically selected. If needed, tap to open the **Authentication** dialog and select the correct security type for the network.

The following settings depend on the Authentication type. Enter all necessary credentials for the network security type, such as Encryption, Keys, EAP type, username, certificate, and/or password.

WEP Key

This setting appears if the Authentication type is **WEP Shared** or **WEP Auto**. Tap to select the correct key type (ASCII or Hex) and enter the key.

Encryption

Tap to select an encryption type if needed. The default is "Auto."

EAP Type

This setting appears if the Authentication type is **WPA/WPA2/WPA3 Enterprise**. The default is PEAP MSCHAP V2. Tap to select a different EAP type if needed.

Username

This field appears along with multiple authentication types. Tap the **Username** field to enter your username.

Certificate

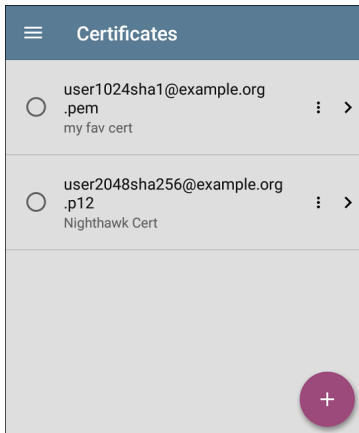

This setting appears if you selected one of the following EAP types: **EAP TLS**, **PEAP TLS**, or **TTLS EAP TLS**.

Tap to open the Certificates screen.



This screen displays all the certificates that have been imported to AutoTest via the Wi-Fi Profile settings.

- Tap the radio button to the left of an imported certificate to select and use it with the current Profile.
- Tap a certificate's row to edit its name and description.

- Tap the action overflow icon  to **Delete** an imported Certificate.
- Tap the floating action button (FAB)  to import a new certificate file.

AirCheck G3 supports these certificate file extensions:

- .pem
- .p12
- .cer
- .crt

The imported certificate feature is meant for client authentication and must include the private key. The AirCheck G3 supports 1-way client authentication only; mutual authentication, Server, and CA/Root certificates are not supported. While AirCheck G3 can perform a key exchange, it does not authenticate the server certificate.

[Tap here](#) to skip the following "How to" section and go to [Advanced Wi-Fi Connection Settings](#).

How to Import a Certificate:

Certificate files can be imported from either an inserted storage device (USB) or the AirCheck

G3's internal file system.

1. Make the certificate file available on your AirCheck G3 unit by saving it to a USB drive inserted into your unit or by transferring to the file system using a USB-C cable or email. (See [Managing Files](#) for help.)
2. To run an [AutoTest Wi-Fi Profile](#) using certificate authentication, set up the profile with the following settings:
 - a. Authentication: **WPA/WPA2/WPA3 Enterprise**
 - b. Encryption: **Auto**
 - c. EAP Type: **EAP TLS, PEAP TLS, or TTLS EAP TLS**
3. In **AutoTest > Wi-Fi Connection** settings, tap the **Certificate** setting to open the Certificates screen.

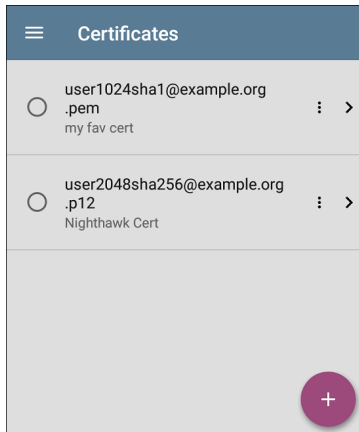

4. Tap the floating action button (FAB)  to open the Import Certificate dialog box.

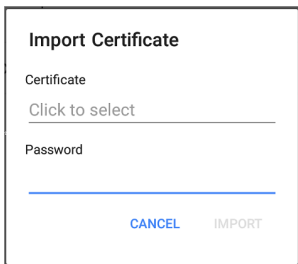

5. Tap **Click to select** beneath the Certificate field to open the **Files** app.

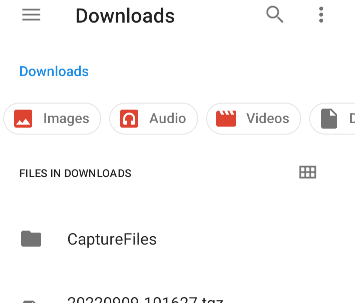

6. In the Files app, navigate to the folder or storage device where your certificate file is saved. Tap the menu button \equiv to open the left-side navigation drawer and access the storage devices.

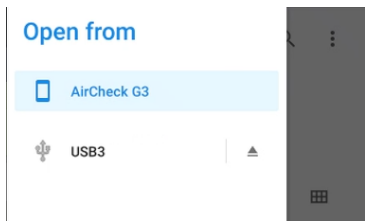

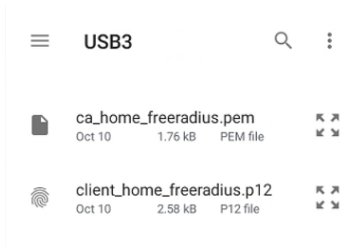

In the image above, the user is navigating to a USB flash drive.

7. Navigate to the required certificate file, and tap to select it.



After you select the file, the Files app closes, and the Import Certificate dialog displays the chosen certificate file.

8. Enter the certificate's password if it is password protected.
9. Tap **IMPORT**.
10. If desired, tap the fields to edit the **Name** and **Description** of the certificate. The name defaults to the certificate file name.
11. Tap the back button  to return to the Certificates list screen. The newly added certificate appears selected in the list.
12. Tap the back button  to return to the Connection settings.

After running the AutoTest, you can review the **Connect Log** from the [Wi-Fi Link Test screen](#) to verify or troubleshoot certificate authentication.

Username

This field appears along with multiple authentication types. Tap the **Username** field to enter your username.

Password

This field appears along with multiple security types. Tap the **Password** field to enter the network password.

Advanced (Wi-Fi Connection) Settings

Advanced	
BSSID	Any
Wi-Fi Band	Auto
Roam Threshold	-70 dBm
Link Test Thresholds	4 enabled thresholds >
Alternate ID	

BSSID

Enter or select a specific BSSID for the Wi-Fi Profile to prevent the AirCheck G3 from roaming to a new AP while linked.

Wi-Fi Band

Tap this setting to specify the wireless band(s) on which the Wi-Fi Profile attempts to connect. The default setting of Auto allows the unit to connect on any band. Note that the Profile fails to link if this setting conflicts with the selected bands in [General Settings](#).

Roam Threshold

This threshold controls the Signal Strength (in dBm) at which AirCheck G3 stays connected and looks for another AP on the network with a stronger signal. If found, it disconnects from the current AP and connect to the AP with a stronger signal. Tap the field to select a new value or enter a custom one.

Link Test Thresholds

Open the **Link Test Thresholds** screen to adjust the values that determine **Success/Warning/Fail** results for the following measurements.

Link Test Thresholds	
Signal Level Thresholds Enabled	<input checked="" type="checkbox"/>
Warning -70 dBm	
Failure -85 dBm	
Signal-to-Noise (SNR) Thresholds Enabled	<input checked="" type="checkbox"/>
Warning 25 dB	
Failure 10 dB	
Retries Thresholds Enabled	<input checked="" type="checkbox"/>

Tap each field to select a new value or enter a custom one. Each threshold also has a toggle button that allows you to disable grading based on that measurement entirely.

Signal Level Thresholds: Measured signal from the AP

Signal-to-Noise (SNR) Thresholds: Ratio of measured AP signal to noise level detected on the channel

Retries Thresholds: Retry frames as a percentage of total transmitted frames

Transmit Rate (TX) Thresholds: Measured rate as a percentage of the AP's maximum throughput rate

Alternate ID

Enter an Alternate ID if necessary. This is an Advanced Authentication setting.

Channel Test Settings

Open **Channel Test** settings to configure Utilization thresholds for the channel test portion of the Wi-Fi profile.

Channel Test	
802.11 Utilization Threshold (%) Enabled	<input checked="" type="checkbox"/>
Warning 35 %	
Failure 75 %	
Non-802.11 Utilization Threshold (%) Enabled	<input checked="" type="checkbox"/>
Warning 30 %	
Failure 50 %	

802.11 Utilization Threshold (%)

This threshold controls the **Success/Warning/Fail** gradings for the percentage of the connected channel's capacity being used by 802.11 devices.

- Tap the toggle button to enable or disable test grading based on 802.11 utilization.
- Tap **Warning** or **Failure** to select or enter custom percentage values for Warning or Failure results.

Non-802.11 Utilization Threshold (%)

This threshold controls the **Success/Warning/Fail** gradings for the percentage of the connected channel's capacity being used by non-802.11 interference.

- Tap the toggle button to enable or disable test grading based on non-802.11 utilization.
- Tap **Warning** or **Failure** to select or enter custom percentage values for Warning or Failure results.

DHCP, DNS, and Gateway Settings

See [DHCP, DNS, and Gateway Tests](#)

PING FTP TCP HTTP Test Targets

Tap the **Test Targets** field to open the Test Targets screen and add custom **Ping, TCP**

Connect, HTTP, or FTP Tests to your AutoTest profile. See [Test Targets](#) to learn more.

HTTP Proxy

The Proxy control lets you specify a proxy server through which the AirCheck G3 establishes a network connection. In AutoTest, these settings are used when HTTP Proxy is enabled in an [HTTP](#) or [FTP](#) Test Target.

To use the proxy settings with a web browser, run the Profile, and then, open the web browser while the unit remains linked.

Open the **HTTP Proxy** screen to enable proxy settings.

HTTP Proxy	
Address	Disabled
Port	80 (www-http)
Username	
Password	

Tap each field to open a pop-up keyboard and enter the appropriate **Address**, **Port**, **Username**, and **Password**. Tap **OK** to save your entries.

DHCP, DNS, and Gateway Tests

DHCP	10.250.2.168	>
	<1 ms	
DNS	Compass	>
	16 ms	
	10.250.0.1	>
	2 ms, 2 ms, 4 ms	

These tests are included in the [Wi-Fi](#) AutoTest Profiles, and the settings and results fields are the same for each Profile type.

Access AutoTest's DHCP, DNS, and Gateway settings from Wi-Fi Profile settings screens, or by tapping the settings button  from the full results screen for each test type.

Tap [blue links](#) or the blue action overflow icon  on the test results screens for additional actions.

DHCP or Static IP Test

The DHCP (Dynamic Host Configuration Protocol) test indicates whether the AirCheck G3 receives an IP address assignment from the DHCP server.

DHCP Settings – IP Configuration

Access the DHCP test settings from the Wi-Fi Profile settings or by tapping the settings button  on the DHCP test results screen.

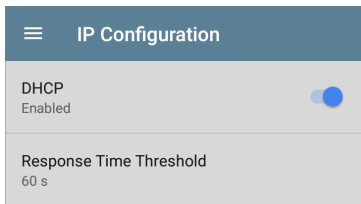

By default, DHCP is enabled. On the **IP Configuration** screen, you can adjust the **DHCP Response Time Threshold** or configure a **Static IP Address**.

DHCP

DHCP is enabled by default. Tap the toggle button to disable DHCP and enter static IP addresses.

(DHCP only) Response Time Threshold

This field only appears if DHCP is enabled. The Response Time Threshold controls how long the AirCheck G3 waits for a DHCP server response before failing the Link and DHCP tests.

Static IP Address

IP Configuration	
DHCP Disabled	<input type="checkbox"/>
Static IP Address	
Subnet Mask 255.255.255.0 /24	
Default Gateway 192.168.1.1	
Primary DNS Server 8.8.8.8	
Secondary DNS Server	

The Static IP address fields for **Subnet Mask**, **Default Gateway**, and **Primary** and **Secondary DNS Servers** only appear if DHCP is disabled. Tap each field to open a pop-up number pad and enter the static addresses as needed. Tap **OK** to save your entries.

DHCP Test Results

When DHCP is enabled, the DHCP test card and results screen are displayed in the Profile.



The DHCP Test card displays the DHCP server's IP address and the total time for the discover, offer, request, and acknowledgment to complete.

Tap the card to open the DHCP test screen.

NOTE: If a **User-Defined MAC** is enabled for this connection in [General Settings](#), (User-defined) appears next to the MAC address beneath the DHCP IP address on results screen.

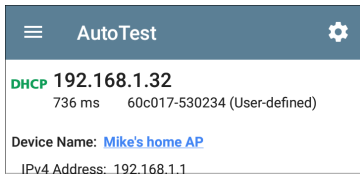

DHCP Test Results Screen

DHCP 10.250.2.168

<1 ms

Device Name: [COS_DEV_SW1](#)

IPv4 Address: 10.250.0.2

MAC Address: Cisco:001cb1-da2cc6

Results

Offered: 10.250.2.168

Accepted: 10.250.2.168

Subnet Mask: 255.255.252.0

Subnet: 10.250.0.0/22

Lease Time: 1 day 0 seconds

Expires: 4/26 2:39 PM

Relay Agent: --

Metric	Result
 Offer	<1 ms
 Acknowledge	<1 ms
Total Time	<1 ms
Threshold	60 s

End User Response Time

50.0 %  Offer Acknowledge

Device Name: The discovered name of the DHCP Server, or, if no name could be discovered, the IP address

IPv4 Address: IP address of the server

MAC Address: Server's MAC address. Two dashes -- indicate that no MAC address was provided from the server.

Results

Offered: IP address offered by the DHCP server

Accepted: IP address accepted by the AirCheck G3

Subnet Mask: Used to determine which addresses are local and which must be reached via a gateway

Subnet: Combination of the subnet mask and the offered IP address

Lease Time: The amount of time the IP address is leased to the AirCheck G3 by the DHCP server

Expires: Expiration date and time of the IP address

Relay Agent: If a BOOTP DHCP relay agent is present, this field shows its IP address. The relay agent relays DHCP messages between

DHCP clients and DHCP servers on different IP networks.

End User Response Time table and chart: Breakdown of the times for the process of acquiring a DHCP IP address

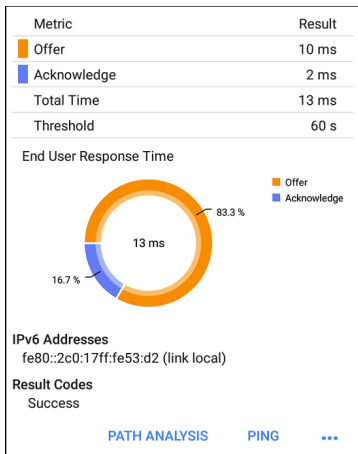

Offer: Time between when the AirCheck G3 sent the discovery and received an address offer from the DHCP server

Acknowledge: Time between AirCheck G3 sending the request and receiving the acknowledgment from the DHCP server

Total Time: Total amount of time consumed by the DHCP process

Threshold: The DHCP Response Time Threshold from the DHCP test settings, which controls how long the AirCheck G3 waits for a DHCP server response before failing the DHCP test.

End User Response Time: A pie chart showing the Offer and Acknowledgment times as percentages

IPv6 Addresses: Addresses obtained via router advertisement

Results Codes: Final status of the test (Success or Failure)

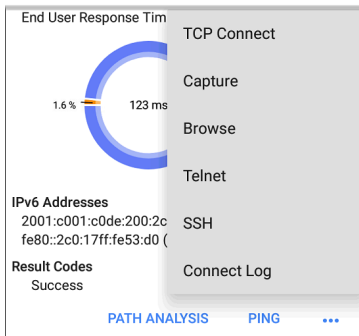

The additional actions available on the DHCP test screen include opening the [Path Analysis](#), [Ping/TCP](#), or [Capture](#) apps populated with the DHCP server address, browsing to the IPv4 address in the web browser, starting a [Telnet](#) or [SSH](#) session, or viewing the [Connect Log](#).

Static IP Test Results

If DHCP is disabled, the DHCP test becomes a "Static IP" test and the Subnet and addresses that were entered in the DHCP test settings are displayed.

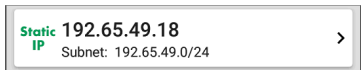

The Static IP card displays the configured IP and Subnet addresses.

Tap the card to open the test results screen.

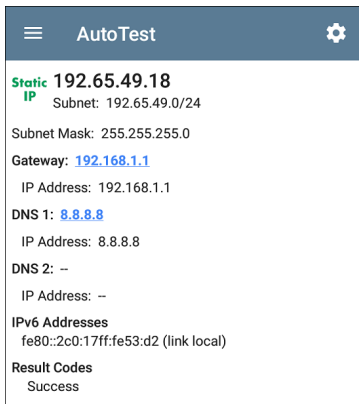

The Static IP test screen displays the configured addresses.

Subnet: Combination of the subnet mask and the offered IP address

Subnet Mask: Used to determine which addresses are local and which must be reached via a gateway

Gateway: Resolved hostname of the Gateway or its IP address if no name could be discovered

IP Address: IP address of the Gateway

DNS (1 and 2): Names and IP addresses of Primary and Secondary DNS servers

IPv6 Addresses: Addresses obtained via router advertisement

Results Codes: Final status of the test (Success or Failure)

Duplicate IP Address

The DHCP and Static IP tests also detect and report the presence of a device using the same IP address (duplicate IP). If the configured address is in use, the AutoTest fails.

● IP Address In Use By: [BRW2C6FC94A974E](#)

MAC Address: HonHai:2c6fc9-4a974e

IPv6 Addresses

fe80::2c0:17ff:fe53:d2 (link local)

Result Codes

IP address already in use (11)

IP Address In Use By: Shows the name of the device currently using the configured static IP address. Tap the blue underlined link to open a [Discovery Details screen](#) for the device.

MAC Address: MAC of the device using the IP address

DNS Test

For overview information, see [DHCP, DNS, and Gateway Tests](#).

The DNS (Domain Name System) server test checks the performance of DNS servers resolving the specified URL. The AirCheck G3 obtains DNS addresses through DHCP or static address configuration.

DNS Test Settings

DNS Test	
DNS Test Enabled	<input checked="" type="checkbox"/>
Lookup Name www.google.com	
IP Protocol Version IPv4	
Lookup Time Threshold 1 s	

DNS Test

If desired, you can tap the top field on the DNS Settings screen and switch the toggle to disable the DNS test in your current AutoTest. When this setting is disabled, the DNS card does not appear on the main AutoTest results screen, and the following settings are hidden.

Lookup Name

This is the URL the DNS server(s) attempts to resolve. Tap the field to enter a URL other than the default: www.google.com.

IP Protocol Version

Tap the field to switch between IPv4 and IPv6.

Lookup Time Threshold

This threshold controls how long the AirCheck G3 waits for a response from the DNS server(s) before the test is failed. The default is 1 second. Tap the field to select or enter a new threshold.

DNS Test Results

The server name and lookup time for DNS 1 are shown on the DNS test card.

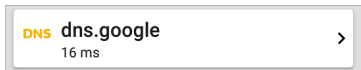

Tap the card to open the DNS test results screen.

DNS Test Results Screen

A detailed view of the DNS test results screen. At the top, it shows "DNS dns.google" in bold with "DNS" in orange, and "16 ms" below it. The "Lookup Name" is "www.google.com". The "Threshold" is "1 s". There are two DNS servers listed: "DNS 1: dns.google" and "DNS 2: dns.google". For DNS 1, the "Lookup IP" is "216.58.193.68" and the "Lookup Time" is "16 ms". For DNS 2, the "Lookup IP" is "--" and the "Lookup Time" is "--" with a red dot. Below this is a "Result Codes" section with "1: Success" and "2: Timeout error (3)". At the bottom, there are three blue links: "TEST AGAIN", "PATH ANALYSIS", and "...".

Lookup Name: Name resolved by the DNS servers

Threshold: Lookup Time Threshold from the DNS test settings

DNS #: Name of the listed DNS server

Lookup IP: Resolved IP address

Lookup Time: Time to receive the IP address after the lookup request sent

Results Codes: Final status of the test (Success or Failure) for each DNS server

14 ms

Lookup Name: www.google.com

Threshold: 1 s

DNS 1: [dns.google](#)

Lookup IP: 172.217.11.100

Lookup Time: 14 ms

DNS 2: [dns.google](#)

Lookup IP: 172.217.11.100

Lookup Time: 14 ms

Result Codes

1: Success

2: Success

Ping

TCP Connect

Capture

Browse

Telnet

SSH

[TEST AGAIN](#) [PATH ANALYSIS](#) [...](#)

Tap [blue links](#) or the blue action overflow icon [...](#) at the bottom of the test results screens to run the **DNS Test Again**, open another app populated with the name and IP address of DNS 1, or **Browse** to the Primary DNS server in your web browser.



Gateway Test

For overview information, see [DHCP, DNS, and Gateway Tests](#).

This test indicates whether the default Gateway could be successfully pinged and identifies the address of the current IPv4 and IPv6 routers.

Gateway Test Settings

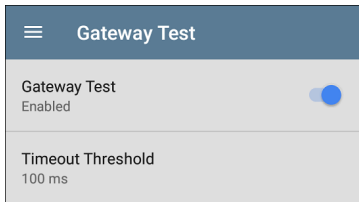

Gateway Test

If desired, you can tap the top field on the Gateway Test screen and switch the toggle to disable the Gateway test in your current AutoTest. When this setting is disabled, the Gateway card does not appear on the main AutoTest results screen, and the following setting is hidden.

Timeout Threshold

The only other setting for the Gateway Test is the timeout threshold, which indicates how long the AirCheck G3 waits for a response from the gateway before grading the test as a fail. Tap the field to select one of the value options, or enter a custom value.

Gateway Test Results

AirCheck G3 gets the Gateway's IP address from DHCP or the static IP configuration, and uses SNMP to acquire system group information and statistics for the port that services the AirCheck G3's subnet. See [Discovery Settings](#) for information about [SNMP configuration](#).

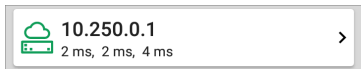

The Gateway test card shows the gateway's IP address and the three Ping response times.

Gateway Test Results Screen



The screenshot shows the 'AutoTest' application interface. At the top, there is a blue header with a hamburger menu icon on the left, the text 'AutoTest' in the center, and a gear icon on the right. Below the header, the main content area has a white background. It starts with a green cloud icon and a server rack icon, followed by the text 'COS_DEV_SW1' and '2 ms, 2 ms, 3 ms'. Below this, there are three sections: 'IPv4 Gateway Name: COS_DEV_SW1' with sub-headers for 'IPv4 Address: 10.250.0.1' and 'MAC Address: Cisco:00000c-07ac01'; 'IPv6 Gateway Name: Andromeda Automation Procurve'; and 'Protocols: RIP, OSPF, HSRP, Statically Configured Router, Proxy ARP Agent, Virtual Router (HSRP)'. A 'Ping Results' section follows, showing 'Response Times: 2 ms, 2 ms, 3 ms' and 'Threshold: 100 ms'. Below that is a 'Result Codes' section with three entries: '1: Success', '2: Success', and '3: Success'. At the bottom of the screen, there are three blue buttons: 'TEST AGAIN', 'PATH ANALYSIS', and an ellipsis '...'.

AutoTest

 **COS_DEV_SW1**
2 ms, 2 ms, 3 ms

IPv4 Gateway Name: [COS_DEV_SW1](#)

IPv4 Address: 10.250.0.1
MAC Address: Cisco:00000c-07ac01

IPv6 Gateway Name: [Andromeda Automation Procurve](#)

Protocols: RIP, OSPF, HSRP, Statically Configured Router, Proxy ARP Agent, Virtual Router (HSRP)

Ping Results
Response Times: 2 ms, 2 ms, 3 ms
Threshold: 100 ms

Result Codes

1: Success
2: Success
3: Success

[TEST AGAIN](#) [PATH ANALYSIS](#) ...

IPv4 Gateway Name: Resolved hostname of the Gateway or its IP address if no name could be discovered

IPv4 Address: Internal IPv4 address of the Gateway

MAC Address: Server's MAC address. Two dashes -- indicate that no MAC address was provided from the server.

IPv6 Address: Router's IPv6 address (if available)

IPv6 Gateway Name: Name advertised by the IPv6 router (if available)

Protocols: Routing protocols the AirCheck G3 used to obtain the Gateway data

Ping Results

- **Response Times** from the three Pings sent to the gateway
- **Threshold:** Gateway Timeout Threshold configured in the gateway settings

Results Codes: Final status of the test (Success or Failure) for each of the three Gateway Pings

 **COS-IT-SW1.netally.com**
1 ms, 1 ms, 1 ms

Gateway Name: [COS-IT-S](#)

IPv4 Address: 172.24.0
MAC Address: Cisco:6c
IPv6 Address: --

Protocols: Statically Cont

Ping Results
Response Times: 1 ms,
Threshold: 100 ms

Result Codes
1: Success
2: Success
3: Success

Ping
TCP Connect
Capture
Browse
Telnet
SSH

[TEST AGAIN](#) [PATH ANALYSIS](#) [...](#)

Tap [blue links](#) or the blue action overflow icon [...](#) at the bottom of the test results screens to run the Gateway **TEST AGAIN**, open another app, **Browse** to the Gateway's IPv4 Address, or start a [Telnet](#) or [SSH](#) session to the Gateway.

Test Targets for Wi-Fi AutoTests

PING	google	>
	28 ms, 28 ms, 15 ms	
TCP	NetAlly	>
	80 ms, 76 ms, 82 ms	
HTTP	github	>
	1.114 s	
FTP	Asset Server	>
	246 ms	

AutoTest

Target tests are user-assignable endpoints to which AirCheck G3 attempts to connect each time the AutoTest profile runs. These tests ensure availability of internal or external websites, servers, and devices to users of your network.

Tap a link below to go to the test's topic:



[Ping](#)

[TCP Connect](#)

[HTTP](#)

[FTP](#)

Adding and Managing Test Targets

To add test targets to AutoTest profiles and manage your saved targets, open the **Test Targets** screen from the **Wi-Fi Profile Settings**  or by tapping the FAB  on the **Wi-Fi Profile** results screens.

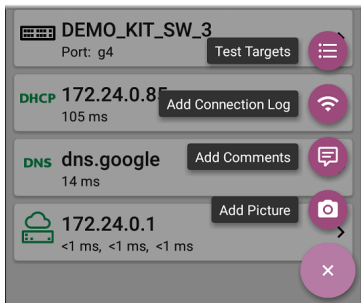

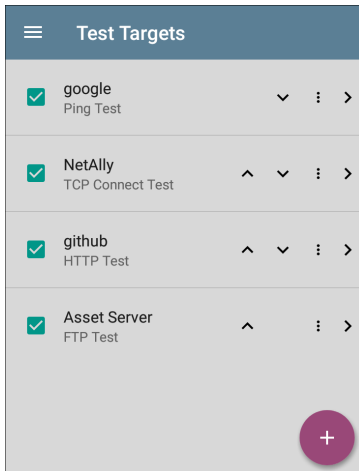

The Test Targets screen lists all of the defined and saved Test Targets. Checked boxes indicate the Test Targets that are enabled in the current Profile. Remember, Test Targets can be added to and used in any number of Wi-Fi Profiles.



On the Test Targets screen, you can perform these actions:

- Select the checkboxes for each Target you want to include in the current profile.
- Tap the up and down arrows to reorder the saved Test Targets on this screen and the main AutoTest Profile screen.

- Tap the action overflow icon  to **Duplicate** or **Delete** a target test.
CAUTION: When you delete a Test Target, you delete it from all Profiles. To remove a Test Target from the current profile, simply uncheck it.
- Tap the **FAB** icon  to add a new target test: Ping, TCP Connect, HTTP, or FTP.

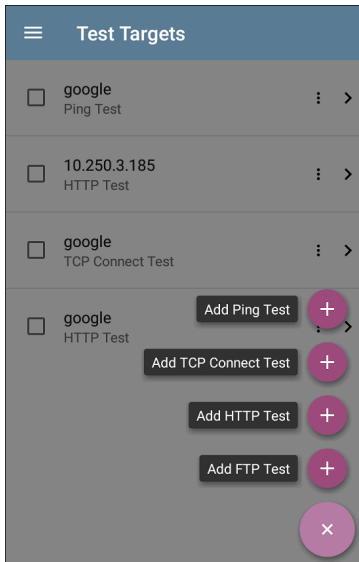

- Tap any target's name, or add a new target, to open the test's settings, where you can enter a custom test name, target address, and thresholds.

Target Test Results Screens

The Target Test type icons display green, yellow, or red to indicate the status (or grade) of the completed test portions: **Success/Warning/Fail**.

As an example, in the Ping test image below, the entire Ping test is graded with a Warning because the third Ping was not returned within the Timeout Threshold configured in the settings.

PING google
9 ms, 33 ms, --

Device Name: [172.217.1.196](#)

IPv4 Address: 172.217.1.196
MAC Address: --

Results
Lookup Time: 3 ms
Response Times: 9 ms, 33 ms, -- ●
Threshold: 250 ms

Result Codes
1: Success
2: Success
3: Timeout error (3)

The third Response Time displays two dashes -- to indicate that no response was received, and under the Results heading, the yellow dot points

out the third Response Time as the reason for the Warning. Additionally, the third Result Code lists "Timeout error" as the reason for the Warning.

Additional Target Test Actions



TEST AGAIN PATH ANALYSIS ...

After the Target test has completed, tap any of the blue links to perform additional actions, including opening other testing apps.

- Tap the blue linked Device Name to open a [Discovery](#) Details app screen for the selected device. From there, you can open other apps and run additional tests.
- Tap [TEST AGAIN](#) to run just the target test again.
- Tap [PATH ANALYSIS](#) to open the Path Analysis app. The path Destination is configured with the current target.
- Tap the action overflow icon  to open the listed apps or tools with the target pre-populated, for example:

- Open the [Ping/TCP](#) app with the current target address.
- Run a packet [Capture](#) on traffic from the test target.
- Browse to the target URL on the internet with your [web browser](#) app.

AutoTest Ping Test

A Ping test sends an ICMP echo request to the selected target to determine whether the server or client can be reached and how long it takes to respond. The AutoTest Target Ping Test sends three Pings to the target and reports the response times. The target can be an IPv4 address, IPv6 address, or named server (URL or DNS).

Ping Test Settings

Ping Test	
Name	google
Device Name	www.google.com
IP Protocol Version	IPv4
Frame Size (bytes)	64
Do Not Fragment	<input type="checkbox"/>
Disabled	
Timeout Threshold	1 s

Name: This field allows you to assign a custom name to the test. The name appears on the target test card in the profile.

Device Name: Enter the IP address or URL of the server you want to ping. If you enter an IP

address, the DNS lookup portion of the test is skipped.

IP Protocol Version: IPv4 is used by default. Tap the field to switch between IPv4 and IPv6.

Frame Size (bytes): This setting specifies the total size of the payload and the header sent. Valid sizes are 64 bytes to 1518 bytes. To test the Maximum Transmission Unit (MTU) along a route to a target, select the MTU frame size you want to test, and set **Do Not Fragment** to **Enabled**.

Do Not Fragment: Tap the toggle button to enable.

Timeout Threshold: This threshold controls how long the AirCheck G3 waits for a response from the target before failing the test.

Ping Test Results

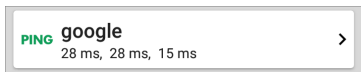

The Ping card shows the Ping test name entered in the Ping test settings and the three Ping response times from the target.

Tap the card to open the Ping results screen.

AutoTest Ping Results Screen

PING google
4 ms, 4 ms, 5 ms

Device Name: www.google.com

IPv4 Address: 172.217.12.4
MAC Address: --

Results
Lookup Time: 1 ms
Response Times: 4 ms, 4 ms, 5 ms
Threshold: 1 s

Result Codes
1: Success
2: Success
3: Success

[TEST AGAIN](#) [PATH ANALYSIS](#) ...

Device Name: Hostname or address of the target device

- **IPv4 or IPv6 Address:** IP address of the target device
- **MAC Address:** Target device's MAC address. The two dashes -- indicate that no MAC address was provided from the server.

Results

- **Lookup Time:** How long it took to resolve the URL into an IP address
- **Response Times:** How long it took for the AirCheck G3 to receive a response from the target after sending each of the three Pings
- **Threshold:** The Timeout Threshold indicated in the test's settings

Results Codes: Final status of the test (Success or Failure) for each of the three Pings

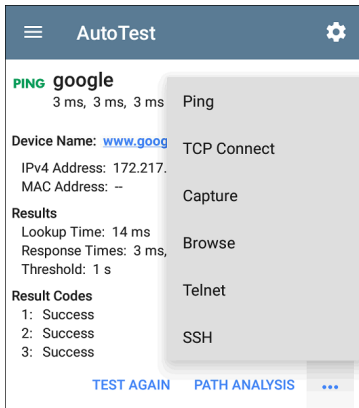

Tap [blue links](#) or the blue action overflow icon [...](#) at the bottom of the test results screens to run the Ping **TEST AGAIN**, open another testing app, **Browse** to the Ping target address in your web browser, or start a [Telnet](#) or [SSH](#) session.

AutoTest TCP Connect Test

A TCP Connect test opens a TCP connection with the selected target to test for port availability using a 3-way handshake (SYN, SYN/ACK, ACK). The AutoTest Target TCP Connect test runs three connection tests and reports the response times.

TCP Connect Test Settings

☰ TCP Connect Test	
Name	NetAlly
Device Name	NetAlly.com
IP Protocol Version	IPv4
Port	80 (www-http)
Timeout Threshold	1 s

Name: This field allows you to assign a custom name to the test. The name appears on the target test card in the profile.

Device Name: Enter the IP address or URL of the target you want to test. If you enter an IP address, the DNS lookup portion of the test is skipped.

IP Protocol Version: IPv4 is used by default. Tap the field to switch between IPv4 and IPv6.

Port: Specify the TCP port number for the AirCheck G3 to use to connect to the target.

Timeout Threshold: This threshold controls how long the AirCheck G3 waits for a response from the target before failing the test.

TCP Connect Test Results

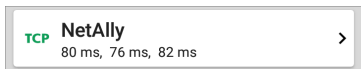

The TCP card shows the test name entered in the settings and the three response times from the target.

Tap the card to open the TCP results screen.

AutoTest TCP Results Screen

AutoTest

TCP **NetAlly**
50 ms, 44 ms, 42 ms

Device Name: [ip-184-168-221-49.ip.secureserver.net](#)

IPv4 Address: 184.168.221.49
MAC Address: --
Port: 80 (www-http)

Results
Lookup Time: 21 ms
Response Times: 50 ms, 44 ms, 42 ms
Threshold: 250 ms

Result Codes
1: Success
2: Success
3: Success

TEST AGAIN PATH ANALYSIS ...

Device Name: DNS name of the device tested

IPv4 or IPv6 Address: IP address of the target device

MAC Address: Device's MAC address. The two dashes -- indicate that no MAC address was provided.

Port: Port number tested

Results

Lookup Time: How long it took to resolve the URL into an IP address

Response Times: How long it took for the AirCheck G3 to receive a response from the server for each of the three connect tests

Threshold: The Timeout Threshold indicated in the test's settings

Results Codes: Final status of the test (Success or Failure) for each of the three Pings

HTTP Test

The HTTP test performs a comprehensive end user response time (EURT) measurement when downloading the specified web page. The target can be an IPv4 address, IPv6 address, or URL.

HTTP Test Settings

HTTP settings allow test grading criteria based on responses and return code in addition to the time threshold.

HTTP Test	
Name	github
URL	https://www.github.com
IP Protocol Version	IPv4
Allow Redirects	<input checked="" type="checkbox"/> Enabled
Response Time Threshold	10 s
Web Page Transfer Size	ALL
Response Must Contain	

Name

This field allows you to assign a custom name to the test. The name appears on the target test card in the profile.

URL

Enter a target address. To reach web servers that operate on a non-default port, enter a colon (:), and specify the port number after the URL.

IP Protocol Version

IPv4 is used by default. Tap the field to switch between IPv4 and IPv6.

Allow Redirects

Tap the toggle button to permit web redirects when trying to connect to the target.

Response Time Threshold

This threshold controls how long the AirCheck G3 waits for a response from the URL before failing the test. Tap the field to change the value.

Web Page Transfer Size

This setting allows you to limit the amount of data downloaded, ranging from the HTML **Header Only** to the entire page (**ALL**). Tap the field to select a different transfer size.

Response Must Contain	
Response Must Not Contain	
Return Code 200 - OK	
HTTP Proxy Disabled	<input type="checkbox"/>

Response Must Contain

Text entered here functions as **pass/fail** test criteria based on the presence of the text string on a specified server or URL. To construct a text string, enter a word or several words with exact spacing. When specifying several words, they must appear consecutively at the source. The test passes if the text string is found. If the string is not found, the test fails with the Return Code: "Response does not contain required text."

Response Must Not Contain

Like the setting above, except text entered here functions as **pass/fail** test criteria based on the

absence of the text string on a specified server or URL. The test passes if the text string is not found. If the string is found, the test fails with the return code: "Response contains excluded text."

Return Code

The Return Code set here functions as **pass/fail** test criteria. The default is "OK (HTTP 200)." Tap the field to select a different Return Code from the list. If your selected Return Code value matches the actual return code value, the test passes, and if AirCheck G3 receives a different return code, the test fails.

HTTP Proxy

The Proxy control in target test settings uses the server address and port specified in the main profile settings. Tap the toggle to use those Proxy settings. See [Wi-Fi Profile Settings](#).

HTTP Test Results



The HTTP card shows the test name entered in the test settings and response time from the target.

HTTP Test Results Screen

Metric	Result
HTTP github 3.671 s	
Device Name: ib-192-30-253-113-iad.github.com	
IPv4 Address: 192.30.253.113	
MAC Address: --	
URL: https://www.github.com	
Results	
Ping	54 ms
DNS Lookup	59 ms
TCP Connect	165 ms
Data Start	1.288 s
Data Transfer	2.157 s
Total Time	3.671 s
Threshold	10 s
Data Bytes	90.9 K
Rate (bps)	206.2 K
End User Response Time	

Device Name: DNS name of the server tested

IPv4 or IPv6 Address: IP address of the server

MAC Address: Server's MAC address. The two dashes -- indicate that no MAC address was provided from the server.

URL: The target URL

Results

Ping: A ping test runs simultaneously with the HTTP test, and this result field displays the Ping response time. If the HTTP test finishes before the ICMP echo reply packet arrives, dashes -- are displayed for the ping test results. Ping results do not affect the Pass/Fail status of the test.

DNS Lookup: Amount of time it took to resolve the URL to an IP address. If you enter an IP address, DNS lookup is not required, so dashes are displayed to indicate that this part of the test was not executed.

TCP Connect: Amount of time it took to open the port on the server

Data Start: Time to receive the first frame of HTML from the web server

Data Transfer: Time to receive the data from the target server

Total Time: The end user response time (EURT), which is the total time it took to download the web page. It is the sum of DNS lookup, TCP connect, data start, and data transfer time. If the Total Time exceeds the Response Time Threshold in the settings, the test fails.

If the Response Time Threshold is exceeded during a step in the test, the current phase of the test (DNS, Lookup, TCP Connect, Data Start, or Data Transfer) is denoted with a red dot, and the rest of the test is aborted.

Threshold: The Response Time Threshold from the test settings

Data Bytes: Total number of data bytes transferred. This does not include header bytes

Rate (bps): The measured data transfer rate

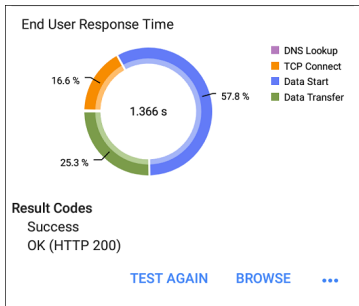

End User Response Time : Pie chart of the times for each phase of the test (DNS, Lookup, TCP Connect, Data Start, and Data Transfer)

Results Codes: Final status of the test (Success or Failure)

The HTTP test also shows the **Return Code** from the website server.

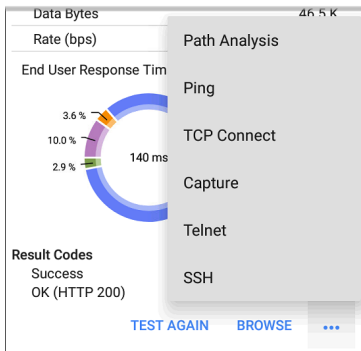

Tap [blue links](#) or the blue action overflow icon **...** at the bottom of the test results screens to run the HTTP **TEST AGAIN**, open another testing app, or **Browse** to the target address in your web browser.

Captive Portal Connections

The HTTP test supports connections through a network with a captive portal requirement.

When running a Profile that connects to a network with a [Captive Portal](#), a system notification  appears to prompt you to enter the captive portal credentials.

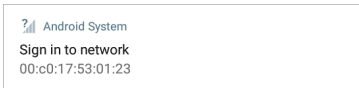

For the HTTP test to pass, you must select the notification and enter the required credentials on the portal website. Otherwise, the HTTP test fails, with a Result Code of "Captive portal detected (25)."

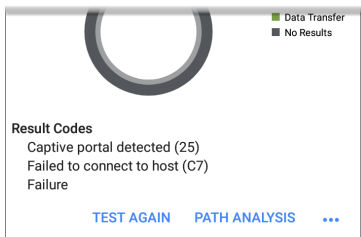

See the "[Captive Portals](#)" on page 51 for more instructions.

When finished in the captive portal browser window, hit the back button  to return to the HTTP test, and tap **TEST AGAIN** to receive valid results.

FTP Test

The FTP test performs a file upload to or download from an FTP server, allowing verification of server and network performance. The target can be an IPv4 address, IPv6 address, or URL. The results provide a complete breakdown of the overall file transfer time into its component parts.

FTP Test Settings

FTP settings allow you to specify a **Get** or **Put** test and the file path and name.

FTP Test	
Name Asset Server	
FTP Server 10.250.2.218	
IP Protocol Version IPv4	
File internal/iperf3	
File Transfer Size ALL	
Direction Get	<input checked="" type="checkbox"/>
Response Time Threshold 10 s	

Name

This field allows you to assign a custom name to the test. The name appears on the target test card in the profile.

FTP Server

Enter the IPv4 address or URL of the FTP server you want to test. If you enter an IP address, the DNS Lookup portion of the test is skipped.

IP Protocol Version

IPv4 is used by default. Tap the field to switch between IPv4 and IPv6.

File

This setting specifies the path and name of the file that is downloaded from (**Get**) or uploaded to (**Put**) the server, based on the **Direction** setting below. Tap the field to enter the file path and name.

File Transfer Size

This setting lets you limit the amount of data to be downloaded or uploaded. The default transfer size is **ALL**.

- When the **Direction** setting is **Get**, a transfer size of **ALL** causes the download to continue until the entire file is downloaded or the Response Time Threshold is exceeded.

Specifying a transfer size that is greater than file being retrieved does not cause the test to fail. The test stops when the file has finished downloading.

- When the **Direction** setting is **Put**, the default transfer size of ALL causes the AirCheck G3 to create and upload a file that is 10 MB.

Direction

Tap the toggle button to switch between a **Get** (download the **File** from the server) or **Put** (upload the **File** to the server) test.

- If Direction is set to Get, the file is retrieved, and the size and data rate are calculated. This data is discarded as soon as it is downloaded and is not retained on the AirCheck G3.
- If Direction is set to Put, the File named above is created on the FTP server. The size of this file is determined by the **File Transfer Size** setting. The file contains a text string indicating that it was sent from the AirCheck G3, and the test string is repeated to produce the set file size.

Response Time Threshold

This threshold controls how long the AirCheck G3 waits for a response from the FTP server before failing the test. Tap the field to change the value.

Username	
Password	
HTTP Proxy Disabled	<input type="checkbox"/>

Username and Password

Enter these credentials to access the target server you specified. Enter "anonymous" as the username to establish an anonymous connection. The test fails if the configured username or password are not valid on the target FTP server.

HTTP Proxy

The Proxy control in target test settings uses the server address and port specified in the main profile settings. See [Wi-Fi Profile Settings](#).

FTP Test Results



The FTP card shows the test name entered in the test settings and response time from the target.

FTP Test Results Screen

FTP Asset Server	
171 ms	
Device Name: 10.250.2.218	
IPv4 Address: 10.250.2.218	
MAC Address: --	
Get File: /internal/iperf3	
Results	
Metric	Result
Ping	50 ms
DNS Lookup	--
TCP Connect	44 ms
Data Start	116 ms
Data Transfer	10 ms
Total Time	171 ms
Threshold	60 s
Data Bytes	24 K
Rate (bps)	1.2 M

Device Name: Hostname of the server tested

IPv4 or IPv6 Address: IP address of the server

MAC Address: Server's MAC address. The two dashes -- indicate that no MAC address was provided from the server.

Get File: File path and name entered in the settings that was transferred to or from the FTP server.

Results

Ping: A ping test runs simultaneously with the FTP test, and this result field displays the Ping response time. If the FTP test finishes before the ICMP echo reply packet arrives, dashes -- are displayed for the ping test results. Ping results do not affect the Pass/Fail status of the test.

DNS Lookup: Amount of time it took to resolve the URL to an IP address. If you enter an IP address, DNS lookup is not required, so dashes are displayed to indicate that this part of the test was not executed.

TCP Connect: Amount of time it took to open the port on the server

Data Start: Time to receive the first frame from the FTP server

Data Transfer: Time to receive the file from the target server

Total Time: The end user response time (EURT), which is the total time it took to download the web page. It is the sum of DNS lookup, TCP connect, data start, and data transfer time. If the Total Time exceeds the Response Time Threshold in the settings, the test fails.

If the Response Time Threshold is exceeded during a step in the test, the current phase of the test (DNS, Lookup, TCP Connect, Data Start, or Data Transfer) is denoted with a red dot, and the rest of the test is aborted.

Threshold: The Response Time Threshold from the test settings

Data Bytes: Total number of data bytes transferred. This does not include header bytes.

Rate (bps): The measured data transfer rate

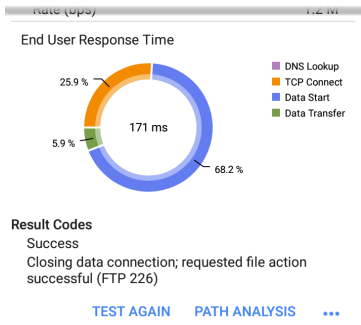

End User Response Time: Pie chart of the times for each phase of the test (DNS, Lookup, TCP Connect, Data Start, and Data Transfer)

Results Codes: Final status of the test (Success or Failure)

The FTP test also shows the **Return Code** from the server.

Tap [blue links](#) or the blue action overflow icon [...](#) at the bottom of the test results screens to run the **FTP Test Again**, open another testing app, or **Browse** to the FTP server in your web browser.

Air Quality AutoTest Profiles

Air Quality Profiles perform a scan of the channels in your wireless network to measure channel utilization and interference.

Each table on the Air Quality results screen shows the top four channels in each band with the highest utilization, co-channel interference or adjacent channel interference, along with the number of APs operating on the channel.

Air Quality Profile results are described next. Tap here to skip to [Air Quality Settings](#).



Air Quality Profile

Top 2.4 GHz Channels By Utilization

Channel	APs	802.11 (%)
11	2	7
1	2	6
12	0	6
10	0	4

Channel	APs	Non-802.11 (%)
4	0	11
10	0	7
7	0	7
2	0	4

Top 2.4 GHz Channels By Co-Channel Interference

Channel	APs
11	2
1	2
5	1
9	1



The AirCheck G3 scans the 2.4-GHz band first and displays results and then does the same for the 5-GHz band and then the 6GHz band if applicable.

Channel usage depends on the number of clients connected to the network and the amount of interference from devices like microwaves or smartphones using Bluetooth. Very high utilization or interference can affect network performance.

Air Quality Profile Results

The image below shows a completed Air Quality Profile test with two **Warnings** and two **Failures** indicated by the yellow and red dots next to the corresponding measurements.



Air Quality Profile

Top 2.4 GHz Channels By Utilization

Channel	APs	802.11 (%)
1	10	10
11	5	10
6	5	8
12	0	8



Channel	APs	Non-802.11 (%)
12	0	22
10	0	20
3	0	17
13	0	17

Top 2.4 GHz Channels By Co-Channel Interference

Channel	APs	
1	10	
11	5	
6	5	
2	1	



Top 2.4 GHz Channels By Adjacent Channel Interference

Channel	APs	
2	15	
1	1	
6	1	
--	--	

Air Quality test gradings are based on the Thresholds configured in the Profile's settings. In the case shown here, the Warnings and Failures occurred because of high Utilization and Co-channel Interference caused by the number of APs active on the top three 2.4 GHz channels: 1, 6, and 11.

802.11 Utilization %: Percentage of the displayed channel's capacity used by all 802.11 WLAN devices

Non-802.11 Utilization %: Percentage of the displayed channel's capacity being used by non-802.11 interferers, which may be non-WLAN sources



Top 5 GHz Channels By Utilization

Channel	APs	802.11 (%)
153	0	7
149	1	6
161	0	6
157	6	5

Channel	APs	Non-802.11 (%)
52	0	1
56	0	1
--	--	--
--	--	--

Top 5 GHz Channels By Co-Channel Interference

Channel	APs	
157	6	
36	2	
149	1	
--	--	

Top 5 GHz Channels By Adjacent Channel Interference

Channel	APs	
149	6	



☰
AutoTest
START

-- -- --

Top 5 GHz Channels By Co-Channel Interference

Channel	APs
157	6
36	2
149	1
--	--

Top 5 GHz Channels By Adjacent Channel Interference

Channel	APs
149	6
157	1
--	--
--	--

Result

Thresholds exceeded

[CHANNELS MAP](#)

Two dashes -- indicate that no Utilization was detected on the Channels shown.

Co-channel Interference: Interference caused by multiple APs operating on the same channel that exceed the minimum **Co-channel Interference AP Signal Level** threshold in the settings. This measurement accounts for 40-MHz and 80-MHz

channels in the 5-GHz band by counting an AP on its primary and each secondary channel.

Adjacent Channel Interference: Interference caused by multiple APs operating on adjacent channels that exceed the minimum **Adjacent channel Interference AP Signal Level** threshold in the settings. This is most common in the 2.4 GHz band where channels are 5 MHz apart but span 20 MHz. There are only three channels that do not overlap in this band: 1, 6, 11. Larger channel widths (e.g., 40 MHz) also affects the adjacent channel interference counts.

Results Codes: Final status of the test (Success or Failure)

Tap the blue link at the bottom of the Air Quality Profile screen to open the Wi-Fi app's [CHANNELS MAP](#), which provides real-time visual results of the utilization on each channel.

Air Quality Profile FAB

The floating action button (FAB) on the AutoTest Air Quality Profile screen allows you to attach comments and images to this AutoTest result on the [Link-Live](#) website.

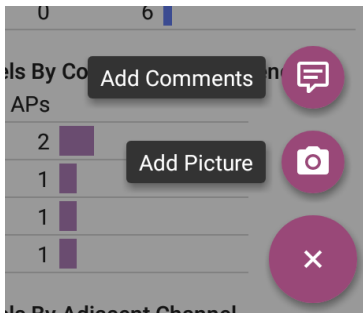

- The **Add Comments** option opens a Link-Live sharing screen where you can enter comments.
- The **Add Picture** function lets you open the Gallery or Camera app to select or take a photo that is then uploaded and attached to your test result.

Air Quality Profile Settings

To configure the profile settings, tap the settings icon  on the Air Quality Profile screen, or add a new Air Quality Profile to AutoTest.

Air Quality Profile	
Name	Air Quality Profile
Channel Scan Cycles	3
AP Signal Level Threshold	-75 dBm
Grading	
Utilization	<input checked="" type="checkbox"/>
Enabled	
Warning	35 %
Failure	75 %

The settings for Air Quality are thresholds for grading the channel utilization and interference.

On the **Air Quality Profile** settings screen, tap each field described below as needed to

configure the profile. Changed settings are automatically applied.

When you finish configuring, tap the back button  to return to the profile.

Name

Tap the **Name** field to enter a custom name for the profile. This name appears on the main AutoTest screen profile card and the Air Quality profile screen header.

Channel Scan Cycles

This setting designates the number of times all of the channels should be scanned before reporting the results. Tap the field to enter a new value between 1 and 10.

AP Signal Level Threshold

This setting designates the minimum signal level at which an AP must be measured to be counted in Co-Channel and Adjacent Channel Interference measurements. Tap the field to select a new value or enter a custom one.

Grading

Use the grading threshold controls to adjust the values that determine **Warning/Fail** results for the corresponding utilization and co-channel interference and adjacent channel measurements. Tap each Warning or Failure field to select a new value or enter a custom one. Each threshold also has a toggle button that allows you to disable grading based on that measurement entirely.

Thresholds

Use the threshold controls to adjust the values that determine **Warning/Fail** results for the corresponding utilization and co-channel interference and adjacent channel measurements. Tap each Warning or Failure field to select a new value or enter a custom one. Each threshold also has a toggle button that allows you to disable grading based on that measurement entirely.

By default, you can set thresholds for both 802.11 and non-802.11 Utilization.

Utilization measurements and thresholds are percentages of a channel's capacity. Co-channel

interference measurements and thresholds are the number of APs operating on the same channel.

Adjacent Channel Interference measurements and thresholds are the number of APs operating on nearby channels that cause interference.

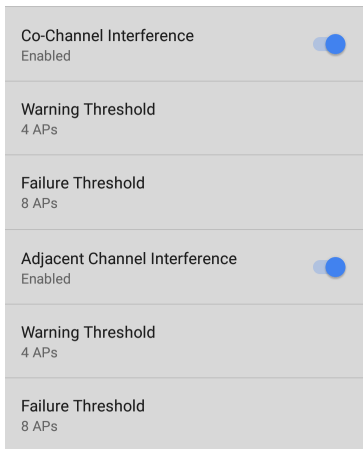



Ping/TCP Test App

The Ping/TCP test app runs a Ping or TCP Connect test to your chosen target, allowing you to monitor connectivity changes.

A Ping test sends an ICMP echo request to the selected target to determine whether the server or client can be reached and how long it takes to respond. A TCP Connect test opens a TCP connection with the selected target to test for port availability using a 3-way handshake (SYN, SYN/ACK, ACK).

You can open the TCP/Ping app from the Home screen, or you can select **Ping** or **TCP Connect** from another app, such as AutoTest or Discovery, while viewing a device's details.

Ping/TCP Settings

To configure a test, you can manually enter a hostname or IP address in the settings, or you can select Ping or TCP Connect from another testing app's device screen.

Populating Ping/TCP from Another App

When you open the Ping/TCP app from another app, the address is pre-populated as the Ping or TCP target device. For example, the floating action button (FAB) menu on the [Discovery](#) app screen shown below contains the option to open the Ping/TCP app.

The screenshot shows a network discovery application interface. At the top, a cloud and server icon is next to the name 'cos-lab-vm-cisco'. Below this, it is identified as a 'Router'. The 'Name' field shows 'SNMP: cos-lab-vm-cisco'. The 'Address' section is circled in green and displays 'IPv4: 10.250.0.11 (Reachable)' and 'MAC: Cisco:40f4ec-f47681'. Below the address, it states 'Protocols: Statically Configured Router' and 'Attributes: Discovered via SNMP Switch, Port Aggregation'. A 'Path Analysis' button is visible. The 'Addresses' section shows 'IPv4: 2' and 'MAC: 1', with a green arrow pointing to a 'Ping/TCP' button. The 'VLANs' section lists '1, 196, 500, 508, 526, 560' and has a 'Capture (Wired)' button. The 'Interfaces' section shows 'Up: 2' and 'Down: 41' with a 'Browse' button. A 'MIB SNMP' section is partially visible at the bottom. On the right side, there are several circular icons: a purple flag icon, a purple 'PING/TCP' icon, a purple icon with a network diagram, a purple icon with a square and an upward arrow, and a purple circle with an 'X'.

If the Ping/TCP app is opened from this screen, the IPv4 address from the Discovery app is already configured as the Ping/TCP target.

☰ Ping START ⚙️

PING
TCP 10.250.0.11

Device Name:
IP Address: 10.250.0.11
MAC Address: --
Interface: Any Port

Results

Started

Configuring Ping/TCP Settings Manually

To configure the target and settings manually, open the app's settings .

Ping/TCP Settings	
Device Name	www.google.com
IP Protocol Version	IPv4
Interface	Any Port
Number Of Tests	Continuous
Protocol	Ping
Frame Size (bytes)	64
Interval	1 s

Device Name: Enter the IP address or DNS name of the target.

IP Protocol Version: IPv4 is used by default. Tap the field to enable IPv6 instead.

Interface: This setting determines the AirCheck G3 port from which the port scan runs. Tap the field to select the port. (See [Selecting Ports](#) for explanations of the different ports.)

Number of Tests: Tap to select the number of Ping or TCP connect tests you want to run. The default setting of **Continuous** keeps running tests until you tap the **STOP** button.

Protocol: Tap to select the **Ping** or **TCP Connect** protocol for the test.

Some of the following settings depend on the selected protocol.

Frame Size (bytes): This setting only appears if the **Ping** Protocol is selected. It specifies the total size of the payload and header the AirCheck G3 sends. Tap a radio button to select a new size, or enter a Custom Value from 64 to 1518 bytes.

To test the Maximum Transmission Unit (MTU) along a route to a target, select the MTU frame size you want to test, and set the **Do Not Fragment** setting (below) to **Enabled**.

Interval: This setting only appears if the **Ping Protocol** is selected. It controls how much time passes between each Ping sent from the AirCheck G3. By default, Pings are sent once every second (1 s). Tap a radio button to select a different interval, or enter a Custom Value between 100 and 10,000 milliseconds.

Port: This setting only appears if the **TCP Connect Protocol** is selected. It indicates the port number your AirCheck G3 uses to connect to the target address for a TCP Port Open test. If needed, tap the **Port** field to open a pop-up number pad and enter a new port number. Tap **OK** to save it.

Timeout Threshold: This threshold controls how long the AirCheck G3 waits for a response from the target before the test is failed.

Do Not Fragment: This setting only appears if the **Ping Protocol** is selected. Tap the toggle

button to enable. See the Frame Size setting description above.

Running Ping/TCP Tests

Your unit must be connected to an active network ([Test or Management Port](#)) to run Ping and TCP Connect tests. Icons in the top Status Bar indicate whether and how your AirCheck G3 is connected. See [Connection Notifications](#) for descriptions of the connection status icons, and select the appropriate **Interface** (or Any Port) from the [Ping/TCP settings](#).

The default target is google.com. Open the app settings  to enter a new target.

To begin the test, tap **START**.

If the Number of Tests setting is set to **Continuous**, the Ping/TCP app runs tests to your selected target until you tap **STOP**.

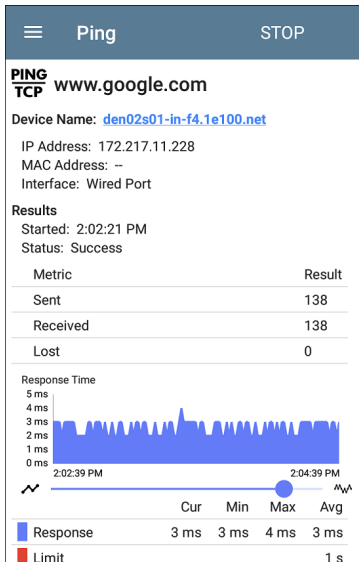

Device Name: Hostname or address of the target device

IPv4 or IPv6 Address: IP address of the target device

MAC Address: Target device's MAC address. The two dashes -- indicate that no MAC address was provided from the device.

Port: The port number used for the TCP Connect test. This field does not appear in Ping test results.

Interface: The AirCheck G3 Test or Management Port from which the test is running

Results

- **Started:** Time the test started
- **Status:** Most recent test status
- **Sent:** Number of Pings or TCP SYN packets sent to the target
- **Received:** Number of Ping or TCP SYN/ACK packets returned from the target
- **Lost:** Number of Pings or TCP packets that were not returned from the target

Response Time graph: Plots the target device's response times in milliseconds. The graph saves and displays data for up to 24 hours in the past if the unit stays linked.

To pan and zoom on the graph, you can swipe, double tap, and move the slider. See the [Trending Graphs](#) topic for an overview of the graph controls.

Response: Table display of the Current, Minimum, Maximum, and Average response time measurements

Limit: The **Timeout Threshold** from the Ping/TCP app's settings



Capture App

Packet capture is the process of recording network traffic in the form of packets as data streams back and forth over Wi-Fi connections. Packet captures can help you analyze network problems, debug client/server communications, track applications and content, ensure that users are adhering to administration policies, and verify network security.

The capture process uses the [Wi-Fi Test port](#).

You can open the Capture app from the Home screen or using a link from another app, such as AutoTest, Discovery, or Wi-Fi.

Capture Settings

The Capture app settings allow you to designate file and slice sizes, and apply filters to capture and analyze only certain packet types. For example, you can create a Wi-Fi filter to capture only packets to and from a particular AP or client. When you open Capture from Home and do not configure any filters, all packets from the switch or channel are captured. The default Wi-Fi capture saves the packets seen on channel 1. If you open the Capture app from another NetAlly test app, Capture filters are automatically applied. Filters that can be applied from other apps include Wi-Fi Channel, Channel Width, and BSSID.

For example, the [floating action menu](#) on the Wi-Fi app's [BSSID Details screen](#) below contains the option to start a Wi-Fi Capture.

Wi-Fi - BSSID

 **Lnksys:c0c1c0-d7b562**
BSSID

SSID: **CiscoE4200-2G**

AP: **Lnksys:c0c1c0-d7b562**

BSSID: c0c1c0-d7b562

802.11

Channel: 6



Types: n, g, b
Signal: -39 dBm
SNR: 53 dB
Security Type: WPA2-E



Last Seen: 3:39:58 PM

Locate 

Connect 

↑↓ Rates and Capabilities  **Capture (Wi-Fi)**

 **Clients** **Name and Authorization** 

 **RF and Traffic Statistics** 

CH: 6 Utilization: 5%

When the Capture app opens, filters are already set with the BSSID, Channel, and Channel Width from the Wi-Fi app.

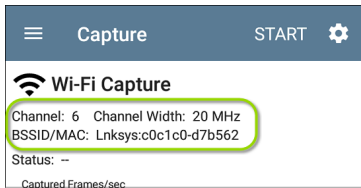

The Capture settings are saved until you clear the filters or open the app with new filters applied.

Tap the settings icon  in the Capture screen to configure capture settings.

Capture Settings	
File Size Limit	1 MB
Slice Size	Full Packet
Capture Port	Wi-Fi
Channel	34
Channel Width	20 MHz
Wi-Fi Filters	
BSSID/MAC	18b169-c83fc5

File Size Limit: Tap this field to specify a size for the capture file. The default size is 1 MB, and largest size allowed is 1000 MB. The capture stops when the captured file reaches this size.

When capture is running, the capture screen displays the current file size as data is captured.

Slice Size: Tap this field to select a specific frame slice size or enter a custom value. The Slice Size setting limits how much of each packet is captured. A smaller slice size is useful when you are interested in the packet's header but do not need to see all the payload data. The default is Full Packet.

Wi-Fi Filters

Channel: Tap the channel button to set the channel on which packets are captured.

Channel Width: (Appears only if you select a Channel number in the 5-GHz or 6-GHz band, above channel 14). Tap to select a width of 20, 40, 80, or (for 6-GHz band only) 160 MHz.

BSSID/MAC: Enter a BSSID to capture only packets going to or from the target device.

Control, Data, and Management Frames and Beacons: All frame types are captured by default. Tap the toggle button for each frame type to disable its capture.

Running and Viewing Captures

To start Capturing, tap **START** at the top of the app screen.

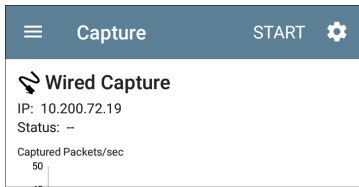

The current Status of the capture and any applied filters are shown under the capture type . The image above indicates that the app captures traffic for IP 10.200.72.19 only.

View the real-time status of the capture as it is running. If you navigate away from the Capture app, the capture process continues to run in the background until the File Size Limit (in [Capture Settings](#)) is reached. Captures also stop if you open the Wi-Fi app (which initiates scanning) or if you connect to a Wi-Fi network using AutoTest.

Tap **STOP** to stop the running capture before it reaches the File Size Limit.

To pan and zoom on the graphs, you can swipe, double tap, and move the slider. See the [Trending Graphs](#) topic for an overview of the graph controls.

Wi-Fi captures graph the Management, Control, and Data Frame Types.

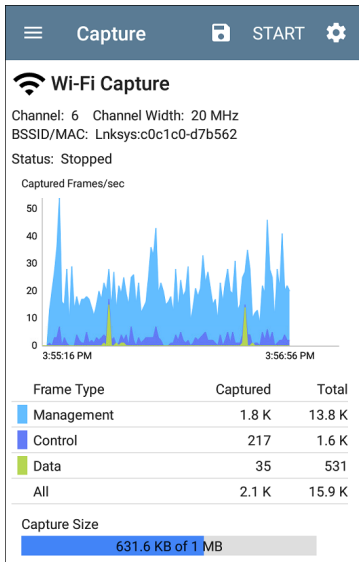

In the test shown above, the app has captured all three Wi-Fi Frame Types on channel 6 with the BSSID shown. The Total measurements in the table below the graph represent all frames seen, while the Captured frames are those that fall within the filter parameters.

Once a capture is completed, the **Save Capture** dialog appears automatically.

Tap the Save icon  to reopen this dialog.

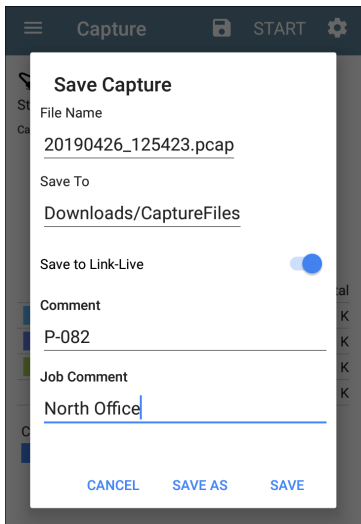

Save Capture

File Name
20190426_125423.pcap

Save To
Downloads/CaptureFiles

Save to Link-Live

Comment
P-082

Job Comment
North Office

CANCEL SAVE AS SAVE

Captures are saved as .pcap files. Tap any of the fields in the dialog to enter changes.

File Name: Capture files are automatically named using the date and time. Tap this field to enter a custom name.

Save to: By default, capture files are saved in the **Downloads** folder in the AirCheck G3 file system, but you can also save them to a USB storage device or choose a different folder by tapping the **Save to** field. See also [Managing Files](#).

Save to Link-Live: You can also upload capture files to [Link-Live](#) and then download them for analysis on a PC. Capture (.pcap) files appear on the Uploaded Files  page in Link-Live.

Comment: This comment is attached to your capture file when it is uploaded to Link-Live.

Job Comment: This is the persistent [Job Comment](#) that uploads to Link-Live with all test results and files, until you change it. Changing the Job Comment here changes it throughout your unit.



Discovery App

The AirCheck G3 Discovery application creates an inventory of the devices on your networks along with their attributes: device types, names, addresses, interfaces, VLANs, resources, and other connected or associated devices. The app allows you to identify and analyze network devices and acts as a jumping-off point for further analysis using other apps, such as Wi-Fi, Path Analysis and connection tests.

Discovery Chapter Contents

This chapter describes how the Discovery process and app screens work, shows examples of Discovery data, and details the Discovery settings.

[Introduction to Discovery](#)

[Main Discovery List Screen](#)

[Discovery Details Screens](#)

[Device Types](#)

[Discovery Settings](#)

[Problem Settings](#)

[TCP Port Scan Settings](#)

Introduction to Discovery

Discovery finds, classifies, and displays the details of network components. Information provided by Discovery can include the following:



- IP, BSSID, and MAC addresses
- Device Names
- Device Connectivity
- SNMP Data
- Network Problems
- Interface Details and Statistics

Devices are discovered via ARP and Ping sweeps; SNMP, DNS, mDNS, and netBIOS queries; and passive traffic monitoring. Discovery classifies each device as it is found. Up to 2,000 devices can be reported.

The Discovery app also detects **Problems** with discovered devices, including **Warning** and **Failure** conditions.

The AirCheck G3's discovery process begins when the unit is powered on. Once a network









connection ([Wi-Fi, test or management](#)) is established, the active discovery process begins.

Discovery notification icons  indicate the progress of active discovery. This icon  indicates that no links are currently available for active discovery, either because none of the ports enabled for discovery are connected or because AutoTest is running.

The Discovery app consistently monitors network traffic, but the active discovery process reruns every 90 minutes by default. You can select a different Refresh Interval in the [Discovery Settings](#).

Main Discovery List Screen

The main Discovery screen lists all the devices the AirCheck G3 has discovered.

Discovery (589)		🔍	⋮
🔍	📏	Name	▼
	AndroLinkSysWav	10.250.2.147	>
	AndroLinkSysWav	Belkin-454655	
	Andromeda Automati...	10.250.3.224	>
	Andromeda Automation Procurve	HP-235cc0	
	Angela's EtherScope ...	10.250.2.139	>
	Angela's EtherScope nXG - 530000	NetAlly-530000	
	Cetus	10.250.2.166	>
	Cetus	Dell-faa680	
	Cisco2500WLC	10.250.3.235	>
	Cisco2500WLC	Cisco-556c80	
	cos-lab-ad.netally.eng	--	>
	cos-lab-ad.netally.eng	VMware-678cc2	
	COS_DEV_SW4	10.250.0.4	>
	COS_DEV_SW4	Dell-b63fb6	
	cos_dev_sw27_huawei	10.250.0.12	>

Like in AutoTest and other AirCheck G3 screens, the icons in Discovery change color to indicate a **Warning** or **Failure** condition. Discovery also displays device icons in **Blue** to indicate Problem-related information that does not constitute a warning or failure, and **Green** to indicate that a previous Problem has been resolved. (See the [Problem Settings](#) to adjust enabled Problems and thresholds.)

The Discovery screen, and other app screens with long lists, support fast scrolling. Touch and drag the scrollbar handle to the right of the list to scroll quickly up and down.

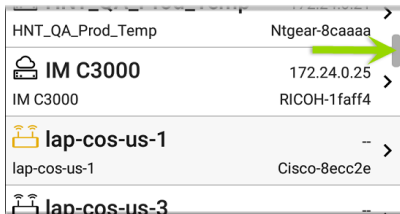

From the main Discovery screen, you can filter and sort the listed devices, open the left side

navigation drawer to configure settings, and tap a device's card to view its details.

The screenshot shows the Discovery App interface with several callouts:

- Total number of discovered devices:** A callout pointing to the text "Discovery (589)" in the header.
- Discovery Settings:** A callout pointing to the hamburger menu icon in the top left.
- Refresh Discovery:** A callout pointing to the "Refresh Discovery" button in the top right.
- Filter:** A callout pointing to the funnel icon in the top left of the list area.
- Sort:** A callout pointing to the "Name" dropdown menu in the top right of the list area.
- Touch a card to view device details:** A callout pointing to the "Angela's EtherScope ..." device card.

The main content is a list of discovered devices:

Device Name	IP Address	Manufacturer
AndroLinkSysWav	10.250.2.147	kin-454655
Andromeda Automati...	10.250.3.224	HP-235cc0
Angela's EtherScope ...	10.250.2.139	NetAlly-530000
Cetus	10.250.2.166	Dell-faa680
Cisco2500WLC	10.250.3.235	Cisco-556c80
cos-lab-ad.netally.eng	-	VMware-678cc2
COS_DEV_SW4	10.250.0.4	Dell-b63fb6
cos_dev_sw27_huawei	10.250.0.12	

Discovery List Cards

The information displayed on each device card varies depending on the selected Sort element and the data the AirCheck G3 was able to discover.

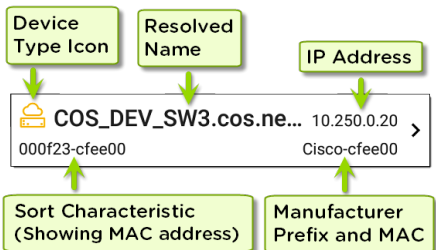

The lower left field displays the characteristic by which the Discovery list is currently sorted. In the image above, the list is sorted by MAC address. See [Discovery Sorts](#) in this topic for more about sorting.

Searching the Discovery List

The main Discovery screen offers a search feature. Tap the search icon  at the top of the

screen to search discovered devices.

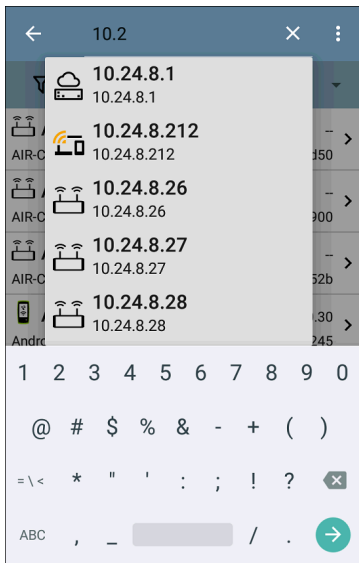



Filtering the Discovery List

Tap the filter button  near the top left of the main Discovery screen to set filters that control which devices are displayed in the list.

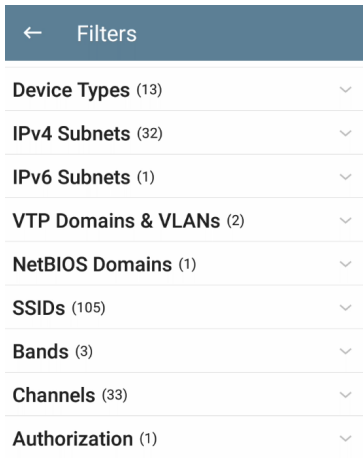

The Filters screen displays the number of devices or domains discovered for each category. Tap a category name to select filters

by checking the boxes. The main Discovery screen shows only those devices or IDs that fall under your chosen filter parameters.

When filters are selected, those active filters are displayed at the top of the Filters screen.

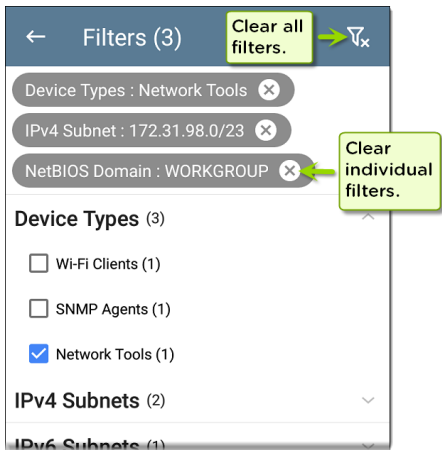

- Tap the **x** button to the right of each filter to clear it.

- Tap the clear filter icon at the top right to clear all filters.

After you select a filter, the Filters screen displays results filtered for that characteristic. For example, in the image above, the user has selected the **Network Tools** device type. As a result, only those subnets, addresses, Wi-Fi bands, etc., with a discovered Network Tool remain selectable in the filters list.

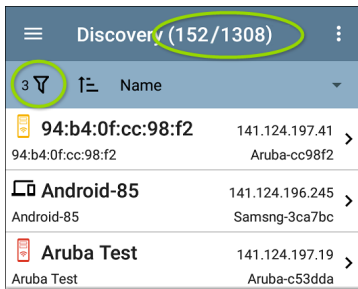

Back on the main Discovery screen, the screen title shows the number of filtered devices out of the total discovered devices (in the image above, 152 filtered devices out of 1308 total).

The number of active filters displays to the left of the filter icon (3 active filters in the image above).

Sorting the Discovery List

Tap the Sort bar or down arrow to open the Sort drop-down menu.

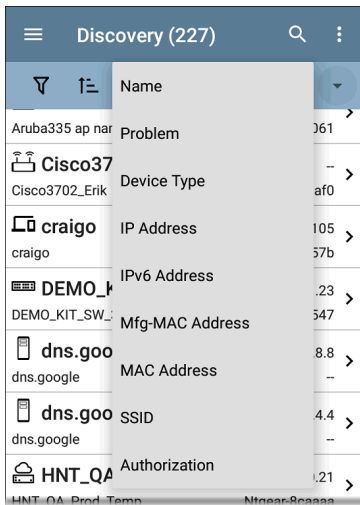

Select a Sort option to order the devices based on your selected characteristic.

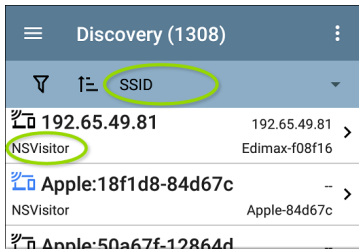

The selected Sort option displays in the Sort bar above the device list, and the sort characteristic for each device is shown under the device type icon. In the image above, all the devices associated with the "NSVisitor" SSID are sorted together. Individual devices on the same SSID are sorted numerically and alphabetically.

Tap the sort order icon  to switch the sort order between normal and reverse order.

Devices are sorted in groups. Those with resolved names appear at the top (in normal order), and then devices with only IPv4, IPv6, and MAC addresses appear below, respectively.

Reversing the normal sort order reverses the devices within the groups but does not change the order of the groups.

Security Auditing – Batch Authorization

Batch Authorization allows the user to extend the AirCheck G3's filtering to organize devices into the following security categories:

- **Authorized:** For devices approved for use on your network
- **Neighbor:** For devices owned and controlled by neighboring organizations
- **Flagged:** To give visibility to a specific device
- **Unknown:** For devices that have not been identified or classified
- **Unauthorized:** For devices that should not be on the network and may present a security risk
- **Unspecified:** Default unassigned Authorization status

Once categorized, it is simple to immediately identify any new devices on the network by filtering according to Authorization type. New devices are identified as Unspecified.

To use the Batch Authorization feature, create a filter that identifies the devices you want to categorize. For example, you could filter on SSIDs used by other offices in your building. After you filter the list of discovered devices, select the overflow menu.

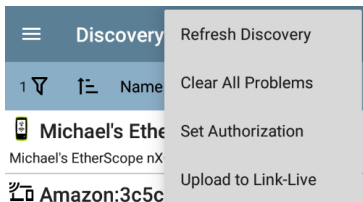

Select **Set Authorization** to see how these devices are currently categorized and the number of devices in each category.

Set Authorization

1077 of 1077 clients selected

- Authorized (5)
- Neighbor (0)
- Flagged (0)
- Unknown (0)
- Unauthorized (17)
- Unspecified (1055)

CANCEL

OK

NOTE: The initial selection on this screen defaults to the category with the highest count. If other categories have non-zero counts, selecting **OK** changes the authorization setting for all devices to the selected category.

Select the appropriate security category. As in the example, if these devices belong to other offices, select: Neighbor and then tap the **OK** button.

Set Authorization

13 of 96 devices selected

Authorized (0)

Neighbor (0)

Flagged (0)

Unknown (0)







Unauthorized (0)

Unspecified (13)

CANCEL **OK**

You can now sort the list of discovered devices and clearly identify the security category of the

devices. Devices from other offices are identified as: Neighbor

Discovery (32)		🔍	⋮
🔼	⏮	Authorization	▾
-		localAdmin-4bd5aa	
	localAdmin:6623ae-7b6756	-	>
-		localAdmin-7b6756	
	localAdmin:7223ae-7b6757	-	>
-		localAdmin-7b6757	
	localAdmin:86da88-a8d0d6	-	>
-		localAdmin-a8d0d6	
	localAdmin:d663fc-5b4f38	-	>
-		localAdmin-5b4f38	
	MXCHIP:c89346-87b4c4	-	>
-		MXCHIP-87b4c4	
	Netgear:803773-e4e2d3	-	>
-		Netgear-e4e2d3	
	Netgear:dcef09-a63460	-	>
-		Netgear-a63460	

See [Assigning a Name and Authorization to a Device](#) for more information on the Authorization feature.

NOTE: Batch Authorization operates on the default MAC address of a device. If a device has multiple MACs, authorization is set only on the default MAC address. Devices that do not have a discovered MAC address, such as unknown switches and off-net devices, cannot have an authorization setting.

Refreshing Discovery

Tap the action overflow icon  at the top right of the main Discovery screen, and select **Refresh Discovery** to refresh the active Discovery process.

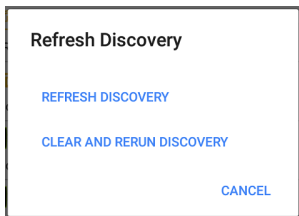

REFRESH DISCOVERY restarts the active discovery process without clearing the already discovered devices.

CLEAR AND RERUN DISCOVERY clears the accumulated results and restarts the discovery process.

Uploading Discovery Results to Link-Live

Tap the action overflow icon  at the top right of the main Discovery screen, and select **Upload to Link-Live** to send the current Discovery results to the Analysis page  on Link-Live.com.

**Link-Live**

by NetAlly



Discovery Snapshot Name

20190802_131842

Comment

1st Floor

Job Comment

Psych Building

SAVE TO ANALYSIS FILES

See the [Link-Live chapter](#) for more information.

Discovery Details Screens

Tap any of the device cards on the main Discovery list screen to view Device Details.

The example below calls out a Router card and its Details screen.

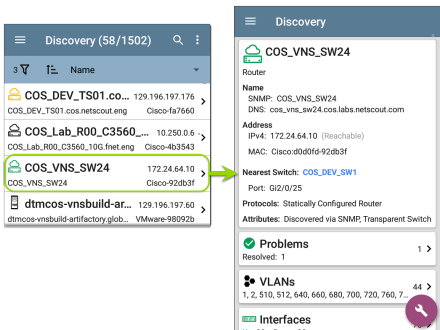



The available data and actions on the Details screens vary significantly depending on the device type, connections, and data the AirCheck G3 was able to discover. In other words, only the discoverable information for each device is shown on the Details screen.

 **Discovery**

 **123.136.196.236**
Switch
Address
IPv4: 123.136.196.236 (Reachable)
IPv6: fe80::7ad2:94ff:fec0:e607
MAC: Ntgear:78d294-c0e607
Attributes: Discovered via SNMP, Transparent Switch

 **Addresses** 2 >
IPv4: 1 IPv6: 1 MAC: 1

 **VLANs** 3 >
1, 2, 3

 **Interfaces** 15 >
Up: 2 Down: 13

 **SNMP** >
Uptime: 11 weeks 1 day 5 hours 14 minutes



For the Switch screen shown above, Discovery was able to find an IP address but not a name for the switch.

Each Details screen shows additional information about the selected device, any Problems detected by the AirCheck G3, and counts for other connected or corresponding network elements.

See [Device Types](#) for specifics about the different devices the AirCheck G3 can discover.

Top Details Card

The top card on the Details screen summarizes the discovered data for the selected device.

**Aruba Test**
Wi-Fi Controller
Name
SNMP: Aruba Test
Address
IPv4: 163.166.137.19 (Unassociated)
MAC: Aruba:186472-c53dda
Nearest Switch: [163.166.136.236](#)
Port: g1
Protocols: Statically Configured Router
Services: DHCP Server

The top of the card shows the device type(s) and icon (a Wi-Fi Controller with a **Failure or Error** status in the example image above).

The rest of the fields that appear on the top Details screen card depend on the device type and what the AirCheck G3 can discover about the device.

On the Discovery Details screens, you can tap any **blue linked name or address** to open a Discovery screen for the linked device.

NOTE: Non-underlined links open in the same app (in this case Discovery), and **underlined links** open in a different app .

 **Discovery**

 **Cisco3702**

Lightweight AP

Name
AP: Cisco3702
SNMP: Cisco3702

Address
IPv4: 10.250.3.69 (Reachable)
IPv6: 2001:c001:c0de:500:ba38:61ff:fe6e:1ae0
MAC: [Cisco:b83861-6e1ae0](#)

802.11
Channels: 1, 64
Type: 802.11ac

Nearest Switch: ~ [Unknown Switch 3](#) ~

Wi-Fi Controller: [Cisco2500WLC](#)
10.250.3.235

Last Seen: 5:23:20 PM

The linked and underlined Cisco MAC address in the screen image above opens the Wi-Fi app's AP Details screen, where you can view the other wireless attributes associated with the Lightweight AP. The Nearest Switch and Wi-Fi Controller links open a Discovery app Details screen for those devices.

Data Fields on the Top Details Card

The following fields may appear on the top card on a Device Details screen, depending on the device type and the information AirCheck G3 was able to discover:

Name: Discovered hostname(s) of the device. This section can display user-defined, DNS, mDNS, SNMP, NetBIOS, AP, and Virtual Machine names as discovered.

Address: Discovered IPv4, IPv6, BSSID, and/or MAC addresses of the device. This section displays the default (first discovered) addresses of each type. For more addresses, select the [Addresses](#) card when available.

Authorization: This field shows the user-assigned Authorization status of the device. See [Assigning a Name and Authorization to a Device](#).

802.11: Wireless data

Channels: Wi-Fi channels on which the device is operating

Type(s): 802.11 media type(s) supported by the device

Nearest Switch: Name or address of the switch identified as closest to the device

Port: Physical port where the device is connected

VLAN ID: ID of the VLAN the device is on

Protocols: Routing protocols, discovered via packet analysis, operating on the device or network

Services: Network services provided by this device, such as DHCP or DNS

Attributes: Other discovered attributes about the device

Wi-Fi Controller: Name and address of the Wi-Fi Controller for a Lightweight AP

AP: Access Point to which the device is connected

SSID: Name of the network on which the device is operating

Security: AP's security type

Hypervisor: Name of the hypervisor on which a virtual machine is operating

Virtual Machine: Name of the virtual machine

Guest OS: Operating system running on the virtual machine

Memory Reservation: Amount of memory reserved for the virtual machine

Last Seen: Time at which AirCheck G3 most recently detected the device

Lower Cards in Device Details

Tap any of the lower cards on a Device Details screen to view more discovered characteristics and "drill down" to specific Problems, Addresses, Interfaces, etc. for the selected device.

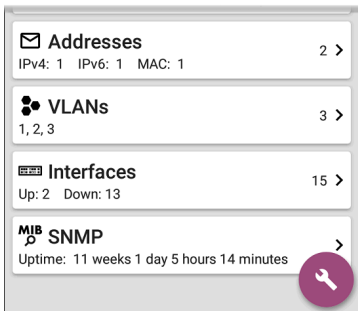

Screens with a list, such as Addresses shown below, also offer Sort options.

Addresses (3)	
↑	Address
IPv4 10.250.0.1 10.250.0.120	BSSID /22 549
IPv6 2001:c001:c0de 2001:c001:c0de	IP Address ... 549
IPv6 fe80::16 fe80::1618:77ff::	IPv6 Address Mfg-MAC Address 549
	MAC Address

The rest of this topic provides examples of each type of Details screen and options for additional analysis.

Remember, you can tap any card with a right pointing arrow ➤ to open a new screen with more information about the device or characteristic.

Problems

The Problems card shows the icon color of the highest severity problem, and the number of detected **Warning**, **Failure or Error**, **Information**, and **Resolved** conditions for the device or network component.



Tap the Problems card to view the Problems list screen (unless only 1 Problem is detected, in which case, the detailed Problem description opens, skipping the list screen).

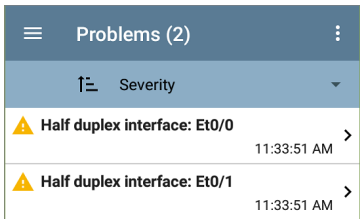

Tap the sort field to sort the list by **Severity** or by the time when the problem was **First Detected**.

On the Problems list screen, tap a Problem's row to read a detailed description.

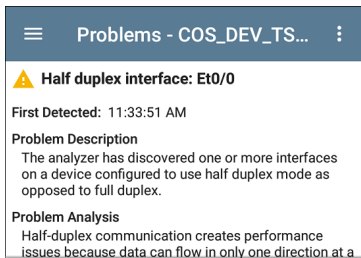

The screenshot shows a mobile application interface for 'Problems - COS_DEV_TS...'. At the top, there is a blue header bar with a hamburger menu icon on the left and a vertical ellipsis icon on the right. Below the header, a problem entry is displayed with a yellow warning triangle icon. The problem title is 'Half duplex interface: Et0/0'. Below the title, the text 'First Detected: 11:33:51 AM' is shown. The section 'Problem Description' contains the text: 'The analyzer has discovered one or more interfaces on a device configured to use half duplex mode as opposed to full duplex.' The section 'Problem Analysis' contains the text: 'Half-duplex communication creates performance issues because data can flow in only one direction at a'.

To clear a problem, tap the action overflow button  at the top right of the Problem list or description screen, and then tap **Clear Problem**.

See [Problem Settings](#) to select which problems are detected and displayed by your unit.

Addresses

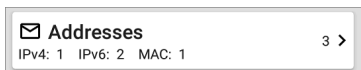

The screenshot shows a mobile application interface for 'Addresses'. It features a white card with a grey border. At the top left of the card is an envelope icon followed by the title 'Addresses'. At the top right is the text '3 >'. Below the title, the text 'IPv4: 1 IPv6: 2 MAC: 1' is displayed.

The Addresses card displays the number of each type of address discovered: IPv4, IPv6, MAC, and/or BSSID. Tap to view the addresses and related information.

Addresses (3)	
↑	Address
IPv4 10.250.0.120	10.250.0.0/22 >
10.250.0.120	Dell-3b5649
IPv6 2001:c001:c0de:500:1618:77f...	>
2001:c001:c0de:500:1618:77ff:fe3b:...	Dell-3b5649
IPv6 fe80::1618:77ff:fe3b:5649	>
fe80::1618:77ff:fe3b:5649	Dell-3b5649

From the Addresses list screen, you can sort the list order and tap any of the discovered addresses to investigate the address further.

TCP Port Scan

If you have run a TCP Port Scan (from the [Discovery FAB](#)) on a device or IP address, a TCP Port Scan card appears on the device's Details screen.

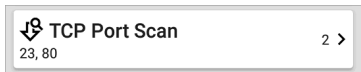

This card lists open port numbers and shows the total quantity of open ports. Tap the card to open the TCP Port Scan screen.

You can also open this screen from the [Discovery floating action menu](#).

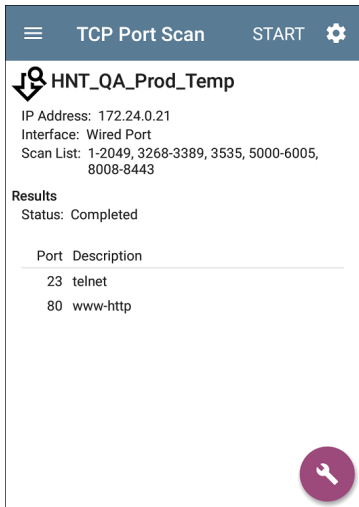

The screenshot shows the 'TCP Port Scan' results screen. At the top, there is a dark blue header with a hamburger menu icon on the left, the title 'TCP Port Scan' in the center, and the word 'START' and a gear icon on the right. Below the header, the device name 'HNT_QA_Prod_Temp' is displayed with a download icon to its left. The scan details are listed below: 'IP Address: 172.24.0.21', 'Interface: Wired Port', and 'Scan List: 1-2049, 3268-3389, 3535, 5000-6005, 8008-8443'. A 'Results' section follows, with 'Status: Completed'. Below this is a table with two columns: 'Port' and 'Description'. The table contains two entries: '23 telnet' and '80 www-http'. In the bottom right corner of the screen, there is a purple circular button with a white wrench icon.

☰ TCP Port Scan START ⚙

↓ HNT_QA_Prod_Temp

IP Address: 172.24.0.21
Interface: Wired Port
Scan List: 1-2049, 3268-3389, 3535, 5000-6005, 8008-8443

Results
Status: Completed

Port	Description
23	telnet
80	www-http

🔧

The top of the TCP Port Scan results screen shows the name or IP address of the tested device and the following fields:

IP address: IP address of the device that was scanned

Interface: Test or management port from which the test ran, set in the [TCP Port Scan settings](#)

Scan List: List of port numbers tested

Results

Status: Current status of the port scan

Port/Description: List of all the detected open ports with their descriptions

See also [TCP Port Scan Settings](#).

VLANs

The VLANs card displays the VLAN IDs this device is using or for which it is configured.

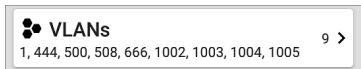

This card does not appear if no VLANs are detected or configured. Tap the card to open the VLANs screen.

COS_DEV_SW33	
 VLANs	
VLAN	Description
1	default
444	VLAN0444
500	VLAN0500
508	LabWiFi
666	VLAN0666
1002	fddi-default
1003	token-ring-default
1004	fddinet-default
1005	trnet-default

The VLANs Details screen also shows the description with each VLAN ID.

Interfaces

Interface are discovered using SNMP.

 Interfaces	171 >
Up: 20 Down: 151	

The Interfaces card shows the number of Up and Down interfaces and the total number of Interfaces to the right.

Tap the card to view the list of Interfaces.

Interfaces (171)		↻
⌄	Interface Status	▾
↑	VLAN-1002 Status: up	0 b VLAN: 1002 >
↑	VLAN-1003 Status: up	0 b VLAN: 1003 >
↑	VLAN-1005 Status: up	0 b VLAN: 1005 >
↓	Fa1 Status: down	100 Mb VLAN: -- >
↓	Gi1/3 Status: down	1 Gb FDx VLAN: 1 >

Like other Discovery list screens, the Interfaces list provides a number of Sort options, and the selected sort option affects the type of information displayed. The image above shows Interfaces sorted by Status (up or down). The image below shows Interfaces sorted by MAC Address, so each Interface's MAC address is displayed.

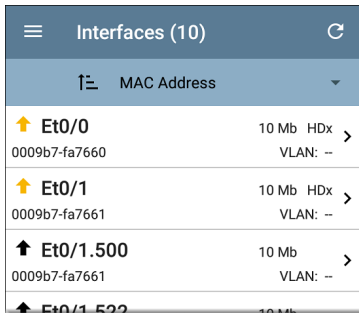

The screenshot shows a mobile application interface titled "Interfaces (10)". At the top left is a hamburger menu icon, and at the top right is a refresh icon. Below the title bar is a header row with a sort icon and the text "MAC Address" followed by a dropdown arrow. The main content is a list of network interfaces, each with a status icon (upward arrow), name, speed, type, and VLAN information. A chevron icon on the right of each row indicates it is tappable.

Interfaces (10)			
Sort	MAC Address		
↑	Et0/0 0009b7-fa7660	10 Mb HDx	VLAN: --
↑	Et0/1 0009b7-fa7661	10 Mb HDx	VLAN: --
↑	Et0/1.500 0009b7-fa7661	10 Mb	VLAN: --
↑	Et0/1.522	10 Mb	

Tapping an Interface row opens a new Discovery Details screen for the selected Interface.

The screenshot shows a mobile application interface for network discovery. At the top, there is a blue header bar with a hamburger menu icon on the left, the text 'COS_DEV_TS01.cos.net...' in the center, and a refresh icon on the right. Below the header, the main content area is divided into three sections. The first section is titled 'Et0/1' with an upward-pointing arrow icon. It contains the text 'DOT1Q Trunk to CISCO_3750_PoE COS_DEV_SW2 f...', 'Status: up', 'Speed: 10 Mb', 'Duplex: HDx', 'MTU: 1500', 'Connected Device: COS_DEV_SW1', 'Port: Gi2/0/30', and 'Address' with 'MAC: Cisco:0009b7-fa7661'. The second section is titled 'Devices' with a square icon and shows '0' devices with a right-pointing arrow. The third section is titled 'Statistics' with a line graph icon and shows 'Util: 0.3 %', 'Discards: 0.0 %', and 'Errors: 0.0 %' with a right-pointing arrow.

The Interface Details screen contains a description of the interface and information about its Status, Connected Device and Port, and Address.

MTU: Maximum Transmission Unit, the maximum packet frame size configured on the interface port

From this screen, you can tap the lower cards to review any discovery **VLANs** and **Devices** for the Interface as well as graphs of the Interface **Statistics**.

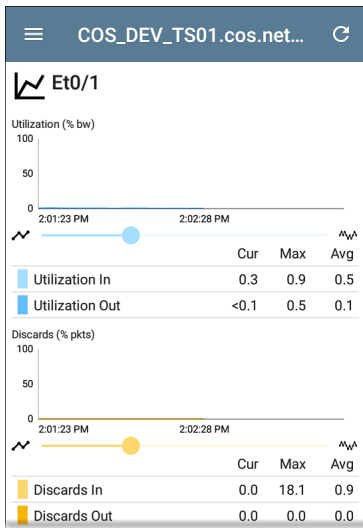

The Statistics screen displays real-time trending graphs of Utilization, Packet Discards, Packet Errors. See the [Trending Graphs](#) topic for an overview of the graphs' pan and zoom controls.

Below the trending graphs are pie charts of Packet transfers to and from the Interface.

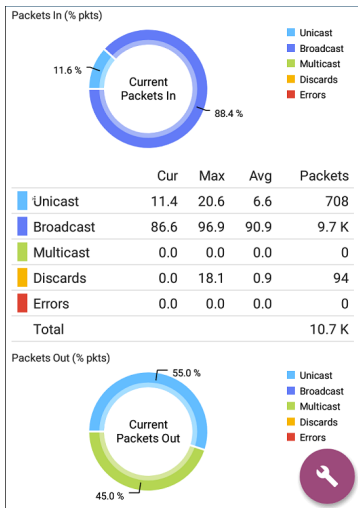

SNMP

This card shows device details gathered via SNMP and SNMP connectivity to the device.

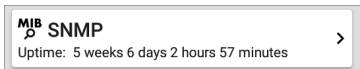

The SNMP card displays the SNMP Uptime. Tap the card for SNMP Details.



COS_DEV_SW34

MIB SNMP**SNMP System Group**

Uptime: 5 weeks 6 days 2 hours 58 minutes

Manufacturer: Cisco

Model: cat4500e

Serial Number: FOX1407GRJA

HW Version: V02

SW Version: 15.2(2)E7

Description:

Cisco IOS Software, Catalyst 4500 L3 Switch
Software (cat4500e-ENTSERVICES-M), Version
15.2(2)E7, RELEASE SOFTWARE (fc3)

Technical Support:<http://www.cisco.com/techsupport>

Copyright (c) 1986-2017 by Cisco Systems, Inc.

Compiled Wed 12-Jul-17 14:36 by

SNMP

Type: SNMP v1/v2/v3

Engine ID: 80000009030068efbd6f4b80

Communication: SNMP v2

Using: Default Community String: public

SNMP System Group: These data fields are gathered from the system group and other key device version information.

SNMP: SNMP versions the device supports, Engine ID (for v3), and how the AirCheck G3 is currently communicating with the device, along





with credentials, including the Community String in use

Connected Devices

The Connected Devices card appears on the Details screen for [Unknown Switches](#). While the AirCheck G3 may be unable to directly identify the connected switch, the devices connected to it provide clues about where the switch is operating.



The Connected Devices card shows the number of discovered devices that are connected to the Unknown Switch. Tapping the card opens a Discovery list screen with the connected devices.

Connected Devices (8)		
	IP Address	
 COS_DEV_SW1 10.250.0.1	Gi1/0/38 Cisco-07ac01	>
 10.250.2.143 10.250.2.143	-- NetAlly-02506e	>
 10.250.2.177 10.250.2.177	-- TRENDn-af1e30	>
 10.250.3.32 10.250.3.32	-- NetAlly-02506e	>

Resources

 **Resources** >
 CPU: 28% Memory: 35%

The Resources card shows the percentages of CPU, memory, and storage usage on the device. This information is gathered via SNMP.

Tap the card to view current and maximum resource utilization measurements.

COS_DEV_SW34		
 Resources		
	Cur	Max
CPU %	12	12
Memory %	60	60
Last Update: 1:44:22 PM		

By default, AirCheck G3 displays a **Warning** condition if CPU, Memory, or Storage utilization is above 90%. You can adjust problem detection and thresholds in the [Problem Settings](#) accessed from the Discovery navigation drawer.

SSIDs

The SSIDs card appears in the Details for [Wi-Fi Controllers](#). This information is gathered via SNMP.



This card shows the number of SSIDs gathered from SNMP. Tap the card to view the list of SSIDs.

Cisco2500WLC		
SSIDs		
SSID	Security	VLAN
✓ CiscoQATest-maana	WPA2-P, WPA-P	--
✓ Cisco WEP64 OA	WEP	--
✓ aa-Cisco-Wep	WEP	--
✓ aonly	WPA2-P, WPA-P	--
✓ Cisco ISE	WPA2-E	--
✓ RF Chamber	WPA2-P, WPA-P	--
✓ Lobo	WPA2-P, WPA-P	--
✓ COS Cisco Captive Portal	Web	--
✗ Portal Test	Web	--
✓ [Cisco Hidden]	WPA2-P	--
✓ Cisco 2.4G	WPA2-P	--

On the SSIDs screen, each SSID is shown with its Security type(s) and any VLANs. SSIDs with a checkmark to the left are enabled, and those with an ✗ are disabled.



Discovery App Floating Action Menu

The floating action button (FAB) on Details screens offers additional actions depending on the device type and connection available.

Opening other NetAlly apps, such as [Path Analysis](#), [Ping/TCP](#), or [Capture](#),

from a Details screen auto-populates the new app with the device's name and/or address. In this way, both the Discovery and [Wi-Fi](#) apps provide a helpful shortcut and prevent you from needing to type in target addresses or hostnames in other testing apps.

- Tapping TCP Port Scan opens the [TCP Port Scan screen](#) in the Discovery app.
- Selecting **Browse** opens Google Chromium.

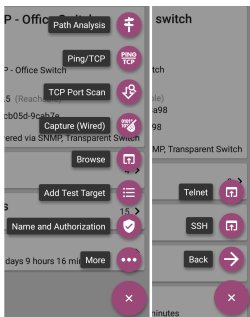



- Tapping **Add Test Target** creates a new AutoTest target matching the currently selected device. A dialog first displays to select the test type, then the AutoTest app opens, displaying the newly added target's settings, where you can further customize it.
- For devices with a MAC address or BSSID, tapping **Name** and **Authorization** opens a dialog where you can assign a custom user name and Authorization status. See [Assigning a Name and Authorization to a Device](#) in the Wi-Fi app chapter.
- Tapping **More** opens a secondary list of additional floating action buttons. Tapping **Back** returns to the original list.
- [Telnet](#) or [SSH](#) open the JuiceSSH app.

Auto-Populating Device Addresses

When another app is opened from the FAB, the default address and name shown on the [Top Details Card](#) are the targets populated.

For example, the Router shown in the Details screen below has multiple IPv4 and MAC addresses (which can be viewed by tapping the Addresses card).

 **Discovery**

 **Rack5SW1.fnet.eng**
Router

Name
SNMP: Rack5SW1.fnet.eng

Address
IPv4: 10.250.3.207 (Reachable)
MAC: Cisco:00141c-8945c1



Nearest Switch: [COS_DEV_SW1](#)
Port: Gi2/0/39

Protocols: Statically Configured Router

Attributes: Discovered via SNMP, Transparent Switch

 **Addresses** 6 >
IPv4: 6 MAC: 5

 **VLANs** 66 >
1, 2, 21, 42, 78, 85, 154, 202, 236, 378, 478, 5...

 **Interfaces** 
Up: 12 Down: 30

When you open the FAB and select a different app, such as Path Analysis, only the address and name listed at the top of the Details screen are populated in the Path Analysis app.

 **Rack5SW1.fnet.eng**

Router

Name
SNMP: Rack5SW1.fnet.eng ←



Address
IPv4: 10.250.3.207 (Reachable) ←
MAC: Cisco:00141c-8945c1

Nearest Switch: [COS_DEV_SW1](#)



Port: Gi2/0/39 **Path Analysis** 

Protocols: Statically Configured Router



Attributes: Discovered via SNMP **Ping/TCP** 

 **Addresses** **Capture (Wired)** 

IPv4: 6 MAC: 5

 **VLANs** **Browse** 

1, 2, 21, 42, 78, 85, 154, 202, 236, 378, 478, 5...

 **Interfaces** 

Up: 12 Down: 30

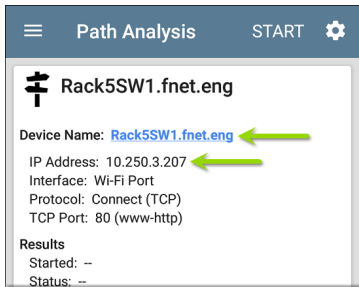

To open another screen or app with a different address, open the Addresses card, and select another address to view its Details screen.

Device Types

The Discovery app lists and analyzes the types of devices explained in this section. Different data may be available to the AirCheck G3 depending on the device type, how it was discovered, and your configured settings.

See [Discovery Settings](#) for [SNMP Configuration](#) and [Devices Discovered Through Other Devices](#) options.

For descriptions of the different Details cards and screens, see [Discovery Details](#).

The images in the rest of this section represent an example of the data Discovery may display for each device type.

Routers

AirCheck G3 discovers IP routers by monitoring traffic and querying hosts.

☰ Discovery

 **COS_DEV_SW34**

Router

Name
SNMP: COS_DEV_SW34

Address
IPv4: 10.250.0.34 (Reachable)
MAC: Cisco:68efbd-6f4bbf

Nearest Switch: [Rack5SW1.fnet.eng](#)

Port: Gi1/0/11
VLAN ID: 500

Protocols: Statically Configured Router

Attributes: Discovered via SNMP, Transparent Switch

 **VLANs** 17 >
1, 244, 500, 801, 803, 804, 805, 806, 825, 830...

 **Interfaces** 171 >
Up: 20 Down: 151

 **SNMP** >



Switches

Switches are also discovered by monitoring traffic and querying hosts.

 **Discovery**

 **cos-dev-sw18-poe**

Switch

Name
SNMP: cos-dev-sw18-poe



Address
IPv4: 10.250.3.216 (Reachable)
MAC: Cisco:503de5-220c43

Attributes: Discovered via SNMP, Transparent Switch

 **Addresses** 2 >
IPv4: 2 MAC: 2

 **VLANs** 37 >
1, 11, 196, 500, 502, 504, 508, 510, 511, 518, ...

 **Interfaces** 38 >
Up: 9 Down: 29

 **SNMP** 
Uptime: 27 weeks 2 days 7 hours 25 minutes

Unknown Switches

Unknown switches are detected indirectly by analyzing traffic going through surrounding switches. The AirCheck G3 cannot identify the switch, but it can sense where a switch is active on the network via the device MAC addresses in that space.

The AirCheck G3 numbers the switches as they are discovered. (These numbers may change each time the discovery process runs.)

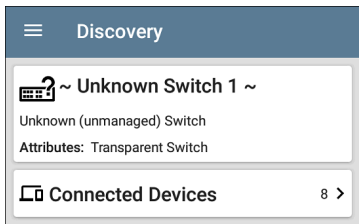

The Unknown Switches Details screen shows the number of devices connected to the switch. Tap the [Connected Devices](#) card to view the connected devices, which may provide clues about the location of the unknown switch.

Network Servers

Network servers include NetBIOS, DHCP, and DNS servers.

☰ Discovery

 **Compass.netally.eng**

Network Server

Name
Virtual Machine: [Compass.netally.eng](#)
DNS: [compass.fnet.eng](#)
NetBIOS: COMPASS

Address
IPv4: 10.250.3.221 (Reachable)
IPv6: 2001:c001:c0de:500:d1f5:d8e0:a81:3397
MAC: VMware:000c29-13235b

Nearest Switch: ~ [Unknown Switch 4](#) ~

Hypervisor: [COS-PNT-VM.fnet.eng](#)
10.250.3.251

Virtual Machine
Guest OS: Windows Server 2008 Standard Edition,
32-bit Service Pack 2 (Build 6003)
Memory Reservation: 2,048MB

Services: DNS, Virtual Machine

 **Addresses**



Hypervisors

VMware hypervisors are discovered via SNMP. The hypervisor's SNMP agent must be enabled for the AirCheck G3 to discover it and classify it as a hypervisor.

☰
Discovery



COS-PNT-VM.fnet.eng

Hypervisor

Name
SNMP: COS-PNT-VM.fnet.eng

Address
IPv4: 10.250.3.251 (Reachable)
IPv6: fe80::1618:77ff:fe34:db2a
MAC: Dell:141877-34db2a

Nearest Switch: ~ Unknown Switch 4 ~

Hypervisor
Product Name: VMware ESXi
Product Version: 6.7.0
Product Build: 13644319
Memory: 98207MB
CPUs: 2
Virtual Machines: 16

Services: Hypervisor

Attributes: Port Aggregation

✉ Addresses
IPv4: 1 IPv6: 1 MAC: 1



Virtual Machines

VMware virtual machines are discovered from VMware client table in SNMP-enabled VMware hypervisors. Devices are also classified as Virtual Machines if they have a VMware MAC.

☰ **Discovery**

 **Cisco ACS 5.8 Linux**

Virtual Machine

Name
Virtual Machine: Cisco ACS 5.8 Linux

Address
IPv4: 10.250.0.59 (Reachable)
IPv6: 2001:c001:c0de:500:20c:29ff:fe0b:e61c
MAC: VMware:000c29-0be61c

Nearest Switch: ~ Unknown Switch 4 ~

Hypervisor: COS-PNT-VM.fnet.eng
10.250.3.251

Virtual Machine
Guest OS: Linux 2.6.32-431.20.3.el6.x86_64 Red Hat Enterprise Linux Server release 6.4 (Santiago)
Memory Reservation: 4,096MB

Services: Virtual Machine

 **Addresses**
IPv4: 1 IPv6: 2 MAC: 1



Wi-Fi Controllers

AirCheck G3 can discover SNMP enabled Wi-Fi controllers, including Cisco and Aruba Wi-Fi Controllers.

 **Discovery**

 **Cisco2500WLC**
Wi-Fi Controller

Name
SNMP: Cisco2500WLC



Address
IPv4: 10.250.3.235 (Reachable)
"MAC: Cisco:ece1a9-556c80

Attributes: Discovered via SNMP, Transparent Switch
AP Capacity: 75

 **APs** 2 >

 **SSIDs** 16 >

 **VLANs** 1 >

 **Interfaces**
Up: 2 Down: 3 

Access Points (APs)

The AirCheck G3 discovers APs through wireless packet analysis and SNMP queries with a linked connection through a management or test port.

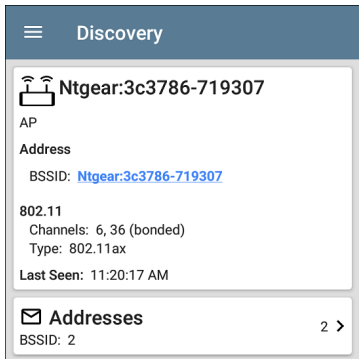

The screenshot shows the 'Discovery' screen of the app. At the top, there is a blue header with a hamburger menu icon and the word 'Discovery'. Below this, a card displays information for an AP. The card has a white background and a grey border. It starts with a wireless router icon and the text 'Ntgear:3c3786-719307'. Underneath, it says 'AP'. The 'Address' section shows 'BSSID: [Ntgear:3c3786-719307](#)'. The '802.11' section lists 'Channels: 6, 36 (bonded)' and 'Type: 802.11ax'. The 'Last Seen' is '11:20:17 AM'. At the bottom of the card, there is an 'Addresses' section with an envelope icon, the text 'Addresses', and 'BSSID: 2' on the left, and '2 >' on the right.

See also [APs in the Wi-Fi analysis app](#).

Wi-Fi Clients

Wireless clients are discovered through wireless packet analysis and SNMP queries with a linked connection through a management or test port.

☰ Discovery

 **Samsng:4c6641-701864**

Wi-Fi Client

Address

MAC: [Samsng:4c6641-701864](#)

802.11

Channels: 60
Type: 802.11ac

AP: [lap-cos-us-1](#)

SSID: NSVisitor
Security: WPA2-P

Last Seen: 11:15:45 AM

 **Problems** 1 >

Warnings: 1

See also [Clients in the Wi-Fi analysis app](#).

VoIP Phones

VoIP discovery provides visibility into the VoIP and layer 2/3 configuration of the network.

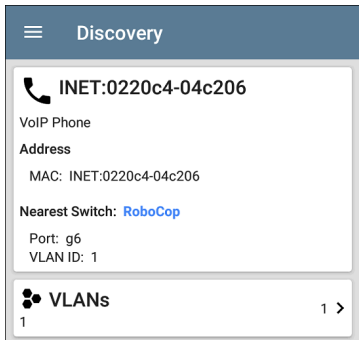

The screenshot shows the Discovery App interface. At the top is a dark blue header with a hamburger menu icon on the left and the word "Discovery" in white. Below the header is a white card with a grey border. The card contains a phone icon, the text "INET:0220c4-04c206", and the label "VoIP Phone". Underneath is the "Address" section with "MAC: INET:0220c4-04c206". The "Nearest Switch" is listed as "RoboCop" in blue. Below that, "Port: g6" and "VLAN ID: 1" are shown. At the bottom of the card is a "VLANs" section with a cluster icon, the number "1", and a right-pointing chevron.

Discovery

 **INET:0220c4-04c206**

VoIP Phone

Address

MAC: INET:0220c4-04c206

Nearest Switch: [RoboCop](#)

Port: g6
VLAN ID: 1

 **VLANs** 1 >

1

Printers

The AirCheck G3 identifies IP printers via the SNMP Printer MIB and IPX printers via diagnostic requests and queries.

 **Discovery**

 **TOSHIBA e-STUDIO3005AC**
Printer
Name
SNMP: TOSHIBA e-STUDIO3005AC
mDNS: MFP12073521
NetBIOS: MFP12073521
Address
IPv4: 143.131.143.43 (Reachable)
IPv6: fe80::280:91ff:feb8:3a31
MAC: Tokyo:008091-b83a31

 **Problems** 1 >
Warnings: 1

 **Addresses** 3 >
IPv4: 1 IPv6: 2 MAC: 1

 **Interfaces** 2 >
Up: 2 Down: 0

 **SNMP**



SNMP Agents

SNMP agents are discovered using SNMP queries. See [SNMP Configuration](#).

NOTE: If AirCheck G3 cannot discover the SNMP agents on your devices, they may be connected to another subnet, like a management subnet. Solve this issue by adding the subnet to [Extended Ranges](#).

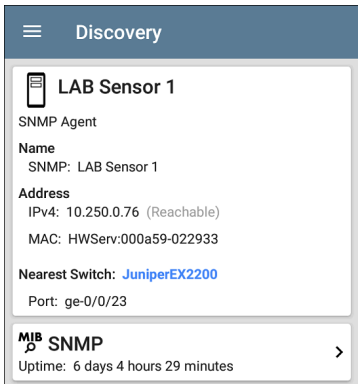

The screenshot shows a mobile application interface with a dark blue header containing a hamburger menu icon and the word "Discovery". Below the header is a white card with a grey border. The card displays the following information:

- LAB Sensor 1** (with a mobile phone icon)
- SNMP Agent
- Name**
SNMP: LAB Sensor 1
- Address**
IPv4: 10.250.0.76 (Reachable)
MAC: HWServ:000a59-022933
- Nearest Switch:** [JuniperEX2200](#)
Port: ge-0/0/23







Below the card is another white card with a grey border, containing:

- MIB** [SNMP](#) (with a right-pointing chevron icon)
- Uptime: 6 days 4 hours 29 minutes

See also [SNMP Details](#).

NetAlly Tools

The AirCheck G3 can also identify other NetAlly network testers, including AirCheck G3, AirCheck G2, OneTouch AT, LinkRunner (AT and G2), and Test Accessory.

Discovery (122/708)		
1	Device Type	
 fe80::2c0:17ff:fe53:138	-	>
EtherScope nXG	NetAlly-530138	
 fe80::2c0:17ff:fe53:146	-	>
EtherScope nXG	NetAlly-530146	
 10.250.3.147	10.250.3.147	>
AirCheck G2	NetAlly-350593	
 NetAlly:00c017-353246	-	>
AirCheck G2	NetAlly-353246	
 10.250.2.117	10.250.2.117	>
LinkRunner G2	NetAlly-c50070	
 10.250.2.132	10.250.2.132	>
Test Accessory	NetAlly-330e87	

The image above shows several NetAlly tools as they appear in the main Discovery list.

AirCheck G3 displays all the information it can gather about each tool on the Details screen.

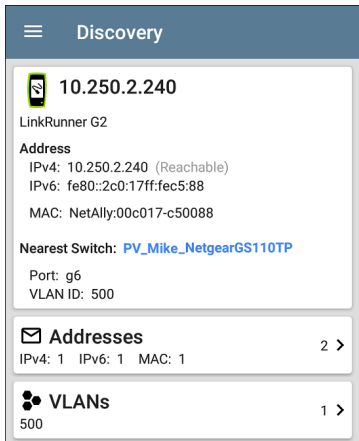



The screenshot shows the 'Discovery' screen of the AirCheck G3 app. At the top, there is a blue header with a hamburger menu icon and the word 'Discovery'. Below the header, the main content area is divided into several sections:

- Device Information:** A green icon with a white 'S' and a red dot is next to the IP address **10.250.2.240**. Below it, the device is identified as **LinkRunner G2**.
- Address Section:** A section titled **Address** containing:
 - IPv4: 10.250.2.240 (Reachable)
 - IPv6: fe80::2c0:17ff:fec5:88
 - MAC: NetAlly:00c017-c50088
- Nearest Switch:** A section titled **Nearest Switch:** with the value **PV_Mike_NetgearGS110TP** in blue text.
- Port and VLAN:** Below the switch name, it shows **Port: g6** and **VLAN ID: 500**.
- Addresses Summary:** A section titled **Addresses** with an envelope icon, showing **IPv4: 1 IPv6: 1 MAC: 1** and a right arrow with the number **2**.
- VLANs Summary:** A section titled **VLANs** with a cluster of three dots icon, showing **500** and a right arrow with the number **1**.

Hosts/Clients

Other hosts and clients are discovered by traffic monitoring and querying. If a host cannot be identified as belonging to one of the other categories (Switch, Router, VoIP device, etc.) then it is categorized as Host/Client.

 **Discovery**

 **ubuntu**

Host/Client

Name
mDNS: ubuntu

Address
IPv4: 10.250.2.109 (Reachable)
IPv6: 2001:c001:c0de:500:b844:4388:4fb7:4506
MAC: ORICO:f01e34-1fbaa4

Nearest Switch: [PV_Mike_NetgearGS110TP](#)

Port: g3
VLAN ID: 500

 **Addresses** 4 >

IPv4: 1 IPv6: 3 MAC: 1

 **VLANs** 1 >

500

NOTE: A MAC address that begins with LocalAdm indicates that the address has been locally randomized to prevent unauthorized tracking.



Discovery

**localAdm:227367-a99246**

Wi-Fi Client

AddressMAC: [localAdm:227367-a99246](#)**802.11**

Channels: 48

Type: --

AP: [localAdm:decbac-51a778](#)

SSID: ngenius&sniffer

Security: WPA2-E

Discovery Settings

Discovery configurations include SNMP settings, Community Strings and the order in which they are used, Credential Sets, Ports, Extended Ranges, and process intervals.

Access the Discovery settings screen by sliding out the left-side navigation drawer or tapping the menu icon , and selecting **Discovery Settings**.

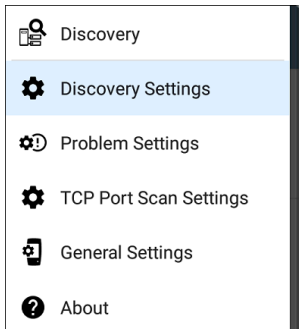

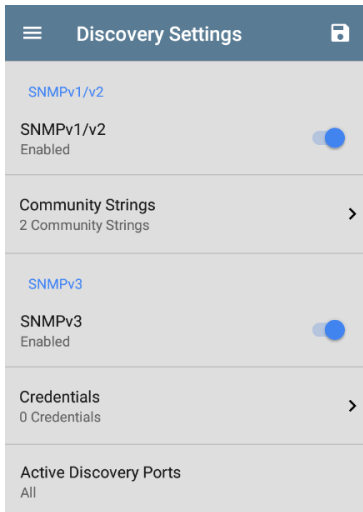

(Tap here to skip to [Problem Settings](#), [TCP Port Scan](#), or back to [General Settings](#).)



To adjust Discovery Settings:

1. On the **Discovery Settings** screen, tap each field described in this topic, as needed, to select or enter your required configuration elements.

2. When you finish configuring, tap the back button  to return to the main [Discovery List](#) screen.
3. Then, [Refresh Discovery](#) from the action overflow menu  to apply the new configuration.

You can load, save, import, and export configured Discovery settings by tapping the save button  on this screen.

- **Load** opens a previously saved Discovery configuration.
- **Save As** saves the current configuration with an existing name or a new custom name.
- **Import:** Import a previously exported settings file.
- **Export:** Create an export file of the current settings, and save it to internal or connected external storage.

See [Managing Testing App Settings](#) for more instructions.

After you have saved a configuration, the custom name you entered appears in the title of the

Discovery Settings screen. In the image below, a user has saved a custom configuration named "South Campus," which replaces the "Discovery Settings" screen title.

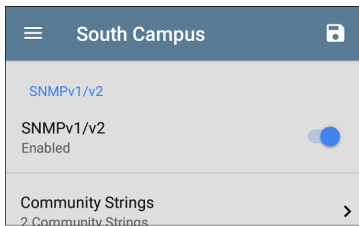

SNMP Configuration

The MIB (Management Information Base) of SNMP managed devices contains information such as device configuration, interface configuration and statistics, SNMP tables (like host resource and route tables) and VLAN details.

Through the Discovery process, the AirCheck G3 interrogates MIBs to determine the device type, ports, connected subnets, and other data.

SNMP credentials are required to communicate with the SNMP agents on your interconnect

devices, such as switches and routers. The Discovery Settings allow you to enter the SNMP community strings and credential sets the AirCheck G3 uses to communicate with those devices.

SNMPv1/v2

Tap the toggle button to enable or disable SNMPv1 and v2 queries. This setting is enabled by default and uses the Community Strings configured in the next setting.

Community Strings

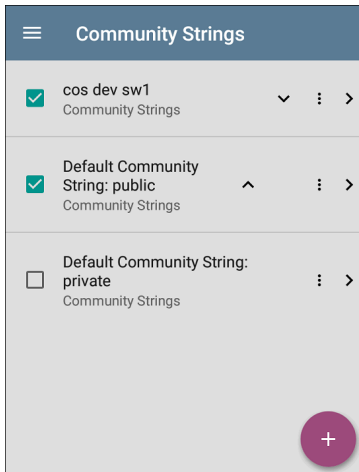

Tap this field to open the Community Strings list screen and add, edit, or remove community strings.



The AirCheck G3 uses the checked strings in the order shown on this screen. If it does not receive a response from the queried device using one string, it sends the next string.

NOTE: This screen and others in the Discovery settings operate much like the [AutoTest Profile Group screen](#).

On the Community Strings screen, you can perform these actions:

- Check or uncheck the boxes to include or exclude a string from use in the current Discovery configuration.
- Tap the up and down arrows  to change the order in which the AirCheck G3 uses the strings to query a device.
- Tap the action overflow icon  to **Duplicate** or **Delete** a Community String.
CAUTION: Deleting a string removes it from all saved Discovery configurations. To remove a string from the current Discovery configuration only, simply uncheck it.
- Tap the FAB  to add new Community Strings.
- Tap any Community String's row to edit the string and its description.

TIP: To minimize discovery time, uncheck or delete all unused community strings, as every failed query extends the discovery time. You can also arrange the community strings in the order they are used most.

SNMPv3

Tap the toggle button to enable or disable SNMPv3 queries. This setting is enabled by default and uses the Credentials configured in the next setting.

NOTE: If this setting is enabled, but no SNMPv3 credentials are configured, the AirCheck G3 discovers the engine IDs of all SNMPv3 agents. This is a good way to discover if a device support SNMPv3.

Credentials

Tap this field to open the Credentials list screen.

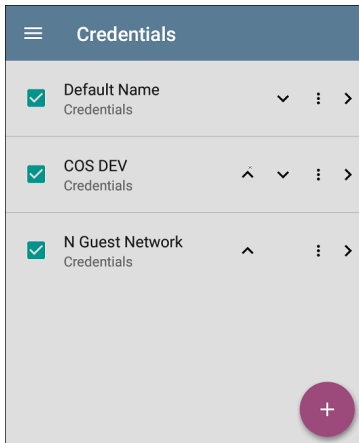

This screen interface works like the Community Strings screen above. AirCheck G3 uses the Credentials in the order shown.

- Check or uncheck the boxes to include or exclude a set of Credentials from use in the current Discovery configuration.
- Tap a row to edit its credentials.

- Tap the FAB  to add new credentials.

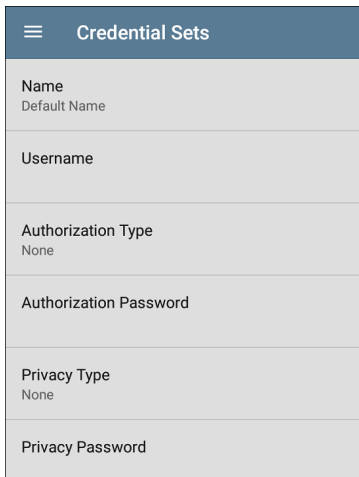

Credential Sets	
Name	Default Name
Username	
Authorization Type	None
Authorization Password	
Privacy Type	None
Privacy Password	

On the Credentials Sets screen, tap each field to select or enter the credentials required.

Name

Tap the **Name** field to enter a custom name for the Credential Set.

Username

Tap to enter the SNMPv3 username.

Authorization Type and Password

AirCheck G3 Discovery supports two SNMPv3 Authorization types: HMAC-SHA and HMAC-MD5. If Authorization is required, enter the appropriate password.

Privacy Type and Password

AirCheck G3 Discovery supports four Privacy Types: CBC-DES, AES-128, AES-192, AND AES-256. If needed, enter the appropriate Privacy Password.

Discovery Settings	
Active Discovery Ports	All
Extended Ranges	0 Extended Ranges >
Devices Discovered Through Other Devices	All
Refresh Interval	90 minutes
Device Health Interval	10 minutes

Active Discovery Ports

Tap **Active Discovery Ports** to select which port Discovery uses to gather data. Discovery runs through the enabled ports only if an active network link is available.

Discovery uses all of the ports by default. Uncheck them to limit which ports are used.

See [Selecting Ports](#) for explanations of the different ports.

Extended Ranges

The Extended Ranges screen allows you to enter addresses of non-local subnets on which you want the Discovery process to run. Discovery sweeps all of the enabled Extended Ranges for devices, whether directly connected or off-net. The AirCheck G3 performs Ping sweeps on subnets that are not directly connected and ARP sweeps on connected subnets.

When the SNMP agents are on a subnet that is separate from the hosts (PC's and servers) subnet, additional networks must be configured for discovery:

- The network address of the remote subnet you want to discover, meaning the host (PC and server) network.
- The network address of the switch and router SNMP agents in the remote subnet, e.g. a management subnet.

Configure both **SNMP Credential Sets** and **Extended Ranges** to ensure that the AirCheck G3

always discovers management subnets, regardless of your network port connections.

Tap the field to open the Extended Ranges list screen.

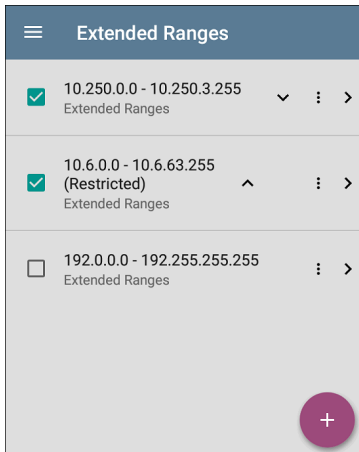

- Check or uncheck the boxes to include or exclude an extended range from the current Discovery configuration. Unchecked

Extended Ranges do not affect the default Discovery behavior in the current configuration, but they may be used in other Discovery configurations (like Community Strings and Credentials).

- Tap any Extended Range's row to edit its address and subnet.
- Tap the FAB  to add new extended ranges.

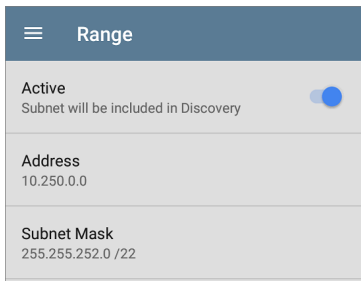

Range	
Active	<input checked="" type="checkbox"/>
Subnet will be included in Discovery	
Address	10.250.0.0
Subnet Mask	255.255.252.0 /22

Active vs. Restricted Subnets

For each configured Extended Range, you can tap the toggle button to switch from **Active** to **Restricted**. Discovery is performed on Active Ranges. Setting a Range to **Restricted** disables

the discovery process on that network or subnet, meaning the AirCheck G3 will *not* communicate with devices within the restricted range.

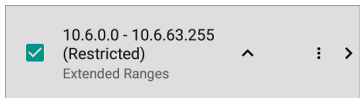

- Restricted Ranges take precedence regardless of the order in which they are listed on the Extended Ranges screen.
- You can Restrict a part of a configured Active Extended Range.
- You can also restrict a single device, whether it is part of an Active Range or not. To enter a single device that you do not want discovered, enter its IP address in the Address field, and set the Subnet Mask field to 255.255.255.255.

Address

Tap the **Address** field to enter or select an IP address range.

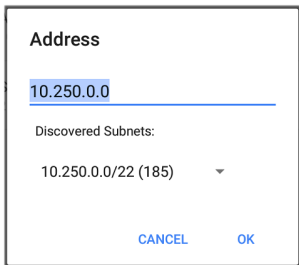

Address

10.250.0.0

Discovered Subnets:

10.250.0.0/22 (185) ▼

CANCEL OK

Tap the drop-down menu to select a previously Discovered Subnet. The Address field is automatically populated with your selection.

Subnet Mask

Tap this field to select a subnet mask. If you select an already Discovered Subnet, the Subnet Mask is also pre-populated.

Devices Discovered Through Other Devices

By default, AirCheck G3 discovers devices from SNMP tables of other devices. If you do not want Discovery to automatically find devices from

SNMP tables of the device types listed here, you can uncheck their boxes.

Devices Discovered Through Other Devices

- Routers and Subnets
- Switches
- VoIP Devices
- Wi-Fi Clients
- Virtual Machines

[CANCEL](#) [OK](#)

Routers and Subnets

When the Routers and Subnets checkbox is enabled, any discovered routers are included in discovery results. In addition, if Discovery has SNMP access to a discovered router, its routing tables are read, and the next hop routers are added to the Discovery list. If any local subnets are available in the routing tables, these are also

added to the Subnets list. This process continues until all the available SNMP credentials are tried for the added routers.

NOTES: Discovery does not sweep every discovered subnet; discovered subnets are only added to the subnets list. To perform discovery in a specific subnet, see **Extended Ranges** above.

If another site has routers you want to discover using this process but there isn't a local next hop link from this site, you can add one of the routers of that site to discovery. The process then runs from that router and finds the routers on that site as well. Add the subnet of the router or just the router's IP address with a mask of /32 to Extended Ranges.

Switches

When the Switches checkbox is enabled, discovery adds any switches that it finds in SNMP neighbor tables of other devices to the Discovery list.

For example, when AirCheck G3 is reading the CDP and LLDP caches of one switch, it contains other switches. If this option is enabled, the AirCheck G3 adds those other switches, even if they are not in discovery ranges.

NOTE: To Discover switches at another site, add one of the switches of that site to Discovery Extended Ranges.

VoIP Devices

When the VoIP Devices checkbox is enabled, discovery adds any VoIP devices that it finds in SNMP tables of other devices regardless of the subnet. These are usually found in the LLDP-MED tables of the switches. Enabling the Switches option provides the best chance of finding all your VoIP devices.

Wi-Fi Clients

When the Wi-Fi Clients checkbox is enabled, discovery adds any wireless clients it finds in SNMP tables of APs and Wireless LAN Controllers. Enabling this option along with Switches provides best chance of finding all Wi-Fi clients.

NOTE: Enabling Wi-Fi Clients here may cause Wi-Fi devices to show in Discovery that do not

Virtual Machines

When the Virtual Machines checkbox is enabled, discovery adds any virtual machines that it finds in SNMP tables of other devices. These are usually found in the ESX host > SNMP tables. Adding the subnets of your ESX hosts to Extended Ranges helps with finding your virtual machines.

Refresh Interval

This setting controls the time between runs of the Discovery process. By default, Discovery runs every 90 minutes. Tap the **Refresh Interval** field to select a different interval, up to 8 hours.

The **Manual** option turns off regular automatic Discovery, and the process refreshes only if you select **Refresh Discovery** from the main Discovery list screen.

Device Health Interval

Discovery automatically runs a set of network health tests to search for network Problems, such as high utilization, discards, or errors on all discovered interfaces and device resources.

The selected time Refresh Interval is the minimum time between each run of the Device Health tests. Tap the field to disable Device Health testing or to change the interval from the default of 10 minutes to 30 or 60 minutes.

Disabling the Device Health testing affects the types of Problems that Discovery can detect.

See also [Problem Settings](#).

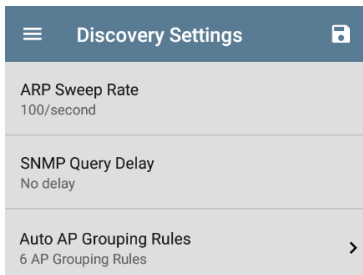

ARP Sweep Rate

Tap the ARP Sweep Rate field to select a rate between 5 and 100 ARP requests per second.

This setting can prevent the AirCheck G3 from shutting down ports that sense too many ARPs are being sent.

SNMP Query Delay

This function controls how long your AirCheck G3 waits between SNMP queries to key tables that can cause CPU spikes in the SNMP agents, including the ARP cache, IP address table, routing tables, and FDB tables.

The default SNMP Query delay is No Delay. When querying the key large tables, the AirCheck G3 asks for more data as soon as a response has been received. You can select a 1 or 5 second delay if needed.

Auto AP Grouping Rules

Auto AP Grouping Rules

6 AP Grouping Rules



This feature allows you to adjust the AP Grouping Rules that control how the AirCheck G3 groups BSSIDs with their Access Points, such that they are grouped appropriately for your AP types and environment.

For example, if BSSIDs from different APs are

Tap the setting to open the AP Grouping Rules list screen. The image below shows the six default AP Grouping Rules on the AirCheck G3. The **Prefix filters** in all of the default grouping rules are set to 000000-000000.

AP Grouping Rules			
<input checked="" type="checkbox"/>	Grouping 1 FFFFFFFFFFC0	▼	⋮ >
<input checked="" type="checkbox"/>	Grouping 2 00FFFFFFFFFF	▲ ▼	⋮ >
<input checked="" type="checkbox"/>	Grouping 3 FFFFFF0FFFFF	▲ ▼	⋮ >
<input checked="" type="checkbox"/>	Grouping 4 00FF0FFFFFFF	▲ ▼	⋮ >
<input checked="" type="checkbox"/>	Grouping 5 0DFFFFFF0FFFF	▲ ▼	⋮ >
<input checked="" type="checkbox"/>	Grouping 6 F0FFFFFFFFF0	▲	⋮ >

As with other settings list screens on the

Check or uncheck the boxes to include or exclude a rule from use in the current Discovery configuration.

Tap the action overflow icon  to **Duplicate** or **Delete** a rule.

CAUTION: When you delete a rule, you delete it from all saved Discovery configurations. To remove a rule from those used by the current Discovery configuration, simply uncheck it.

Tap the FAB  to add a new rule.

Tap any rule's row to edit it.

AP Grouping Rules	
Name	Grouping 1
Prefix filter	000000000000
Filter mask	FFFFFFFFFC0

Name

If desired, enter a custom name for a default or new rule. If you intend to use a Prefix filter, a best practice would be to name the rule with the AP manufacturer's name.

Prefix filter

Use the **Prefix filter** to create a rule for a specific AP manufacturer's BSSID scheme, meaning a rule for just one AP manufacturer prefix. The default rules all contain a default Prefix filter of 000000-000000.

If a Prefix filter is non-zero, its second and third bytes are compared to discovered BSSIDs before the **Filter mask** (described below) is applied. These two bytes must match exactly, or the two BSSIDs are not grouped together. This behavior allows you to specify a fairly open Filter mask, because the mask applies only to one manufacturer.

For example, you could have Cisco APs whose BSSIDs all start with b83861. By specifying a Prefix filter of 003861-000000, you limit the grouping rule to just those APs.

Filter mask

The Filter mask specifies what parts of the BSSIDs are compared when determining AP groupings.

For example, default **Grouping Rule 1** has a Filter mask of FFFFFFFF-FFFFC0, so any BSSIDs that vary only by the lower six bits are grouped together.

Problem Settings

The Problem settings determine which issues are detected and displayed by *both* the Discovery and [Wi-Fi Analysis](#) apps as well as the thresholds for enabled problems, such as Packet Discards and Utilization.

Access the Problem Settings screen by sliding out the left-side navigation drawer or tapping the menu icon  in the Discovery app, and selecting **Problem Settings**.

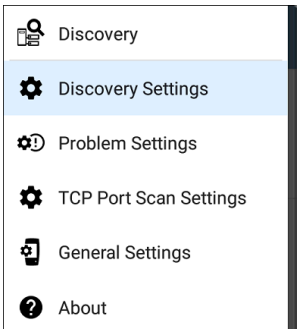

(Tap here to go to [Discovery Settings](#) or back to [General Settings](#).)

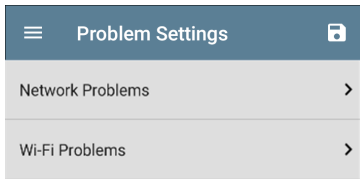



Problems are categorized as Network or Wi-Fi. NOTE: The Wi-Fi Problems configured here also control the [Problems](#) detected and displayed in the [Wi-Fi Analysis](#) app.

As with [Discovery Settings](#), you can save, load, import, and export configured Problem Settings by tapping the save button  on this screen. See [Managing Testing App Settings](#) for more instructions.

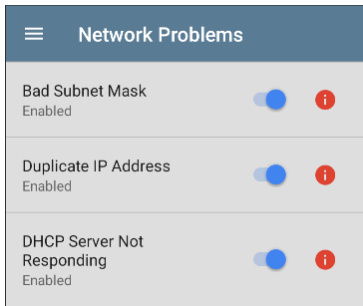
Tap the row for each to enable or disable the problem types and set thresholds where applicable.



All Problem types are enabled by default. Tap the toggle button to the right to disable each one.

Tap the red , yellow , or blue  information icons to the right of each Problem to read a detailed description and recommended actions. **Red** icons indicate Failure conditions and **yellow** indicate Warning conditions. **Blue** icons are simply informational.

When you finish configuring, tap the back button  to return to the main Discovery screen.

TCP Port Scan Settings

The TCP Port Scan feature checks for open ports on the current device from the [Discovery Details](#) screen's [FAB](#). The AirCheck G3 scans many ports simultaneously and reports the open port's numbers.

Access the TCP Port Scan Settings by sliding out the left-side navigation drawer or tapping the menu icon  in the [Discovery](#) app.

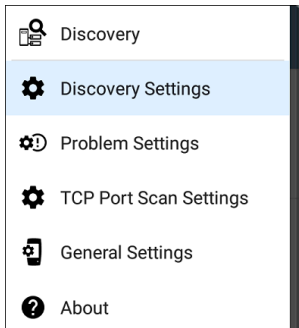

Select **TCP Port Scan Settings**.

TCP Port Scan Settings	
Interface	Any Port
Scan List	1-2049, 3268-3389, 3535, 5000-6005, 8008-8443
Timeout Threshold	1 s

Interface: Tap the field to select the AirCheck G3 port from which the port scan runs. (See [Selecting Ports](#) for explanations of the different ports.)

Scan List: This setting lists which port numbers are tested during the port scan. Tap the field to enter different port numbers or ranges, separated by commas.

Timeout Threshold: This value controls how long the AirCheck G3 waits for a response from each port. Once all the ports in the Scan List have had this amount of time to respond, the scan ends, and the TCP Port Scan results screen

lists the ports that responded within the threshold.

See also the [TCP Port Scan results card and screen](#).



Wi-Fi Analysis App

The Wi-Fi Analysis app scans the wireless channels in your environment to discover and gather data about the devices and traffic on your Wi-Fi networks. Wi-Fi discovery begins when you power on the AirCheck G3, and measurements update with each channel scan cycle.

The AirCheck G3 supports 802.11a/b/g/n/ac/ax technologies and operates in both the 2.4 GHz and 5 GHz bands. AirCheck G3 can also detect and indicate the 802.11ax media type (known as Wi-Fi 6) being used on APs and Clients, as reported in the wireless management frames.

The Wi-Fi app features separate screens that list and display characteristics of the different devices and elements of your wireless environment. Tap a link below to go directly to the description of the screen listed:

- [Channels Map](#)
- [Channels](#)
- [SSIDs](#)
- [APs](#)
- [BSSIDs](#)
- [Clients](#)

Wi-Fi Analysis and Discovery

Wi-Fi Analysis uses the [Wi-Fi Test Port](#) to scan the channels and acquire information about your wireless networks. If the Wi-Fi Test Port is linked (for instance after running a [Wi-Fi AutoTest Profile](#)), the port unlinks and resumes scanning when you open the Wi-Fi Analysis app.

Wi-Fi Analysis is enhanced with data gathered by [Discovery](#). When the AirCheck G3 is linked to a network through one of its Wi-Fi ports, Discovery can obtain information from network layers 3 and above, such as IP addresses, Protocols, and SNMP data.

Therefore, the information Wi-Fi Analysis is able to display also depends on configured [Discovery Settings](#), such as [SNMP Community Strings and Credentials](#), [Active Discovery Ports](#), [Extended Ranges](#), and [Device Health](#) testing.

Wi-Fi App List Screens

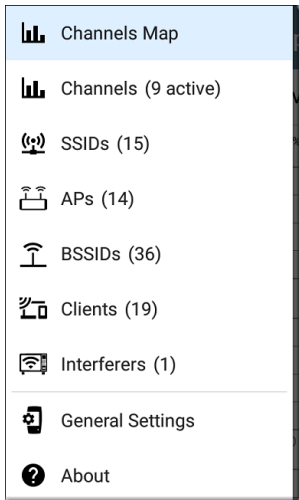

To switch between the different Wi-Fi app screens, tap the menu icon  (or swipe right) to open the left-side navigation drawer.



The Wi-Fi app's navigation drawer displays a real-time count (in parentheses) of each wireless component AirCheck G3 has detected. Tap an option to open the corresponding screen.

NOTE: The **General Settings** for Wi-Fi control which channels and bands are scanned to populate the Wi-Fi screens. See the [General Settings](#) topic for more explanation.

Wi-Fi App List Screens

The Wi-Fi app screens, except for Channels Map, display a list of discovered items, much like a [Discovery App list screen](#). You can [Filter](#)  and [Sort](#)  the list by different characteristics and tap a network component's card to view its details.

The example image below shows the APs screen with common Wi-Fi app functions:

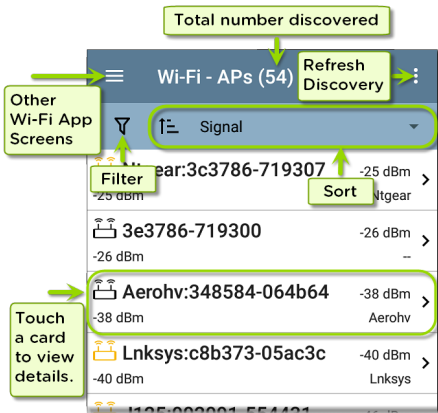

Like in AutoTest and other AirCheck G3 screens, the icons in Wi-Fi analysis change color to indicate a **Warning** or **Failure** condition. The app also displays icons in **Blue** to indicate Problem-related information that does not constitute a warning or failure, and **Green** to indicate that a previous Problem has been resolved.

NOTE: To adjust the **Problem Settings**, access them from the Discovery app's left-side navigation drawer. Problem Settings in the

Discovery app are also applied to the Wi-Fi Analysis app.

The Wi-Fi list screens, and other app screens with long lists, support fast scrolling. Touch and drag the scrollbar handle to the right of the list to scroll quickly up and down.

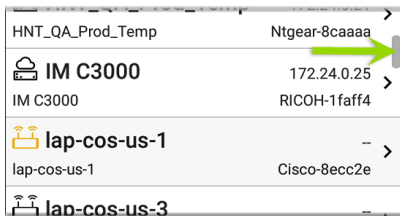

Wi-Fi List Cards

The information displayed on each card varies depending on the selected Sort characteristic and the data the AirCheck G3 was able to discover. For example, a card on the Channels list screen displays the channel number, frequency, connected APs, and utilization.

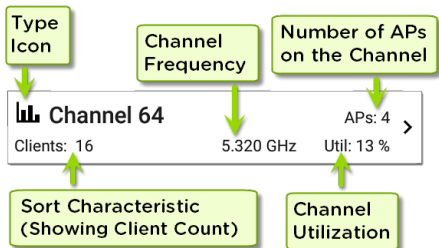

The lower left field displays the characteristic by which the list screen is currently sorted. In the image above, the Channels list is sorted by Client Count.

If a device is grayed out, the AirCheck G3 no longer detects a signal from it. The client card shown below indicates that the "Rspbry" client cannot be detected currently.



The time the device was Last Seen, meaning last detected by the AirCheck G3, is shown on the device's Details screen.

☰ **Wi-Fi - Client**

 Rspbry:b827eb-35a92a

Wi-Fi Probing Client

Address

MAC: Rspbry:b827eb-35a92a

802.11

Channel: 44

Type: --

Signal: --

SNR: --

Last Seen: 3:12:15 PM 

 **RF and Traffic Statistics** >

CH: 44 Utilization: 0%

Filtering in the Wi-Fi App

Each Wi-Fi Analysis screen has different Filter options that are appropriate for the network component type you are analyzing.

Tap the filter button  near the top left of the Wi-Fi screens to set filters that control which network components are displayed. You can also

filter the **Channels Map > Overlap** screen, as shown below:

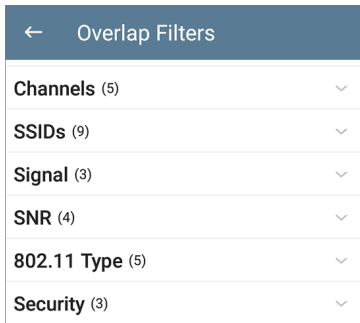

← Overlap Filters	
Channels (5)	∨
SSIDs (9)	∨
Signal (3)	∨
SNR (4)	∨
802.11 Type (5)	∨
Security (3)	∨

The number in parentheses shows how many active network characteristics are detected for each category. (The example shows (5) active Channels, (9) SSIDs, and so on.)

Tap a category to select filters by tapping the checkboxes or radio buttons.

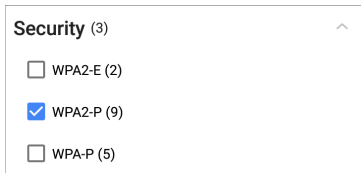

Under each category, the number of discovered APs is shown for each characteristic. (In the example above, there are (3) Security types detected and (9) APs using the WPA2-P Security type.)

In this example, the Overlap screen shows only those APs that fall under your chosen filter parameters.

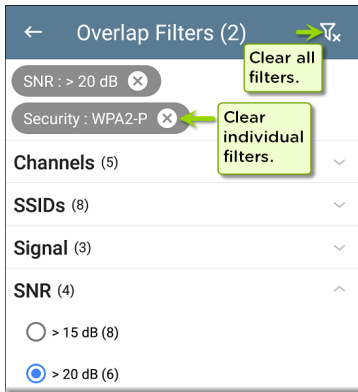

When filters are selected, those active filters are displayed at the top of the Filters screen.

- Tap the **x** button to the right of each filter to clear it.
- Tap the clear filter icon at the top right to clear all filters.

Back on the Overlap screen, the number of active filters displays to the left of the filter icon, like this: 2 .

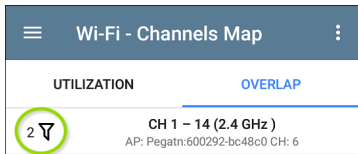

The screenshot shows the 'Wi-Fi - Channels Map' screen. At the top, there is a blue header with a hamburger menu icon on the left and a vertical ellipsis icon on the right. Below the header, there are two tabs: 'UTILIZATION' and 'OVERLAP', with 'OVERLAP' being the active tab. A green circle highlights a filter icon (a downward-pointing triangle) with the number '2' next to it. To the right of the filter icon, the text reads 'CH 1 - 14 (2.4 GHz)' and 'AP: Pegatn:600292-bc48c0 CH: 6'.

If the screen is a list, like the APs screen below, the screen title shows the number of filtered devices out of the total discovered devices (5 filtered devices out of 16 total).

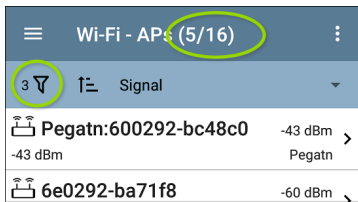

The screenshot shows the 'Wi-Fi - APs (5/16)' screen. At the top, there is a blue header with a hamburger menu icon on the left and a vertical ellipsis icon on the right. The title 'Wi-Fi - APs (5/16)' is displayed in the center, with '(5/16)' circled in green. Below the header, there is a filter icon (a downward-pointing triangle) with the number '3' next to it, also circled in green. To the right of the filter icon, there is a filter icon (a triangle with a horizontal line) and the text 'Signal'. Below the filter icon, there is a list of APs. The first AP is 'Pegatn:600292-bc48c0' with a signal strength of '-43 dBm'. The second AP is '6e0292-ba71f8' with a signal strength of '-60 dBm'. Each AP entry has a right-pointing arrow next to it.



Sorting in the Wi-Fi App

Tap the Sort bar or down arrow to open the Sort drop-down menu. Each list screen supports relevant Sort options based on what you are viewing. The APs screen Sort options are shown below as an example.

The screenshot shows the 'Wi-Fi - APs (55)' screen. A sort menu is open, displaying the following options:

- Signal
- Name
- Problem
- Mfg Prefix
- SSID Count
- BSSID Count
- Channel Count
- Client Count
- Authorization

The background list shows APs with their respective signal strengths and names:

AP Icon	IP Address	Signal Strength	Name	Other Info
📶	192.168	-29 dBm	Name	Bm ear >
📶	AsusTk:	-34 dBm	Problem	Bm sTk >
📶	10.24.8.	-39 dBm	Mfg Prefix	Bm icw >
📶	10.24.8.	-39 dBm	SSID Count	Bm icw >
📶	10.24.8.	-40 dBm	BSSID Count	Bm icw >
📶	10.24.8.	-40 dBm	Channel Count	Bm icw >
📶	Lnksys:	-42 dBm	Client Count	Bm sys >
📶	10.24.8.35	-43 dBm	Authorization	

Select a Sort option to order the list based on your selected characteristic.

Wi-Fi - APs (16)		
Filter	Sort	SSID Count
	Tchclr:7c9a54-be4263	-68 dBm > Tchclr
	SSIDs: 4	
	Pegatn:600292-bc48c0	-42 dBm > Pegatn
	SSIDs: 3	
	Tchclr:7c9a54-be425a	-66 dBm > Tchclr
	SSIDs: 3	

The selected Sort option displays in the Sort bar above the list, and the sort characteristic for each item is shown under the type icon and name. In the image above, the discovered APs are sorted by SSID Count, which is shown below each AP icon.

Tap the sort order icon to switch the sort order between normal and reverse order.

Wireless devices and IDs are sorted in groups. Those with resolved names appear at the top (in normal order), and then devices with only IPv4,

IPv6, and MAC addresses appear below, respectively. Reversing the normal sort order reverses the devices within the groups but does not change the order of the groups.

Refreshing Wi-Fi

Tap the action overflow icon  at the top right of the screen in any of the Wi-Fi screens (Channels Map, Channels, SSID, APs, BSSIDs, or Clients), and select **Refresh Wi-Fi** to clear and repopulate the Wi-Fi app screens with data.

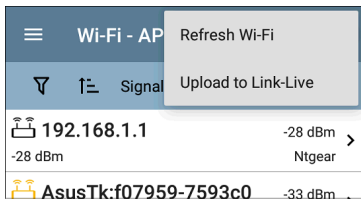

Clearing All Problems

Tap the action overflow icon  at the top right of the screen in any of the Wi-Fi screens (Channels Map, Channels, SSID, APs, BSSIDs, or

Clients), and tap **Clear All Problems** to clear all detected problems on all Wi-Fi lists.

See [Wi-Fi Problems Screen](#) for more information.

Setting Authorization

You can also use the Authorization to sort the BSSID and Clients lists. From the BSSID or Clients list screen, tap the action overflow icon  at the top right and select **Set Authorization** to see how these devices are currently categorized and the number of devices in each category.

Set Authorization

1077 of 1077 clients selected



- Authorized (5)
- Neighbor (0)
- Flagged (0)
- Unknown (0)
- Unauthorized (17)
- Unspecified (1055)

CANCEL

OK

See ["Assigning a Name and Authorization to a Device"](#) on page 464 for more information.

Uploading Wi-Fi Results to Link-Live

Tap the action overflow icon  at the top right of the screen in any of the Wi-Fi screens (Channels Map, Channels, SSID, APs, BSSIDs, or Clients), and tap **Upload to Link-Live** to send the current Wi-Fi results to the Analysis page  on Link-Live.com.

NOTE: Discovery app results automatically upload with the Wi-Fi results.

**Link-Live**

by NetAlly

**Wi-Fi Snapshot Name**20190812_210303

Comment3rd floor

Job CommentUnion Hall

**SAVE TO ANALYSIS FILES**

See the [Link-Live chapter](#) for more information.

Wi-Fi Details Screens

Tapping any card on a list screen—SSIDs, APs, BSSIDs, or Clients—opens the Details screen for that device or network ID.

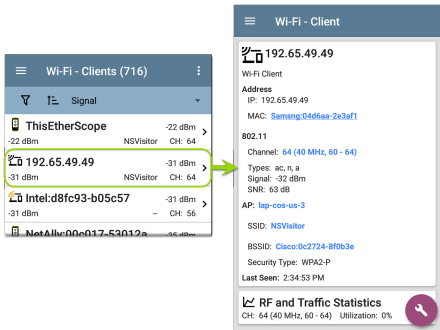

On the Wi-Fi Details screens, you can tap any **blue linked name or address** to open a Discovery or Wi-Fi app screen for the linked device.

NOTE: Non-underlined links open in the same app (in this case Wi-Fi), and **under-**

[lined links](#) open in a different app (in this case Discovery).

Each Details screen shows additional information about the selected item, any Problems detected by the AirCheck G3, and counts for other connected network devices or IDs.

See also [Data Fields on the Top Details Card in the Discovery chapter](#). Many of the Discovery data fields are the same as those shown in Wi-Fi Details.

☰ **Wi-Fi - Channel**

 **Channel 64**

5.320 GHz

Channel: 64

Center Frequency: 5.320 GHz

Frequency Range: 5.310 - 5.330 GHz

Width: 20 MHz

Band: 5 GHz UNII - 1/2



Attributes: Dynamic Frequency Selection (DFS)
channel

 **SSIDs** 2 >

 **APs** 1 >

 **BSSIDs** 2 >

 **Clients** 2 >

 **RF and Traffic Statistics** 

Signal: 70 dBm Utilization: 10%

The Channel Details screen above shows how many SSIDs, APs, BSSIDs, or Clients are detected on Channel 64. Tap the lower cards in Wi-Fi

Details to open a list screen that is filtered for the network component you are examining.

If you select BSSIDs on the Details screen for Channel 64, the BSSIDs screen opens and filters for BSSIDs found on Channel 64 only.

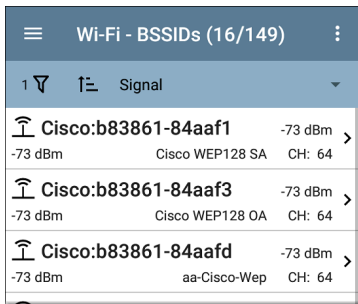

See the topics for each Wi-Fi app screen type (SSIDs, APs, etc.) for more discussion of the corresponding Details screen.

Wi-Fi Problems Screen

If any of the enabled Wi-Fi Problems are detected, the Problems card appears on the Wi-Fi Details screen.

The screenshot shows the 'Wi-Fi - AP' screen. At the top is a blue header with a hamburger menu icon and the text 'Wi-Fi - AP'. Below this is a white card for the access point 'TRENDn:d8eb97-af1e2c'. The card contains the following information: an orange Wi-Fi router icon, the text 'AP', the AP ID 'TRENDn:d8eb97-af1e2c' (with a blue link), 'Mfg Prefix: TRENDn', '802.11', 'Types: ac, n, g, a, b', 'Security Type: WPA2-P', 'Signal: -54 dBm', and 'Last Seen: 3:47:10 PM'. Below the main card is a 'Problems' card with a yellow warning triangle icon, the text 'Problems', 'Warnings: 2', and a right-pointing arrow with the number '2'. At the bottom is a partially visible 'SSIDs' card with a signal strength icon.

The Problems card shows the icon color of the highest severity problem, and the number of detected **Warning**, **Failure**, **Information**, and **Resolved** conditions for the device or network component.

Tap the card to open the Problems screen.

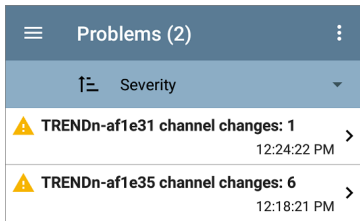

On the Problems list screen, tap a Problem's row to read a detailed description.

You can also tap the sort field to sort the list by **Severity** or by the time when the problem was **First Detected**. To clear a problem, tap the action overflow button  at the top right, and then tap **Clear Problem**.

See [Problem Settings](#) in the Discovery app to select which Wi-Fi Problems are detected and displayed by your AirCheck G3.

RF and Traffic Statistics Overview

The Channel, BSSID, and Client Details screens can display RF and Traffic Statistics if any traffic is detected.

This section describes the common elements of the RF and Traffic Statistics screen. See the topic for each type of Details screen for differences.



The RF and Traffic Statistics card shows the Channel number or the Signal strength of the strongest AP on the channel and the channel's Utilization percentage.

Tap the card to view graphs of Signal, Noise, Utilization, and Retries.

To pan and zoom on the graphs, you can swipe, double tap, and move the slider. See the [Trending Graphs](#) topic for an overview of the graph controls.

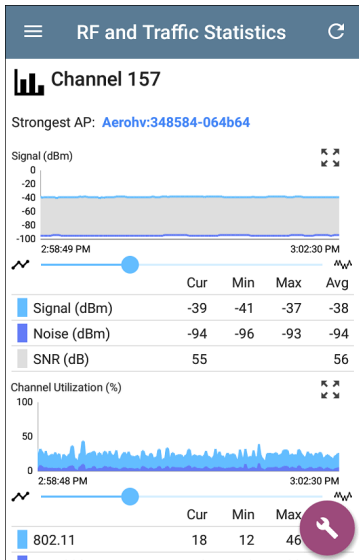

Strongest AP: The AP on the channel with the strongest signal

Under each graph, a legend table displays the Current, Minimum, Maximum, and Average

measurements. The Current column contains measurements from the last second. Min, Max, and Avg columns show cumulative measurements gathered during the time the RF and Traffic screen has been open.

Tap the refresh button  at the top of the screen to clear and restart the measurements.

Signal (dBm) graph: Plots the signal strength in dBm of the selected AP or AP with the strongest signal on a channel

- Y-axis scales to the max Tx Rate supported by the Access Point, not the Wi-Fi Client.
- Signal - The AP's signal strength in dBm
- Noise - The noise level in dBm on the channel used
- SNR - The network's signal-to-noise ratio, a measure of signal strength relative to noise, measured in decibels (dB)

Channel Utilization (%) graph: Plots percentage of the channel capacity being used by 802.11 devices and by non-802.11 interference.

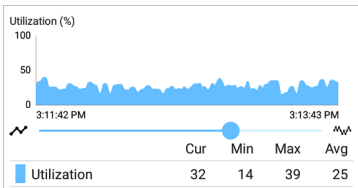

Retries (% of packets) graph: Plots percentage of transmitted packets that are retry packets.

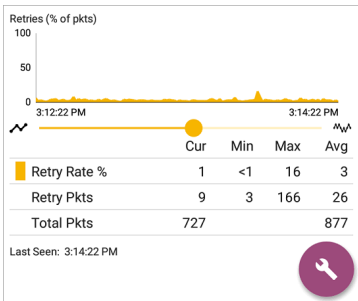



- **Retry Rate %** - The percentage of total packets that are retry packets
- **Retry Pkts** - The number of retry packets

- Total Pkts - The total number of transmitted packets

Locating Wi-Fi Devices

You can use your AirCheck G3 to locate APs and Wi-Fi clients from the Channels Map screen for [BSSIDs](#) and [Clients](#).

To begin a location action:

1. Start the Wi-Fi app.
2. From the menu icon , select **BSSIDs** or **Clients**.
3. Select the BSSID or Client that you want to locate.
4. Tap the FAB menu icon  in the lower right corner of the screen. This displays the FAB pop-up options.

The screenshot displays the 'Wi-Fi - BSSID' screen in the Wi-Fi Analysis App. At the top, there is a blue header with a menu icon and the title 'Wi-Fi - BSSID'. Below this, a grey card contains the following information:

- BSSID:** ASUSTekC:d850e6-cc9c9c
- SSID:** wisornet-wpa2psk
- AP:** router.asus.com
- BSSID:** d850e6-cc9c9c
- 802.11**
- Channel:** 48 (80 MHz, 36 - 48)
- Types:** ac, n, a
- Signal:** -46 dBm
- SNR:** 43 dB
- Security Type:** WPA2-P
- Last Seen:** 9:43:28 PM

On the right side of the card, there are two buttons: 'Locate' and 'Connect'. To the right of the 'Locate' button is a circular icon with a line graph. To the right of the 'Connect' button is a circular icon with a list and checkmark. Below the card, there are three more sections, each with a button and an icon:

- Rates and Capabilities:** Button labeled 'Capture (Wi-Fi)', icon shows a signal strength indicator and '01011 10%'.
- Clients:** Button labeled 'Name and Authorization', icon shows a shield with a checkmark.
- RF and Traffic Statistics:** Button with an 'X' icon, icon shows a line graph.

At the bottom of the 'RF and Traffic Statistics' section, it says 'CH: 48 (80 MHz, 36 - 48) Utilization: 0%'.

5. Tap **Locate**. This opens the Locate screen and causes your AirCheck G3 to "listen" for the BSSID or Client wireless devices you

want to find using either the internal antennas or the optional external antenna (sold separately or in kits).



ASUSTekC:d850e6-cc9c9c

Channel: 48 (80 MHz, 36 - 48)

Signal: -45 dBm

Signal (dBm)

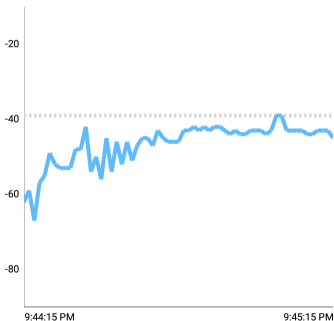

Last Seen: 9:45:15 PM



External Antenna



- The test unit can emit an audible tone that increases in rate and pitch as the signal strength of the device increases (as you get closer to it). Tap the speaker icon  to turn sound on or off. Use the volume slider by the speaker icon to turn the sound up or down. (If you have an external sound device attached, volume is controlled by the buttons on the side of your unit.)
- The **External Antenna** toggle enables the optional external antenna for BSSID or Client location.
 - In areas with many rooms, like a hospital or school, the internal antennas are more effective. See [Using the Internal Antennas to Locate](#) below.
 - In large, open areas, the external antenna can help locate devices more quickly. See [Using the Optional External Antenna](#) below.

Locating with the Internal Antennas

AirCheck G3 uses the internal antennas by default.

1. Navigate to the RF and Traffic Statistics screen for the BSSID (AP) or client you need to locate.
2. (Optional) Tap the speaker icon to toggle the audible tone on or off.

3. Divide the area you want to search into four sections.

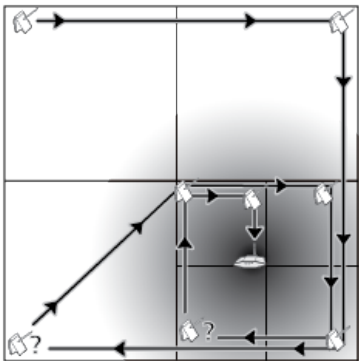

4. Go to one corner of your search area, and note the device's signal strength on the Signal graph.
5. Go to the other three corners of the area, and note the signal strength at each corner.
6. Go to the section with the strongest signal.

7. Repeat steps 3 through 6 until you find the device.

If you still cannot find the device, try looking on the floors above or below you. If you cannot find a client, try locating the AP to which the client is connected first.

Locating with the Directional External Antenna

In large, open areas, the directional external antenna can help determine the direction of a signal source more precisely than the internal antennas. Visit NetAlly.com for purchasing information.

1. If using the Directional Tri-band (2.4, 5, and 6 GHz) external antenna, screw the antenna's RP-SMA connector into the antenna port on the top of the AirCheck G3 (shown below). If using the Dual-band (2.4 and 5 GHz) Flag antenna, screw the external antenna cord into the antenna port.

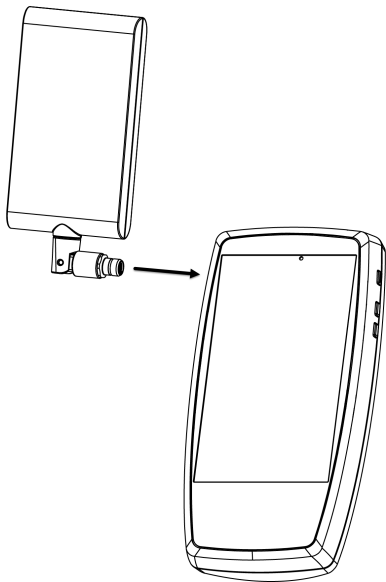

2. On the RF and Traffic Statistics screen, tap the **External Antenna** toggle to enable the external antenna.

- (Optional) Tap the speaker icon to toggle the audible tone on or off.
- Divide the area you want to search into four sections.

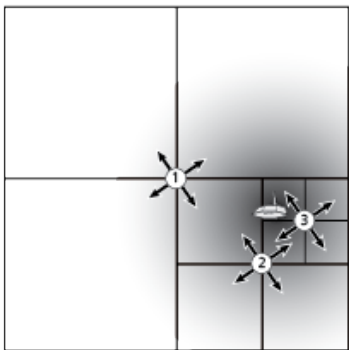

- Go to the center of your search area.
- For the Directional Tri-band external antenna, use the swivel joint on the RP-SMA connector to angle the antenna so that the "target" silkscreen on the antenna points toward your search area, as shown below.

Point the antenna towards each corner of the area. To get the best measurements, hold it at a constant height and above barriers such as cubicle walls.

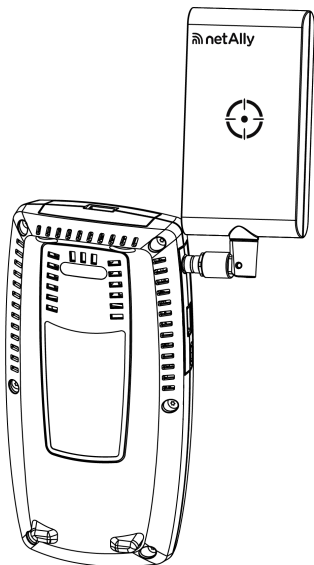

7. For the Dual-band Flag antenna, point the front edge of the antenna toward your search area, as shown below.



8. Go to the middle of the section with the strongest signal.
9. Repeat steps 4 through 7 until you find the device.

Assigning a Name and Authorization to a Device

The Wi-Fi and Discovery apps provide the option to assign a **Name and Authorization** to any discovered device with a MAC Address or BSSID.

Assigning a User Name and/or Authorization status does not change any of the information on the actual device, only how the device's

information displays on the AirCheck G3 on which the Name and Authorization are assigned.

You only need to assign a Name and/or Authorization to one BSSID or MAC address for a device with multiple addresses. Names and Authorizations are saved in the internal authname.txt file and remain set as the unit powers off and on.

This feature allows you to quickly identify your known devices and categorize them with the following statuses:

- **Authorized:** For devices approved for use on your network
- **Neighbor:** For devices owned and controlled by neighboring organizations
- **Flagged:** To give visibility to a specific device
- **Unknown:** For devices that have not been identified or classified
- **Unauthorized:** For devices that should not be on the network and may present a security risk

- **Unspecified:**Default unassigned Authorization status

While the Authorization statuses are designed with these intended meanings, you can use them however you like for your purposes.

Once set, the custom User Name is shown in other NetAlly apps wherever device information is displayed. The Authorization is displayed in the Discovery and Wi-Fi apps.

You can sort and filter by the assigned Authorization in the Wi-Fi and Discovery apps. When a list is sorted by Authorization (in normal sort order), the devices with Authorizations of highest concern appear at the top. The image below shows the BSSIDs list screen sorted this way:

Wi-Fi - BSSIDs (150)		
Filter	Sort	Authorization
	Ntgear:3c3786-719306	-33 dBm >
Unauthorized	Nighthawk 802.11ax 5GHz	CH: 36
	Cisco:b83861-84aaf0	-82 dBm >
Neighbor	Cisco WEP64 SA	CH: 36
	Cisco:b83861-84aaf0	-67 dBm >
Neighbor	CiscoQATest-mañana	CH: 1
	Cisco:78bc1a-0fd908	-64 dBm >
Authorized	[NGP-004]	CH: 36

Applying a Name and/or Authorization

Access the **Name and Authorization** function from the floating action menu  on a [Discovery Details screen](#) or a [Wi-Fi Details screen](#) for a [BSSID](#) or [Client](#).

NOTE: When applying an Authorization to a device with multiple BSSIDs or MAC addresses, the Authorization status is only applied to the MAC address/BSSID displayed on the Details screen, as shown in this section.

1. Tap the **FAB** on a Discovery or Wi-Fi Details screen for a device with a discovered MAC/BSSID.

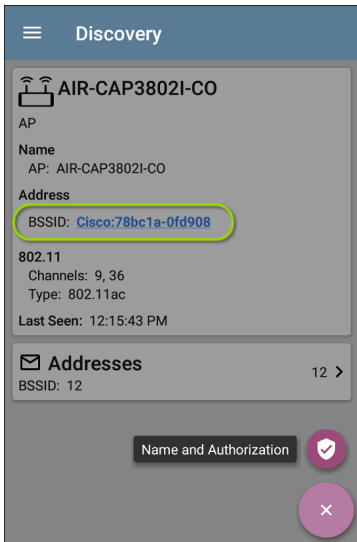

The example above shows an AP's Details screen in the Discovery app.

2. Select **Name and Authorization** to open the dialog.

Name and Authorization

MAC Address: Cisco:78bc1a-0fd908

User Name: Conference Room AP

Authorization

Authorized

Neighbor

Flagged

Unknown

Unauthorized

Unspecified

CANCEL OK

3. In the Name and Authorization dialog, tap the **User Name** field to enter a customized

name, if desired. In the image above, the user has entered the name "Conference Room AP."

NOTE: It is possible to *either* enter a user name or select an Authorization. You do not have to do both.

4. Select the radio button to assign an **Authorization** status as needed.
5. Tap **OK** to apply.

Once applied, the User Name and Authorization are displayed on the Discovery Details screen.

The screenshot shows the 'Discovery' screen of the Wi-Fi Analysis App. At the top, there is a blue header with a hamburger menu icon and the word 'Discovery'. Below the header, there is a card for a discovered AP. The card has a title 'Conference Room AP' with a Wi-Fi icon. Underneath the title, it says 'AP'. The 'Name' section contains two lines of text: 'User: Conference Room AP' and 'AP: AIR-CAP3802I-CO', both of which are circled in green. The 'Address' section contains two lines: 'BSSID: Cisco:78bc1a-0fd908' (where the BSSID is a blue link) and 'Authorization: Authorized', also circled in green. Below the address section, it shows '802.11', 'Channels: 9, 36', 'Type: 802.11ac', and 'Last Seen: 12:17:22 PM'. At the bottom of the card, there is a section titled 'Addresses' with an envelope icon, showing 'BSSID: 12' and a right-pointing arrow with the number '12' next to it.

☰ Discovery

 **Conference Room AP**

AP

Name

User: Conference Room AP
AP: AIR-CAP3802I-CO

Address

BSSID: [Cisco:78bc1a-0fd908](#)
Authorization: Authorized

802.11
Channels: 9, 36
Type: 802.11ac
Last Seen: 12:17:22 PM

 **Addresses** 12 >

BSSID: 12

The user-assigned name for the AP and Authorization for the BSSID also appear on the Wi-Fi BSSID Details screen, as shown below.

 **Wi-Fi - BSSID**

 **Cisco:78bc1a-0fd908**
BSSID

SSID: **AmNaCa**

AP: Conference Room AP
BSSID: 78bc1a-0fd908
Authorization: Authorized

802.11

Channel: **9**

Types: n, g, b

Signal: -60 dBm

SNR: 33 dB

Security Type: WPA2-P

Last Seen: 2:30:38 PM

 **Rates and Capabilities** >

 **Clients** 0 >

 **RF and Traffic Statistics** >







NOTE: If different Authorization statuses are assigned for different BSSIDs or MAC addresses on the same device, the Authorization of highest concern appears on the device's Details screens.

Changing or Clearing a User Name or Authorization

Open the Name and Authorization dialog again *for the same BSSID or MAC address* on a device to reassign or clear the assigned User Name or Authorization. If the Name or Authorization do not update as expected after a few minutes, you may have assigned them to multiple addresses for the same device.

To view all assigned Authorizations for a device, open the Discovery or Wi-Fi Details screen for the device and view the Addresses or BSSIDs screen. Then, sort by Authorization.

Addresses (14)	
Authorization	
 Cisco:b83861-84aaf3 Flagged	CH: 36 > Cisco WEP128 OA
 Cisco:b83861-84aaf1 Neighbor	CH: 1 > Cisco WEP64 OA
 Cisco:b83861-84aafc Authorized	CH: 1 > Cisco WEP128 OA
 Cisco:b83861-84aaf0 Neighbor	CH: 1 > Cisco WEP64 OA

To reset a device's User Name and/or Authorization to the unassigned defaults, open the Name and Authorization dialog, clear the User Name field and leave it blank, and select the **Unspecified** Authorization. Then, tap OK.

Revising or Importing authname.txt

Custom Names and Authorizations are stored in the **authname.txt** file in the AirCheck G3's internal storage **.settings** folder, accessible from the [Files](#) app.

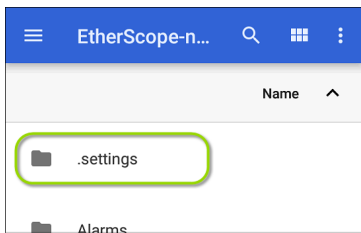

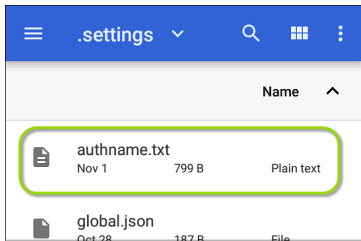

NOTE: In the Files app, you may need to tap the action overflow icon  at the top right and select **Show Internal Storage** to navigate to the **EtherScope-nXG** folder and sub-folders.

If desired, you can manually edit this file on the AirCheck G3 unit, or you can create a new authname.txt file on a PC and import it onto your unit in the same file location.

The default authname.txt file on your unit contains instructions on how to format your Name and Authorization entries.

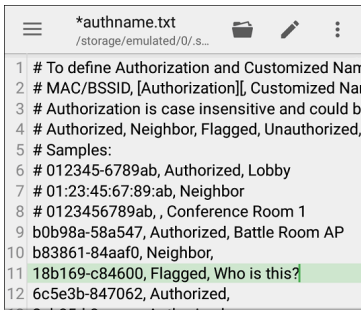

```

1 # To define Authorization and Customized Name
2 # MAC/BSSID, [Authorization][, Customized Name]
3 # Authorization is case insensitive and could be
4 # Authorized, Neighbor, Flagged, Unauthorized,
5 # Samples:
6 # 012345-6789ab, Authorized, Lobby
7 # 01:23:45:67:89:ab, Neighbor
8 # 0123456789ab, , Conference Room 1
9 b0b98a-58a547, Authorized, Battle Room AP
10 b83861-84aaf0, Neighbor,
11 18b169-c84600, Flagged, Who is this?
12 6c5e3b-847062, Authorized,

```



 Who is this?	-38 dBm >
Flagged	Sonicw

To edit the authname.txt file on the AirCheck G3, third-party apps, such QuickEdit Text Editor, are available from the NetAlly [App Store](#)  .

For help importing a file, see the [Managing Files](#) topic.

NOTE: After importing and overriding the authname.txt file, NetAlly recommends [Refreshing Discovery](#) in the Discovery app or restarting your unit.

Channels Map

The Channels Map screens provide charts of channel utilization with AP coverage and overlap. Swipe right or left or tap the tab names to switch between the chart types: **Map**, **Map 6E**, or **Overlap**.



Map and Map 6E Tabs

The Map and Map 6E tabs display a bar graph of 802.11 and non-802.11 utilization, retry percentage, APs for each channel, clients for each channel, and illegal channels. (The Map 6E tab is for 6 GHz channels only.)

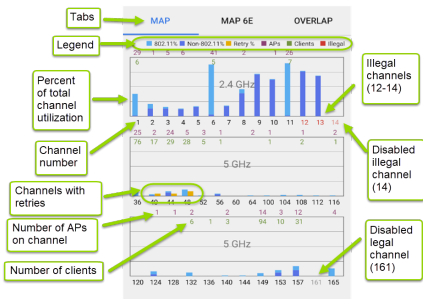

- The blue vertical bars show the percentage of each channel's capacity used by 802.11 devices (light blue) and non-802.11 interference (dark blue).
- Yellow bars next to the blue bars show the percentage of retries. In the example above,

Channels 1 and 3 show a small percentage of retries.

- Channel numbers are listed on the x-axis and utilization percentage on the y-axis.
- Illegal channel numbers—channels that are not legal for the country that your unit is set to operate in—are shown in bright red. In the example above, Channels 12, 13, and 14 are illegal.
- Disabled legal channels are shown in light gray. In the example above Channel 161 is disabled.
- Disabled illegal channels are shown in light red. In the example above Channel 14 is an illegal channel and disabled.
- AP counts for the APs' primary channel are shown in dark red at the top of the column for each channel. In the example below, Channel 161 has 7 APs. (Channels that do not have APs can still show 802.11 utilization because of overlap from adjacent channels.)

- Client counts for the channel are shown in green near the top of the column for each channel. In the example below, Channel 161 has 15 clients.
- Tap a Channel's column on the Map or Map 6E graph to select and highlight the channel. This displays the CHANNEL DETAILS and SPECTRUM links at the bottom of the screen. In the example below, Channel 161 is highlighted.

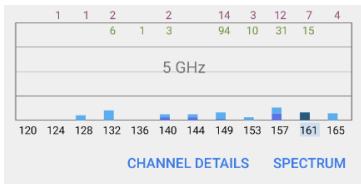



The [Channel Details](#) screen lets you examine the addresses and devices operating on the channel and perform a deeper analysis.

The [Spectrum](#) link opens the Spectrum app, a Wi-Fi spectrum analyzer that provides data about signal strength and noise.

Overlap Tab

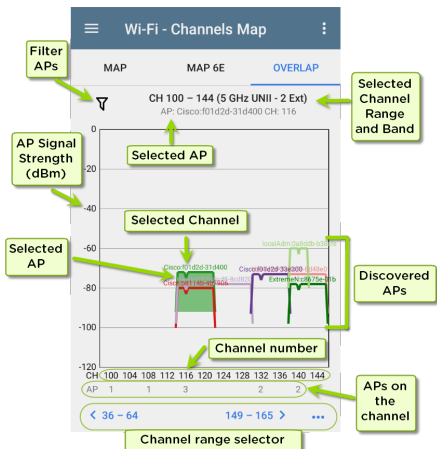
Tap **Overlap** to view access point channel, coverage, and overlap. This can help you spot potential coverage issues. Each discovered AP is shown as a colored bracket on a graph based on channel coverage (on the x-axis) and signal strength in dBm (on the y-axis).



- Tap the Filter icon  near the top left to open the Overlap Filters screen to control what APs are displayed. You can select filters for channels, SSIDs, Signal, SNR, 802.11 type, or Security.
- Tap an AP on the graph to select it and its primary channel. This highlights the area covered by the channel and lists the channel information above the graph. In the image below, the AP named "Cisco:b8114b-4b7906" on channel 132 is selected.

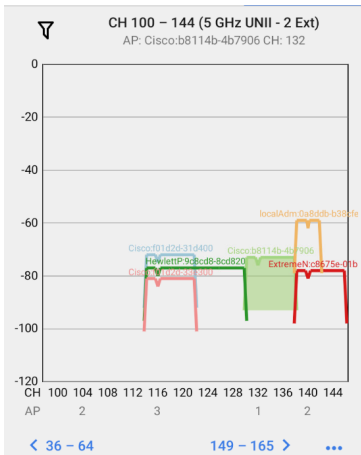

- Double-tap the graph to zoom in or use "pinch" gestures with your thumb and forefinger. Tap the Restore icon (🔄) or reverse the pinch gesture to return to the full graph. The image below shows a zoomed-in view with the AP named "Cisco:f01d2d-33e300" on channel 116 selected.

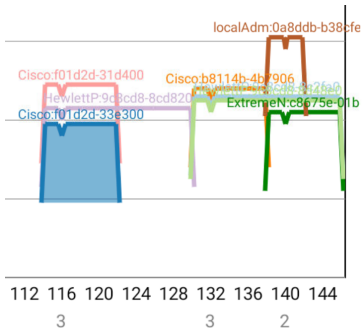

- Tap the **blue channel** selectors at the bottom to view a different Wi-Fi band (2.4, 5 and 6 GHz) and channel range on the graph.
- Tap the action overflow button **•••** to open the **AP Details** or **Channel Details** screens for the selected AP or Channel or to open the **Spectrum Test App**.

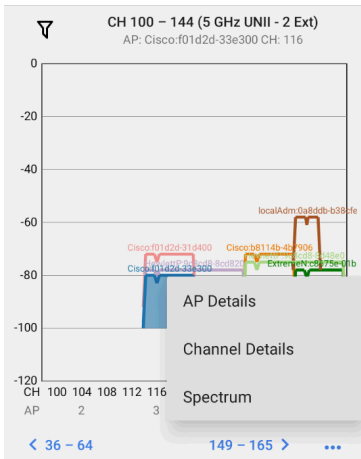



See [Filtering in the Wi-Fi App](#) for an explanation of the Overlap screen's filtering options.

Channels

The Channels list screen displays the characteristics of the wireless Channels as they are scanned in your location.

Wi-Fi - Channels (43)			
Filter	Sort	Channel	
	Channel 1	APs: 11	>
Channel 1	2.412 GHz	Util: 32 %	
	Channel 2	APs: 0	>
Channel 2	2.417 GHz	Util: 20 %	
	Channel 3	APs: 0	>
Channel 3	2.422 GHz	Util: 0 %	
	Channel 4	APs: 0	>
Channel 4	2.427 GHz	Util: 7 %	
	Channel 5	APs: 1	>
Channel 5	2.432 GHz	Util: 37 %	
	Channel 6	APs: 11	>
Channel 6	2.437 GHz	Util: 53 %	
	Channel 7	APs: 0	>
Channel 7	2.442 GHz	Util: 24 %	

You can [Filter](#)  and [Sort](#)  the list to determine which Channels are shown and their order. Refer to the [Wi-Fi App List Screens](#) topic if needed.

By default, Channels are ordered by channel number, and each card shows the channel frequency, number of APs, and total Utilization percent.

Tap a Channel card to open the Channel Details screen.

Channel Details

 **Wi-Fi - Channel**

 **Channel 1**
2.412 GHz
Channel: 1
Center Frequency: 2.412 GHz
Frequency Range: 2.402 - 2.422 GHz
Width: 20 MHz
Band: 2.4 GHz

 **Problems** 1 >
Warnings: 1

 **SSIDs** 24 >
[Hidden], Battle Mountain Crestron, CiscoE42...

 **APs** 17 >
10.250.2.101, 10.250.3.9, Cisco-Li:20aa4b-0f...

 **BSSIDs** 46 >
18b169-8e7456, 18b169-8e7457, 18b169-c7...

 **Clients**



The Channel Details screen displays the channel's Center Frequency under the icon,

along with the Frequency Range, Width, and Band.

Dynamic Frequency Selection (DFS) channels also display an Attributes field that indicates DFS.

Channel RF and Traffic Statistics

The RF and Traffic Statistics card appears when there is an active AP and Utilization on the channel. See [RF and Traffic Statistics Overview](#) in the Wi-Fi Details Screens topic.

Channel FAB

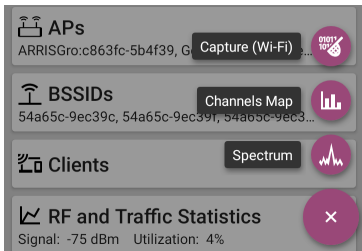

















Tap the [FAB](#) on the Channel Details screen to:

- Open the [Capture](#) app to record a packet capture on the channel.
- Open the [Channels Map](#) screen with the current channel selected.
- Open the [Spectrum](#) app to view signal measurements for the channel.

SSIDs



The SSIDs list screen shows all the network SSIDs the AirCheck G3 has discovered.

Wi-Fi - SSIDs (89)		
Filter	Sort	Signal
 Cisco WEP64 OA		-61 dBm > APs: 1
-61 dBm		
 HNTNetgear2.4G		-61 dBm > APs: 1
-61 dBm		
 Cisco 5G		-62 dBm > APs: 2
-62 dBm		
 CiscoQATest-mañana		-62 dBm > APs: 1
-62 dBm		
 Cisco WEP128 OA		-62 dBm > APs: 1
-62 dBm		
 Cisco WEP128 SA		-62 dBm > APs: 1
-62 dBm		
 Home-Guest-2.4G		-62 dBm > APs: 1
-62 dBm		

You can **Filter**  and **Sort**  the list to determine which SSIDs are shown and their order. Refer to the [Wi-Fi App List Screens](#) topic if needed.

By default, SSIDs are ordered by Signal strength, and each card shows the network security status and number of APs on the network.

The security status icons have the following meanings:

-  **Green closed lock:** All APs on the network use secure protocols, like WPA2 or WPA3.
-  **Yellow closed lock:** One or more APs use WEP or Cisco LEAP protocols, which are less secure.
-  **Red open lock:** The network does not have security enabled.

Tap a SSID card to open the SSID Details screen.

SSID Details

 **Wi-Fi - SSID**

 **LRG**
Broadcast SSID
SSID: LRG
Types: ac, n, g, a, b
Security Type: WPA2-P
Strongest AP: [Sonicwal:18b169-c84602](#)
Signal: -35 dBm
Last Seen: 3:10:00 PM

 **APs** 13 >
Sonicwal:18b169-8e7456, Sonicwal:18b169-...

 **BSSIDs** 22 >
18b169-8e744f, 18b169-8e7457, 18b169-c7f...

 **Channels** 9 >
1, 6, 11, 36, 40, 44, 149, 157, 161

 **Clients** 19 >



In addition to the Signal and Security Type, the SSID Details displays the AP on the network with the strongest signal, 802.11 Types that the APs in

the network support, and the time the AirCheck G3 last detected activity on the network (Last Seen).

AirCheck G3 can detect and display 802.11 types a/b/g/n/ac/ax.

SSID FAB

Tap the **FAB** on the SSID Details screen to **Connect** to the network.

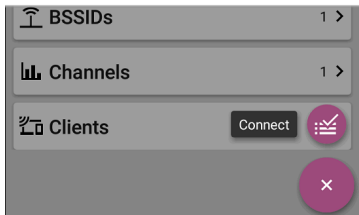



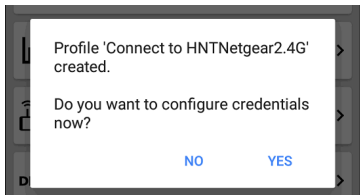



This action opens the **AutoTest** app and creates a new **Wi-Fi profile** called "Connect to [SSID]."





See [Creating a Wi-Fi Profile from the Wi-Fi Analysis App](#) in the AutoTest chapter for a more detailed description of this process.

APs

The APs list screen displays all the Access Points discovered operating on your wireless networks.

Wi-Fi - APs (54)		
Filter	Sort	Signal
	Ntgear:3c3786-719307	-26 dBm > Ntgear
	3e3786-719300	-29 dBm > --
	Lnksys:c8b373-05ac3c	-39 dBm > Lnksys
	Aerohv:348584-064b64	-40 dBm > Aerohv
	J125:002091-554431	-46 dBm > J125
	Lnksys:c8d719-a51bcb	-48 dBm > Lnksys
	Cisco3702 Kris A	-50 dBm

You can **Filter**  and **Sort**  the list to determine which APs are shown and their order.

Refer to the [Wi-Fi App List Screens](#) topic if needed.

By default, APs are ordered by Signal strength, and each card shows the Signal strength in dBm and the AP's manufacturer prefix.

Tap an individual AP's card to open the AP Details screen.

AP Details

☰ Wi-Fi - AP

 **Ntgear:3c3786-719307**

AP

AP: [Ntgear:3c3786-719307](#)

Mfg Prefix: Ntgear

802.11

Types: ax, ac, n, g, a, b

Security Type: WPA2-P

Signal: -28 dBm

Last Seen: 4:09:05 PM

 **Problems** 2 >

Warnings: 2

 **SSIDs** 2 >

Nighthawk 802.11 ax 2.4GHz, Nighthawk 802.1...

 **BSSIDs** 2 >

3c3786-719306, 3c3786-719307

 **Channels** 2 >

6, 36 (80 MHz, 36 - 48)

The AP Details screen shows the 802.11 Types the AP supports, the AP's Security Type, and the







time the AP was last detected (Last Seen) by the AirCheck G3.



Tap the lower cards to view the network IDs, Channels, and Clients associated with the AP.

See [Wi-Fi Problems](#) for more information about the Problems card.

BSSIDs

The BSSIDs list screen shows the BSSID addresses discovered in your wireless environment.

Wi-Fi - BSSIDs (121)		
Signal		
 3e3786-719300 -27 dBm	Nighthawk-Guest ...	-27 dBm CH: 6
 Ntgear:3c3786-719307 -28 dBm	Nighthawk 802.1...	-28 dBm CH: 6
 Ntgear:3c3786-719306 -37 dBm	Nighthawk 802.1...	-37 dBm CH: 36
 Aerohv:348584-064b64 -39 dBm	HNT 802.11ax	-39 dBm CH: 157
 Lnksys:c8b373-05ac3b -42 dBm	The Office Netwo...	-42 dBm CH: 1
 Lnksys:c8d719-a51bcb -48 dBm	Linksys15538	-48 dBm CH: 1
 1125-002091-554431 -49 dBm		-49 dBm

You can [Filter](#)  and [Sort](#)  the list to determine which BSSIDs are shown and their order. Refer to the [Wi-Fi App List Screens](#) topic if needed.

By default, BSSIDs are ordered by signal strength, and each card shows the signal strength, SSID, and channel number on which the BSSID operates. The icons indicate different types of BSSID:



Single, transmitted



Reduced neighbor report, transmitted



Reduced neighbor report, non-transmitted



Multiple, transmitted (6 GHz)





Multiple, non-transmitted (6 GHz)

Colors show the BSSID's status: black indicates normal status, **yellow** indicates a warning-level problem, and **red** indicates an error-level problem.

Tap a BSSID's card to open the Details screen.

BSSID Details

 **Wi-Fi - BSSID**

 **Cisco:f01d2d-31d403**
BSSID

SSID: **cos-ngp-eap-fast**

AP: **Cisco:f01d2d-31d406**
BSSID: f01d2d-31d403

802.11
Channel: **1**

Types: ax, n, g, b
Signal: -68 dBm
SNR: 22 dB
Security Type: WPA2-E
QBSS Station Count: 0
QBSS Channel Utilization: 71%

Last Seen: 7:58:16 PM

 **Rates and Capabilities** >

 **Clients**



In addition to the characteristics on the BSSID cards, the Details screen displays the following information:

- User-assigned [Authorization status](#) (if set)
- Supported **802.11 Types**
- Signal-to-Noise ratio (**SNR**) measurement
- Network **Security** type
- QBSS station count and channel utilization
- Time activity was **Last Seen** on the BSSID

BSSID Details also includes cards that link to Rates and Capabilities details, the Wi-Fi [Clients](#) list, and [BSSID RF and Traffic Statistics](#) details.

Rates and Capabilities

Tap the Rates and Capabilities card to open the full screen.



Rates and Capabilities



ASUSTek:7c10c9-7e2e44

BSSID

Rates (Mbps)

Supported: 6, 9, 12, 18, 24, 36, 48, 54

Basic: 6, 12, 24

Country Code: US

802.11n Capabilities

SGI 20 MHz: true

SGI 40 MHz: true

Max AMPDU: 65535 bytes

	Tx	Rx
Max Rate	300 Mbps	300 Mbps
Max Streams	2	2
Max MCS	15	15

802.11ac Capabilities

SGI 80 MHz: true

SGI 160 MHz: false

Max AMPDU: 1048575 bytes

MU Beamformer: true

	Tx	Rx
Max Rate	866 Mbps	866 Mbps
Max Streams	2	2

This screen shows advanced information about the transmit and receive rates and 802.11 capabilities reported by the beacon.

Rates (Mbps)

Supported: The extended physical (PHY) rates that the AP is configured to support

Basic: The basic physical (PHY) rates that the AP is configured to support

Country Code

The 802.11d country code as detected for the country in which you use your device.

802.11 Capabilities

- 802.11n capabilities are gathered from HT capabilities in the beacon.
- 802.11ac capabilities are gathered from VHT capabilities in the beacon.
- 802.11ax capabilities are gathered from HE capabilities in the beacon.

802.11ax Rates and Capabilities

AirCheck G3 can also report Advanced 802.11ax (Wi-Fi 6) capabilities it sees in the beacon.



Rates and Capabilities

802.11ax Capabilities

Max AMPDU: 4194303 bytes

SU Beamformer: true

SU Beamformee: true

MU Beamformer: false

	Tx	Rx
Max Rate	573 Mbps	573 Mbps
Max Streams	4	4
Max MCS	11	11

Advanced 802.11ax Capabilities

+HTC HE Support: true

TWT Requester Support: false

TWT Responder Support: false

Fragmentation Support: 1

Maximum Number Of Fragmented MSDUs/A-MSDUs

Exponent: 0

Minimum Fragment Size: None

HE Link Adaptation Support: 0

All ACK Support: false

BSR Support: false

Broadcast TWT Support: false

32-bit BA Bitmap Support: false

MU Cascading Support: false

Ack-Enabled Aggregation Support: false

DM Control Support: false

Clients

Tap the **Clients** card to open the Wi-Fi Clients list screen.

BSSID RF and Traffic Statistics

Tap the **RF and Traffic Statistics** card to open the RF and Traffic Statistics screen. This screen displays the BSSID and channel number at the top of the screen as well as informational graphs.

To pan and zoom on the graphs, you can swipe, double tap, and move the slider under each graph. Tap the Restore icon  to return to the full graph. (See the [Trending Graphs](#) topic for an overview of the graph controls.)

See [RF and Traffic Statistics Overview](#) in the Wi-Fi Details Screens topic for an explanation of the common elements of this screen.

The Signal graph shows the signal in light blue, noise in dark blue, and a calculated SNR.

The Channel Utilization graph uses light blue to show 802.11 channel utilization and dark blue to show non-802.11 utilization:



RF and Traffic Statistics



D-LinkIn:802689-4cc98a

Channel: 153 (80 MHz, 149 - 161)

Signal (dBm)



	Cur	Min	Max	Avg
Signal (dBm)	-43	-44	-37	-38
Noise (dBm)	-95	-95	-92	-94
SNR (dB)	52			55

Channel Utilization (%)

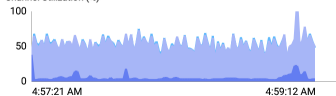

	Cur	Min	Max	Avg
CH 802.11	48	24	100	53
BSSID 802.11	46	<1	94	48

The screen also displays separate graphs for BSSID Retries and Channel Retries:

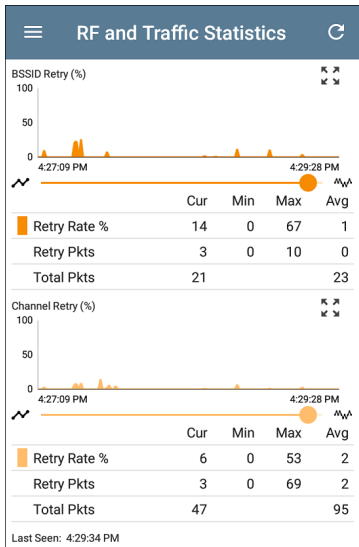

BSSID FAB

The floating action button on the BSSID screen lets you **Locate** the wireless device, **Connect** to the BSSID, record a packet Capture of the

network traffic with the current BSSID on the connected channel, and assign or change its **Name and Authorization**.

☰
Wi-Fi - BSSID



ASUSTekC:d850e6-cc9c9c

BSSID

SSID: [wisornet-wpa2psk](#)

AP: [router.asus.com](#)

BSSID: d850e6-cc9c9c

802.11

Channel: **48 (80 MHz, 36 - 48)**

Types: ac, n, a

Signal: -46 dBm

SNR: 43 dB

Security Type: WPA2-P

Last Seen: 9:43:28 PM

Locate



Connect



↕

Rates and Capabilities

Capture (Wi-Fi)



👤

Clients

Name and Authorization



📊

RF and Traffic Statistics





CH: 48 (80 MHz, 36 - 48) Utilization: 0%

- Selecting **Locate** opens the Locate BSSID screen. See [Locating Wi-Fi Devices](#).
- Tapping **Connect** opens the [AutoTest](#) app and creates a new [Wi-Fi profile](#) called "Connect to [BSSID]." See [Creating a Wi-Fi Profile from the Wi-Fi Analysis App](#) in the AutoTest chapter for a more detailed description of this process.
- Selecting **Capture** opens the Capture app populated with the Channel and BSSID. See the [Capture app](#) chapter.
- Selecting **Name and Authorization** opens the Name and Authorization dialog. See [Assigning a Name and Authorization to a Device](#).



Clients

The Clients list screen displays the wireless clients the AirCheck G3 has discovered connected to your wireless networks.

Wi-Fi - Clients (61)		
Filter	Sort	Signal
	192.168.0.105	-34 dBm >
-34 dBm	LiftingRound	CH: 153
	ARRISGro:189c27-59da36	-50 dBm >
-50 dBm	RuleGViolation	CH: 157
	Sonos:48a6b8-a730a3	-62 dBm >
-62 dBm	--	CH: 6
	Sonos:48a6b8-a730a3	-62 dBm >
-62 dBm	--	CH: 6
	localAdmin:6632b1-3eb...	-68 dBm >
-68 dBm	--	CH: 153
	fe80::f28a:76ff:fe6c:82d0	-70 dBm >
-70 dBm	Fragblast	CH: 8
	Sonos:48a6b8-a72f15	-71 dBm >

You can [Filter](#)  and [Sort](#)  the list to determine which Clients are shown and their order. Refer to the [Wi-Fi App List Screens](#) topic if needed.

By default, the Clients are ordered by Signal strength, and each card shows the client's Signal strength in dBm, the SSID of the network to which the client is connected, and the channel number on which the Client is operating.

The general Client icons indicate whether the device is Probing  or Connected  to a network and able to receive data. If a Client is probing, two dashes -- display where the SSID would appear.

The Clients screen also shows specific icons for NetAlly testers, like the AirCheck G3 icon  shown in the image above.

Tap a Client's card to open the Details screen.

Client Details

 **Wi-Fi - Client**

 **10.24.8.111**
Wi-Fi Client



Address
IP: 10.24.8.111
MAC: [localAdm:d65834-911230](#)

802.11
Channel: [157 \(40 MHz, 157 - 161\)](#)
Types: ac, n, a
Signal: -47 dBm
SNR: 42 dB

AP: [10.24.8.36](#)

SSID: [LRG](#)

BSSID: [Sonicwal:18b169-c8decf](#)
Security Type: WPA2-P
Last Seen: 9:29:39 PM

 **RF and Traffic Statistics**
Channel Utilization: 7% 

The top Client Details card for a connected Client displays the following information:

- Client's **IP** and **MAC** addresses.
- User-assigned **Authorization status** (if set)
- Supported **802.11** media **Types**
- Signal-to-Noise ratio (**SNR**) measurement
- Name of the **AP** to which the Client is connected
- **SSID** of the network to which the Client is connected
- **BSSID** on which the Client is operating
- Network **Security** type
- Time the Client was **Last Seen** by the AirCheck G3

Probing Clients

If the client is a Wi-Fi probing client, the details screen replaces AP details with a list of the SSIDs for which the client is probing in the **Probes For** field:

 UGSI:6c0b84-c1f09f

Wi-Fi Probing Client

AddressMAC: [UGSI:6c0b84-c1f09f](#)

802.11

Channel: 6

Types: g, b

Signal: -45 dBm

SNR: 50 dB

Last Seen: 11:03:02 AM

Probes For: _OpenWrt_5G, Nighthawk 802.11ax
5GHz, NETGEAR17-5G

Client RF and Traffic Statistics

Tap the **RF and Traffic Statistics** card to open the RF and Traffic Statistics screen. This screen displays the client's ID or address and channel number at the top of the screen as well as informational graphs.

To pan and zoom on the graphs, you can swipe, double tap, and move the slider under each graph. Tap the Restore icon  to return to the full graph. (See the [Trending Graphs](#) topic for an overview of the graph controls.)

See [RF and Traffic Statistics Overview](#) in the Wi-Fi Details Screens topic for an explanation of the common elements of this screen.

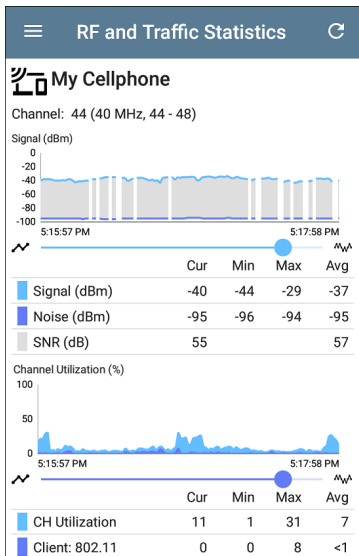

The Signal graph shows the signal in light blue, noise in dark blue, and a calculated SNR.

The Channel Utilization graph uses light blue to show 802.11 channel utilization and dark blue to show non-802.11 utilization:

Breaks in the Client RF and Traffic graphs may occur if the Client is not consistently transmitting, so there is no data for AirCheck G3 to display during those times.

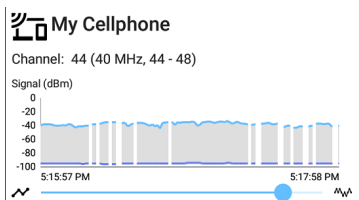

The Clients RF and Traffic Statistics screen also displays a graph of Transmit (Tx) and Receive (Rx) Rates in Mbps, number of Tx Streams, and Tx Channel Width in MHz.

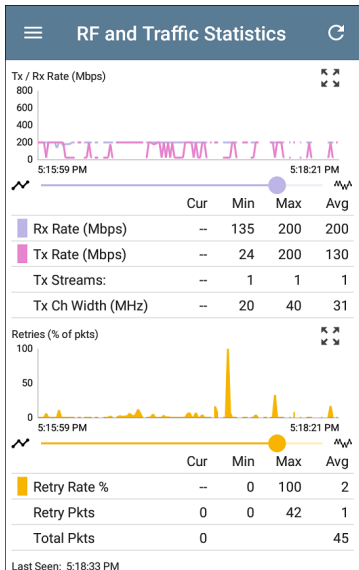

Clients FAB

Tap the **FAB** on the Client Details screen to **Locate** the client device, to open the **Capture** app to record a packet capture of traffic going to

and from the client, or to assign or change its **Name and Authorization**.

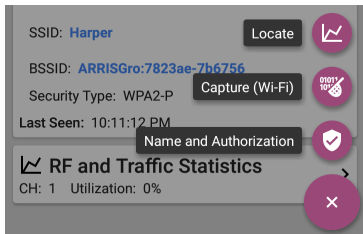

- Select **Locate** to open the Locate Client screen. See [Locating Wi-Fi Devices](#).
- Select **Capture** to open the Capture app populated with the Channel and MAC address of the client. See the [Capture app](#) chapter.
- Select **Name and Authorization** to open the Name and Authorization dialog. See [Assigning a Name and Authorization to a Device](#).



Path Analysis App

Path Analysis traces the connection points, including intermediate routers and switches, between the AirCheck G3 and a destination URL or IP address. You can use Path Analysis to identify issues such as overloaded interfaces, overloaded device resources, and interface errors. It also shows how devices within your network (and off-net devices) are connected to each other along a path.

All switches are pre-discovered through SNMP queries. When the measurement is complete, AirCheck G3 shows the number of hops to the destination device. A maximum of 30 hops can be reported.

Introduction to Path Analysis

Path Analysis combines Layer 3 and Layer 2 measurements.

The Layer 3 measurement combines the classic Layer 3 IP (UDP, ICMP, or TCP) traceroute measurement with a view of the path through the Layer 2 switches.

The Layer 2 measurement discovers switches between the router hops by looking for the routers' MAC addresses in the switch forwarding tables by sending SNMP queries to all discovered switches. The switches found in the path are displayed between the router hops when the measurement finishes.

Path Analysis is most effective when you have configured the Discovery app with SNMP credentials. See [SNMP Configuration](#) in the [Discovery Settings](#) topic to learn how.

Path Analysis Settings

The Path Analysis source device is always your AirCheck G3. The default destination is [www.-google.com](http://www.google.com).

Populating Path Analysis from Another App

Like other AirCheck G3 testing apps, when you open Path Analysis from another app, like [Discovery](#), the address of the network component you were viewing in the previous app is pre-populated as the Path Analysis Destination.

Configuring Path Analysis Manually

Open the app settings to configure a custom destination and select an Interface and Protocol. To open, from the Path Analysis app screen, tap the settings  icon, or open the left-side navigation drawer and select **Path Analysis Settings**.

Path Analysis Settings	
Device Name	10.250.2.166
Interface	Any Port
Protocol	Connect (TCP)
TCP Port	80 (www-http)

On the Path Analysis Settings screen, tap each field as needed to configure your target:

Device Name: Tap to enter the IP address or DNS name of the Path destination. The default is www.google.com.

Interface: This setting determines the AirCheck G3 port from which the port scan runs. Tap the field to select a port. (See [Selecting Ports](#) for explanations of the different ports.)

AirCheck G3 must have an active network link on the selected port to run a Path Analysis. If **Any**

Port is selected, available links are used in the order shown in the Interface dialog above.

See [Test and Management Ports](#) for explanations of the different ports and how to link.



Protocol: Tap to select the Connect (TCP), Ping (ICMP), or Echo (UDP/7) protocol for your Path Analysis.

TCP Port: This field only appears if you have selected the Connect (TCP) Protocol. Tap to enter the port number over which you want to run Path Analysis. (You may need to enter a specific port number because routes can vary based on the port number and/or may be blocked by firewalls.)

Running Path Analysis

Tap the **START** button at the top of the app screen to begin a Path Analysis.

NOTE: AirCheck G3 must be linked on the Interface (Port) selected in the app's settings. See [Test and Management Ports](#) for help.

 **Path Analysis** START 

 **www.google.com** 1
36 ms, 29 ms, 27 ms

Device Name: www.google.com

IP Address: 142.250.69.228

Interface: Any Port

Protocol: Connect (TCP)

TCP Port: 80 (www-http)

Results

Started: 11:40:46 AM

Status: Destination reached in 7 hops

[UPLOAD TO LINK-LIVE](#)

 **ACK-G3C - 5500C8** >

Out: Wi-Fi Management Port

SSID: ASUS_5G_Guest CH: 157 -

 **Layer 2 Path**

Stopped by user

 **COS-DEV-SW1.NetAlly.com** >

Like AutoTest, Path Analysis results are presented on cards. The top card shows the main test details, the second card shows information for the source device (your AirCheck

G3), and the following cards show the Layer 2 and Layer 3 Hops in the path, which are sequentially ordered.

Tap any [blue linked name or address](#) in the Path Analysis results screens to open the [Discovery](#) app and further examine the linked element.

Path Analysis Results and Source AirCheck G3 Cards

 **google.com**
10 ms, 6 ms, 11 ms
Device Name: [google.com](#)
IP Address: 172.217.1.206
Interface: Any Port
Protocol: Connect (TCP)
TCP Port: 80 (www-http)
Results
Started: 2:26:58 PM
Status: Destination reached in 11 hops
[UPLOAD TO LINK-LIVE](#)

The top Path Analysis results card shows the path's Destination address at the top, followed

by the three response times from the TCP Connect, Ping, or Echo tests.

Device Name: Resolved DNS name or IP address of the destination entered in the settings

IP Address: IPv4 address of the target destination

Interface: The Interface option selected in the settings

Protocol: The Protocol selected in the settings (TCP, Ping, or Echo)

TCP Port: The port number used for a TCP Connect Protocol. This field does not appear for Ping or Echo Protocol results.

Results

Started: Time at which the Path Analysis began

Status: Current status of the Path Analysis test, including any error messages

UPLOAD TO LINK-LIVE: Tap this link to upload your results to a Link-Live account. See [Uploading Path Analysis Results to Link-Live](#) later in this topic.

Source AirCheck G3 Card

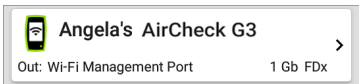

This AirCheck G3 card displays the port from which the Path Analysis ran.

- For Wi-Fi port analyses, the card displays the SSID and channel number.
NOTE: This card and screen only display a custom name for your AirCheck G3 if you have [claimed it to Link-Live](#).

Tap the card to view more details.

☰
Path Analysis

ThisEtherScope

Device Name: [ThisEtherScope](#)

IP Address: 192.65.49.14

 Out: Wi-Fi Port

 SSID: [NSVisitor](#)

BSSID: [Cisco:0c2724-f8f0b3](#)

Channel: [52](#)

Protocol: 802.11n

Security: WPA2-P

The example image above shows the SSID, Channel, and other Wi-Fi information the AirCheck G3 can display after running a Path Analysis over Wi-Fi.

Layer 3 Hops

Each Layer 3 Hop card displays the device type icon, DNS name (if discovered), and IP address.





192.168.249.81
8 ms, 4 ms, 3 ms

Hop: 2 >

Beneath the name (or IP), the response times for each Connect (TCP), Ping (ICMP), or Echo (UDP/7) display in milliseconds. On the right side is the router Hop number of this device in the path.

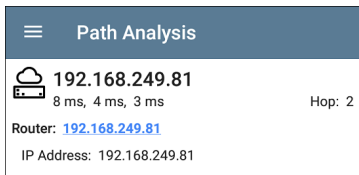
Tap the card to view the hop Details screen.

 **Path Analysis**









 **192.168.249.81**
8 ms, 4 ms, 3 ms Hop: 2

Router: [192.168.249.81](#)

IP Address: 192.168.249.81

No Reply

Sometimes Path Analysis displays Hop cards with "No Reply" (as shown below). This result means that the device in that portion of the path did not send an ICMP TTL timeout response.

Path Analysis		START	⚙️
	No Reply -, -, -	Hop: 5	>
	4.34.62.118 23 ms, 22 ms, 18 ms	Hop: 6	>
	ae-6.pat1.nez.yahoo.com 47 ms, 40 ms, 46 ms	Hop: 7	>
	Split Route 41 ms, 25 ms, 34 ms	Hop: 8	>
	Split Route 38 ms, 45 ms, 31 ms	Hop: 9	>
	Split Route 48 ms, 28 ms, 47 ms	Hop: 10	>
	slb8-1-flk.ne1.yahoo.com 39 ms, 41 ms, 38 ms	Hop: 11	>
	www.yahoo.com 35 ms, 61 ms, 46 ms	Hop: 12	>

Split Route

Path Analyses may obtain a "Split Route" result (as shown above), meaning that two or three

different routers within same hop responded to the three requests.

Tap a Split Route card to view the DNS names and IP addresses of the responding routers.

☰
Path Analysis



Split Route

41 ms, 25 ms, 34 ms Hop: 8

Response 1: et-0-0-0.msr1.ne1.yahoo.com

IP Address: 216.115.105.25

Response 2: et-0-0-0.msr2.ne1.yahoo.com

IP Address: 216.115.105.179

Response 3: et-19-1-0.msr2.ne1.yahoo.com

IP Address: 216.115.105.181

Layer 3 Interfaces and Statistics

Statistics for Interfaces on Layer 3 devices may be identified and measured if the AirCheck G3 has SNMP access.



COS_DEV_SW1

13 ms, 12 ms, 13 ms Hop: 3 >

In: Gi1/0/47

1 Gb FDx

Tap a Hop card to see a summary of Interface Details and Statistics, if they are available.

See also [Layer 2 Switch Interfaces and Statistics](#) below.

Network Problems in Path Analysis

The Hop cards can also show detected Problems based on the [Problem Settings](#) in the Discovery app and display the device type icons in the corresponding colors.

The yellow switch icon in the image above indicates a **Warning** status.

☰
Path Analysis



COS_DEV_SW1

13 ms, 12 ms, 13 ms

Hop: 3

Router: [COS_DEV_SW1](#)

IP Address: 192.168.249.82

In: [Gi1/0/47](#)

Speed: 1 Gb

Duplex: FDx

Statistics

Util: 0.3 % Discards: 0.0 % Errors: 0.0 %

Tapping the [blue linked](#) switch name opens a [Discovery Details screen](#) for the switch, where the user can investigate the cause of the Warning.



Layer 2 Devices

Layer 2 devices can be switches or APs.

Layer 2 Switches

The image below displays an example of a Path Analysis to a device on the local broadcast domain with two switches in the Layer 2 portion of the path.

Path Analysis





Interface: Any Port
 Protocol: Connect (TCP)
 TCP Port: 80 (www-http)

Results

Started: 3:41:34 PM
 Status: Destination reached in 1 hop

[UPLOAD TO LINK-LIVE](#)

Angela's AirCheck G3
>

Out: Wi-Fi Port 1 Gb FDx

COS_DEV_SW1
>

In: Gi1/0/13	VLAN: 500	1 Gb FDx
Out: Gi2/0/24	VLAN: 500	1 Gb FDx

cos-dev-sw18-poe
>

In: Gi0/1	VLAN: 500	1 Gb FDx
Out: Gi0/7	VLAN: 500	1 Gb FDx



Cetus
>

6 ms, 4 ms, 6 ms Hop: 1

The AirCheck G3 is able to identify these Layer 2 switches and their interfaces because it has [configured SNMP](#) access to the switches.

The switch cards display the In and Out Interface IDs, VLAN ID, and the link speed and duplex (if detected) of the interfaces.

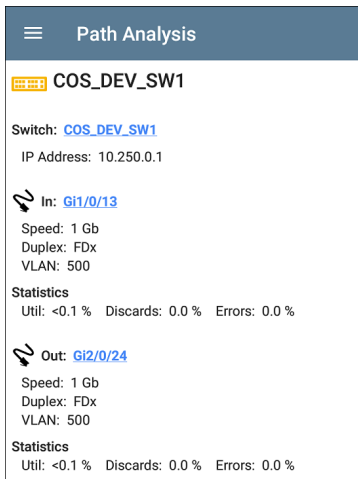
Tapping a Layer 2 card opens a Details screen for the device.



The screenshot shows the 'Path Analysis' app interface. At the top, there is a blue header with a hamburger menu icon and the text 'Path Analysis'. Below the header, the device name 'COS_DEV_SW1' is displayed with a keyboard icon to its left. Underneath, the switch name 'Switch: COS_DEV_SW1' and IP address 'IP Address: 10.250.0.1' are listed. The 'In' interface section is marked with a red lightning bolt icon and shows 'In: Gi1/0/13', 'Speed: 1 Gb', 'Duplex: FDx', and 'VLAN: 500'. Below this, the 'Statistics' section shows 'Util: <0.1 %', 'Discards: 0.0 %', and 'Errors: 0.0 %'. The 'Out' interface section is also marked with a red lightning bolt icon and shows 'Out: Gi2/0/24', 'Speed: 1 Gb', 'Duplex: FDx', and 'VLAN: 500'. Finally, another 'Statistics' section shows 'Util: <0.1 %', 'Discards: 0.0 %', and 'Errors: 0.0 %'.

A Layer 2 Details screen displays the device name and IP address at the top.

NOTE: The yellow switch icon in the image above indicates a **Warning** status. See [Network Problems in Path Analysis](#) later in this topic.

Layer 2 Switch Interfaces and Statistics

Layer 2 Switch Details screens in Path Analysis display a summary of the Interface Statistics (described below). To view all available information for these interfaces, tap their blue links to open a [Interface Details](#) screen in the Discovery app.

Statistics for Interfaces on Layer 2 switches may be identified and measured if the AirCheck G3 has SNMP access.

In/Out: Indicates the interface type and name. The interface name often contains the physical port number where the switch is connected to the network.

Util: Percentage of total interface capacity being used

Discards: Percentage of total packets that have been dropped

Errors: Percentage of packets containing errors

Layer 2 APs

If the Layer 2 path starts or ends with a Wi-Fi device, its AP is shown as a Layer 2 device in the path.

A Layer 2 AP card indicates the connected network SSID, channel, and 802.11 type in use.

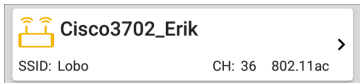

Layer 2 AP Details screens allow you to further examine the wireless characteristics by selecting their blue links, which open a [Wi-Fi app Details](#) screen.

 **Path Analysis**

 **Cisco3702_Erik**

AP: [Cisco3702_Erik](#)

IP Address: 10.250.3.69

 SSID: [Lobo](#)

BSSID: [Cisco:b83861-84aaf9](#)

Channel: [36](#)

Protocol: 802.11ac

Security: --

No layer 2 devices discovered

 **Layer 2 Path**

No layer 2 devices discovered

In some cases, the AirCheck G3 does not discover Layer 2 devices between Layer 3 devices. There may not be any Layer 2 devices, or AirCheck G3 might not have SNMP access to those switches.

The Layer 2 card may also display a result of "No switches found," which indicates that Discovery

has not found any switches with SNMP access to determine if the switches are in the path. If this is an unexpected result, check and verify your [SNMP Configuration](#) and [Extended Ranges](#) in the Discovery app settings.

Uploading Path Analysis Results to Link-Live

Tapping the **UPLOAD TO LINK-LIVE** link on the top card opens the [Link-Live](#) sharing screen for path analysis results:

**Link-Live**

by NetAlly



Path Analysis Name

20190419_131047

Comment

Conference Room B

Job Comment

Union Hall



SAVE TO ANALYSIS FILES

Path Analysis results are uploaded to the **Analysis** page  on Link-Live.

[Back to Title and Contents](#)



AirMapper™ App

The AirMapper Site Survey application enables you to perform a Wi-Fi survey of an indoor or outdoor location and upload it to Link-Live Cloud Service. On Link-Live.com, you can view heatmaps and Wi-Fi measurements for each data collection point.

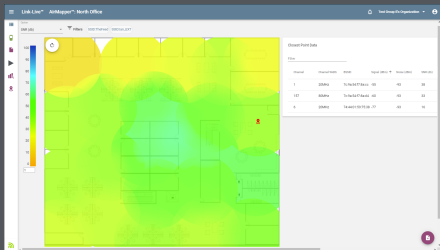



The Signal heatmap is available to all Link-Live users. **AllyCare** Support customers can also view maps of Noise, SNR, and Max TX and RX Rates. Visit NetAlly.com/Support.

AirMapper Settings

Setting up the AirMapper app to perform a survey involves naming the survey, loading a floor plan image, specifying its dimensions, setting scanning mode, and overriding bands and channels.

- Only .png and .jpg image file types are supported.
- You may need to use an image editing application to crop your floor plan image to known dimensions, such as the walls of a building or property boundary.

Access the AirMapper settings by selecting the menu icon  or settings icon  at the top of the main app screen.

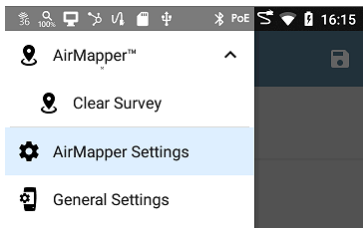

Configuring an AirMapper Survey

AirMapper Settings	
Name Second floor survey	
Description Quick walk all isles	
Floor Plan Denver Site	>
Survey Mode Current Scan (Passive)	
Override Bands and Channels Disabled	<input type="checkbox"/>

Name

Tap the **Name** field to enter a custom name for your AirMapper project. This name is uploaded to Link-Live to identify this survey project.

Description

Enter any additional information you want for the survey.

Floor Plan

NOTE: You can configure floor plans on Link-Live and then send them to your AirCheck G3. A notification appears when a new floor plan arrives:



The new floor plan is added to the existing floor plans but is not automatically selected.

To select a floor plan:

1. Tap **Floor Plan** to open the list of available floor plans.

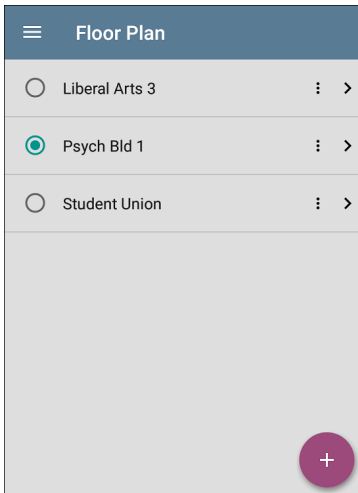

2. Select a floor plan or load a new floor plan by tapping the floating action button , using the file selector to navigate to the new map image file, and then tapping the file to select it. This displays the Floor Plan menu.



3. Fill out the remaining fields for the Floor Plan as needed:

Floor Plan	
Name	DenverSite
Imported File	DenverSite.png
Dimensions	500 x 711 feet >
Signal Propagation	20.0 feet

Name: Enter a name for this floor plan. This field defaults to the file name.

Imported File: The original image file name.

Dimensions: Tap this option to display the floor plan with two markers. Move the markers to two places on the floor plan that are a known distance apart. Then tap **Marker Distance** to enter the distance between the two points. (Set the units (feet or meters) in

the [General Settings](#) for the test apps, accessed from the left-side navigation drawer ) When finished, tap  to return to

Floor Plan menu.

Signal Propagation: Tap to enter a value for the propagation radius for the survey sample points.

Survey Mode

Tap Survey Mode to select the Wi-Fi data collection method that best suits your Wi-Fi environment and survey data collection requirements:

1. **Current Scan** (Passive) is the default and preferred way to perform a survey. It allows immediate data collection based on the most recent AP beacon seen from each BSSID. AP BSSIDs age out after 140 seconds, and Wi-Fi clients age-out after 4 minutes.
2. **Scan Once** (Passive) is more precise but more time-consuming. When a point is selected, all the BSSID information is cleared, and the unit acquires a single scan

of the selected channels for the selected dwell time. This gives an exact measurement. However, in congested environments any beacons not seen during the dwell time are not included in that sample point.

3. **Connected** (Active) collects data from the linked connection of the Wi-Fi Test port. NOTE: Selecting this method disables the AirMapper settings for Dwell Time and Override Bands and Channels.

Dwell Time

(Enabled for passive survey modes only.) Tap **Dwell Time** to select choose a preset dwell time or enter a custom value. See the [General Settings](#) for additional information about dwell time.

Override Bands and Channels

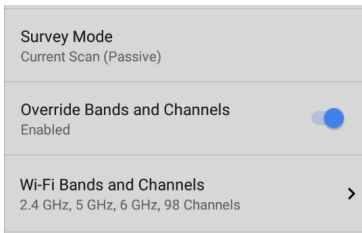

(Enabled for passive survey modes only.) Tap **Override Bands and Channels** to enable selection of different bands and channels than the values defined in [General Settings](#). (These override settings are used only for AirMapper site surveys.) Enabling this setting displays the Wi-Fi Bands and Channels setting.

Wi-Fi Bands and Channels

(Enabled only when Override Bands and Channels is enabled.) Tap **Wi-Fi Bands and Channels** to open a list of frequency bands. Then tap the frequency band to open a menu to select specific channels to use for that band. See the [General Settings](#) for additional information.

Wi-Fi Bands and Channels	
Wi-Fi Band(s)	2.4 GHz, 5 GHz, 6 GHz
2.4 GHz Channels	All
5 GHz Channels	All
6 GHz Channels	All

Note: Selecting a subset of channels and bands lets you exclude scans of unneeded channels from the survey. This improves survey performance and reduces the amount of data collected.

Changing Settings after Starting

You can reopen the AirMapper settings to change the **Floor Plan > Dimensions** or **Signal Propagation** size after starting your survey. Existing data points are retained on the map unless you select a different Floor Plan.

Note: NetAlly does *not* recommend that you change the band, channel, or dwell time settings after you have started a survey. The survey results for the multiple settings can create confusing or less reliable results. If you wish to do so and if the **Override Bands and Channels** setting is enabled, you can use the AirMapper Settings to make changes after you have started your survey. If the **Override Bands and Channels** setting is *not* enabled you must use the General Settings to make changes.

Hidden SSIDs and APs

For any [Hidden] APs or SSIDs at your site that you want detected during a survey, NetAlly recommends creating and enabling a Wi-Fi Profile in the AutoTest app, configured with the appropriate credentials. Otherwise, AirMapper detects the BSSIDs associated with hidden devices but may not determine their APs/SSIDs.

Passive Survey

Wi-Fi Management Port:

GuestNetwork

Bluetooth: Enabled

DISMISS

To collect data, travel around your site, and tap the map at your current location to scan the enabled wireless channels in that spot.

Do not move from that location until the scan is complete and the data point on the screen turns from red to green.

Channel Scanning Indicator



Pause or finish data collection

Undo last point

Tap your location on the map to scan channels and create a data point.

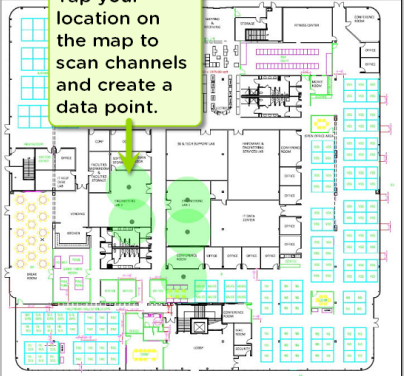

Rotate image



As shown in the image above, you can undo previous collection points and rotate the image as needed.

Use swiping and pinch-to-zoom gestures to pan and zoom the map.

While the AirCheck G3 is scanning, the Signal Propagation circle is red. Once the scan is complete, the circle turns green.

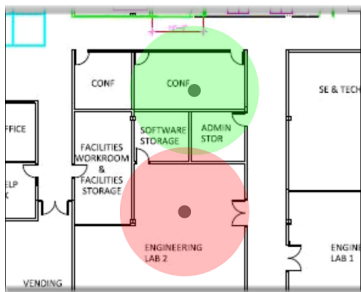

The completed data points in the AirMapper app are always green. The colored heatmap is generated once you upload the AirMapper results to Link-Live.

Watch the Wi-Fi status icon  in the top status bar to see the channels the AirCheck G3 is scanning in real time.

NOTE: To adjust the **Dwell Time**, meaning the amount of time the AirCheck G3 lingers on each channel gathering data, enable the Override Bands and Channels and open the Wi-Fi Bands and Channels, or open the [General Settings](#) > **Wi-Fi Bands and Channels**, accessed from the left-side navigation drawer.

When you finish adding data points, or if you want to pause, tap **STOP**.



Tap **RESUME** to add more data points.

Taking a Connected (Active) Survey

Use AutoTest to run a Wi-Fi profile and connect the desired SSID. Tap **START** to begin the survey.

If not connected to an SSID, a message is displayed at the bottom of the screen and the survey will not start.

Collect data as you would a passive survey described above.

If the connection is lost, the link notification changes to an X. AirCheck G3 continuously tries to reconnect to the SSID.

Survey points taken during this unlinked time are displayed in Yellow. These indicate areas where there is not coverage for that SSID.

When you finish adding data points or if you want to pause the survey, tap **STOP**.

Tap **RESUME** to add more data points.

Tap the Link-Live upload icon  to send your survey results to Link-Live's AirMapper page.

Adding Wi-Fi Management Port Data

If the Wi-Fi Management port is connected to an SSID, its active connection data is added to any survey points taken. It doesn't matter what type

of survey you are taking. This information is viewable only on Link-Live.

Adding Comments

Long press on the floor plan to add a comment. A context menu appears. Tap **Add Comment**. A dialog appears to enter your comment. Tap **OK** to add the comment.

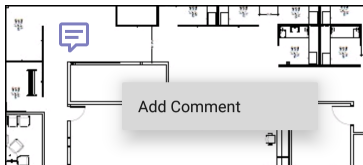

Long press over a comment to edit/delete it. The selected comment turns dark and a context menu appears. Tap **Edit Comment**. Edit the comment and tap **OK** or tap **Delete** to remove it. If two comments are very close, the closest one to the tap point is selected.

Deleting Survey Points

Long press over a survey point to delete it. The selected survey point turns red and a context

menu appears. If two survey points overlap, the closest survey point is selected. Tap **Delete Survey Point**.

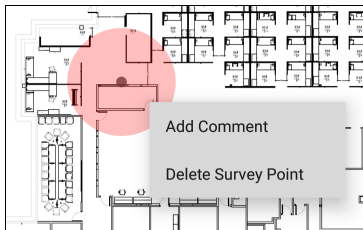

NOTE: There is no undo for deleting a survey point. Once deleted, it cannot be recovered.

Uploading AirMapper Surveys to Link-Live

When you tap the upload icon , select **Upload to Link-Live** to display the Link-Live sharing screen.

Tap the Link-Live upload icon  to send your survey results to Link-Live's AirMapper page. The upload dialog lets you enter a survey name, a comment for the overall survey, and a job

comment (such as a note about the overall job status).

NOTE: When you upload data from a survey (or save it locally), your unit also uploads/saves a Discovery analysis file to assist with data analysis on Link-Live. When you upload an active survey, the connection log is also uploaded.

**Link-Live**

by NetAlly



Survey Name

North Office

Comment

Quick Coverage Test

Job Comment

Event Check

**SAVE TO AIRMAPPER FILES**

Enter any **Comments** or Job Comments you want attached to your AirMapper result in Link-Live, and tap **SAVE TO AIRMAPPER FILES**.

NOTE: The Job Comment remains the same until you delete or change it.

The current survey remains on the AirMapper screen until you **Clear Survey**, allowing you to add additional points if needed and re-upload.

Export AirMapper Data to AirMagnet Survey PRO

Survey data can be exported as a .amp file for import into AirMagnet Survey PRO version 10 for more advanced analysis, planning and reporting.

When your survey data collection is complete, tap the upload icon  and select **Export to Survey PRO** to create the .amp file.

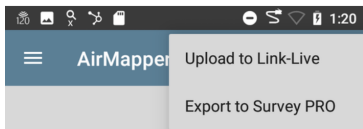

Optionally rename the .amp file and select the Save button to create the .amp file.



You can copy the file to external storage at a later time using the Files app.

Load and Save AirMapper Settings

The entire survey configuration can be saved as named settings using the disk icon in the title bar.



This allows fast recall of any specific survey configuration.

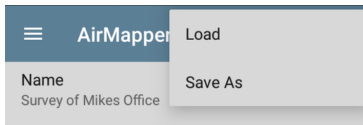

Starting a New Survey

To start a new AirMapper survey, open the left-side drawer and select **Clear Survey**.



AirMapper™



Clear Survey



AirMapper Settings



Spectrum Test App

The Spectrum Application is a dual-band Wi-Fi spectrum analyzer that measures Wi-Fi signal information to provide data about signal strength as well as noise. This application requires the NXT-1000 Portable Spectrum Analyzer (sold separately or included in kits), which plugs into the top USB port of your EtherScope nXG.

This application offers:

- Frequency spectrum (heat map) display across the frequency band
- Waterfall display (2-minute historical) of RF
- Real time display of current, average, and max-hold signal levels

This information can help you identify both Wi-Fi and non-Wi-Fi sources in your environments.

Using the Spectrum Views

Opening the Spectrum app automatically changes the screen orientation and opens the default view: a Frequency Spectrum graph for the 2.4 GHz band. You can choose from three views of live data: Frequency Spectrum (heatmap), Waterfall, and Real Time.





Before You Begin

- Connect NetAlly's Spectrum dongle to the top USB port (USB Type-A) of your AirCheck G3. (See [Contact NetAlly](#) to acquire the NXT-1000 Portable Spectrum Analyzer if you do not already have one.)
- Tap the Refresh icon  to clear the current graph and start new measurements.
- To get more accurate test results, NetAlly recommends that you turn off your device's test and management Wi-Fi and Bluetooth. (The Spectrum app notifies you if these services are turned on.)

To turn off test Wi-Fi:



1. Tap the Menu icon  to open the Spectrum navigation drawer.
2. Tap **General Settings**.
3. Tap **Use Wi-Fi test port** to set it to Disabled.

To turn off management Wi-Fi and Bluetooth:

1. Swipe down from the top of the AirCheck G3 screen to display the system icons.
 2. Tap the Wi-Fi icon  until it indicates that Wi-Fi is off . (You can also use the [General Settings](#) to turn off management Wi-Fi.)
 3. Tap the Bluetooth icon  until it indicates that Bluetooth is off .
- (Optional) See "[Spectrum Settings](#)" on [page 578](#) for instructions on changing the frequency band, changing the Waterfall View type, and saving settings.

Using Common View Actions

Use these actions in each Spectrum view to change the view details:

- **Pause:** Tap the Pause icon  to stop updates of the display. This can help you examine patterns and anomalies without updated data overriding your current view.
- **Resume:** Tap the Resume icon  to cancel a pause and continue live data updates.
- **Refresh:** Tap the Refresh icon  to clear the graph and start acquiring new data. (A refresh also cancels a pause.)
- **Display markers:** (Frequency Spectrum and Real Time views only) Tap the graph at a particular frequency that you want to examine. This displays a pink vertical marker at that frequency and lists the frequency's numerical details above the graph.
 - The Frequency Spectrum view displays the frequency and its maximum value.
 - The Real Time view displays the frequency, the frequency's current value, the average value, and the highest measured value (Max-Hold).

- If you have a specific frequency detail marker, double-tapping on the marker erases it. (You can reset the marker by single-tapping the graph again.)
- **Zoom in:** Double-tap the view graph to zoom in to a narrower band around a particular frequency.
 - For the 2.4 GHz band, the graph centers on a 40 MHz range around the channel closest to the frequency you tapped.
 - The 5 GHz band the graph centers on an 80 MHz range around the nearest of several predefined frequency ranges.
- **Restore to normal view:** Tap the Restore icon  to close the zoomed-in view, return to the full display for the frequency band, and refresh the graph with new data.
- **Saving results:** see "[Uploading Spectrum Results to Link-Live](#)" on page 576.

Frequency Spectrum View

This display uses the color spectrum to present a heatmap of the frequency band you have chosen, showing the density of recent RF measurements.

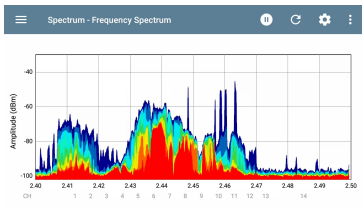

- Blues and greens ("cool" colors) indicate less RF detected at that frequency and amplitude.
- Yellow, orange, and red ("hot" colors) indicate the repeated presence of RF at that frequency and amplitude.
- Darkest blue indicates infrequent RFs while red indicates the continuous presence of RF at that amplitude.

Waterfall View

The Waterfall display draws new data at the top of the display as it scrolls older data downwards over a 2-minute interval. This provides a visualization of RF activity over time.

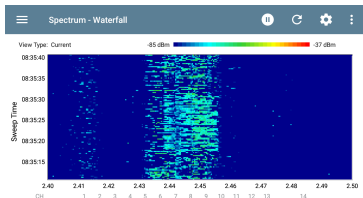

- The vertical axis shows the measurement time, and the horizontal axis shows frequencies and channels.
- The colors in the waterfall represent the amplitude of a frequency at a certain time according to the scale in the upper right. Dark blue shows lower amplitude measurements, and lighter colors show higher amplitude signals. More colors indicate more activity. For example, in the waterfall shown

above, a speed test is running on Channel 8.

- The waterfall has two view types. Use Current to detect instantaneous RF. To smooth the data and see overall usage, change the type to Average 5 Sweeps, which averages five sweeps for each new line of data. This decreases the data resolution but may make the data easier to interpret in highly active RF environments. (See ["Changing Spectrum Settings" on page 579](#) for instructions on changing the type.)

Real Time View

The Real Time display shows the current values across the frequency band with colored lines for the current measurement, the average measurement, and the highest measured value (Max-Hold).

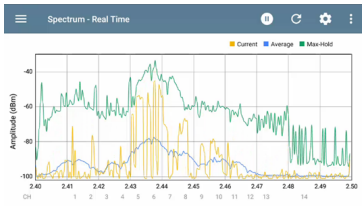

- The yellow line indicates the current values.
- The blue line indicates the average values, which are calculated using all measurements accumulated since the graph was last cleared.
- The green line indicates the highest measured value (Max-Hold).

Uploading Spectrum Results to Link-Live

To send your Spectrum results to the [Link-Live](#) website, tap the action overflow icon  at the top right of the Spectrum screen, and then tap **Upload graphs to Link-Live**.

**Link-Live**

by NetAlly



Graphs Image Name

Comment

Job Comment



SAVE TO LINK-LIVE

The [Link-Live sharing screen](#) opens. The system creates a file name automatically using the date. You can also enter optional Comments and Job Comments to attach to the results file. The results are displayed as images on Link-Live.com.

Spectrum Settings

The Spectrum navigation drawer allows you to change the data views, change frequency bands, change the Waterfall display type, and save settings.

Changing Spectrum Views

To change the Spectrum view:

1. Tap the Menu icon  to open the Spectrum navigation drawer:

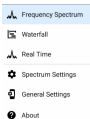

2. Select the view that you want: Frequency Spectrum, Waterfall, or Real Time. See ["Using the Spectrum Views" on page 569](#) for information on using these views.



Saving Settings

To save the current Spectrum settings, tap the Save icon  in the upper right corner of the

Spectrum Settings screen. This opens a menu for you to **Load**, **Save As**, **Import**, or **Export** any changes you make to the settings. See "[Saving App Settings and Configurations](#)" on page 129 for more information.

Changing Spectrum Settings

The Spectrum settings allow you to change the frequency band and to change the waterfall view type.

To change settings, tap the settings  icon or tap the Menu icon  and select **Spectrum Settings** from the Spectrum navigation drawer. Either action opens the Spectrum settings window:

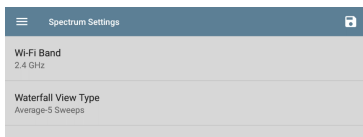

To change the frequency band:

1. Tap **Wi-Fi Band**. This opens a selection box.
2. Tap the button for the frequency band you want, and then tap **OK** to return to Spectrum Settings.
3. Tap **OK** to return to Spectrum Settings.
4. Tap the back button  to return to the Spectrum view.

To change the waterfall view type:

1. Tap **Waterfall View Type**. This opens a selection box.
2. Tap the button for either **Current** or **Average-5 Sweeps**.
 - **Current** maintains the default display for the Waterfall view.
 - **Average-5 Sweeps** averages each line of waterfall data into five sweeps. This decreases some of the data resolution but may make the data easier to understand in highly active environments.
3. Tap **OK** to return to Spectrum Settings.

4. Tap the back button  to return to the Spectrum view.



iPerf Test App

iPerf is a standardized network performance tool used to measure UDP or TCP throughput and loss.

The iPerf app runs an iPerf3 performance test to a NetAlly Test Accessory or an iPerf server endpoint.



The NetAlly Test Accessory runs network connection tests, uploads results to [Link-Live Cloud Service](#), and acts as an iPerf server endpoint for iPerf tests run by other NetAlly handheld testers.

Learn more about the Test Accessory from [NetAlly.com/products/TestAccessory](https://www.netally.com/products/TestAccessory).

If you are using an iPerf server installed on a PC or other device as an endpoint, iPerf version 3 is required to run the AirCheck G3 iPerf test. You can download iPerf server software from <https://iperf.fr>.

iPerf Settings

To run an iPerf test, you must configure your AirCheck G3 unit to communicate with your iPerf endpoint. You can manually enter an iPerf server address, or select a NetAlly Test Accessory's address in the iPerf settings.

Saving Custom iPerf Settings

The iPerf app allows you to save a configuration of settings for running an iPerf test to the same endpoint later.

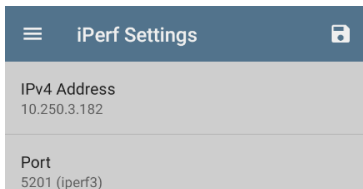

Tap the save icon  to load, save, import, and export configured settings. See [Saving App Settings Configurations](#) for more instructions.

Once you save a settings configuration, the custom name you entered appears at the top of

the iPerf settings and results screens. In the example images here, the user has saved a custom iPerf configuration called "Server Room Endpoint."

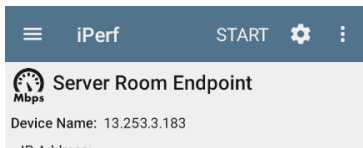
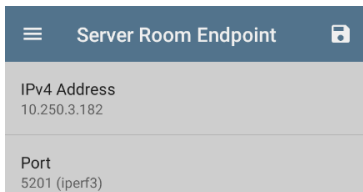



Test Accessories in Discovery

You can start an iPerf test from the Details screen for a Test Accessory in the [Discovery app](#) using the floating action button.

1. Open the Discovery app, and select an active **Test Accessory** from the main

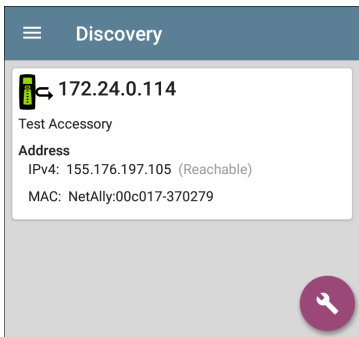
Discovery list to open its Details screen.



2. Tap the floating action button ([FAB](#)) to open the action menu. 





3. Select the **iPerf** app button to open the iPerf app with the IP address populated from the Test Accessory in Discovery.

NOTE: You can also select **Browse** in the FAB menu to open the Test Accessory's Web Interface, where you can view its status and configure its settings.

Configuring iPerf Settings

To configure the iPerf test settings manually, open the settings  on the iPerf screen.

	Server Room Endpoint	
IPv4 Address	10.250.3.182	
Port	5201 (iperf3)	
Duration	10 seconds	
Protocol	TCP	
Direction	Upstream/Downstream	
Upstream Threshold	10 Mbps	
Downstream Threshold	10 Mbps	

Tap each field to enter or revise selections as needed. Changed settings are automatically applied. When you finish configuring, tap the back button  to return to the iPerf test screen.

NOTE: iPerf runs on the test port interface only.

IPv4 Address: Tap the field to enter or select the IPv4 address of the target iPerf server. Only IPv4 addresses are allowed for iPerf testing.



A drop-down list in the IPv4 Address dialog shows all the Test Accessories the AirCheck G3 has discovered through the [discovery process](#), as well as any Test Accessories that are claimed to

the same [Link-Live](#) organization as your AirCheck G3.

NOTE: Clear the address field in the dialog to see the full list of discovered Test Accessory addresses.

Port: The default iPerf3 port number is 5201. Tap the field to enter a different port number.

NOTE: The iPerf port number entered here must match the port number used by your iPerf server. If needed, consult the Test Accessory User Guide (NetAlly.com/products/TestAccessory).

Duration: This setting is the length of time for one direction, Upstream or Downstream, of the iPerf test. If the Direction setting below is set to both Upstream/Downstream, the total test time is twice the value set here. Tap the field to select a new duration or enter a custom value. The default is 10 seconds.

Protocol: TCP is the default protocol. Tap the UDP selector to switch to UDP.

NOTE: iPerf tests running the TCP protocol automatically run at the fastest rate possible.

When running a UDP protocol test, the iPerf app attempts to run at the selected Bandwidth.

Direction: You can run an iPerf test Upstream, Downstream, or both. The default is Upstream and Downstream. Tap this field to set the test for only one direction.

Upstream and Downstream Bandwidth: These fields only appear if the **UDP Protocol** is selected. They specify the desired target bandwidth for the iPerf Test using the UDP protocol.

Upstream and Downstream Thresholds: Thresholds are the values the AirCheck G3 uses to grade the test as **Pass** or **Fail**. iPerf thresholds are throughput rates. The default is 10 Mbps. Tap the threshold fields to select a different value or enter a custom one.

Running an iPerf Test

Ensure that you have an active link on the Interface ([Test or Management Port](#)) from which you are running the iPerf test. Wi-Fi test ports require that an AutoTest Wi-Fi Profile has run to establish a link. Management ports link automatically if a connection is available.

Tap the **START** button on the main iPerf screen to begin testing.

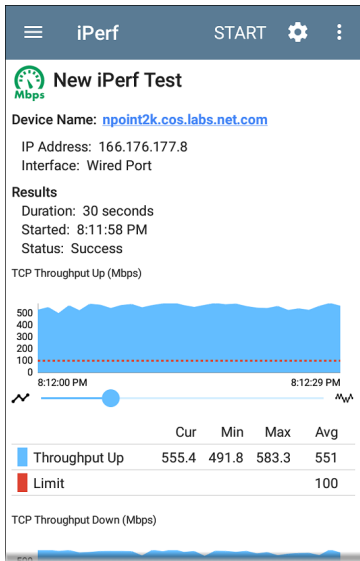

Test characteristics and status are displayed at the top of the iPerf results screen while the lower part of the screen displays a real-time graph of the TCP or UDP Upload and/or Download speeds.

To pan and zoom on the graphs, you can swipe, double tap, and move the slider. See the [Trending Graphs](#) topic for an overview of the graph controls.

Device Name: Hostname or address of the iPerf server or Test Accessory

IP Address: IPv4 address of the iPerf server

Interface: The AirCheck G3 Test or Management Port from which the test is running

Results

- **Duration:** Configured Duration from the iPerf settings
- **Started:** Time the test started
- **Status:** Success or failure status of the test.

TCP/UDP Throughput Up and Down graphs:

The iPerf graphs plot the throughput rate to (Up) or from (Down) the iPerf server in Mbps.

The table below each graph displays the Current, Minimum, Maximum, and Average rates.

Limit: This is the **Threshold** from the iPerf app's settings. The threshold value is also displayed on the graph as a red dotted line.

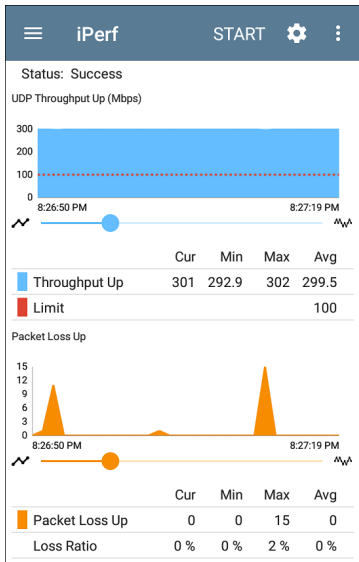

UDP Packet Loss Up and Down graphs: When running a UDP protocol test, the iPerf results also display graphs and tables of Packet Loss. Values for the number and percentage of packets lost are displayed in the table below the

graph. The Packet Loss Up graph and table do not display measurements until results are received from the iPerf server at the end of the upstream test.

Note that the Packet Loss Up number could be much less than the Packet Loss Down number.

Uploading iPerf Results to Link-Live

To send your iPerf results to the [Link-Live](#) website, tap the action overflow button  at the top right of the iPerf screen, and then tap **Upload to Link-Live**.

**Link-Live**

by NetAlly

**Iperf Result Filename**

20190619_134743

Comment

Room 302

Job Comment

Union Hall

**SAVE TO LINK-LIVE**

The [Link-Live sharing screen](#) opens and allows you to revise the auto-generated file name and attach comments to the iPerf result, which is displayed on the Results  page on Link-Live.com.



Link-Live Cloud Service

The screenshot displays the Link-Live Cloud Service interface. The top navigation bar includes a menu icon, the text "Link-Live™ Results", a notification bell, and a dropdown menu for "Test Group: It's Organization". Below the navigation bar is a search bar and a toolbar with various icons. The main content area is divided into a left sidebar and a main panel. The sidebar lists several test results for "Angela's EtherScope nXG - 5300D0" and "Joe's EtherScope nXG - 5301F0". The main panel shows detailed test results for "Angela's EtherScope nXG - 5300D0" on "Nov 22, 2019 12:16 PM". The results are organized into several sections: "Inventory" (with a red 'X' icon and "Add a Label" button), "Test" (showing device details like MAC, Device, Type, Profile, and Firmware), "Link" (showing PHY Rate, Retry Rate, Signal, Noise, SNR, and Success), "Access Point" (showing SSID, BSSID, Channel, and Channel Util), "DHCP" (showing IP, Server, Subnet, DHCP Total, Local IP, and IPv6 Global), "DNS", and "Gateway". A red circular badge with the number "2" is visible in the bottom right corner of the screenshot.

Link-Live Cloud Service is a free, online system for collecting, tracking, organizing, analyzing, and reporting your test results. AutoTest results are automatically uploaded once your AirCheck G3 is claimed.

The comprehensive AirCheck G3 offers more features for analyzing your network in Link-Live than previous testers. Claim your AirCheck G3 to Link-Live.com to access these functions:

- Check for software updates and update your AirCheck G3 software.
- Download third-party applications from the NetAlly [App Store](#) to use on your AirCheck G3.
- Automatically upload [AutoTest](#) results each time you run AutoTest.
- Attach test and [Job](#) comments to Link-Live uploads, and automatically sort your results and files into folders in Link-Live.
- Upload test, discovery, and analysis results from the NetAlly apps, including Discovery, Wi-Fi, Path Analysis, AirMapper, and iPerf. See [Link-Live and Testing Apps](#) for more about uploading.

Getting Started in Link-Live Cloud Service

To start, create a user account at Link-Live.com, and sign in. You can open the Link-Live website in the AirCheck G3's web browser to create and manage your account.

Claiming the Unit

On Link-Live.com

1. The first time you sign in to Link-Live.com, a pop-up window appears, prompting you to claim a device.

If you already have a user account and other devices claimed to Link-Live, navigate to the **Units** page from the left side navigation drawer, and click the **Claim Unit** button  at the lower right corner of the screen .

2. Then, select the AirCheck G3 image, and follow the claiming instructions on the Link-Live website.

On the AirCheck G3 Unit

1. Open the Link-Live app. Your unit's MAC address is displayed.

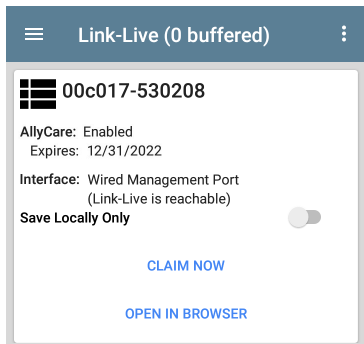

2. Tap **CLAIM NOW** on the Link-Live app screen.
3. When prompted by the instructions on the Link-Live website, enter the MAC address.

After you claim your AirCheck G3 to Link-Live, a software update may be available. If so, a notification appears in the Status Bar . Open the

[Top Notification Panel](#), and select the notification to update your unit.

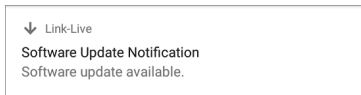

See [Updating Software](#) for more information.

After Claiming

Once your AirCheck G3 is claimed to the Link-Live Cloud Service, it automatically uploads your AutoTest results each time you run AutoTest. You can also upload a test comment and a picture with your test results using the floating action buttons (FABs) for the [Wi-Fi Test Results](#). You can automatically sort your results into folders in Link-Live using test and [Job comments](#).

If your AirCheck G3 is not connected to an active network, any test results, comments, or images are stored in memory (buffered) and uploaded once a connection is established.

For more information on how to use the [Link-Live.com](#) website, click or tap the

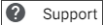
navigation menu icon  at the top left of the Link-Live.com pages, and select .

Unclaiming

You may need to unclaim your unit from Link-Live to transfer it to another user or if you no longer want to send data to Link-Live.com.

To unclaim your AirCheck G3 from Link-Live, tap the navigation menu icon  in the Link-Live app, tap [About](#) screen from and then tap **UNCLAIM**.

 **About**

 **AirCheck G3 Analyzer**

Model: AIRCHECK-G3-PRO

Serial: 1930014

MAC Addresses

Wi-Fi: 00c017-53020a

Wi-Fi Management: 00c017-53020b

System Version: 2.1.0.167

Application Version: 2.1.0.172

AllyCare: Enabled

Expires: 6/24/2023

SFP Details

Type: 10GBASE-SR (850 nm)

Vendor: AVAGO

Version: G2.3

Model: AFBR-703SDZ

Rx Power: --

[UNCLAIM](#) [EXPORT LOGS](#)

AllyCare Code

The AllyCare Code button appears at the bottom of the About screen next to the Export Logs button if your unit is not claimed.

[ALLYCARE CODE](#) [EXPORT LOGS](#)

Tap **AllyCare Code** to open a dialog to enter an AllyCare Activation Code.

Private Link-Live Settings

Use these settings only when your organization has deployed a private instance of Link-Live. Consult your IT organization for setting details.

Link-Live App Features

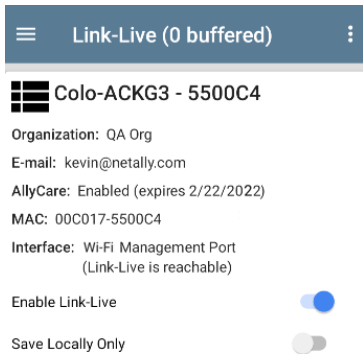

The main Link-Live app screen on your AirCheck G3 facilitates the claiming process, displays Link-Live related information, and allows you to enable or disable Link-Live.com uploads as needed.

Link-Live App Screen



The screenshot shows the Link-Live app interface. At the top, there is a dark blue header with a hamburger menu icon on the left, the text "Link-Live (0 buffered)" in the center, and a vertical ellipsis menu icon on the right. Below the header, there is a device icon (a 2x2 grid of squares) followed by the text "Colo-ACKG3 - 5500C4". Underneath, several fields are listed: "Organization: QA Org", "E-mail: kevin@netally.com", "AllyCare: Enabled (expires 2/22/2022)", and "MAC: 00C017-5500C4". The "Interface" section shows "Wi-Fi Management Port" with a sub-note "(Link-Live is reachable)". At the bottom, there are two toggle switches: "Enable Link-Live" which is turned on (blue), and "Save Locally Only" which is turned off (grey).

[OPEN IN BROWSER](#)

The AirCheck G3 unit's name that displays on the Link-Live.com is shown to the right of the Link-Live icon . You can change this name on the Link-Live.com **Units**  page.

Organization is the Link-Live organization where the unit is claimed.

E-mail is the first e-mail address assigned to the unit, which receives test result notification emails.

The Organization and Email address shown here are assigned on the Link-Live.com website. The fields displayed in AirCheck G3's Link-Live app are informational.

AllyCare indicates the status of NetAlly's optional AllyCare services. See [NetAlly.com/Support](https://www.netally.com/Support) for more information.

Interface shows which network interface is currently being used by Link-Live to post results and its status.

The **Enable Link-Live** toggle button turns the Link-Live features on or off. If Link-Live is disabled here, the AirCheck G3 cannot upload test results or check for software updates. The

Upload to Link-Live options do not appear in the testing apps.

Tap the **OPEN IN BROWSER** link to open Link-Live.com on the AirCheck G3's web browser.

The "(# buffered)" in the Link-Live screen header indicates the number of files stored in the device memory when no active network connection is available. The buffered file types are listed below the main app card.

 **Link-Live (2 buffered)**

 **Ken's AirCheck G3**
530208

Organization: My Organization

E-mail: ken@netally.com

AllyCare: Enabled
Expires: 12/31/2023

MAC: 00C017-530208

Interface: Wi-Fi Management Port
(Link-Live is reachable)

Enable Link-Live

Save Locally Only

[OPEN IN BROWSER](#)

Discovery Snapshot 
Apr 25, 2022 11:16:24 PM

Wi-Fi Snapshot 
Apr 25, 2022 11:16:25 PM

The buffered files displayed automatically upload to Link-Live.com once your AirCheck G3 connects to an active network.

Saving Locally Only

If you do not want to send your results to the Link-Live website, you can still save results locally to your AirCheck G3 as JSON files.



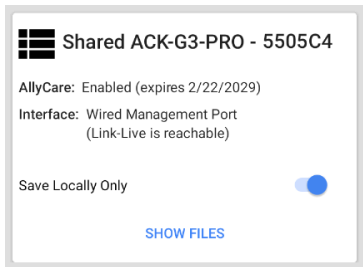

Tap the **Save Locally Only** toggle field in the Link-Live app to save the JSON files to your unit.

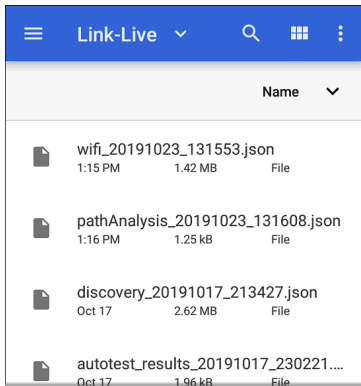

Select **SHOW FILES** to open the **Files** app. The .json files are saved in the **Downloads > TestResults** folder.



The screenshot shows the Link-Live mobile application interface. At the top is a blue header with a hamburger menu icon, the text "Link-Live" with a dropdown arrow, a search icon, a grid icon, and a vertical ellipsis icon. Below the header is a table with a "Name" column header and a dropdown arrow. The table lists four JSON files, each with a file icon, a name, a date, a size, and a "File" type indicator.

	Name			
	wifi_20191023_131553.json	1:15 PM	1.42 MB	File
	pathAnalysis_20191023_131608.json	1:16 PM	1.25 kB	File
	discovery_20191017_213427.json	Oct 17	2.62 MB	File
	autotest_results_20191017_230221....	Oct 17	1.96 kB	File

See the [Managing Files](#) topic for an overview of the Files app.

You can transfer the JSON files to a PC for analysis, or you can download a JSON viewer app from the App Store  on your AirCheck G3.

With **Save Locally Only** enabled, options for uploading or saving to Link-Live (described in the [Link-Live and Testing Apps](#) section below) still display in the NetAlly testing apps. However, the results are saved to the internal Link-Live

storage folder, and not uploaded to Link-Live.com.

Job Comment

The [left-side navigation drawer](#) for the Link-Live app lets you enter or change the Job Comment. The **Job Comment** attaches to all test results and files uploaded to Link-Live, until you change or delete it. In contrast, other **Comments**, like those attached to [Wi-Fi](#) AutoTest results or [Discovery](#) results, are only attached to one set of test results or uploaded file.

Both comment types appear on [Link-Live sharing screens](#) like the one below:

**Link-Live**
by NetAlly

File Name
client1024rsa-new.pem

Comment
Certs

Job Comment
South Campus Wi-Fi

To enter or change the Job Comment in the Link-Live app:

1. With the Link-Live app open, tap the menu icon  or swipe right from the left side of the screen.

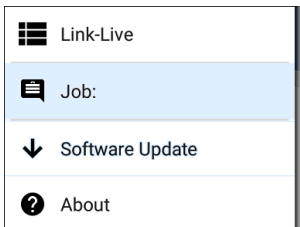

2. Tap the **Job:** field.
3. Enter a comment in the dialog box.
4. Tap **SAVE**.





Note that the **Job Comment** field appears in other Link-Live sharing screens, allowing you to change it from multiple locations on the AirCheck G3. No matter where you change the Job Comment, it is updated everywhere on the unit.

Software Updates

The left-side navigation drawer for the Link-Live app also lets you check for and download any available software updates. See [Updating Software](#) in the Software Management chapter.

Link-Live and Testing Apps

Once your unit is claimed, the Link-Live app works with several of the testing apps to upload test results, discovery and analysis data, comments, and images to the Link-Live website. Link-Live.com categorizes the uploads from different apps on corresponding webpages, as shown below:

LINK-LIVE WEBPAGE	APP UPLOADS
 Results	AutoTest and iPerf results, images, connect logs, and other files when saved to a test result
 Uploaded Files	Captures, images, connect logs, and other file types
 Analysis	Discovery, Wi-Fi, and Path Analysis results
 AirMapper	AirMapper Heatmaps

If your unit is not claimed to [Link-Live.com](https://link-live.com) or if Link-Live is disabled on the app screen, the links and buttons for uploading to Link-Live in the testing apps do not appear.

Link-Live Sharing Screens

Save to Link-Live



UPLOAD TO LINK-LIVE

Whenever you select a button or link, like those above, to Upload, Save, or [Share](#) to Link-Live, a Link-Live sharing screen appears with the appropriate options for the data type.

For example, the Link-Live sharing screen for Discovery or Wi-Fi app data allows you to upload to the Analysis  page on Link-Live.com.

**Link-Live**

by NetAlly

**Wi-Fi Snapshot Name**

20190429_122109

Comment



Conference Room B

Job Comment

North Office



SAVE TO ANALYSIS FILES

The Link-Live sharing screen for a screenshot or other image allows you to attach it to the most recently run test result (AutoTest or iPerf) on the Results  page, or to the Uploaded Files  page on Link-Live.com.



Link-Live

by NetAlly



Comment

Conference Room B

Job Comment

North Office



SAVE TO LAST TEST RESULT



SAVE TO UPLOADED FILES

Remember, the regular **Comment** field uploads only to the current result or file, while the **Job Comment** field uploads with all results and files until you change it.

Sharing a Text File to Link-Live

You can also select and share text by [long pressing](#) text on the unit's screen. Text files are attached to the last test results on Link-Live.com.

1. Long press a text string to select it.

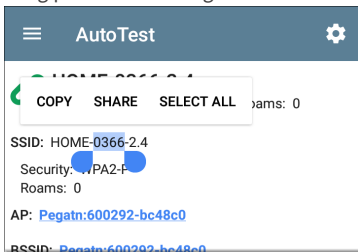

2. Tap **Select All** if needed.

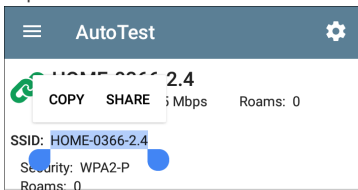

3. Tap **SHARE**.

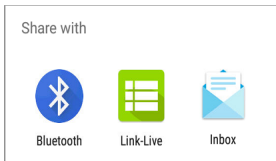

4. Select the Link-Live icon to open the [Link-Live sharing screen](#).



Link-Live
by NetAlly



File Name
20191106_155804

Comment
SSIDs

Job Comment
/Inventory

 **SAVE TO LAST TEST RESULT**

5. Enter any **comments** as needed, and then tap **SAVE TO LAST TEST RESULT**.

Basic Wired Testing With Link-Live Pairing

Link-Live allows you to add several simple wired tests by pairing a NetAlly LinkSprinter or Test Accessory with your AirCheck G3. This ability lets you run wired tests and view the results on your unit. For example, you may wish to make sure that an AP is getting adequate PoE and basic connectivity while performing a Wi-Fi survey or running other Wi-Fi tests. The wired data is uploaded to Link-Live and then shared to your AirCheck G3 to give you more complete information.

Tests available are:

- Power Over Ethernet (PoE)
- Wired link verification
- DHCP link verification
- Gateway detection
- Link-Live access verification
- (LinkSprinter only) Wi-Fi availability

You can also view the information on Link-Live, which includes supplemental information fields.

Before You Begin

- You must have a Test Accessory iPerf Tester or a LinkSprinter Pocket Network Tester. To acquire one of these devices, contact your netally.com representative or visit: netally.com
- Read the user guide available for your product, available at: <https://www.netally.com/support/user-guides/>

Link-Live Setup

1. Log into your Link-Live account. (You can use a PC or start the Link-Live app on your AirCheck G3 and then select the **Open in Browser** option.)
2. Make sure your AirCheck G3 is [claimed](#) to Link-Live.
3. Using the same Link-Live organization to which you claimed your AirCheck G3, claim your Test Accessory or LinkSprinter as per the instructions in the documentation.
4. Select the **Units** option from the left-side menu. This displays your claimed devices.

5. Select your AirCheck G3. (On a PC, you can use the filter icons at the top of the list.) This displays your device information.
6. Scroll down until you see the Pair Unit heading.
7. Tap or click on the **Pair Unit** toggle button next to the Test Accessory or LinkSprinter that you want to pair with your unit.
8. Turn off your Test Accessory or LinkSprinter and unplug its Ethernet wire connection.

Run the Paired Test and View Results

To run a paired wiring test:

1. With your Test Accessory or LinkSprinter turned off, plug the Ethernet cable connection that you want to test into the test port. (All test LEDs activate for a few seconds, and then the PoE icon LED  remains on if there is adequate power from the connection.)
2. Wait about 90 seconds for a tests to complete. All five LEDs turn green if the tests are successful. The test results are uploaded

to Link-Live and then shared with your AirCheck G3.

3. To view the results on your AirCheck G3:
 - a. Wait for the paired test icon  to appear on the system notification bar.
 - b. Swipe down from the top of the screen to view the notifications list.
 - c. Locate and tap on the down arrow for the notification from Link-Live that shows a new result from your Test Accessory or LinkSprinter.

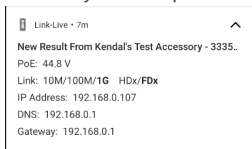

- PoE voltage is listed
- Bold fields in the Link details show actual speed and duplex.
- The IP Address is the DHCP IP.

- The DNS is the primary server (DNS 1)
- Ping times to reach google.com are not included.

NOTE: successive tests replace the data in the notice.

4. To view the results on a PC:
 - a. In Link-Live, select the **Results** option from the left-side menu. This displays your test results for all your claimed devices.
 - b. Select the results you want for the paired Test Accessory or LinkSprinter from the list. (On a PC, you can use the Search function to look for specific devices, folders, etc.) This displays the same information as the AirCheck G3 system notification described above, but it adds additional information fields:
 - Link polarity
 - DHCP subnet mask

- Gateway ping time and public IP address
- Ping time for google.com
- (LinkSprinter only) Information on the nearest switch (switch name, model, IP/MAC address, port number, and type)

Specifications and Compliance

This chapter contains device specifications and required compliance information.

AirCheck G3 Specifications

General

Dimensions	4.01 in x 7.71 in x 1.65 in (10.2 cm x 19.6 cm x 4.2 cm)
Weight	1.05 lbs (0.48 kg)
Battery	Rechargeable lithium-ion battery pack (3.63 V, 9.75 Ah, 36.39 Wh)
Battery Life	Typical operating life is 8 hours. Typical charge time is 3 hours.
Display	5.0-inch color LCD with capacitive touchscreen (720 x 1280 pixels)
Host Interfaces	(2) USB Type-A Ports USB Type-C On-the-Go Port
Memory	Approximately 8 GB available for storing test results and user applications
Charging	USB Type-C 45-W adapter: AC Input Power 100-240 V, 50-60 Hz; DC Output Power 15 V (3 A)
Supported IEEE Standards	Wi-Fi: 802.11 ax/ac/a/b/g/n
LEDs	1 LED (Status Indicator)

Tri-band Wireless

AirCheck G3 has two internal Wi-Fi Radios:

- **Wi-Fi Testing** – WiFi 6/6E 2x2 MU-MIMO wireless radio 802.11ax
- **System Wi-Fi, Bluetooth, and Management** – 1x1 Dual-band 802.11ac Wave 2 + Bluetooth 5.0 and BLE wireless radio 802.11ac

WiFi 6/6E 2x2 MU-MIMO Tri-band Radio for Testing

Applicant's Name	NetAlly
Model Number	WNFQ-268AXI(BT)
Manufacturer	SparkLAN Communications, Inc.
Manufacture Date	2021
Country of Origin	Taiwan
Security	64/128-bits WEP, WPA, WPA2, WPA3, 802.1x
Regulatory Domain	World Mode
Antenna Gain	2.0 dBi peak/2.4 GHz 1.5 dBi peak/5 GHz 2.7 dBi peak/6 GHz

Data Rates

- **802.11a/g:** 54 Mbps
- **802.11ac:** MCS0~9
- **802.11ax:** HE0~11
- **802.11b:** 11 Mbps
- **802.11n:** MCS0~15
- **Bluetooth:** 1 Mbps, 2 Mbps, 3 Mbps

Operating Frequencies

The AirCheck G3 receives on all of the frequencies in every country, but transmits only on the frequencies and channels allowed in the country.

The Wi-Fi radio supports the following frequency bands:

- **2.4-GHz band:** 2.412 – 2.484 GHz*
- **5-GHz band:** 5.150 – 5.825 GHz*
- **6-GHz band:** 5.925 – 7.125 GHz *

* where permitted

Modulation

Wi-Fi:

- **802.11a:** OFDM (BPSK, QPSK, 16-QAM, 64-QAM)
- **802.11ac:** OFDM (BPSK, QPSK, 16-QAM, 64-QAM, 256-QAM)
- **802.11ax:** OFDMA (BPSK, QPSK, 16-QAM, 64-QAM, 256-QAM, 1024-QAM)
- **802.11b:** DSSS (DBPSK, DQPSK, CCK)
- **802.11g:** OFDM (BPSK, QPSK, 16-QAM, 64-QAM)
- **802.11n:** OFDM (BPSK, QPSK, 16-QAM, 64-QAM)

Bluetooth:

- **Header:** GFSK
- **Payload 2M:** $\pi/4$ -DQPSK
- **Payload 3M:** 8-DPSK

Receive Sensitivity

- 6 Mbps: -90 dBm
- 54 Mbps: -71 dBm
- 802.11n 20 MHz: -89 dBm (MCS 0/8)
- 802.11n 40 MHz: -86 dBm (MCS 0/8)
- VHT20 MCS 8: -63 dBm
- VHT40 MCS 9: -60 dBm

- VHT80 MCS 9: -57 dBm

System 1x1 Wi-Fi/Bluetooth Management Radio

Applicant's Name	NetAlly
Model	BLUE bean
Manufacturer	8devices
Manufacture Date	2019
Country of Origin	United States
Security	64/128-Bit WEP Key, WPA, WPA2, 802.1X (TKIP, AES)
Regulatory Domain	World Mode
Antenna Gain	1.1 dBi peak in the 2.4-GHz band; 3.2 dBi peak in the 5-GHz band

Data Rates

- **802.11a:** 6, 9, 12, 18, 24, 36, 48, 54 Mbps
- **802.11b:** 1, 2, 5.5, 11 Mbps
- **802.11g:** 6, 9, 12, 18, 24, 36, 48, 54 Mbps
- **802.11n 20 MHz:** 7.2, 14.4, 21.7, 28.9, 43.3, 57.8, 65, 72.2, 86.7 Mbps
- **802.11n 40 MHz:** 15, 30, 45, 60, 90, 120, 135, 150 Mbps

- **802.11ac 20 MHz:** 7.2, 14.4, 21.7, 28.9, 43.3, 57.8, 65, 72.2, 86.7 Mbps
- **802.11ac 40 MHz:** 15, 30, 45, 60, 90, 120, 135, 150, 180, 200 Mbps
- **802.11ac 80 MHz:** 32.5, 65, 97.5, 130, 195, 260, 292.5, 325, 390, 433.3 Mbps

Operating Frequencies

The AirCheck G3 receives on all of the frequencies in every country but transmits only on the frequencies and channels allowed in the country.

These are the center frequencies of the channels that the Wi-Fi radio supports.

- **2.4-GHz band:** 2.412 – 2.484 GHz (channels 1 through 14)
- **5-GHz band:** 5.150 – 5.825 GHz (channels 34, 36, 38, 40, 42, 44, 46, 48, 52, 56, 60, 64, 100, 104, 108, 112, 116, 120, 124, 128, 132, 136, 140, 144, 149, 153, 157, 161, 165)

Modulation

- **802.11a:** BPSK (6 and 9 Mbps), QPSK (12 and 18 Mbps), 16 QAM (24 and 36 Mbps), 64 QAM (48 and 54 Mbps), OFDM
- **802.11n/ac:** BPSK (MCS0), QPSK (MCS1 and MCS2), 16 QAM (MCS3 and MCS4), 64 QAM (MCS5, 6, and 7), OFDM
- **802.11ac:** 256 QAM (MCS8 and MCS9), OFDM

- **802.11b:** DBPSK, BPSK (1 and 2 Mbps), QPSK (2 Mbps), CCK (5.5 and 11 Mbps)
- **802.11g:** BPSK (6 and 9 Mbps), QPSK (12 and 18 Mbps), 16 QAM (24 and 36 Mbps), 64 QAM (48 and 54 Mbps), OFDM

Bluetooth v5 and BLE

- **Frequency Range:** 2.402 – 2.480 GHz
- **Max TX power:** 14 dBm (4 dBm BLE)

External Directional Antenna Accessory

- Minimum gain: 6.4 dBi peak in the 2.4-GHz band, 8.9 dBi peak in the 5-GHz band, and 8.6 dBi peak in the 6 GHz band.
- Reverse-polarity SMA plug
- Antenna frequency range: 2.4 – 2.5, 4.9 – 5.9 GHz, 6.0 – 7.1 GHz
- External antenna port is receive-only (no transmit).

Environmental Specifications

Operating Temperature	32°F to 113°F (0°C to +45°C) NOTE: The battery will not charge if the internal temperature of the unit is above 113°F (45°C).
Operating relative humidity (% RH without condensation)	90% (50°F to 95°F; 10°C to 35°C) 75% (95°F to 113°F; 35°C to 45°C)
Storage Temperature	-4°F to 140°F (-20°C to +60°C)
Shock and vibration	Meets the requirements of MIL-PRF-28800F for Class 3 Equipment
Safety	IEC 61010-1:2010: Pollution degree 2
Altitude	Operating: 4,000 m; Storage: 12,000 m
EMC	IEC 61326-1: Basic Electromagnetic Environment CISPR 11: Group 1, Class A

Certifications and Compliance Statements

⚠ CAUTION: Changes or modifications not expressly approved by the party responsible for compliance could void the user's authority to operate the equipment.



Complies with 47 CFR Part 15 requirements of the U.S. Federal Communications Commission.



Conforms to relevant Australian Safety and EMC standards.



Listed by the Canadian Standards Association.



Conforms to relevant European Union directives.



Complies with United Kingdom and European Economic Area radiation

exposure limits.



FCC Notices

Contains FCC IDs

RYK-WNFQ268AXB
T, WA7-9377

Contains IC IDs

6158A-WNFQ268AXB
T, 6627C-9377

This equipment has been tested and found to comply with the limits for a class B digital device, pursuant to part 15 of the FCC Rules. These limits are designed to provide reasonable protection against harmful interference in a residential installation. This equipment generates, uses and can radiate radio frequency energy and if not installed and used in accordance with the instructions, may cause harmful interference to radio communications. However, there is no guarantee that interference will not occur in a particular installation. If this equipment does cause harmful interference to radio or television reception, which can be determined by turning the equipment off and on, the user is encouraged to try to correct the interference

by one or more of the following measures:

- Reorient or relocate the receiving antenna.
- Increase the separation between the equipment and receiver.
- Connect the equipment into an outlet on a circuit different from that to which the receiver is connected.
- Consult the dealer or an experienced radio/TV technician for help.

Caution: Any changes or modifications made to the equipment without the approval of manufacturer could void the user's authority to operate this equipment.

The device is for indoor use. This equipment may only be operated indoors. Operation outdoors is in violation of 47 U.S.C. 301 and could subject the operator to serious legal penalties.

The operation of this device is prohibited on oil platforms, cars, trains, boats, and aircraft, except that operation of this device is

permitted in large aircraft while flying above 10,000 feet. Operation of transmitters in the 5.925-7.125 GHz band is prohibited for control of or communications with unmanned aircraft systems.

Warning: FCC Radiation Exposure Statement: This equipment complies with FCC radiation exposure limits set forth for an uncontrolled environment. This equipment should be installed and operated with a minimum distance of 25 cm between the radiator and your body.



Australian IEC 61326-1:2013: Basic Electromagnetic Environment; CISPR 11: Group 1, Class A

Group 1: Equipment has intentionally generated and/or uses conductively-coupled radio frequency energy that is necessary for the internal function of the equipment itself.

Class A: Equipment is suitable for use in all

establishments other than domestic and those directly connected to a low-voltage power supply network that supplies buildings used for domestic purposes. There may be potential difficulties in ensuring electromagnetic compatibility in other environments due to conducted and radiated disturbances.



Innovation, Science and
Economic Development Canada

Innovation, Sciences et
Développement économique Canada

Warning: For indoor use only. Pour une utilisation en intérieur uniquement. This device complies with Industry Canada license-exempt RSS standard(s). Operation is subject to the following two conditions: (1) this device may not cause interference, and (2) this device must accept any interference, including interference that may cause undesired operation of the device.

Le présent appareil est conforme aux CNR d'Industrie Canada applicables aux appareils radio exempts de licence. L'exploitation est autorisée aux deux conditions suivantes: (1) le dispositif ne doit pas produire de brouillage

préjudiciable, et (2) ce dispositif doit accepter tout brouillage reçu, y compris un brouillage brouillage susceptible de provoquer un fonctionnement indésirable.

Warning: IC Radiation Exposure Statement:

This equipment complies with RSS-102 radiation exposure limits set forth for an uncontrolled environment. This equipment should be installed and operated with minimum distance 27 cm between the radiator & your body.

Avertissement: Cet équipement est conforme aux limites d'exposition aux rayonnements RSS-102 établies pour un environnement non contrôlé. Cet équipement doit être installé et utilisé avec une distance minimale de 20 cm entre le radiateur et votre corps.

Caution: The device for operation in the band 5150-5530 MHz is only for indoor use to reduce the potential for harmful interference to co-channel mobile satellite systems.

Avertissement: les dispositifs fonctionnant

dans la bande 5150-5530 MHz sont réservés uniquement pour une utilisation à l'intérieur afin de réduire les risques de brouillage préjudiciable aux systèmes de satellites mobiles utilisant les mêmes canaux.

This radio transmitter has been approved by Innovation, Science and Economic Development Canada to operate with the antenna types listed in the SparkLAN WNFQ-268AXI(BT) Datasheet, with the maximum permissible gain indicated. Antenna types not included in this list that have a gain greater than the maximum gain indicated for any type listed are strictly prohibited for use with this device.

Cet émetteur radio a été approuvé par Innovation, Sciences et Développement économique Canada pour fonctionner avec les types d'antennes répertoriés dans la fiche technique SparkLAN WNFQ-268AXI(BT), avec le gain maximal autorisé indiqué. Les types d'antenne non inclus dans cette liste qui ont un gain supérieur au gain maximum indiqué

pour tout type répertorié sont strictement interdits pour une utilisation avec cet appareil.



European Union (EU) Radiation Warning Statement and Con- formance Notices

Warning: This equipment complies with EU radiation exposure limits set forth for an uncontrolled environment. This equipment should be installed and operated with a minimum distance of 20 cm between the radiator and your body.

Selling Countries:

 Restrictions or requirements in the UK	AT BE BG HR CY CZ DK
	EE FI FR DE EL HU IE
	IT LV LT LU MT NL PL
	PT RO SK SI ES SE UK (NI)

This device complies with the following EU Directives: Directives 2014/53/EU, 2014/35/EU,

and 2014/30/EU.

Accessory Information:

Adapter Model No.: FSP045-A1BR

Input: AC 100-240 V, 50/60 Hz 1.2 A

Output: DC 15 V, 3 A

Japan Indoor Use Statement

For Japan, the AirCheck G3 is restricted for indoor use in the 5150-5530 MHz band only.

Taiwan Regulatory Statement

Article 12: For low-power RF motors that have passed the type certification, companies, firms or users are not allowed to change the frequency, increase the power, or change the features and functions of the original design without permission.

第十二條 經型式認證合格之低功率射頻電機，非經許可，公司、商號或使用者均不得擅自變更頻率、加大功率或變更原設計之特性及功能。

Article 14: The use of low-power radio frequency motors shall not affect flight safety or interfere with legal communications; if any interference is found, it shall be stopped immediately, and it shall be continued to be used until there is no interference. The legal communication referred to in the preceding paragraph refers to the radio communication operated in accordance with the provisions of the Telecommunications Law. Low power radio frequency motors are subject to interference from legal communications or radio wave radiating electrical equipment for industrial, scientific and medical use.

第十四條低功率射頻電機之使用不得影響飛航安全及干擾合法通信；經發現有干擾現象時，應立即停用，並改善至無干擾時方得繼續使用。前項合法通信，指依電信法規定作業之無線電通信。低功率射頻電機須忍受合法通信或工業、科學及醫療用電波輻射性電機設備之干擾。

Wireless information transmission equipment operating in the 5.25-5.35 kHz frequency band

is limited to indoor use.

在5.25-5.35 兆赫頻帶內操作之無線資訊傳輸設備，限於室內使用。



Complies with United Kingdom and European Economic Area radiation exposure limits

This equipment complies with the UK and EEA radiation exposure limits set forth for an uncontrolled environment. This equipment should be installed and operated with a minimum distance of 20 cm between the radiator and your body. The frequency and the maximum transmitted power in the UK and European Conformity are listed below:

2402-2480 MHz (LE) 9.63 dBm

2405-2480 MHz 9.81 dBm

2412-2472 MHz 19.96 dBm

5180-5240 MHz 22.95 dBm

5260-5320 MHz 22.98 dBm

5500-5700 MHz 22.98 dBm

5745-5825 MHz 22.98 dBm

5955-5825 MHz 22.98 dBm

5955-6415 MHz 22.97 dBm

6489-7987.2 MHz -41.58 dBm/RBW

The device is restricted to indoor use only when operating in the 5295 to 6425 MHz frequency range.

Hereby, NetAlly declares that the radio equipment AirCheck G3 is in compliance with Radio Equipment Regulations 2017.
