



Empowering you to work smarter

N2DX Flex-X Manifold Gauge with HD Color Graphic Interface

User Manual



NAVAC Inc.
www.NavacGlobal.com
Tel/Fax: +1 877 MY-NAVAC
877 696 2822
MADE IN PRC



Failure to follow warnings could
result in death or serious injury.

**SAVE THIS MANUAL
FOR FUTURE REFERENCE**

CONTENTS

I. Safety Information	01
II. Product Overview	02
III. Technical Specification	02
IV. Screen Display	03
V. Indicator Icons	04
VI. Pressure Calibration&Alarm	04
VII. Device Standby/Off	04
VIII. Button Function	05
IX. Exploded View	06

I. Safety Information

Use this instrument only as specified in this manual. Failure to do so may impair the protection provided by the instrument.

Follow these safety guidelines to avoid personal injury or death:

- Most governments and legal authorities require HVAC technicians to be trained and certified in the safe and proper operation of HVAC tools, such as this instrument. Since this tool may be connected to various types of equipment through an unlimited combination of hoses and fittings, proper training is crucial for the safe operation of this tool.
- Read the entire user manual before using the instrument.
- Use the instrument only as described in the user manual. Failure to do so may impair the protection provided by the equipment.
- Do not use the instrument if it is damaged. Before using the instrument, inspect the case for any cracks or loose components.
- The instrument contains no internal, user-serviceable parts. Do not open the instrument.
- Do not use the instrument if it operates abnormally, as this may impair its protection. If in doubt, have the instrument serviced.
- Do not operate the instrument near explosive gases, vapor, or dust.
- The refrigerant database in this unit may include refrigerants classified as flammable. If such refrigerants are selected, the operator may require additional certifications and/or training. Consult your government and legal authority and fully comply with all requirements.
- Always wear eye and skin protection when working with refrigerants. Escaping refrigerant vapors can present a freezing danger. Never direct refrigerant vapors venting from hoses toward the skin.

Warning

This product operates under high pressure. Follow all safety guidelines regarding refrigerant handling including wearing Personal Protective Equipment such as safety glasses, and gloves.

II. Product Overview



III. Technical Specification

Model	N2DX				
Pressure units	MPa, KPa, bar, psi, kgf/cm ²				
Temperature units	°C, °F				
Pressure measuring range	-1~50 bar	-0.1~5 MPa	-100~5000 KPa	-14.5~725 psi	-1.02~51 kgf/cm ²
Resolution	0.01 bar	0.001 MPa	1 KPa	0.1 bar	0.01kgf/cm ²
Operating environment	-4 ~122°F				
Battery	3.7V, 3000mAh				
Connection port	1/4"				
Sensor	Analog Sensor				
72 Refrigerant Types	R-11, R-12, R-13, R-22, R-23, R-32, R-113, R-114, R-115, R-116, R-123, R-124, R-125, R134a, R-236fa, R-245fa, R-290, R-401A, R-401B, R-402A, R-402B, R-403B, R-404A, R-406A, R-407A, R-407B, R-407C, R-408A, R-409A, R-410A, R-413A, R-414A, R-414B, R-416A, R-417A, R-417C, R-420A, R-421A, R-421B, R-422A, R-422B, R-422C, R-422D, R-424A, R-427A, R-428A, R-434A, R-437A, R-438A, R-448A, R-449A, R-450A, R-452A, R-452B, R-453A, R-454B, R-458A, R-500, R-501, R-502, R-503, R-507A, R-508B, R-513A, R-600, R-600a, R-601, R-601a, R-744*, R-1233zd, R-1234yf, R-1234ze *Maximum pressure: 725 Psi (5000 Kpa)				



IV. Screen Display

Main interface:

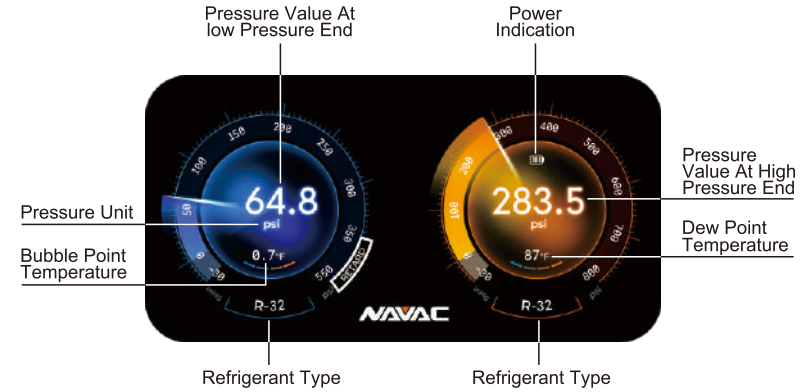



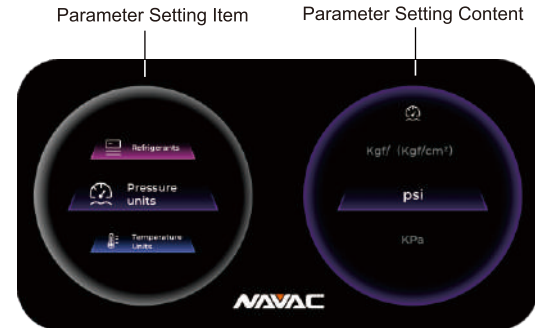



Parameter setting interface:



Parameter setting items	Parameter setting content
Refrigerant type	72 types of refrigerants, including R11, R22, etc.
Pressure units	Mpa, bar, kg/(kgf/cm ²), psi, Kpa (factory default psi)
Temperature units	°C, °F (factory default °F)
Shutdown settings	1 Hour/2 Hours/OFF (factory default 1H)
Always-on settings	2min/5min/10min/OFF (factory default 10min)
Version information	VER (hardware version): X.X.X (X stands for number) (X stands for number or English)

V. Indicator Icons

 : Device battery level (Pre-charging square flashes when charging)	 : Temperature units
 : Refrigerant type	 : Shutdown settings
 : Pressure units	 : Always-on settings
 : Version information	

VI. Pressure Calibration & Alarm

Pressure wheel display: When the pressure value is greater than 0, both the pressure pointer and pressure bar point upward, When the pressure value is less than 0, both the pressure pointer and pressure bar point downward.

Pressure calibration: If the pressure value is not 0 when the pressure is atmospheric, press and hold the knob to reset the pressure to zero.

Pressure failure alarm: If the pressure sensor fails, the low-pressure side will display "E1" and the high-pressure side will display "E2," both flashing. The temperature will display "--.-".

VII. Device Standby/Off

Auto shutdown: The device will automatically shut down when the pressure value reads 0, and the button is not operated. This will occur after reaching the set auto-shutdown time (factory default: 1 hour). In addition, the device will automatically shut down if the battery level is too low.

Auto screen off: If no buttons are pressed, and the pressure value stays at 0. When the set time is reached (factory default: 10 minutes), the device will automatically turn off the screen.

VIII. Button Function

The power button is on the left side of the device, while the knob button is on the right side.

Power on/off: Press and hold the power button for more than 2 seconds to turn on the device. When the device is on, press and hold the power button for more than 2 seconds to turn it off.

Parameter setting: Click the knob on the main interface to enter the parameter setting interface. You can select the parameter setting items and their contents by scrolling the knob. Click the knob to confirm the selected parameter setting items and contents.

Parameter setting interface:

- (1) The left side of the parameter setting interface displays the current parameter setting. The right side displays the content of the currently set parameter.
- (2) The initial selection cursor is located on the left side. By scrolling the knob up/down, the left parameter setting item will scroll up/down in a circular motion. The right parameter setting content will correspond to the selected option on the left. Click the power button to return to the main interface.
- (3) In the (2) interface, click the knob to select and enter the parameter content interface. Scroll the knob up/down to scroll the parameter content upward or downward in a circular motion.
- (4) In the (3) interface, click the knob to confirm the selected parameter content and return to the (2) interface.
- (5) Click the power button in the (3) interface. The selected parameter content will not be confirmed and will return to the (2) interface.

IX. Exploded View

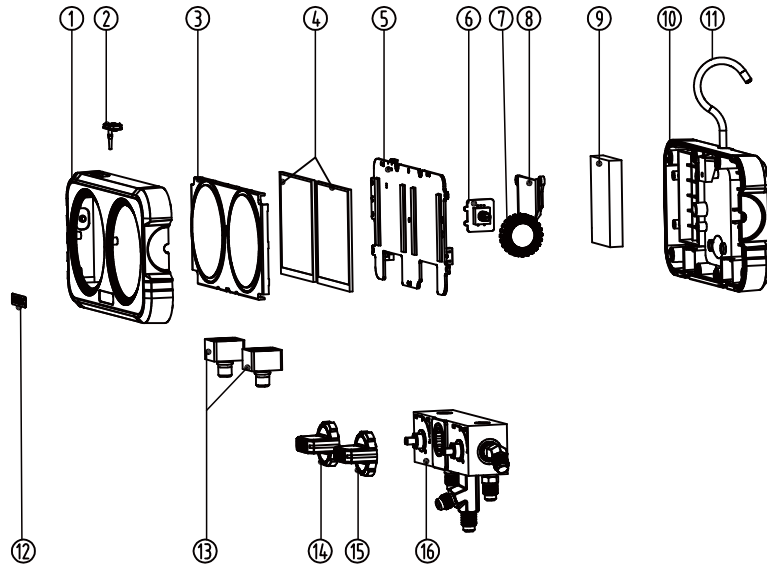

Spare Parts List

No.	Item
1	Front Case
2	USB Plug
3	Display Protector
4	Display
5	Main Board Assembly
6	Knob Switch Plate
7	Knob
8	Battery Mounting Plate
9	Battery Assembly
10	Backshell
11	Hook Assembly
12	Logo Nameplate
13	Sensor Assembly
14	Valve Body left knob Assembly
15	Valve Body right knob Assembly
16	Valve Body Assembly
