

A guide to low resistance testing

Megger®



Contents

INTRODUCTION	3
Brief history of low resistance ohmmeters	4
WHY MEASURE LOW RESISTANCE?.....	4
What is a low resistance measurement?	5
What does a low resistance measurement tell the user?	5
What problems create the need for a test?	5
Saving money by low resistance testing	5
Industries with significant resistance problems.....	6
What equipment needs low resistance testing	6
Motor armature	6
Automotive assembly	7
Power generation and distribution	7
Transformers.....	7
Uninterruptible power supply - battery straps	7
Cement plants and other raw material processing applications.....	8
Circuit breakers	8
Aircraft assembly.....	8
Strap and wire bonds between rail segments (railroad industry)	9
Graphite electrodes	9
Welding spot or seam	9
Cable reels	10
Measuring cable resistance of multicore cable of at least 3 cores.....	10
Using low resistance measurements to set torque.....	11

HOW IS LOW RESISTANCE MEASURED?.....	12
Two, three and four wire d.c. measurements	12
Two wire measurements.....	13
Three wire measurements	13
Four wire measurements	13
D.C. vs. A.C.	13
The difference between continuity and low resistance	14
Test modes	14
Models designed in the 1970s and 1980s.....	14
2 and 10 amp models.....	14
100 amp and above models	14
HOW DOES A LOW RESISTANCE OHMMETER OPERATE?	15
Safety	15
Test on de-energized samples	15
Use and misuse of low resistance ohmmeters	16
Current selection	16
Probe and lead selection	16
Low range tests	17
TYPES OF TESTERS - WHICH ONE?	17
Milli-ohmmeter	17
2 Amp micro-ohmmeter	18
10 Amp micro-ohmmeter	18
100 Amp and above micro-ohmmeter	18
Nominal vs. absolute test current levels.....	19
Auto range	19
Ingress protection.....	19

EVALUATION / INTERPRETATION OF RESULTS..... 21

Repeatability..... 21

Spot readings / base expectations for readings..... 21

Trending 21

 Circuit breakers 22

 Stand-by battery back-up systems 22

Measuring components of a system 23

High currents in low resistance measurement 24

Potential sources of error / ensure quality results 24

 Test leads / probes 24

 Accuracy statements 25

 Interference 25

 Delivery of stated test current under load 25

 Taking a measurement at a stable plateau 26

 Material resistivity 26

 Effects of temperature..... 26

 Effects of humidity..... 27

 Background noise, current and voltage 27

 Thermal emf / Seebeck voltage compensation 28

 Contact resistance contamination 28

 Noise ratio and induced currents..... 29

 Hot spots..... 29

Calibration in the field 29

APPENDICES..... 30

Testing of transformers.....30

Motor bar to bar tests.....30

Battery strap tests32

Ramp testing.....32

Wheatstone and kelvin bridges33

 Wheatstone bridge 33

 Kelvin bridge 33

DLRO microohm and milliohm applications lists34

MEGGER PRODUCTS OVERVIEW..... 36

DLRO2.....36

DLRO10 / DLRO10X.....37

DLRO10HD / DLRO10HDX37

Series 24700038

DLRO100.....38

DLRO200.....39

MOM2.....39

MJÖLNER200 / MJÖLNER60040

MOM200A / MOM600A40

DLRO600.....41

MOM690A 41

Duplex connect test lead system.....41

PRODUCT COMPARISON CHART 42

FIGURES

Fig 1: Qualitative Resistance Temperature Curve for Manganin.....	3
Fig 2: Bus bar connections	7
Fig 3: Single strap with two contact surfaces	7
Fig 4: Parallel straps on a large battery complex	8
Fig 5: Measuring carrier strip resistance	8
Fig 6: Test on graphite slugs for uniform density (ohms / inch)	9
Fig 7: Series of measurements across a weld seam.....	9
Fig 8: Determining the remaining length of cable on a reel	10
Fig 9: Conventional test, one kelvin at either end of a multi-core cable	10
Fig 10: The C2 and P2 shown as separate cables from a meter to one of the cores.....	11
Fig 11: C1 connected to an adjacent core on the same end of the multi-core cable	11
Fig 12: P1 connected to another core on the same end of the multi-core cable.....	11
Fig 13: The other end of the cable showing the unmarked core	11
Fig 14: Contact area reduced due to overtightening	12
Fig 15: Typical joints that should be tested	12
Fig 16: Typical faults that can be prevented by low resistance testing	12
Fig 17: Selection of optimum measuring technique	12
Fig 18: Simplified example of a 4 wire measurement.....	13
Fig 19: Basic operation diagram	15
Fig 20: ASTM standard B193-65.....	17
Fig 21: Probe / lead configurations	17
Fig 22: Trending analysis of low resistance readings.....	22
Fig 23: C1 clip being connected to end of circuit being tested	23
Fig 24: Duplex hand spike being used to perform same test as shown in Fig 23	23
Fig 25: Correct and incorrect probe placements	24
Fig 26: Basic styles of probes	25
Fig 27: Temperature resistance curves for iron, copper and carbon	27
Fig 28: Circuit breaker corrosion	29
Fig 29: Noise	29
Fig 30: Hot spots.....	29
Fig 31: Bar to bar test on d.c. motor rotor	30
Fig 32: Lap winding test data	31
Fig 33: Commutator with 24 coils in series	31
Fig 34: Wave winding test data.....	31
Fig 35: Wave winding coil arrangement.....	32
Fig 36: Single strap resistance target	32
Fig 37: Parallel strap resistance target	32
Fig 38: Wheatstone bridge circuit	33
Fig 39: Kelvin bridge circuit	33
Fig 40: DLRO2	36
Fig 41: DLRO10/DLRO10X	37
Fig 42: DLRO10HD	37
Fig 43: DLRO247000	38
Fig 44: DLRO100 Series.....	38
Fig 45: DLRO200	39
Fig 46: MOM2	39
Fig 47: MJÖLNER200	40
Fig 48: MJÖLNER600	40
Fig 49: MOM200A / MOM600A	40
Fig 50: DLRO600	41
Fig 51: MOM690A	41
Fig 52: Duplex connect test leads.....	41

Introduction

The quantitative study of electrical circuits originated in 1827, when Georg Simon Ohm published his famous book 'Die galvanische Kette, mathematisch bearbeitet' in which he gave his complete theory of electricity. In this seminal work, he introduced the relationship or 'Law' that carries his name:

$$Resistance (R) = Voltage (E) / Current (I)$$

At that time, the standards for Voltage, Current and Resistance had not been developed. Ohm's Law expressed the fact that the magnitude of the current flowing in a circuit depended directly on the electrical forces or pressure and inversely on a property of the circuit known as the resistance. Obviously, however, he did not have units of the size of our present Volt, Ampere, and Ohm to measure these quantities.

At this time, laboratories developed resistance elements, constructed of iron, copper or other available alloy materials. The laboratories needed stable alloys that could be moved from place to place to certify the measurements under review. The standard for the ohm had to be temperature stable and with minimum effects due to the material connected to the ohm standard.

In 1861, a committee was established to develop a resistance standard. This committee included a number of famous men with whom we are now familiar, including James Clerk Maxwell, James Prescott Joule, Lord William Thomson Kelvin and Sir Charles Wheatstone¹. In 1864, a coil of platinum-silver alloy wire sealed in a container filled with paraffin was used as a standard. This was used for 20 years while studies were made for a more reliable standard. These studies continued as the old National Bureau of Standards (NBS), now known as the National Institute of Standards and Technology (NIST), controlled the standard for the 'Ohm'. Today the industry uses Manganin alloy because it has a low temperature coefficient so that its resistance changes very little with temperature. Melvin B. Stout's 'Basic Electrical Measurements' highlights the key properties of Manganin.

Table 1: Key properties of Manganin

Composition %	Resistivity		Temperature Coefficient per °C	Thermal emf Against Copper $\mu\text{V}/^\circ\text{C}$
	Microhms for cm Cube	Ohms for Cir. mil Foot		
Cu 84% Mn 12% Ni 4%	44 $\mu\Omega$	264 Ω	* $\pm 0.00001^\circ$	1.7

*Manganin shows zero effect from 20° to 30° C.

The thermal emf against copper shows the thermocouple activity of the material whereby a voltage is generated simply by connecting two different metals together. The goal is to minimize thermocouple activity as it introduces error into the measurement.

With the metric system, the measurements are in meters and the resistivity is determined for a one meter cube of the material. However, more practical units are based on a centimeter cube. With the USA system, the resistivity is defined in ohms per mil foot. The wire diameter is measured in circular mils $(0.001)^2$ and the length in feet.

Fig 1 shows the temperature resistance curve for Manganin wire at 20 °C (68 °F). For Manganin shunts, the 20 °C curve shifts to 50 °C (122 °F), as this material will be operating at a higher temperature due to the application. The Manganin alloy was designed for use in coils used to do stable measuring conditions at 20 °C ambient room conditions.

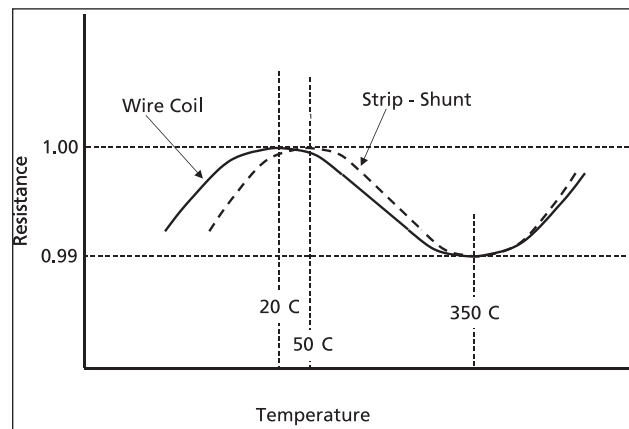

Fig 1: Qualitative Resistance Temperature Curve for Manganin³

A guide to low resistance testing

The alloy is modified for strips of material used in measuring shunts, which operate at a higher ambient, up to 50 °C.

The purpose of this booklet is to help the engineer, technician or user to understand:

- **The rationale behind low resistance tests**
- **How to make a low resistance measurement**
- **How to select the correct instrument for the test application**
- **How to interpret and use the results**

Brief history of low resistance ohmmeters

The original DUCTER™ low resistance ohmmeter¹ was developed by Evershed & Vignoles (one of the companies that evolved into Megger and the developer of the first insulation resistance tester) in 1908 and employed the cross-coils meter movement that was already used in the insulation resistance tester. This initial design evolved into field units in the 1920s that required a leveling procedure at the time of the test due to the sensitivity of the coil (to being level). These early models did not travel well and were sensitive to shock and vibration.

For fifty years, field portable low resistance ohmmeters were analog units. In 1976, in response to numerous customer requests, the James G. Biddle Company (another one of the companies that ultimately became Megger) developed and introduced a digital low resistance ohmmeter. This unit was known by its trade name, the DLRO. Ultimately, the James G. Biddle Company released 10 A and 100 A versions of the DLRO, including a single box design for some versions that simplified the test process, and an extended range model.

Through the acquisition of Programma Electric AB, Megger strengthened the program of high current low resistance ohmmeters's (LRO's).

Back in the late seventies the MOM (Micro Ohm Meter) was one of the first products developed by Programma Electric AB, and in the decades that followed that series has been supplemented with MJÖLNER and MOM2. The MJÖLNER moved from transformer based technology to switched technology, which has the benefit of a much lighter test instrument. The latest innovation is the MOM2, which uses a patented ultra capacitor technology to generate the high current, which makes it possible to get over 200 A in a hand held product that weighs less than 1 kg.

This style of instrument served the industry well for a number of years, and the various versions continue to help end users solve problems. However, electronics and battery technology advanced to the point where

¹ Basic Electrical Measurements; Melvin B. Stout; 1950; page 61.

a considerable number of improvements could be made to the 1970s designs. Newly designed low resistance ohmmeters by Megger include data storage and downloading capability, additional test modes, reduced weight, extended battery life, etc.

Why measure low resistance?

Measuring low resistance helps identify resistance elements that have increased above acceptable values. The operation of electrical equipment depends on the controlled flow of current within the design parameters of the given piece of equipment. Ohm's Law dictates that for a specified energy source, operating on V a.c. or V d.c., the amount of current drawn will be dependent upon the resistance of the circuit or component.

In the modern age of electronics, increased demands are placed on all aspects of electrical circuitry. Years ago the ability to measure 0.01 ohms was acceptable, but, in the present industrial electronic environments, the field test engineer is now required to make measurements, which show repeatability within a few microhms or less. These types of measurements require the unique characteristics of a low resistance ohmmeter's four wire test method, which is detailed in "Four wire measurements" on page 13.

Low resistance measurements are required to prevent long term damage to existing equipment and to minimize energy wasted as heat. They show any restrictions in current flow that might prevent a machine from generating its full power or allow insufficient current to flow to activate protective devices in the case of a fault.

Periodic tests are made to evaluate an initial condition or to identify unexpected changes in the measured values, and the trending of this data helps to indicate, and may forecast, possible failure conditions. Excessive changes in measured values point to the need for corrective action to prevent a major failure. When making field measurements, the user should have reference values that apply to the device being tested (the manufacturer should include this information in the literature or name plate supplied with the device). If the tests are a repeat of previous tests, then these records can also be used to observe the range of the anticipated measurements.

If, when conducting tests, the user records the results and the conditions under which the tests were done, the information becomes the start of a database that can be used to identify any changes from fatigue, corrosion, vibration, temperature or other condition that can occur at the test site.

What is a low resistance measurement?

A low resistance measurement is typically a measurement below 1 Ohm. At this level it is important to use test instruments that will minimize errors introduced by the test lead resistance and / or the contact resistance between the probe and the material under test. Also, at this level, standing

voltages across the item being measured (e.g. thermal electromotive forces (emfs) at junctions between different metals) can cause errors, which need to be identified.

To allow a measurement to compensate the errors, a four terminal measurement method is employed with a reversible test current and a suitable Kelvin Bridge meter. Low resistance ohmmeters are designed specifically for these applications. In addition the upper span on a number of these meters will range into kilohms, which covers the lower ranges of a Wheatstone bridge (see "Wheatstone and Kelvin bridges" on page 32 for a discussion of each method). The lower range on many low resistance ohmmeters will resolve 0.1 microhm. This level of measurement is required to do a number of low range resistance tests.

What does a low resistance measurement tell the user?

Resistance (R) is the property of a circuit or element that determines, for a given current, the rate at which electrical energy is converted to heat in accordance with the formula $W=I^2R$. The practical unit is the ohm. The low resistance measurement will show to the observant user when degradation has or is taking place within an electrical device.

Changes in the value of a low resistance element are one of the best and quickest indications of degradation taking place between two contact points. Alternatively, readings can be compared to 'like' test specimens. These elements include rail bonds, ground bonds, circuit breaker contacts, switches, transformer windings, battery strap connections, motor windings, squirrel cage bars, bus bar with cable joints and bond connections to ground beds.

The measurement will alert the user to changes having taken place from the initial and / or subsequent measurements. These changes can occur from a number of influences including temperature, chemical corrosion, vibration, loss of torque between mating surfaces, fatigue and incorrect handling.

These measurements are required on a regular timed cycle to chart any changes taking place. Seasonal changes may be evident when summer and winter data are reviewed.

What problems create the need for a test?

Assuming a device has been correctly installed in the first place, temperature, cycling, fatigue, vibration and corrosion all work to cause the gradual degradation of the resistance value of an electrical device. These influences build up over a period of time until a level is reached at which the device no longer operates correctly. The critical degrading factor will be determined by the application.

Environmental and chemical attacks are relentless. Even air will oxidize organic materials while the ingress of moisture, oil and salt will degrade connections even more rapidly. Chemical corrosion can attack the cross sectional area of an element, reducing the area while increasing the resistance of the component. Electrical stresses, particularly sustained overvoltages or impulses, can cause welds to loosen. Mechanical stress from vibration during operation can also degrade connections, causing resistance to rise. These conditions result in excessive heating at the location when the component is carrying the rated current, based on the formula $W=I^2R$. For example:

6000 A across a 1 $\mu\Omega$ bus = 36 Watts.

*6000 A across a 100 m Ω bus = 3,600 kWatts,
which will result in excessive heating.*

If left unattended, these types of problems can lead to failure in the electrical system containing the affected components. Excessive heating will ultimately result in failure due to burnout, which can open an energized circuit.

Backup battery power supplies provide a good practical example of how degradation can occur under normal operating conditions. Changes in current flow cause expansion and contraction of the terminal connections, causing them to loosen or corrode. Additionally, connections are exposed to acid vapors, causing further degradation. These conditions result in a decrease in the surface-to-surface contact area with an associated increase in surface-to-surface contact resistance, ultimately causing excessive heating at the junction.

Saving money by low resistance testing

If you think about it, a joint that carries current will heat up over time. The amount of heat is dependent on the resistance of the connection and the amount of current it carries and also the amount of time!

A guide to low resistance testing

So obviously a joint or cable connection which becomes hot will only ever become hotter until, if you are lucky, it is identified by thermal imaging, and if you are not so lucky, when the lights go out as the connection burns out and the protective device operates.

But what if you can't use thermal imaging because there is no direct line of sight to the connections. These can cook away deep inside a panel and not be spotted until it's too late.

Critical supplies fail regularly because of overheating connections due to high resistance connections burning out. Because of their critical nature, this makes regular isolation and maintenance almost impossible.

Think about hospitals and data centers. Health and data are probably two of the most critical but vulnerable installations but get the least downtime for maintenance of enclosed switchgear assemblies and panel busbar systems.

Using the formula $W=I^2R$ we can estimate the power lost over a connection or connections.

For a 10kA joint/s with a 0.1mΩ resistance, the power is 10kW.

For a 10kA joint/s with a 1mΩ resistance, the power is 100kW.

For a 6kA joint/s with a 0.1μΩ resistance, the power is 36W.

For a 6kA joint/s with a 100mΩ resistance, the power is 3600kW.

Simply, the power manifests itself as heat.

Using a DLRO to check the contact resistance of switchgear, lapped joints on busbars and cable lug connections before the power is switched on is the only sure way to prevent poor connections becoming potentially catastrophic failures.

Industries with significant resistance problems

Industries that consume vast amounts of electrical power must include low resistance ohmmeter measurements in their maintenance operations. Not only does abnormally high resistance cause unwanted heating, possibly leading to danger, but it also causes energy losses, which increase operating costs; in effect you are paying for energy which you can not use.

In addition, there are industries that have critical specifications on bond connections to ensure solid connections to 'ground beds.' Poor connections reduce the effectiveness of the ground bed and can cause significant power quality related problems and / or catastrophic failure in the event of major electrical surge. A number of sub-assembly operations supply components to aircraft manufacturers that specify low resistance connections to the airframe. Strap connections between cells on a power back-up battery system also require very low resistance.

A general list of industries include:

- **Power generation and distribution companies**
- **Chemical plants**
- **Refineries**
- **Mines**
- **Railroads**
- **Telecommunications companies**
- **Automotive manufacturers**
- **Aircraft manufacturers**
- **Anyone with UPS battery back-up systems**

What equipment needs low resistance testing

As we have shown, low resistance ohmmeters have an application in a wide range of industries, and can help identify a number of problems that could lead to apparatus failure. In general manufacturing industries, motor windings, circuit breakers, bus bar connections, coils, ground bonds, switches, weld joints, lightning conductors, small transformers and resistive components all require testing for low resistance.

The following are some of the more typical applications.

Motor armature

Armature windings can be tested to identify shorting between adjacent coils or conductors. Squirrel cage bars in the rotor can separate from the end plates, resulting in loss of performance. If a motor seems to be losing power, a low resistance test should be done. Alternatively, tests can be made when bearings are being replaced at a periodic or annual shutdown.

■ **Motor bar to bar tests**

Motor bar to bar tests on d.c. motor rotors are done to identify open or shorted coils. These tests are done with spring loaded hand probes. This is a dynamic method to determine the conditions of the windings and the soldered connections to the riser on the commutator segments. When test data is reviewed periodically, the effects of overheating due to excessive temperature rise can be identified.

For more detailed information, see 'motor bar to bar tests' section' in Appendices.

Automotive assembly

Cable leads in a 'robot' spot welder can harden through continual flexing. Eventually fatigue can occur, causing strands to break. This condition results in a high lead resistance with loss of power to the weld, producing a poor spot weld (nugget) or even complete failure of the machine.

Power generation and distribution

High current joints, connections and bus bars

Bus bars in a power system consisting of lap joints and other connections, are used to deliver current to the elements in the system. These bolted connections can be degraded by vibration and corrosion (see Fig 2). The bolts are stressed to a specific tightness (torque), and the quickest and most economical way to determine the quality of the connection is to measure the resistance across the joint. The user should have historical data to make a determination on the suitability of the connection. If left uncorrected, loss of power and / or excessive heating could lead to a meltdown at the connection.

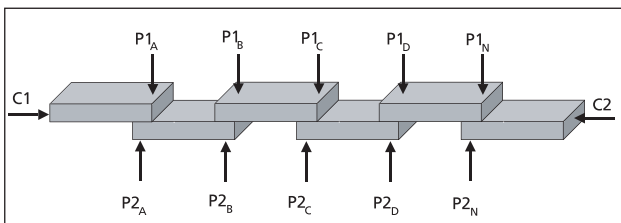

Fig 2: Bus bar connections

Transformers

Transformer winding tests are done in the factory and then periodically in the field. The factory test is done at ambient temperature. A second factory test is a heat run to check that, at rated power, the resistance of the windings stays within its designed temperature rise characteristics.

Large transformers have 'taps' on both the primary and secondary windings. The condition of the taps requires verification, since the secondary taps are operated daily and are exposed to excessive wear and vibration as the power distribution system balances the load carried on the various circuits. The taps on the primary side are critical to major adjustments in the power distribution and should be tested to ensure that a low resistance connection is available for the new power condition. Tap connections can corrode when not in use and can overheat due to the high current (which can result in a fire).

For more detailed information, see 'testing of transformers' section in Appendices.

Uninterruptible power supply - battery straps

On series connected industrial batteries, straps (lead coated copper bars) are secured to the posts on adjacent batteries, (+) to (-), with stainless steel bolts. These surfaces are cleaned, greased and tightened to a preset torque value. As noted previously, they are subject to vibration, chemical corrosion and heat due to the charging and high current discharges associated with the application. The quickest and best way to determine the quality of the connections is to measure the resistance between the two adjacent battery terminals (see Fig 3 and 4).

This is the only field application in which the user makes measurements on an energized system. For more detailed information, see 'battery strap test' section in Appendices.

Please note that there are various levels of 'float current' in a battery system and the test procedure must account for this current flow. A test is done with the test current added to the float current and a second test is made with the test current opposed to the float current. These two measurements are averaged to determine the 'ohmic' value of the connection.

Standard procedures require measurements on a regular schedule, as past experience has determined that battery straps are one of the weakest elements in the operation of a battery system. When not attended to on a regular test program, high resistance connections can develop. This situation can result in the battery being unable to deliver sufficient current when called for, or when combined with current surge and hydrogen gas evolved from the battery cells, can cause a fire in the battery system, destroying the UPS.

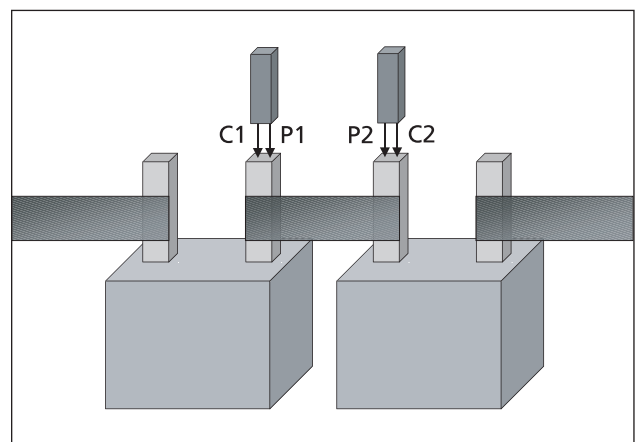

Fig 3: Single strap with two contact surfaces

A guide to low resistance testing

Carrier strips 'carry' the plates in a cell. The plates are suspended from the carrier strips into the liquid in the cell. If the resistance of the terminal to carrier strip welds is too high, the battery's ability to carry current is limited. In addition to measuring strap resistance, a low resistance ohmmeter can also be used to measure the quality of these welds (see Fig 5).

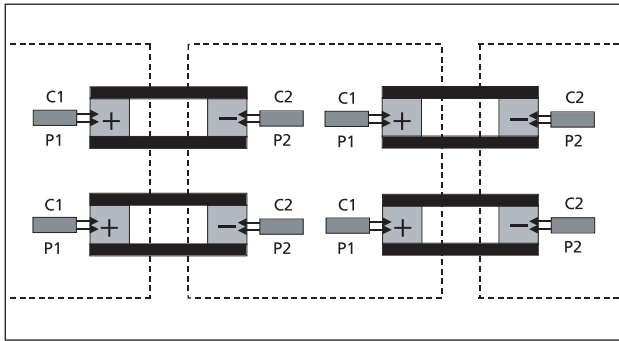

Fig 4: Parallel straps on a large battery complex

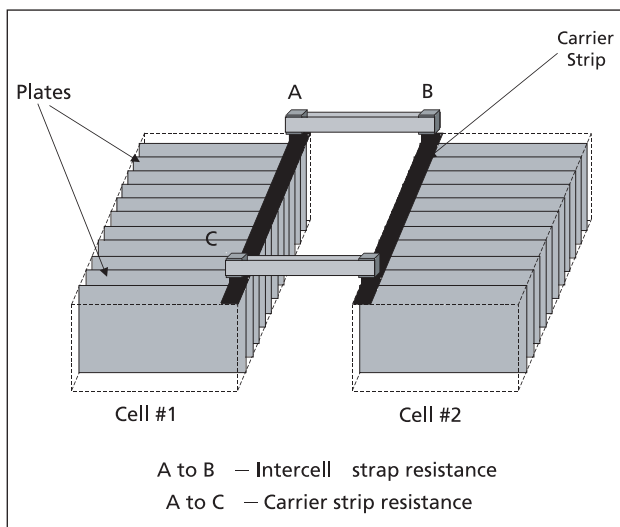

Fig 5: Measuring carrier strip resistance

Cement plants and other raw material processing applications

The electrical system at a cement plant or other raw materials processing facility includes motors, relays, disconnect switches, etc. Tests of these power carrying elements, as part of a regular program or when major retrofits take place, is critical to the ongoing operation of the plant. The quality of the current connections can identify weak elements or connections in the system.

Note: Cement dust is chemically active (corrosive) and will attack metallic connection.

Circuit breakers

Due to arcing at the pads of a circuit breaker, carbonized layers can build up and the live contact area will reduce or become pitted, leading to increased resistance and heating. This situation reduces the efficiency of the circuit breaker and can lead to failure on an active transmission system resulting in the loss of a substation. When planning a test, the user must be aware of IEC62271-100 (minimum 50 A) ANSI and ANSI C37.09 (minimum 100 A) for test current requirements. When tests are done on large oil circuit breakers, the best instrument is one that ramps up current, holds it for a period of time and then ramps down (see "Ramp testing" on page 31).

When d.c. is run through a circuit with a Current Transformer (CT), the CT will be magnetized. The problem caused is that the positive flank in the d.c. can cause a transient that might trip the relay. A d.c. with a large ripple is particularly problematic.

Care should be taken when making a measurement across a CT as high d.c. currents can saturate the CT, desensitizing it to potential faults. Also, a ripple on the test current can cause circuit breakers to trip.

Careful positioning of the current probes should prevent this from happening, and the ripple present on the current waveform may be minimized by separating the test leads. Alternatively use a test set with a ramp feature and smoothed d.c.

Aircraft assembly

Bonding test of all main frame electrical and mechanical connections is required to ensure a stable 'ground plane' within an aircraft. These physical 'bond' connections provide a uniform path for static electricity to be discharged to the wicks on the trailing edge of the wings and tail assembly. This path reduces the chance of lightning damaging the avionics in the event of a lightning strike situation.

Over time, the bonding of static wicks, antenna, control linkage and battery terminals must be inspected. The integrity of a welded exhaust system should also be checked and documented.

In normal operations, excessive static electricity will not effect the operation of most navigation and communications systems. The best (lowest) resistance connections will improve the performance of such systems.

Strap and wire bonds between rail segments (railroad industry)

In the railroad environment, bonds are exposed to vibration as the wheels pass over the rails (each click-clack causes vibration across the interface bonding the strap to the rail). These bonds are part of the control system which tells the user the location of different trains. Within the rail system, a telephone system uses the rail conductors to communicate. The resistance of these bonds is critical to the performance of the control system. In systems that use three rails, the third rail is the active source of power for the engine, and power lost across a high resistance bond (such as a poor Cadweld joint) reduces the efficiency of the transit system. The user can select a five foot section of track without a bond, make a measurement and then measure a five foot section with a bond to determine the quality of the connection. As a rule of thumb, these measurements should be within a few microhms (or $\pm 5\%$).

Graphite electrodes

Graphite electrodes have a negative temperature characteristic (as the temperature of the element increases the resistance measurement will decrease). Graphite slugs are extruded as large diameter cylinders and can be up to six feet in length. One of the applications for these large slugs is in aluminum refineries where high currents (150,000 A) are used to reduce bauxite ore to high grade aluminum.

Low resistance tests are done as a quality control step to check the density of the graphite extrusion. Due to the size of the electrodes, this test requires a special test fixture to introduce the test current across the surface of the ends, ensuring a uniform current density through the volume of the sample. The potential probes are then connected across a known length of the sample to determine the 'ohms per unit length' (see Fig 6).

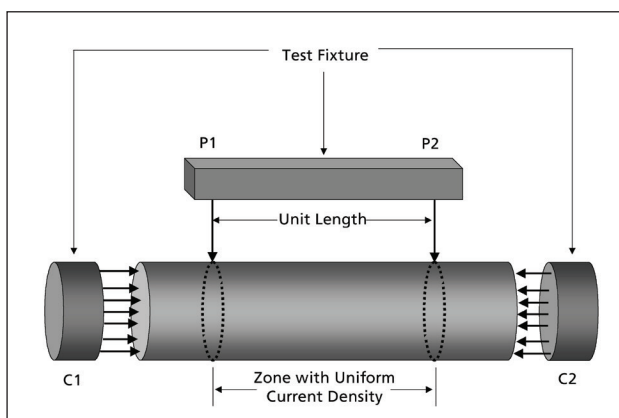

Fig 6: Test on graphite slugs for uniform density (ohms / inch)

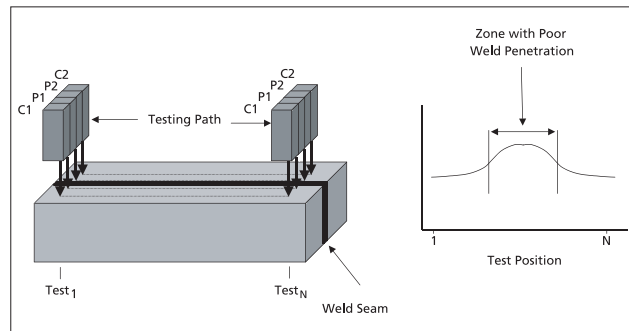

Fig 7: Series of measurements across a weld seam

Welding spot or seam

The quality of a spot weld can be determined by measuring the resistance across the joined materials. The quality of a seam weld can be determined by a series of tests along the weld seam. Readings should stay within a narrow band of values. An increase and then a drop in readings shows that the uniformity of the weld is out of specification. To make the measurement correctly, the user should fabricate a fixture to keep the probes in a fixed relationship. Readings are then taken at a number of points across the weld seam and plotted (see Fig 7). These measurements are normally in the microhm region and special care is required in the design of the test fixture.

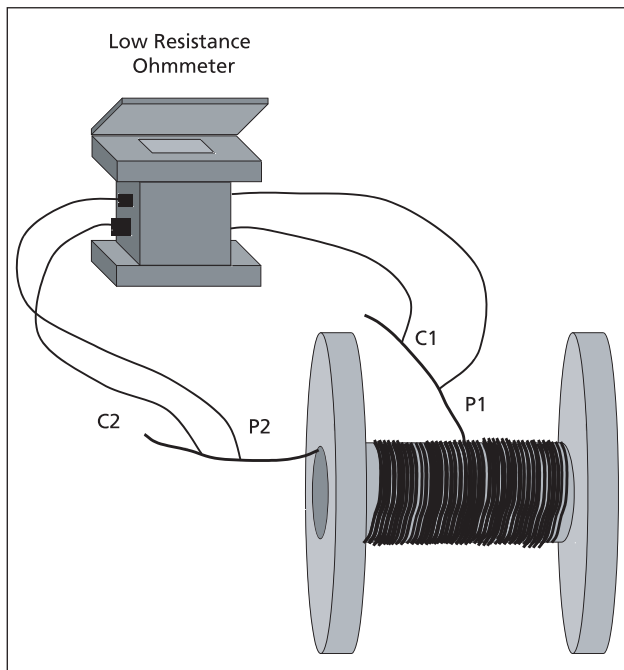

Fig 8: Determining the remaining length of cable on a reel

Cable reels

A reel of insulated copper wire may have a tag, which shows the wire gauge along with the ohms per unit length. When wire remains on the reel after partial utilization, the remaining length can be calculated by measuring the resistance of the wire and making a calculation using the ohms per length specification (see Fig 8).

Alternatively, if the tag has been destroyed, the user can cut off a known length of wire, measure that sample and determine the ohms per length. This value can then be used with the reading taken when measuring the balance of wire on the reel to calculate the remaining length. The temperature of the reel of cable will be approximately the same as the temperature of the sample. Though the internal temperature of the reel can be slightly different, a reasonable estimate of the remaining length of cable can be calculated. If the user reviews the temperature charts in "Effects of temperature" on page 26, an estimate of the inaccuracy can be determined. This method also applies to aluminum and steel wires as long as the wire has an insulating coating to prevent shorting between adjacent loops of wire.

Measuring cable resistance of multicore cables of at least 3 cores

When measuring cable resistance, the standard method is to connect the current and potential lead at each end of the cable core to be tested (see Fig 9).

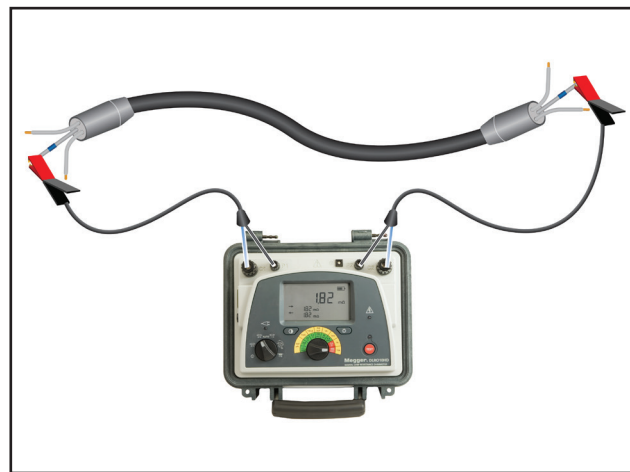

Fig 9: Conventional test, one kelvin at either end of a core of a multi-core cable

When the cable is too long to use extension test leads or passes through the floors of a building, the above method cannot be used. However, there is a way to configure the test leads to accurately measure the resistance of each core of the cable with the DLRO positioned at one end of the cable to be tested. The current and potential test leads must be connected individually and not as a single kelvin type connection.

Step 1: Connect the current and potential leads C2 and P2 to the core under test. In Fig 10 it is the core with the blue marker.

Step 2: Connect the current lead C to an adjacent core. In Fig 11 it is the unmarked core.

Step 3: Connect the potential lead P1 to the other core. In Fig 12 it is the core with the red marker.

Step 4: At the other end of the cable, connect core C1 to core 1 and core 3 to core 1 using short jumper cable ensuring that both the P connections are between the C connections..

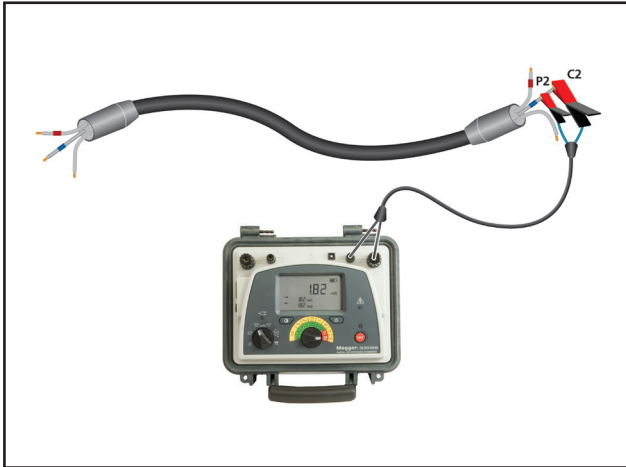

Fig 10: The C2 and P2 shown as separate cables from a meter to one of the cores

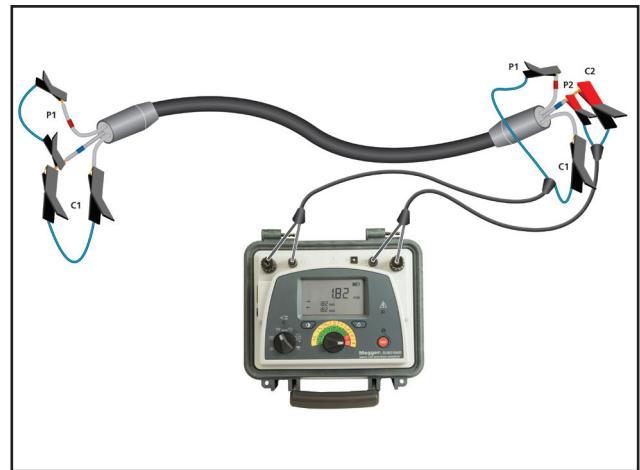

Fig 13: The other end of the cable shows the unmarked core carrying C1 connected to core with the blue marker (the core to be tested) and the core with the red marker carrying P1 connected to core with the blue marker (the core to be tested) the connections with short jumper cables

Using the simple configuration (see Fig 13) shows that the resistance of long multi-core cables can be measured by using 2 cores of the cable as part of the measuring circuit.

Using low resistance measurements to set torque

One application for the DLRO which is infrequently used is the use of low resistance measurements in the assembly of bolted components to a set torque.

When bus bar lapped joints or terminal lugs are overtightened, the material of the joint becomes dished and instead of becoming a better connection the resistance starts to increase as the surface area contact becomes distorted. This is why each joint and connection in a system normally has a manufacturer's torque setting.

But that's not the whole story. If the joint has some contamination when it is tightened to its torque setting, the higher resistance may go undiscovered and the connection begins a journey on the downward spiral to overheating, arcing and eventual failure.

But what if the connection does not have a manufacturer's torque setting? The DLRO can be used during tightening to ensure the resistance of the joint is at its optimal value before being made live and put to work.

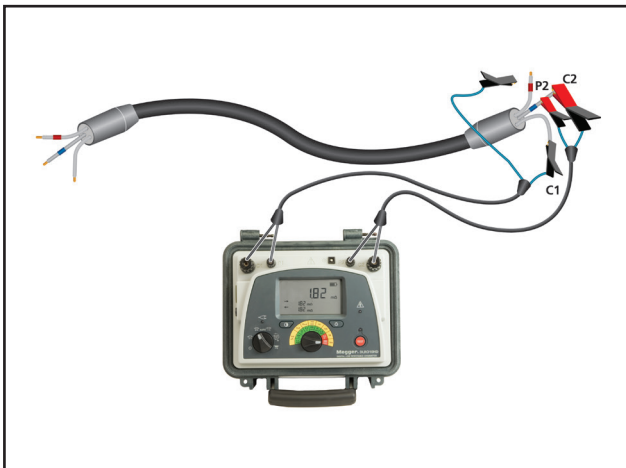

Fig 11: C1 connected to an adjacent core on the same end of the multi-core cable

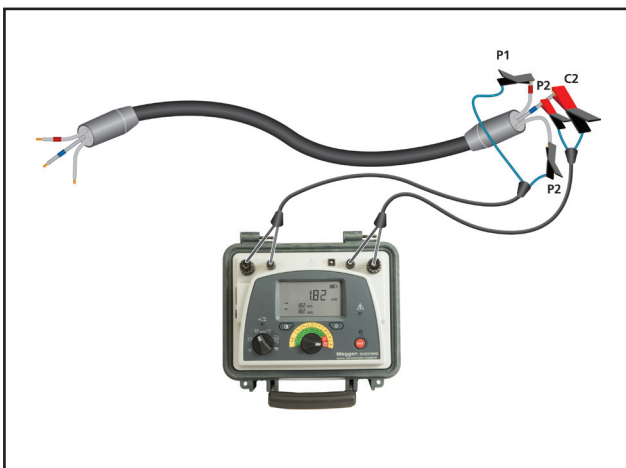

Fig 12: P1 connected to another core on the same end of the multi-core cable

A guide to low resistance testing

Single bolted connections have always had issues with the relationship between tightness and optimal surface area contact.

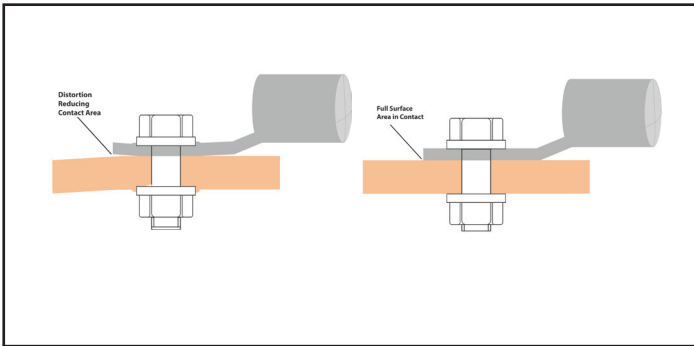

Fig 14: Contact area reduced due to overtightening

For this reason, and to increase the surface area contact, many panel and busbar systems use clamped, lapped or sandwich type joints (see Fig 14). In assemblies that are subject to excesses of heat and vibration, the issues discussed can become dramatic very quickly, which is why we see more use of elaborate locking mechanisms to maintain the contact resistance once set.

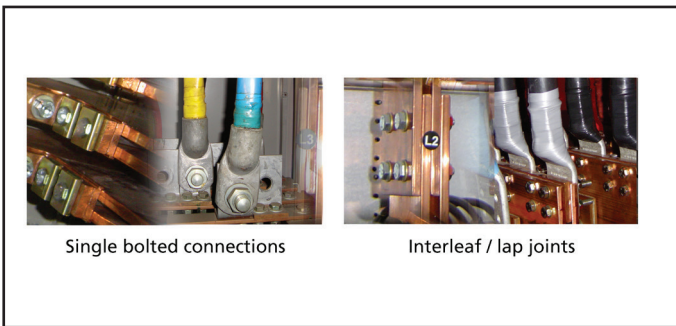

Fig 15: Typical joints that should be tested

Using a DLRO to measure the effectiveness of these types of connections (see Fig 15), the resulting data can be collected and using predictive maintenance techniques, trended over time to identify potential failures, in a joint or an assembly of connected parts by the early identification of a rise in resistance levels (see Fig 16).



Fig 16: Typical faults that can be prevented by low resistance testing

How is low resistance measured?

Two, three and four wire d.c. measurements

Why do we have resistance measuring instruments, some with only two test leads, some with three and even some with four test leads? The answer depends on the degree of information required from the measurement, and the magnitude of the resistance being measured. Resistance readings cover a wide range of values from microhms into the thousands of megohms region. Fig 17 shows the measurement range in which each type of instrument works best.

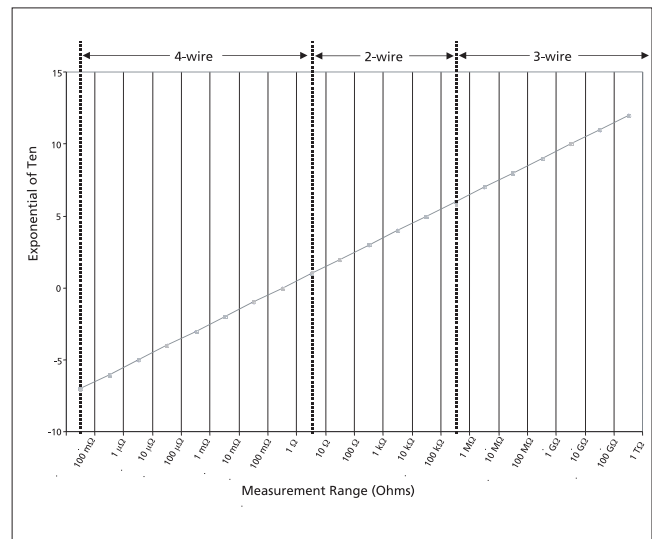

Fig 17: Selection of optimum measuring technique

Two wire measurements

Two wire tests are the simplest method and are used to make a general assessment of a circuit element, conductor or the routing of a conductor in a circuit. The two wire lead configuration is most familiar to many users as it is the configuration used on most multimeters. It is generally used when the probe's contact resistance, series lead resistance or parallel leakage resistances do not degrade the quality of the measurement beyond a point acceptable to the user.

The measured value will include the test lead wire resistance and contact probe resistance values, which will affect the measurement by adding some tens of milliohms to the actual resistance. In most instances this will make little practical difference to the measured value, but when the measurement is below 1 ohm the two wire method can easily introduce an error, which could be several percent, into the measured resistance value.

The specifications on some hand held meters show a 200 milliohm range with one milliohm sensitivity. The lead resistance can be zeroed out, but that leaves the uncertainty of the contact resistances, which can change with each measurement. Contact resistance values can be in the 35 milliohm range at each probe and can vary with the temperature of the material under investigation.

The two wire test method is best used for readings above 10.00 ohm up to 1.0 to 10.0 megohm.

Three wire measurements

Three wire d.c. tests are reserved for very high resistance and is typically used for measurements above 10 megohms. We normally associate these types of tests with diagnostic insulation resistance. The test method uses a third test lead as a guard, and allows for resistances, in parallel with the test circuit, to be eliminated from the measurement. This parallel resistance is usually considerably lower than the insulation resistance being measured. In fact it can, in severe cases, effectively short out the insulation resistance such that a meaningful measurement cannot be carried out without the use of a guarding circuit.

This test method is described and illustrated in the Megger booklets 'A Stitch in Time' and 'A Guide To Diagnostic Insulation Testing Above 1 kV'.

Four wire measurements

Four wire tests are the most accurate method when measuring circuits below 10 ohms as this method eliminates errors due to lead and contact resistances. This is the test method associated with low resistance ohmmeters. Four wire d.c. measurements uses two current and two potential leads (see Fig 18). The four wire d.c. measurement negates the

errors due to the probe lead wire and any contact resistance values in the final reading by moving the connection point of the high impedance voltage measurements from within the instruments to the actual test piece. This results in much more accurate resistance measurements..

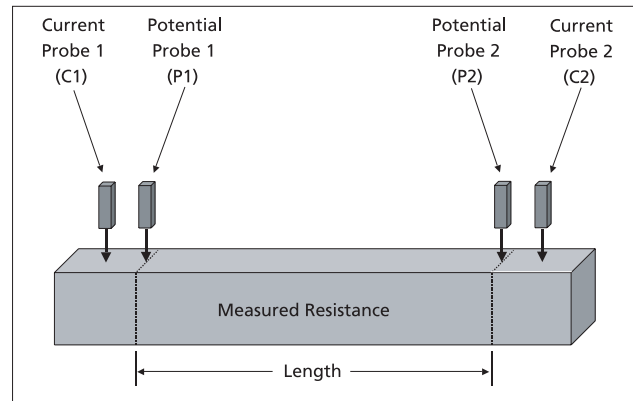

Fig 18: Simplified example of a 4 wire measurement

D.C. vs. A.C.

The issue here is the selection of the correct type of test current. A d.c. instrument should be used when trying to measure the pure resistance of a circuit or device. An a.c. instrument is used for applications such as ground bed tests or impedance tests.

A special impedance meter is used to do tests on industrial batteries. The word impedance is used to show that a measurement comprised of a resistance and reactance, which can be either an inductive or capacitive component. These measurements are conducted as part of a battery maintenance program; typically a low resistance ohmmeter is used to do strap connection verification tests.

Three or four wire a.c. measuring systems are used to do tests on 'ground beds' with special frequencies that exclude measurement errors from 50 / 60 Hz ground currents. The use of a.c. prevents the test current polarizing ions in the soil, thereby changing the conditions and thus the measured values. This is an area of interest to the electrical power distribution and telecommunication fields. The low ground resistance path is required for maintaining the potential of the ground wire to the 'earth' potential. Electrical performance of the power system minimizes shock hazards as a path to ground is made available for the energy from lightning and other static voltages that can affect the power control system. The same conditions pertain to the telephone systems, as high resistance grounds can cause excessive noise on the voice and

A guide to low resistance testing

data links (see the Megger booklet 'Getting Down to Earth' for more information on ground resistance tests). Both of these industries require not only low ground bed resistance but also low resistance 'a.c. / d.c. bonds' between the ground bed and the active circuits.

The difference between continuity and low resistance

In basic terms, continuity shows us that we are connected to both ends of the same cable. This is normally done as a 2-wire test with a resistance measurement of 10 mΩ or above. In many cases, this is acceptable for a value to be recorded on certification. But it is worth bearing in mind that continuity can also be proved with an indication such as a buzzer or test lamp.

Low resistance measurements can start at 0.1μΩ, often revealing connection issues with joints and contacts which can prove to be points of failure in waiting. This test uses the 4-wire test method which is not susceptible to test lead or probe / clip connection resistance to the device under test as it can be on the continuity 2-wire method.

Test modes

Digital low resistance ohmmeters designed in the 1970s and 1980s tended to offer two modes of operation, each designed for specific applications. Recent microprocessor technology has allowed newer instruments to include additional modes, further extending the capabilities of these models. The following is a brief review of the types of test modes available on different vintage instruments:

Models designed in the 1970s and 1980s

Continuous Mode: Allows the test current to flow and a measurement taken when the current and potential probes contact the test specimen. This mode of operation is usually implemented when the helical spring point lead sets are used and is the normal method when conducting field tests. Battery life is extended, as the test current flows only when the tests are in progress.

Momentary Mode: Requires both sets of test leads to be connected to the specimen. The measurement is done when the switch is toggled to the Momentary position. This mode of operation is used when separate current and potential leads are connected to the specimen.

2 amp and 10 amp models

Normal Mode: The user connects all four test leads and presses the test button on the instrument to start a test. The instrument checks the continuity of the test connections and then applies forward and reverse current. The reading is shown for a short period (10 seconds).

Auto Mode: Allows forward and reverse current measurements to be made (the average value is shown) by making contact with all four probes. Each time the probes are removed and reconnected to the load, another test is done. This mode, which is similar to the Continuous Mode found on older instruments, is an excellent time saving method to use when battery straps are tested with hand-spikes. It has the added advantage, when hand-spikes are used, that the contact detection sensing ensures good contact before heavy currents are applied. This avoids arcing when contact is made, which erodes the probe tips as well as potentially damaging the surface of the item under test.

Continuous Mode: Allows repeated measurements to be made on the same test sample. Once the test leads are connected and the test button pressed, a measurement is made every set number of seconds until the circuit is broken.

Unidirectional Mode: Applies a current in one direction only. While this type of measurement does not negate standing emfs, it does speed up the measuring process. In many test conditions, such as battery straps tests, it is not necessary to do a reversed current test on the sample.

Inductive Mode: Applies a current in one direction continuously until the test is stopped. This allows the instrument to charge the inductive element of the load and therefore measure just the resistive part.

100 amp and above models

Normal Mode: The user connects all four test leads and presses the test button on the instrument to start a test. The instrument checks the continuity of the test connections and then applies the test current.

Continuous Mode: Used to monitor test conditions for a period of time. After the test leads are connected and the test button is pressed, tests will be recorded every set number of seconds until the test button is pressed again or contact is broken with any of the test probes.

Auto Mode: Because of the heavy test currents used, the user connects the current leads, selects the desired test current and presses the test button. As soon as the potential leads are connected, a test will start. To make another test, the user breaks contact with the voltage probes and then remakes contact. This is an excellent mode for measuring individual joints in a bus bar.

How does a low resistance ohmmeter operate?

A low resistance ohmmeter uses two internal measuring circuits. The supply injects a current into the test sample through two leads, usually identified as C1 and C2, and the magnitude of the current is measured. Concurrently, two probes (normally referred to as P1 and P2) measure the potential across the sample. The instrument then does an internal calculation to determine the resistance of the test sample.

Why does this approach result in a measurement that is independent of lead resistance and contact resistance?

We have represented the complete measurement circuit in Fig 19. Current is injected into the item under test via leads C1 and C2. The current that flows will be dependent upon the total resistance of this loop and the power available to push the current through that resistance. Since this current is measured, and the measured value is used in subsequent calculations, the loop resistance, including the contact resistance of the C1 and C2 contacts and the lead resistance of C1 and C2, does not have an effect on the final result.

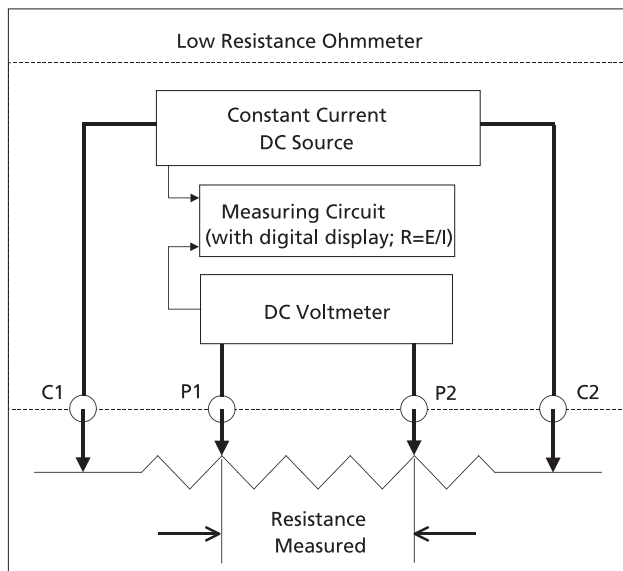

Fig 19: Basic operation diagram

From Ohm's Law, if we pass a current through a resistance we will generate a voltage across the resistance. This voltage is detected by the P1 and P2 probes. The voltmeter to which these probes are connected internally has a high impedance, which prevents current flowing in this potential loop. Since no current flows, the contact resistance of the P1 and P2 contacts produces no voltage and thus has no effect on the potential difference (voltage) detected by the probes. Furthermore, since no current flows through the P leads their resistance has no effect.

A high current output is one of the qualifying characteristics of a true low resistance ohmmeter. Generic multimeters do not supply enough current to give a reliable indication of the current carrying capabilities of joints, welds, bonds and the like under real operating conditions. At the same time, little voltage is required, as measurements are typically being made at the extreme low end of the resistance spectrum. Only the voltage drop across the measured resistance is critical, and it is measured at the millivolt level.

Good instruments alert the user of open circuit conditions on the test leads while a few models have automatic range selection.

Safety

Safety is the responsibility of the field test engineer or technician, whoever will be in contact with the sample being tested. The majority of field tests are done on de-energized circuits. When magnetic components are tested, a state of winding saturation can occur. The user should connect a short circuit across the winding to neutralize the energy stored in the winding and then make a voltage test to check the neutral state of the sample. Some instruments have indication lamps on the test probes to alert the user to a live voltage condition.

Battery strap tests represent a special condition, as the batteries must remain connected. The user is required to use insulated gloves, face mask and a body apron for protection when performing these tests. This is one of the few times when electrical resistance tests are done in the field on energized systems. Special probes, rated for 600 V operation, are available with the newer instruments to do these tests.

Using instruments with the capacity to store measured values improves the safety as the user does not have to write down the readings between each test.

Test on de-energized samples

As a general safety measure, tests should always be done on de-energized samples. Special training and equipment are required to do tests on energized circuits. Internal fused input circuits are designed into a few instruments that will protect the instrument if inadvertently connected to an energized test sample. The low input impedance of the current supply internal to general instruments becomes a willing current sink when connected across a live circuit.

Use and misuse of low resistance ohmmeters

The effective operation of a low resistance ohmmeter relies on the user using the correct test leads. Battery operated instruments are designed for a specific lead resistance, based on the operational life of the test sequence. The specified leads allow for a reasonable current drain from the power supply for the test cycle. If leads with a higher resistance are used, the current used for the test can be lower than the meter requires, potentially causing a signal-to-noise problem that can reduce the accuracy and / or repeatability of the measurement.

If leads with lower than the specified resistance values are used, the test cycle for the instrument will be shorter than anticipated. This situation may be suitable if the meter is to be used in a test program with high background electrical noise. The use of special leads with shielding can also be a solution for these high noise situations.

A common error in the field is to use a low resistance ohmmeter to sample the resistance of a ground bed. This application is incorrect, as the ground bed test method requires an instrument that toggles the test signal at a known frequency and current level. A low resistance ohmmeter used in this application will provide an erroneous reading as the ground current will have an undue influence on the measurement.

A genuine ground tester works in essentially the same way as a low resistance ohmmeter, that is, by injecting a current into the test sample and measuring the voltage drop across it. However, the earth typically carries numerous currents originating from other sources, such as the utility. These will interfere with the d.c. measurement being taken by a low resistance ohmmeter. The genuine ground tester, however, operates with a definitive alternating square wave of a frequency distinct from utility harmonics. In this manner, it is able to do a discrete measurement, free of noise influence.

Current selection

Depending on the selected instrument, the current selection can be either manual or automatic. The user should select the highest current suitable for the test to provide the best signal to noise ratio for the measurement. On instruments that offer current levels in excess of 10 A, care is required to minimize any heating of the sample that would itself cause the resistance of the sample to change.

Instruments designed to test circuit breakers have much higher current characteristics. For high current paths, like overhead line joints, bus bars and circuit breakers, it is important to make the measurement with the highest current possible, to be able to detect degraded current paths. Phenomena called 'hot spots' heat up the current path at high currents and the heat increases resistance even more, which makes the situation worse. This problem needs to be detected before it happens within nominal currents and creates a problem.

To be compliant with circuit breaker standards, a minimum 50 A (IEC) and 100 A (ANSI) is required when performing low resistance measurements.

In circuit breakers, contaminations have been seen which influence the results and cause a higher than expected reading. Using a high current can break through the contamination and thus provide an accurate and correct value.

Instruments designed specifically to test transformers have a special high voltage power level at the start of a test, to saturate the winding. These instruments then switch to a lower constant current mode to measure the winding on the transformer.

It is also important that the instrument discharges the transformer when the measurement is completed. If not, lethal voltages can be present at disconnection. Dedicated test instruments with these features integrated are available.

Warning: Never use a non-dedicated LRO to measure the winding resistance on a power transformer, since lethal voltages can be present if a winding is not discharged correctly before the leads are disconnected.

Probe and lead selection

The potential and current leads are either connected separately or to a probe. When probes are used the potential connection is identified with a P. The connections are placed in contact with the sample so that the P-identified contacts or leads are positioned towards each other. The current contacts are then positioned outside or away from the potential connections. This causes the current to flow with a more uniform current density across the sample being measured.

For the more rigorous tests, separate test leads are used and the current connections are positioned away from the potential connections by a distance that is 1.5 times the circumference of the sample being measured. ASTM Standard B193-65 provides guidelines for making a measurement that will establish uniform current density. This standard suggests separating the current probes from the potential probes by 1.5 times the cross sectional perimeter of the test specimen. Fig 20 on the following page shows a test being made to the standard on a cylindrical test item.

The use of probes, Kelvin Clips, or C-clamps will meet most field requirements as the user should be making repetitive measurements under the same conditions. The sharp points on the probes should leave a mark on the specimen for future tests. In some situations a marker pen can show the test area and the probe positions will be identified by the probe indentations.

Leads are available in a number of lengths to meet different field application requirements. The probe selection is made from separate current and potential leads with clips to connect to the test sample. Helical spring point probes have both potential and current probes in the

same handle. The 'P' identification on the probe identifies the position on the sample at which the measurement is taken. This probe arrangement provides a practical method when making repetitive measurements (ideal for tests on strap connections in UPS battery supply systems).

Kelvin Clips and C-clamps have the current and potential connections 180° from each other, providing separate current and potential connections. The size of the terminal connection determines which one to select. See Fig 21 for the different probe / lead configurations.

Note: The order of connection of potential and current clips is not important. However, never connect the potential clip to the current clip as this will cause an error in the measurement due to the voltage drop at the current connection interface at the sample.

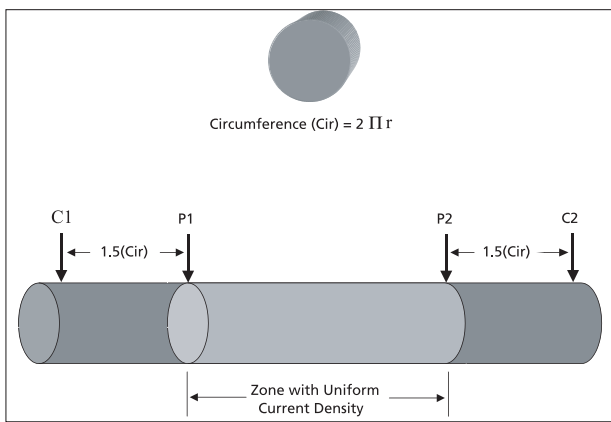

Fig 20: ASTM standard B193-65

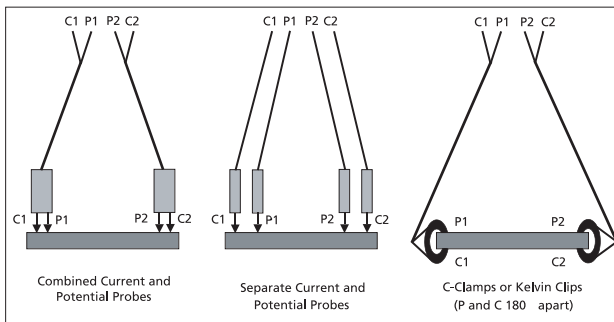

Fig 21: Probe / lead configurations

Low range tests

When measuring on the extreme edge of precision and sensitivity, factors that would be too small to be of consequence in conventional tests, become significant.

In low resistance tests, thermal emfs (electromotive forces), also known as Seebeck voltage, can produce voltage gradients across the test sample. Although only on the millivolt level, and of little or no influence on common multimeter tests, these can cause fluctuations of several digits. Such instability defeats the purpose of a high precision measurement. In addition,

a.c. interference can be induced by nearby electric or magnetic fields, or can be present from the float charge on standby battery systems, or through leaky switches, electrical imbalance and so on.

This problem is readily overcome by taking readings in forward and reverse polarity and then averaging them. Some models accomplish this with a manually operated reversal switch, while others do the two measurements automatically, then show the average reading. If unidirectional measurement is required (to save time (as in battery strap tests)), the tester may have an override function. Another sophisticated technique automatically measures the magnitude and slope of thermal emfs and subtracts from the shown reading.

However, the simplest technique is to test with high current if it is a high current path. Since the measured voltage becomes significantly higher than the thermal emf voltage the accuracy will be kept. This simple method also saves time since there is no need for reversed polarity.

Types of testers - which one?

Milli-ohmmeter

As the name implies, a milli-ohmmeter is less sensitive than a micro-ohmmeter, with measurement capability in the milliohm rather than microhm range (minimum resolution of 0.01 milliohm. This type of instrument is normally used for general circuit and component verification. Milli-ohmmeters also tend to be less expensive than micro-ohmmeters, making them a good choice if measurement sensitivity and resolution are not critical. The maximum test current is typically less than 2 A and as low as 0.2 A.

2 Amp micro-ohmmeter

The low current output on these micro-ohmmeters means that a much smaller hand held format is possible. This makes these ideal toolbox sized instruments that still have enough current to enable micro-ohm level measurements, typically with 1 $\mu\Omega$ resolution. Although they won't provide the weakness heating capabilities and very low ohm performance of a 10A tester they are still more than capable of finding issues not possible with a 200 mA continuity tester. The hand held format also results in a more cost effective solution and the convenience of AA battery operation.

10 Amp micro-ohmmeter

The field portable micro-ohmmeter with a 10 A maximum test current is the 'work horse' instrument for most users because it covers the majority of field applications. The 10 A output not only provides a comfortable and suitable test current through the test sample to make the measurement, but also allows for reduced weight and improved battery operation. The additional current over the 2 A micro-ohmmeter can provide twenty five times the power to heat weaknesses, and improved signal to noise ratio. The 10 A test current is also recommended for molded case circuit breakers in commercial and industrial applications, low voltage air switches, and circuit breakers with ratings below 100 A.

The best 10 A micro-ohmmeters offer measurements from 0.1 microhm to 2000 ohms with a best resolution of 0.1 microhm at the low end of the range and accuracy of $\pm 0.2\%$, ± 0.2 microhm. On some instruments, different measurement modes can be selected which address different types of test conditions. Measurement modes could include manual, automatic or a continuous test, or a high power test on windings.

The following is a selected list of key d.c. resistance measurement applications for 2 A to 10 A micro-ohmmeters.

- **Switch and contact breaker resistance**
- **Bus bar and cable joints**
- **Aircraft frame bonds and static control circuits**
- **Welded joint integrity**
- **Intercell strap connections on battery systems**
- **Resistive components (quality control)**
- **Small transformer and motor winding resistance**
- **Rail and pipe bonds**
- **Metal alloy welds and fuse resistance**
- **Graphite electrodes and other composites**
- **Wire and cable resistance**
- **Transmitter aerial and lightning conductor bonding**

100 Amp and above micro-ohmmeter

According to IEC62271-100, a test of the contact resistance of high voltage a.c. circuit breakers calls for a test current with any convenient value between 50 A and the rated normal current. ANSI C37.09 specifies that the test current should be a minimum of 100 A. Most electrical utilities prefer to test at higher currents, as they believe this is more representative of working conditions.

Field portable micro-ohmmeters are available that can deliver anywhere from 100 A up to 600 A (subject to the load resistance and supply voltage). The best instruments have measurement resolution to 0.1 microhm and offer variable test current to address a wider range of applications. If a test is done at 10 A and then at a higher current, the user can get a better understanding of the maintenance requirements for the circuit breaker.

As previously stated, in circuit breakers, contaminations have been seen which influence the results and cause a higher than expected reading. Using a high current can break through the contamination and thus provide an accurate and correct value.

In addition to circuit breakers, electrical utilities and test companies use higher current micro-ohmmeters on other high voltage apparatus, including:

- **Cables**
- **Cable joints**
- **Overhead line joints**
- **Ground connections**
- **Lightning protections**
- **Welds**
- **Bus bars**
- **Switchgear in general**

When a 100 A (or above) micro-ohmmeter is used, users should be aware of certain technical issues related to tests at high currents. Some users have shown that they do a 10 A test and then see improved resistance readings with 100 A (or more) test currents. This difference in the measurements raises the question of whether there is a need for additional maintenance. A strict reading of Ohm's Law does not indicate the need for the higher current to do the measurement. In the equation $R = V/I$, the magnitude of the current is not defined. Is this a situation where the high current is blasting contaminants away from the contacts, and at the same time welding the contacts together? The user should be aware that they could be masking a potential problem in a power distribution system and avoiding necessary maintenance.

Users should also be aware that high current meters are intended to be used at high currents. Their accuracy may reduce considerably at low currents, particularly when measuring small resistances.

Nominal vs. absolute test current levels

Battery operated digital low resistance ohmmeters have different test currents, which are a function of the selected range. The lowest range has the highest current level and as the range increases the current decreases. As the range increases by a factor of 10, the test current will decrease by a factor of 10. This action allows for a balance of weight and function; if the current were to increase as the range increases, this field instrument would lose much of its portability, and its usefulness for field tests would decrease significantly. In power plants, substation and distribution sites, the test equipment is exposed to interference from high currents generated in the area. The user will have to determine the test current level to provide the most accurate and repeatable measurements.

Industry standard test currents were originally developed according to available technology in metering. With early technology, enormous currents were needed to develop a measurable voltage across a test sample with negligible resistance. By Ohm's Law, a typical meter of one millivolt full scale would require 100 A to measure as little as a microhm. The microhm being the preferred unit of measurement for low resistance tests, this made 100 A testers the standard design for early instrumentation.

Unfortunately, this design made for testers that were large, difficult to move, and of limited practicality in the field. The development of cross-coil movements, with the balancing of voltage and current in two separate coils driving the pointer, produced a dramatic increase in sensitivity, and brought workable test currents down to the familiar 10 A level. Of course, microprocessors have further extended the sensitivity of modern instruments. But this process is limited by the need for adequate noise suppression. Low resistance ohmmeters measure at levels several powers of ten lower than common multimeters. Noise becomes large by comparison, and makes noise suppression critical to the adequate function of the instrument. The tester, therefore, must maintain an adequate signal-to-noise ratio, and/or deploy the latest techniques in noise filtering.

Testers with large current outputs are still widely used, however, for tests on specific types of equipment. The limiting factor on the high end is principally the generation of heat. Tests at too high a current can cause a heating effect on the measurements, be injurious to the test item, and even cause welding of contacts. Certain types of equipment such as high voltage a.c. circuit breakers (see IEC62271-100) have sufficiently large conductors and areas of contact to carry currents of several hundred Amps without experiencing these harmful effects.

The demand for test current is critical when coils are tested, transformers or other magnetic components due to the inductive characteristics of these types of components. Industry standards may call for some specified high current. Such selection is typically a compromise between various factors as discussed above, with a view toward practicality, rather than scientifically justified demands. Sophisticated testers will automatically balance current against the load, for maximum precision and minimum heat effect, so that it is not necessary to impose specific, pre-selected values on the test procedure. Some suppliers specify 200+ Amps for SF6 breaker contacts to overcome oxidation on the contact surfaces.

Note: The Kelvin Bridge instrument, which has been used to make measurements in the sub-microhm region, uses approximately 5 A of test current.

Auto range

Auto range capability on an instrument allows the user full use of the test probes. An auto range instrument will automatically select the range to give the best use of the display, provide the most sensitive reading for the measurement and optimize the resolution of the reading.

When taking a series of readings, the user will be able to maximize the use of their time.

Ingress protection

Somewhere in the fine print (specifications) of most test instrument product bulletins is an IP rating, a number that gives the user vital information. In fact, the IP rating lets the user know whether a piece of test equipment is suitable for an application and / or test environment.

'IP' stands for 'ingress protection'. That is the degree to which the instrument can withstand invasion by foreign matter. The IP rating system was established by the IEC (International Electrotechnical Commission), in their Standard 529, and is used as a guide to help the user protect the life of the instrument. It also can help the user make a more informed purchase decision by ensuring that the test equipment is designed to work in the environments that a user faces.

A guide to low resistance testing

The IP rating comprises of two numbers, each signify a separate characteristic. The designation shows how well the item is sealed against invasion by foreign matter, both moisture and dust (the higher the number, the better the degree of protection). What would a typical rating of IP54 tell a buyer about the application capabilities of a model? If you want to sound thoroughly knowledgeable, that's IP five-four, not fifty-four. Each number relates to a separate rating, not to each other.

The first number refers to particulate ingress, reflecting the degree to which solid objects can penetrate the enclosure. A level of '5' means 'dust protected', as well as protected from invasion with a wire down to 1.0 mm. There is only one higher category: 'dust tight'.

The second number refers to moisture. A rating of '4' means a resistance to 'splashing water, any direction'. The higher ratings of 5 through to 8 indicate 'jetting water' and 'temporary' or 'continuous' immersion.

As an example, suppose an instrument under consideration is rated to IP43. What would that tell the user about its usability? Could it be thoroughly utilized in a quarry or cement plant? Hardly! The particulate rating 4 means 'objects equal or greater than 1 mm'. That's a boulder in comparison to particles typically produced by industrial processes. Flying dust could put the instrument out of commission.

Suppose the instrument is rated at IP42. A moisture rating of 2 means 'dripping water'. Therefore, it would not be resistant to flying spray. An instrument which is used in an environment that exceeds its IP rating likely means that the user will need a new instrument very soon. What about a rating of IP40? A moisture rating of 0 means that the instrument is not protected against **any** liquid ingress.

The following tables provide a guide to various IP ratings and what they mean to the user:

Table 2: Ingress and access protection

First No.	Description
0	Non-protected
1	Objects equal to or greater than 50 mm Protected against access with back of hand
2	Objects equal to or greater than 12.5 mm Protected against access with jointed finger
3	Objects equal to or greater than 2.5 mm Protected against access with a tool
4	Objects equal to or greater than 1 mm Protected against access with a wire
5	Dust protected
6	Dust tight

Table 3: Ingress of liquids protection

Second No.	Description
0	Non-protected
1	Water dripping vertically
2	Water dripping, enclosure tilted up to 15°
3	Spraying water, up to 60° angle from vertical
4	Splashing water, any direction
5	Jetting water, any direction
6	Powerful jetting water, any direction
7	Temporary immersion in water
8	Continuous immersion in water

Evaluation / interpretation of results

Repeatability

A good quality low resistance ohmmeter will provide repeatable readings within the accuracy specifications for the instrument. A typical accuracy specification is $\pm 0.2\%$ of reading, ± 2 LSD (least significant digit). For a reading of 1500.0, this accuracy specification allows a variance of ± 3.2 ($0.2\% \times 1500 = 3$; $2 \text{ LSD} = 0.2$).

Additionally, the temperature coefficient must be factored into the reading if the ambient temperature deviates from the standard calibration temperature.

Spot readings / base expectations for readings

Spot readings can be very important in understanding the condition of an electrical system. The user should have some idea of the level of the expected measurement based on the system's data sheet or the supplier's nameplate. Using this information as a baseline, variances can be identified and analyzed. A comparison can also be made with data collected on similar equipment.

As noted, the data sheet or nameplate on a device should include electrical data relevant to its operation. The voltage, current and power requirements can be used to estimate the resistance of a circuit, and the operating specification can be used to determine the allowed change in a device (for example, with battery straps, connection resistances will change with time). Various national standards provide guidance for periodic test cycles.

The temperature of the device will have a strong influence on the expected reading. As an example, the data collected on a hot motor will be different from a cold reading at the time of the installation. As the motor warms up, the resistance readings will go up. The resistance of copper windings responds to changes in temperature based on the basic nature of copper as a material. A more detailed review of temperature effects is covered in the appendix. Using the nameplate data for a motor, the expected percentage change in resistance due to temperature can be estimated using Table 4 for copper windings or the equation on which it is based.

Different materials will have different temperature coefficients. As a result, the temperature correction equation will vary depending on the material being tested.

Table 4: Copper: temperature / resistance relationship

Temp °C (°F)	Resistance $\mu\Omega$	% Change
-40 (-40)	764.2	-23.6
32 (0)	921.5	-7.8
68 (20)	1000.0	0.0
104 (40)	1078.6	7.9
140 (60)	1157.2	15.7
176 (80)	1235.8	23.6
212 (100)	1314.3	31.4
221 (105)	1334.0	33.4

$$R(\text{end of test})/R(\text{start of test})$$

$$= (234.5 + T(\text{end of test})) / (234.5 + T(\text{start of test}))$$

Trending

In addition to comparing measurements made with a low resistance ohmmeter against some preset standard (spot test), the results should be saved and tracked against past and future measurements. Logging of measurements on standard forms with the data registered in a central database will improve the efficiency of the test operation. Previous test data can be reviewed by the user, and then on-site conditions can be determined.

Developing a trend of readings helps the user better predict when a joint, weld, connection, or other component will become unsafe, and make the necessary repairs. Remember that degradation can be a slow process. Electrical equipment faces mechanical operations or thermal cycles that can fatigue the leads, contacts and bond connections. Additionally, these components can also be exposed to chemical attack from either the atmosphere or man made situations. Periodic tests and recording of the results will provide a database of values that can be used to develop resistance trends.

Note: When taking periodic measurements, the user should always connect the probes in the same place on the test sample to ensure similar test conditions.

The following are several examples of where trending can help the user make better informed maintenance decisions:

Circuit breakers

As mentioned previously a 10 A test current is recommended for molded case circuit breakers in commercial and industrial applications, low voltage air switches, and circuit breakers with ratings below 100 A. "

For high voltage circuit breakers the test current will need to be at least 50A if you are testing to IEC standards, or at least 100A if referencing ANSI standards

As noted before, mechanical wear and tear on circuit breaker contacts, that reduces the area of the contact surfaces combined with sparking and / or arcing, will increase the resistance across the working connections. This condition will produce heat that can reduce the effectiveness of the circuit breaker. Periodic measurements will show the rate of increase of the contact resistance value. When these values are compared to the original manufacturer's specification, a decision can be made to continue or repair. By tracking the trend of the readings, the user will get an idea of when the circuit breaker should be pulled for service before damage is done.

Stand-by battery back-up systems

The interface between the terminals and the straps on battery back-up systems is subject to chemical attack from the acid atmosphere, thermal changes due to the charging and discharge currents and mechanical stress from vibration. Each of these factors can cause the resistance bond to degrade, resulting in the potential for a fire at a critical power discharge (due to the hydrogen gas atmosphere).

Battery systems require diligent attention, as replacement batteries are both expensive and not off-the-shelf items. A failure situation can result in a battery system being out of service for a number of weeks. Periodic measurements of the strap resistance will identify those bond connections that have degraded since the last test and corrective action can be planned.

Note: When connections have higher than normal resistance measurements, the user should not retighten the bolts, as this will over stress the soft lead connection. Over tightening does not cure the problem. The correct procedure is to disassemble the straps, clean, grease and then reconnect with the bolts tightened to the supplier's torque level. All the connections should be balanced within a narrow tolerance of ± 10 to 20%.

In these and many other systems, time lost to repair defective equipment may be small compared to the cost of having equipment out of service for weeks. Periodic tests can avert many problems. Analyzing data against past results and reasonable standards allows the user to select the time when corrective work should be done.

The value of a system is in its ability to work on demand. Operations are predicated on many systems being available at an instant's notice. When elements break, production is lost and time is wasted making emergency repairs. Taking and analyzing periodic low resistance measurements saves companies money by helping identify problems before they result in catastrophic failure.

The practical example shown in Fig 22 shows how trending low resistance measurements made on a periodic basis provides critical information to the user.

When low resistance measurements are made on stranded cables on spot welding robot #23, the user is gathering data to estimate when fatigue to the current conductor will degrade the quality of the weld nugget. The test data starts with the wire manufacturer's specifications. The example shows that a resistance increase of up to 10% is acceptable.

In this case, measurements are made after a specific number of weld operations. When charting this data, observe the rate of change as the readings approach the end of life for the stranded cable. The critical factor could have been long-term exposure to a chemical solvent. In other operations the critical factor is time, with tests done on a seasonal basis or on specified number of days.

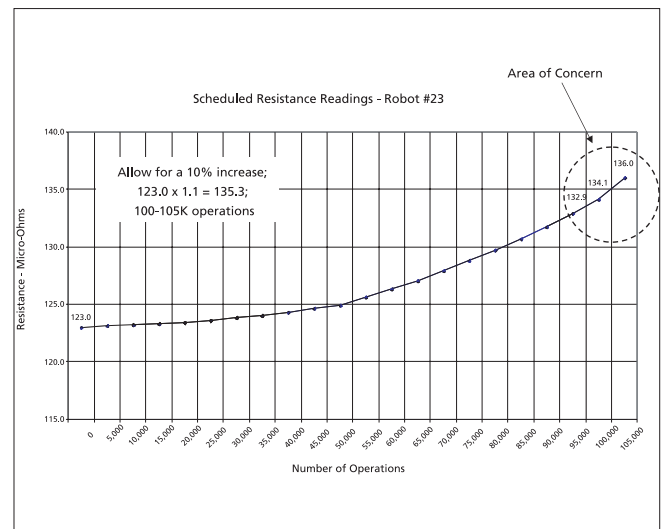

Fig 22: Trending analysis of low resistance readings

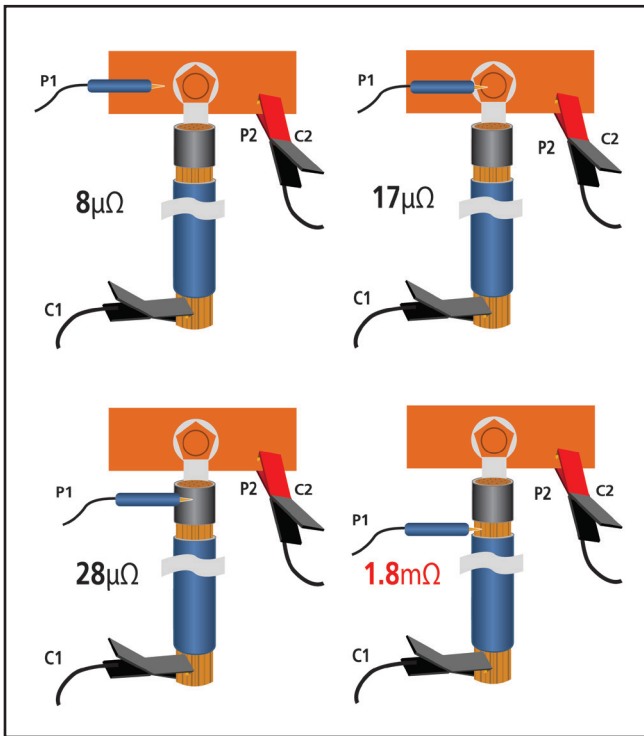

Fig 23: C1 clip being connected to end of circuit being tested

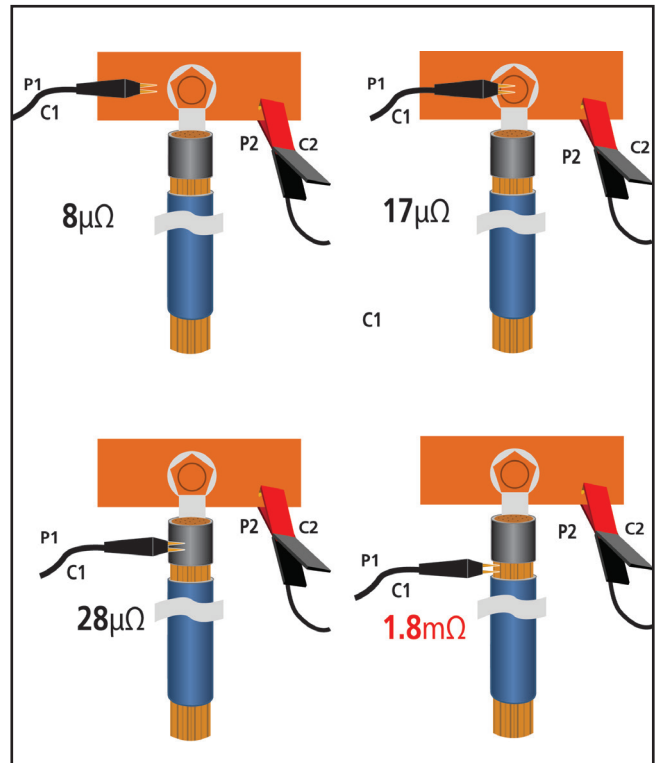

Fig 24: Duplex hand spike being used to perform same test as shown in Fig 23

Measuring components of a system

When using the current and potential as split test leads there is the ability to locate faulty components and connections by probing at each connection or joint and looking at the increase in resistance.

An example is measuring the resistance of a cable to lug joint or lug to bolted connection while still connected to a system.

In Figs 23 and 24, a kelvin clip is shown connected to a bus bar for the C2 and P2 connections, although these connections could easily be done using separate clips.

Fig 23 shows a large C1 clip being connected to the end of the circuit being tested, which in this case is the end of a cable. A single probe tip is being used for the P1 connection to easily probe to the point the measurement is required.

In Fig 24, a duplex hand spike is being used to perform the same tests. Roughly the same resistance values will be measured, although in practice they will have slight differences due to the current density difference produced by the different C1 connection point.

A guide to low resistance testing

The test results in Fig 24 show a jump in resistance of nearly 1.8 mΩ at the connection between the cable and the crimp lug. This would not be detected using a continuity test of 200 mA or a multimeter. This additional resistance will over time develop into a larger value eventually causing a breakdown or even a fire. As it stands, the additional resistance will at least create power losses.

High currents in low resistance measurement

Low resistance measurements are good for identifying resistive elements that change over time due to environmental conditions. Conditions that can degrade devices or materials include, temperature, noise ratio or induced currents, thermal EMF / Seebeck voltage, fatigue, corrosion, vibration, oxidization, hot spots (see "Potential sources of error / ensure quality results" on page 24 below).

Low resistance measurements are typically below 1 A, so it is important that test equipment errors be minimized. To minimise these errors as much as possible use the four wire (Kelvin) test method, which gives accurate results when low resistance is measured.

- **High currents are recommended by International high voltage Circuit Breaker test standards and by Megger (taking care of heating issues)**
- **Higher test currents give a better chance of good reliable test results**
- **Bad low current results do not always indicate that a contact is in a bad state (contamination) or that a good result indicates a good contact condition (hot spots)**

The International Standards for high voltage Circuit Breaker tests can be found in IEC 622 7 1 and IEEE C32.09.

Test Current (d.c.)

- **Minimum 50 A (IEC): 100 A (ANSI)**

Potential sources of error / ensure quality results

The user can compromise low resistance measurements if the wrong test equipment is used or the temperature at the test site is not determined and noted on the test data sheet. Before a test, surface preparation can be critical. Heavy scale or oxide coatings should be removed to expose a clean surface and ensure good current connections.

Test leads / probes

An instrument's specification should have a recommended listing of suitable test leads. The user should always check that the correct leads are being used as leads can look alike but have different resistances, which can limit the maximum current that the instrument can produce.

Do not use thermocouple extension wire in place of copper leads as the material mismatch will produce erratic data that will change as the site temperature varies with the seasons.

The probe selection is also critical. High current tests require secure connections to the work surface because high resistance at the contacting point can limit the expected level of test current, causing a poor signal-to-noise ratio, with erratic results. Use of unsuitable probes for the particular application can lead to unreliable results.

In all cases tests are done with current injection and potential measurements made at separate locations on the component. Potential test clips must never be connected to the current connection as the voltage drop at the current interface will be added to the potential measurement and produce an error in the reading. The ideal current connection injects current above the potential measurement position. When these points are close to each other the Kelvin clip or C-clamp connectors are used, injecting current 180° from the potential connection (see Fig 25).

The test leads are matched to battery operated meters to ensure that the nominal level of test current will be delivered to the test specimen.

Finally, probes are designed to make electrical connection with the test sample. They are not intended to be used to clean surfaces, open tins, etc.

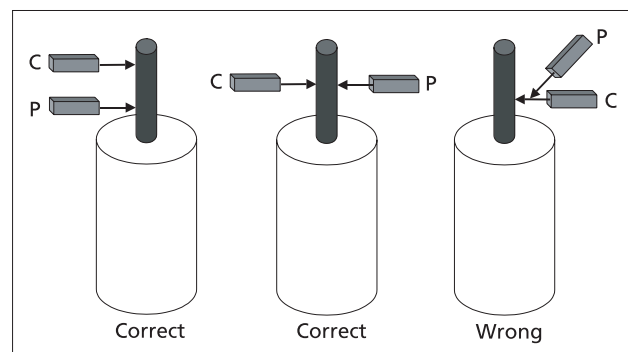

Fig 25: Correct and incorrect probe placements

Probes are available in five basic styles. Each probe is designed to address specific field and / or application situations. Fig 26 shows some of the different styles.

Fixed Point: Most economical and lightweight probes.

Kelvin Clips: Feature spade lugs on the inboard end and alligator clips with insulated silver or gold plated jaws.

Linear Spring Points: These probes are designed with spring points, which recess into the handle to allow for unevenness of the surface. They are designed for clean surfaces as they have no 'cutting' action to allow them to bite through surface contamination.

Helical Spring Points: The tips rotate and compress into the body of the probe, allowing the probes to break through any grease or surface film, ensuring an accurate measurement. Additionally, these probes will leave a mark on the test surface to identify the points where the test was done. Care should be taken when using these probes if the surface being contacted is sensitive to pressure points.

C-Clamps: A current passes through the C-clamp and screw thread while the potential passes through a four point anvil insulated from the clamp metal.

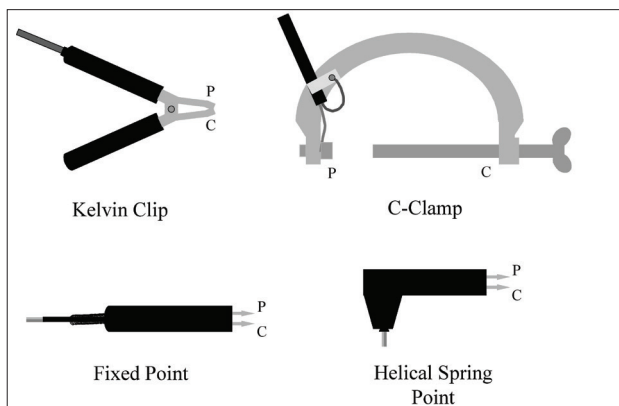

Fig 26: Basic styles of probes

Accuracy statements

Quality low resistance ohmmeters will show their accuracy statement as ' $\pm X.X\%$ of reading, $\pm X$ LSD'. Beware of instrument accuracies stated as a percent of range rather than a percent of reading. While these accuracy statements can look alike, the measurements made on an instrument with (% of range) accuracy would provide readings that are less accurate.

The resolution of an instrument reading is typically one half the least significant digit (LSD) noted in the accuracy statement. The magnitude of the LSD influences the repeatability of the measurement. A large LSD number is due to the low sensitivity of the instrument, adding an additional error to the measurement.

Check the temperature coefficient of the selected instrument. The temperature coefficient (% of reading per degree) is multiplied by the site temperature difference from the instrument's calibrated temperature and will influence the accuracy of the field measurements. An instrument that

includes an accuracy notation of $+0.2\% / ^\circ\text{C}$ should not be used in the field, as its best utilization would be in a laboratory with a constant ambient environment.

The user must be aware of all these characteristics when selecting the test instrument.

Interference

A strong electrical field, flux linkage from a high current circuit or voltage induced from a high voltage conductor can cause interference at the test site. In addition ground currents can induce noise on a conductor. Interference can reduce sensitivity and produce unstable readings. An instrument with low noise rejection, or hum attenuation may be stable when tested on the bench, but be erratic in selective field conditions.

Modern electronics can detect the level of noise and some instruments use this to show when excessive noise is present to make a valid measurement.

A simple technique to minimize noise problems is to measure at high current since the measured signal gets larger than the noise it self.

Delivery of stated test current under load

Battery operated, digital low resistance ohmmeters have different test currents dependent on the selected range. The lowest resistance range has the highest current level and as the range increases the current will decrease (as the range increases by a factor of ten the test current will decrease by a factor of ten). This feature allows for an effective balance between weight and functionality.

The output current delivered by the instrument is not critical, as the instrument will be measuring the actual test current at the time of the test. However, the instrument must be able to deliver sufficient current to produce a clear signal in the presence of typical noise. A typical instrument can have a 10% to 20% tolerance on the maximum current rating. But, to make a good potential measurement, the current must be stable. The critical factor for the measurement is the voltage measurement via the potential leads (Ohms Law).

The one test area where the test current is critical is on a transformer, due to the magnetic characteristics of the winding. Sufficient current is required to saturate the winding, and then a lower constant current is used to do the measurement.

A guide to low resistance testing

Taking a measurement at a stable plateau

A de-energized test specimen provides a stable platform on which to make the measurement. Live circuits can produce an unstable test platform. An example of the latter is the test of battery straps on a UPS system. The charging and / or discharging currents may induce noise across the battery straps being measured, and at the same time cause the resistance values to increase (due to heating of the strap and its connections).

When collecting data, the user must define the test conditions. As noted previously, temperature can have a significant influence on any measurements made. The user should note the temperature and document any electrical equipment that is in operation in the test area.

Material resistivity

Conductors of the same dimensions have different resistances if they are made of different materials, due to the varying number of free electrons in varying substances. We account for these differences with the term resistivity, which is the resistance of a sample of the material having dimensions with specified unit values.

While scientists tend to look at cubes of material as the measurement standard (one centimeter cube or one inch cube), conductors tend to be circular, making a circular standard important for practical use.

The resistivity of a material is defined in ohm-circular mils per foot; that is, the resistance (in ohms) of a piece of material one foot long and one circular mil cross section. It is defined at a temperature of 20 °C (68 °F).

Table 5 shows the resistivities for a number of conducting materials¹:

In most field applications the user determines the suitability of a field measurement against a pre-selected specification. In most cases, these specifications have been generated from the following formula (at 20 °C (68 °F)):

$$R = \rho L/A$$

ρ = Resistivity of the material in ohm-CM per foot.

L = Distance between two points on the material, in feet.

A = Cross section area measured in circular mils.

Table 5: Resistivities of conductors

Substance	Microhms		Ohm-cm per Foot
	cm cube	in cube	
Aluminum	2.83	1.11	17.0

1 Electrical Metermen's Handbook; Third Edition; 1965; page 479

Substance	Microhms		Ohm-cm per Foot
	cm cube	in cube	
Carbon (Graphite)	700	275	4210
Constantan (Cu 60%, Ni 40%)	49	19.3	295
Copper (annealed)	1.72	0.68	10.4
Iron (99.98% pure)	10	3.94	60.2
Lead	22	8.66	132
Manganin (Cu 84%, Ni 4%, Mn 12%)	44	17.3	264
Mercury	95.78	37.7	576
Platinum	9.9	3.9	59.5
Silver	1.65	0.65	9.9
Tungsten	5.5	2.17	33.1
Zinc	6.1	2.4	36.7

Effects of temperature

Resistance measurements are dependent on temperature. If the original data was read at one temperature but later tests are conducted at other temperatures, this temperature data is required to determine the suitability of the measurements. All materials do not react to temperature to the same degree. Aluminum, steel, copper and graphite have specific temperature coefficients that will affect the degree of changes that can take place with temperature at the site of the measurement.

Low resistance measurements rely on the user conducting the tests within the operating temperature range of the instrument (the user must be aware of field conditions). When the user sees out-of-tolerance measurements, one of the first steps is to check the instrument's reading with a suitable calibration shunt.

As mentioned previously, resistance measurements are dependent on temperature. The resistance of all pure metals increases with rising temperature. The proportional change in resistance for a specific material with a unit change in temperature is called the temperature coefficient of resistance for that material. Temperature coefficients are expressed as the relative increase in resistance for a one degree increase in temperature. While most materials have positive temperature coefficients (resistance increases as temperature rises), carbon graphite materials have negative temperature coefficients (resistance decreases as temperature rises).

Table 6 shows the temperature coefficients of resistance for selected materials²:

Table 6: Temperature coefficients of resistance

Material	Per °C	Per °F
Aluminum	0.0038	0.0021

2 Electrical Metermen's Handbook; Third Edition; 1965; page 480

Material	Per °C	Per °F
Carbon (0 - 1850 °C)	-0.00025	-0.00014
Constantan (0 - 100 °C)	Negligible	Negligible
Copper (@ 20 °C)	0.00393	0.00218
Iron	0.0050	0.0028
Lead	0.0043	0.0024
Manganin (0-100 °C)	Negligible	Negligible
Mercury	0.00090	0.00050
Platinum	0.0038	0.0021
Silver	0.0040	0.0021
Tungsten	0.0045	0.0025
Zinc	0.0037	0.0021

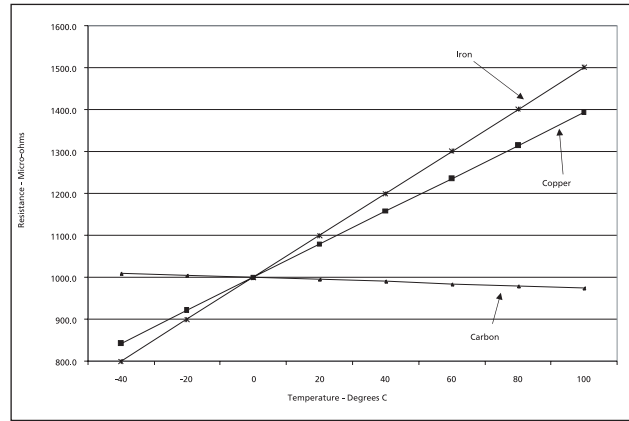

Fig 27: Temperature resistance curves for iron, copper and carbon

Fig 27 shows the temperature resistance curves for some of these materials (based on a baseline reading of 1000 microhms at 20 °C (68 °F).

When making a measurement on a specific material, the user can calculate the change in resistance due to a change in temperature by multiplying the resistance at the reference temperature by the temperature coefficient of resistance and by the change in temperature:

$$R_2 - R_1 = (R_1)(a)(T_2 - T_1)$$

R₁ = resistance of the conductor at the reference temperature

R₂ = resistance of the conductor when the measurement is made

T₁ = reference temperature

T₂ = temperature at which the measurement is made

a = temperature coefficient of resistance for the material being tested

The user should also be aware of operating and storage temperature specifications of the instrument they are using to ensure that it is suitable for the environment in which it will be used.

Effects of humidity

The relative humidity of the test specimen should not affect the resistance reading unless the material is hygroscopic, in which case more moisture will be absorbed into the sample at higher humidities. This will change the measurement conditions and will affect the achieved result. However, most conductors are non-hygroscopic. Therefore, since instruments are typically designed with an operating range of from 0 to 95% RH, providing that moisture is not actually condensing on the instrument then a correct reading will be obtained.

Background noise, current and voltage

Resistance measurements can be degraded by static voltages and ripple currents (electrical noise) impressed on the test specimen. The user should be aware of the level of noise rejection in the instrument being used. Changing to a different model can help the user make a measurement at a difficult test site.

The magnitude of the test current used by the instrument will affect the noise rejection capability of that instrument. A 10 A test current will provide much better noise rejection than a 0.1 A test current. Beware of excessive test currents which can change or damage the test sample due to heating ($W = I^2R$). If 100 A is used in place of 10 A, the sample will experience 100 times the heat of the lower test current. With that said, use appropriate test current based on the nominal current rating.

The open circuit voltage on most low resistance ohmmeters is low. When making measurements on transformer windings, additional power is required to saturate the winding and allow the meter to stabilize more rapidly.

Instruments

A guide to low resistance testing

designed for this type of application have a higher open circuit voltage (in the 50 V d.c. range) to deliver the energy needed to saturate the windings. Then a constant current mode of operation is used to do the resistance measurement.

Thermal emf / Seebeck voltage compensation

Thermal EMF / Seebeck voltage is generated when different conducting materials are part of the same circuit or at different temperatures. The effects of this can be overcome by increasing the current used for the test. Increasing the current will reduce the error, but ensure that it is not too high (heating), see tables below:

Table 7: Current error percentage

Current	Voltage	Error		
		Cu-Ni	Cu-Al	Cu-Ag
1 A	50 μ V	400%	200%	20%
10 A	500 μ V	40%	20%	2%
100 A	5 mV	4%	2%	0.2%
600 A	30 mV	0.7%	0.3%	0.03%

Table 8: Conducting materials temperature

Junction	μ V/ $^{\circ}$ C
Copper - Copper	<0.3
Copper - Gold	0.5
Copper - Silver	0.5
Copper - Brass	3
Copper - Nickel	10

Junction	μ V/ $^{\circ}$ C
Copper - Lead - Tin Solder	1 - 3
Copper - Aluminum	5
Copper - Kovar	40
Copper - Copper Oxide	>500

Contact resistance contamination

Contact resistance is the resistance to current flow through a closed pair of contacts. Sometimes it takes a high current to break through, melt or soften the contact point and its surrounding area, which increases the contact area and, as such, reduce the resistance.

Example: A circuit breaker is tested and its main contact shows a resistance of 300 microhms using a 100 A test current. The test is repeated using a 600 A test current and a resistance of 80 microhms shows, the test is again repeated using a 100 A test current, again the result is 80 microhms.



Fig 28: Circuit breaker corrosion

Noise ratio and induced currents

It's common to have noise in a power environment, so to establish an accurate result the measurement signal needs to be greater than the noise generated:

- Low resistance measurement of 50 Ω
- 1 A => measurement signal 50 μV
- 10 A => measurement signal 500 μV
- 100 A => measurement signal 5 mV
- 600 A => measurement signal 30 mV

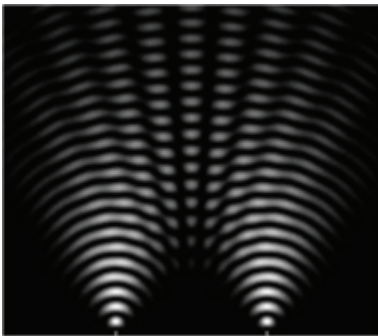

Fig 29: Noise

Hot spots

Hot spots from degrading contact inhibits the contacts ability to carry nominal or overload currents and, dependant on the severity of the contact state, this can result in temperature rises.



Fig 30: Hot spots

At the point where a hot spot is detected you may see a much higher rise in temperature than the overall temperature measured, this would increase the resistance and a greater chance of fire:

- Hot spots are the source of high frequency waves (Harmonics). When these waves pile up at a location, they will cause equipment damage by Resonance Phenomenon
- Hot spots are indicators of impending failure of the equipment
- There are sources of electrical energy losses (loose connections)
- Hot spots are the primary cause for a major explosion of electrical equipment
- It is one of the main reasons for failure of current transformer (especially in HV circuits)

Calibration in the field

Calibration of low resistance ohmmeters can be checked in the field by the use of a shunt. Calibration is done using individual current and potential 12-gauge copper leads, to ensure correct current distribution through the shunt and an accurate potential measurement. Be aware that 'test probes' do not provide accurate positioning of the leads to check instrument calibration. They can, however, be used to determine the relative calibration of the instrument.

Table 8: Commercially available shunts

Resistance ±0.25% Value	Current Rating
10 Ω	1 mA
1 Ω	10 mA
0.10 Ω	100 mA
0.01 Ω	1 A
0.0010 Ω	10 A
0.0001 Ω	100 A

These calibration shunts when used with a Certificate of Calibration, traceable to National Standards, help the field service engineer demonstrate to a customer the accuracy of the tests being conducted.

Appendices

Testing of transformers

Regular tests on transformers can help identify problems that reduce system performance and can lead to unexpected outages. The d.c. resistance of a transformer winding can indicate the internal temperature of the winding, when the resistance at ambient is compared to the hot resistance. The ideal test method is to make resistance readings at one minute intervals as the hot winding is cooling. When this data is charted, the resistance at time zero can be estimated. This test is one of the mandatory tests done when the transformer is manufactured and might also be used in the field if the transformer is accessed while still heated up.

The typical test will show excessive overheating in the coils due to fatigue or corrosion of the internal coil and / or the internal connections. Low resistance tests on transformers addresses small, medium, large single, large poly-phase and auto-transformer windings. Tests are done on:

- **Dual windings with the test current connected through the windings in opposed polarities**
- **Wye to wye windings with and without a neutral connection; the leg of the other winding is connected to the potential lead to measure the voltage at the internal connection**
- **Wye to delta windings; a jumper is used to connect the current from the wye winding to the delta winding (this test mode reduces the test time)**
- **Delta to delta windings; the test time can be improved by connecting the current jumper to the primary and secondary of the same phase in opposed polarities**

Taps are used to improve voltage regulation and are adjusted daily. Excessive wear and loosening due to vibration can be identified with low resistance measurements. Consecutive tests can be done on secondary tap changers (shorting style of taps). Large transformers have many tap positions and test time will be reduced, as the test current does not have to be shut off between tests. Tests on primary taps (open taps) must be done as individual tests with the test current shut off between tests.

The low resistance ohmmeter must have sufficient current capacity to saturate the windings. The time taken to test will depend on the available test current. Large transformers require special attention prior to performing the tests. The insulation between the windings will store energy, similar to the dielectric in a cable, and must be discharged before a test can be done.

When three-phase transformers are tested, interaction will occur between the primary and secondary windings. This situation is most evident when transformers with Wye and Delta windings are tested, and can be minimized by connecting the test current to flow through both primary and secondary windings. The net effect is to reduce the mutual coupling between the windings and minimize the flow of circulating current in the delta winding.

The recommended test current is between 1 - 10% of the nominal current, but not above 15%. Over 15% will cause heating, as it will affect their resistance value significantly. The lower test currents reduce stress in the magnetic core of the winding, but will increase the test time.

Large test currents produce large forces on the core and can cause damage and generate heat, which will affect the resistance value.

It is also important that the instrument discharges the transformer when the measurement is completed. If not, lethal voltages can be present at disconnection. Dedicated test instruments with these features integrated are available.

Warning: Never use a non-dedicated LRO to measure the winding resistance on a power transformer. Lethal voltages can be present if a winding is not discharged correctly before the test leads are disconnected.

Motor bar to bar tests

Helical spring point probes are used to measure the value of the bar to bar resistances of the rotor in a d.c. motor (see Fig 31). This test is typically done at the 10 A current level with the typical coil resistance measurements in the 6000 microhm range. These tests identify broken/ loose welds or solder connections between the coils and commutator bars. The resistance measurements should remain consistent. Readings can be higher on a heated motor, due to the temperature of the coils. As the coils cool, the resistance values can drop to some prior reference value recorded at ambient temperature.

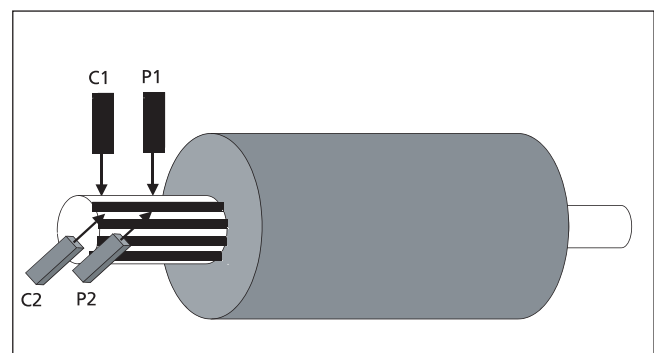

Fig 31: Bar to bar test on d.c. motor rotor

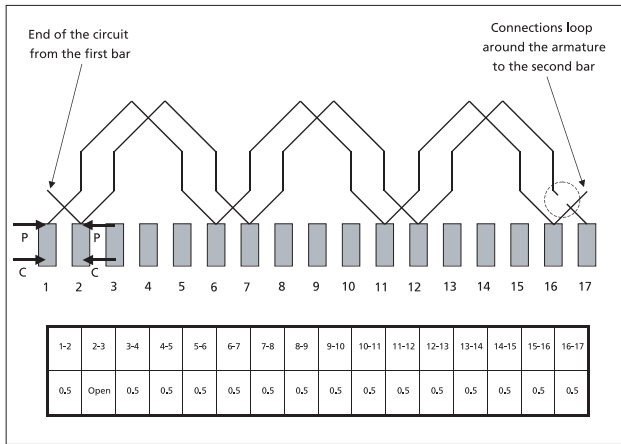

Fig 32: Lap winding test data

Fig 32 shows a lap winding, a style where the windings are connected to bars laying next to each other. To make a test, the current probe should be placed at the end of the commutator bar and the potential probe should be placed at the connection to the winding (the riser on the commutator bar). The user measures the resistance of the windings between each set of bars under test (1 - 2, 2 - 3, 3 - 4, etc.). In this example, there is a possible weak solder joint between bars 4 and 5, and a break in the coil between bars 12 and 17 (the instrument will show this as an open).

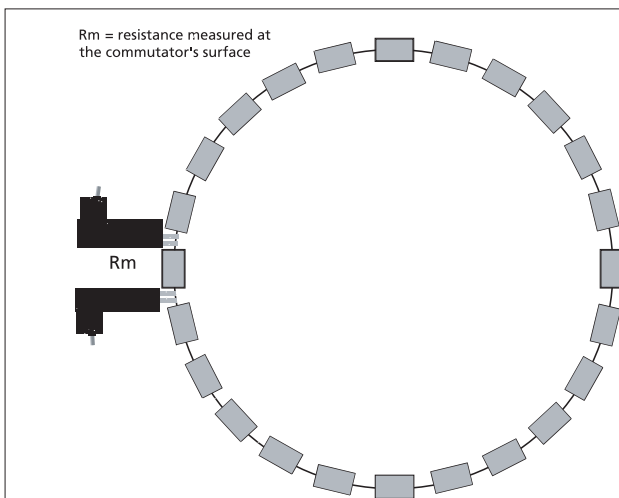

Fig 33: Commutator with 24 coils in series

In Fig 33 (lap winding, 24 coils), all the coils are connected in series.

The resistance of each coil will be measured with the resistance of all of the other coils connected in parallel. The primary question for the user is what constitutes an acceptable reading for a specific coil (R_m) since the remaining 23 coils in parallel will lower the resistance of the coil being tested. For this example, we will assume that the resistance of the coil before insertion into the motor (R_c) was 1 A.

The expected resistance can be calculated by the equation:

$$Expected R_m = (R_c)(\# \text{ of coils being tested})/(\# \text{ of coils in parallel})/(\# \text{ of coils being tested} + \# \text{ of coils in parallel})$$

In this example:

$$Expected R_m = (1 A)(1)(23)/(1 + 23)$$

$$Expected R_m = 0.958 A$$

Fig 34 shows a wave winding, another manufacturing technique for putting high resistance coils in a motor. In this example, the coil runs from commutator bar 1 to 6 to 11 to 16 and then loops back around the armature to commutator bar 2 (connected in series). When the user measures between bars 1 and 2, he / she is checking the resistance of the wave wound coil (the complete loop). In this example, there is a break in the coil between bars 12 and 17. This problem will appear when measuring bars 2 and 3, since they are the start and end bars of the loop.

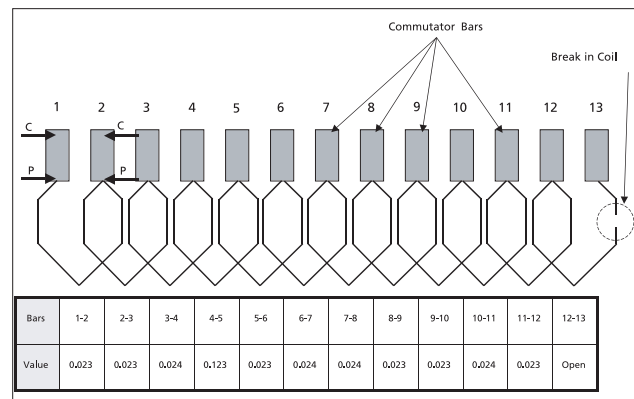

Fig 34: Wave winding test data

35 on the following page shows wave winding commutator connections to the internal coils and test probe connections to individual commutator bars. This is a simplified layout, as the heavy ring shows the series connections for all the coils in the armature. A d.c. motor will have a different number of coils depending on the horse power and the voltage rating. In this example (tests from bar #1 to bar #2), two coils are in series and nineteen are in parallel. If one coil is open in the ring, the measurement from bar #1 to bar #2 will be the series value of the two coils. If the test probes are across the open coil, the total resistance of the other nineteen coils will be shown.

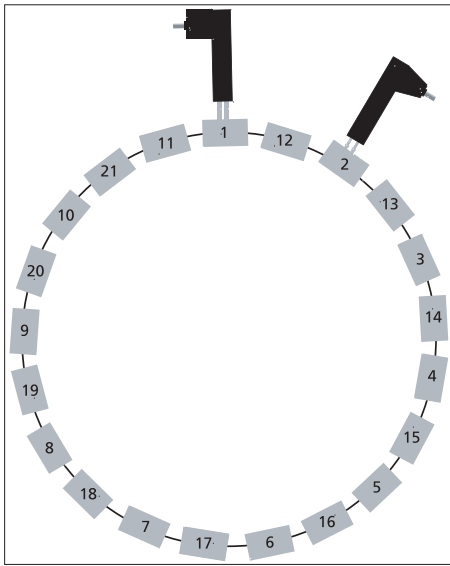

Fig 35: Wave winding coil arrangement

Battery strap tests

When battery straps are tested, the user should have baseline values or targets to compare against the actual results.

The following are examples of how these target levels are determined:

Example 1: In Fig 36, the user is measuring the resistance (R_0) across a single battery strap (both sides of the terminal). The straps on each side of the terminal have a resistance of 20 microhm and the connections to the terminals each have a resistance of 5 microhm. Under these conditions, the target resistance that the user wants to see is 15 microhm. A significant variance from this resistance in the actual reading would show a loose connection.

Example 2: Fig 37 shows terminals connected in parallel by carrier strips with a resistance of 100 microhm. In this case, the target resistance that the user wants to see is 14 microhm.

If there was an open strap between terminal 'a' and terminal 'b', the resistance reading would be significantly higher than the target, as follows:

$$R_{a-b} = R_{a-c} + R_{c-d} + R_{b-d}$$

$$R_{a-b} = 100 + 15 + 100$$

$$R_{a-b} = 215 \mu\Omega$$

Additional tests can be done between the same polarity terminals on a cell. Such a test will help determine the quality of the terminal-to-bar welds and major problems with the internal bar to which the plates are welded, as all are series connected. In this example, the measured resistance between like terminals on the same cell should be in the 100 microhm range.

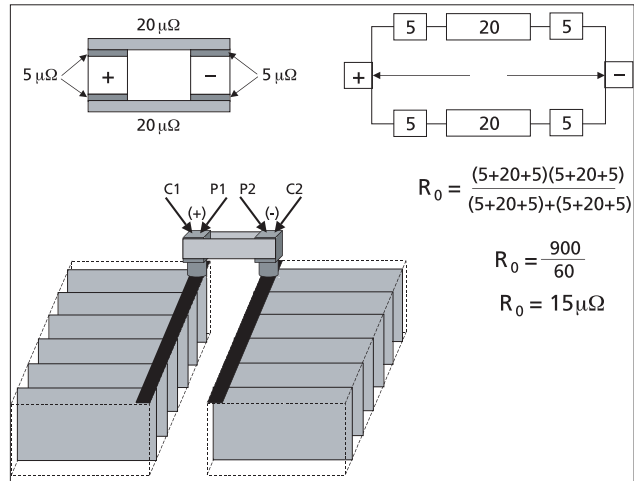

Fig 36: Single strap resistance target

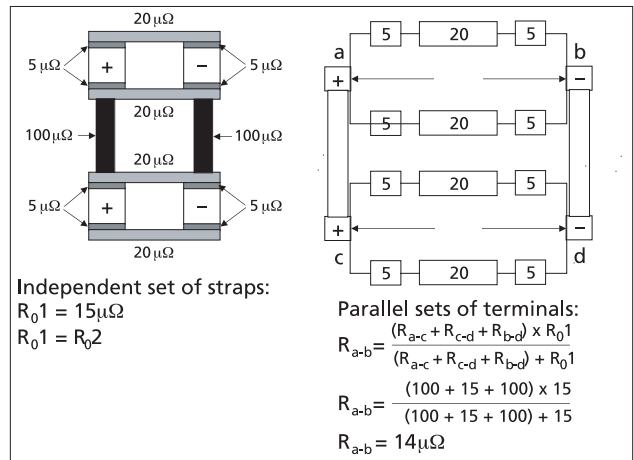

Fig 37: Parallel strap resistance target

Ramp testing

A ramp test delivers a controlled 'ramp' of the output current from 0 up to the required output. This ability is particularly beneficial where there are protection relays in place, typically in the form of differential relays.

When the contact resistance of a circuit breaker is tested, a differential relay monitors the line for any sudden rise in current that may be an a.c. signal. If the rise in current is too fast the differential relay detects this as a fault and trips the circuit breaker, as it would do under normal operating conditions.

By the application of the current at a slower rate, which is variable and configurable, it allows low resistance test equipment to be used with a multitude of protection relays, each with different sensitivities.

This means that the protection relays can stay in place and removes the undesirable need to disconnect the protection relay in a test.

Protection relays are also sensitive to the a.c. ripple, which can exist within the output current of the test equipment. These small ripples can look like a potential fault, for example, a.c. signal and also trip the Circuit Breaker under test.

Is this a reason to keep these relays in place?

Smooth current output enables protection to remain in place during testing thus maximizing safety for the user.

Wheatstone and Kelvin bridges

A Wheatstone bridge can be used to measure resistance by comparing an unknown resistor against precision resistors of known value. A Kelvin double bridge is a variant of the Wheatstone bridge and can be used for measuring very low resistances.

Wheatstone bridge

A pioneering method for measuring resistance was devised in 1833 by S. H. Christie and made public by Sir Charles Wheatstone. The simplest arrangement is a square pattern of four resistors with a galvanometer connected across one diagonal and a battery across the other (see Fig 38). Two of the resistors are of known appropriate values and comprise the ratio arm (A + B). A third has a known value which can be varied in small increments over a wide range, and is thus designated the rheostat arm (R). The fourth is the resistance being measured, the unknown arm (X).

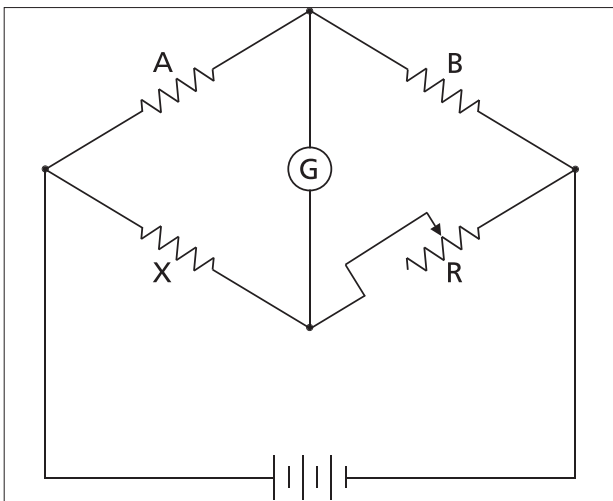

Fig 38: Wheatstone bridge circuit¹

The bridge is considered balanced when the rheostat arm has been adjusted (tweaked) so that current is divided in such a way that there is no voltage drop across the galvanometer and it ceases to deflect (is nulled). The resistance being measured can then be calculated from a knowledge of the

1 Electrical Meterman's Handbook; Third Edition; 1965; page 479

values of the ratio resistors and the adjusted value of the rheostat arm. The basic formula is:

$$X = B/A \times R$$

Where:

B and A are the ratio resistors

R is the rheostat

The Wheatstone Bridge can be constructed to a variety of ranges and is generally used for all but the highest and lowest measurements. It's suited to a range of about 1 to 100,000 A.

Kelvin bridge

The Kelvin Bridge (also known as the Thomson Bridge) is used for precision measurements below the typical range of the Wheatstone Bridge. Sir William Thomson (Lord Kelvin) devised the concept circa 1854. The classic arrangement has six resistors in a rectangle, bisected by a galvanometer (see Fig 39). A comparatively large current is passed through the unknown resistance and a known resistance of a low value. The galvanometer compares the voltage drops across these two resistances with the double ratio circuit comprised of the other four resistors.

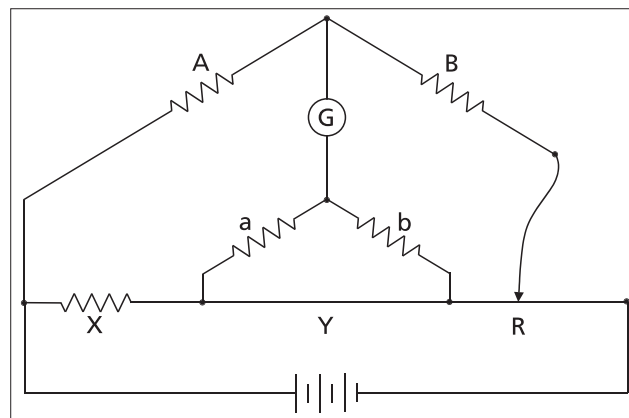

Fig 39: Kelvin bridge circuit²

For very low measurements, the Kelvin Bridge has the advantage of nullifying extraneous resistances from leads and contacts by employing the system of double ratio arms. The resistances of the connecting leads are in series with the high resistance ratio arms and not with the reference or tested resistors. The two pairs of ratio resistors (A/B, a/b) are paralleled with each other and connected across with the galvanometer. One pair (a/b) is in series with the unknown (X) and the

2 Electrical Meterman's Handbook; Third Edition; 1965; page 480

A guide to low resistance testing

reference standard (R). The latter is an adjustable low resistance, usually a Manganin bar with a sliding contact. When potential is balanced across the two parallel circuits, the unknown is equivalent to the parallel ratio multiplied by the adjusted reference value.

$$X = A/B \times R$$

A connecting link (Y), sometimes called the yoke, shunts the ratio pair (a/b) that are otherwise in series with the unknown and standard, but has minimal effect on the accuracy of the measurement so long as the two pairs of parallel ratio resistors are kept exactly equal (A to a, B to b). Lead and contact resistances are included in the value of the ratio pairs, and any effects can be nullified by keeping the resistance of the yoke extremely low. Keeping the yoke resistance low also accommodates the large test currents often used in Kelvin Bridges without causing unwanted heating effects.

DLRO microohm and milliohm applications list

Aviation

- Assembly of components
- Interconnection of equipment
- Repair and maintenance

Rail, including tram and underground

- Rolling stock and infrastructure
- Track high current joints
- Signalling systems

Marine

- Power wiring systems
- Protection systems
- Ship-to-shore bonding
 - Cable
 - Connection points
- Cathode protection system testing

Oil and gas pipelines

- Bonding between welded joints
- Grounding systems

Automotive and electric vehicles

- Battery connections
- Weld quality
- Quality of crimped connections
- Assembly robot welding cables

Cable manufacturers

- Quality control
- Cable length

Component manufacturers

- Quality control
 - Resistors, inductors, chokes

All types of mechanically assembled joints which need low resistance values

- Bolted
- Welded
- Compressed
- Crimped
- Soldered
- Conductive adhesive
- Joints subject to
 - Stress
 - Vibration
 - Heat
 - Cold
 - Corrosion
 - Fatigue

Cable manufacturers

- Motors and generators
- Coil and turn-to-turn shorts
- Bar-to-bar tests
- Coil balance — cold to full load current comparison

Space exploration and engineering

- Structural metal to metal
- Ground network metal to metal
- Carbon fiber to metal
- Carbon fiber to carbon fiber

Data centers

- During installation
 - Main panel supplies
 - UPS supplies
 - Generator supplies
 - Verification of protective device contact resistance
 - Busbar parallel feeds
 - Busbar lapped joints
 - Optimum resistance over torque
 - Cable lug to busbar connections
 - Copper cable to lug to busbar fault finding
- During maintenance
 - Using trending data of all of the above aspects
 - Verification after repair

Medical

- Grounding and bonding systems for protection against
 - Microshock
 - Macroshock
- On new, in service, fully or partly connected systems
- Each medical location should be tested regularly to local standard requirements

Robotics

- Wiring systems and connections which are subject to stress/movement/vibration
- Bonding of component parts to minimize static
- Grounding of machine
- Welding leads of robot spot welder

Electrical infrastructure

- Transformer windings
- Substation wiring and grounding
- Tap changers
- Battery strap resistance testing
- Cable resistance from one end
- Cable length
- Identification of parallel supplies while connected
- Cable to lug to connection fault finding
- Checking assembled connections

Megger products overview

Megger offers solutions to ensure electrical system performance with its comprehensive line of low resistance ohmmeters and Micro-ohmmeters. An overview of the various products available is described below.

For more information on these and many other Megger products, please contact us at 866-254-0962 or. Or visit our web site us.megger.com for the most up-to-date news, product and service information 24 hours a day.

DLRO2

The DLRO2 is a hand held 2 A low resistance ohmmeter, and is the latest in a long line of instruments to proudly display the Ducter™ brand.

The IP54 rating ensures that rain or dust will not prevent outdoor testing.

The DLRO2 has a dedicated test to optimize the output for applications with long test leads. The long test lead function provides up to 1 A of test current into 3.2 ohms resistance. This makes the DLRO2, with optional cable reel test leads, ideal for testing wind turbine and avionic lightning protection applications.

To allow testing of smaller inductive loads the DLRO2 can apply 1 A continuously, made possible by high capacity rechargeable batteries, with a separate inductive load function.

The DLRO2 is equipped with a new innovative feature called a difference meter. This allows repetitive measurements to be easily compared with an initial reference measurement. The difference meter translating percentage difference to a needle / pointer movement to make it visually easy to see change. New reference measurements can be set at any time at the push of a button.

The DLRO2 provides 1% accuracy with a focus on repeatability making it ideal for repeated quality tests in production and industrial applications.



Fig 40: DLRO2

DLRO10 / DLRO10X

The DLRO10 and DLRO10X are built into a strong, lightweight case that is equally suitable in the field or in the laboratory. Light enough to be worn around the neck, they are small enough to be taken into areas which were previously too small to access. The DLRO10 uses a large, bright 4.5 digit LED display while the DLRO10X has a large, backlit LCD.

The DLRO10 displays the average of measurements achieved using forward and reverse current, while the DLRO10X displays both individual measurements and the average. The DLRO10X uses a menu system controlled by a two axis paddle to allow the user to manually select the test current. The unit also adds real time download of results and on-board storage for later download to a PC.



Fig 41: DLRO10 / DLRO10X

DLRO10HD / DLRO10HDX

Common with the DLRO10 series, the DLRO10HD and DLRO10HDX feature output power limiting to 0.25 W so as not to heat the test piece. However, the DLRO10HD and DLRO10HDX have the additional benefit of combining this with two high power, high compliance ranges. Benefits include the ability to use much longer test leads, the ability to heat and, therefore, identify circuit weakness and the ability to maintain 10 A for at least a minute, which allows for improved tests on inductive loads. In addition the DLRO10HDX comes with on-board memory for up to 200 test records and the ability to download saved test results to external software.



Fig 42: DLRO10HD

The two instruments are designed to operate in the harshest of conditions, surviving knocks, drops, dusty and wet conditions. They can be used in the rain, and, with the lid closed, are sealed to IP65. There is no need to worry about inadvertent connection to live supplies. High input protection shrugs it off without even blowing a fuse.

The DLRO10HD and DLRO10HDX are powered by a rechargeable battery or from mains power, which makes them suitable to do continuous tests in a production line or repetitive use environments, even with the internal battery on charge. You never have to wait for the battery to charge.

A guide to low resistance testing

Series 247000

This traditional line from Megger has been the hallmark of quality and reliability since the emergence of the DLRO, and remains as popular today as ever. Decades of proven field use have made them the defining standard in ruggedness and portability.

Three 10 A models in the series offer highest accuracy combined with user friendly ease of operation:

Cat. No. 247000 features the tried and popular dual-pak design, where the charger is a separate item that can be left behind while the measuring module affords the maximum in portability. Where self containment is a premium.

Cat. No. 247001 combines the measurement module and charger in a single-pak instrument without loss of convenient portability.

Cat. No. 247002 is a single-pak instrument as well, with an added range for extra precision, down to 0.1 mA resolution.



Fig 43: DLRO247000

DLRO100 series

The DLRO100 offers a unique range of 100 A digital low resistance testers. Never before has CAT IV 600 V safety, operational IP54 ingress protection for dust and water, and lightweight, fast charge, Li Ion battery technology been available on a continuous 100 A low resistance tester.

Providing low resistance measurements across a multitude of applications, including areas without access to mains power, the DLRO100 is extremely flexible. Some example applications include switchgear, circuit breaker contact resistance, bus bar and cable joints, wire and cable resistance, lightning conductor bonding, welded joints, ground connections and joints.

Megger has taken a no compromise approach when designing the new DLRO100 series. The range offers a unique combination of features, including DualGround™ tests, adjustable current ramp tests, high noise immunity, high power 100 A continuous tests and even remote control, yet it still manages to be small and lightweight.

There are three models in the series, all of which have CAT IV 600 V and can test currents from 10 A to 110 A. The mid-range model adds data storage and DualGround™ tests. The top of the range model adds to this, the capability of asset tags to enter unique asset ID's with the DLRO100 Asset Tag Windows app, Bluetooth® download and USB remote operation.



Fig 44: DLRO100 Series

DLRO200

The DLRO200 is designed to check and measure contact resistance in high voltage circuit breakers, disconnecting switches (isolators), bus bar joints, or for any low resistance measurement. DLRO200-EN and DLRO200-115 accurately measure resistances ranging from 0.1 microhm to 1 ohm, at high currents.

This versatile instrument can provide test currents from 10 A up to 200 A, subject to the load resistance and supply voltage. The DLRO200 delivers an unfiltered d.c. current and can drive 200 A through a total current loop resistance of 19 milliohm (Supply >207 V, 11 milliohm for 115 V supply).

The unique design allows the weight and size of the DLRO200 to be kept to a minimum; the instrument weighs less than 14.5 kg (32 lbs). This small size plus a water / dust ingress rating of IP54 makes the test set equally at home in the workshop, on the production floor or in the field.

As well as adding notes to stored results, the alphanumeric keypad allows you to set the test current directly by keying in the value required. The DLRO200 will check the continuity of the test circuit, and will quickly ramp the test current up to the desired level. The keyboard is also used to set upper and lower limits for the result and to prevent the use of excessive currents by setting an upper limit to the allowable test current.



Fig 45: DLRO200

MOM2

The MOM2 micro-ohmmeter is designed to measure the resistance of circuit breaker contacts, bus bar joints and other high current links.

MOM2 uses an ultra capacitor to generate the high output current. The ultra capacitor is able to store a huge amount of energy compared to conventional capacitors and can deliver very high current during the discharge thanks to its very low internal resistance.

The MOM2 can be used anywhere to measure a low resistance value with high accuracy.

With the MOM2 it is possible to make measurements according to the DualGround™ method. This means that the test object will be grounded on both sides throughout the test giving a safer, faster and easier workflow.



Fig 46: MOM2

A guide to low resistance testing

MJÖLNER200 / MJÖLNER600

The MJÖLNER200 and MJÖLNER600 micro-ohmmeters, like the MOM2, are designed to measure the resistance of circuit breaker contacts, bus bar joints and other high-current links, and in addition also measures contact elements in bus bars.



Fig 47: MJÖLNER200

With MJÖLNER200, its high current capability, up to 200 A d.c., the user avoids problems with incorrect test results due to low test current when high current devices such as circuit breakers are tested. It can also do true d.c. ripple free current tests of bus bars, circuit breakers, fuses, etc.

Use the MJÖLNER600, with excessive power resources for demanding applications, for superior measurement accuracy and when 300 A continuous is required.



Fig 48: MJÖLNER600

The MJÖLNER200 and MJÖLNER600 also make measurements according to the DualGround™ method, the same as the MOM2, and can be used anywhere to measure a low resistance value with high accuracy.

With its lightweight and rugged suitcase design, it makes the MJÖLNER200 and MJÖLNER600 an excellent choice when a portable solution is needed. When the case is closed, the product can withstand the impact of water, dust or sand – it even floats.

Optional accessories are a remote control and PC software.

MOM200A / MOM600A

The MOM200A™ is designed to check and measure contact resistances in high voltage circuit breakers, disconnecting switches (isolators) and bus bar joints. It is an excellent choice when 200 A or less are needed for measurement.

The MOM200A is ideal for finding poor connections, since it can put out 100 A for extended periods. Its range, extending up to 20 milliohm, makes it ideal for measuring many different types of connections, and, with its weight at 14 kg (31 lb), it's convenient to take along with you.

The MOM600A, with output current between 100 and 660 A, comes in two versions, a 115 V and a 230 V.

A complete MOM200A and MOM600A includes a cable set (including separate sensing cables) and a transport case.



Fig 49: MOM200A / MOM600A

DLRO600

All the features of the DLRO10 and 10X, plus additional current up to 600 A to accommodate the preferred standards to test circuit breaker contacts. Yet ease of portability has been retained, with the instrument weighing in at only 33 pounds!

Measurement range from 0.1 microhm to 1 ohm facilitates all standard high current requirements. Memory stores up to 300 results while an RS232 connection enables downloading to printer or laptop. The added data manipulation capabilities enable current limitation at standard values up to 600 A, thereby eliminating the need for multiple testers to conform to a variety of standards.



Fig 50: DLRO600

MOM690A

The MOM690A supplements Meggers family of micro-ohmmeters. In addition to high current capacity, the MOM690A features microprocessor based measurement, storage and reporting. The built-in software enables individual tests or a whole series of tests and store the results.

With the optional MOMWin™ software test results can also be exported to a PC for further analysis and reporting. Ranges are set automatically, resistances are measured continually and test results can be automatically captured at a preset test current.

After a circuit breaker with a Current Transformer (CT) mounted in its current circuit has been tested, e.g. dead tank and GIS breakers, some standards recommended that the CT is demagnetized. This troublesome task can be accomplished quickly and easily thanks to the a.c. output of the MOM690. The a.c. output can also be used as a general multi-purpose current source in different applications.



Fig 51: MOM690A

Duplex connect test lead system

The Megger Duplex Connect test lead system can be used with the 10 A DLRO instruments.



Fig 52: Duplex connect test leads

This test lead system provides the most cost effective and convenient way to provide the user with many test lead lengths, including extensions, and the ability to connect test lead terminations required for the many different applications encountered in low resistance testing.

One set of test leads, all the terminations.

At the center of this unique test lead system is the bespoke four terminal connectors (two in each test lead), which allows terminations such as kelvin clips or duplex test probes to be used as required.

There are two connector versions, one without and one with indicator LEDs, which operate with the DLRO10 range of instruments.

Product comparison chart



Technical Data	DLR02	DLR010	DLR010X	DLR010HD
Test currents	1 mA to 2 A	10 A	10 A	0.1 - 10 A
Current steps	1 mA, 10 mA, 100mA 1 A and 2 A	Preset values: 100 µA, 1 mA, 10 mA, 100 mA, 1 A, 10 A	Preset values: 100 µA, 1 mA, 10 mA, 100mA, 1 A, 10 A	Preset values: 0.1 mA, 1 mA, 10 mA, 100 mA, 1 A, 10 A
Max test time at max current	1 A continuous on inductive mode	1 A continuous on inductive mode	1 A continuous on inductive mode	60 sec
Max continuous current	2 A	10 A	10 A	10 A
Max. resistance for max. current	2 A with up to 1.1 Ω total resistance and 1 A with up to 3.2Ω total resistance.	1.999 mΩ***	1.999 mΩ***	250 mΩ
Measurement range	0 Ω to 2000 Ω	1.9999 mΩ - 1999.9Ω	1.9999 mΩ - 1999.9Ω	0 Ω - 250 mΩ
Best resolution	1 µΩ	0.1 µΩ	0.1 µΩ	0.1 µΩ
Inaccuracy	± 1% ± 2 digit	± 0.2% ± 0.2 µΩ	± 0.2% ± 0.2 µΩ	± 0.2%
Ripple free DC	■	■	■	■
Additional smoothing on DC				
DualGround				
Ramp up/down (Automatic)				
AC Demagnetization				
Remote control				
Built in printer				
User settable High and low test limits			■	
Data storage			■	
Memo field for stored test results			■	
Communication PC			RS232	
Battery operated	■	■ Detachable battery pack	■ Detachable battery pack	■**
CAT rating *	CAT III 600 V	CAT III 600 V	CAT III 600 V	CAT III 300 V
External voltage protection	600 V AC or DC Test inhibit Without blowing a fuse	600 V AC or DC Test inhibit Without blowing a fuse	600 V AC or DC Test inhibit Without blowing a fuse	600 V AC or DC Test inhibit Without blowing a fuse
Noise immunity spec	80 mV peak 50/60/400 Hz (Differential)	100 mV 50/60 Hz (Differential)	100 mV 50/60 Hz (Differential)	100 mV 50/60 Hz (Differential)
IP rating	IP54 in use			IP65 closed IP54 open
Tough transport case housing	Hand held			■
Weight excluding leads	905 g	2.6 kg (5.7 lbs)	2.6 kg (5.7 lbs)	6.7 kg (14.77 lbs)
Dimensions	228 x 105 x 75 mm (8.98 x 4.1 x 2.95 in)	220 x 100 x 237 mm (8.66 x 3.9 x 9.3 in)	220 x 100 x 237 mm (8.66 x 3.9 x 9.3 in)	315 x 285 x 181 mm (12.4 x 11.2 x 7.1 in)



DLRO10HDX	DLRO100	DLRO200	DLRO200-115	Comments
0.1 - 10 A	10 - 110 A	10 - 200 A		
Preset values: 0.1 mA, 1 mA, 10 mA, 100 mA, 1 A, 10 A	1 A (Also 10 A, 50 A and 100 A presets)	1 A		
60 sec	10 min	>10 min		
10 A	100 A (10min)	200 A (15 min)		Long test times can help locate weaknesses by heating
250 mΩ	100 mΩ	19 mΩ	11 mΩ	Subtract expected test resistance and you can calculate max. test lead length ***Power limited to 0.25W for sensitive applications
0 Ω - 250 mΩ	0.1 μΩ - 1.999 Ω	0.1 μΩ - 999.9 mΩ		
0.1 μΩ	0.1 μΩ	0.1 μΩ		
± 0.2%	± 0.2% + 2 μΩ	± 0.7% + 1 μΩ		
■	■		■	Ideal for testing circuit breakers with active relay system connected without tripping
			■	Can test most circuit breakers with active relay system connected without tripping
	■			Used when testing circuit breakers with both sides connected to ground, without additional inaccuracy.
	■	■	■	Ideal for testing circuit breakers with active relay system connected without tripping
	■ Depending on model			
	■ Depending on model	■	■	Ideal for rapid testing to pre-determined test limits
■	■ Depending on model	■	■	
		■	■	Make note of issues or corrective action required
USB	USB Depending on model	RS232	RS232	
■**	■**			*Operates from line supply even with a dead battery
CAT III 300 V	CAT IV 600 V *Touch proof clips	CAT II 300 V	CAT II 300 V	**Touch proof clips reduce chance of causing arc flash over in live environments
600 V AC or DC Test inhibit Without blowing a fuse	600 V AC or DC Test inhibit Without blowing a fuse			Particularly important when testing in close vicinity of live voltage
100 mV 50/60 Hz (Differential)	100 mV 50/60 Hz (Differential)	5 V rms 50/60 Hz (common mode)	5 V rms 50/60 Hz (common mode)	Reflects instruments ability to work in electrically noisy environments such as high voltage sub-stations
IP65 closed IP54 open	IP65 closed IP54 open	IP53	IP53	High IP ratings ideal for outdoor operation
■	■			
6.7 kg (14.77 lbs)	7.9 kg (18 lbs)	14.5 kg (33 lbs)	14.5 kg (33 lbs)	Weight excluding leads
315 x 285 x 181 mm (12.4 x 11.2 x 7.1 in)	400 x 300 x 200 mm (16 x 12 x 7.9 in)	410 x 250 x 270 mm (16 x 10 x 11 in)	410 x 250 x 270 mm (16 x 10 x 11 in)	Dimensions

Product comparison chart



Technical Data	DLRO600	Mjolner200	Mjolner600	MOM2	MOM200
Test currents	10-600 A	5 - 200 A	5 - 600 A	220 A	0 - 200 A
Current steps	1 A	1 A	1 A		
Max test time at max current	<60 sec	2 min	15 sec	3 sec - discharging	20 sec
Max continuous current	200 A (15 min)	200 A	300 A	N/A	100 A (15 min)
Max. resistance for max. current	11 mΩ	19mΩ, with cables	2mΩ, with cables	2 mΩ, with cables	17mΩ, with cables
Measurement range	0.1 μΩ - 999.9 mΩ	0 μΩ - 999.9 mΩ	0 μΩ - 999.9 mΩ	0 μΩ - 1000 mΩ	0 μΩ - 19.99 mΩ
Best resolution	0.1 μΩ	0.1 μΩ	0.1 μΩ	1.0 μΩ	1.0 μΩ
Inaccuracy	0.6% + 0.3 μΩ	± 0.3 μΩ	± 0.3 μΩ	± 1% + 1μΩ	± 1% + 1 μΩ
Ripple free DC		■	■	■	
Additional smoothing on DC					
DualGround		■	■	■	
Ramp up/down (Automatic)	■	■	■		
AC Demagnetization					
Remote control		■	■	■	
Built in printer		■	■		
User settable High and low test limits	■			■	
Data storage	■	■	■	■	
Memo field for stored test results	■				
Communication PC	RS232	USB	USB	Bluetooth	
Battery operated				■	
CAT rating *	CAT II 300V				
External voltage protection					
Noise immunity spec	5 V rms 50/60 Hz (common mode)				
IP rating	IP53	IP41	IP41	IP54	IP20
Tough transport case housing		■	■		
Weight excluding leads	14.5 kg (33 lbs)	8.8 kg (20 lbs)	13.8 kg (31 lbs)	1.0 kg (2lbs)	14.6 kg (32 lbs)
Dimensions	410 x 250 x 270 mm (16 x 10 x 11 in)	486 x 392 x 192 mm (19 x 15 x 7.6 in)	486 x 392 x 192 mm (19 x 15 x 7.6 in)	217 x 92 x 72 mm (8.5 x 3.6 x 2.8 in)	280 x 178 x 246 mm (11 x 7 x 9.7 in)

A guide to low resistance testing



MOM600A	MOM690	Comments
0 - 600 A	0 - 800 A	
15 sec	Instant shut off	
100 A	100 A (10 min)	Long test times can help locate weaknesses by heating
9mΩ, with cables	With cables, 600A 0,5mΩ	Subtract expected test resistance and you can calculate max. test lead length ***Power limited to 0.25W for sensitive applications
0 μΩ - 1999 mΩ	0 μΩ - 200 mΩ	
1.0 μΩ	1.0 μΩ	
± 1% + 1 μΩ	± 1% + 1 μΩ	
		Ideal for testing circuit breakers with active relay system connected without tripping
		Can test most circuit breakers with active relay system connected without tripping
		Used when testing circuit breakers with both side connected to ground, with out additional inaccuracy.
		Ideal for testing circuit breakers with active relay system connected without tripping
		■
		Ideal for rapid testing to pre-determined test limits
		Make note of issues or corrective action required
		■
		*Operates from line supply even with a dead battery
	CAT I	**Touch proof clips reduce chance of causing arc flash over in live environments
		Particular important when testing in close vicinity of live voltage
		Reflects instruments ability to work in electrically noise environments such as high voltage sub-stations
IP20	IP20	High IP ratings ideal for outdoor operation
24.7 kg (55 lbs)	23.7 kg (52 lbs)	Weight excluding leads
356 x 203 x 241 mm (14 x 8 x 9.5 in)	350 x 270 x 220 mm (14 x 11 x 8.7 in)	Dimensions

*For measuring circuits used to measure any other electrical signal CAT II the transient stresses must be considered by the user to assure that they do not exceed the capabilities of the measuring equipment. The expected transient level for CAT IV is 6000 V, CAT III 4000 V, CAT II 2500 V and for CAT I 1500 V. For CAT I the transient levels can be specified differently and they are then designed and tested accordingly to assure that they withstand the expected transients.



Megger
2621 Van Buren Avenue • Norristown, PA 19403 USA
866-254-0962

us.megger.com

DLRO_AG_en_V04

The word 'Megger' is a registered trademark. Copyright © 2018

Megger[®]