



**TELEDYNE LECROY**  
Everywhereyoulook™



# **Current Probes**

## **User Manual**

CP030B, CP150B



## CP030B and CP150B Current Probes User Manual

© 2023 Teledyne LeCroy, Inc. All rights reserved.

Teledyne LeCroy is a registered trademark of Teledyne LeCroy, Inc. Other product or brand names are trademarks or requested trademarks of their respective holders. Information in this publication supersedes all earlier versions. Specifications are subject to change without notice.

Users are permitted to duplicate and distribute Teledyne LeCroy documentation for internal training purposes only. Resale or unauthorized duplication of Teledyne LeCroy documentation materials is strictly prohibited.

CP\*\*\*B-probes-manual-eng\_05oct23.pdf  
October, 2023

---

# Contents

<b>Introduction</b> .....	<b>1</b>
<b>Safety Instructions</b> .....	<b>2</b>
Symbols .....	2
Precautions .....	2
<b>Specifications</b> .....	<b>4</b>
Warranted Characteristics .....	4
Nominal Characteristics .....	4
Typical Characteristics .....	5
Environmental Characteristics .....	5
Physical Characteristics .....	6
Safety Ratings .....	6
Maximum Input Current vs. Frequency .....	7
Insertion Impedance vs. Frequency .....	8
Amplitude vs. Frequency .....	9
<b>Operation</b> .....	<b>10</b>
Connecting to the Test Instrument .....	11
Connecting to the Test Circuit .....	11
Operating with an Oscilloscope .....	12
<b>Performance Verification</b> .....	<b>15</b>
Preliminary Procedure.....	15
Functional Check .....	15
Test Equipment Required.....	16
Check LF Accuracy CP030B .....	17
Check LF Accuracy CP150B .....	18
CP_____ Test Record.....	20
<b>Care and Maintenance</b> .....	<b>21</b>
Cleaning .....	21
Calibration Interval.....	21
Service Strategy .....	21
Troubleshooting.....	21
<b>Returning a Product for Service</b> .....	<b>22</b>

---

# CP030B and CP150B Current Probes

---

<b>Technical Support .....</b>	<b>23</b>
Live Support and Service.....	23
Resources .....	23
<b>Certifications.....</b>	<b>24</b>
European Council .....	24
United Kingdom .....	25
China .....	25
Australia & New Zealand.....	26
<b>Warranty .....</b>	<b>27</b>

## Introduction

The CP series current probes are designed for easy, highly accurate current measurements. The probes utilize a combination of Hall-effect and transformer technology to enable measurements to be made on DC, AC and impulse currents over a wide bandwidth range with over-current protection.

With the ProBus interface, the probe becomes an integral part of the measuring instrument. The bandwidth limit, Auto Zero and Degauss functions are all controlled from the instrument's touch screen user interface. The interface provides power to the probe, so no external power supply is needed.

CP current probes are compatible with most Teledyne LeCroy oscilloscopes with a ProBus interface running MAUI™ firmware version 10.4.x.x or later.

Contact your local service center to determine whether the oscilloscope may be made compatible with the probes with appropriate software upgrades.





**NOTE:** CP probes cannot be used with the AP-1M adapter to achieve 1 M $\Omega$  coupling.

# Safety Instructions

Follow these instructions to keep the probe operating in a correct and safe condition. Observe generally accepted safety procedures in addition to the precautions specified here. **The overall safety of any system incorporating this product is the responsibility of the assembler of the system.**

## Symbols

These symbols appear on the probe body or in documentation to alert you to important safety considerations.

	<b>WARNING</b> , possibility of electric shock or burn.
	<b>CAUTION</b> of damage to probe or instrument, or <b>WARNING</b> of hazard to health. Attend to the accompanying information to protect against personal injury or damage. Do not proceed until conditions are fully understood and met.
	Do not apply around or remove from <b>UNINSULATED HAZARDOUS LIVE</b> conductors which may render electric shock, electric burn, or arc flash.
	Equipment protected by double insulation or reinforced insulation.
	<b>CAUTION</b> , hot surface.

## Precautions



Comply with the following safety precautions to avoid personal injury or damage to your equipment:

**Use only as specified.** The probe is intended to be used only with compatible Teledyne LeCroy instruments. Using the probe and/or the equipment it is connected to in a manner other than specified may impair the protection mechanisms.

**Do not use the probe for measurements on Mains circuits.** The probe should only be applied around or removed from insulated, limited-energy circuit conductors that are not directly connected to the mains.

**Do not overload; observe all ratings.** To avoid electric shock or fire, do not connect the current probe to any wire that carries voltages or currents that exceed the ratings of the probe.

**Connect and disconnect properly.** Connect the probe to the test instrument before connecting to the circuit/conductor being measured.

**Avoid damaging the cable through excessive bending.**

**Never install or remove the probe on bare conductors which are energized.** The transformer core and shield are grounded but not insulated and may contact the conductor when the locking lever is open.

**Be careful not to damage the insulation surface** when making measurements. Before clamping to the conductor being measured, check that the insulation on the conductor is undamaged, and take care not to damage the insulation when clamping the conductor. Any damage to the insulation could cause an electric shock.

**Use only indoors within the operational environment listed.** Do not use in wet or explosive atmospheres.

**Do not remove the probe's casing.** Touching exposed connections may result in electric shock.

**Keep product surfaces clean and dry.**

**Comply with the maximum input current vs. frequency derating** when measuring current that includes a high frequency component. Using the probe at high frequencies or in strong magnetic fields may cause the device to become abnormally hot, resulting in fire, equipment damage or burns.

**Do not operate with suspected failures.** Before each use, inspect the probe and accessories for any damage such as tears or other defects in the probe body, cable jacket, accessories, etc. If any part is damaged, cease operation immediately and sequester the probe from inadvertent use.

**NOTE:** Depending on the amplitude and frequency of the current being measured, the sensor head may emit a resonant sound. This sound may also occur during demagnetizing operation, but it does not represent a malfunction (device failure).

# Specifications

For the most current specifications, see the card included with the product. Specifications are subject to change without notice.

## Warranted Characteristics

	CP030B	CP150B
<b>Amplitude Accuracy</b>	±1% of reading to 30 Arms ±2% of reading to 50 Apeak	±1% of reading to 150 Arms ±2% of reading to 300 Apeak
<b>Bandwidth (probe only)</b>	DC to 50 MHz	DC to 10 MHz

## Nominal Characteristics

	CP030B	CP0150B
<b>Max Continuous Input Current</b>	30 Arms at 0.1 V/A 5 Arms at 1V/A	150 Arms at 0.01V/A 30 Arms at 0.1V/A
<b>Max Peak Current*</b>	50 Apeak non-continuous	300 Apeak non-continuous
<b>Intended Output Load</b>	1 M $\Omega$	
<b>Sensitivity</b>	1 mA/div to 50 A/div	100 mA/div to 100 A/div
<b>Measured Conductors</b>	Insulated conductors only	

\* Peak pulse width  $\leq 10 \mu\text{s}$ .



## Typical Characteristics

	CP030B	CP150B
<b>Output Voltage</b>	1 V/A and 0.1 V/A	0.1 V/A and 0.01 V/A
<b>Sensitivity Temperature Coefficient</b>	$\pm 2\%$ or less (0 °C to +40 °C)	+2%, -6% (0 °C to +40 °C)
<b>Noise at 20 MHz BW</b>	$\leq 150 \mu\text{Arms}$	$\leq 1.8 \text{ mArms}$
<b>Rise Time</b>	$\leq 7\text{ns}$	$\leq 35 \text{ ns}$

## Environmental Characteristics

	CP030B	CP0150B
<b>Operating Temperature</b>	0 °C to 40 °C	
<b>Operating Relative Humidity (RH)</b>	$\leq 80\%$ (non-condensing)	
<b>Storage Temperature</b>	-10 °C to 50 °C	
<b>Storage Relative Humidity (RH)</b>	$\leq 80\%$ (non-condensing)	
<b>Maximum Altitude</b>	2000 m	
<b>Effect in an External DC/60 Hz, 400 A/m Magnetic Field</b>	Max 5 mA	Max 150 mA

### Physical Characteristics

	CP030B	CP150B
<b>Probe Head Length</b>	176.15 mm (6.9 inch)	173.82 mm (6.8 inch)
<b>Probe Head Width</b>	19.8 mm (0.78 inch)	30.2 mm (1.19 inch)
<b>Probe Head Height</b>	39.5 mm (1.56 inch)	67.74 mm (2.67 inch)
<b>Maximum Diameter of Conductors Measured</b>	5 mm (0.2 inch)	20 mm (0.79 inch)
<b>Cable Length</b>	1.5 m (4.9 feet)	2 m (6.5 feet)
<b>Weight</b>	236 g (0.52 lbs)	490 g (1.08 lbs)

### Safety Ratings

	Rating	Definition (per EN IEC 61010-2-032:2021)
<b>Probe Designation</b>	Type D	Probe is intended to be applied around or removed from insulated conductors only.
<b>Measurement Category (CAT)</b>	No rated measurement category	Probe is not intended for measurements on circuits directly connected to Mains supply. Not rated for measurements within CAT II, III or IV.
<b>Safe Voltage Rating</b>	Use only on fully insulated conductors	Probe is not rated for measurements on uninsulated conductors.
<b>Pollution Degree</b>	2	Use only in an operating environment where normally only dry, non-conductive pollution occurs. Temporary conductivity caused by condensation should be expected.

## Maximum Input Current vs. Frequency

### CP030B

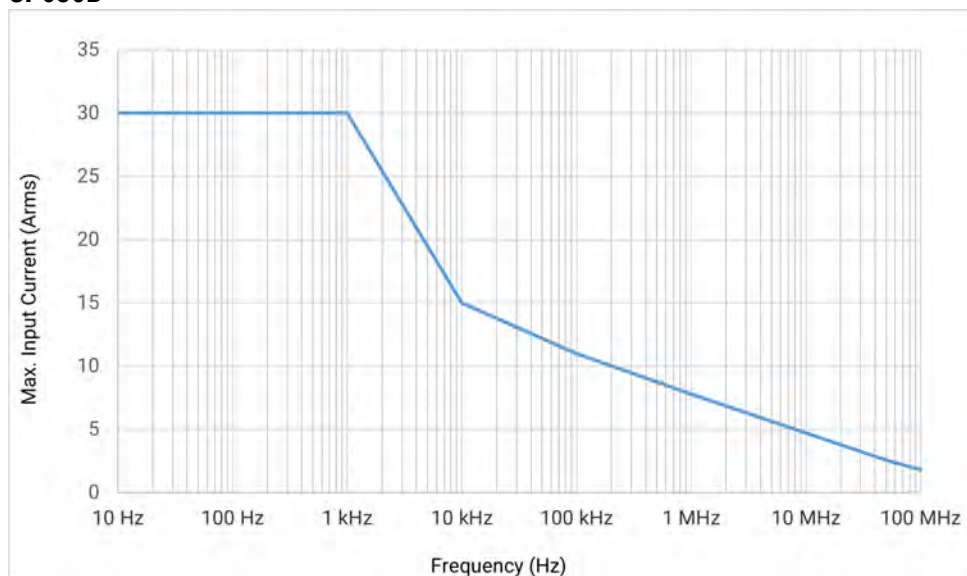

### CP150B

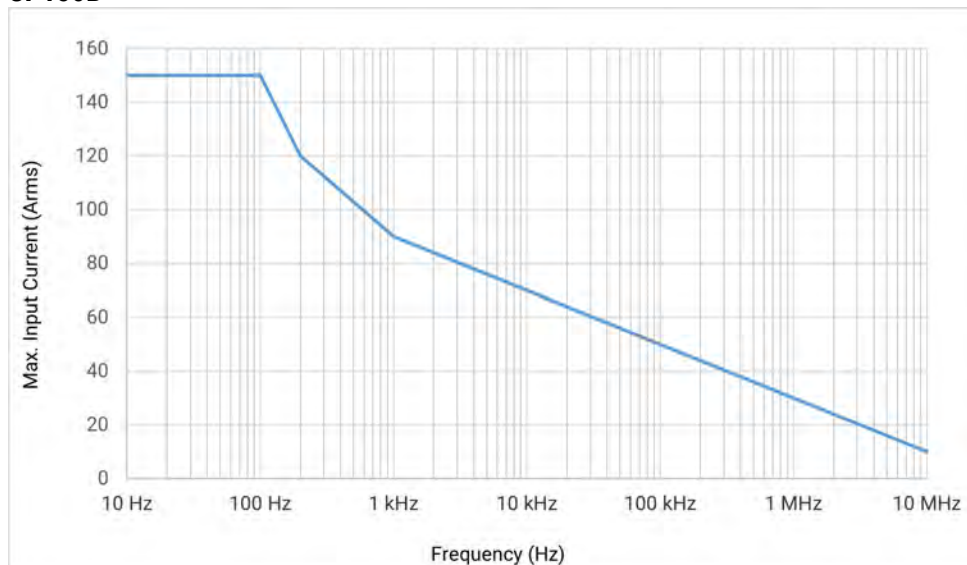

## Insertion Impedance vs. Frequency

### CP030B

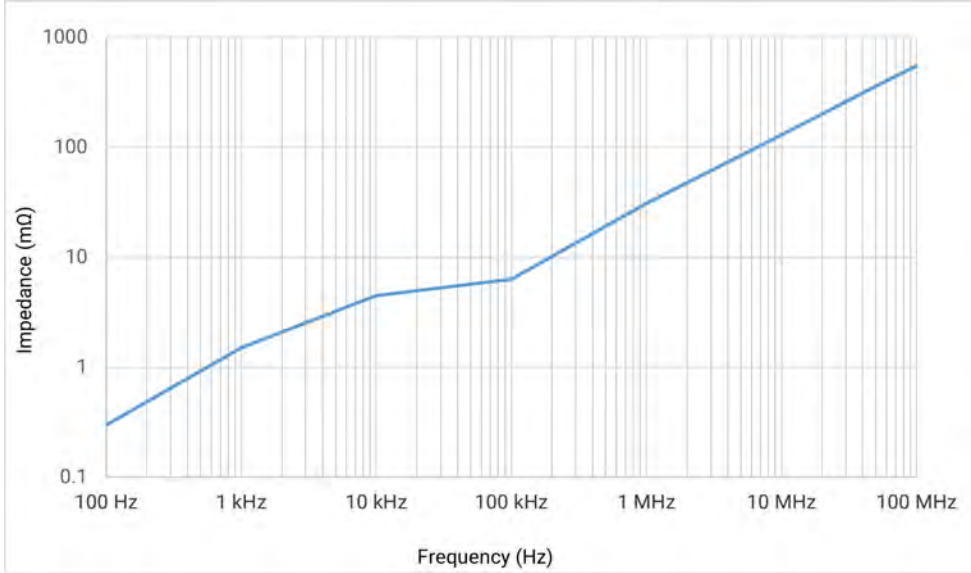

### CP150B

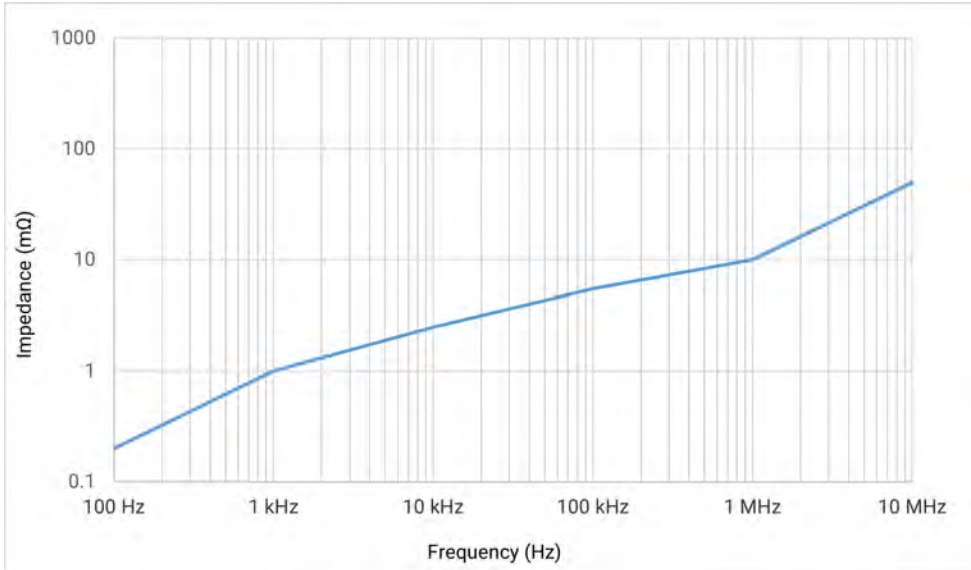

## Amplitude vs. Frequency

### CP030B

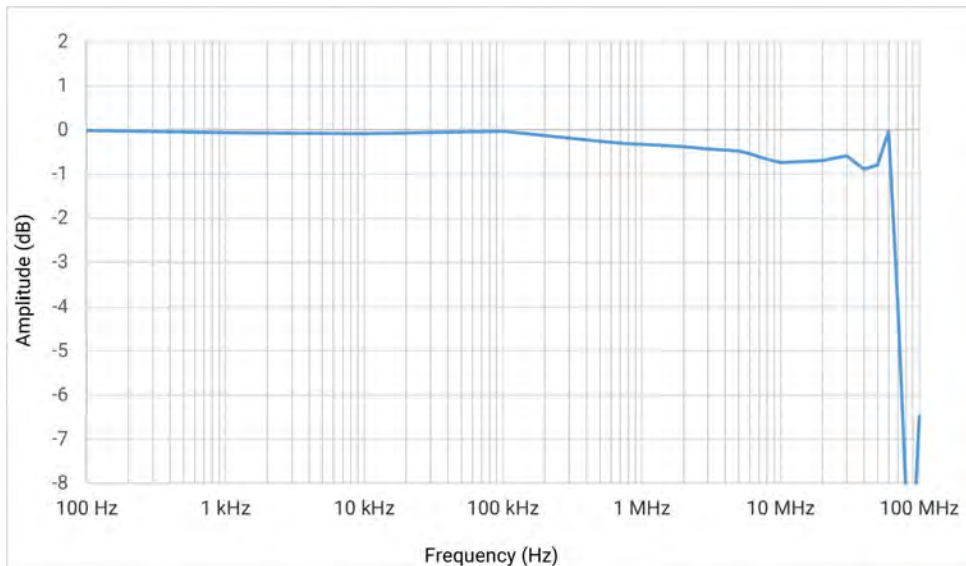

### CP150B

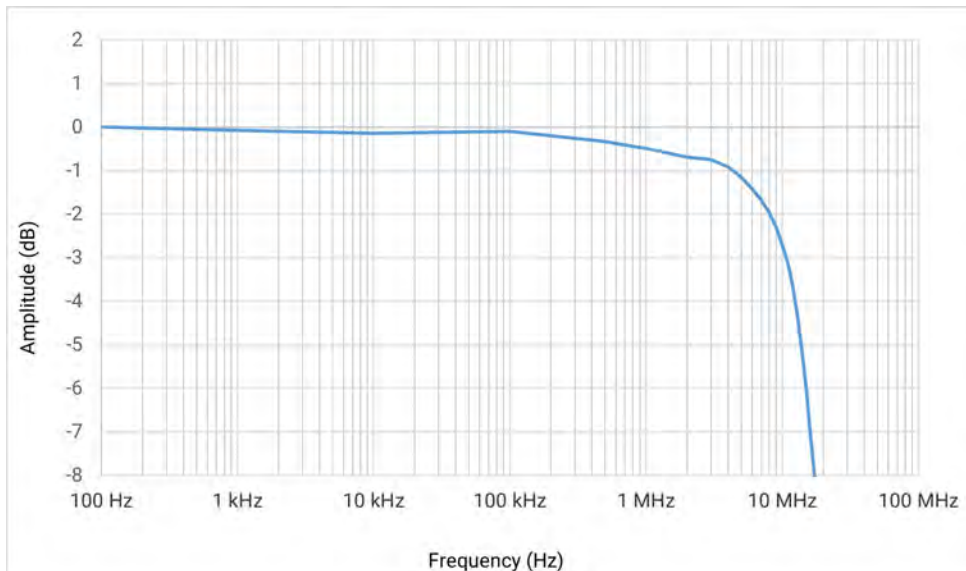

### Operation

**NOTE:** Operation of the probe as described requires software version 10.4.x.x or higher. To confirm the version installed, choose Utilities > Utilities Setup from the oscilloscope menu bar, then open the Status tab.

The sensor head is a precision assembly consisting of a molded component with a ferrite core and a Hall effect element. It may be damaged if subjected to sudden changes in temperature, mechanical strain or shock, or application of static electricity.

The mating surfaces of the sensor are precision ground and should be treated with care. If there is any type of dust or dirt on the mating surfaces of the sensor head, measurements may be impaired.

Accurate measurements may not be possible in locations subject to strong magnetic fields such as transformers and high-current conductors, or in locations subject to strong external electric fields.



**WARNING:** Comply with the probe derating when measuring current that includes a high frequency component. Never measure any current that exceeds the rated current. Using the probe at high frequencies or in strong magnetic fields may cause the probe head to become abnormally hot, resulting in equipment damage or personal injury.

---



**CAUTION:** Do not touch the probe head after disconnecting from the circuit until it has had sufficient time to cool. Using the probe near the upper limits for current and ambient temperature for extended lengths of time may cause the probe head surface to become hot to the touch.

---



**CAUTION:** Do not use this probe to measure Mains circuits. Using the probe on uninsulated hazardous live conductors may result in electric shock, burn, or arc flash.

---



**CAUTION:** Never use this probe on bare conductors. The core and shield are grounded, and any voltage applied to the conductor may cause damage the probe or the circuit under test. **Always connect the probe to a powered-on oscilloscope before clamping it to an active conductor. Failure to do so may damage the probe or test instrument.**

---

## Connecting to the Test Instrument

The probe has been designed for use with the Teledyne LeCroy instruments equipped with the ProBus interface. When you attach the probe output connector to the instrument's input connector, the instrument will:

- Recognize the probe model
- Set the input termination to 1 M $\Omega$
- Activate the probe control functions in the touch screen user interface.

## Connecting to the Test Circuit

The probe has been designed with a movable split core, eliminating the need to break the conductor for the core to slip around the conductor. To connect:

1. Pull back the slider so that the clamp opens.
2. Align the sensor so that the current direction indicator corresponds to the direction of current flow in the conductor.

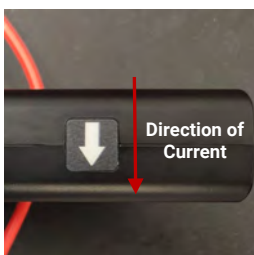
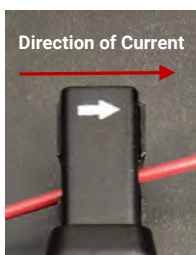

3. Close the slider on the sensor head to the locked position until the "UNLOCK" indicator disappears.



4. Verify that the opening lever is firmly locked and the clamp is securely closed.

### Operating with an Oscilloscope

When connected to a Teledyne LeCroy oscilloscope, the displayed scale factor and measurement values will be automatically adjusted to account for the effective gain of the probe. A/div, Offset, and Coupling, and Bandwidth (BWL) are controlled from the Channel setup (Cn) dialog.



*Channel setup dialog with Probe dialog behind it.*

The probe's attributes are shown on the Probe dialog, which appears behind the Channel dialog when a probe is detected. The Probe dialog also contains controls for Auto Zero and Degauss.

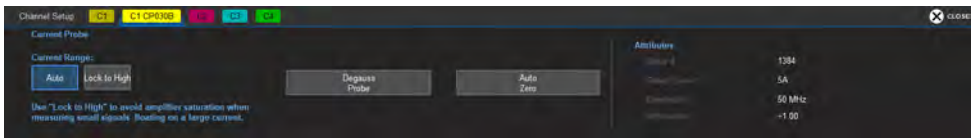

*Probe dialog.*

### PROBE A/DIV AND ATTENUATION

The front panel Volts/div knob controls the oscilloscope's scale factor and the probe's internal attenuation to give full available dynamic range (see Nominal Characteristics table p.4 ). Alternatively, A/div may be controlled from the Channel setup dialog. There are two options as to how the probe will set attenuation relative to the oscilloscope's A/div setting:

**Auto** will automatically raise the attenuation when the A/div setting is higher than the attenuation threshold of the probe, or lower attenuation when the A/div setting is below the threshold. As a result, the probe can automatically adjust attenuation to properly view the input waveform. The Auto attenuation thresholds are:

- CP030B: 500 mA/div
- CP150B: 2 A/div

**Lock to High** locks the attenuation setting to the highest attenuation, regardless of the A/div setting. Maintaining a high attenuation will allow small signals on a larger current waveform to be accurately measured.



## BANDWIDTH LIMIT

The CP030B is capable of switching from Full (maximum bandwidth) to 20 MHz bandwidth by changing the Bandwidth setting on the Channel dialog. The CP150B probe is limited to 20 MHz bandwidth.

## AC COUPLING

In general, using offset to adjust a DC current on the screen is the preferred method to measure transient signals in the presence of a larger DC currents. The offset function has limits that will cause a signal that is beyond the linear operating range of the probe to go off the screen, preventing measurement errors.

There are times, however, when it is convenient to use AC coupling to remove the DC component of the measured signal from the measurement. Selecting AC coupling on the Channel dialog uses the oscilloscope AC coupling at the probe output to remove any steady state value from the displayed current.

**NOTE:** Since this AC coupling is on the probe output, DC current beyond the linear range of the probe will cause the probe to saturate and make the displayed waveform inaccurate. It is important not to exceed the maximum linear input values when using AC coupling.

The maximum linear DC input current is:

Model	Maximum Linear DC Input Current
CP030B	30 A at 0.1 V/A sensitivity ( $>500$ mA/div) 5 A at 1 V/A sensitivity ( $>500$ mA/div)
CP150B	150 A at 0.01 V/A sensitivity ( $>2$ A/div) 30 A at 0.1 V/A ( $\leq 2$ A/div)

### **AUTO ZERO**

After several minutes of warm-up, or when the probe is exposed to a large shift in ambient temperature, some DC offset drift may occur. The Probe dialog incorporates an Auto Zero function to remove the DC offset from the current probe. Auto Zero must be invoked by the user. Open the Probe dialog and touch **Auto Zero**.

### **DEGAUSS**

If the probe has been magnetized by external magnetic field or by excessive input, the core can be demagnetized by degaussing. The demagnetizing process takes about 5 seconds and should always be performed before taking a measurement.

Without clamping the probe around a conductor, slide the opening lever to close and lock the probe. Open the Probe dialog and touch **Degauss**.

An Auto Zero is automatically performed as part of the degauss cycle.

## Performance Verification

Performance verification can be used to verify the warranted characteristics of the probe. The recommended calibration interval for Current Probes is one year. The complete performance verification procedure should be performed as the first step of annual calibration. Performance verification can be completed without removing the probe covers or exposing the user to hazardous currents. Test results can be recorded on a photocopy of the Test Record provided.

The warranted characteristics of the probe are valid at any temperature within the Environmental Characteristics listed in the Specifications. However, some of the other test equipment used to verify the performance may have environmental limitations required to meet the accuracy needed for the procedure. Make sure that the ambient conditions meet the requirements of all the test instruments used in his procedure.

### Preliminary Procedure

1. Connect the probe to the C1 input of the instrument and completely close the probe slider.
2. Turn on the instrument and allow at least 30 minutes warmup time for the probe before performing the verification procedure.
3. Turn on the other test equipment and allow these to warm up for the time recommended by the manufacturer.
4. While the instruments are reaching operating temperature, make a photocopy of the Performance Verification Test Record and fill in the necessary data.

### Functional Check

This procedure verifies the basic operation of the probe functions. It is recommended to perform it prior to the Check LF Accuracy procedure.

1. Open the C1 setup dialog and confirm that the bandwidth is set to **Full** (BWL OFF).
2. Verify that the probe is sensed and the probe dialog appears behind the C1 setup dialog.
3. Open the probe dialog and touch **Degauss**, then **OK**.
4. Confirm that the message "**Performing Degauss on CPxx-xx....**" is displayed in the message bar and that no error messages are displayed.

## Current Probes

---

### Test Equipment Required

The following table lists the test equipment (or equivalents) which are required for performance verification of the CP series current Probes. Because the input and output connector types may vary on different brands and models of test instruments, additional adapters or cables may be required.

Description	Minimum Requirements	Example Equipment
Wide Band Oscilloscope	200 MHz bandwidth ProBus interface	Teledyne LeCroy WaveSurfer 4000HD
Digital Multimeter (2)	DC: 0.1% Accuracy 5½ digit resolution	Agilent 34401A Fluke 8842A-09
Function Generator	50 Hz sine wave output 3 Vrms into 50Ω	Teledyne Test Tools T3AFG5 Stanford Research Model DS340
Calibration Fixture	100 turn loop in series with 0.5Ω ±0.1% resistor with sense terminals 500 turn loop in series with 0.5Ω ±0.1% resistor with sense terminals	Teledyne LeCroy CP030-CF02 Teledyne LeCroy CP150-CF02
Calibration Fixture	ProBus Extension Cable	Teledyne LeCroy PROBUS-CF01
Banana Plug Adapter	Female BNC to Dual Banana Plug	Pomona 1269
Patch Cables (4)	Male Banana to Male Banana, 12"	Pomona B-12-0 (black) Pomona B-12-2 (red)
BNC Adapter	BNC Male to Dual Banana Jack	Pomona 1296

## Check LF Accuracy CP030B

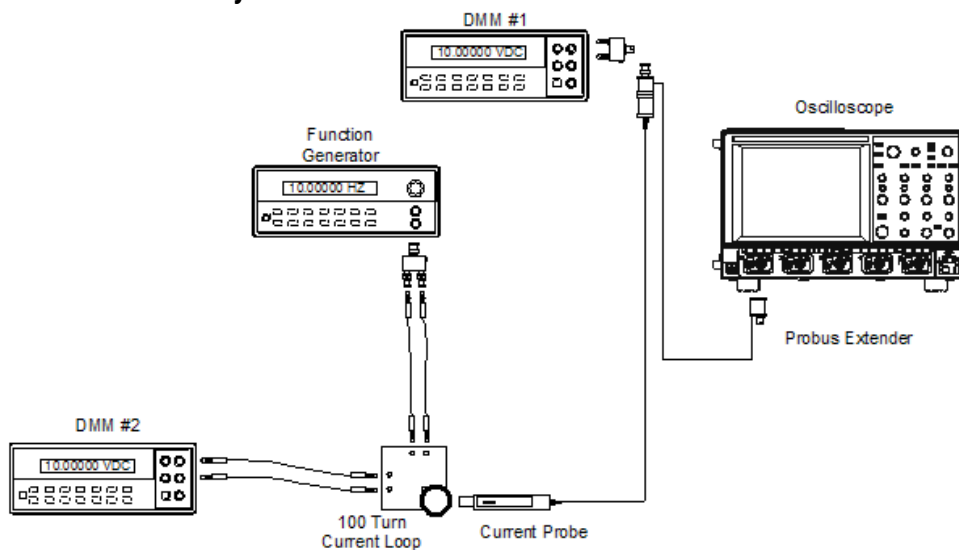

*LF Accuracy Test set up.*

1. Set the Function generator to 50 Hz sine wave, output voltage at 3 Vrms with 50Ω output.
2. Remove the probe from the instrument and reconnect using the ProBus extension cable. Connect the BNC male connector of the ProBus extension to DMM #1 using a BNC Female to Dual Banana adapter.
3. Using Banana Patch cords and the BNC to Dual Banana Plug adapter, connect the 'V Source' and 'V Return' terminals of the 100 Turn Calibration Loop to the output of the Function Generator.
4. Connect the Current Sense terminals of the 100 Turn Calibration Loop to the voltage inputs of DMM #2.
5. Set both DMMs to measure AC Volt.
6. With the probe removed from any signal and the slider returned to the LOCKED position, degauss the probe by pressing the **Degauss** button.
7. Set the current probe channel sensitivity to 1 A/div.
8. Open the probe slider and position the probe input around the 100 Turn loop. Close and LOCK the slider.

## Current Probes

- Adjust the Function generator voltage until the voltage measured at the 'Current Sense' terminals (DMM #2) reads 50 mV  $\pm$ 0.05 mV. (This corresponds to 10 A at the probe head).
- Record the voltage measured by DMM #1 on the Test Record.
- Verify that the measured voltage is between 0.989 volt and 1.011 volt.

## Check LF Accuracy CP150B

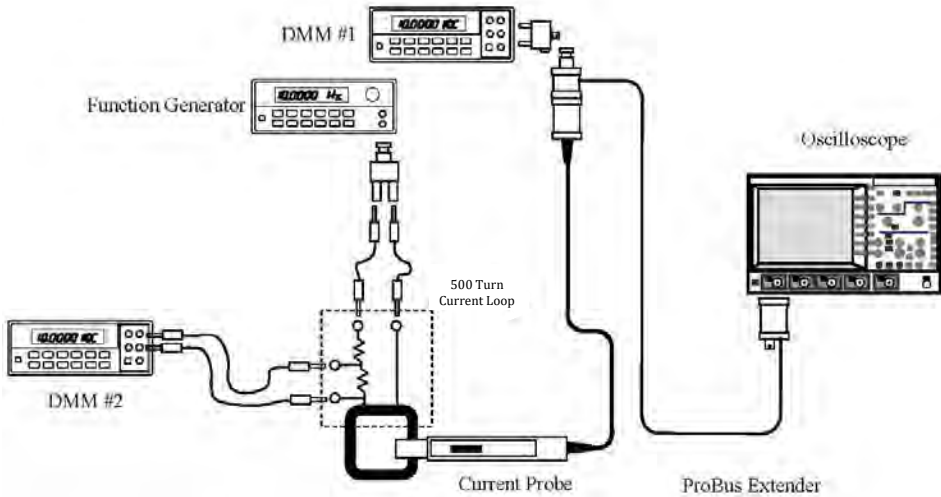

*LF Accuracy Test set up.*

- Set the Function generator to 50 Hz sine wave, output voltage at 1.7 Vrms with 50  $\Omega$  output.
- Remove the probe from the instrument and reconnect using the ProBus extension cable. Connect the BNC male connector of the ProBus extension to DMM #1 using a BNC Female to Dual Banana adapter.
- Using Banana Patch cords and the BNC to Dual Banana Plug adapter, connect the 'V Source' and 'V Return' terminals of the 500 Turn Calibration Loop to the output of the Function Generator.
- Connect the Current Sense terminals of the 500 Turn Calibration Loop to the voltage inputs of DMM #2.
- Set both DMMs to measure AC Volt.
- With the probe removed from any signal and the slider returned to the LOCKED position, degauss the probe by pressing the **Degauss** button.

7. Set the current probe channel sensitivity to 10 A/div.
8. Open the probe slider and position the probe input around the 500 Turn loop. Close and LOCK the slider.
9. Adjust the Function generator voltage until the voltage measured at the 'Current Sense' terminals (DMM #2) reads 10 mV  $\pm$ 0.01 mV (10 A at the probe head).
10. Record the voltage measured by DMM #1 on the Test Record.
11. Verify that the measured voltage is between 99 mV and 101 mV.

# CP\_\_\_\_\_ Test Record

**Model:** \_\_\_\_\_

**Serial Number:** \_\_\_\_\_

**Asset/Tracking Number:** \_\_\_\_\_

**Date:** \_\_\_\_\_

**Technician:** \_\_\_\_\_

Equipment	Model	Serial Number	Calibration Date
Digital Multimeter #1			
Digital Multimeter #2			
Function Generator*			N/A

\* The function generator is used for making relative measurements. The output of the generator is measured with a DMM or oscilloscope. Thus, the generator is not required to be calibrated.

Step	Description	Intermediate Data	Test Result
10	Probe Output		_____ V

Permission is granted to photocopy this page and record the results of the performance verification procedure on the copy. File the completed record as required by applicable internal quality procedures.

Results recorded under "Test Result" are the actual specification limit check. The test limits are included in all of these steps. Record other measurements and intermediate calculations that support the limit check under "Intermediate Data".



## Care and Maintenance

### Cleaning

The exterior of the probe and cable should be cleaned only using a soft cloth moistened with water or isopropyl alcohol. The use of abrasive agent, strong detergents or other solvents may damage the probe.



---

**CAUTION:** The probe casing is not sealed and should never be immersed in any fluid.

---

### Calibration Interval

The recommended calibration interval is one year. Adjustment should only be performed by qualified personnel. (A performance verification procedure is included in this manual.)

### Service Strategy

Defective probes must be returned to a Teledyne LeCroy service facility for diagnosis and exchange. A defective probe under warranty will be replaced with a factory refurbished probe. A probe that is not under warranty can be exchanged for a factory refurbished probe. A modest fee is charged for this service. A defective probe must be returned in order to receive credit for the probe core.

### Troubleshooting

If the probe is not operating properly the problem may be the way in which it is used. Before assuming the probe is defective, perform the following troubleshooting procedures:

1. Verify the test instrument is running the required firmware (10.4.x.x or higher).
2. If the waveform is inverted, check that the arrow on the slider is in the direction of the current flow.
3. If there is no signal, check that the slider is closed and locked.

### Returning a Product for Service

Contact your local Teledyne LeCroy service center for calibration or other service. If the product cannot be serviced on location, the service center will give you a Return Material Authorization (RMA) code and instruct you where to ship the product. All products returned to the factory must have an RMA.

**Return shipments must be prepaid.** Teledyne LeCroy cannot accept COD or Collect shipments. We recommend air freighting. Insure the item you're returning for at least the replacement cost.

1. Remove all accessories from the probe.
2. Pack the probe in its case. If possible, include all tips. Do not include the manual.
3. Pack the case in its original shipping box, or an equivalent carton with adequate padding to avoid damage in transit.
4. Mark the outside of the box with the shipping address given to you by Teledyne LeCroy. Be sure to add the following:
  - ATTN:<RMA code assigned by Teledyne LeCroy>
  - FRAGILE
5. **If returning a probe to a different country:** contact Teledyne LeCroy Service for instructions on completing your import/export documents.

Extended warranty, calibration and upgrade plans are available for purchase. Contact your Teledyne LeCroy sales representative to purchase a service plan.

For a complete list of Teledyne LeCroy offices by country, including our sales and distribution partners, visit: [teledynelecroy.com/support/contact](http://teledynelecroy.com/support/contact).

## Technical Support

### Live Support and Service

For a complete list of offices by country, including our sales and distribution partners, visit:

[teledynelecroy.com/support/contact](https://teledynelecroy.com/support/contact)

Teledyne LeCroy  
700 Chestnut Ridge Road  
Chestnut Ridge, NY, 10977, USA  
[teledynelecroy.com](https://teledynelecroy.com)

### US Sales and Service:

Ph: 800-553-2769 / 845-425-2000

FAX: 845-578-5985

### US Support:

Ph: 800-553-2769

[support@teledynelecroy.com](mailto:support@teledynelecroy.com)

### Resources

Teledyne LeCroy publishes a free Technical Library on its website. Manuals, tutorials, application notes, white papers, and videos are available to help you get the most out of your Teledyne LeCroy products. Visit:

<https://teledynelecroy.com/support/techlib>

# Certifications

Teledyne LeCroy certifies compliance to the following standards as of the time of publication.

## European Council



The probe bears this mark to indicate it conforms to all applicable European Council standards. Please see the EC Declaration of Conformity document shipped with your product for current certifications.

## EC DECLARATION OF CONFORMITY - EMC

The probe meets the intent of EC Directive 2014/30/EU for Electromagnetic Compatibility.

EN IEC 61326-1:2021 EMC requirements for electrical equipment for measurement, control, and laboratory use. 1, 2

EN IEC 61326-2-1:2021 Particular requirements for sensitive test and measurement equipment for EMC unprotected applications.

<sup>1</sup> Emissions which exceed the levels required by this standard may occur when the instrument is connected to a test object.

<sup>2</sup> This product is intended for use in nonresidential areas only. Use in residential areas may cause electromagnetic interference.

## EC DECLARATION OF CONFORMITY – SAFETY

The probe meets the intent of EC Directive 2014/35/EU for Product Safety. Compliance was demonstrated to the following specifications as listed in the Official Journal of the European Communities:

EN 61010-1:2010+A1:2019 Safety requirements for electrical equipment for measurement, control, and laboratory use – Part 1: General requirements

EN IEC 61010-2-032:2021 Safety Requirements for Electrical Equipment for Measurement, Control, and Laboratory Use – Part 2-032: Particular Requirements for Hand-Held and Hand Manipulated Current Sensors for Electrical Test and Measurement.

## END-OF-LIFE HANDLING / WEEE



The probe is marked with this symbol to indicate that it complies with the applicable European Union requirements to Directives 2012/19/EU on Waste Electrical and Electronic Equipment (WEEE).

The probe is subject to disposal and recycling regulations that vary by country and region. Many countries prohibit the disposal of waste electronic equipment in standard waste receptacles. For more information about proper disposal of your Teledyne LeCroy product, visit [teledynelecroy.com/recycle](http://teledynelecroy.com/recycle).

### **RESTRICTION OF HAZARDOUS SUBSTANCES (ROHS)**

The probe conforms to the 2011/65/EU RoHS2 Directive inclusive of any further amendments or modifications of said Directive.

IEC/EN 63000:2018 Technical documentation for the assessment of electrical and electronic products with respect to the restriction of hazardous substances

### **European Contact:\***

Teledyne GmbH – LeCroy Division  
Im Breitspiel 11c  
D-69126 Heidelberg  
Germany  
Tel: (49) 6221 82700

### **United Kingdom**



The probe bears this mark to indicate it conforms to all applicable United Kingdom standards for EMC and Safety. The design of the product has been verified to conform to the applicable harmonized standards and technical specifications and is in conformity with the relevant Union harmonization legislation below:

UK SI 2016 No. 1101 The Electrical Equipment (Safety) Regulations 2016

UK SI 2016 No. 1091 Electromagnetic Compatibility Regulations 2016

UK SI 2012 No. 3032 Restriction of the Use of Certain Hazardous Substances in Electrical and Electronic Equipment Regulations 2012

### **China**



Unless otherwise specified, all materials and processes are compliant with the latest requirements of China RoHS. The hazardous substances contained in the product are disclosed in accordance with the standards:

SJ/T 11364-2014 Marking for the Restricted Use of Hazardous Substances in Electronic and Electrical Products

GB/T 26572-2011 Requirements on Concentration Limits for Certain Restricted Substances in Electrical and Electronic Products).

## Current Probes

---

### **Australia & New Zealand**

The probe complies with the EMC provision of the Australian Communication and Media Authority (ACMA) Radio Communications Act:

AS/NZS CISPR 11:2017/A1:2020, EN 55011:2016+A2:2021 Radiated and Conducted Emissions, Group 1, Class A.

### **Australia / New Zealand Contacts:\***

RS Components Pty Ltd.  
Suite 326 The Parade West  
Kent Town, South Australia 5067

RS Components Ltd.  
Unit 30 & 31 Warehouse World  
761 Great South Road  
Penrose, Auckland, New Zealand

\* Visit [teledynelecroy.com/support/contact](http://teledynelecroy.com/support/contact) for the latest contact information.

## Warranty

Teledyne LeCroy warrants this oscilloscope accessory for normal use and operation within specification for a period of one year from the date of shipment. Spare parts, replacement parts and repairs are warranted for 90 days.

In exercising its warranty, Teledyne LeCroy, at its option, will either repair or replace any assembly returned within its warranty period to the Customer Service Department or an authorized service center. However, this will be done only if the product is determined by Teledyne LeCroy's examination to be defective due to workmanship or materials, and the defect is not caused by misuse, neglect, accident, abnormal conditions of operation, or damage resulting from attempted repair or modifications by a non-authorized service facility.

The customer will be responsible for the transportation and insurance charges for the return of products to the service facility. Teledyne LeCroy will return all products under warranty with transportation charges prepaid.

This warranty replaces all other warranties, expressed or implied, including but not limited to any implied warranty of merchantability, fitness or adequacy for any particular purposes or use. Teledyne LeCroy shall not be liable for any special, incidental, or consequential damages, whether in contract or otherwise.



700 Chestnut Ridge Road  
Chestnut Ridge, NY 10977  
USA

[teledynelecroy.com](http://teledynelecroy.com)