

Keysight Technologies Low Current Semiconductor Measurements Using the B2980A Series Ammeter

Keysight B2981A/B2983A Femto/Picoammeter

Keysight B2985A/B2987A Electrometer/High Resistance Meter

Technical Overview



Introduction

Low current measurement is a key performance metric for picoammeters and electrometers, which often specify atto-ampere (aA) level current measurement resolution. In addition to ultra-low current measurement capability, it is also very important to have other measurement functions such as filtering to smooth-out noisy data and basic measurement data evaluation tools to simplify debugging.

The four key capabilities necessary to successfully make sensitive low current measurements are listed below:

1. Femto-ampere current measurement capability.
2. A floating design configuration for maximum flexibility.
3. The ability to improve data quality through averaging, filtering and zero cancelation.
4. Integrated capability to analyze measurement data via histograms, time domain graphs, etc.

The Keysight B2981A/B2983A Femto/Picoammeter and B2985A/B2987A Electrometer/High Resistance Meter provide both superior performance of 10 aA minimum resolution and improved measurement confidence by supporting all of the features listed above.

This technical overview highlights the B2980A Series ammeter current measurement performance using a diode measurement example.

Note: The B2983A and B2987A have an internal rechargeable battery that allows them to operate without being connected to AC power.

Important words used in the document:

- Low-current metric system prefixes:
 - pico (p) = 10^{-12}
 - femto (f) = 10^{-15}
 - atto (a) = 10^{-18}

Measurement Basics and the B2980A Series Performance

1. Low noise, low impedance and low current ammeter provides stable measurement data

The B2980A Series ammeter has the following features:

- The B2980A's low noise design achieves better than 100 aA current measurement (with 10 aA minimum resolution).
- The low input resistance and low offset voltage allow a faster measurement response and more accurate measurement results.

These features provide the B2980A Series ammeter with the ability to perform stable measurements across a wide range of applications (especially very low current measurements).

2. Floating ammeter design provides stable measurements for both floating and grounded DUTs

The B2980A Series ammeter employs a floating design to provide stable measurements and a flexible configuration for low current measurement applications.

Floating DUT configuration

Figure 1 shows a circuit block diagram using the floating ammeter with a DC voltage source supplying current to the device under test (DUT). The ammeter common is connected to the inner shield of the ammeter's triaxial input, while the outer shield/conductor is connected to the instrument chassis. The chassis is connected to earth ground through the power cable ground connection.

In the Figure 1 example the DUT is floating, with the DC source connected at one end and the ammeter connected at the other end. Since the ammeter is not connected to earth ground, any common noise generated in the DC source ground loop does not flow into the ammeter. Therefore, the ammeter's floating design minimizes the impact of ground noise interference on the measurements.

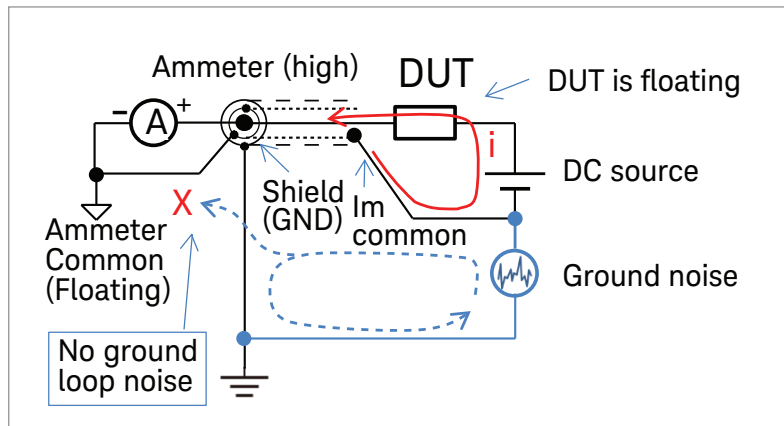

Figure 1. B2980A Series floating ammeter

2. Floating ammeter design provides stable measurements for both floating and grounded DUTs (continued)

Grounded DUT configuration

Figure 2 shows the case where one of the ends of the DUT is grounded. In this case the connection scheme shown in Figure 1 cannot be used. The reason for this is that the ammeter side of the DUT must always be floating and there is no way to apply a voltage to the DUT except through the ammeter. Figure 2 shows the proper ammeter configuration for a grounded DUT measurement. In this configuration the ammeter common is floating and the voltage source (V_s) is connected to the ammeter common. The source voltage (V_s) is applied through the ammeter's input terminal.

Note: In both the floating and the grounded cases, the outside conductor of the ammeter's triaxial input terminal is connected to the instrument's chassis ground to maintain safe operating conditions.

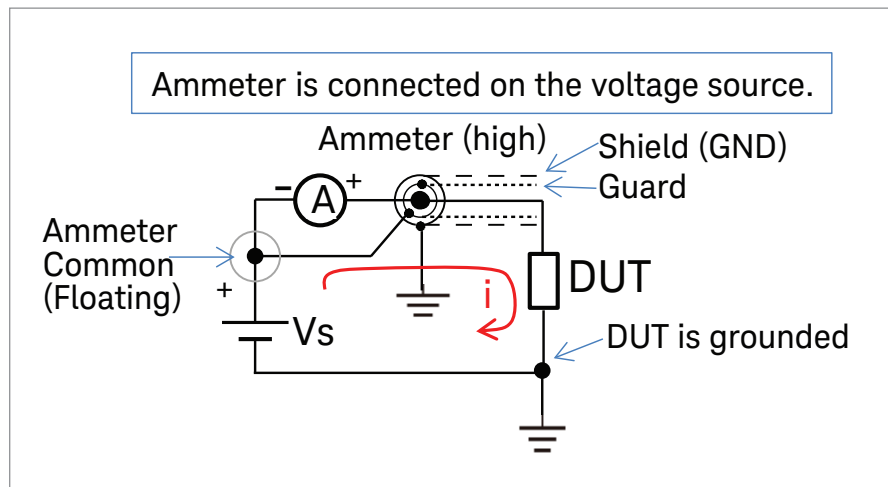

Figure 2. Configuration to measure a grounded DUT.

Note: The B2985A and B2987A have a built-in voltage source that provides the following benefits:

- The ability to synchronize the voltage source output with the measurement timing.
- The ability to display the voltage and current relationship in an X-Y graph on the instrument front panel.

3. Measurement speed, filtering/averaging and zero cancellation functions improve measurement data quality

Measurement Speed selection:

The B2980A series supports four measurement speeds: Quick, Normal, Stable, and Manual. The Quick, Normal and Stable measurement speeds are available when using auto mode, and they correspond to integrating over some fraction or multiple of the power line cycle (PLC). For these cases the measurement speed is automatically set for a given measurement range to provide the best data for the selected speed. If you want to control this parameter, then the Manual speed setting is user definable from 0.001 PLC to 100 PLC.

Filtering capability:

In addition to the measurement speed selection, you can also perform filtering on the measurement data. The filtering function can provide median averaging and a moving average to reduce noise effects.

3. Measurement speed, filtering/averaging and zero cancelation functions improve measurement data quality (continued)

Null (Zero cancel) capability:

To remove the effects of any residual offset currents, you can have the instrument automatically subtract out these currents by pressing the Null key.

Figure 3 shows a measurement example using the B2980A Series ammeter. In this example the B2985A is in its 2 pA measurement range, the measurement speed is set to “Quick”, the filtering is set to a 100 point moving average and stray leakage currents have been removed using the NULL function. Using the B2985A's Roll View the data is displayed over a 100 second time span. With these settings it is easy to see that a stable 100 nA level measurement can be made.

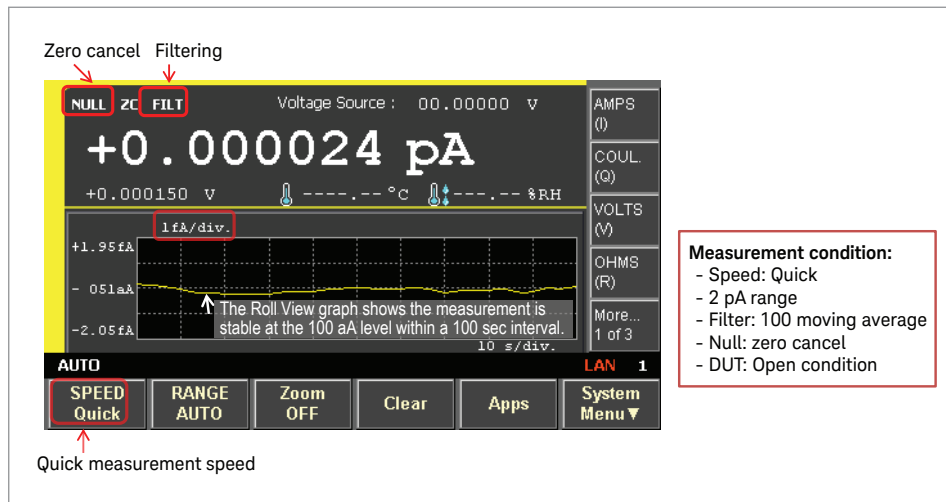

Figure 3. Low current measurement example (B2985A).

4. Histogram View enables real-time data distribution analysis

In order to reduce or eliminate measurement noise it is helpful to be able to analyze measurement data statistically in real-time. Once you know the characteristics of the noise you are seeing you can decide if it is better to reduce the noise at its source or to filter out the noise from the data. Of course, if the noise is symmetrically distributed then you can simply use the average of the histogram.

Figure 4 shows an example of this procedure using the B2980A's Histogram View. The two histograms show the profound effect that measurement speed and data filtering can have when making measurements in a noisy test environment.

Note: This measurement was made using a banana clip lead to triaxial cable with the input terminal open and without shielding; therefore, there is a considerable amount of noise entering the ammeter.

Figure 4(a) shows Histogram View results using 0.1 power line cycle (PLC) measurement speed and no filtering. The histogram distribution exhibits peaks at both ends and the measured sigma is 0.17 pA. Figure 4(b) shows the same measurement performed using Normal speed (which does PLC averaging) and a 100 point moving average filter on the measurement data. In this case the measured sigma is 0.018 pA, which is about 9.5 times (= 0.17/0.018) smaller than the sigma shown in Figure 4(a).

4. Histogram View enables real-time data distribution analysis (continued)

This example shows how you can use line frequency averaging and data filtering in conjunction with the Histogram View to improve data quality

Note: The sample histogram shown in Figure 4(a), which has a bimodal distribution with peaks at both ends, is typical of the situation where sinusoidal power line voltage is the main noise source. Figure 4(b) illustrates that the line frequency noise components can be filtered out using power line cycle integration and data averaging.

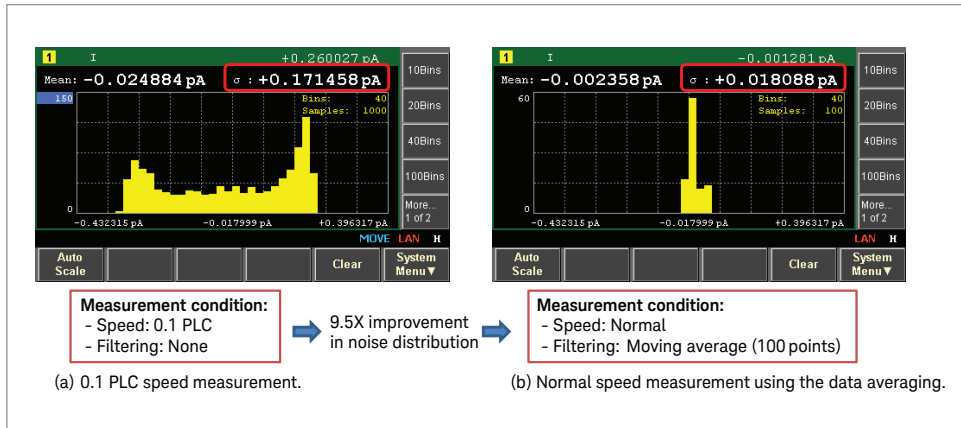

Figure 4. Using histogram view and other functions to improve measurement data.

Low Current Measurement Example

Measurement steps on B2985A/87A front panel operation

This section gives step-by-step instructions on how to use the B2980A's Femto/Picoammeter to perform low current (I/V) characterization using an LED as the test device. The B2985A Electrometer/High Resistance Meter is used in the example because it has a built-in voltage source so that no additional external instruments are required to apply voltage to the LED.

Note: To make the same measurements using the B2981A/B2983A Femto/Picoammeter requires some modifications to the software key sequences and steps shown in this example (although the ammeter setup is identical). Of course, when using the B2981A/B2983A you need to supply an external voltage source to measure the I/V characteristics.

You can download the test setup of the following examples from the next link; www.keysight.com/find/SensitiveMeasurements

Example 1. Monitoring LED Forward diode current

Figure 5 shows the proper connections to measure the I/V characteristics of an LED. Note that it is important to connect the ammeter common to the chassis ground using the banana to lug cable as shown in the figure.

Note: If the ammeter common and the test fixture shield are connected, then this ground connection is not necessary.

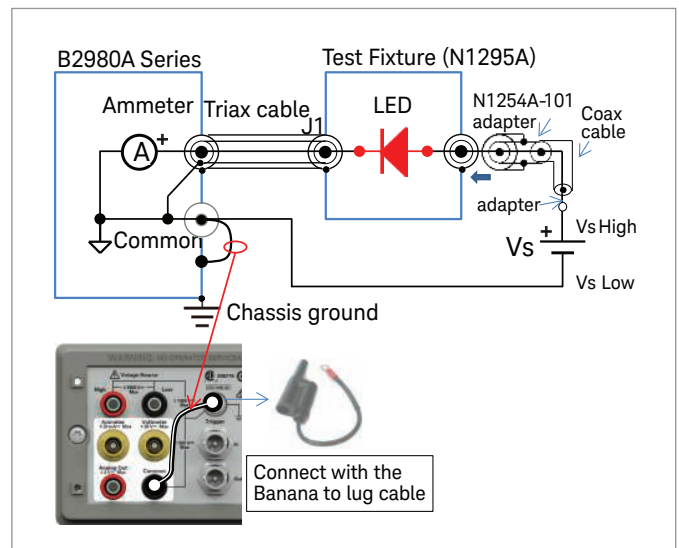

Figure 5. LED I/V measurement setup example.

Example 1. Monitoring LED Forward diode current (continued)

The following steps outline how to setup and measure the low current I/V characteristics of an LED.

Detailed B2985A front panel setup instructions

Step 1. Press the lower-right [View] key to show the View menus in the function keys below the screen. Next, press the [Meter View] function key, and then press the [AMPS(I)] assist key at the right of the screen.

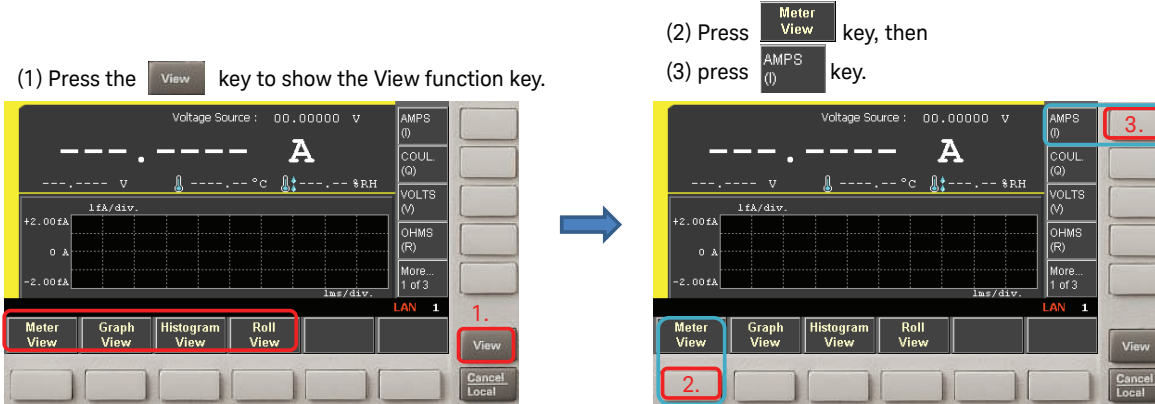

Note: In case of the B2981A/83A the instrument boots-up into this state and these operations are not necessary.

Step 2. Check if the Voltage Source field is set to 0 V. If not then follow the steps shown below to set the output voltage to zero volts.

- (1) If the Voltage Source value is not 0 V, then perform the following steps.
- (2) Rotate and to move the field pointer onto the Voltage Source value, and press the knob to edit the voltage.
- (3) The field pointer changes to green (EDIT mode), and the status information will change to EDIT .
- (4) Set the voltage to zero volts by rotating the and press to fix the value.

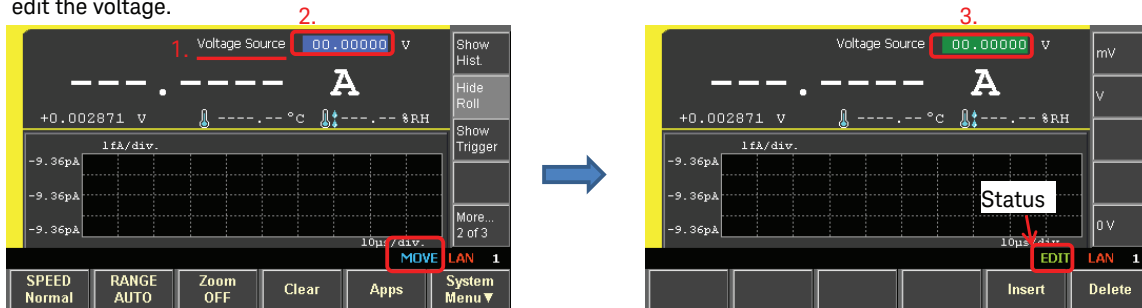

Step 3. (1) Press the Voltage Source [On/Off] key to enable the voltage source to output 0 V.

Note: If using the B2981A/83A then set the external voltage source to zero volts.

- (2) Press the Ammeter [On/Off] key to connect the ammeter.
- (3) A single current measurement is made automatically.

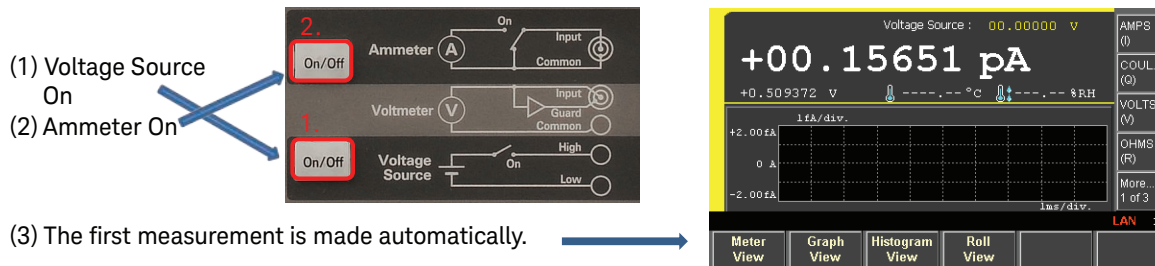

Example 1. Monitoring LED Forward diode current (continued)

Step 4. Press the [Run/Stop] key to start continuous current measurements. The “AUTO” indicator at the bottom of the screen shows that the measurement is continuously repeating.

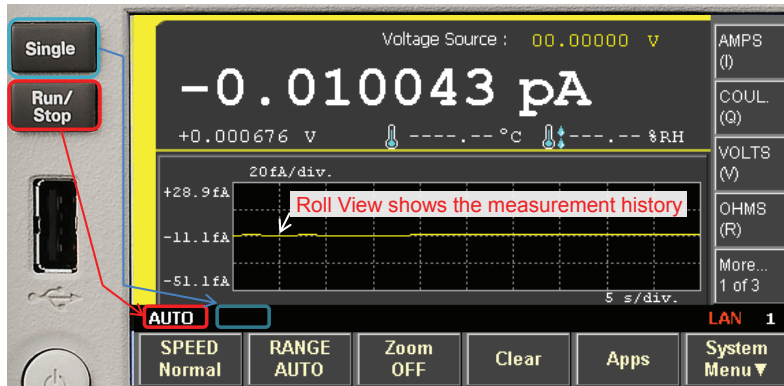

Note: If you press the [Single] key, then only one measurement will be made. The “ARM” indicator is shown while measurements are in progress.

Step 5. Change the voltage source to edit mode using the procedure outlined in step 2. (B2985A/87A only). Then change the voltage to approximately 1.0 V.

Rotate  slowly to increase the voltage. The value increases as you rotate the [knob] clockwise. Stop when the voltage reaches approximately 1.0 V.

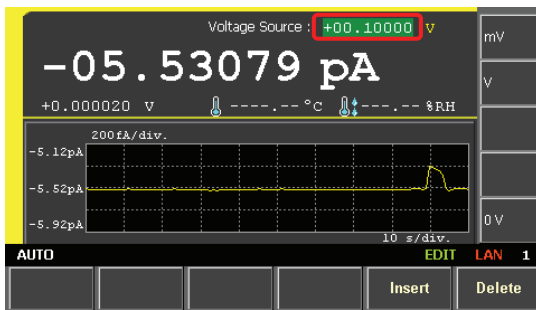

Step 6. (1) Continue rotating the [Knob] and increasing the voltage until the current is between 10 to 20 mA.

Note: If using the B2981A/83A then increase the external voltage source voltage.

(2) The LED starts to emit light at around 1.5 V.

(3) The LED current will continue to increase until the LED temperature stabilizes.

(1) Further rotate , and increase the voltage until the current is between 10 to 20 mA.

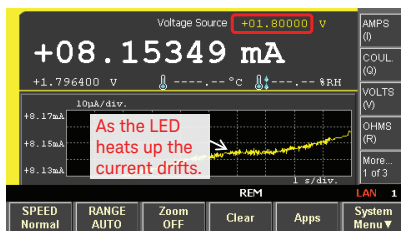

(3) Roll View shows the current drift status after the LED's temperature stabilizes.

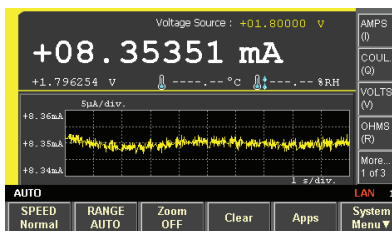

(2) LED light up as shown in the picture.

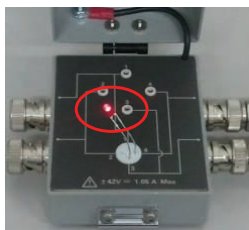

Example 1. Monitoring LED Forward diode current (continued)

- Step 7. As a final step we will check the residual current of the test fixture.
- (1) Close the lid of the test fixture.
 - (2) Disconnect the Vs cable from the fixture.
 - (3) Check the current transient in the Roll view display and note the final residual current.

Note that the residual current quickly reaches the pA level and eventually stabilizes at the fA level (3 fA in about 100 seconds in this example).

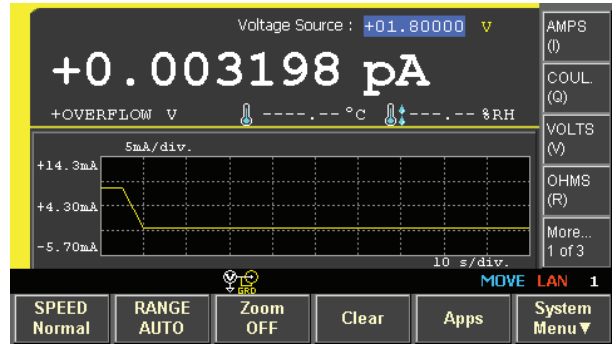

Example 2. LED forward diode I/V characteristics

This example outlines how to plot LED current versus voltage (I/V) characteristics and it only applies to the B2985A/87A.

Note: If using the B2981A/83A then you need to plot the current measured by the B2981A/83A and the voltage applied by the external voltage source on a PC to make this same type of I/V plot.

The following steps outline how to plot the I/V characteristics of an LED.

- Step 1. (1) Press the [Meter View] function key at the bottom of the screen.
 (2) Then press the [More ... 1 of 3] assist key twice so that the third set [More ... 3 of 3] of softkey labels is displayed on the assist keys at the right of the screen.
 (3) Press the [Show VS Func.] assist key to show the VS function menu.

- (1) Press **Meter View** key, then
 (2) press **More... 1 of 3** key two times until **More... 3 of 3** key appears.

- (3) press **Show VS Func.** key.

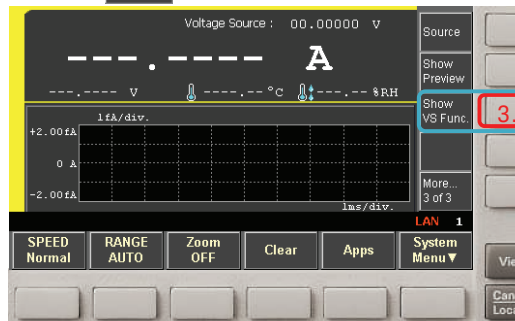
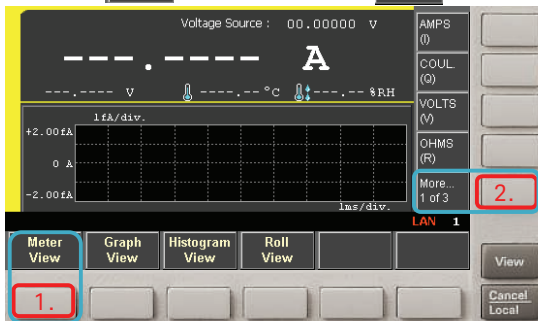

- Step 2. (1) Move the cursor by rotating the [Knob] until the cursor is on the VS Function and then select it by pushing the knob.
 The VS Function is now in edit mode and the assist softkey menu at the right of the screen represents the available VS Functions.
 (2) Press on the [LINEAR SINGLE] assist key.

Move the cursor on the VS Function by rotating  .

- (1) Click on the VS Function by , and the VS menu options are displayed.
 (2) Press **LINEAR SINGLE** assist key.

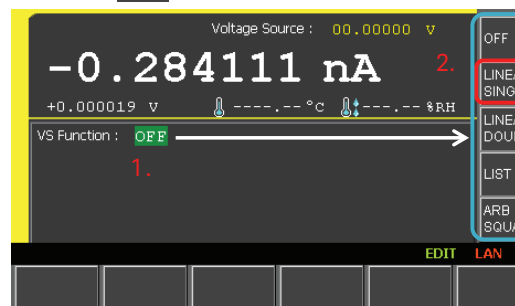
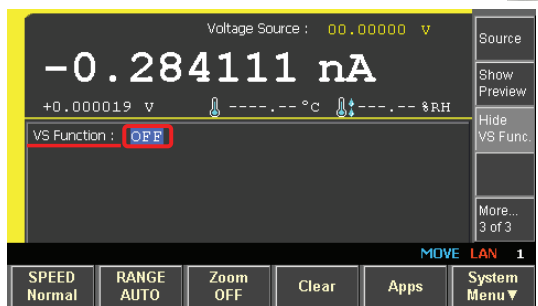

Example 2. LED forward diode I/V characteristics (continued)

Step 3. (1) The Source function graphic changes to linear single sweep (upper right corner of screen).

- (2) Edit the sweep parameters as shown in the figure to the following values:
- Start: 0 V
 - Stop: 1.8 V (or the anode voltage that flows about 10 ~ 20 mA anode current.)
 - Points: 37 (or any number required to achieve the desired Step voltage.)

Optional steps: To check the Trigger mode If the sweep measurement does not work in step 5, perform the following steps (3) thru (7).

- (3) Press the [More... 3 of 3] assist key two times until it changes to the [More... 2 of 3] softkey label.
 (4) Press the [Show Trigger] assist key. The trigger sub-panel is now displayed. If the Trigger mode is set to MANUAL as shown in step (5), then perform the following steps:
 (5) Using the [Knob], place the cursor over the Trigger function and press the knob to select it. This changes the assist softkey labels.
 (6) Press the [AUTO] assist key to change the Trigger function to AUTO mode.
 (7) In this mode, the trigger parameter changes automatically as you change the sweep parameters.

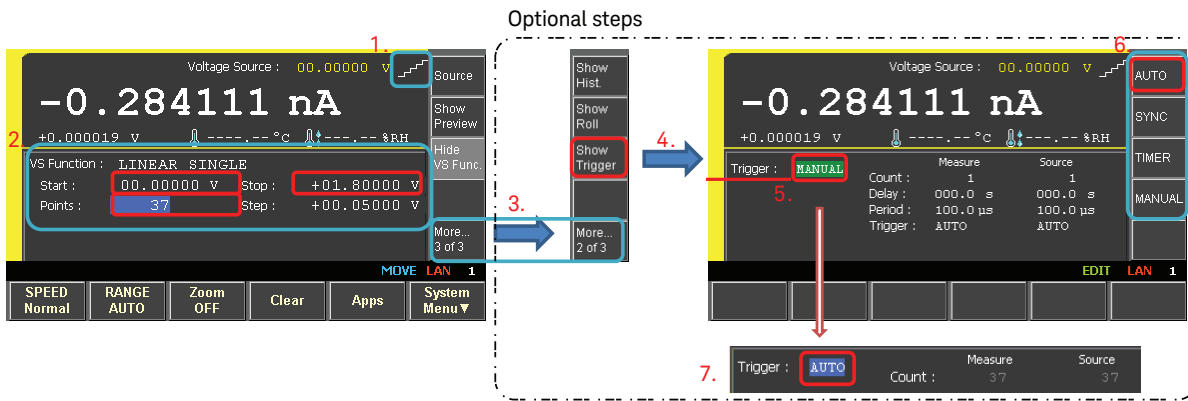



Step 4. (1) Press the [View] key, and then press the [Graph View] function key. The X-Y graph view panel opens.

- (2) Check or change the X-Y axis parameters and the x-axis maximum scale as follows:
- 2-1. Y: I (A)
 - 2-2. X: SRC (Source V)
 - 2-3. X-axis max scale: 1.8 V (or the maximum sweep voltage)

(2) Edit Y and X axis parameter to plot the data.

Use  to select items, and select from the list of the assist key.

(1) Press  key, then press  soft key.

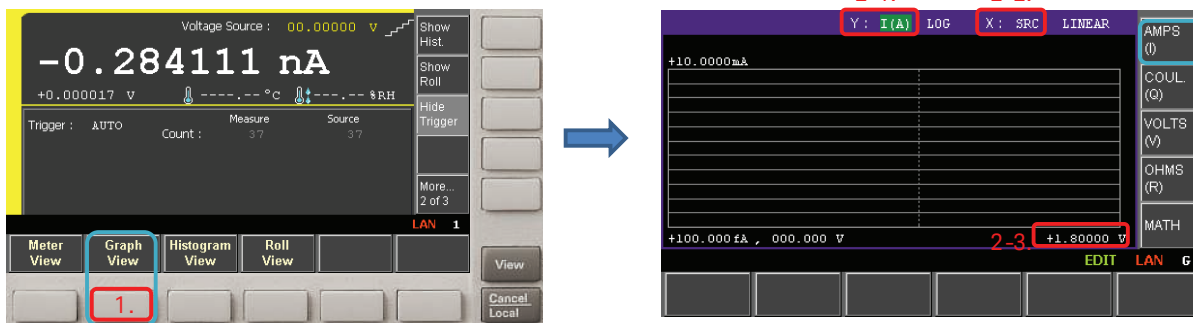

Example 2. LED forward diode I/V characteristics (continued)

Step 5. Press the [Single] key. The Trigger indicator changes to [ARM], and the sweep measurement begins.

By pressing the [Auto Scale] function key, intermediate measurement data can be seen on the 10 X-Y graph.

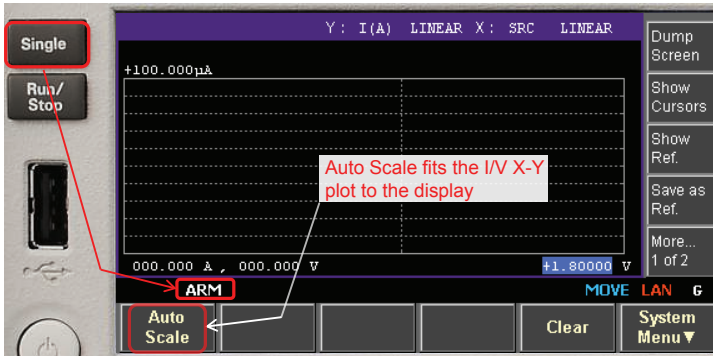

Step 6. An I/V curve of the LED's forward characteristics is displayed with the Y-axis using a linear scale.

Select and click on the Y-axis scale [LINEAR] and change it to [LOG] by pressing the [LOG] assist key.

Click on the [LINEAR] scale using .

Press  key to change the Y axis to the LOG scale.

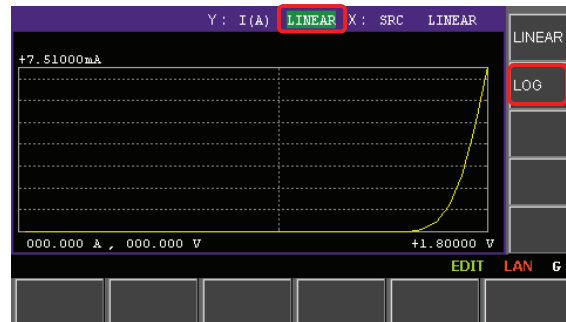
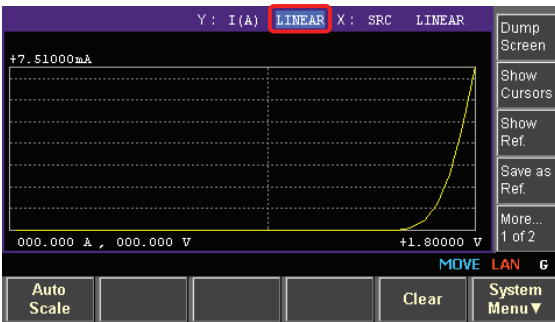

Step 7. The Y-axis is changed to a log scale.

You can easily export the measurement data in CSV format to a PC using the B2985A/87A's USB port.

LED's forward I/V characteristics (Log scale)

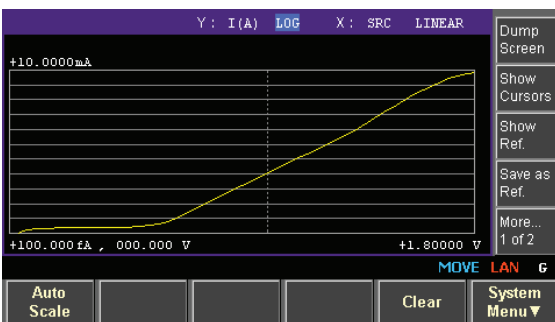

Spread sheet graph plotted on a PC.

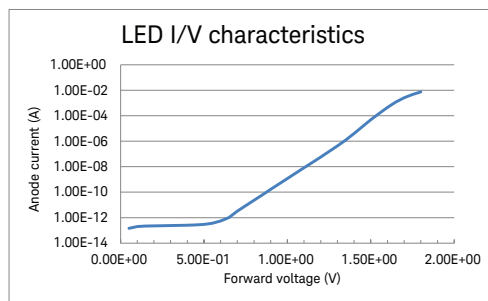

Conclusion

The Keysight B2980A Series Picoammeter/Electrometer ammeter is an easy-to use, high performance and stable picoammeter that can measure down to 100 aA with 10 aA effective resolution. The B2980A Series employs a floating ammeter design, which provides considerable freedom to use the ammeter in various ways depending on the measurement requirements. The user friendly graphical interface supports four viewing modes: Meter View, Graph View, Histogram View and Roll View. When used with the Null and Filter functions these features enable you to optimize the quality of your measurement data.

Using the B2985A/B2987A's built-in voltage source, it is easy to plot the I/V characteristics of two terminal semiconductor devices.

myKeysight

myKeysight

www.keysight.com/find/mykeysight

A personalized view into the information most relevant to you.



www.axiestandard.org

AdvancedTCA® Extensions for Instrumentation and Test (AXIe) is an open standard that extends the AdvancedTCA for general purpose and semiconductor test. Keysight is a founding member of the AXIe consortium. ATCA®, AdvancedTCA®, and the ATCA logo are registered US trademarks of the PCI Industrial Computer Manufacturers Group.



www.lxistandard.org

LAN eXtensions for Instruments puts the power of Ethernet and the Web inside your test systems. Keysight is a founding member of the LXI consortium.



www.pxisa.org

PCI eXtensions for Instrumentation (PXI) modular instrumentation delivers a rugged, PC-based high-performance measurement and automation system.



Three-Year Warranty

www.keysight.com/find/ThreeYearWarranty

Keysight's commitment to superior product quality and lower total cost of ownership. The only test and measurement company with three-year warranty standard on all instruments, worldwide.



Keysight Assurance Plans

www.keysight.com/find/AssurancePlans

Up to five years of protection and no budgetary surprises to ensure your instruments are operating to specification so you can rely on accurate measurements.



www.keysight.com/go/quality

Keysight Technologies, Inc.
DEKRA Certified ISO 9001:2008
Quality Management System

Keysight Channel Partners

www.keysight.com/find/channelpartners

Get the best of both worlds: Keysight's measurement expertise and product breadth, combined with channel partner convenience.

www.keysight.com/find/precisionMEASURE

For more information on Keysight Technologies' products, applications or services, please contact your local Keysight office. The complete list is available at: www.keysight.com/find/contactus

Americas

Canada	(877) 894 4414
Brazil	55 11 3351 7010
Mexico	001 800 254 2440
United States	(800) 829 4444

Asia Pacific

Australia	1 800 629 485
China	800 810 0189
Hong Kong	800 938 693
India	1 800 112 929
Japan	0120 (421) 345
Korea	080 769 0800
Malaysia	1 800 888 848
Singapore	1 800 375 8100
Taiwan	0800 047 866
Other AP Countries	(65) 6375 8100

Europe & Middle East

Austria	0800 001122
Belgium	0800 58580
Finland	0800 523252
France	0805 980333
Germany	0800 6270999
Ireland	1800 832700
Israel	1 809 343051
Italy	800 599100
Luxembourg	+32 800 58580
Netherlands	0800 0233200
Russia	8800 5009286
Spain	0800 000154
Sweden	0200 882255
Switzerland	0800 805353
	Opt. 1 (DE)
	Opt. 2 (FR)
	Opt. 3 (IT)
United Kingdom	0800 0260637

For other unlisted countries:
www.keysight.com/find/contactus
(BP-07-10-14)



Keysight B2900 Precision Instrument Family

The B2900Family lines up products for both precision source and precision measurement.

www.keysight.com/find/b2900a

