

# Parametric Instrument Accessories

## Accessories Guide

---



## Table of Contents

1. Introduction.....	3
2. Connecting to Fixture.....	4
2.1. Jumper cables.....	5
2.2. Socket modules.....	6
3. Connecting to SWM.....	7
3.1. GNDU .....	7
3.2. SMU.....	9
3.3. MFCMU .....	10
4. Connecting to Prober.....	11
4.1. GNDU connections.....	11
4.2. SMU/CMU connections .....	13
5. Accessories .....	18
5.1. CMU accessories .....	18
5.2. B1500A peripherals.....	20
5.3. Connector type.....	21
5.4. Cables .....	23
5.5. Connector plates .....	25
5.6. Adapters and connectors.....	30

## 1. Introduction

This guide provides information on how to connect a prober to Keysight Technologies, Inc. semiconductor parametric measurement instruments.

This guide also provides information on accessories for a variety of Keysight Technologies semiconductor parametric measurement instruments, such as:

- Keysight B1500A—Semiconductor Device Analyzer
- Keysight 4155C/4156C—Semiconductor Parameter Analyzer
- Keysight E5270B—8 slot Precision Measurement Mainframe
- Keysight E5260A—8 slot High Speed Measurement Mainframe
- Keysight B2200A—fA Leakage Switch Mainframe
- Keysight B2201A—14ch Low Leakage Switch Mainframe
- Keysight E5250A—Low Leakage Switch Mainframe



Figure 1.1. B1500A with Cascade prober



Figure 1.2. B1500A with Vector prober



Figure 1.3, B1500A with Suss prober

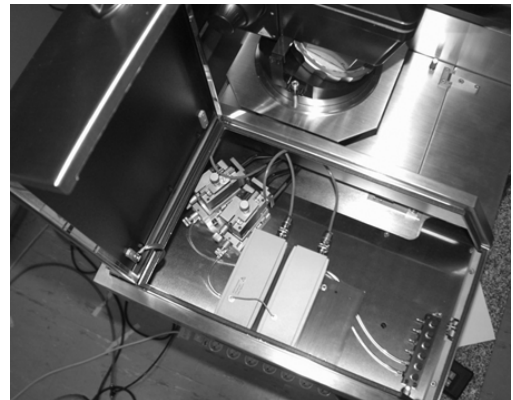

Figure 1.4. ASUs on the probe station

## 2. Connecting to Fixture

The 16442A and 16442B test fixtures have 6 triaxial input ports. You can connect force ports of SMU to them by using Triaxial Cable 16494A as shown in Figure 2.1.

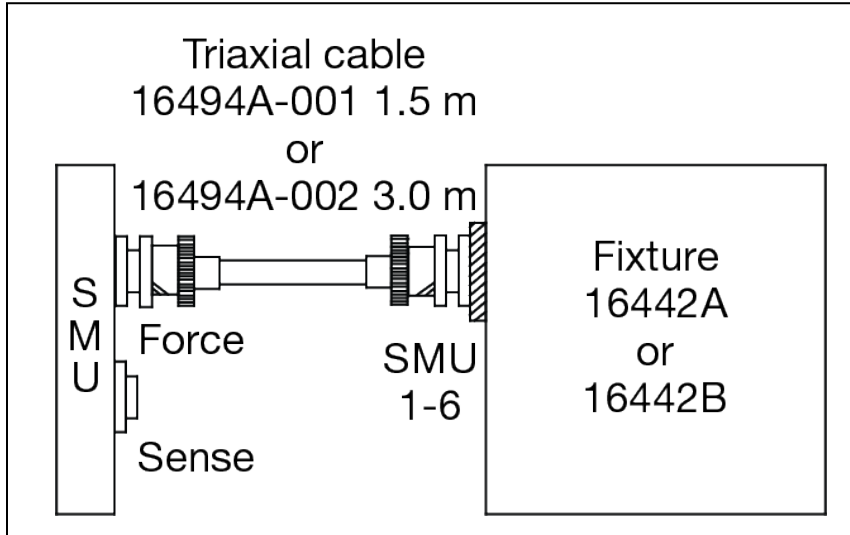

Figure 2.1. Connecting SMUs to fixture



## 2.1. Jumper cables

Table 2.1. Jumper cables

### Mini banana – Pin plug

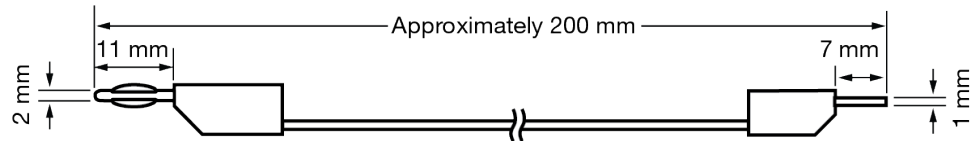

#### As option of 16442A/16442B

16442A-811/16442B-811 for Black (2ea), Blue (2ea), Red (2ea)

#### Parts number

16442-61600 for Black (1ea)

16442-61601 for Red (1ea)

16442-61602 for Blue (1ea)

### Pin plug – Pin plug

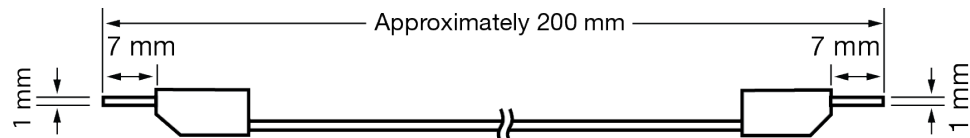

#### As option of 16442A/16442B

16442A-812/16442B-812 for Black (2ea), Blue (2ea), Red (2ea)

#### Parts number

16442-61603 for Black (1ea)

16442-61604 for Red (1ea)

16442-61605 for Blue (1ea)

### Mini banana – Mini clip

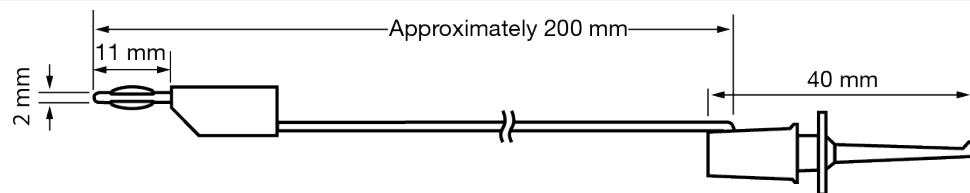

#### As option of 16442A/16442B

16442A-813/16442B-813 for Black (2ea), Blue (2ea), Red (2ea)

#### Parts number

16442-61606 for Black (1ea)

16442-61607 for Red (1ea)

16442-61608 for Blue (1ea)

## Mini banana – Mini banana

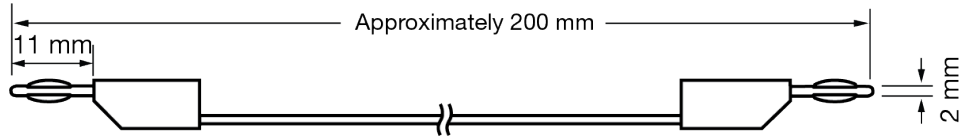

### As option of 16442A/16442B

16442A-814/16442B-814 for Black (2ea), Blue (2ea), Red (2ea)

### Parts number

16442-61609 for Black (1ea)

16442-61610 for Red (1ea)

16442-61611 for Blue (1ea)

## 2.2. Socket modules

Table 2.2.

Socket Modules			
N1254A-204	0.1 inch		<p>This socket module is for measurement of virtually any device—component, DIPIC, or small-scale circuit.</p>
16442A-801/16442B-801	0.1 inch		
N1254A-205	0.075 inch		
16442A-802/16442B-802	0.075 inch		
N1254A-206	0.05 inch		
16442A-803/16442B-803	0.05 inch		
N1254A-200			<p>This socket module has two transistor sockets for measurement of three lead or four lead bipolar transistors and FETs.</p> <p>Maximum voltage: 200 V</p>
16442A-821/16442B-821			
N1254A-201			<p>This socket module has a 28-pin dual-in-line socket.</p> <p>Maximum voltage: 230 V</p>
16442A-823/16442B-823			

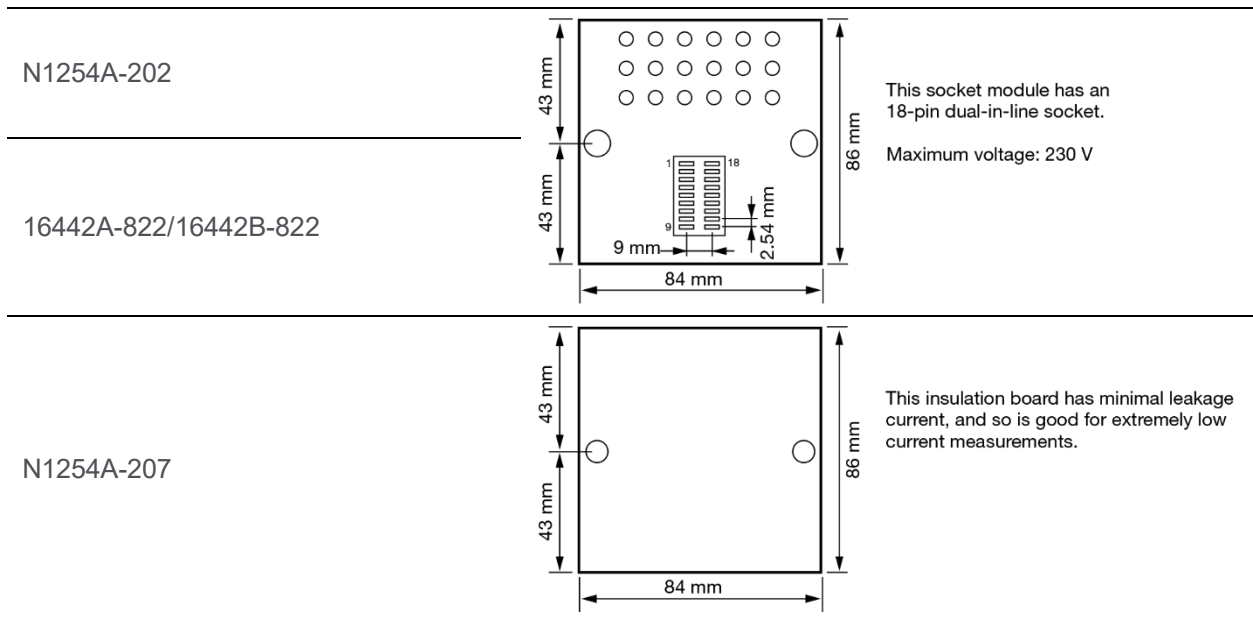

### 3. Connecting to SWM

#### 3.1. GNDU

An SMU has FORCE (SENSE), GUARD, and COMMON, but a GNDU has SENSE, FORCE, and COMMON as shown in Figure 3.1. You need some sort of GNDU to Kelvin adapter when connecting the GNDU to standard triaxial connections.

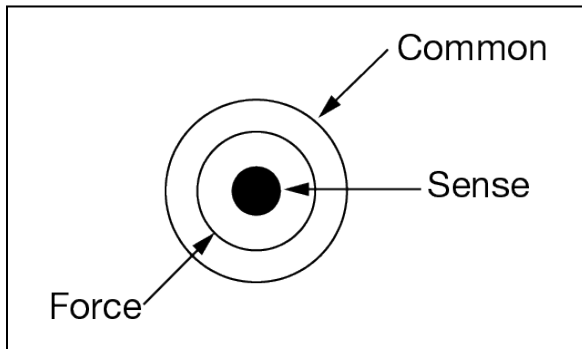

Figure 3.1. GNDU terminal

#### CAUTION

You should use the Keysight 16493L GNDU cable to connect the GNDU to the SWM; do not use a standard triaxial cable. The GNDU cable can handle the maximum GNDU current of 4.2 A, but standard triaxial cables are only rated to 1 A.

### (Non-Kelvin connection)

Connect the triaxial connector using an adapter for GNDU (N1254A-107) as shown in Figure 3.2. For this part, see Table 5.10 in Section 5.6 Adapters. For parts information, see Table 3.1.

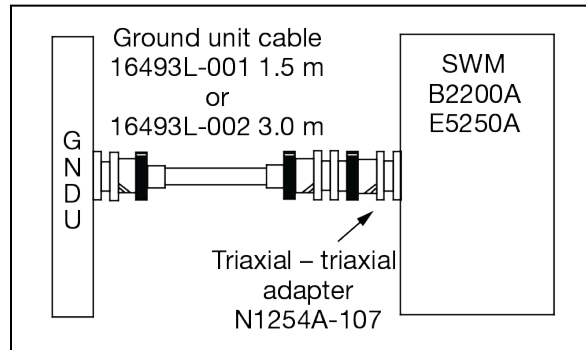

Figure 3.2. Examples of a GNDU non-Kelvin connection to SWM

Table 3.1. Parts information

Description	Qty	Part number	Product
Ground unit cable – 1.5 m (Max 4.2 A)	1	—	16493L-001
Ground unit cable – 3.0 m (Max 4.2 A)	1	—	16493L-002
Adapter for GNDU (triaxial (m) – triaxial (f))	1	1250-2654	N1254A-107

### Kelvin connection

Connect the dual triaxial connector using a GNDU to Kelvin Adapter (N1254A-100) as shown in Figure 3.3. For this part, see Table 5.10 in Section 5.6 Adapters. For parts information, see Table 3.2. Maximum current is restricted when the Kelvin triaxial cable is used. See Table 3.2.

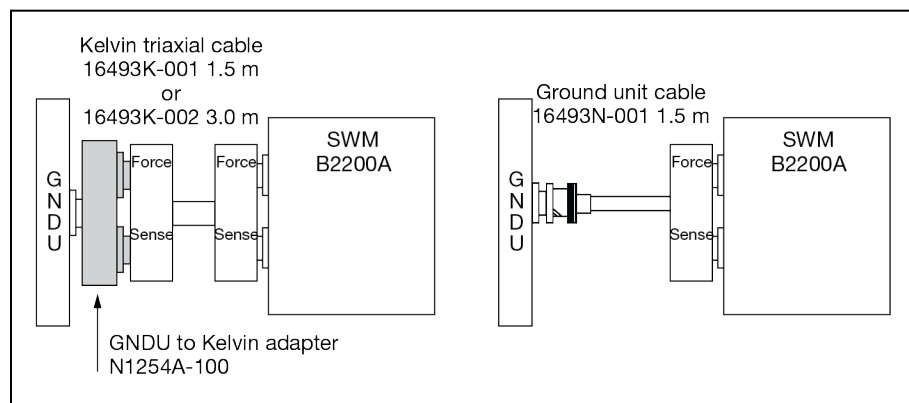

Figure 3.3. Examples of a GNDU Kelvin connection to SWM



Table 3.2. Parts information

Description	Qty	Part number	Product
Kelvin triaxial cable – 1.5 m (Max 3.0 A)	1	—	16493K-001
Kelvin triaxial cable – 3.0 m (Max 2.6 A)	1	—	16493K-001
Ground unit cable – 1.5 m	1	—	16493N-001
GNDU to Kelvin adapter	1	—	N1254A-100

### 3.2. SMU

An SMU terminal is shown in Figure 3.4.

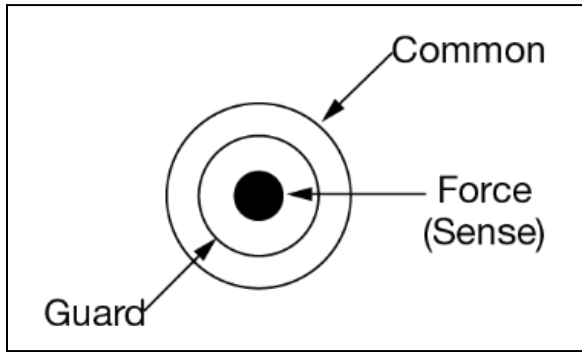

Figure 3.4. SMU terminal

### Kelvin connection

When Kelvin connection is used, connect a Keysight 16493K Kelvin triaxial cable for B2200A/B2201A as shown in Figure 3.5. For E5250A, connect a Keysight 16494B Kelvin Triaxial Cable as shown in Figure 3.5. You can also use two Keysight 16494A triaxial cables in place of one Kelvin Triaxial Cable.

Connect the FORCE and SENSE lines to ports separately.

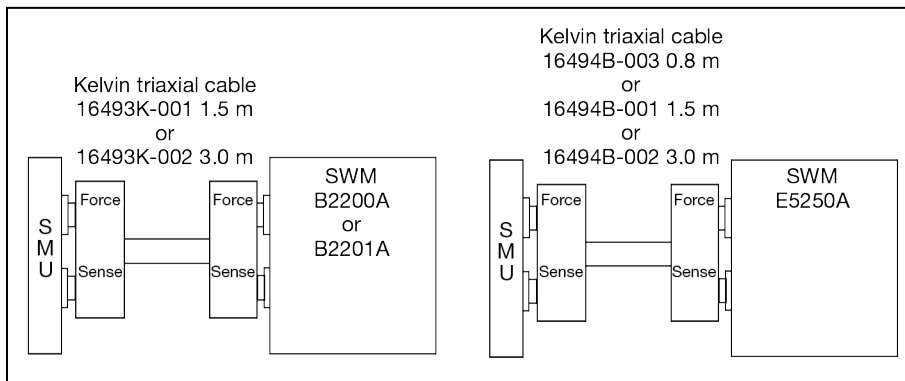

Figure 3.5. Examples of a SMU Kelvin connection to SWM

## Non-Kelvin connection

When non-Kelvin connection is used, connect the Keysight 16494A triaxial cable between the SMU and SWM as shown in Figure 3.6.

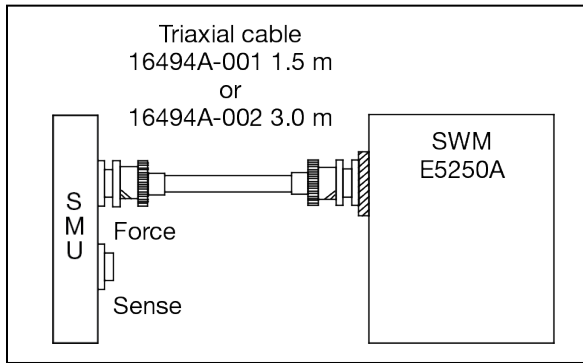

Figure 3.6. Examples of a SMU non-Kelvin connection to SWM

## 3.3. MFCMU

MFCMU of B1500A is connected to CMH and CML port of B2200A/ B2201A by using CMU input cable 16494F-001 as shown in Figure 3.7.

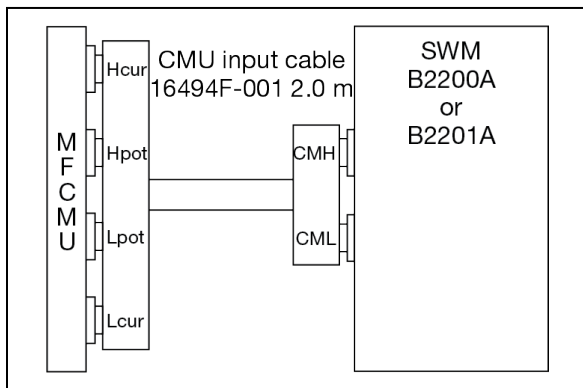

Figure 3.7. Examples of a MFCMU connection to SWM

## 4. Connecting to Prober

### 4.1. GNDU connections

An SMU has FORCE (SENSE), GUARD, and COMMON, but a GNDU has SENSE, FORCE, and COMMON as shown in Figure 4.1. You need some sort of GNDU to Kelvin adapter when connecting the GNDU to standard triaxial connections.

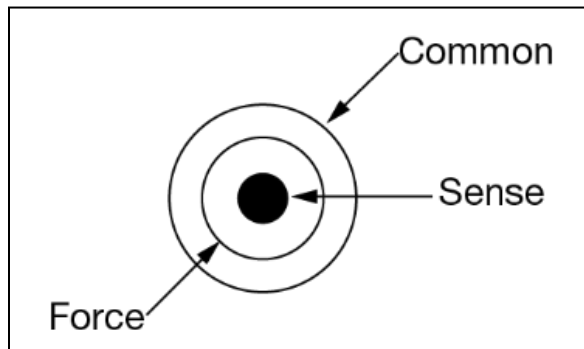

Figure 4.1. GNDU terminal

### CAUTION

You should use the Keysight 16493L GNDU cable to connect the GNDU to the connector plate; do not use a standard triaxial cable. The GNDU cable can handle the maximum GNDU current of 4.2 A, but standard triaxial cables are only rated to 1 A.

### Non-Kelvin connection

Connect the triaxial connector using an adapter for GNDU (N1254A-107) as shown in Figure 4.2. For this part, see Table 5.10 in Section 5.6 Adapters. For parts information, see Table 4.1.

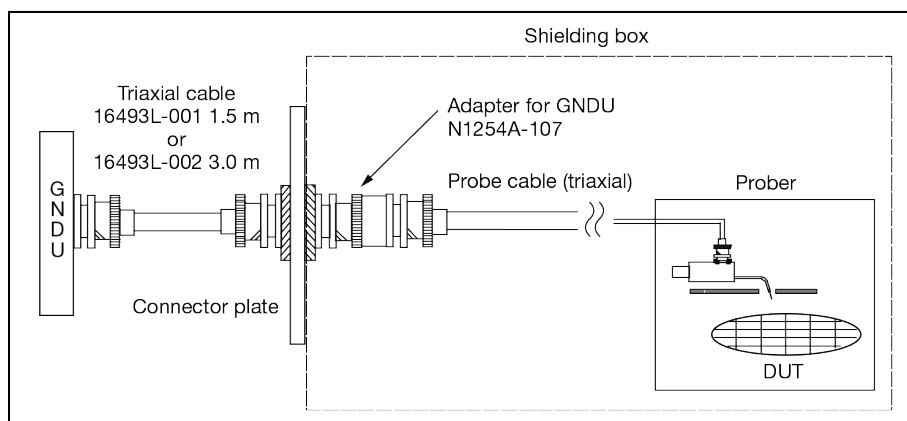

Figure 4.2. Examples of a GNDU non-Kelvin connection

Table 4.1. Parts information

Description	Qty	Part number	Product
Ground unit cable – 1.5 m (Max 4.2A)	1	—	16493L-001
Ground unit cable – 3.0 m (Max 4.2A)	1	—	16493L-002
Adapter for GNDU (triaxial (m) – triaxial (f))	1	1250-2654	N1254A-107

### Kelvin connection

Connect the dual triaxial connector using a GNDU to Kelvin Adapter (N1254A-100) as shown in Figure 4.3. For this part, see Table 5.10 in Section 5.6 Adapters. For parts information, see Table 4.2. Maximum current is restricted when the Kelvin triaxial cable is used. See Table 4.2.

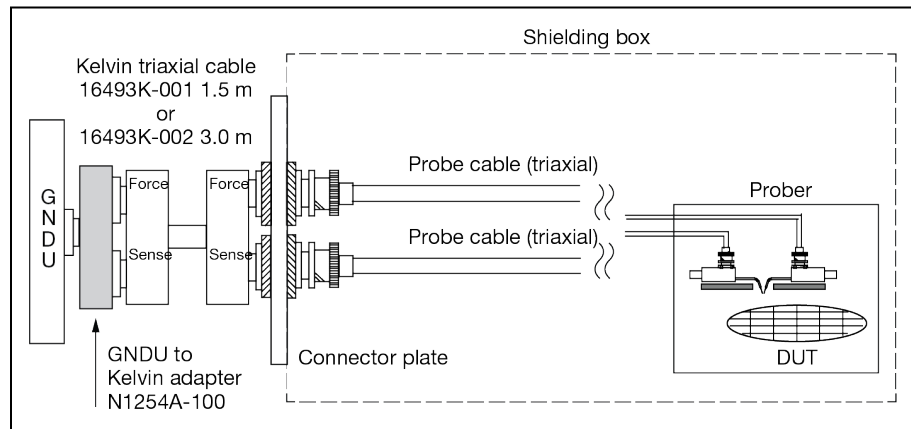

Figure 4.3. Examples of a GNDU Kelvin connection

Table 4.2. Parts information

Description	Qty	Part number	Product
Kelvin triaxial cable – 1.5 m (Max 3.0 A)	1	—	16493K-001
Kelvin triaxial cable – 3.0 m (Max 2.6 A)	1	—	16493K-002
GNDU to Kelvin adapter	1	—	N1254A-100

## 4.2. SMU/CMU connections

An SMU terminal is shown in Figure 4.4.

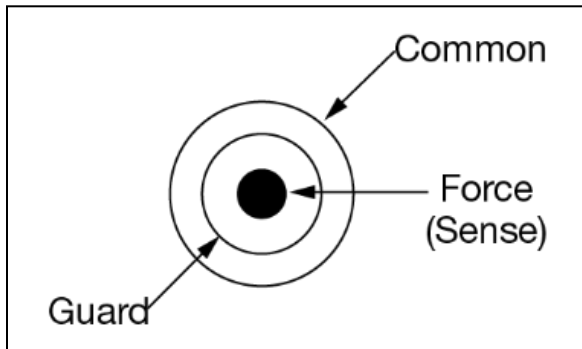

Figure 4.4. SMU terminal

### Kelvin connection

These instructions apply when all connections are Kelvin. Two probes must contact the wafer in this connection.

Connect a Keysight 16493K Kelvin triaxial cable (or two Keysight 16494A triaxial cables) between the SMU and the connector plate. Connect the FORCE and SENSE lines to probes separately. Connect the triaxial connector on the probe cable as shown in Figure 4.5. To prevent oscillations, use short cables. For parts information, see Table 4.3.

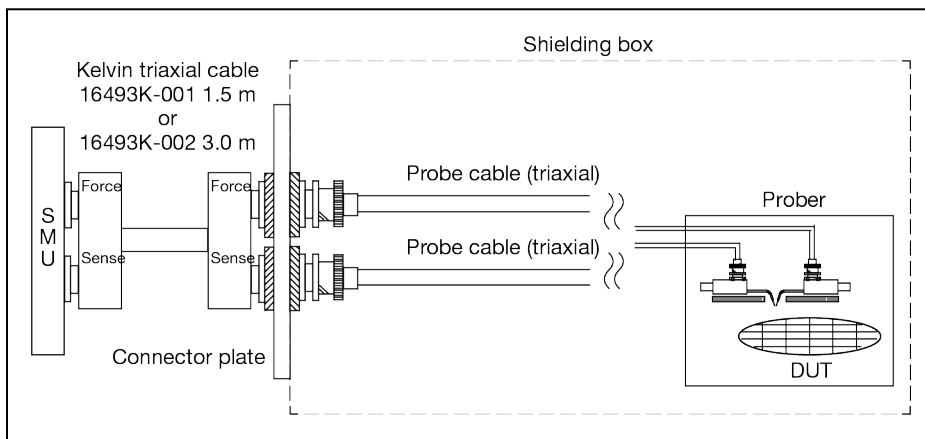

Figure 4.5. Examples of a SMU Kelvin connection

Table 4.3. Parts information

Description	Qty	Part number	Product
Kelvin triaxial cable – 1.5 m (Max 3.0 A)	1	—	16493K-001
Kelvin triaxial cable – 3.0 m (Max 2.6 A)	1	—	16493K-002

### Non-Kelvin connection

These instructions apply when all connections are non-Kelvin. Connect the Keysight 16494A triaxial cables between the SMU and the Connector plate.

Connect the triaxial connector on the probe cable as shown in Figure 4.6. For parts information, see Table 4.4.

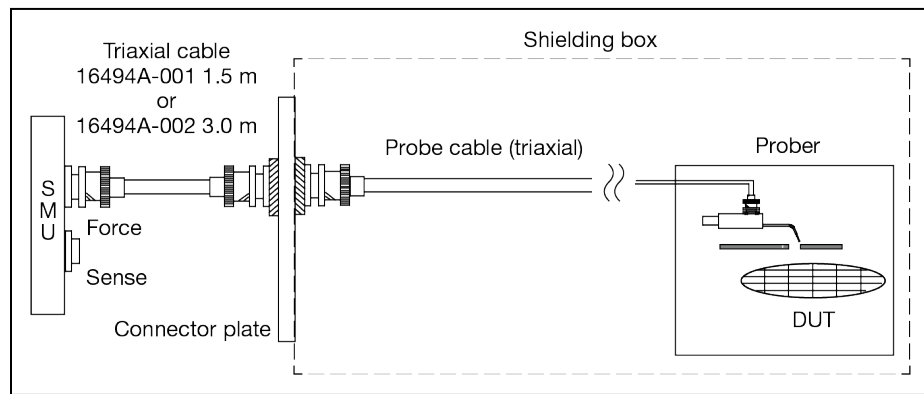

Figure 4.6. Examples of a SMU non-Kelvin connection

Table 4.4. Parts information

Description	Qty	Part number	Product
Triaxial cable – 1.5 m	1	—	16494A-001
Triaxial cable – 3.0 m	1	—	16494A-002

### Kelvin to non-Kelvin connection

These instructions apply when the connections up to the Connector Plate are Kelvin, but the probe is a non-Kelvin connection.

Connect a Keysight 16493K Kelvin triaxial cable (or two Keysight 16494A triaxial cables) between the SMU and the Connector plate.

Connect the triaxial connector on the probe cable as shown in Figure 4.7.

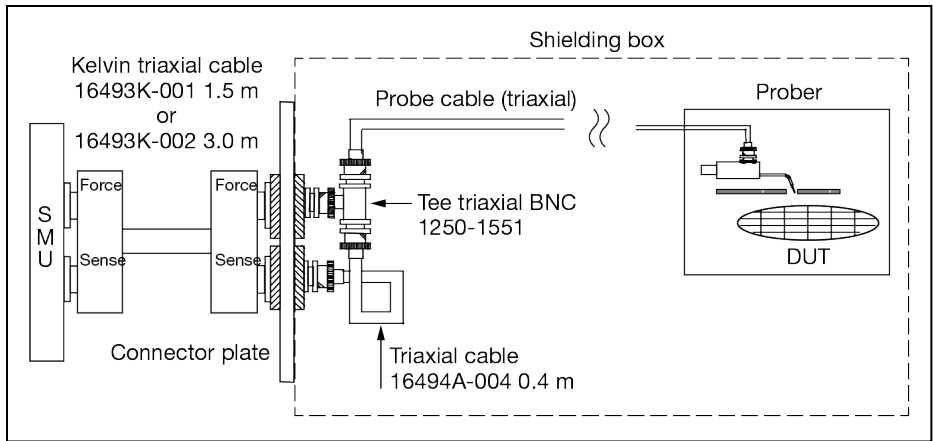

Figure 4.7. Examples of a SMU Kelvin to non-Kelvin connection

Connect the FORCE and SENSE lines on this side of the probe input terminal. A Tee Triaxial BNC adapter can be used. For parts information, see Table 4.5.

Table 4.5. Parts information

Description	Qty	Part number	Product
Kelvin triaxial cable – 1.5 m	1	—	16493K-001
Kelvin triaxial cable – 3.0 m	1	—	16493K-002
Triaxial cable – 0.4 m	1	—	16494A-004
Triaxial tee-connector	1	1250-1551	—

Note: When connecting the cable and tee connector as shown in Figure 4.7, space restrictions make an adjacent connector unusable. Since three connectors are necessary for a Kelvin connection a connector plate must be used. Select the correct connector plate for your application. To make two Kelvin connections, use a Keysight 16495H. To make three Kelvin connections, use a Keysight 16495J.

## ASU connection

Each ASU has one Dsub control cable, one triaxial cable, and (optionally) two coaxial cables connected to it. The cables can be connected to the ASU inside the shielding box through the 16495K plate.

The ASU outputs should be connected to the DUT by using triaxial cables as shown in Figure 4.8.

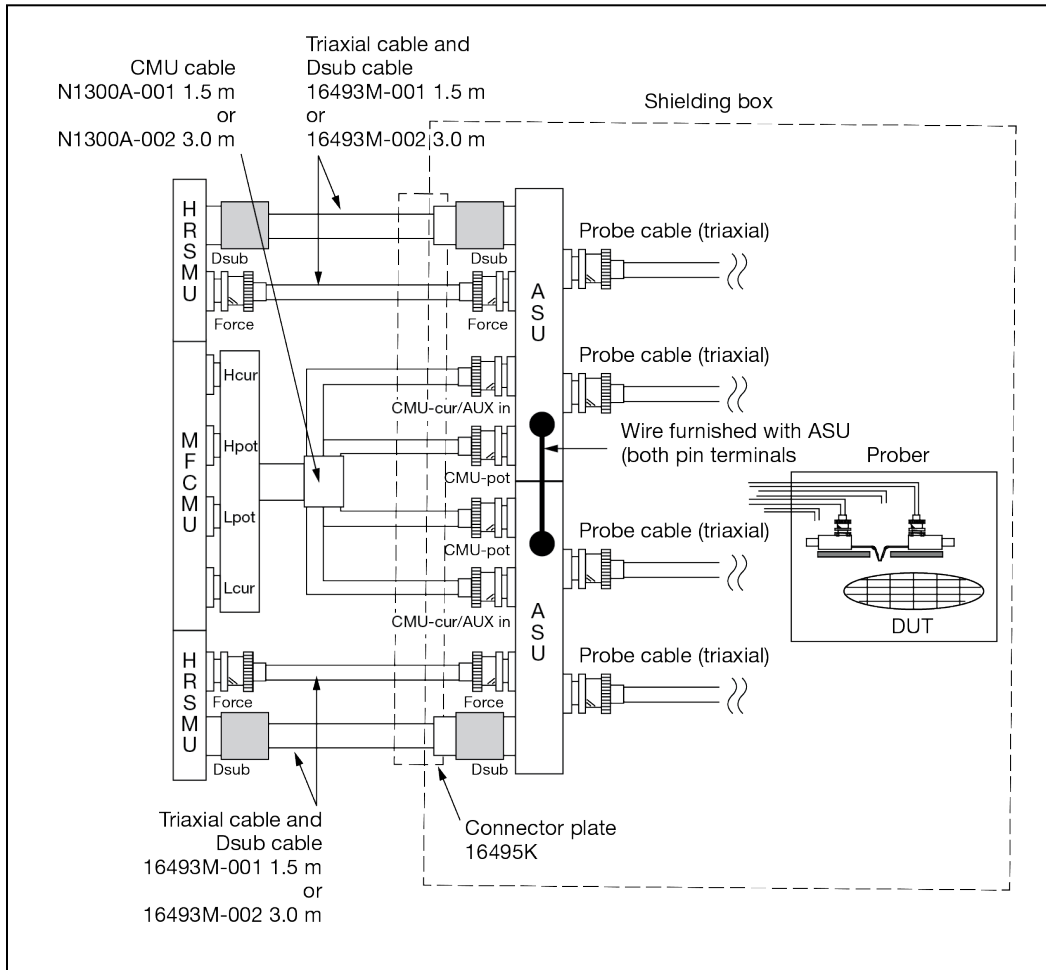

Figure 4.8. Examples of an ASU connection

Table 4.6. Parts information

Description	Qty	Part number	Product
Triaxial cable & Dsub cable for ASU – 1.5 m	2	—	16493M-001
Triaxial cable & Dsub cable for ASU – 3.0 m	2	—	16493M-002
CMU cable for B1500A – 1.5 m	1	—	N1300A-001
CMU cable for B1500A – 3.0 m	1	—	N1300A-002
Connector plate	1	—	16495K



When making IV measurements with the SMUs, all measurements are Kelvin. The SENSE line information is fed back to the SMU via the Dsub cable.

When making CV measurements, the four-terminal pair (4TP) connections are correctly terminated inside of the ASUs. The ASUs also allow for a current return path between the outer conductors to stabilize the series inductance and improve accuracy. You must connect the furnished wire between the two ASUs to enable this feature.

### SCUU positioner-based probing mode

The SCUU should be connected to the DUT by using triaxial cables as shown in Figure 4.9.

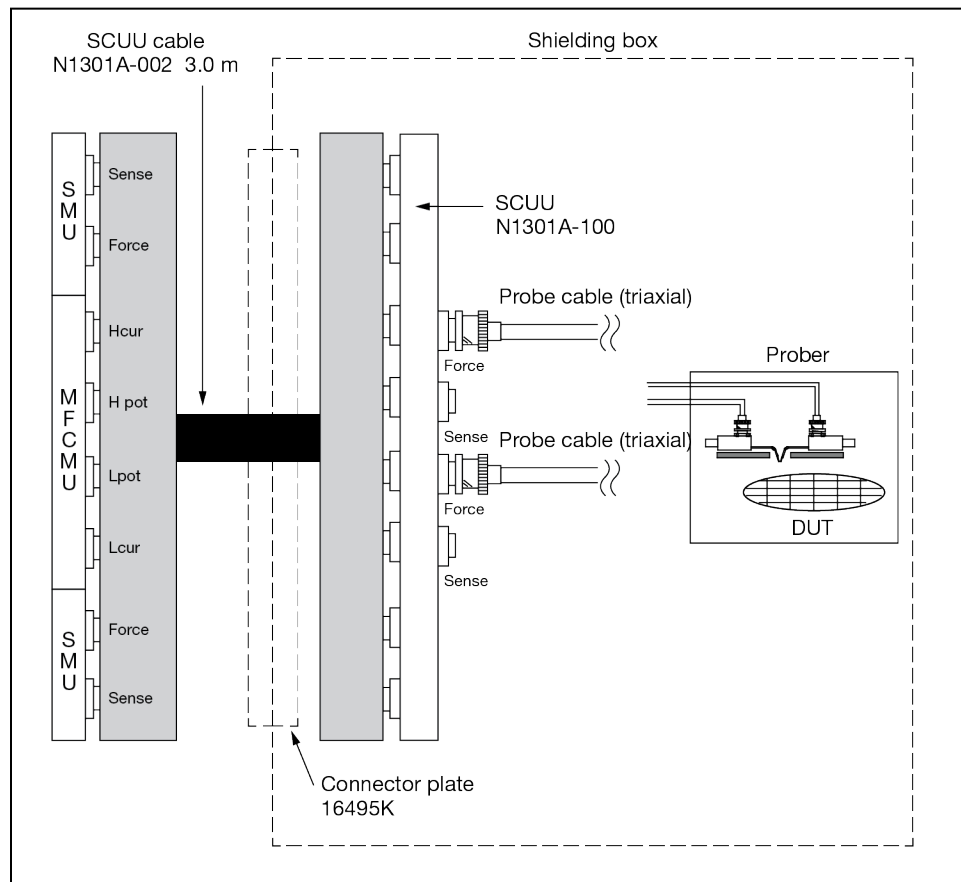

Figure 4.9. Examples of a SCUU remote docking mode

Table 4.7. Parts information

Description	Qty	Part number	Product
SMU CMU unify unit (SCUU)	1	—	N1301A-100
SMU CMU unify unit cable (3.0 m)	1	—	N1301A-102
Connector plate	1	—	16495K

When making IV measurements using the SMUs, the outputs of the SCUU function exactly the same as the Kelvin outputs of an SMU (both FORCE and SENSE lines are available).

Note: In Figure 4.9 the SENSE lines are not used.

When making CV measurements using the MFCMU, only the FORCE outputs of the SCUU are used. SCUU FORCE output1 corresponds to CMH, and SCUU FORCE output2 corresponds to CML.

The SCUU can be fixed on the prober by using SCUU Magnet Stand (N1301A-110).

## 5. Accessories

### 5.1. CMU accessories

B1500A has the multi frequency capacitance measurement unit (MFCMU). There are two types of CMU connection as follows.

- Standard four terminal pair (4TP) connection
- SCUU positioner-based probing mode

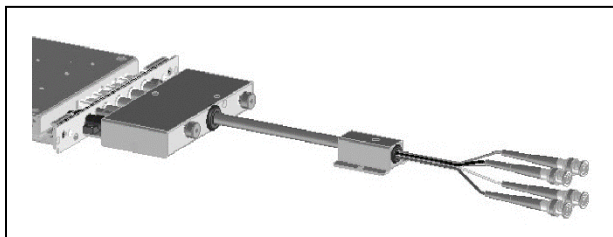

Figure 5.1. Standard four terminal pair (4TP)

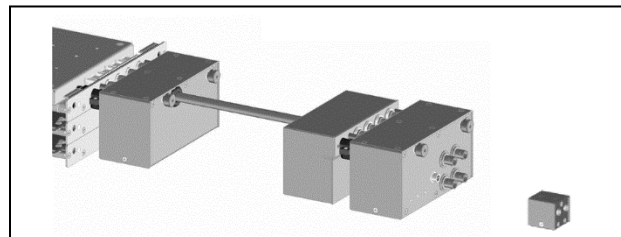

Figure 5.2. SCUU positioner-based probing

According to your situation, you can select the type of connection.

Table 5.1. CMU accessories overview

<p>N1300A-001/N1300A-002</p> 	<p>16494F-001</p> 	
<p>N1301A-100</p> 	<p>N1301A-100</p> 	<p>N1301A-100</p> 
<p>N1301A-102</p> 	<p>SCUU w/SCUU Cable, GSWU</p> 	
<p>N1301A-110</p> 	<p>SCUU w/SCUU magnet</p> 	<p>N1301A-200</p> 
<p>N1301A-201</p> 	<p>Pin cable for GSWU</p> 	<p>GSWU w/GSWU cable</p> 

Table 5.2. CMU accessories item list

Item	Description	OP instruction
N1300A	CMU cable for B1500A	
N1300A-001	CMU cable for B1500A (1.5 m)	
N1300A-002	CMU cable for B1500A (3.0 m)	
N1301A	CMU accessories for B1500	
N1301A-100	SMU CMU unify unit (SCUU)	
N1301A-102	SMU CMU unify unit cable (3 m)	
N1301A-110	SCUU magnet stand	To fix SCUU on prober top etc.
N1301A-200	Guard switch unit (GSWU)	Need to be specified with N1301A-201 or N1301A-202.
N1301A-201	Guard switch unit cable (1 m)	Please specify N1301A-201 or N1302A-202 when N1301A-200 is ordered.
N1301A-202	Guard switch unit cable (3 m)	
16494F	CMU input cable	
16494F-001	CMU input cable (2 m)	

## 5.2. B1500A peripherals

Table 5.3. B1500A peripherals overview

16444A-001	16444A-002	16444A-001 16444A-003
		

Table 5.4. B1500A peripherals item list

Item	Description	OP instruction
16444A	B1500A accessories	
16444A-001	USB keyboard	Keyboard includes mouse pad and mouse pointer
16444A-002	USB mouse	USB Mouse
16444A-003	Stylus pen	For use with the B1500A touch screen

### 5.3. Connector type

There are two main styles of Kelvin SMU connections. When connecting instruments together, you need to make sure that you have the correct type of Kelvin triaxial cables.

Type A connectors have two screws, one guide pin, and two triaxial terminals. Type B connectors have one screw and two triaxial terminals. These connectors are also different in their width and thickness.

Table 5.5. Overview of instrument connector types

B1500A



Type A



4156C+41501B



Type A



4155C



Single triaxial



E5260A/E5270B



Type A



B2200A/B2201A inputs

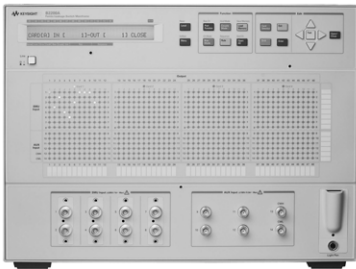

Type A



B2200A/B2201A outputs



Type B

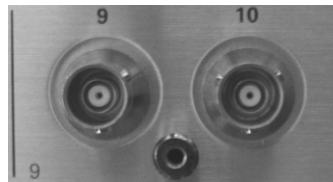

E5250A inputs



Type B



E5250A outputs (E5252A cards)



Type B

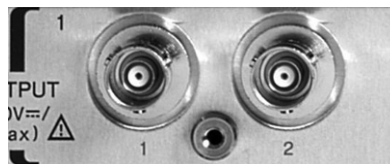

---

16442A/B



Type A



---

16493K/16494B/16493N cables

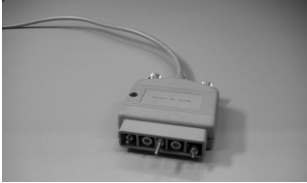

Type A

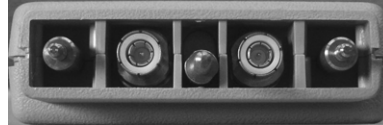

---

16494B cable



Type B



---

## 5.4. Cables





Several possibilities exist for connecting the Source Monitor Units (SMUs) to the DUT. The great variety of available cables can be categorized into mainly three types:

Triaxial cables have three layers or leads: a center conductor for the signal, a middle conductor that is actively driven to be at the same potential as the center conductor to eliminate leakage currents, and a grounded (Common) outer conductor.

Kelvin triaxial cables are similar to triaxial cables, except that both the Force and Sense lines from the SMU run through the same cable. The Force and Sense lines share a common driven guard and a common outer shield. Kelvin triaxial cables typically give better low-current measurement performance than you would get from using two separate triaxial cables for the Force and Sense lines.

The GNDU cable is a special triaxial cable designed to handle the large currents (up to 4.2 A) that the ground unit can sink. In the GNDU cable the center conductor is SENSE, the middle conductor is FORCE, and the outer conductor is Common.



Table 5.6. SMU cables overview

		16493K		16494B			
							
		Kelvin triaxial cable		Kelvin triaxial cable			
Connector type		Type A		Type A	Type B		
SMU	B1500A	OK		OK	NG		
	E526X	OK		OK	NG		
	E527X	OK		OK	NG		
	415X	OK		OK	NG		
	41501	OK		OK	NG		
SWM input	B220XA	OK		OK	NG		
	E5250A	NG		NG	OK		
SWM output	B220XA	NG		NG	OK		
	E5250A	NG		NG	OK		
Length option	0.4 m	N/A		N/A			
	0.8 m	N/A		16494B-003			
	1.5 m	16493K-001		16494B-001			
	3.0 m	16493K-002		16494B-002			
	4.0 m	N/A		N/A			
		16493M		16494A		16493J	
							
		Triaxial & Dsub cable For ASU		Triaxial cable		Interlock cable	
Connector type		—		Triax	—		
SMU	B1500A	OK		OK	OK	OK	
	E526X	N/A		OK	OK	OK	
	E527X	OK		OK	OK	OK	
	415X	N/A		OK	OK	OK	
	41501	N/A		OK	OK	N/A	
SWM input	B220XA	N/A		OK	N/A	N/A	
	E5250A	N/A		OK	N/A	N/A	



SWM output	B220XA	N/A	OK	N/A
	E5250A	N/A	OK	N/A
Length option	0.4 m	N/A	16494A-004	N/A
	0.8 m	N/A	16494A-003	N/A
	1.5 m	16493M-001	16494A-001	16493J-001
	3.0 m	16493M-002	16494A-002	16493J-002
	4.0 m	N/A	16494A-005	N/A

Table 5.7. GNDU cables overview

		16493N		16493L	
					
		Ground unit cable		Ground unit cable	
Connector type		Type A	Type A	Type B	
GNDU	B1500A	N/A	OK	OK	
	E526X	N/A	OK	OK	
	E527X	N/A	OK	OK	
	415X	N/A	N/A	N/A	
	41501	N/A	OK	OK	
SWM input	B220XA	OK	OK	OK	
	E5250A	NG	OK	OK	
SWM output	B220XA	NG	OK	OK	
	E5250A	NG	OK	OK	
Length option	1.5 m	16493N-001			16493L-001
	3.0 m	N/A			16493L-002

## 5.5. Connector plates

The following connector plates work with a variety of Keysight semiconductor parametric measurement instruments, such as the B1500, B2200/B2201, E5250, E5260/E5270, 4155/4156 and 41501.

Prober vendor also provides connector plates. If you need the information of those connector plates, please kindly contact each prober vendor.

If you need parts to fix a connector plate, see Table 5.8. Order the quantity you need. (The number of holes in a connector plate is four.)

Table 5.8. Parts information to fix connector plates

Description	Qty	Part number	Product
Screw	1	0515-0986	—
Spring washer	1	2190-0584	—
Terminal washer	1	3050-0891	—
Nut	1	0535-0031	—

Table 5.9. Connector plates

**16495F—Half size connector plate for matrix**

16495F-001 has 12 triaxial through connectors (female to female), an Intlk connector, and a GNDU connector (triaxial through, female to female). The back of the Intlk connector is designed for soldering.

16495F-002 has 12 triaxial connectors, an Intlk connector, and a GNDU connector. The back of each connector is designed for soldering.



**16495G—Full size connector plate for matrix**

16495G-001 has 24 triaxial through connectors (female to female), an Intlk connector, and a GNDU connector (triaxial through, female to female). The back of the Intlk connector is designed for soldering.

16495G-002 has 24 triaxial connectors, an Intlk connector, and a GNDU connector. The back of each connector is designed for soldering.

**16495H—Half size connector plate for analyzer**

16495H-001 has 6 triaxial through connectors (female to female), 6 BNC through connectors (female to female), an Intlk connector, and a GNDU connector (triaxial through, female to female). The back of the Intlk connector is designed for soldering.

16495H-002 has 6 triaxial connectors, 6 BNC connectors, an Intlk connector, and a GNDU connector. The back of each connector is designed for soldering.



---

### 16495J—Half size connector plate for analyzer

16495J-001 has 8 triaxial through connectors (female to female), 4 BNC through connectors (female to female), an Intlk connector, and a GNDU connector (triaxial through, female to female). The back of the Intlk connector is designed for soldering.

16495J-002 has 8 triaxial connectors, 4 BNC connectors, an Intlk connector, and a GNDU connector. The back of each connector is designed for soldering.



---

### 16495K—Half size connector plate with universal cable holder

16495K-001 does not have any connectors. This plate provides the cable hole and the cover with rubber used to block the light from the cable hole. This plate will be used with the Keysight E5288A Atto Sense/Switch Unit (ASU) or the Keysight N1301A-200 Guard Switch Unit (GSWU) that will be installed in the shielding box. The cable hole is to pass the cables from the ASU or GSWU to the instrument such as the Keysight B1500A, E5270B, and so on. And the cables will be fixed to the shielding box by using the cover with rubber that will close the opening of the cable hole.

---

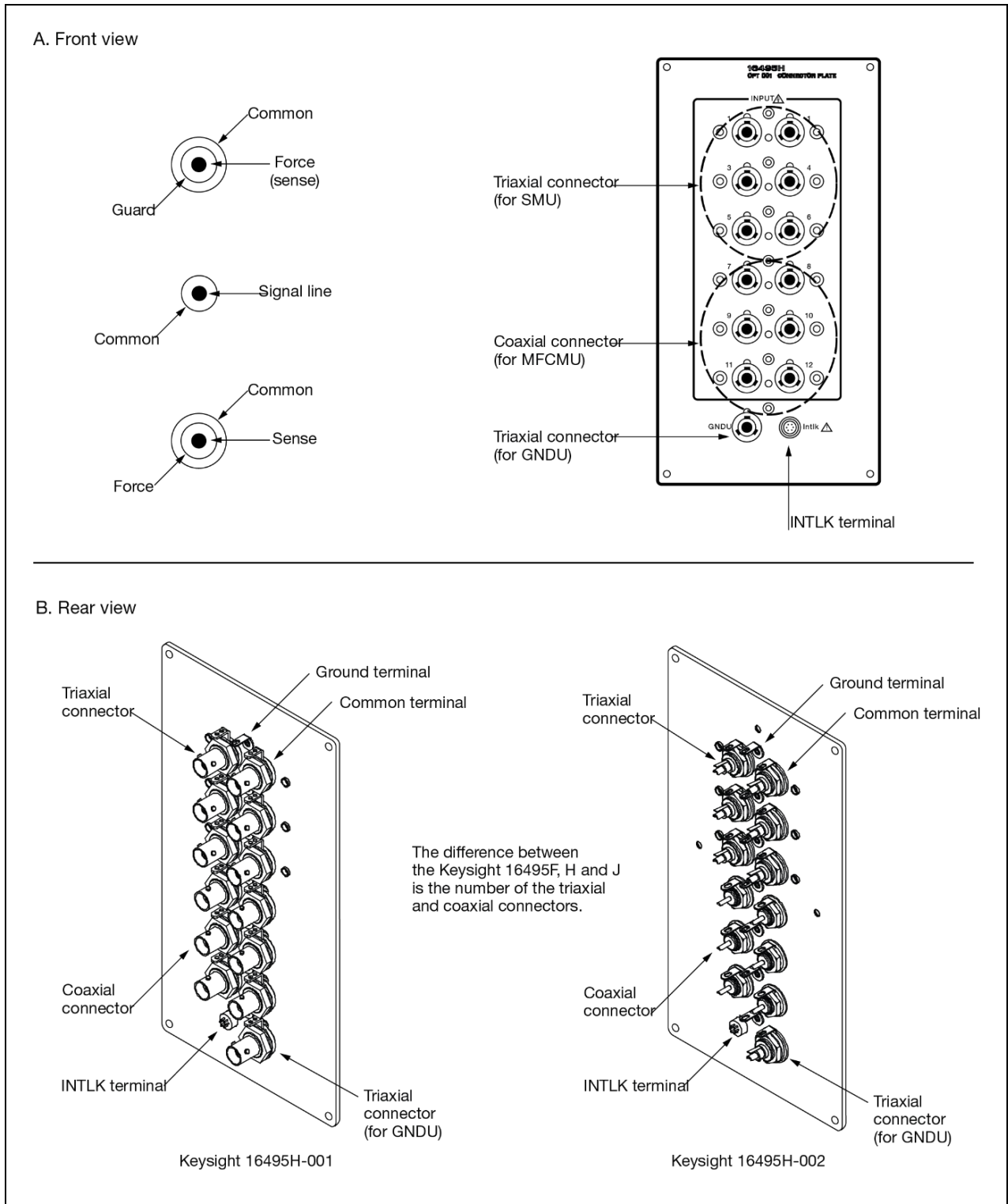

Figure 5.3. Front view and rear view of connector plate

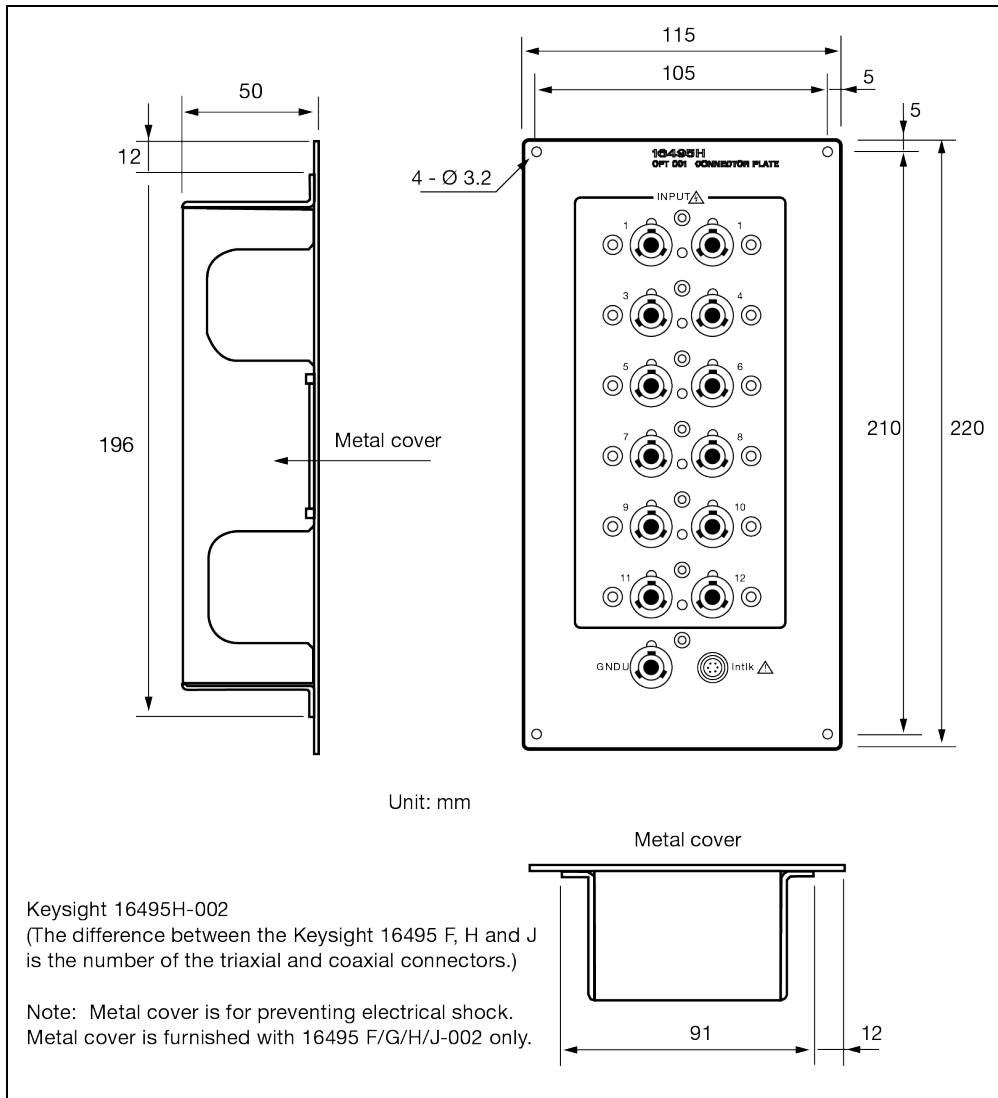

Figure 5.4. Dimensions of the connector plate (Keysight 16495F/H/J)

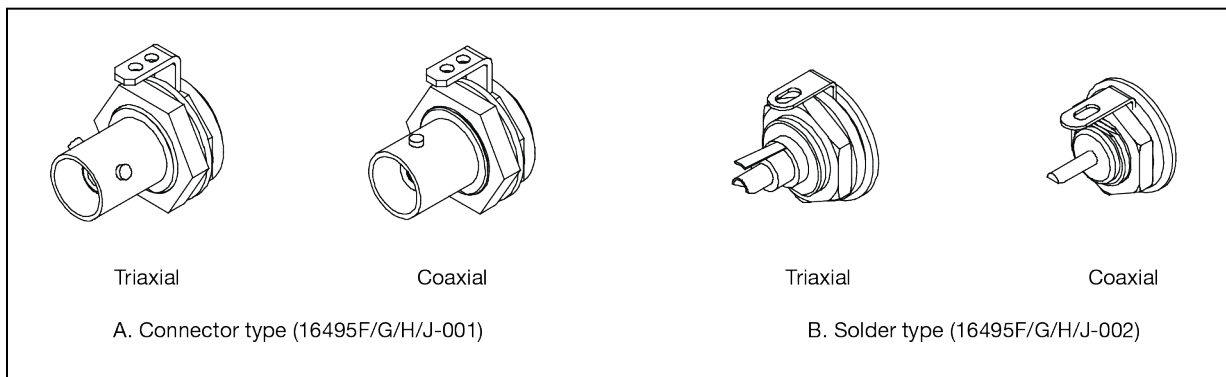

Figure 5.5. Connection type of connector plate (rear)

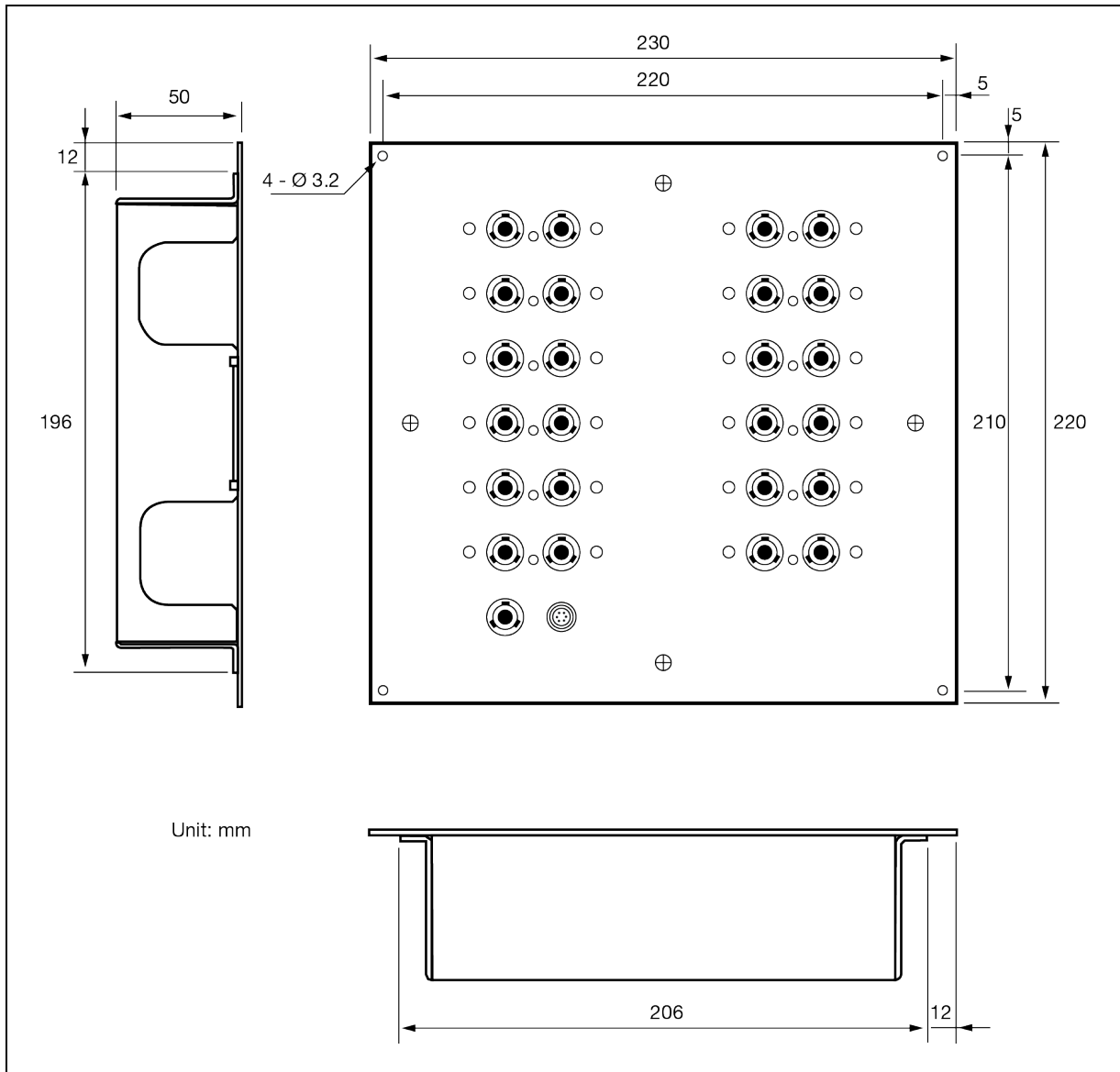

Figure 5.6. Dimensions of the connector plate (Keysight 16495G)

## 5.6. Adapters and connectors

If you need to make a connection between a triaxial connector and a coaxial connector, use a triaxial-coaxial adapter.

Table 5.10 shows the adapter information provided by Keysight. If you need an adapter which is not provided, contact a local parts vendor.

## WARNING

To avoid injury, always be sure to use a shielding box and Interlock when you make a measurement.

Do not use the adapters in Table 5.10 when the GUARD line connects to the outer conductor of the connector or adapter. Because they connect GUARD line and outer conductor of the connector or adapter, the potential of the GUARD terminal is equal to the output voltage and there is a potential for high voltage electrical shock at the adapter and connector.

Table 5.10. Parts information

Item	Description	Qty	Part number	Illustration
N1254A-100	GNDU to Kelvin adapter	1	—	
N1254A-101	Triaxial (m) – Coaxial (f)	1	1250-2648	
N1254A-102	Triaxial (f) – Coaxial (m)	1	1250-2649	
N1254A-103	Triaxial (m) – Coaxial (f)	1	1250-2650	
N1254A-104	Triaxial (f) – Coaxial (m)	1	1250-2651	
N1254A-105	Triaxial (f) – Coaxial (m)	1	1250-2652	
N1254A-106	Triaxial (m) – Coaxial (f)	1	1250-2653	
N1254A-107	Triaxial (m) – Triaxial (f)	1	1250-2654	

Learn more at: [www.keysight.com](http://www.keysight.com)

For more information on Keysight Technologies' products, applications or services, please contact your local Keysight office. The complete list is available at: [www.keysight.com/find/contactus](http://www.keysight.com/find/contactus)

