

---

# RP7970 & RP7980 Series Regenerative Power System

RP7972A, RP7973A, RP7982A, RP7983A, RP7984A



<b>Legal and Safety Information</b> .....	<b>9</b>
<b>Legal Notices</b> .....	<b>9</b>
<b>Safety and Regulatory Symbols</b> .....	<b>11</b>
<b>Safety Notices</b> .....	<b>12</b>
<b>1 Quick Reference</b> .....	<b>15</b>
<b>Introduction to the Instrument</b> .....	<b>16</b>
Regenerative Power System at a Glance .....	16
Front Panel at a Glance .....	17
Rear Panel at a Glance .....	18
Front Panel Display at a Glance .....	20
Front Panel Keys at a Glance .....	21
<b>Front Panel Menu Reference</b> .....	<b>22</b>
<b>Command Quick Reference</b> .....	<b>25</b>
<b>Model Features and Options</b> .....	<b>35</b>
Model Features .....	35
Options/Accessories .....	35
<b>Specifications and Characteristics</b> .....	<b>36</b>
Specifications .....	36
Supplemental Characteristics .....	37
Common Characteristics .....	38
AC Input Efficiency, Power Factor, and THD .....	41
Output Impedance Graphs .....	45
Inductive Load Boundary for Constant Current (CC) Operation .....	49
Capacitive Load Boundary for Constant Voltage (CV) Operation .....	51
Small Signal Programming Response .....	54
Measurement Accuracy and Resolution - with shorter measurement intervals .....	55
Excessive Dynamic Protection (all models) .....	55
Output Quadrants .....	56
<b>2 Installing the Instrument</b> .....	<b>57</b>
<b>Before Installation or Use</b> .....	<b>58</b>
Inspect the Unit .....	58
Check for Items Supplied .....	58
Review Safety Information .....	58
Observe Environmental Conditions .....	59
Provide Adequate Air Flow .....	59
Moving Instruments .....	59
Stacking Instruments .....	59
Rack Mounting Accessories .....	59
Outline Diagram for 20 kW Models .....	60
Outline Diagram for 30 kW Models .....	61
<b>AC Mains Connections</b> .....	<b>62</b>
AC Mains Considerations .....	62
Power Cable Connections .....	63
<b>Single Unit Output Connections</b> .....	<b>66</b>
Output Connections .....	66
Single Load Connections .....	67

Multiple Load Connections .....	69
Remote Sense Connections .....	70
Additional Load Considerations .....	72
<b>Multiple Unit Output Connections .....</b>	<b>75</b>
Parallel Connections .....	75
Load and Sense Connections .....	75
Primary/Secondary Connections .....	77
Series Connections .....	77
<b>Interface Connections .....</b>	<b>78</b>
GPIB Connections .....	78
USB Connections .....	78
LAN Connections - site and private .....	79
Digital Port Connections .....	80
Interface Cover Installation .....	81
<b>3 Getting Started .....</b>	<b>83</b>
<b>Using the Front Panel .....</b>	<b>84</b>
Turn the Unit On .....	84
Set the Output Voltage .....	84
Set the Output Current .....	85
Set Over-voltage Protection .....	86
Enable the Output .....	87
Use Built-in Help System .....	88
<b>Remote Interface Configuration .....</b>	<b>89</b>
Introduction .....	89
USB Configuration .....	89
GPIB Configuration .....	89
LAN Configuration .....	90
Modifying the LAN Settings .....	91
Using the Web Interface .....	93
Using Telnet .....	94
Using Sockets .....	95
Interface Lockout .....	95
<b>4 Using the Regenerative Power System .....</b>	<b>97</b>
<b>Programming the Output .....</b>	<b>98</b>
Set the Output Priority Mode .....	98
Set the Output Voltage .....	99
Set the Output Current .....	99
Set the Slew Rate .....	100
Set the Output Resistance .....	100
Set the Output Bandwidth .....	101
Set the Output Turn-On/Turn-Off Mode .....	102
Enable the Output .....	103
<b>Parallel Operation .....</b>	<b>104</b>
Introduction .....	104
Primary/Secondary Configuration .....	104
Primary/Secondary Front Panel Display .....	106
Primary/Secondary Programming Considerations .....	106



Primary/Secondary Power Rating Considerations .....	108
Primary/Secondary Command Details .....	110
Troubleshooting .....	110
<b>Current Sinking Operation .....</b>	<b>112</b>
Current Sinking .....	112
Regenerative Operation .....	112
<b>Programming Output Protection .....</b>	<b>113</b>
Introduction .....	113
Set the Over-Voltage Protection .....	115
Set the Over-Current Protection .....	115
Output Watchdog Timer .....	116
Set the Under-Voltage Protection .....	117
Clear Output Protection .....	118
<b>Programming Output Transients .....</b>	<b>119</b>
Introduction .....	119
Common Actions for All Transients .....	119
Programming a Step Transient .....	122
Programming a List Transient .....	123
Programming an Arbitrary Waveform .....	127
<b>Sequencing the Output .....</b>	<b>129</b>
Turn-On/Turn-Off Delays .....	129
Coupling the Output .....	129
Sequencing Multiple Units .....	130
Output Turn-On Turn-Off Behavior .....	131
<b>Making Measurements .....</b>	<b>134</b>
Average Measurements .....	134
Measurement Sweep .....	134
Measurement Windowing .....	135
Amp-hour & Watt-hour measurement .....	135
Digitized Measurements .....	136
Measurement Triggering .....	138
<b>External Data Logging .....</b>	<b>143</b>
Introduction .....	143
Select the Measurement Function .....	143
Specify the Integration Period .....	144
Select the Elog Trigger Source .....	144
Initiate and Trigger the Elog .....	145
Periodically Retrieve the Data .....	145
Terminate the Elog .....	146
<b>Programming the Digital Port .....</b>	<b>147</b>
Digital Control Port .....	147
Bi-Directional Digital I/O .....	148
Digital Input .....	149
External Trigger I/O .....	149
Fault Output .....	150
Inhibit Input .....	150
Fault/Inhibit System Protection .....	151
Output Couple Control .....	151

<b>System-Related Operations</b> .....	<b>153</b>
Instrument Identification .....	153
Instrument State Storage .....	153
Front Panel Display .....	154
Front Panel Lock-Out .....	154
Password Protection .....	155
Clock Setup .....	155
<b>Photovoltaic (SAS) Operation</b> .....	<b>156</b>
Introduction .....	156
Programming the Curve Parameters .....	157
Programming the Table Parameters .....	157
Programming Multiple Tables .....	158
Programming Additional Parameters .....	160
SAS Command Details .....	160
Troubleshooting .....	161
Model Equations .....	161
<b>Priority Mode Tutorial</b> .....	<b>163</b>
Voltage Priority .....	163
Current Priority .....	164
<b>5 SCPI Programming Reference</b> .....	<b>167</b>
<b>Related Software</b> .....	<b>168</b>
<b>SCPI Introduction</b> .....	<b>169</b>
Introduction .....	169
Keywords .....	170
Queries .....	170
Command Separators and Terminators .....	170
Syntax Conventions .....	171
Parameter Types .....	172
Device Clear .....	173
Typical Command Processing Times .....	173
<b>Commands by Subsystem</b> .....	<b>175</b>
ABORt Subsystem .....	176
ARB Subsystem .....	177
CALibrate Subsystem .....	179
CURRent Subsystem .....	182
DIGital Subsystem .....	185
DISPlay Subsystem .....	187
FETCh Subsystem .....	188
FORMat Subsystem .....	191
FUNCTion Command .....	192
HCOPy Subsystem .....	193
IEEE-488 Common Commands .....	194
INITiate Subsystem .....	199
INSTrument Subsystem .....	200
LIST Subsystem .....	202
LXI Subsystem .....	205
MEASure Subsystem .....	206

OUTPut Subsystem .....	208
POWer Query .....	213
SASimulator Subsystem .....	214
SENSe Subsystem .....	219
[SOURce] Subsystem .....	222
STATus Subsystem .....	223
STEP Command .....	227
SYSTem Subsystem .....	228
TRIGger Subsystem .....	232
VOLTage Subsystem .....	235
<b>Status Tutorial .....</b>	<b>240</b>
Status Registers .....	240
Operation Status Group .....	240
Questionable Status Groups .....	241
Standard Event Status Group .....	242
Status Byte Register .....	243
Error and Output Queues .....	243
Status Diagram .....	244
<b>Trigger Tutorial .....</b>	<b>245</b>
Trigger Sources .....	245
Trigger Destinations .....	245
Trigger Diagram .....	246
<b>Reset State (*RST) .....</b>	<b>247</b>
<b>SCPI Error Messages .....</b>	<b>252</b>
<b>Compatibility Commands .....</b>	<b>260</b>
<b>6 Verification and Calibration .....</b>	<b>261</b>
<b>Test Equipment and Setups .....</b>	<b>262</b>
Test Equipment .....	262
Measurement Setups .....	263
<b>Performance Verification .....</b>	<b>264</b>
Introduction .....	264
Verification Setups .....	266
Test Considerations .....	266
Verification Procedure .....	267
<b>Instrument Calibration .....</b>	<b>271</b>
Introduction .....	271
Calibration Interval .....	272
Calibration Setups .....	272
Test Considerations .....	272
Calibration Procedure .....	273
<b>Test Record Forms - RPS family .....</b>	<b>276</b>
<b>7 Service and Maintenance .....</b>	<b>281</b>
<b>Introduction .....</b>	<b>282</b>
Repair Service Available .....	282
Before Returning the Unit .....	282
Repackaging for Shipment .....	282
Cleaning .....	283

<b>Self-Test Procedure</b> .....	<b>284</b>
Power-On Self-Test .....	284
User-Initiated Self-Test .....	284
<b>Firmware Update</b> .....	<b>285</b>
Software Required .....	285
Update Procedure .....	285
Restricting Access .....	285
<b>Instrument Sanitize</b> .....	<b>286</b>
Turn-on after Sanitization .....	286
Sanitizing an Inoperative Instrument .....	286
<b>Calibration Switches</b> .....	<b>287</b>
Accessing the Calibration Switch .....	287
Switch Functions .....	287
<b>Battery Replacement</b> .....	<b>288</b>
<b>Disassembly</b> .....	<b>290</b>
Electrostatic Discharge (ESD) Precautions .....	290
Tools Required .....	290
Cover Disassembly .....	290
Control Board Disassembly .....	291
Constellation Board Disassembly .....	291
<b>Index</b> .....	<b>293</b>

## Legal and Safety Information

### Legal Notices

### Safety and Regulatory Symbols

### Safety Notices

## Legal Notices

© Copyright Keysight Technologies 2020 - 2023

Edition 6, September 2022

Updated January 2023

Manual part number RP7900-90951

No part of this manual may be reproduced in any form or by any means (including electronic storage and retrieval or translation into a foreign language) without prior agreement and written consent from Keysight Technologies as governed by United States and international copyright laws.

In this document the terms “master” and “slave” have been replaced with “primary” and “secondary.”

Keysight Technologies

550 Clark Drive, Suite 101

Budd Lake, NJ 07828 USA

## Software

This product uses Microsoft Windows CE. Keysight highly recommends that all Windows-based computers connected to Windows CE instruments use current anti-virus software.

The hardware and/or software described in this document are furnished under a license and may be used or copied only in accordance with the terms of such license.

## License Files

From gifencode C source code:

\* Code drawn from ppmtogif.c, from the pbmplus package Based on GIFENCOD  
\* by David Rowley <mgardi@watdscu.waterloo.edu>. A Lempel-Zim  
\* compression based on "compress". Modified by Marcel Wijkstra  
\* <wijkstra@fwi.uva.nl> Copyright (C) 1989 by Jef Poskanzer. Permission  
\* to use, copy, modify, and distribute this software and its  
\* documentation for any purpose and without fee is hereby granted,  
\* provided that the above copyright notice appear in all copies and that  
\* both that copyright notice and this permission notice appear in  
\* supporting documentation. This software is provided "as is" without  
\* express or implied warranty. The Graphics Interchange Format(c) is the  
\* Copyright property of CompuServe Incorporated. GIF(sm) is a Service  
\* Mark property of CompuServe Incorporated. ;

## Warranty

The material contained in this document is provided "as is," and is subject to being changed, without notice, in future editions. Further, to the maximum extent permitted by applicable law, Keysight disclaims all warranties, either express or implied, with regard to this manual and any information contained herein, including but not limited to the implied warranties of merchantability and fitness for a particular purpose. Keysight shall not be liable for errors or for incidental or consequential damages in connection with the furnishing, use, or performance of this document or of any information contained herein. Should Keysight and the user have a separate written agreement with warranty terms covering the material in this document that conflict with these terms, the warranty terms in the separate agreement shall control.

## Certification

Keysight Technologies certifies that this product met its published specifications at time of shipment from the factory. Keysight Technologies further certifies that its calibration measurements are traceable to the United States National Institute of Standards and Technology, to the extent allowed by the Institute's calibration facility, and to the calibration facilities of other International Standards Organization members

## US Government Rights

The Software is "commercial computer software," as defined by Federal Acquisition Regulation ("FAR") 2.101. Pursuant to FAR 12.212 and 27.405-3 and Department of Defense FAR Supplement ("DFARS") 227.7202, the U.S. government acquires commercial computer software under the same terms by which the software is customarily provided to the public. Accordingly, Keysight provides the Software to U.S. government customers under its standard commercial license, which is embodied in its End User License Agreement (EULA), a copy of which can be found at [www.keysight.com/find/sweula](http://www.keysight.com/find/sweula). The license set forth in the EULA represents the exclusive authority by which the U.S. government may use, modify, distribute, or disclose the Software. The EULA and the license set forth therein, does not require or permit, among other things, that Keysight: (1) Furnish technical information related to commercial computer software or commercial computer software documentation that is not customarily provided to the public; or (2) Relinquish to, or otherwise provide, the government rights in excess of these rights customarily provided to the public to use, modify, reproduce, release, perform, display, or disclose commercial computer software or commercial computer software documentation. No additional government requirements beyond those set forth in the EULA shall apply, except to the extent that those terms, rights, or licenses are explicitly required from all providers of commercial computer software pursuant to the FAR and the DFARS and are set forth specifically in writing elsewhere in the EULA. Keysight shall be under no obligation to update, revise or otherwise modify the Software. With respect to any technical data as defined by FAR 2.101, pursuant to FAR 12.211 and 27.404.2 and DFARS 227.7102, the U.S. government acquires no greater than Limited Rights as defined in FAR 27.401 or DFAR 227.7103-5 (c), as applicable in any technical data.

## Waste Electrical and Electronic Equipment (WEEE) Directive 2012/19/EU

The following crossed out wheeled bin symbol indicates that separate collection for waste electric and electronic equipment (WEEE) is required, as obligated by DIRECTIVE 2012/19/EU and other National legislation.

Do not dispose in domestic household waste. Please refer to [about.keysight.com/en/companyinfo/environment/takeback.shtml](http://about.keysight.com/en/companyinfo/environment/takeback.shtml) to understand your trade in options with Keysight in addition to product takeback instructions.



## Safety and Regulatory Symbols

**WARNING** A WARNING notice denotes a hazard. It calls attention to an operating procedure, practice, or the like that, if not correctly performed or adhered to, could result in personal injury or DEATH. Do not proceed beyond a WARNING notice until the indicated conditions are fully understood and met.

**CAUTION** A CAUTION notice denotes a hazard. It calls attention to an operating procedure, practice, or the like that, if not correctly performed or adhered to, could result in damage to the product or loss of important data. Do not proceed beyond a CAUTION notice until the indicated conditions are fully understood and met.



Direct current



Alternating current



Frame or chassis terminal



Standby supply. Unit is not completely disconnected from ac mains when switch is off.



**WARNING** risk of electric shock



**WARNING** refer to accompanying documents



Earth ground terminal



The CE mark is a registered trademark of the European Community.  
CAN ICES/NMB-001(A) indicates compliance with the Canadian Interference- Causing Equipment Standard.  
ISM GRP 1-A indicates that the instrument is an Industrial Scientific and Medical Group 1 Class A product (CISPER 11, Clause 4)



The ETL mark is a registered trademark of Intertek. The text indicates product compliance with the Canadian Interference- Causing Equipment Standard (ICES-001).



The RCM mark is a registered trademark of the Australian Communications and Media Authority.



Indicates United Kingdom Conformity Assessed.



Contains one or more of the 6 hazardous substances above the maximum concentration value (MCV), 40 Year EPUP.



South Korean Class A EMC Declaration.  
This equipment has been conformity assessed for use in business environments. In a residential environment this equipment may cause radio interference. This EMC statement applies to the equipment only for use in business environments.

### 사용자 안내문

이 기기는 업무용 환경에서 사용할 목적으로 적합성평가를 받은 기기로서 가정용 환경에서 사용하는 경우 전파간섭의 우려가 있습니다.

※ 사용자 안내문은 "업무용 방송통신기자재"에만 적용한다.

## Safety Notices

The following general safety precautions must be observed during all phases of operation of this instrument. Failure to comply with these precautions or with specific warnings or instructions elsewhere in this manual violates safety standards of design, manufacture, and intended use of the instrument. Keysight Technologies assumes no liability of the customer's failure to comply with the requirements.

The equipment is for industrial use. Equipment operators are subject to all applicable safety regulations. Along with the warning and safety notices in this manual, all relevant safety, accident prevention, and environmental regulations must also be followed. In particular, the operators of the equipment:

- Must be informed of the relevant safety requirements.
- Must have read and understood the operating manual before using the equipment.
- Must use the designated and recommended safety equipment.

### WARNING

#### General

Do not use this product in any manner not specified by the manufacturer. The protective features of this product may be impaired if it is used in a manner not specified in the operating instructions.

---

### WARNING

#### Environmental Conditions

Never use the instrument outside of the specified environmental conditions described in the Environmental Characteristics of the specifications.

---

### WARNING

#### Heavy Weight

Danger to hands and feet. To avoid personal injury and damage to the instrument, always use a sturdy cart or other suitable device to move the instrument. Do not lift the instrument alone; always use two people to lift the instrument.

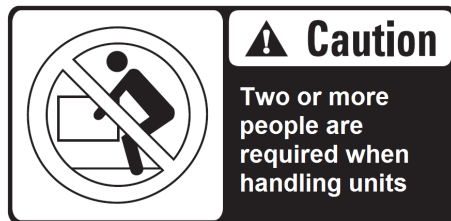

### WARNING

#### SHOCK HAZARD Ground the Instrument

This product is provided with a protective earth terminal. To minimize shock hazard, the instrument must be connected to the ac mains through a grounded power cable, with the ground wire firmly connected to an electrical ground (safety ground) at the power outlet. Any interruption of the protective (grounding) conductor or disconnection of the protective earth terminal will cause a potential shock hazard that could result in injury or death.

---



**WARNING**

**Before Applying Power**

Verify that all safety precautions are taken. All connections must be made with the unit turned off, and must be performed by qualified personnel who are aware of the hazards involved. Improper actions can cause fatal injury as well as equipment damage. Note the instrument's external markings described under "Safety Symbols".

---

**WARNING**

**SHOCK HAZARD, LETHAL VOLTAGES** - Many models generate output voltages up to 2,000 VDC! Ensure that all instrument connections, load wiring, load and sense connections are insulated using high-voltage wire. Always attach the safety cover provided, so that no accidental contact with lethal voltages can occur.

---

**WARNING**

**SHOCK HAZARD** Never touch cables or connections immediately after turning off the unit. Depending on the model, lethal voltages can remain at the output terminals for several seconds after turn-off. Verify that there is no dangerous voltage on the output or sense terminals before touching them.

---

**WARNING**

**SHOCK HAZARD** from external energy sources.

Because the instrument can be used as a load to sink current, hazardous voltages from an external energy source such as a battery may be present on the output terminals even with the unit turned off. Provision must be made to disconnect the external energy source before touching the output or sense terminals.

---

**WARNING**

**Do Not Operate in an Explosive Atmosphere**

Do not operate the instrument in the presence of flammable gases or fumes.

---

**WARNING**

**Do Not Remove the Instrument Cover**

Only qualified, service-trained personnel who are aware of the hazards involved should remove instrument covers. Always disconnect the power cable and any external circuits before removing the instrument cover.

---

**WARNING**

**Do Not Modify the Instrument**

Do not install substitute parts or perform any unauthorized modification to the product. Return the product to a Keysight Sales and Service Office for service and repair to ensure that safety features are maintained.

---

**WARNING**

**Fuses**

The instrument contains an internal fuse, which is not customer accessible.

---

**WARNING**

**Cleaning**

To prevent electric shock, always disconnect the ac mains before cleaning. Use a dry cloth or one slightly dampened with water to clean the external case parts. Do not use detergent or chemical solvents. Do not attempt to clean internally.

---

**WARNING**

**In Case of Damage**

Instruments that are not functioning correctly, appear damaged or defective should be made inoperative and secured against unintended operation until they can be repaired by qualified service personnel.

---

# 1

## Quick Reference

**Legal and Safety Information**

**Introduction to the Instrument**

**Front Panel Menu Reference**

**Command Quick Reference**

**Model Features and Options**

**Specifications and Characteristics**

This document includes user, service, and programming information for the Keysight Regenerative Power System (RPS) family.

### **Documentation, Firmware, and Technical Support**

You can download the latest version of this document at [www.keysight.com/find/RPSPV-doc](http://www.keysight.com/find/RPSPV-doc).

For the latest firmware revision go to [Firmware Updates](#).

If you have questions about your shipment, or if you need information about warranty, service, or technical support, contact Keysight Technologies.

### **Contacting Keysight Technologies**

Use [www.keysight.com/find/assist](http://www.keysight.com/find/assist) for information on contacting Keysight worldwide, or contact your Keysight Technologies representative.

## Introduction to the Instrument

**Regenerative Power System at a Glance**

**Front Panel at a Glance**

**Rear Panel at a Glance**

**Front Panel Display at a Glance**

**Front Panel Keys at a Glance**

### Regenerative Power System at a Glance

The Keysight Regenerative Power System (RPS) series include 3U and 5U rack-mountable dc power supplies with performance and features that are optimized for automated test systems. The output and system features are described as follows. The **Models and Options** section describes the features that apply to specific models.

#### Output features

- Full programming capability for the entire range of output voltage and current
- Output autoranging for greater flexibility
- Output can operate in voltage priority, current priority, or photovoltaic (SAS) modes
- High-speed up and down output programming
- Output resistance programming
- Programmable arbitrary waveform and output list capability
- Turn-on/turn-off delays allow output on/off sequencing across multiple units
- Current sharing capability for paralleled outputs
- Protection capability includes over-voltage, over-current, and over-temperature
- Solid-state output disconnect switch for fast protection and smooth turn on/off transitions
- Two-quadrant operation provides current sourcing and sinking capability
- 20 kW and 30 kW rated models

#### Measurement features

- 5.12 microsecond sample rate
- Real-time power measurements
- Amp-hour & Watt-hour measurement
- Digitized measurement capability

## System features

- Save and recall up to 10 instrument states in non-volatile memory
- GPIB (IEEE-488), LAN, and USB remote programming interfaces are built in
- Front panel menu setup for GPIB and LAN parameters
- Compliant with 1.5 LXI Device Specification 2016, including a built-in Web server
- SCPI (Standard Commands for Programmable Instruments) compatibility
- Primary/secondary function allows for composite output control and display from one unit

## Regenerative Operation

Whenever the RPS is sinking current, either by rapidly down-programming the output, or by discharging an energy source such as a battery, the unit will direct the excess power back to the ac mains. You cannot disable the regenerative operation.

During regenerative operation, the power factor of 0.99 is maintained. Sine wave current distortion is less than 2% at full load. This ensures the quality of the ac signal that is returned to the ac mains.

When an ac mains dropout is sensed, galvanic relays disconnect the ac mains and the unit shuts down. To safeguard your device under test, the RPS provides “anti-islanding” that senses that the grid is live before regenerating power back to the grid.

Refer to [AC Mains Considerations](#) for additional information about unit shutdown and restart.

## Front Panel at a Glance

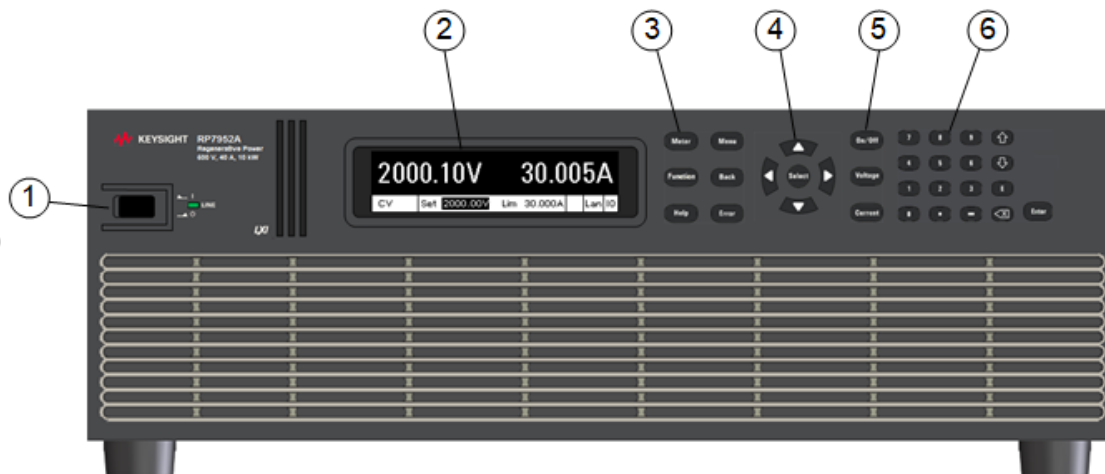

## 1 Quick Reference

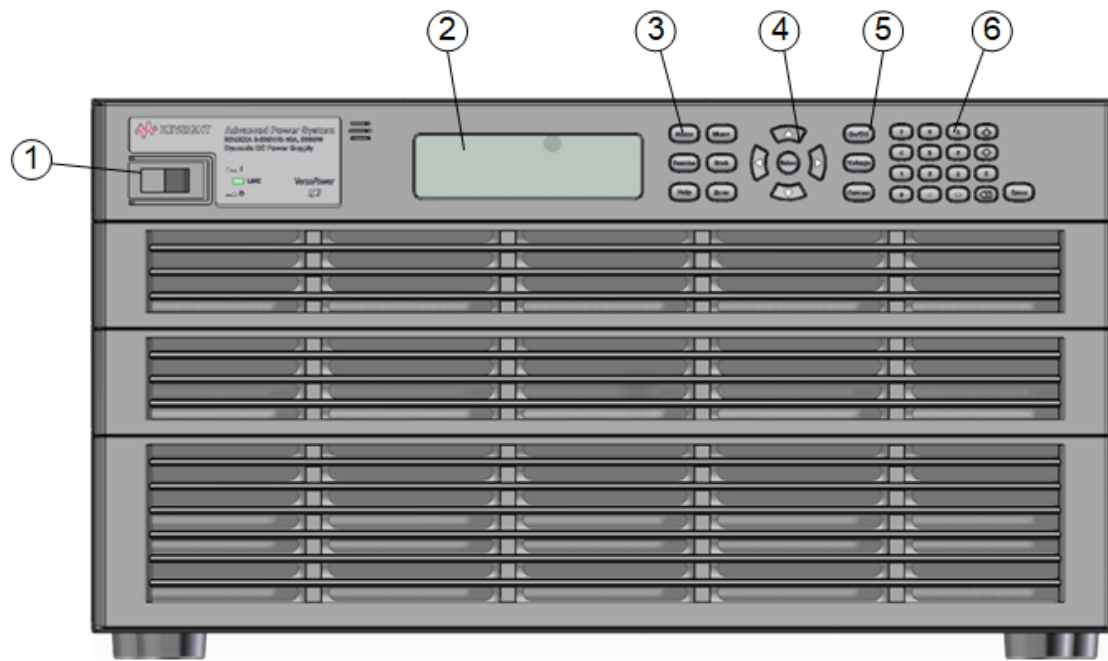

1. **On/Off switch and LED** - LED indicates power is on. Green indicates normal operation. Amber indicates display is in screen-saver mode.
2. **Display** - Turns off after 1 hour of inactivity. Press any key to restore the display.
3. **System keys** - Select metering function. Access front panel command, help, and error menus.
4. **Navigation keys** - Move the cursor to a menu item. Select the highlighted menu item.
5. **Output keys** - Turn the outputs on or off. Enter voltage or current.
6. **Numeric Entry keys** - Enter values. Arrow keys increment or decrement numeric settings.

## Rear Panel at a Glance

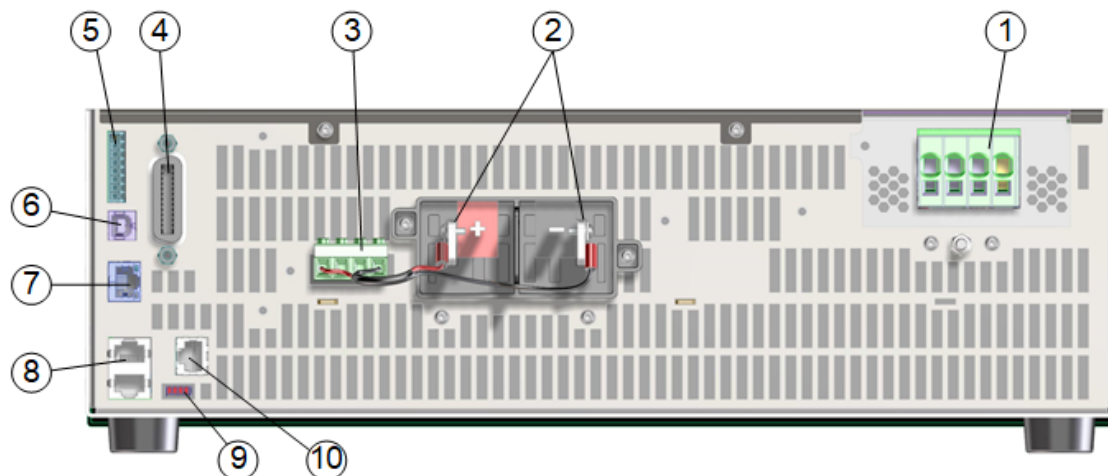

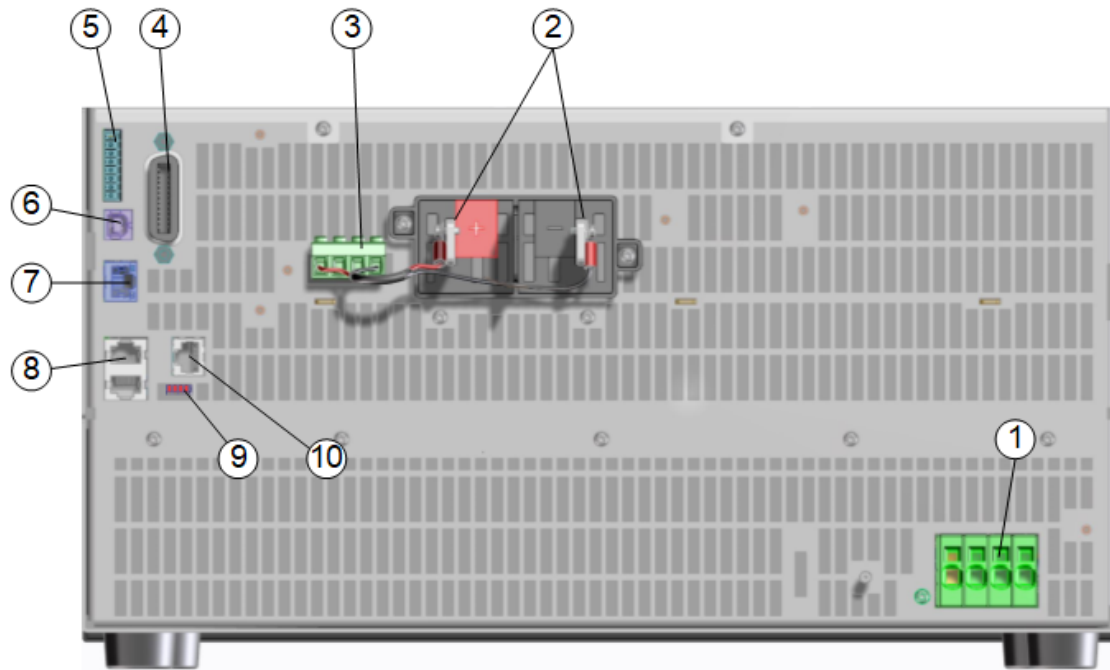

1. **AC input** - 3-phase ac input. Includes 3-phase L1, L2, L3, and Neutral connections. A chassis ground stud is located below the connector for ground connections. The ac input is bi-directional.
2. **DC outputs** - Positive and negative output terminals.
3. **Sensing** - Remote sense terminals - connected for local sensing.
4. **GPIB** - GPIB interface connector.
5. **Digital IO** - Digital IO connector. Pins are user-configurable.
6. **USB** - USB interface connector.
7. **LAN** - 10/100/1000 Base-T Left LED indicates activity. Right LED indicates link integrity.
8. **Primary/secondary** - Connectors for grouping paralleled units.
9. **Termination switches** - Specifies primary/secondary termination types.
10. **Safety disconnect** - Not available for use.

## Front Panel Display at a Glance

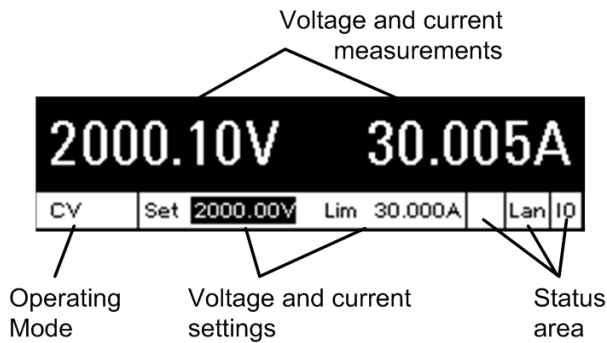

<b>Voltage and current measurements</b>	Displays the actual output voltage and current
<b>Operating mode</b>	<p>Indicates one of the following:</p> <ul style="list-style-type: none"> <li>OFF = the output is off</li> <li>CV = the output is in constant voltage mode</li> <li>CC = the output is in constant current mode</li> <li>Unr = the output is unregulated</li> <li>IPK+/- = the output is in positive or negative peak current limit</li> <li>VL+/- = the output is in positive or negative voltage limit mode</li> <li>CL+/- = the output is in positive or negative current limit mode</li> <li>T-on = the output is turning on</li> <li>T-off = the output is turning off</li> <li>OV+/- = the output is disabled by the positive or negative over-voltage protection</li> <li>OP+/- = the output is disabled by the positive or negative over-power limit</li> <li>OC = the output is disabled by the over-current protection</li> <li>OT = the output is disabled by the over-temperature protection</li> <li>PF = the output is disabled by a power-fail condition</li> <li>Inh = the output is disabled by an external inhibit signal</li> <li>Prot = the output is disabled by a protection condition on another unit</li> <li>EDP = the output is disabled by excessive output dynamics protection</li> <li>CSF = a current sharing fault has occurred</li> <li>PSP = a primary/secondary protection has occurred</li> <li>UV = the output is disabled by the under-voltage protection</li> <li>LOV+/- = the output voltage has exceeded a positive or negative internal limit</li> <li>DOV+/- = a DUT-applied voltage has exceeded the positive or negative voltage limit</li> <li>OCF+/- = the positive or negative internal current limits are exceeded - possibly due to a DUT-applied voltage that has exceeded the positive or negative voltage limit</li> </ul>
<b>Voltage and current settings</b>	Displays the programmed voltage and current. These settings may not match the actual output voltage or current. For example, in CV mode, the current limit may be set to 1 A, but the actual output current must be less than 1 A for the output to remain in CV mode. If the current limit is reached, the output will no longer be in CV mode, but will be in current limit. In this case, the actual output voltage will now be less than the voltage setting.
<b>Status area</b>	<p>Indicates the following remote interface activity:</p> <ul style="list-style-type: none"> <li>Err = an error has occurred (press Error key to display error message)</li> <li>Lan = the LAN is connected and has been configured</li> <li>IO = there is activity on one of the remote interfaces</li> </ul>



## Front Panel Keys at a Glance



The On/Off switch turns the unit on or off. The LED indicates power is on. **Green** indicates normal operation. **Yellow** indicates that the display is in screen saver mode. The LED is also yellow during the boot-up process. Press any key to exit screen saver mode.

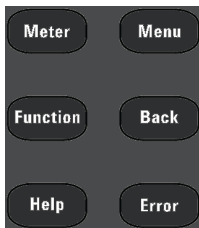

The System keys access the following front panel meter and command menus:  
 Meter returns the display to metering mode. Also toggles between current and power measurements.  
 Menu accesses the command menu.  
 Function key is reserved for future use.  
 Back backs out of a menu without activating any changes.  
 Help accesses information about the displayed menu control.  
 Error displays all error messages in the error queue. Displaying the errors clears the error queue.

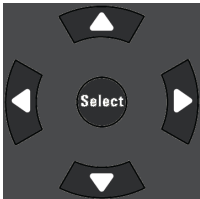

The Navigation keys do the following:  
 The Arrow keys move around in the command menus. They also select alpha characters in alpha-numeric entry fields.  
 The Select key lets you make a selection in the command menus. It also lets you enter edit mode for editing the numeric parameters.

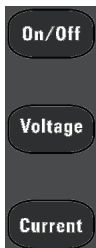

The Output keys do the following:  
 On/Off controls the output.  
 Voltage lets you change the voltage setting.  
 Current lets you change the current setting.



The Numeric entry keys do the following:  
 The 0 through 9 keys enter numbers.  
 The (.) key is the decimal point.  
 The - key is used to enter a minus sign.  
 The up/down arrow keys increment or decrement voltage or current settings. They also select letters in alphabetic entry fields.  
 The E key enters an exponent. Add the value to the right of the E.  
 The Backspace key deletes digits as it backspaces over them.  
 The Enter key enters a value. If you exit a field without pressing the Enter key, the value is ignored.

### NOTE

Press the Help key to get context sensitive help.

## Front Panel Menu Reference

Press the **Menu** key to access the front panel menus. For a brief tutorial, refer to [Using the front panel menu](#). If a menu item is grayed-out, it is not available for the mode that is being programmed.

Examples of modes that affect the menu items include Fixed, SAS, and Primary/Secondary functions.

1st Menu Level	2nd Level	3rd & 4th Levels	Description	
<b>Output</b>	Voltage		Programs output voltage or voltage limit	
	Current		Programs output current or current limit	
	Mode		Programs voltage or current priority mode and SAS operating mode	
	SAS	Curve	Shape	Specifies the curve shape: space or terrestrial
			Settings	Programs the SAS curve parameters: Imp, Isc, Vmp, and Voc
		Table	Activates one of the loaded tables	
		Scale	Selects a scale factor for the current and voltage curves	
		Bandwidth	Programs the SAS bandwidth	
		Sequence	Delay	Programs output on/off delay
			Couple	Configures output state coupling
	Advanced	Slew	Current	Programs output current slew rate
			Voltage	Programs output voltage slew rate
		Resistance	Programs output resistance	
		Bandwidth	Current	Programs current bandwidth
Voltage			Programs voltage bandwidth	
	Tmode	Programs output turn-on/turn-off modes		
<b>Measure</b>	Sweep		Configures measurement sampling	
	Window		Select measurement window	
	Control		Initiates, triggers, and aborts acquisitions; displays trig state	
	AhWh		Measures or resets amp-hours and watt hours	
<b>Transient</b>	Mode		Selects voltage and current transient modes	
	Step		Configures voltage or current steps and trigger signals	
	List	Pace	Specifies Dwell or Trigger paced list	
		Repeat	Specifies number of list repetitions, or continuous list	

1st Menu Level	2nd Level	3rd & 4th Levels	Description
		Terminate	Specifies list termination conditions
		Config	Configures individual list step settings
		Reset	Aborts the list and resets all list settings
	Arb	Repeat	Specifies number of Arb repetitions, or continuous Arb
		Terminate	Specifies Arb termination conditions
		Config	Configures individual Arb settings
	TrigSource		Specifies the transient and CD Arb trigger source
	Control		Initiates, triggers, and aborts transients; displays trig state
<b>Protect</b>	OVP		Configures over-voltage protection settings
	UVP		Configures under-voltage protection settings
	OCP		Configures over-current protection settings
	Inhibit		Configures inhibit input mode settings
	WDog		Configures output watchdog protections settings
	Clear		Clears protection conditions and displays output status
<b>States</b>	Reset		Resets all instrument settings to the reset (*RST) state
	SaveRecall		Saves and recalls instrument settings
	PowerOn		Selects the power-on instrument state
<b>System</b>	IO	LAN	Settings View the currently active network settings
		Modify	Modify the network configuration (IP, Name, DNS, mDNS, Services)
		Apply	Applies the configuration changes and restarts unit
		Cancel	Cancels the configuration changes
		Reset	Performs an LXI LCI reset of LAN settings and restarts
		Defaults	Resets the network to the as-shipped defaults and restarts
		USB	Displays USB identification string
		GPIB	Display or change the GPIB address
		DigPort	Pins Configures the individual digital port pins
		Data	Reads/writes data to the digital port
	Groups	Function	Specifies the primary/secondary function
		Primary	Discovers and connects the primary to the secondary units

## 1 Quick Reference

1st Menu Level	2nd Level	3rd & 4th Levels	Description
		Secondary	Specifies the secondary address
	Preferences	Clock	Sets the system clock
		Display	Configures the screen saver and start-up meter view
		Lock	Locks the front panel keys with a password
	Admin	Login	Enter a password to access the Admin functions
		Cal	Vprog Calibrates voltage programming
			Curr Calibrates current programming and measurement
			Misc Calibrates CurrTC
		Count	View the calibration count
		Date	Saves the calibration date
		Save	Saves the calibration data
		IO	Enables/disables USB, GPIB, and LAN services
		Sanitize	Performs NISPOM secure erase of all user data
		Update	Password protected firmware update
		Password	Changes the admin password
	About		Displays model, options, serial number, and firmware version

## Command Quick Reference

Some [optional] commands have been included for clarity. All settings commands have a corresponding query. See the [Syntax Conventions](#) for SCPI.

### ABORT

:ACQuire	Cancels any triggered measurements.
:ELOG	Stops external data logging.
:TRANsient	Cancels any transients or Arbs.

### CALibrate

:COUNT?	Returns the number of times the unit has been calibrated.
:CURRent	
[:LEVel] <value>	Calibrates the current programming and measurement.
:TC	Calibrates the temperature coefficient.
:DATA <value>	Enters the calibration value read by the external meter.
:DATE <"date">	Enters the calibration date in nonvolatile memory.
:LEVel P1 P2 P3	Advances to the next level in the calibration.
:PASSword <value>	Sets a numeric password to prevent unauthorized calibration.
:SAVE	Saves the calibration constants in non-volatile memory.
:STATe 0 OFF 1 ON	Enables or disables calibration mode.
:VOLTage	
[:LEVel] <value>	Calibrates the local voltage programming and measurement.

### DISPlay

[:WINDow]	
[:STATe] 0 OFF 1 ON	Turns the front panel display on or off.
:VIEW METER_VI METER_VP METER_VIP	Selects the parameters to display on the front panel.
:SAVer	
[:STATe] 0 OFF 1 ON	Turns the front panel screen saver on or off.

### FETCh

[:SCALar]	
:CURRent	
[:DC]? [<start_index>, <points>]	Returns the averaged measurement.
:ACDC?	Returns the rms measurement (ac + dc).
:HIGH?	Returns the High level of a pulse waveform.
:LOW?	Returns the Low level of a pulse waveform.
:MAXimum?	Returns the maximum value
:MINimum?	Returns the minimum value
:POWer	
[:DC]?	Returns the averaged measurement.
:MAXimum?	Returns the maximum value
:MINimum?	Returns the minimum value

## 1 Quick Reference

:VOLTage	
[:DC]? [<start_index>, <points>]	Returns the averaged measurement.
:ACDC?	Returns the rms measurement (ac + dc).
:HIGH?	Returns the High level of a pulse waveform.
:LOW?	Returns the Low level of a pulse waveform.
:MAXimum?	Returns the maximum value
:MINimum?	Returns the minimum value
:AHOur? [IGNORE_OVLD]	Returns the accumulated amp-hours.
:ARRAY	
:CURRent	
[:DC]? [<start_index>, <points>]	Returns the instantaneous measurement.
:POWer	
[:DC]? [<start_index>, <points>]	Returns the instantaneous measurement.
:VOLTage	
[:DC]? [<start_index>, <points>]	Returns the instantaneous measurement.
:ELOG <maxrecords>	Returns the most recent external datalog records.
:WHOur? [IGNORE_OVLD]	Returns the accumulated watt-hours.

### FORMat

[:DATA] ASCII   REAL	Specifies the format of the returned data.
:BORDER NORMAL   SWAPPed	Specifies how binary data is transferred.

### HCOPY

:SDUMp	
:DATA? [BMP GIF PNG]	Returns an image of the front panel display.
:DATA	
:FORMat BMP GIF PNG	Specifies the format for front panel images returned.

### IEEE-488 Common Commands

*CLS	Clear status command.
*ESE <value>	Event status enable command and query.
*ESR?	Event status event query.
*IDN?	Identification Query.
*OPC	Sets the OPC (operation complete) bit in the standard event register.
*OPC?	Returns a 1 to the output buffer when all pending operations complete.
*OPT?	Returns a string identifying any installed options.
*RCL <value>	Recalls a saved instrument state.
*RST	Resets the instrument to pre-defined values that are either typical or safe.
*SAV <value>	Saves the instrument state to one of ten non-volatile memory locations.
*SRE <value>	Service request enable command and query.
*STB?	Status byte query.
*TRG	Trigger command.
*TST?	Self-test query.
*WAI	Pauses additional command processing until all pending operations are complete.

**INITiate**

[:IMMediate]	
:ACQuire	Initiates the measurement trigger system.
:ELOG	Initiates external data logging.
:TRANsient	Initiates the transient trigger system.
:CONTinuous	
:TRANsient 0 OFF 1 ON	Continuously initiates the transient trigger system.

**INSTrument**

:GROup	
:FUNCTion PRIMary SECondary NONE	Sets the primary/secondary function
:PRIMary	
:CONNect	
[:STATe] 0 OFF 1 ON	Connects the primary to previously discovered secondary units
:DELay <delay>	Specifies an auto-connect delay after power-on
:MODE AUTO MANual	Automatic connect at power-on or by command
:DISCover	Discovers bus connected primary units
:RESet	Reset the primary configuration
:SECondary	
:ADDRes <bus address>	Sets the secondary bus address

**LXI**

:IDENtify	
[:STATe] 0 OFF 1 ON	Turns the front panel LXI identify indicator on or off.
:MDNS	
[:STATe] 0 OFF 1 ON	Sets the MDNS state

**MEASure**

[:SCALar]	
:CURRent	
[:DC]?	Takes a measurement; returns the averaged current.
:ACDC?	Takes a measurement; returns the rms current (ac + dc).
:HIGH?	Takes a measurement; returns the High level of a current pulse.
:LOW?	Takes a measurement; returns the Low level of a current pulse.
:MAXimum?	Takes a measurement; returns the maximum current.
:MINimum?	Takes a measurement; returns the minimum current.
:POWer	
[:DC]?	Takes a measurement; returns the averaged power.
:MAXimum?	Takes a measurement; returns the maximum power.
:MINimum?	Takes a measurement; returns the minimum power.
:VOLTage	
[:DC]?	Takes a measurement; returns the averaged voltage.
:ACDC?	Takes a measurement; returns the rms voltage (ac + dc).

## 1 Quick Reference

:HIGH?	Takes a measurement; returns the High level of a voltage pulse.
:LOW?	Takes a measurement; returns the Low level of a voltage pulse.
:MAXimum?	Takes a measurement; returns the maximum voltage.
:MINimum?	Takes a measurement; returns the minimum voltage.
:ARRAY	
:CURRent[:DC]?	Takes a measurement; returns the instantaneous current.
:POWer[:DC]?	Takes a measurement; returns the instantaneous power.
:VOLTage[:DC]?	Takes a measurement; returns the instantaneous voltage.

## OUTPut

[:STATe] 0 OFF 1 ON	Enables or disables the output.
:COUPlE	
[:STATe] 0 OFF 1 ON	Enables or disables output coupling.
:DOFFset <value>	Sets a delay offset to synchronize coupled output state changes.
:MAX	
:DOFFset?	Returns the delay offset required for this instrument.
:DELay	
:FALL <value>	Sets the output turn-off sequence delay.
:RISE <value>	Sets the output turn-on sequence delay.
:TMODE	
:COUPlE 0 OFF 1 ON	Couples the turn-on and turn-off settings.
[:OFF] LOWZ HIGHZ	Selects the output turn-off mode.
:ON LOWZ HIGHZ	Selects the output turn-on mode.
:INHibit	
:MODE LATChing LIVE OFF	Sets the operating mode of the remote inhibit digital pin.
:PON	
:STATe RST RCL0	Sets the output power-on state.
:PROTection	
:CLEar	Resets the latched protection.
:TEMPerature	
:MARGin?	Returns the margin remaining before the over-temperature trips.
:WDOG	
[:STATe] 0 OFF 1 ON	Enables or disables the I/O watchdog timer.
:DELay <value>	Sets the watchdog delay time.

## SENSe

:AHOuR	
:RESet	Resets the amp-hour or watt-hour measurement to zero.
:ELOG	
:FUNction	
:CURRent 0 OFF 1 ON	Enables/disables external current logging.
:MINMax 0 OFF 1 ON	Enables/disables external min/max current logging.
:VOLTage 0 OFF 1 ON	Enables/disables external voltage logging.
:MINMax 0 OFF 1 ON	Enables/disables external min/max voltage logging.



:PERiod <value>	Sets the external datalog integration time.
:FUNction	
:CURRent 0 OFF 1 ON	Enables/disables current measurements.
:VOLTage 0 OFF 1 ON	Enables/disables voltage measurements.
:SWEep	
:NPLCycles <value>	Sets the measurement time in number of power line cycles.
:OFFSet	
:POINTs <value>	Defines the offset in a data sweep for triggered measurements.
:POINTs <value>	Defines the number of points in a measurement.
:TINTerval <value>	Defines the time period between measurement samples.
:WHOUr	
:RESet	Resets the accumulated watt-hour measurement.
:WINDow	
[:TYPE] HANNing RECTangular	Selects the measurement window.

## [SOURce:]

**ARB**

:COUNT <value> INFinity	Specifies the number of times the Arb repeats.
:CURRent	
:CDWell	
[:LEVel] <value>{,<value>}<Block>	Specifies the level of each point in the Arb.
:DWELL <value>	Specifies the dwell time of each point in the Arb.
:POINTs?	Returns the number of points in the Arb.
:FUNction	
:TYPE CURRent VOLTage	Specifies either a voltage or current Arb.
:TERMinate	
:LAST 0 OFF 1 ON	Selects the output setting after the Arb ends.
:VOLTage	
:CDWell	
[:LEVel] <value>{,<value>}<Block>	Specifies the level of each point in the Arb.
:DWELL <value>	Specifies the dwell time of each point in the Arb.
:POINTs?	Returns the number of points in the Arb.

## [SOURce:]

**CURRent**

[:LEVel]	
[:IMMediate]	
[:AMPLitude] <value>	Sets the output current when in current priority mode.
:TRIGgered	
[:AMPLitude] <value>	Sets the triggered output current.
:BWIDth	
:LEVel 0, <value>	Sets the compensation frequency.
:LIMit	
[:POSitive]	

## 1 Quick Reference

<code>[:IMMEDIATE]</code>	
<code>[:AMPLITUDE] &lt;value&gt;</code>	Sets the current limit when in voltage priority mode.
<code>:NEGATIVE</code>	
<code>[:IMMEDIATE]</code>	
<code>[:AMPLITUDE] &lt;value&gt;</code>	Sets the current limit when in voltage priority mode.
<code>:MODE FIXED STEP LIST ARB</code>	Sets the transient mode.
<code>:PROTECTION</code>	
<code>:DELAY</code>	
<code>[:TIME] &lt;value&gt;</code>	Sets the over-current protection delay.
<code>:STARTSCHANGECCTRANS</code>	Specifies what starts the over-current protection delay timer.
<code>:STATE 0 OFF 1 ON</code>	Enables or disables the over-current protection.
<code>:SLEW</code>	
<code>[:IMMEDIATE] &lt;value&gt; INFINITY</code>	Sets the current slew rate.
<code>:MAXIMUM 0 OFF 1 ON</code>	Enables or disables the maximum slew rate override.

[SOURCE:]

### DIGITAL

<code>:INPUT</code>	
<code>:DATA?</code>	Reads the state of the digital control port.
<code>:OUTPUT</code>	
<code>:DATA &lt;value&gt;</code>	Sets the state of the digital control port.
<code>:PIN&lt;1-7&gt;</code>	
<code>:FUNCTION &lt;function&gt;</code>	Sets pin function. DIO DINPUT FAULT INHIBIT ONCOUPLE OFFCOUPLE TOUTPUT TINPUT
<code>:POLARITY POSITIVE NEGATIVE</code>	Sets the pin polarity.
<code>:TOUTPUT</code>	
<code>:BUS</code>	
<code>[:ENABLE] 0 OFF 1 ON</code>	Enables or disables BUS triggers on digital port pins.

[SOURCE:]

**FUNCTION** CURRENT|VOLTAGE Sets the output regulation - voltage priority or current priority.

[SOURCE:]

### LIST

<code>:COUNT &lt;value&gt; INFINITY</code>	Sets the list repeat count.
<code>:CURRENT</code>	
<code>[:LEVEL] &lt;value&gt;{,&lt;value&gt;}</code>	Specifies the setting for each list step.
<code>:POINTS?</code>	Returns the number of current points.
<code>:DWELL &lt;value&gt;{,&lt;value&gt;}</code>	Specifies the dwell time for each list step.
<code>:POINTS?</code>	Returns the number of dwell points.
<code>:STEP ONCE AUTO</code>	Specifies trigger or dwell pacing.
<code>:TERMINATE</code>	
<code>:LAST 0 OFF 1 ON</code>	Determines the output value when the list terminates.
<code>:TOUTPUT</code>	
<code>:BOSTEP</code>	

[:DATA] <Bool>{,<Bool>}	Generates a trigger out at the Beginning Of Step
:POINTs?	Returns the number of BOST points.
:EOSTep	
[:DATA] <Bool>{,<Bool>}	Generates a trigger out at the End Of Step
:POINTs?	Returns the number of EOST points.
:VOLTage	
[:LEVel] <value>{,<value>}	Specifies the setting for each list step.
:POINTs?	Returns the number of voltage points.

[SOURce:]

**POWer**

:LIMit?	Returns the output power limit of the instrument
---------	--------------------------------------------------

[SOURce:]

**SASimulator**

:ACTive	
:MPP	
:CURRent?	Returns the current at the maximum power point.
:POWer?	Returns the maximum power point.
:VOLTage?	Returns the voltage at the maximum power point.
:BWIDth	
:RANGe 0   1	Sets the SAS compensation.
:CURve	
:IMP <value>	Sets the current at the maximum power point of the curve.
:ISC <value>	Sets the short-circuit current.
:SHAPE SPACe TERRestrial	Sets the curve shape.
:VMP <value>	Sets the voltage at the maximum power point of the curve.
:VOC <value>	Sets the open-circuit voltage.
:MODE FIXed CURVe TABLe	Sets the operating mode of the instrument.
:SCALE	
:CURRent <value>	Sets a scale factor for the curve in both SAS and Table modes.
:VOLTage <value>	Sets a scale factor for the curve in both SAS and Table modes.
:TABLe	
:ACTivate 1 2	Loads and runs the table created using the MEMory commands.
:SElect 1 2	Runs one of two tables that have been loaded.
:UPDate 1 2	Updates a table.
:TABLe[1 2]	
:CURRent	
[:AMPLitude] <value>{,<value>}	Programs a list of current points in Table mode.
:POINTs?	Returns the number of current points in the current table.
:VOLTage	
[:AMPLitude] <value>{,<value>}	Programs a list of voltage points in Table mode.
:POINTs?	Returns the number of current points in the voltage table.

## 1 Quick Reference

[SOURce:]

### STEP

:TOUTput 0|OFF|1|ON Specifies whether a trigger out is generated when a transient step occurs.

[SOURce:]

### VOLTage

[:LEVel]

[:IMMediate]

[:AMPLitude] <value> Sets the output voltage when in voltage priority mode.

:TRIGgered

[:AMPLitude] <value> Sets the triggered output voltage.

:BWIDth

:LEVel 0 | 1 | 2, <value> Sets the compensation frequency.

:RANGe 0 | 1 | 2 Sets the voltage compensation range.

:LIMit

[:POSitive]

[:IMMediate]

[:AMPLitude] <value> Sets the voltage limit when in current priority mode.

:LOW <value> Sets the low-voltage limit.

:STATe 0|OFF|1|ON Enables or disables the low-voltage limit.

:MODE FIXed|STEP|LIST|ARB Sets the transient mode.

:PROTection

[:LEVel] <value> Sets the over-voltage protection level.

:LOW

[:LEVel] <value> Sets the low-voltage protection level.

:DELay <value> Sets the low-voltage protection delay.

:STATe 0|OFF|1|ON Enables or disables low-voltage protection.

:RESistance

[:LEVel]

[:IMMediate]

[:AMPLitude] <value> Sets the output resistance level.

:STATe 0|OFF|1|ON Enables or disables output resistance programming.

:SLEW

[:IMMediate] <value>|INFINITY Sets the voltage slew rate.

:MAXimum 0|OFF|1|ON Enables or disables the maximum slew rate override.

### STATus

:OPERation

[:EVENT]? Queries the operation event register.

:CONDition? Queries the operation condition register.

:ENABle <value> Sets the operation enable register.

:NTRansiton <value> Sets the Negative transition filter.

:PTRansiton <value> Sets the Positive transition filter.

:PRESet Presets all Enable, PTR, and NTR registers.

:QUEStionable<1 2>	
[:EVENT]?	Queries the questionable event register.
:CONDition?	Queries the questionable condition register.
:ENABle <value>	Sets the questionable enable register.
:NTRansiton <value>	Sets the Negative transition filter.
:PTRansiton <value>	Sets the Positive transition filter.

## SYSTem

:COMMunicate	
:LAN TCPIP:CONTRol?	Returns the initial socket control connection port number.
:RLState LOCal REMOte RWLock	Configures the remote/local state of the instrument.
:DATE <yyyy>, <mm>, <dd>	Sets the date of the system clock.
:ERRor?	Reads and clears one error from the error queue.
:PASSword	
:FPANel	
:RESet	Resets the front panel lockout password to zero.
:REBoot	Reboots the instrument to its power-on state.
:SECurity	
:IMMEDIATE	Clears all user memory and reboots the instrument.
:SET <block data>	Get and set the instrument state
:TIME <hh>, <mm>, <ss>	Sets the time of the system clock.
:VERSion?	Returns the SCPI version that the instrument complies with.

## TRIGger

:ACQuire	
[:IMMEDIATE]	Generates an immediate trigger.
:CURRent	
[:LEVel] <value>	Sets the triggered level of the output.
:SLOPe POSitive NEGative	Sets the slope of the signal.
:INDices	
[:DATA]?	Returns the indices where triggers were captured.
:COUNT?	Returns the number of triggers captured during the acquisition.
:SOURce <source>	Sets the acquire trigger source: BUS CURRent1 EXTErnal PIN<1-7> TRANSient1 VOLTage1
:TOUtput	
[:ENABle]	Enables measurement triggers to be sent to a digital port pin.
:VOLTage	
[:LEVel] <value>	Sets the triggered level of the output.
:SLOPe POSitive NEGative	Sets the slope of the signal.
:ARB	
:SOURce <source>	Selects the trigger source for arbitrary waveforms: BUS  EXTErnal  IMMEDIATE  PIN<1-7>
:ELOG	
[:IMMEDIATE]	Generates an immediate trigger.
:SOURce <source>	Selects the trigger source for external data logging: BUS  EXTErnal  IMMEDIATE  PIN<1-7>
:TRANsient	

## 1 Quick Reference

[:IMMEDIATE]

Generates an immediate trigger.

:SOURce <source>

Selects the transient trigger source: BUS |EXTernal |IMMEDIATE |PIN<1-7>

## Model Features and Options

### Model Features

Feature	RP7972A	RP7973A	RP7982A	RP7983A	RP7984A
Voltage, current, & power ratings	0 to 1000 V 0 to $\pm 60$ A $\pm 20$ kW	0 to 2000 V 0 to $\pm 30$ A $\pm 20$ kW	0 to 1000 V 0 to $\pm 90$ A <sup>1</sup> $\pm 30$ kW <sup>1</sup>	0 to 2000 V 0 to $\pm 30$ A <sup>1</sup> $\pm 30$ kW <sup>1</sup>	0 to 1500 V 0 to $\pm 60$ A <sup>1</sup> $\pm 30$ kW <sup>1</sup>
Photovoltaic operation	Yes	Yes	Yes	Yes	Yes
Output autoranging	Yes	Yes	Yes	Yes	Yes
3-phase, 380/480 Vac nominal	Yes	Yes	Yes	Yes	Yes
3-phase, 200/208 Vac nominal	No	No	Yes	Yes	Yes
Output lists	Yes	Yes	Yes	Yes	Yes
Arbitrary waveforms	Yes	Yes	Yes	Yes	Yes
Adjustable bandwidth	V, I, & PV	V, I, & PV	V, I, & PV	V, I, & PV	V, I, & PV
Primary/secondary mode	Yes	Yes	Yes	Yes	Yes
Voltage & current programming	Yes	Yes	Yes	Yes	Yes
Output resistance programming	Yes	Yes	Yes	Yes	Yes
Voltage & current measurements	Yes	Yes	Yes	Yes	Yes
Amp-hour, Watt-hour, & power measurement	Yes	Yes	Yes	Yes	Yes
Array readback	Yes	Yes	Yes	Yes	Yes
Adjustable sampling	Yes	Yes	Yes	Yes	Yes
External data logging	Yes	Yes	Yes	Yes	Yes
Under-voltage protection	Yes	Yes	Yes	Yes	Yes
Solid-state output disconnect	Yes	Yes	Yes	Yes	Yes

<sup>1</sup> 200/208 Vac input reduces the current and power rating 50%; 200/208 Vac input is only available with firmware rev B.06.03.1003 and up

### Options/Accessories

Option/Accessory	Description
Option UK6	Commercial calibration with test results data
Keysight 1CP108A	Rack mount kit with handles - for use with RP7972A, RP7973A
Keysight 1CP120A	Rack mount kit with handles - for use with RP7982A, RP7983A, RP7984A
Keysight RP7908A	Rack rails for Keysight racks or similar design
Keysight <b>DG9000</b>	Advanced/multi-input PV inverter test software for up to 12 instruments
Keysight <b>BV9200B/BV9201B</b>	Advanced sourcing and measurement functionality for a single, or up to four instruments

## Specifications and Characteristics

### Specifications

#### Supplemental Characteristics

#### Common Characteristics

#### AC Input Efficiency, Power Factor, and THD

#### Output Impedance Graphs

#### Inductive Load Boundary for Constant Current (CC) Operation

#### Capacitive Load Boundary for Constant Voltage (CV) Operation

#### Measurement Accuracy and Resolution

#### Excessive Dynamic Protection

#### Output Quadrants

## Specifications

Unless otherwise noted, specifications are warranted over the ambient temperature range of 0 to 40°C after a 30-minute warm-up. Specifications apply at the output terminals, with local sensing.

Specification	RP7972A	RP7973A	RP7982A	RP7983A	RP7984A
DC Ratings					
Voltage source:	0 to 1000 V	0 to 2000 V	0 to 1000 V	0 to 2000 V	0 to 1500 V
Current source and sink:	0 to ±60 A	0 to ±30 A	0 to ±90 A <sup>1</sup>	0 to ±30 A <sup>1</sup>	0 to ±60 A <sup>1</sup>
Power:	0 to ±20 kW	0 to ±20 kW	0 to ±30 kW <sup>1</sup>	0 to ±30 kW <sup>1</sup>	0 to ±30 kW <sup>1</sup>
Output ripple & noise					
CV peak-to-peak: <sup>2</sup>	1.5 V	3 V	1.5 V	3 V	2.25 V
CV rms: <sup>3</sup>	200 mV	400 mV	200 mV	400 mV	300 mV
Load regulation					
Voltage: <sup>4</sup>	50 mV	100 mV	50 mV	100 mV	75 mV
Current:	8 mA	4 mA	12 mA	4 mA	8 mA
Voltage programming & measurement accuracy: <sup>5</sup>	0.04% + 75 mV	0.04% + 150 mV	0.03% + 75 mV	0.03% + 150 mV	0.03% + 100 mV
Current programming & measurement accuracy: <sup>5</sup>	0.03% + 6 mA	0.03% + 3 mA	0.03% + 9 mA	0.03% + 3 mA	0.03% + 6 mA
Transient response <sup>6</sup>					
Recovery Time:	300 μs	300 μs	300 μs	300 μs	300 μs
Settling band:	10 V	20 V	10 V	20 V	15 V

<sup>1</sup> 200/208 Vac input reduces the current and power rating 50%; 200/208 Vac input is only available with firmware rev B.06.03.1003 and up

<sup>2</sup> From 20 Hz to 20 MHz (-3dB bandwidth) with resistive load, terminals ungrounded, or either terminal grounded

<sup>3</sup> From 20 Hz to 10 MHz (-3dB bandwidth) with resistive load, terminals ungrounded, or either terminal grounded

<sup>4</sup> Also applies when remote sensing with a ≤1 V drop per load lead - see [Wire Size](#) and [Remote Sense Connections](#) for additional information

<sup>5</sup> Percent of value + offset; at 25°C ±5°C after a 30 minute warm-up; measurement NPLC=1; valid for 1 year, see [Calibration Interval](#); with a ≤1 V drop per load lead - see [Wire Size](#) for information about additional load lead voltage drop

<sup>6</sup> Recovery to within settling band following a step from 40%-90% and 90%-40% of full load at Comp 0, with a 40μs current rise and fall time



## Supplemental Characteristics

Supplemental characteristics are not warranted but are descriptions of performance determined either by design or by type testing. Supplemental characteristics are typical unless otherwise noted.

Characteristic	RP7972A	RP7973A	RP7982A	RP7983A	RP7984A
Voltage programming					
Range:	+1V to +1020V	+2V to +2040V	+1V to +1020V	+2V to +2040V	+1.5 V to +1530V
Resolution:	10 mV	20 mV	10 mV	20 mV	15 mV
Current programming					
Range:	-61.2A to +61.2A	-30.6A to +30.6A	-91.8A to +91.8A <sup>1</sup>	-30.6A to +30.6A <sup>1</sup>	-61.2A to +61.2A <sup>1</sup>
Resolution:	1.2 mA	0.6 mA	1.8 mA	0.6 mA	1.2 mA
Resistance programming					
Range:	0 to 69 Ω	0 to 277 Ω	0 to 43.8 Ω	0 to 394 Ω	0 to 98.6 Ω
Resolution:	0.55 mΩ	2.2 mΩ	0.4 mΩ	3.2 mΩ	0.8 mΩ
Accuracy:	0.06% + 0.55 mΩ	0.06% + 2.2 mΩ	0.05% + 0.4 mΩ	0.05% + 3.2 mΩ	0.05% + 0.8 mΩ
Measurement range					
Voltage:	0 to 1200 V	0 to 2400 V	0 to 1200 V	0 to 2400 V	0 to 1800 V
Current:	-153 A to 153 A	-76.5 A to 76.5 A	-229.5 A to 229.5 A	-76.5 A to 76.5 A	-153 A to 153 A
Programming & measurement tempCo/°C <sup>2</sup>					
Voltage:	0.002%+7 mV	0.002%+14 mV	0.002%+7 mV	0.002%+14 mV	0.002%+7 mV
Current:	0.005%+240μA	0.005%+120μA	0.005%+360μA	0.005%+120μA	0.005%+240μA
Output ripple & noise (20 Hz to 20 MHz)					
CC rms:	30 mA	15 mA	30 mA	15 mA	30 mA
Common mode current					
rms:	2.5 mA	2.5 mA	2.5 mA	2.5 mA	2.5 mA
peak-to-peak:	30 mA	30 mA	30 mA	30 mA	30 mA
Overvoltage protection					
Maximum setting:	1200 V	2400 V	1200 V	2400 V	1800 V
Accuracy:	0.04% + 75 mV	0.04% + 150 mV	0.03% + 75 mV	0.03% + 150 mV	0.02% + 150 mV
Response time: <sup>3</sup>	< 30 μs	< 30 μs	< 30 μs	< 30 μs	< 30 μs
Voltage up/down programming, comp 0 4					
0.2 ms	0.2 ms	0.2 ms	0.2 ms	0.2 ms	0.2 ms
Rise/fall time 10% to 90% of step:	1 ms	1 ms	1 ms	1 ms	1 ms
Settling time to 0.1% of step:					
Voltage up/down programming, comp 1 4					
0.5 ms	0.5 ms	0.5 ms	0.5 ms	0.5 ms	0.5 ms
Rise/fall time 10% to 90% of step:	2.5 ms	2.5 ms	2.5 ms	2.5 ms	2.5 ms
Settling time to 0.1% of step:					
Voltage up/down programming, comp 2 4					
33 ms	33 ms	33 ms	33 ms	33 ms	33 ms
Rise/fall time 10% to 90% of step:	110 ms	110 ms	110 ms	110 ms	110 ms
Settling time to 0.1% of step:					
Current up/down programming, comp 0 5					
100 μs	100 μs	100 μs	100 μs	100 μs	100 μs
Rise/fall time 10% to 90% of step:	200 μs	200 μs	200 μs	200 μs	200 μs
Settling time to 1% of step:					

## 1 Quick Reference

Characteristic	RP7972A	RP7973A	RP7982A	RP7983A	RP7984A
Output on delay time <sup>6</sup>					
Voltage priority - high impedance:	8.1 ms	8.1 ms	8.1 ms	8.1 ms	8.1 ms
Voltage priority - low impedance:	8.1 ms	8.1 ms	8.1 ms	8.1 ms	8.1 ms
Current priority:	7.1 ms	7.1 ms	7.1 ms	7.1 ms	7.1 ms
Maximum load inductance: <sup>7</sup>	185 $\mu$ H	740 $\mu$ H	80 $\mu$ H	490 $\mu$ H	490 $\mu$ H
Line regulation					
Voltage and current:	See Note <sup>8</sup>	See Note <sup>8</sup>	See Note <sup>8</sup>	See Note <sup>8</sup>	See Note <sup>8</sup>
Typical leakage current					
Output disabled, or unplugged from ac mains:	0.75 mA	0.75 mA	0.4 mA	0.4 mA	1 mA
Bleed resistor					
+/- Terminals to chassis ground:	68 M $\Omega$	68 M $\Omega$	68 M $\Omega$	68 M $\Omega$	68 M $\Omega$

<sup>1</sup> 200/208 Vac input reduces the current and power rating 50%; 200/208 Vac input is only available with firmware rev B.06.03.1003 and up

<sup>2</sup> Applies for ambient temperatures above 30°C or below 20°C

<sup>3</sup> From occurrence of over-voltage to start of shutdown

<sup>4</sup> With no load and a step change from 0.1% to 100% of voltage rating; bandwidth frequency = 100 kHz

<sup>5</sup> With ac short and a step >10% of output voltage rating; bandwidth frequency = 100 kHz

<sup>6</sup> Time from when the Output On command is received to the initiation of turning the output on

<sup>7</sup> **CAUTION** Unit is susceptible to internal damage if Maximum Load Inductance limits are exceeded at the rated current

<sup>8</sup> Due to the pre-regulation circuits in the unit, the line regulation is not measurable

## Common Characteristics

Common Characteristic	All Models
Command Processing Time	$\leq 1$ ms from receipt of command to start of output change. Applies to simple settings commands over the GPIB interface (see <b>Typical Command Processing Times</b> )
Constant Dwell ARBs	
Number of points:	Up to 65,535
Dwell range:	One dwell setting applies for the entire ARB, from 10.24 $\mu$ s to 0.30 seconds
Dwell resolution:	Values are rounded to the nearest 10.24-microsecond increment
Computer Interfaces	
LXI version:	1.5 LXI Device Specification 2016
LXI extended functions:	LXI IPv6, LXI HiSLIP, LXI VXI VXI-11 Discovery and Identification
LAN:	10 Mb, 100 Mb, 1 Gb LAN
USB:	USB 2.0 (USB-TMC488 protocol)
GPIB:	SCPI - 1993, IEEE 488.2 compliant interface

Common Characteristic	All Models
<b>Digital Port</b>	
Max voltage rating:	+16.5 Vdc/- 5 Vdc between pins
Pins 1 & 2 as FLT:	Maximum low-level output voltage = 0.5 V @ 4 mA Maximum low-level sink current = 4 mA Typical high-level leakage current = 1 mA @ 16.5 Vdc
Pins 1-7 as outputs:	Maximum low-level output voltage = 0.5 V @ 4 mA; 1 V @ 50 mA; 1.75 V @ 100 mA Maximum low-level sink current = 100 mA Typical high-level leakage current = 0.8 mA @ 16.5 Vdc
Pins 1-7 as inputs:	Maximum low-level input voltage = 0.8 V Minimum high-level input voltage = 2 V Typical low-level current = 2 mA @ 0 V (internal 2.2k pull-up) Typical high-level leakage current = 0.12 mA @ 16.5 Vdc
Pin 8:	Pin 8 is common (internally connected to chassis ground)
<b>Acoustic statement (European Machinery Directive)</b>	
	Acoustic noise emission LpA 80.92 dB at Operator position: <sup>1</sup> LpA 75.57 dB at Bystander position LpA 62.04 at Idle fan speed Normal operation mode per ISO 7779
<b>Environmental</b>	
Operating environment:	Indoor use, installation category III, pollution degree 2
Temperature range:	0°C to 55°C (Maximum continuous current available is derated at 1% of rating per degree C from 40°C to 55°C)
Relative humidity:	95% or less (non-condensing)
Altitude:	Up to 2000 meters
Storage temperature:	-30°C to 70°C
<b>Regulatory Compliance</b>	
EMC:	Complies with European EMC Directive for test and measurement products Complies with Australian standard and carries C-Tick mark This ISM device complies with Canadian ICES-001 Cet appareil ISM est conforme à la norme NMB-001 du Canada
Safety:	Complies with European Low Voltage Directive and carries the CE mark. Conforms to US and Canadian safety regulations.  Declarations of Conformity for this product may be downloaded from the Web. Go to <a href="http://www.keysight.com/go/conformity">http://www.keysight.com/go/conformity</a> and click on "Declarations of Conformity."
<b>AC Input</b>	
Connections:	L1, L2, L3, N, PE (Wye-type ac mains wiring with a neutral connection) L1, L2, L3, PE (Wye-type ac mains wiring (no neutral) after firmware rev B.06.03.985)
Phase and range:	3-phase; 380-480 Vac nominal, line-to-line ±10% 3-phase; 200-208 Vac nominal, line-to-line ±10% (RP798xA after firmware rev B.06.03.1003)
Frequency:	50/60 Hz
Input VA:	23 kVA for 20 kW models, 34 kVA for 30 kW models <sup>2</sup>
Input current per phase:	36 A for 20 kW models, 52 A for 30 kW models <sup>2</sup>
Efficiency at full power:	90%
Power Factor:	0.99 @ nominal input and rated power

## 1 Quick Reference

Common Characteristic	All Models
Output Terminal Isolation for 1 kV units: for 1.5 kV and 2 kV units:	No output terminal may be more than $\pm 1000$ Vdc from any other terminal or chassis ground No output terminal may be more than $\pm 2000$ Vdc from any other terminal or chassis ground
Typical Weight	82 lbs. (37.3 kg) for 20 kW models 126 lbs. (57.2 kg) for 30 kW models
Dimensions	See <a href="#">Outline Diagrams</a> for details

<sup>1</sup> A sound pressure level of 80 dBA above a reference sound pressure of 20  $\mu$ Pa is at present regarded by man authorities as the threshold at which a hazard may be caused. Special means, such as the use of protective earpieces, can make a higher level non-hazardous to an operator.

<sup>2</sup> Applies at 380-480 Vac nominal

## AC Input Efficiency, Power Factor, and THD

The following graphs provide additional details about ac input efficiency, power factor, and total harmonic distortion over the entire power range of the instrument.

For 20 kW Models RP7972A, RP7973A

Source/Sink Efficiency

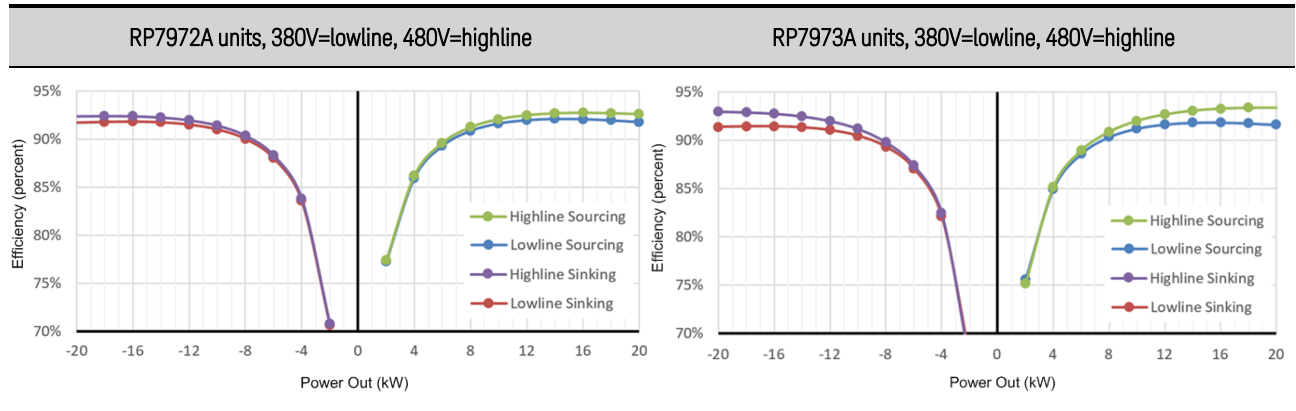

Power Factor

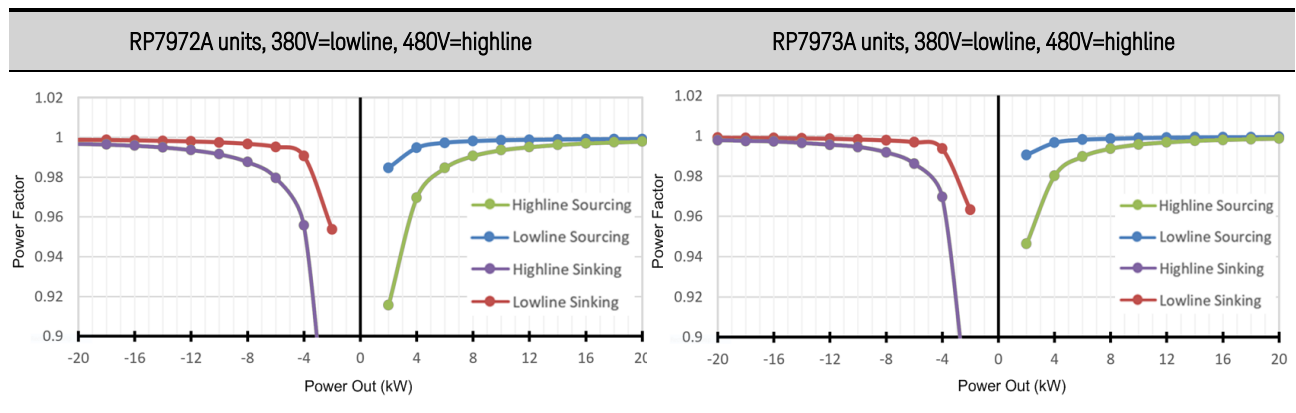

Total Harmonic Distortion

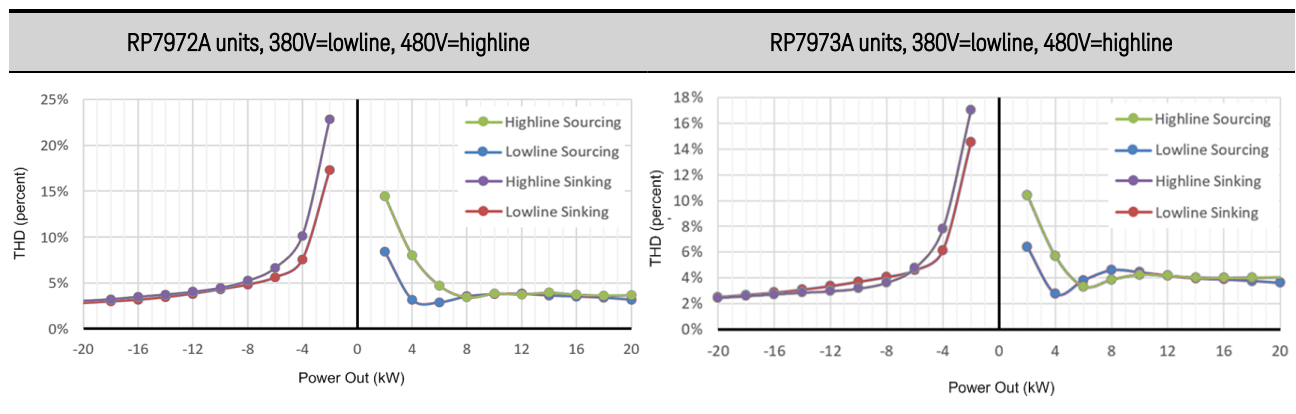

# 1 Quick Reference

## For 30 kW Model RP7982A

### Source/Sink Efficiency

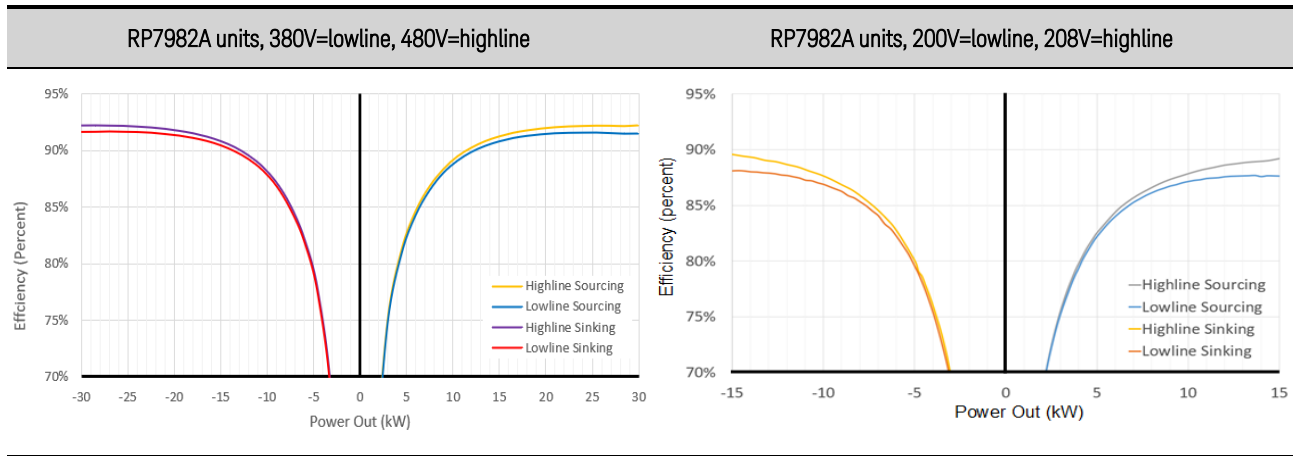

### Power Factor

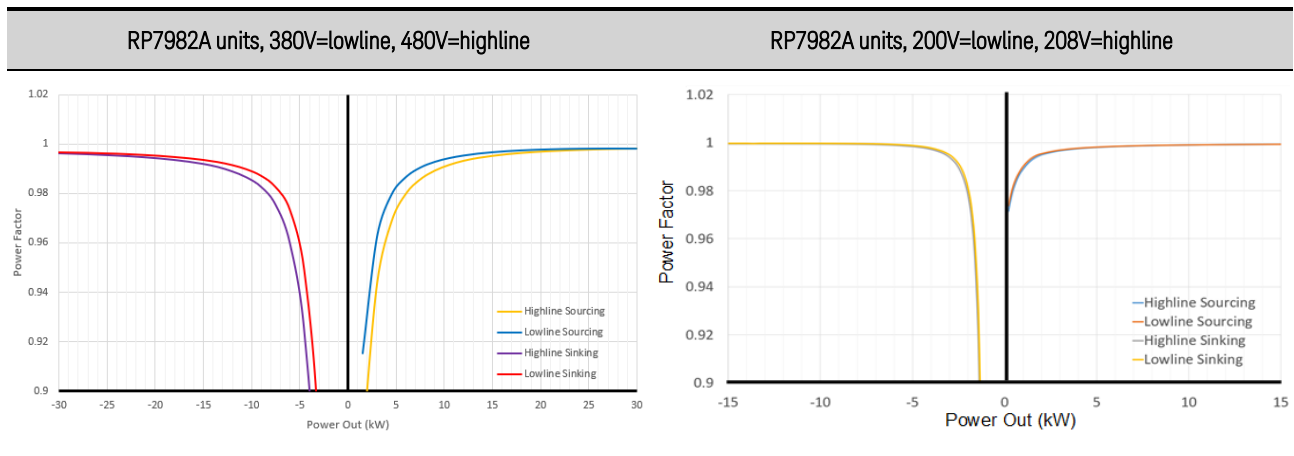

### Total Harmonic Distortion

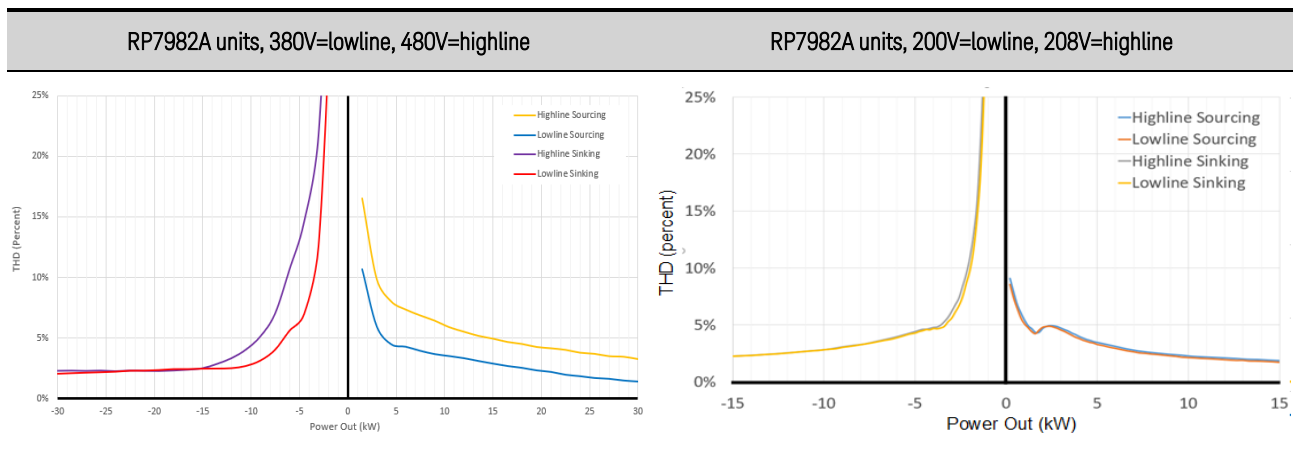

For 30 kW Model RP7983A

Source/Sink Efficiency

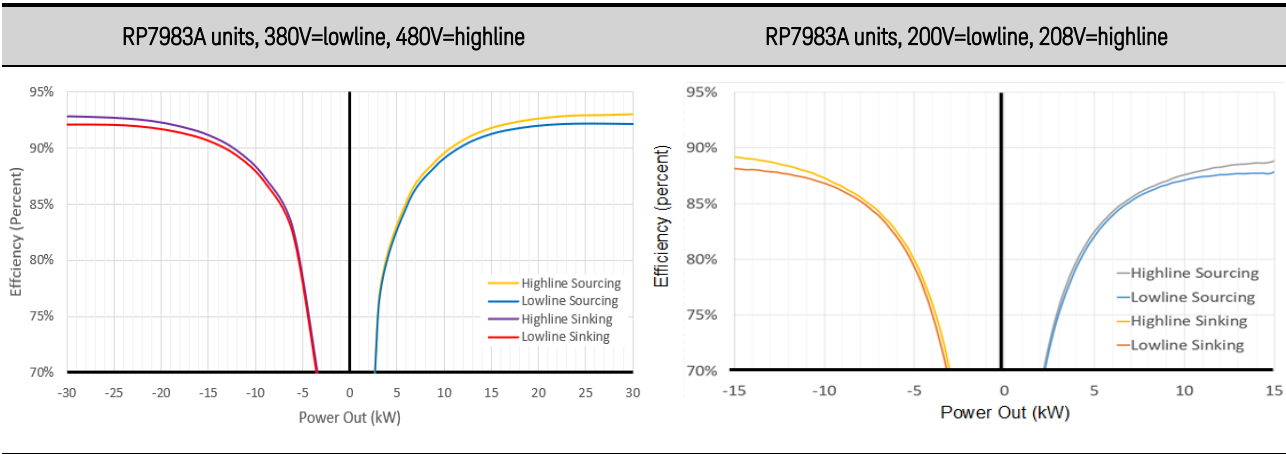

Power Factor

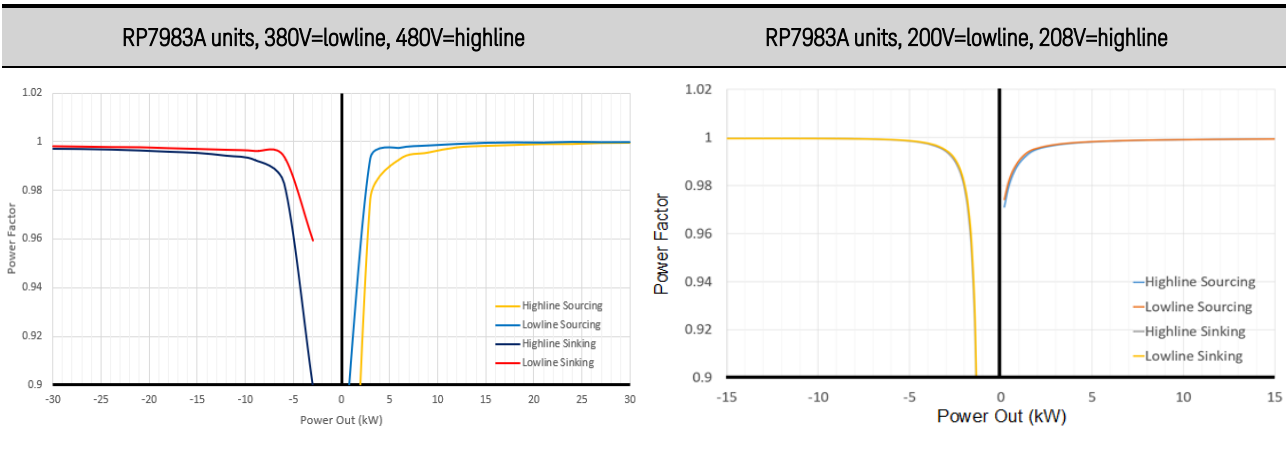

Total Harmonic Distortion

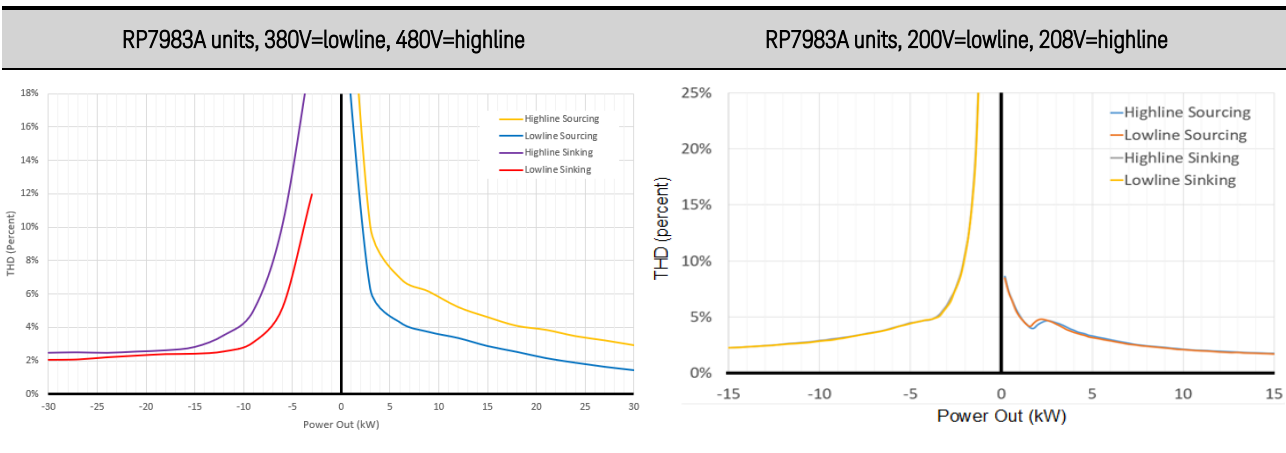

# 1 Quick Reference

## For 30 kW Model RP7984A

### Source/Sink Efficiency

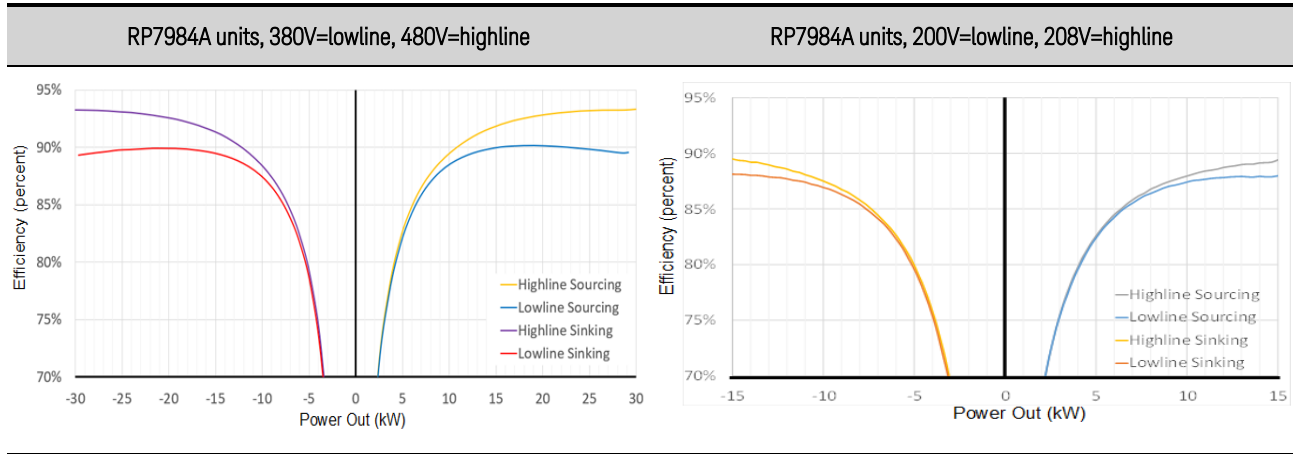

### Power Factor

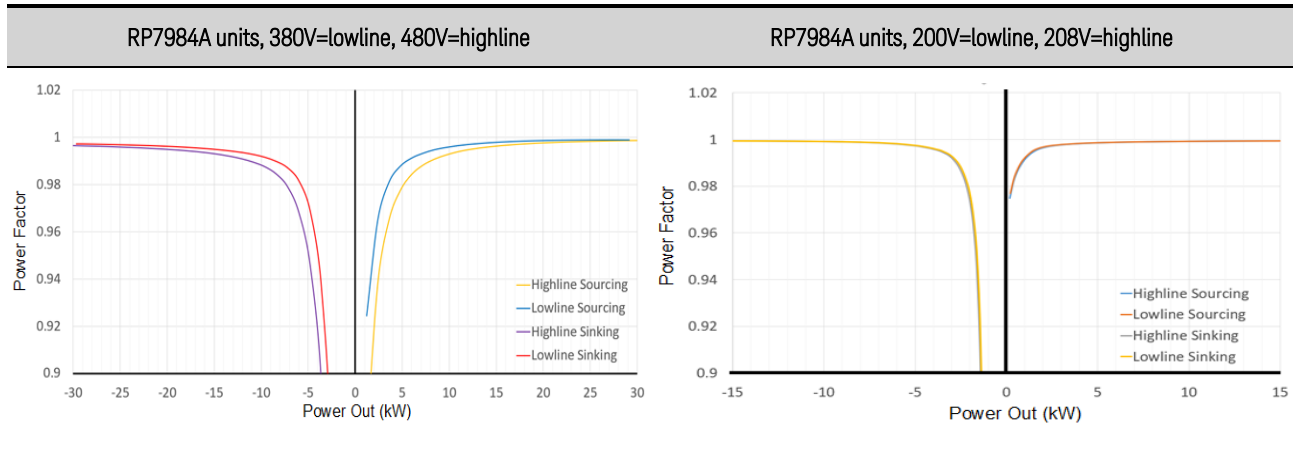

### Total Harmonic Distortion

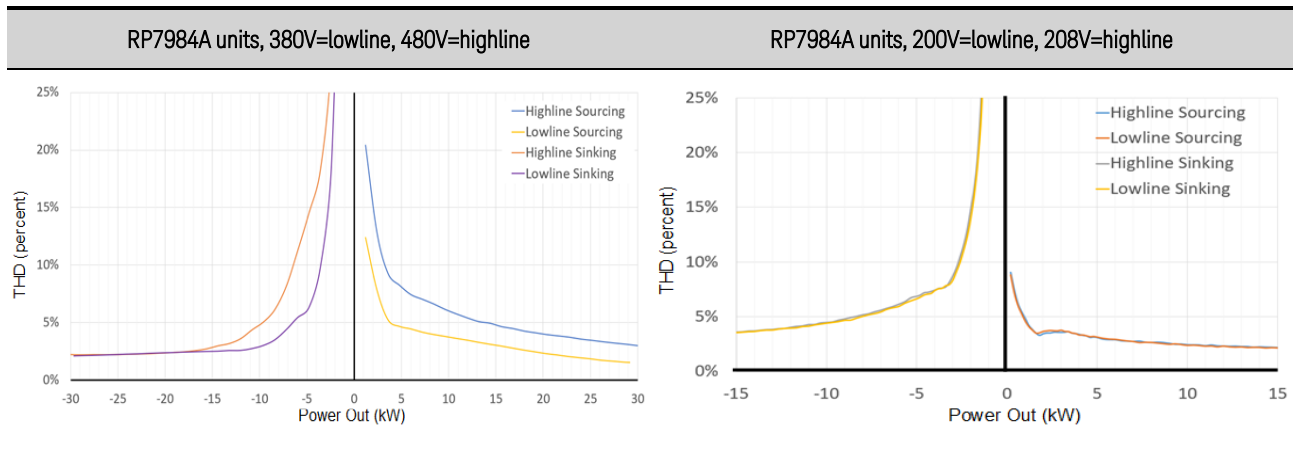



## Output Impedance Graphs

The following graphs show the small signal output impedance of the compensation modes for constant voltage (CV) and constant current (CC) operation.

For 20 kW Models RP7972A, RP7973A

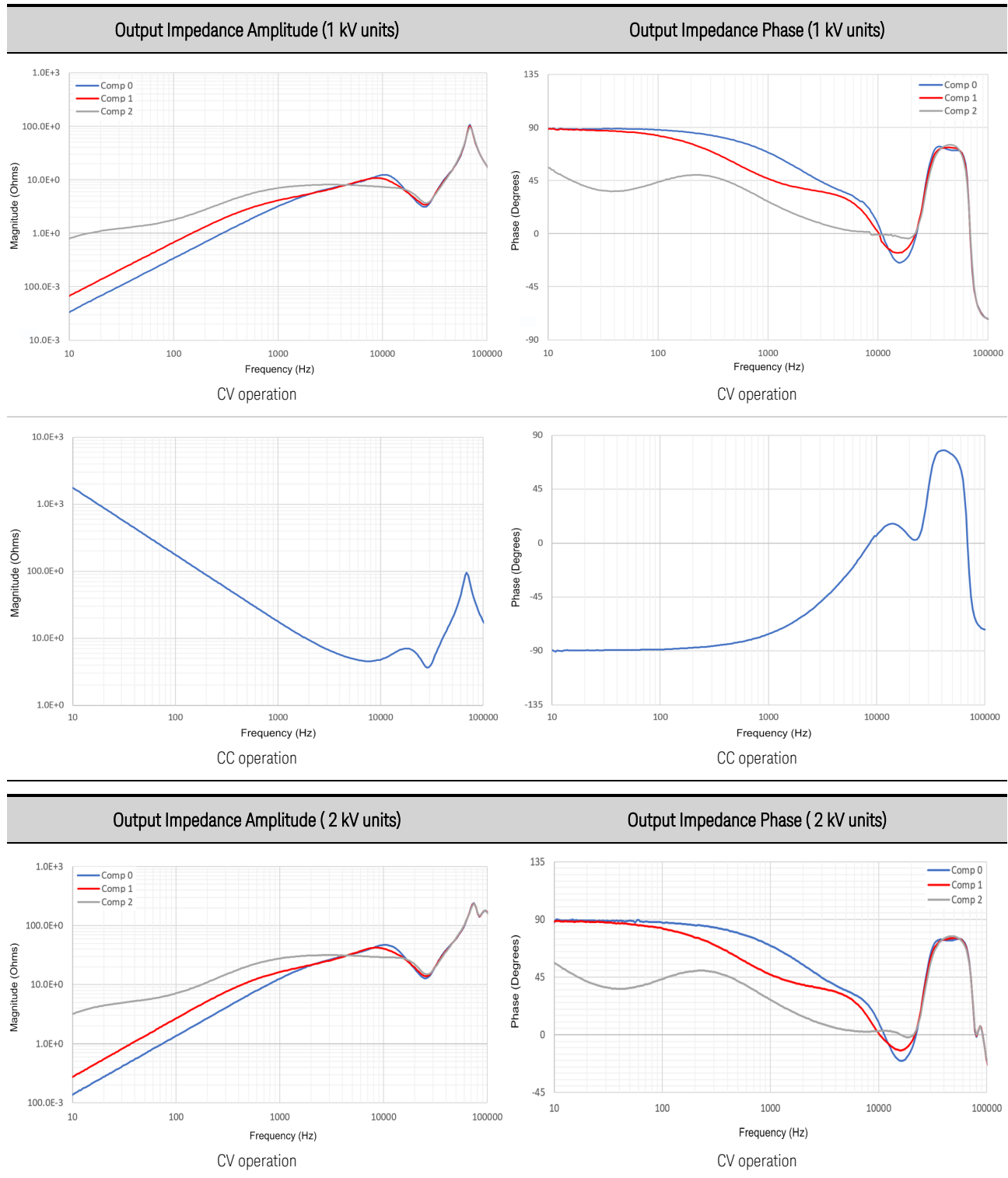

# 1 Quick Reference

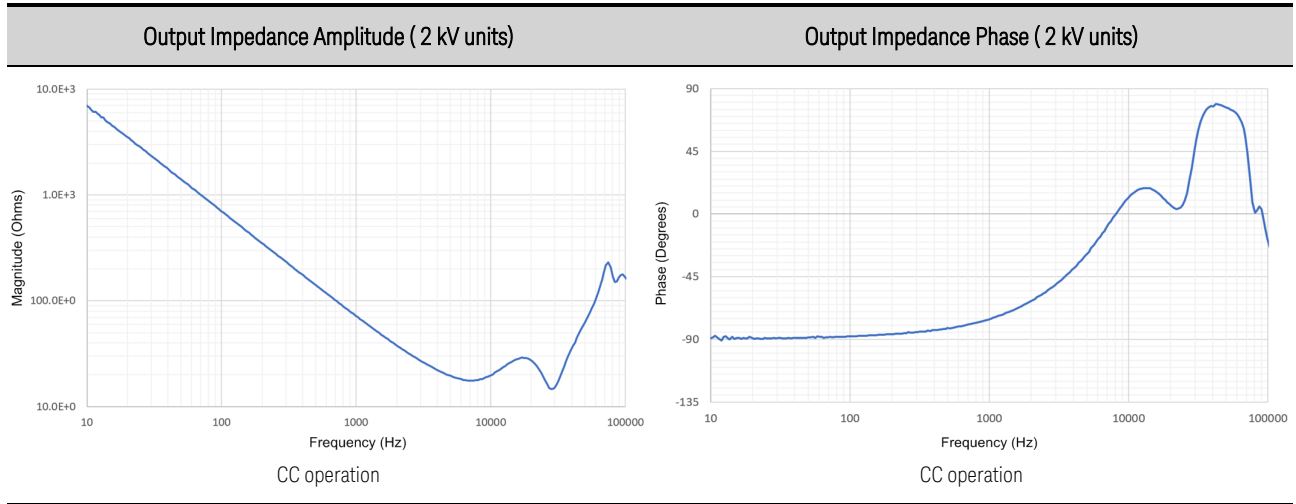

For 30 kW Models RP7982A, RP7983A, RP7984A

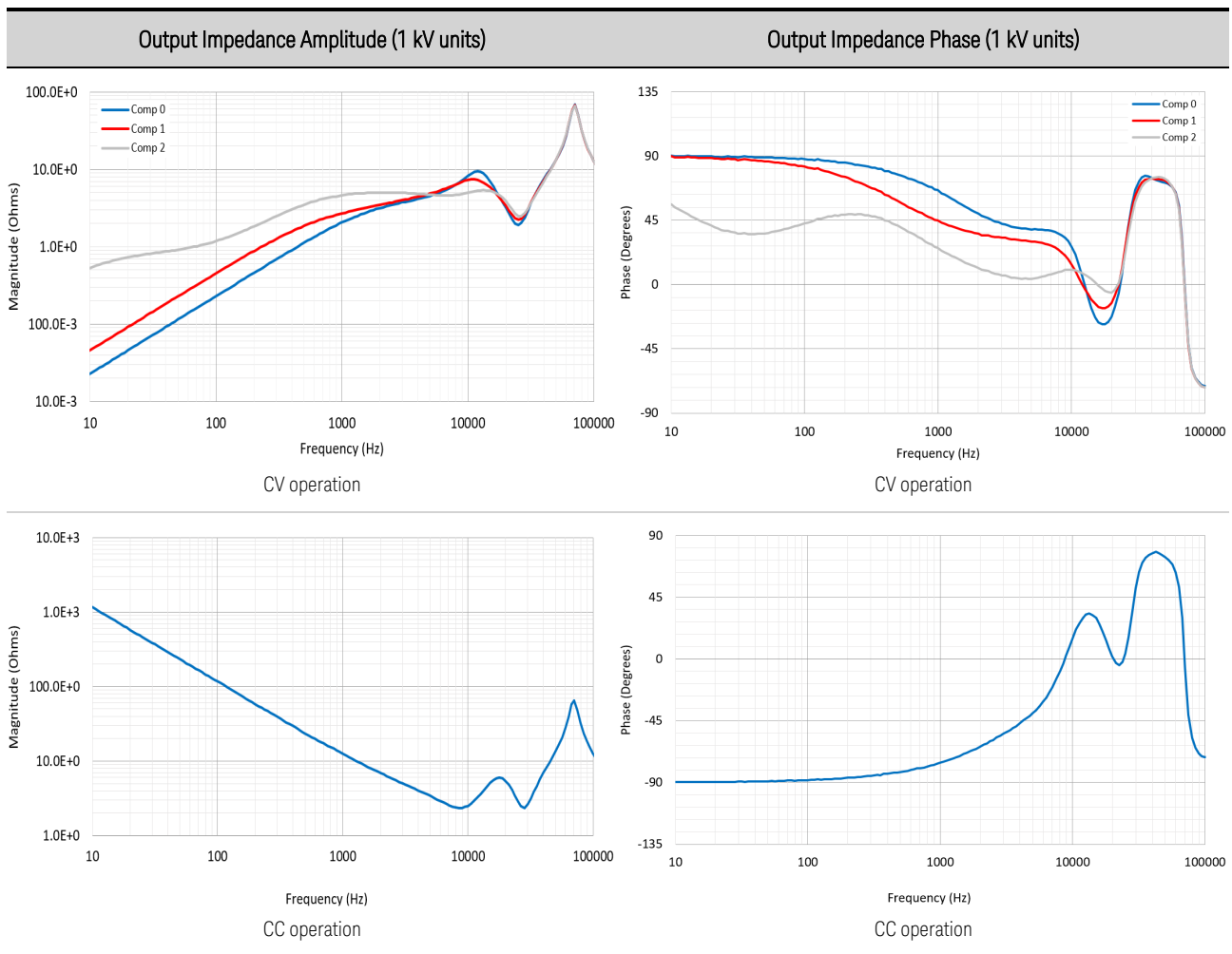

**Output Impedance Amplitude (2 kV units)      Output Impedance Phase (2 kV units)**

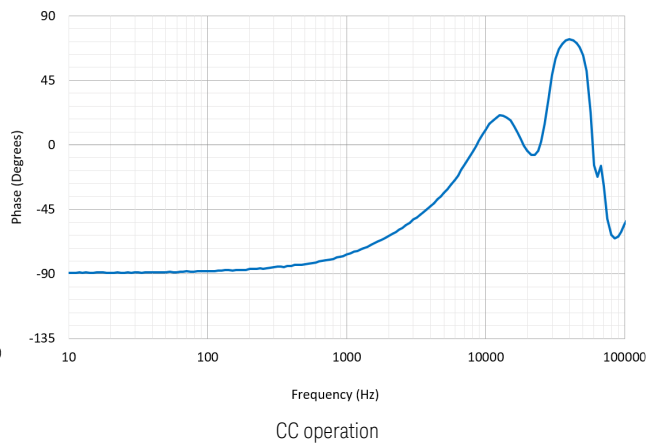
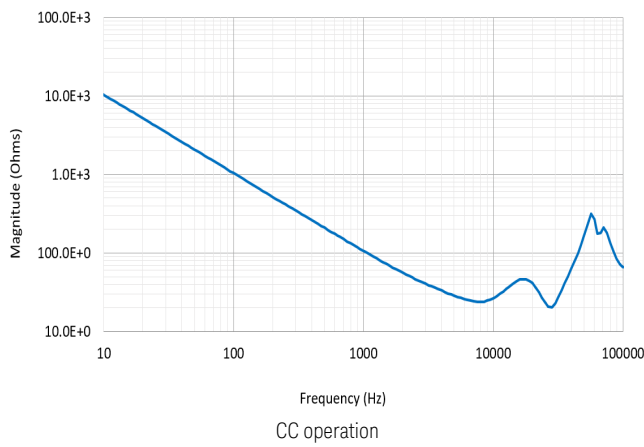
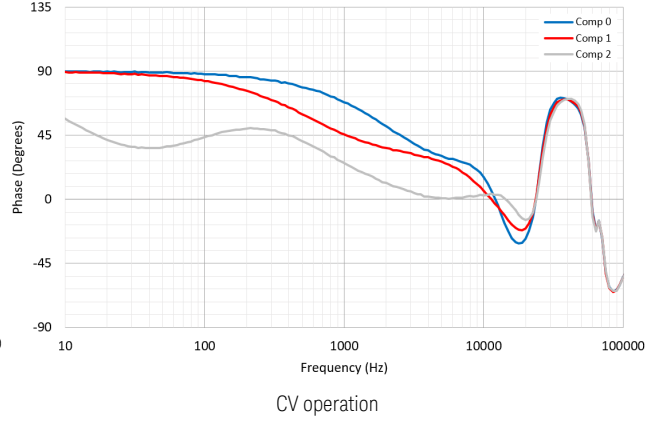
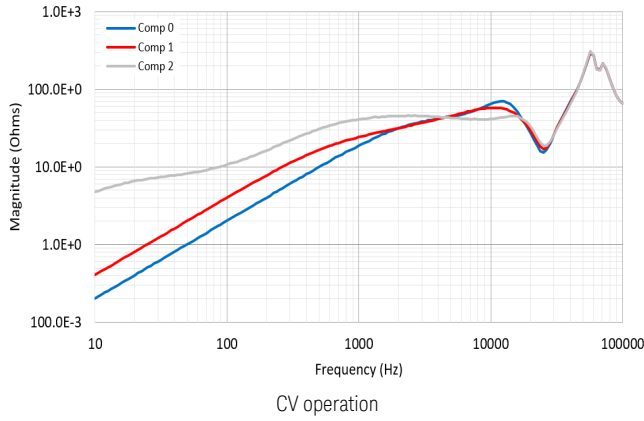

**Output Impedance Amplitude (1.5 kV units)      Output Impedance Phase (1.5 kV units)**

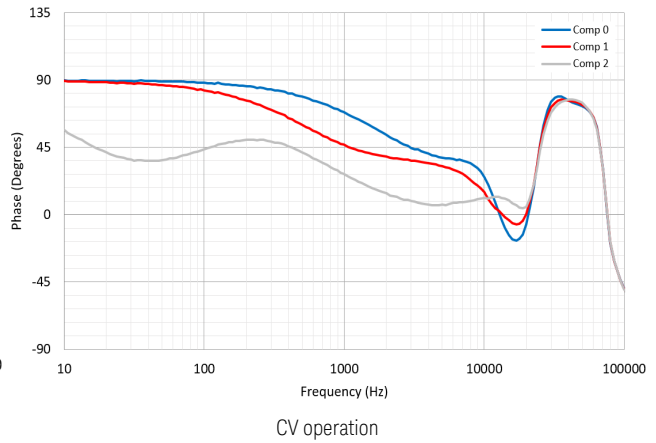
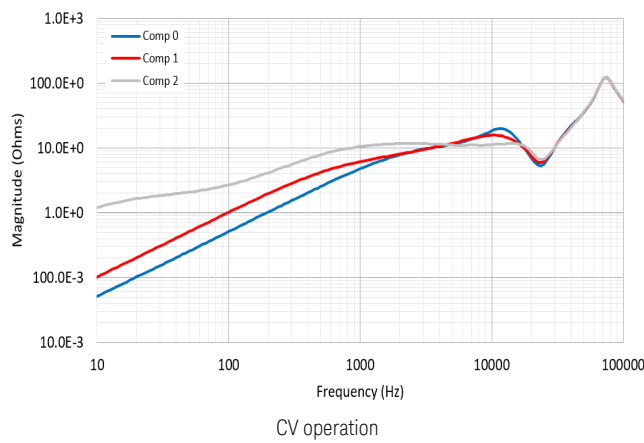

# 1 Quick Reference

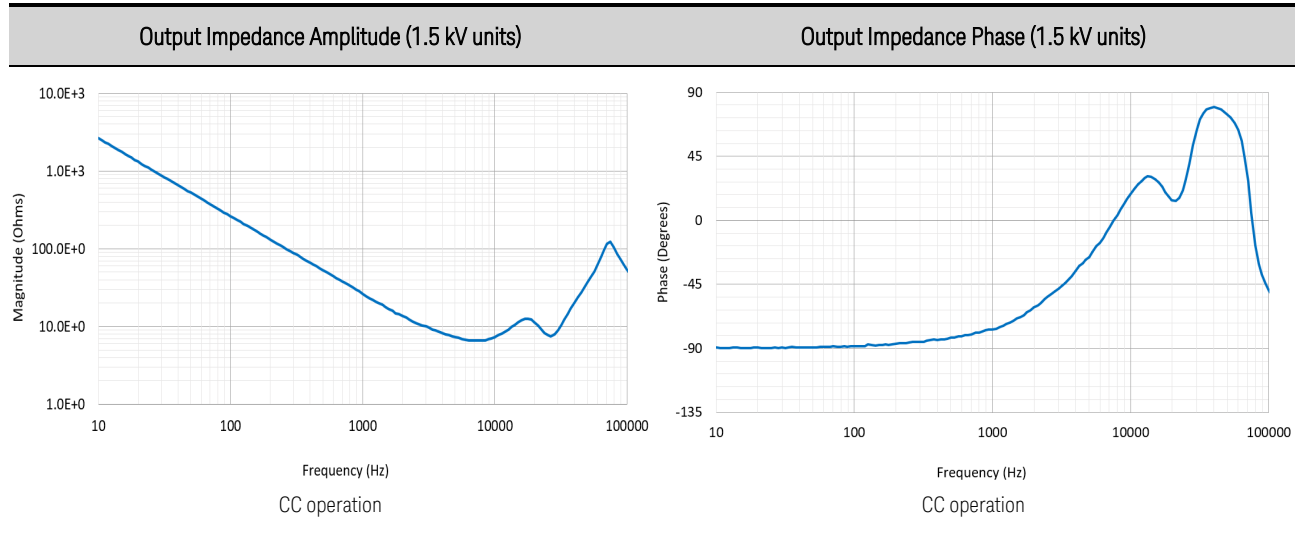

## Inductive Load Boundary for Constant Current (CC) Operation

The following figures show the boundary limitations for inductive loads with equivalent series resistance (ESR) for constant current operation. Operation below the red marginal stability lines may result in output instability. Note that lead and DUT resistance and inductance are indistinguishable in this context. It is also important to consider the voltage drop and power dissipation in the leads from increased lead resistance. Refer to [Inductance Considerations](#) for details.

### CAUTION

**EQUIPMENT DAMAGE** The power supply's internal voltage clamps are susceptible to thermal damage when the output is abruptly turned off at full load current if the lead inductance exceeds the model-dependent **Maximum Load Inductance** characteristic.

For 20 kW Models RP7972A, RP7973A

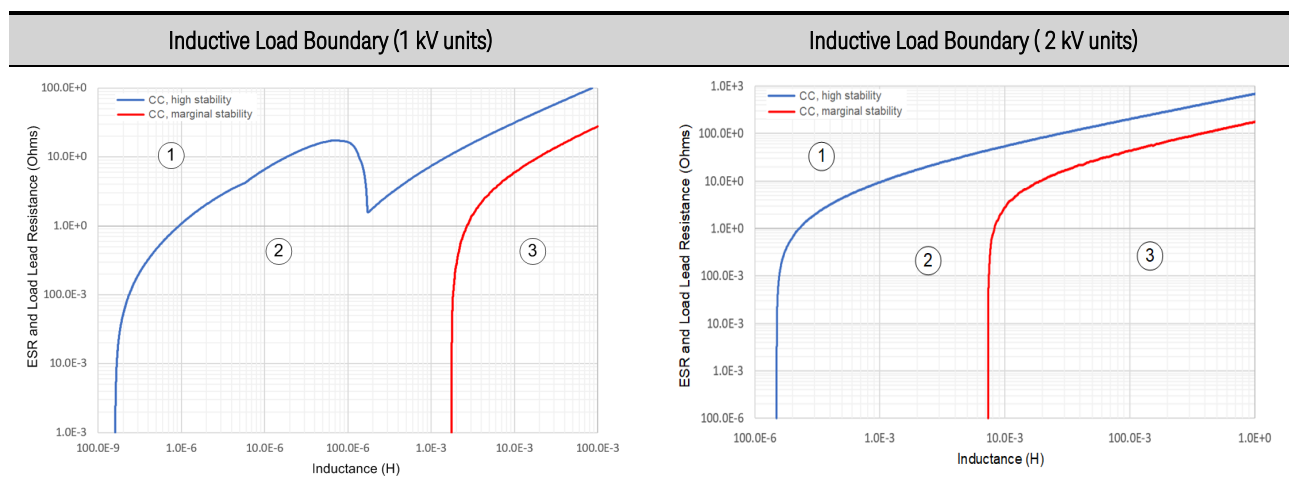

For 30 kW Models RP7982A, RP7983A, RP7984A

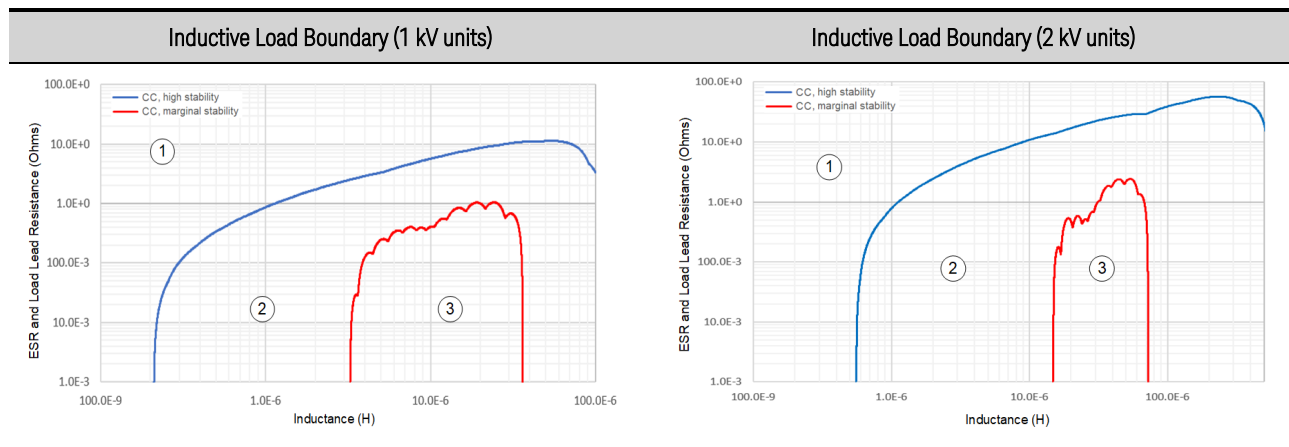

1. The output is stable in this region
2. The output may overshoot in this region
3. The output may be unstable in this region

## 1 Quick Reference

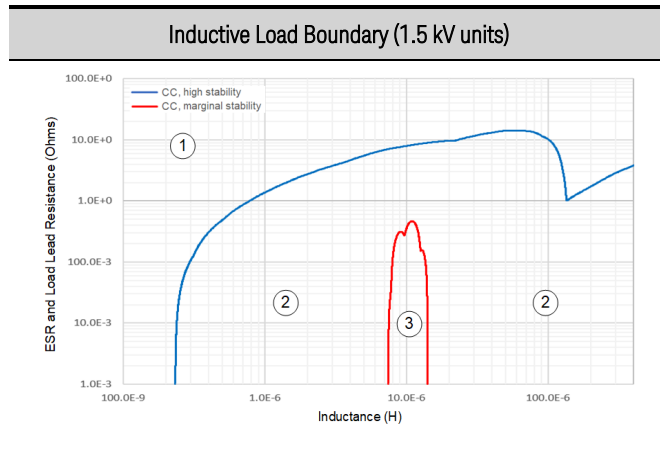

1. The output is stable in this region
2. The output may overshoot in this region
3. The output may be unstable in this region

## Capacitive Load Boundary for Constant Voltage (CV) Operation

The following figures show the boundary limitations for capacitive loads with equivalent series resistance (ESR) for constant voltage operation. Operation below the red marginal stability lines with the **Compensation** bandwidth settings may result in output instability. There are no absolute limits for DUT capacitance, as the stability is also a function of ESR. Refer to **Load Capacitance and Lead Inductance Considerations** for details.

For 20 kW Models RP7972A, RP7973A

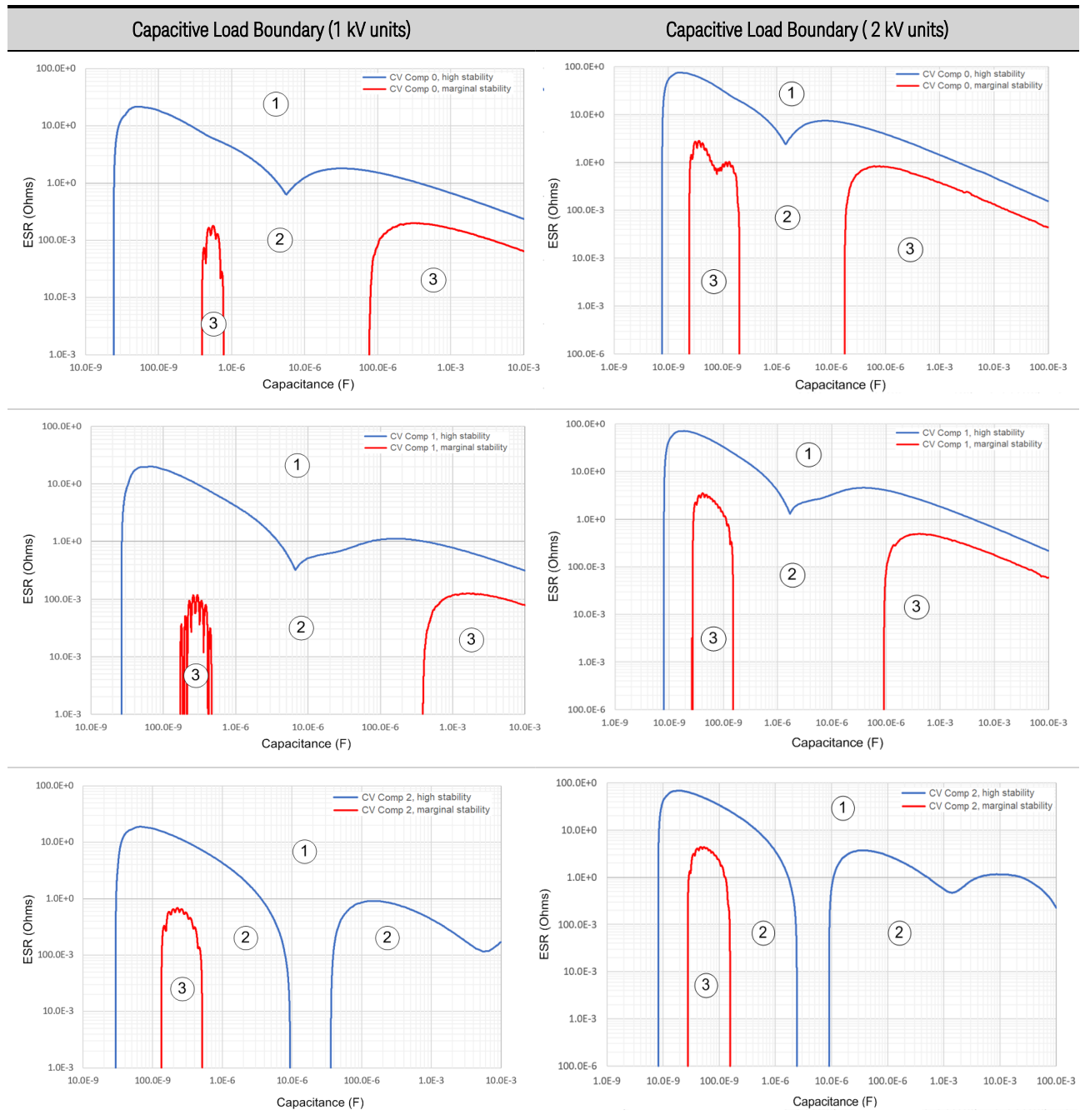

1. The output is stable in this region; 2. The output may overshoot in this region; 3. The output may be unstable in this region

# 1 Quick Reference

For 30 kW Models RP7982A, RP7983A, RP7984A

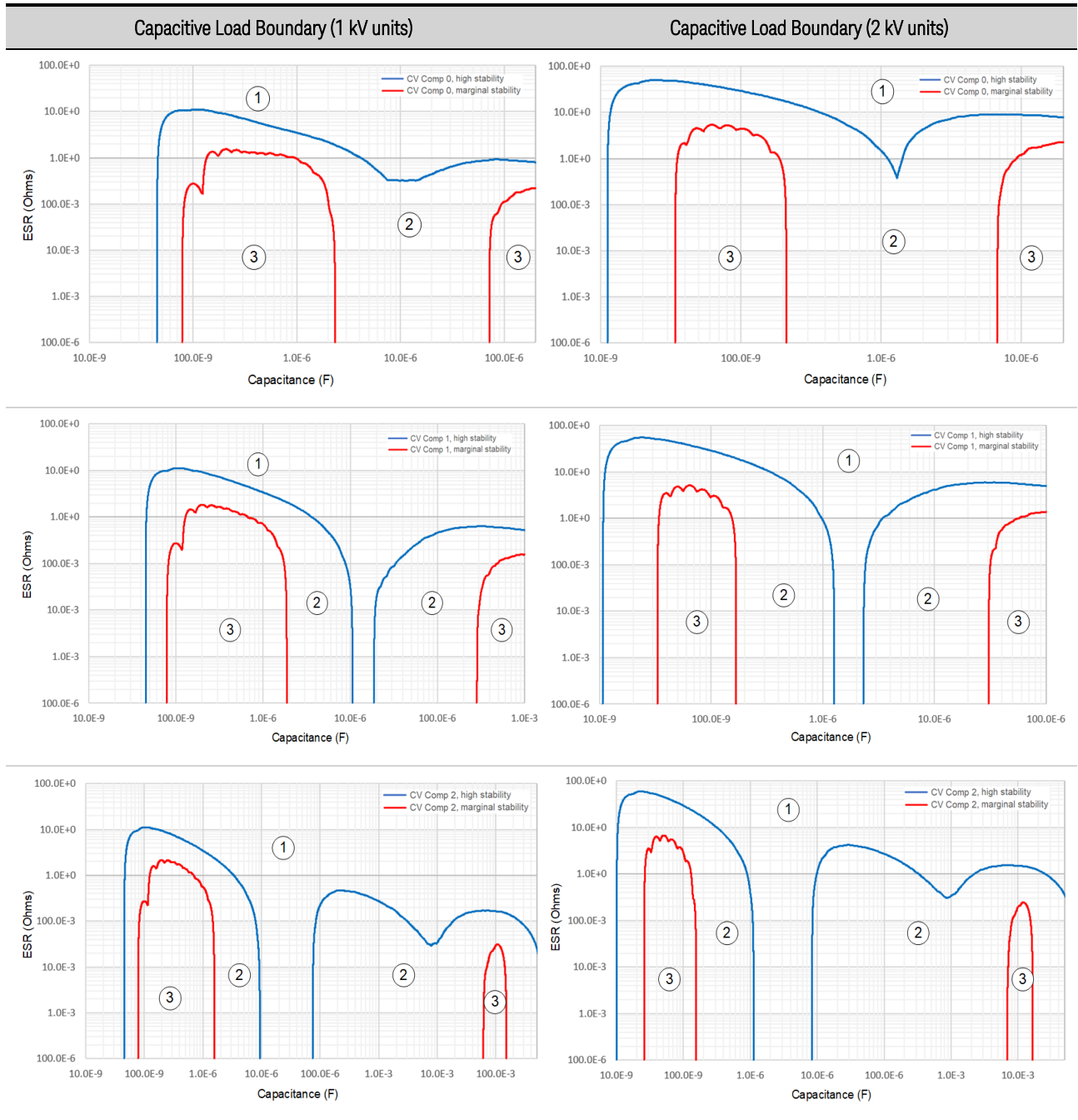

1. The output is stable in this region;
2. The output may overshoot in this region
3. The output may be unstable in this region



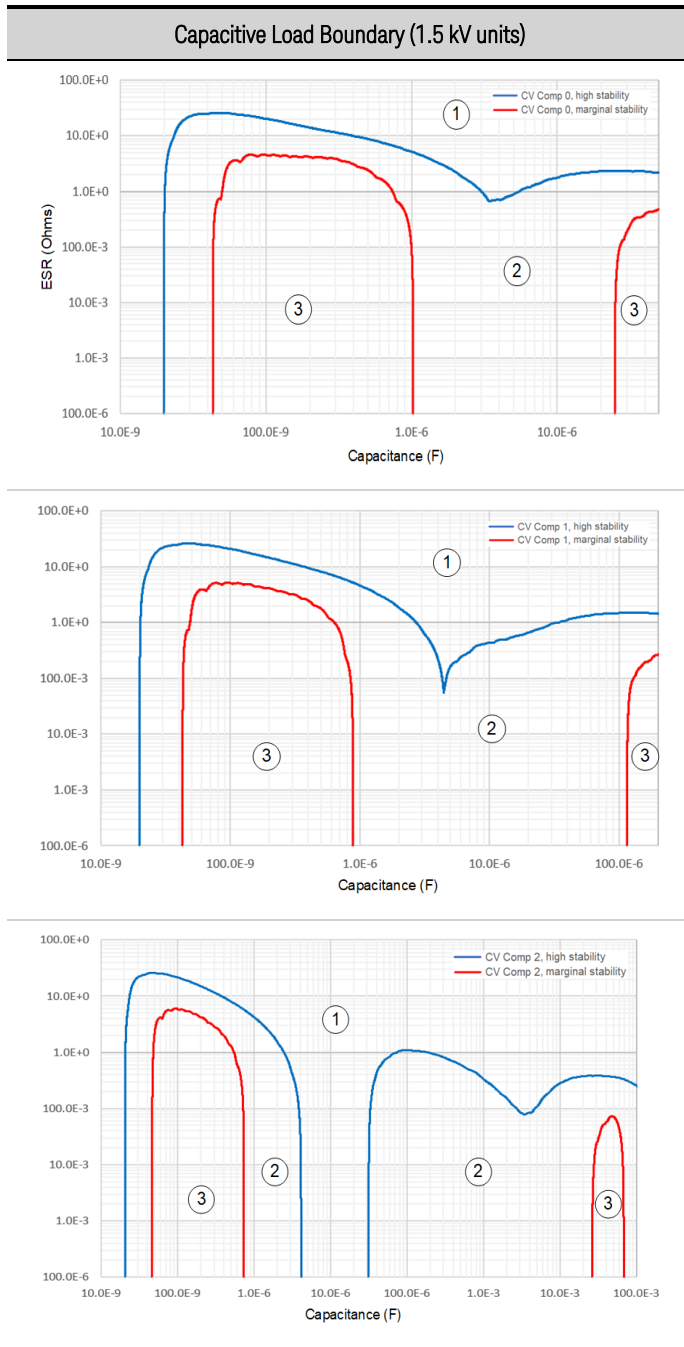

1. The output is stable in this region
2. The output may overshoot in this region
3. The output may be unstable in this region

## Small Signal Programming Response

The following graphs show the output voltage and current programming response characteristic. The voltage response applies with no load (open-circuit) conditions. The current response applies with a short-circuit conditions where the DUT is a low ac impedance. The characteristic is valid when operating above 10% of the rated output of the unit.

For 20 kW and 30 kW Models

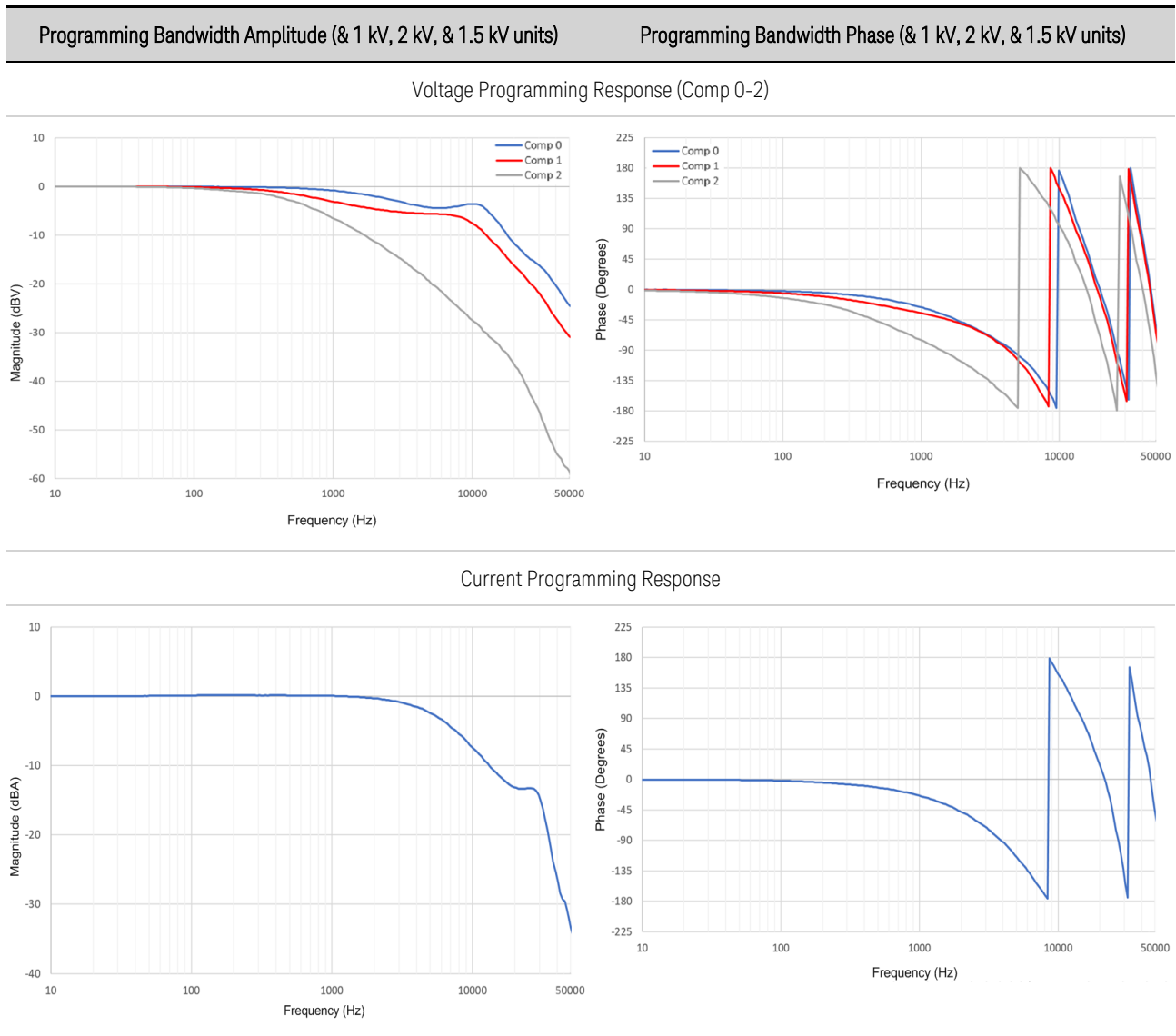

## Measurement Accuracy and Resolution - with shorter measurement intervals

The following table shows changes to the short-term measurement accuracy and resolution with various number of power line cycle (NPLC) measurement settings. Changes are due to the A-to-D converter's noise performance. The table's baseline is 1 NPLC with no added noise. To determine the measurement accuracy at shorter averaging intervals, simply calculate the percent of range to add, then add it to the offset value in the specification table.

For example, to determine the percent of range to add to the accuracy specification of the voltage measurement when making measurements at 0.003 NPLC, simply multiply the full voltage rating by the "% of range added to spec value" as follows: 2000 V x 0.0015% = 30 mV. Add this number to the offset part of the measurement accuracy specification: 150 mV + 30 mV. The new voltage measurement accuracy is 0.04% + 180 mV at 0.003 NPLC.

NPLC @60Hz	Number of averaged points	Voltage Measurement % of range added to offset	Current Measurement % of range added to offset
1	3255	0	0
0.3	1000	0.0004%	0.0015%
0.1	325	0.0007%	0.003%
0.01	33	0.0009%	0.008%
0.003	10	0.0015%	0.016%
0.0003	1	0.005%	0.056%

## Excessive Dynamic Protection (all models)

To prevent the unit from disabling the output due to an excessive dynamic protection (EDP) condition, you must limit the amplitude of any user-defined arbitrary waveform versus output frequency.

The following graph plots the maximum permissible output peak-to-peak voltage that can safely be generated by the arbitrary waveform system at a specific frequency. The values are normalized in terms of full scale peak to peak voltage; therefore all models are represented.

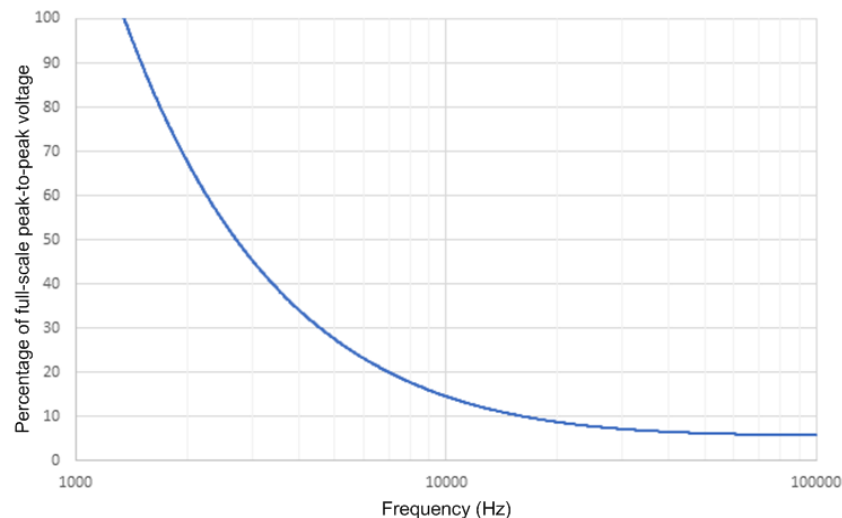

## Output Quadrants

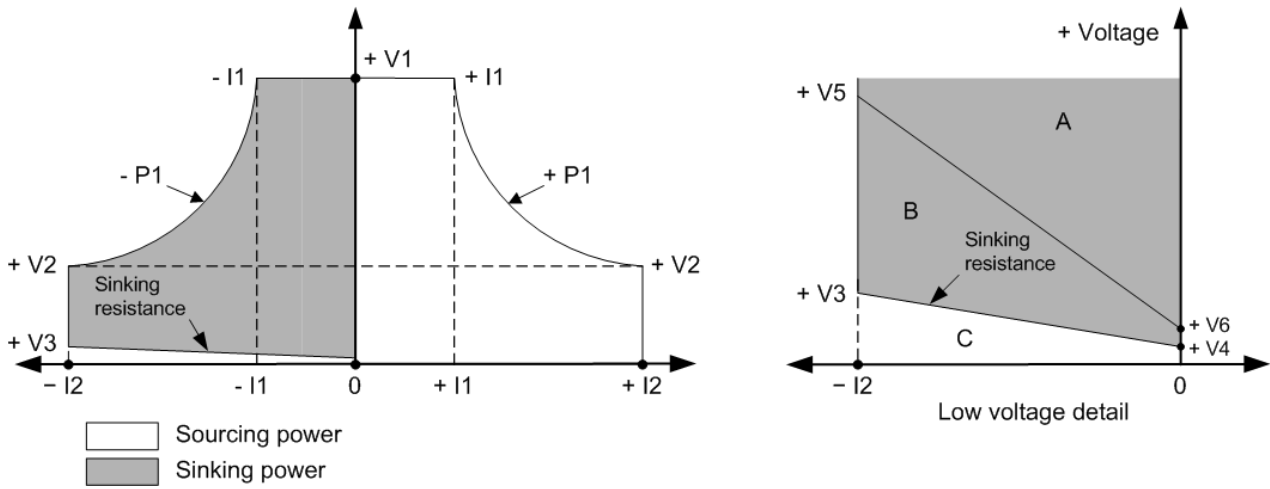

Model	+V1	+V2	+V3	+V4	+V5	+V6	+/- I1	+/- I2	+/- P1	Sinking resistance
RP7972A	1000 V	333 V	7.8 V	2.5 V	25.5 V	3 V	20 A	60 A	20 kW	130 mΩ
RP7973A	2000 V	666 V	15 V	5 V	51 V	6 V	10 A	30 A	20 kW	500 mΩ
RP7982A	1000 V	333 V	7.2 V	2.5 V	25.5 V	3 V	30 A <sup>1</sup>	90 A <sup>1</sup>	30 kW <sup>1</sup>	80 mΩ
RP7983A	2000 V	1000 V	18 V	5 V	51 V	6 V	15 A <sup>1</sup>	30 A <sup>1</sup>	30 kW <sup>1</sup>	600 mΩ
RP7984A	1500 V	500 V	10.5 V	0 V	33 V	3 V	20 A <sup>1</sup>	60 A <sup>1</sup>	30 kW <sup>1</sup>	175 mΩ

<sup>1</sup>200/208 Vac input reduces the current and power rating 50%; 200/208 Vac input is only available with firmware rev B.06.03.1003 and up

### Low voltage detail

A. The unit operates normally in this region

B. The output voltage and current will regulate properly but the status may indicate unregulated. Additionally, the peak-to-peak and rms ripple may be higher and the settling time and transient response may be slower.

C. The unit will not operate in this region. This region is bounded by the sinking resistance limit. The border lines between A, B, and C are approximate.

# 2

## Installing the Instrument

### Before Installation or Use

#### AC Mains Connections

#### Single Unit Output Connections

#### Multiple Unit Output Connections

#### Interface Connections

**WARNING**

**Heavy Weight**

Danger to hands and feet. To avoid personal injury and damage to the instrument, always use a sturdy cart or other suitable device to move the instrument. Do not lift the instrument alone; always use two people to lift the instrument.



## Before Installation or Use

### Inspect the Unit

Upon receipt of the RPS unit, inspect it for any obvious shipping damage. If there is damage, notify the shipping carrier and nearest Keysight Sales and Support Office immediately ([www.keysight.com/find/assist](http://www.keysight.com/find/assist)). Save the shipping carton and packing materials in case the unit has to be returned.

### Check for Items Supplied

Before getting started, check the following list and verify that you have received these items. If anything is missing, please contact your nearest Keysight Sales and Support Office.

Supplied Items	Description	Part Number
Sense connector plug with cable (installed)	4-pin high-voltage sense connector plug with 2-wire high-voltage cable for +/- voltage sense	Keysight 5188-9651 Plug only: Keysight 0360-3228 (Phoenix Contact 1714294)
Sense connector plug (installed)	4-pin high-voltage sense connector (The two center terminals are not used)	Keysight 0360-3228 (Phoenix Contact 1714294)
Cover kit - Includes:		Keysight 5066-2117
Digital connector plug	8-pin connector for the digital port	Phoenix Contact 1840421
Primary/secondary cable	1 m cable (CAT6A) for parallel communication	
AC input safety cover	AC input safety cover with strain relief bushing	
Output safety cover	High voltage output bus bar safety cover	
Ferrite core	Ferrite core installs on the output cables (for RP7973A, RP7982A, RP7983A)	
ESD cover with flange	ESD cover for remote interface connections	
Bus bar connection kit	Connection hardware for high voltage bus bars	Keysight 5067-6031
Calibration certificate	Calibration certificate referenced to serial number	None

### Review Safety Information

This power supply is a Safety Class 1 instrument - with a protective earth terminal. This terminal must be connected to earth ground through an ac mains equipped with an earth ground. Refer to the [Safety Summary](#) page for general safety information. Before installation or operation, always review this guide for specific safety warnings and instructions located at appropriate places throughout the guide.

#### **WARNING**

**SHOCK HAZARD, LETHAL VOLTAGES - Many models generate output voltages up to 2,000 VDC! Ensure that all instrument connections, load wiring, load and sense connections are insulated using high-voltage wire. Always attach the safety cover provided, so that no accidental contact with lethal voltages can occur.**

## Observe Environmental Conditions

**WARNING** Do not operate the instrument in the presence of flammable gases or fumes.

---

The environmental conditions for the power supply are documented under **Common Characteristics**. Basically, the unit should only be operated indoors in a controlled environment. Do not operate the unit in areas where the ambient temperature exceeds +55 degrees Celsius. This applies for rack-mounting as well as for bench use.

## Provide Adequate Air Flow

**CAUTION** Do not block the air intake at the front, or the exhaust at the rear of the instrument.

---

The dimensions of your power supply as well as an outline diagram are given under **Outline Diagram**. Fans cool the power supply by drawing air through the front and exhausting it out the back. The unit must be installed in a location that allows sufficient space of at least 12 inches (30.5 cm) at the front and back of the unit for adequate air circulation.

In case of excessive ambient temperature or blockage of airflow at the air inlet or outlet of the instrument, an over-temperature protection will disable the output to protect the power supply and device under test.

## Moving Instruments

**CAUTION** Keysight RPS models weigh as much as 126 lbs. (57.2 kg). Always use a sturdy cart or other suitable device to move the instrument. Two people are required for installation. Do not lift or move the unit alone. Avoid moving the unit by hand. If unavoidable, lift only the unit's chassis; do not lift the unit using the output terminals or front panel.

---

## Stacking Instruments

**CAUTION** Never stack more than three 20 kW-rated units on top of one another in a free-standing installation. Additionally, because of their increased weight, 30 kW-rated units (RP7982A, RP7983A) cannot be stacked.

---

## Rack Mounting Accessories

Accessory	Description
Keysight 1CP108A	Rack mount kit with handles - for use with RP7972A, RP7973A
Keysight 1CP120A	Rack mount kit with handles - for use with RP7982A, RP7983A
Keysight RP7908A	Rack rails for Keysight racks or similar design

### Outline Diagram for 20 kW Models

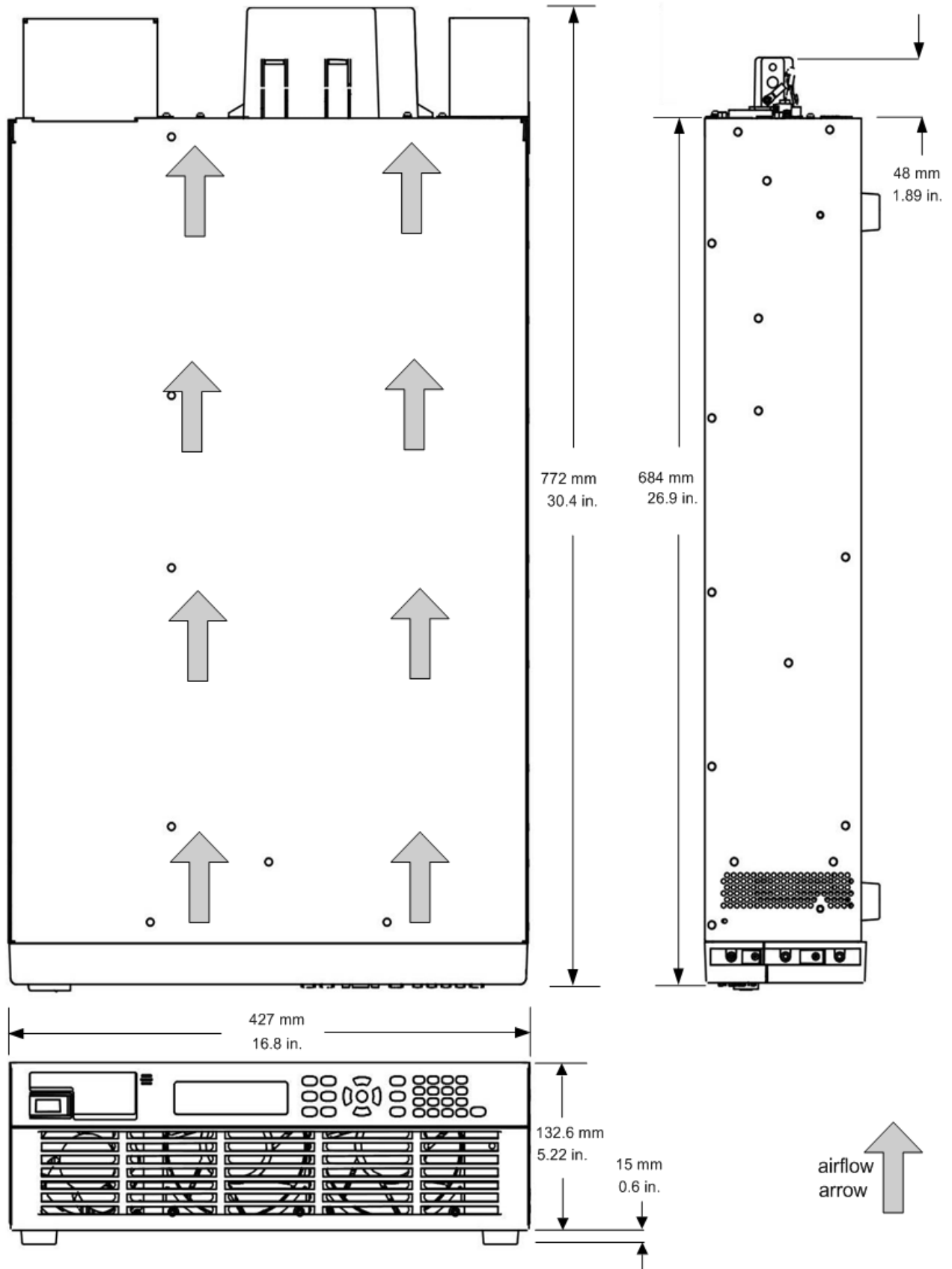



Outline Diagram for 30 kW Models

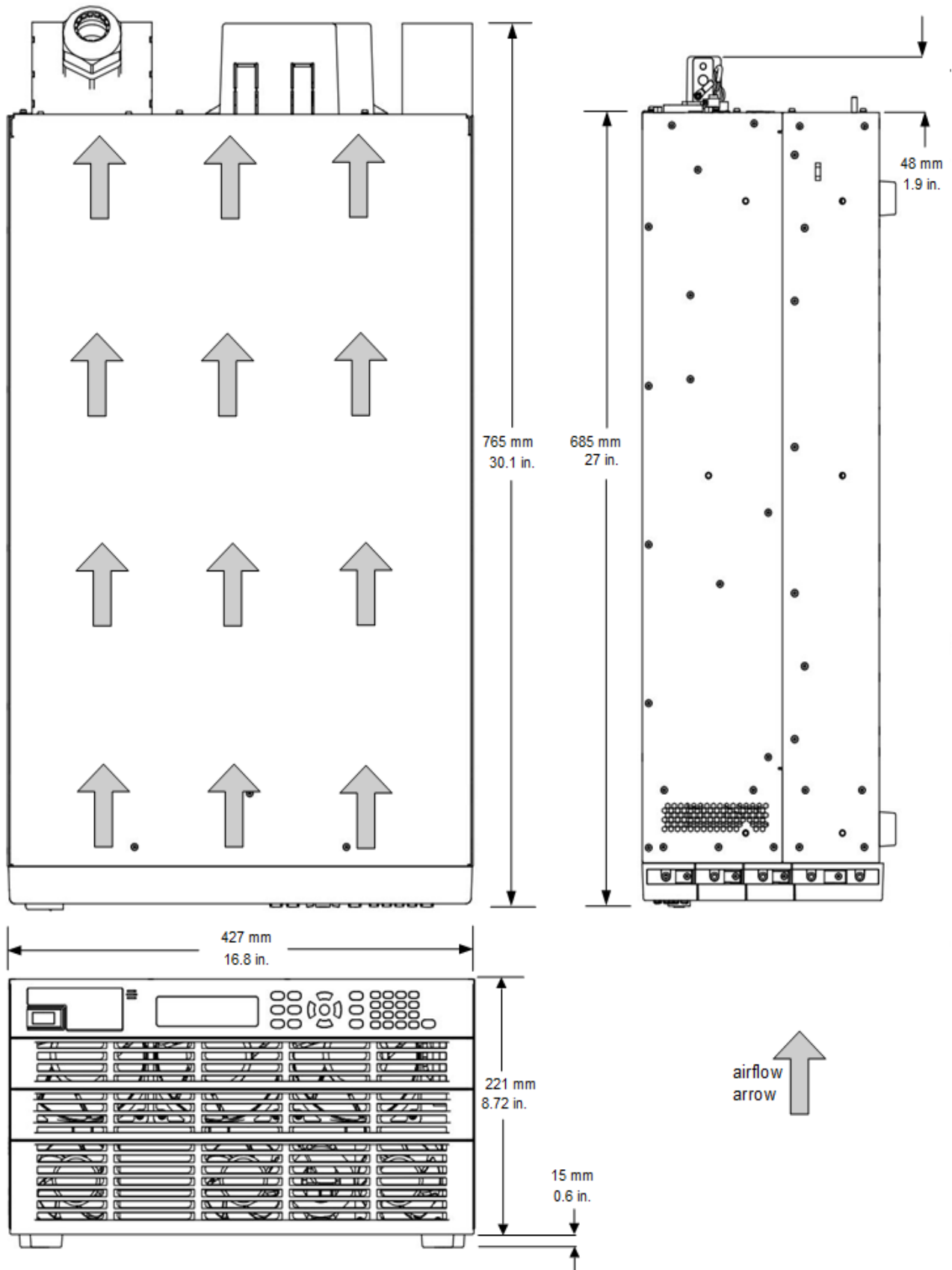

# AC Mains Connections

## AC Mains Considerations

### Power Cable Connections

## AC Mains Considerations

Keysight RPS models have a fully bi-directional three-phase ac input converter, which allows for seamless bi-directional power flow between the ac mains and dc output terminals.

In a standard power supply, energy only flows from the ac to the dc output terminals. In a regenerative power supply, energy also flows from the dc output terminals back to the ac mains whenever the unit is sinking current, either from rapid down-programming of the output or from discharging an energy source such as a battery. This return of energy back to the ac mains is referred to as regenerative operation.

The ac input converter of the RPS unit employs firmware algorithms to maintain high power factor and low total harmonic distortion across a wide range of operating conditions. For more information refer to the ac input portion of the **Characteristics** section.

Follow all wiring instructions for the power cord provided in this section of the manual. For example, previous RPS units employed a connection to ac neutral, or the unit would not turn on. Later RPS units no longer require a neutral connection. Refer to **Power Cable Connections** for details.

### CAUTION

Exceeding the ac input voltage rating or mis-wiring the line connection can create permanent damage in the following devices.

---

The following components are used to provide immunity against line-to-line transients as high as 2 kV, and line-to-ground transients as high as 4 kV:

- 300 Vrms voltage limiting devices are installed between the line and neutral connections.
- 600 Vrms voltage limiting devices are installed between the line-to-line connections.
- A gas-discharge tube is installed between the neutral connection and chassis ground.

Several internal protection functions are used to safeguard the instrument against abnormal line conditions while also preventing ac mains islanding. The following conditions cause the instrument to shut down:

- If the line voltage is greater than 120% of the highest nominal rating for two line cycles.
- If the line voltage is less than 50% of the lowest nominal rating for four line cycles.
- If the line current is greater than 120% of the highest expected line current for about one second.
- If the line frequency shifts more than 2 Hz from its initial frequency for more than two seconds.
- If a four-cycle line dropout occurs.

The instrument will automatically reboot if the fault condition is no longer present. The output will remain off after reboot until the operator reinstates the previous settings, either by the front panel controls or a computer program. This behavior is consistent with safe operating procedures.

The following conditions will force the output into a protection state and produce a power fail (PF) status flag. Cycling power will be required to clear the protection:

- If the line voltage is less than 83% of the lowest nominal rating for more than one second.
- If an extreme line-to-line surge approaching 2 kV occurs.

The following condition will prevent the instrument from turning on:

- If the line frequency is outside the range of 46.5 Hz to 63.5 Hz.

In case of an ac mains power failure, the unit will automatically disconnect from the line. This will occur with the unit either sourcing or sinking current.

## Power Cable Connections

### NOTE

Compliance to all regulations for the operation of and connection to the public grid of energy back-feeding equipment is required.

AC mains connections must be made by a qualified electrician who is knowledgeable about energy back-feeding equipment to ensure that all applicable safety requirements have been applied and all necessary conditions have been met. Knowledge about 3-phase mains circuits and all applicable safety standards and requirements is also required.

*An ac mains power cable is not provided with the unit.*

Refer to the following table for the maximum current capacity requirements for each cable conductor. If required by local electrical codes, install a fuse or circuit breaker between the ac mains and the unit.

Model	Unit Rating	L1 $I_{max}$	L2 $I_{max}$	L3 $I_{max}$
RP7972A, RP7973A	20 kW, 380-480 Vac, line-to-line	36 A	36 A	36 A
RP7982A, RP7983A, RP7984A	30 kW, 380-480 Vac, line-to-line	52 A	52 A	52 A
	15 kW, 200-208 Vac, line-to-line	51.9	51.9	51.9

### WARNING

The cable cross-section must be suitable for the maximum input current of the instrument. The ground cable must have the same cross-section as the phase cables.

### CAUTION

**Possible Equipment Damage** Delta-type ac-mains transformers are **not** supported. For Wye-type ac-mains connections, the neutral wire **must** be connected on units with firmware revision prior to B.06.03.985, otherwise the units will not turn on. Ensure that no wires other than the neutral wire are connected to the "N" port. If a Neutral connection is not required, leave the N terminal unconnected.

## 2 Installing the Instrument

### NOTE

Safety agency requirements dictate that there must be a way to physically disconnect the ac mains cable from the unit. A disconnect device, either a switch or circuit breaker must be provided in the final installation. The disconnect device must be close to the equipment, be easily accessible, and be marked as the disconnect device for this equipment. It must meet the input ratings requirements listed in the previous table.

Starting with firmware revision B.06.03.985 and up, ac mains wiring without a neutral connection may be used. Refer to **Instrument Identification** to determine which firmware version is installed on your instrument.

A solidly-grounded Wye-type ac mains transformer is required. This may be on-premise or part of the electric utility equipment. If the neutral is to be used, it must be a separate conductor from earth ground (Protective Earth (PE)).

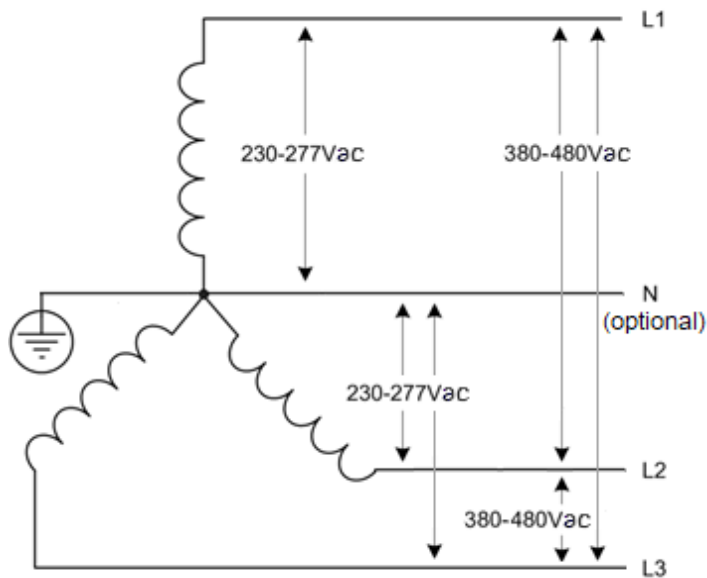

### 380-480 ac mains, line-to-line

This is a solidly-grounded Wye-type transformer.

A separate Neutral (N) connection to the unit is not required for firmware revision B.06.03.985 and up.

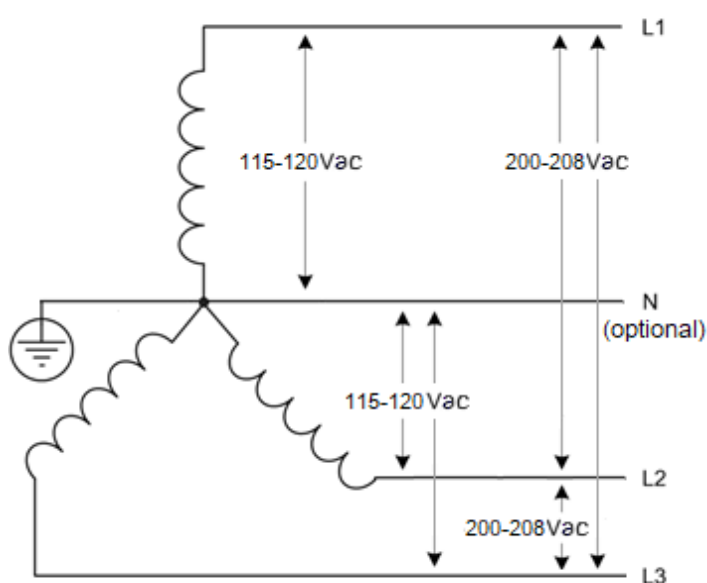

### 200-208 ac mains, line-to-line

This is a solidly-grounded Wye-type transformer.

A separate Neutral (N) connection to the unit is not required for firmware revision B.06.03.985 and up.

200-208 ac input is allowed on RP798xA models with firmware revision B.06.03.1003 and up. 200/208 Vac input reduces the current and power rating by 50%.

**WARNING**

**SHOCK HAZARD** The instrument requires a chassis ground connection through a separate conductor. The ac mains must include an earth ground connection.

In cases where the unit is not hardwired to the electrical system, a locking connector scheme should be used as referenced in UL 498, IEC 60309, or equivalent. Consult a local electrician for the connector scheme appropriate for your region.

480V/60A and 200V/30A connector examples:

[https://en.wikipedia.org/wiki/IEC\\_60309](https://en.wikipedia.org/wiki/IEC_60309)

Keep the ac mains cables as short as possible. The longer the cable, the greater the voltage loss due to cable resistance.

- If attached, remove the safety cover from the unit.
- Insert the power cord through the strain relief bushing of the safety cover. The strain relief bushing can accommodate a wire cable or individual wires. Minimum inside diameter: 15 mm (0.6 in.). Maximum inside diameter: 25.4 mm (1 in.).
- Do not tighten the strain relief until all wire connections are complete.
- After all wire connections are complete, attach the safety cover to the unit and tighten the strain relief.
- Attach the line wires to the ac mains terminals (U.S. color code shown). Maximum wire size: 6 AWG (16 mm<sup>2</sup>) Wire stripping length: 18 mm Always use a flat blade screwdriver to release and fully open the wire clamp.
- Optional ferrule suggestion:  
For 6 AWG: WAGO 216-210  
For 8 AWG: WAGO 216-289  
For 10 AWG: WAGO 216-288  
(Refer to manufacturer for details.)
- Connect the ground wire to the chassis stud *below* the ac connector. The stud diameter is M5. Torque the M5 combination nut to 20 in-lbs.

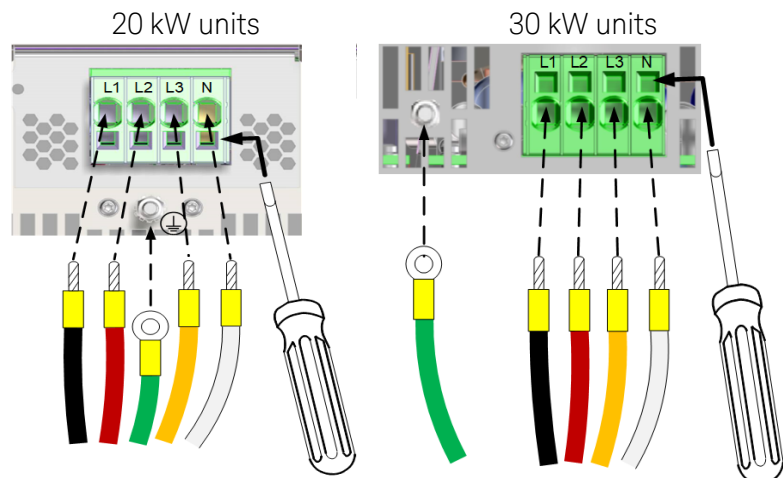
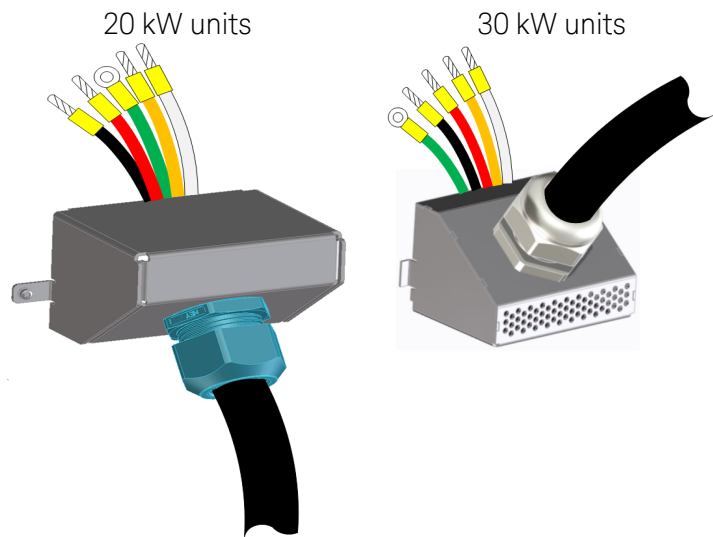

## Single Unit Output Connections

### Output Connections

#### Single Load Connections

#### Multiple Load Connections

#### Remote Sense Connections

#### Additional Load Considerations

## Output Connections

### Sense Connections

Ensure that the sense cable is installed on the back of the instrument as shown. The only time the sense cable should be disconnected from the output bus bars is when **remote sensing**.

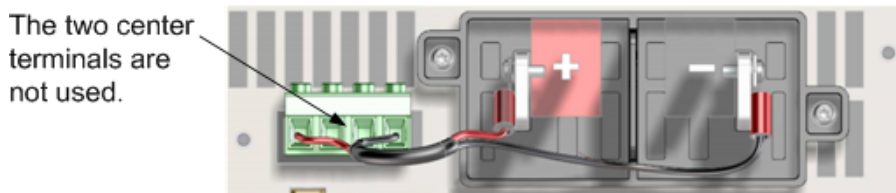

If the sense cable is not installed prior to instrument turn-on or becomes disconnected, the unit will continue to operate. The open-circuit voltage will now be higher **at the output terminals** than the programmed value because the regulation point is now maintained through internal sense-protect resistors. The actual voltage at the output terminals will be higher by the percent shown below, even though the readback voltage will still reflect the programmed value.

Model	$\Delta$ Output voltage increase
RP7972A, RP7982A	1 %
RP7973A, RP7983A, RP7984A	1.65 %

### Bus Bar Connections

#### **WARNING**

**SHOCK HAZARD, LETHAL VOLTAGES** - Many models generate output voltages up to 2,000 VDC! Ensure that all instrument connections, load wiring, load and sense connections are insulated using high-voltage wire. Always attach the safety cover provided, so that no accidental contact with lethal voltages can occur.

The following factors should be considered when wiring the load to the power supply:

- Load wire temperature, current carrying capacity, and voltage drop
- Load and sense wire insulation rating must be equivalent to the output voltage rating
- Load wire noise and impedance effect

## Wire Size

### WARNING

**FIRE HAZARD** To satisfy safety requirements, load wires must be large enough not to overheat when carrying the maximum short-circuit output current. If there is more than one load, then any pair of load wires must be capable of safely carrying the full-rated current of the unit. Paralleled load wires may be required for larger-ampacity models.

The following table lists the characteristics of AWG (American Wire Gauge) copper wire.

AWG	Equivalent mm <sup>2</sup>	Nearest Metric size	Ampacity (Note 1)	Resistance (Note 2)
18	0.82	1.0 mm <sup>2</sup>	up to 14 A	6.385 Ω
16	1.31	1.5 mm <sup>2</sup>	up to 18 A	4.016 Ω
14	2.1	2.5 mm <sup>2</sup>	up to 25 A	2.525 Ω
12	3.3	4 mm <sup>2</sup>	up to 30 A	1.588 Ω
10	5.3	6 mm <sup>2</sup>	up to 40 A	0.999 Ω
8	8.4	10 mm <sup>2</sup>	up to 60 A	0.628 Ω
6	13.3	16 mm <sup>2</sup>	up to 80 A	0.395 Ω
4	21.2	25 mm <sup>2</sup>	up to 105 A	0.248 Ω
2	33.6	35 mm <sup>2</sup>	up to 140 A	0.156 Ω

Note 1 Ampacity is based on a single conductor **in free air**, 26–30 °C ambient temperature with the conductor rated at 60 °C. Ampacity decreases at higher temperatures.

Note 2 Resistance is in ohms/1000 feet, at 20 °C wire temperature.

Along with ampacity, you must also consider voltage drop in the load lead due to wire resistance sizing wires. The power supply will tolerate a voltage drop of 1 V per lead while maintaining the specified programming accuracy, measurement accuracy, and load regulation (see **specifications**). Voltage drops of up to 25% of the rated output voltage per lead will be tolerated - resulting in an additional 4 mV of voltage regulation for each additional volt dropped per load lead. Of course, any voltage drop in the load leads reduces the maximum voltage available at the load. Subtract the load lead drop from the rated output voltage to determine the maximum voltage available at the load.

## Single Load Connections

1. As shown in the following figure, terminate all load wires with wire terminal lugs securely attached. DO NOT use unterminated wires for load connections at the power supply.
2. Route the wires through the safety cover before attaching them to the bus bars. Knockouts are provided on for larger diameter wires. The figure illustrates the recommended hardware for connecting wires to the bus bars. You must provide all cabling. Ensure that the wire-mounting hardware does not short the output terminals.



## 2 Installing the Instrument

- When attaching terminal lugs to the bus bars, do not put any washers or other hardware between the lug and bus bar. Ensure there is enough room for the safety cover. Twist or bundle the load wires to reduce lead inductance and noise pickup. The goal is to minimize the loop area or physical space between the + and - output leads from the bus bars to the load.
- Attach the safety cover to the rear panel.** Make sure that you do not pinch the sense wires when attaching the cover. Note that heavy wiring cables must have some form of strain relief to prevent bending the safety cover or bus bars.

### CAUTION

Tightening torque for the 8.8 mm opening cannot exceed 10.8 Nm (8 lb-ft).  
Tightening torque for the 5.5 mm opening cannot exceed 4.8 Nm (3.5 lb-ft).

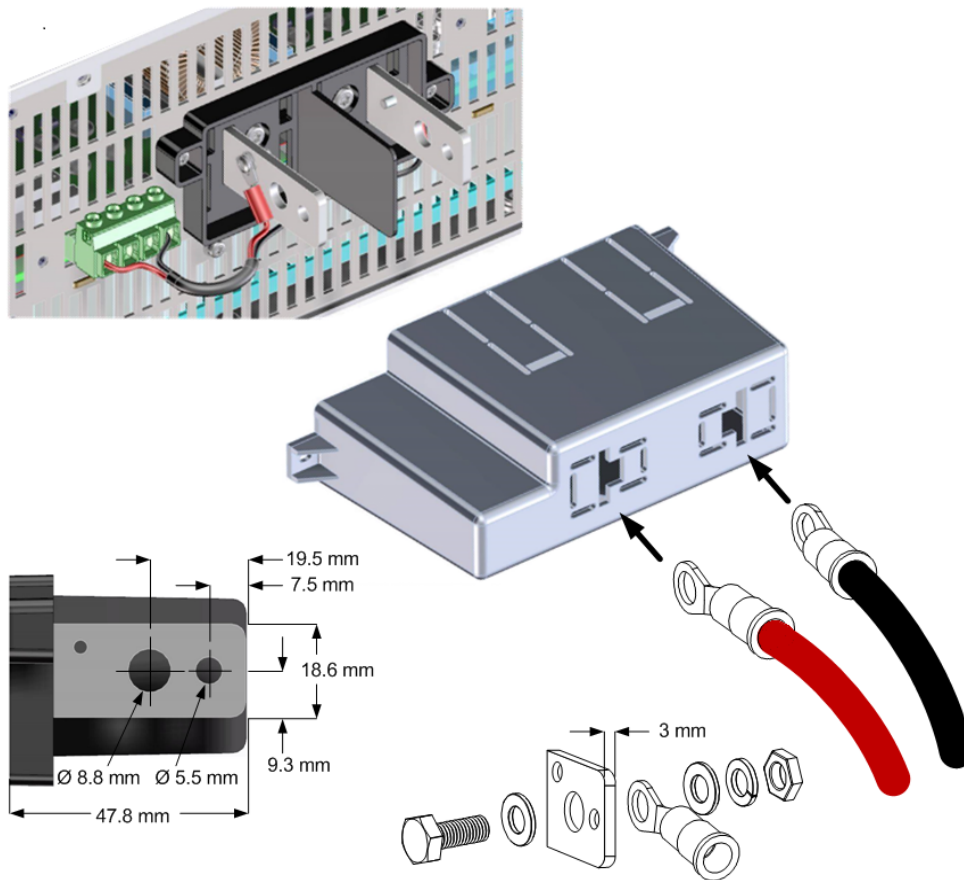

### Ferrite Core Installation - for RP7973A, RP7982A, RP7983A models only

For the applicable units, install the supplied ferrite core to reduce EMI (electromagnetic interference).

Run each output lead through the core three times. If using remote sensing (not shown), also run each sense lead through the core three times.

Place the core as close as possible to the output cover as shown.

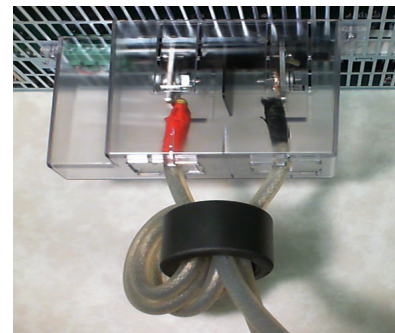



## Multiple Load Connections

### WARNING

**SHOCK HAZARD, LETHAL VOLTAGES** - Many models generate output voltages up to 2,000 VDC! Ensure that all instrument connections, load wiring, load and sense connections are insulated using high-voltage wire. Always attach the safety cover provided, so that no accidental contact with lethal voltages can occur.

If you are using local sensing and are connecting multiple loads to one output, connect each load to the output terminals using separate connecting wires as shown in the following figure. This minimizes mutual coupling effects and takes full advantage of the power supply's low output impedance. Keep the wire-pair as short as possible and twist or bundle it to reduce lead inductance and noise pickup. The goal is to minimize the loop area or physical space between the + and - output leads from the bus bars to the load.

If load considerations require the use of distribution terminals that are located away from the power supply, twist or bundle the wires from the output terminals to the remote distribution terminals. Connect each load to the distribution terminals separately. Remote voltage sensing is recommended under these circumstances. Sense either at the remote distribution terminals or, if one load is more sensitive than the others, directly at the critical load.

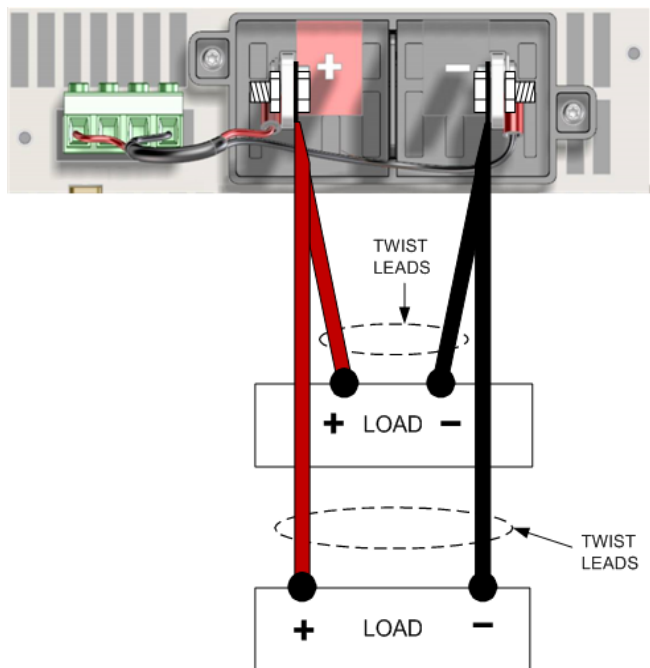

## Remote Sense Connections

### WARNING

**SHOCK HAZARD, LETHAL VOLTAGES** - Many models generate output voltages up to 2,000 VDC! Ensure that all instrument connections, load wiring, load and sense connections are insulated using high-voltage wire. Always attach the safety cover provided, so that no accidental contact with lethal voltages can occur.

Remote sensing improves the voltage regulation at the load by regulating the voltage there instead of at the output terminals. This lets the power supply automatically compensate for the voltage drop in the load leads. Remote sensing is especially useful for CV operation with load impedances that vary or have significant load lead resistance. In current priority mode, the voltage limit settings are monitored at the sense connections. Over-voltage protection is also monitored at the sense connections.

Connect the unit for remote sensing by first removing the local sense cable between the sense and load terminals. Then make your sense and load connections as shown in the following figure. Note that the two center terminals of the sense connector are not used.

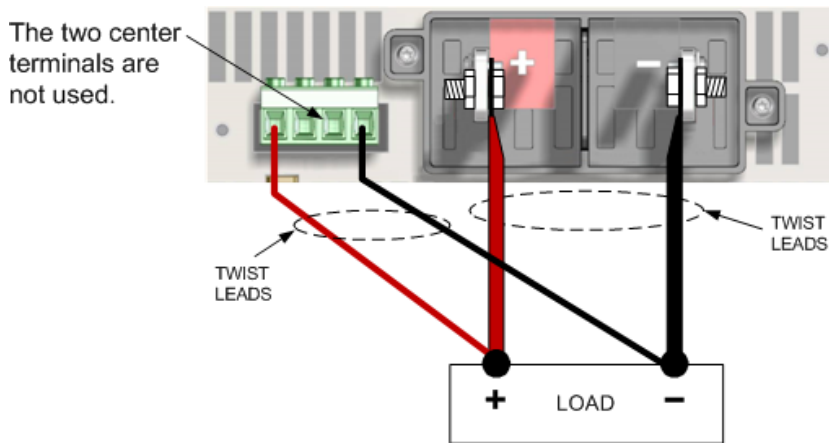

Sense connectors accept wire sizes between AWG 16 (1.5 mm<sup>2</sup>) maximum and AWG 24 (0.2 mm<sup>2</sup>) minimum. Strip the wire insulation back 10 mm. Tighten the screws securely.

Connect the sense leads as close to the load as possible. Keep the sense wire-pair as short as possible and twist or bundle it to reduce noise pickup. Do NOT bundle the sense wire-pair together with the load leads; keep the load wires and sense wires separate. Sense wires are normally of a lighter gauge than the load wiring.

Note that any voltage drop due to wire resistance in the sense leads can degrade the output voltage regulation. As the voltage drop in the load leads increases, the load voltage regulation error due to sense-lead resistance increases according to the following formula:

$$\Delta V_{\text{regulation}} = 2(V_{\text{load}}(R_{\text{sense}}/S_{\text{protect}}))$$

$R_{\text{sense}}$  is the resistance in ohms of each sense lead.

$V_{\text{load}}$  is the voltage drop in each load lead.

$S_{\text{protect}}$  is the internal sense protect resistor (see following table).

The formula assumes that the voltage drop in the +/- load leads are equal.

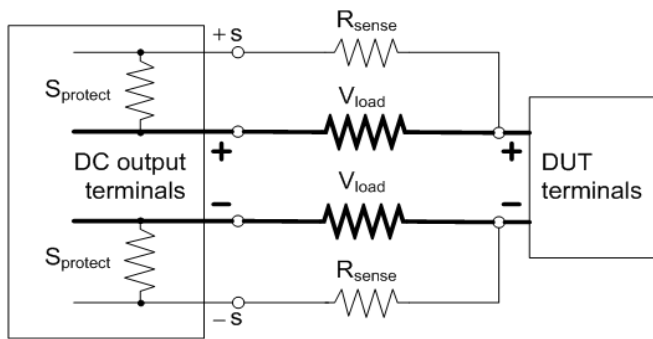

Model	S <sub>protect</sub> resistor	Model	S <sub>protect</sub> resistor
RP7972A, RP7982A	198 kΩ	RP7984A	108 kΩ
RP7973A, RP7983A	60 kΩ		

If the remote sense wires open during normal CV operation (with output current present), the change in output voltage **at the load** will depend on the load current and the load wire resistances involved. When the sense leads open, the unit automatically reverts to local sensing. The voltage at the previous remote sense point (usually at the load) will change by an amount given by the following equation:

$$\Delta V = K(V_{\text{set}}) - I_{\text{out}} \times (\text{total resistance of load leads})$$

$K = 1\%$  for 1 kV models,  $1.2\%$  for 1.5 kV models, and  $1.65\%$  for 2 kV models

$I_{\text{out}} =$  positive when the unit sourcing current; negative when the unit is sinking current

Shorted sense leads are detected by the over-voltage protection function. This function results in the output being disabled due to an over-voltage fault (OV). Reversed sense leads are detected by the negative over-voltage protection function. This results in the output being disabled due to a negative over-voltage fault (OV). Refer to **Additional Load Considerations** for information about lead inductance when using remote sensing with load capacitance and lead inductance.

### Over-voltage Protection

Over-voltage protection (OVP) provides a configurable over-voltage protection based on sense lead voltage. Having the OVP circuit monitor the sense lead voltage rather than the output terminal voltage allows for more precise voltage monitoring directly at the load.

Note that due to the voltage drop in the load leads, the voltage at the output of the power supply could be higher than the voltage being regulated at the load. The voltage at the output terminals of the power supply should never exceed the unit's voltage rating.

### Output Noise

Any noise picked up on the sense leads will appear at the output terminals and may adversely affect CV load regulation. Twist the sense leads to minimize the pickup of external noise. In extremely noisy environments it may be necessary to shield the sense leads. Ground the shield at the power supply end only; do not use the shield as one of the sensing conductors.

## 2 Installing the Instrument

The noise specifications documented in the **specification** tables apply at the output terminals when using local sensing. However, voltage transients may be produced at the load by noise induced in the leads or by load current transients acting on the inductance and resistance of the load lead. If it is desirable to keep voltage transient levels to a minimum, place a high-voltage film capacitor, with an approximate value of 10 microfarad per foot (30.5 cm) of load lead, right across the load.

### Additional Load Considerations

#### Response Time with External Capacitor

When up-programming or down-programming the output voltage with an external load capacitor, voltage response time may be longer than with purely resistive loads since the power supply may enter constant current operating mode, which adds additional response time. By setting the proper voltage slew rate when using an external capacitor, it may be possible to prevent mode crossover into constant current. Use the following formula to estimate the additional programming response time:

$$\text{Response Time} = \frac{(\text{added output capacitor} + C_x) \times (\text{change in } V_{\text{out}})}{(\text{current limit setting}) - (\text{load current})}$$

Model	Internal capacitance $C_x$	Model	Internal capacitance $C_x$
RP7972A/ RP7982A	8.8 $\mu\text{F}$ / 13.2 $\mu\text{F}$	RP7984A	5.9 $\mu\text{F}$
RP7973A/ RP7983A	2.2 $\mu\text{F}$ / 1.5 $\mu\text{F}$		

#### Positive, Negative, and Floating Voltages

Either positive or negative voltages with respect to ground can be obtained from the output by grounding (or "commoning") one of the output terminals. Always use two wires to connect the load to the output regardless of where or how the system is grounded.

- 1 kV units can operate with any output terminal  $\pm 1$  kVDC including output voltage from ground
- 1.5/2 kV units can operate with any output terminal  $\pm 2$  kVDC including output voltage from ground

#### NOTE

Keysight power supplies are optimized for grounding the negative output terminal. Grounding the positive terminal may result in increased current measurement noise and a reduction in current measurement accuracy.

#### Load Inductance Limitations

#### CAUTION

EQUIPMENT DAMAGE. The unit's internal voltage clamps may be thermally damaged when the output is abruptly turned off at full load current if the lead inductance exceeds the Maximum Load Inductance listed under **Supplemental characteristics**.

As a wire inductance reference point, a single pair of load leads typically yields between 500 nH to 1  $\mu\text{H}$  per meter of paired length (round trip), depending on the gauge of wire, thickness of insulation, and mechanical coupling of the leads. To attain greater lead lengths, wire inductance can be minimized by paralleling additional bundled sets of load leads or using specialized low inductance wiring.

## Load Capacitance and Lead Inductance Considerations in Constant Voltage (CV) Operation

In CV operation, both in voltage priority mode and in current priority mode (when in voltage limit), the setup typically resembles that in the following figure where the DUT is of a resistive or high impedance nature and may have some local bypass capacitance near its own terminals. Remote sensing at the DUT terminals is recommended if accurate dc voltage regulation is required.

RP797xA and RP798xA

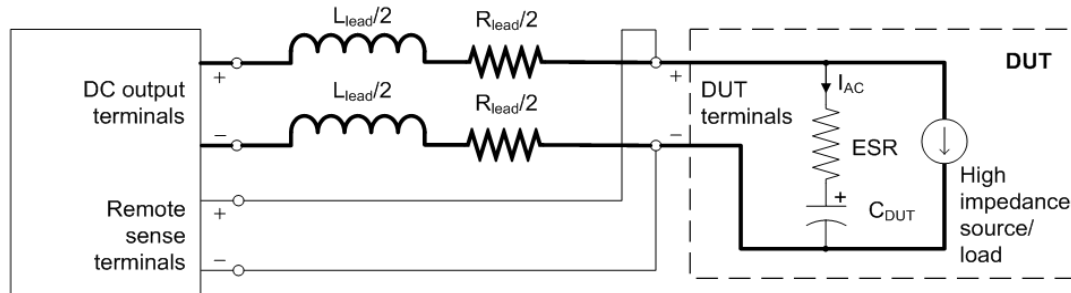

In CV operation, large capacitive loads and high inductance leads have the potential to create ringing and dynamically unstable voltage at the DUT when undergoing sudden load or voltage changes. ESR tends to mitigate this by dampening the resonance that occurs between the load capacitance and lead inductance. Lead resistance contributes to the damping effects of ESR but also increases voltage drop and power dissipation in the load leads. The **Capacitive Load Boundary** characteristic graphs have guidelines for minimum required ESR as a function of DUT capacitance. This is a function of the voltage **compensation mode**.

For a DUT that has internal capacitance with low ESR as shown in the Capacitive Load Boundary graphs, such as film capacitor or ceramic capacitors, additional capacitance and series resistance can be added in parallel to dampen the effects of ringing, as shown in the following figure. The additional capacitance should be at least 1 to 4 times the value of  $C_{DUT}$  and the desired ESR should be chosen based on the Capacitive Load Boundary plots for  $C_{DUT}$ . This can be implemented through the addition of a high-voltage film capacitor and a series resistor. The parallel capacitance and ESR must be able to handle DUT-specific requirements such as current or voltage ripple. In addition, parallel capacitance will limit the ability of the power supply to measure fast current edges sourced directly from the DUT, as well as slow down the voltage programming speed and bandwidth.

Typical external damping network

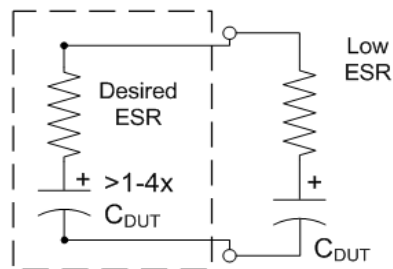

The specified voltage transient response to a load current step for the power supply may become degraded when remote sensing with long load leads, especially with low bypass capacitance at the DUT. This can be manifested as a poorly dampened ringing or even as a well dampened response with very large peak deviation. This issue can be most problematic when operating at lower voltage with higher current. To mitigate this, parallel capacitance can be added at the terminals of interest to

## 2 Installing the Instrument

reduce the amplitude of voltage deviation. It is likely an external parallel damping network, as previously illustrated, would be needed in place of or in addition to a pure capacitor. Generally, a capacitor with low ESR in parallel with a capacitor with high ESR allows for good stability, minimized transient response voltage deviation, as well as good voltage noise filtering.

### Lead Inductance Considerations in Constant Current (CC) Operation

In CC operation, both in current priority mode and in voltage priority mode (when in current limit), the setup typically resembles that in the following figure where the DUT is of a low impedance or voltage source nature. Sense lead measurements are still utilized to detect over/under voltage protection events and when cross-over into CV operation occurs.

RP797xA and RP798xA

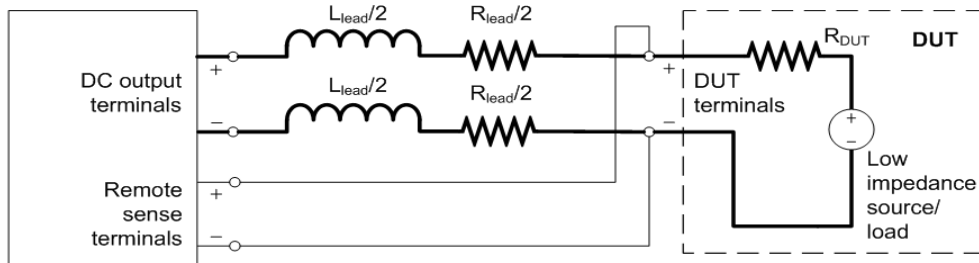

In CC operation, large inductive leads have the potential to create ringing in the output current when undergoing current programming steps or load voltage changes. This effect increases as inductance increases and lead resistance decreases. The **Inductive Load Boundary** characteristic graphs show the minimum amount of lead resistance to mitigate programming overshoot and unstable programming response. Note that if there is no bypass capacitor at the DUT, the lead and DUT resistance are indistinguishable in this context so that any resistance in the DUT is added to the effective lead resistance as specified in the graphs.

### Dynamic Current Programming with Large Inductive Loads

Additional constraints may be required when programming current steps with high inductance DUTs or leads. When programming large current steps, further speed degradation and overshoots may occur due to inherent voltage limitations of the power supply. Without lowering the inductance, the speed degradation cannot be improved. However, the overshoot aspect can be mitigated or removed by gradually decreasing the **programming pole** or **slew rate** until the desired performance is achieved.

### Excessive Current in Current Priority Mode

#### CAUTION

Excessive output current may damage the device under test under certain conditions. This can occur, for example, if the DUT shorts the output of the instrument when the lower voltage limit is set substantially above zero.

When operating in current priority mode, if the voltage of a low-impedance DUT, such as a battery or short circuit, rises above the upper voltage limit setting or falls below the lower voltage limit setting, current flow exceeding the unit's steady state rating can occur, potentially damaging the DUT. After a short delay, the excessive current flow will cause over-current protection to engage - thereby disabling the output of the unit.

## Multiple Unit Output Connections

### Parallel Connections

### Load and Sense Connections

### Primary/Secondary Connections

### Series Connections

## Parallel Connections

Parallel operation lets you connect multiple power supplies together to create a system with higher total current and power. This applies for current sourcing as well as current sinking operation.

### WARNING

**SHOCK HAZARD** All paralleled units must be connected to ground through a grounded power cord at all times. Any interruption of the protective (grounding) conductor or disconnection of the protective earth terminal on any unit will cause a potential shock hazard that could result in injury or death.

---

### CAUTION

**To Prevent Possible Equipment Damage:**

- Connect no more than twenty units **of identical input and output voltage ratings**. All units must have the same voltage rating but current ratings can be different. All units must have the same version firmware. Refer to **Instrument Identification** for the firmware version.
  - Always turn the **ac power** on and off together. Never leave any units powered on while the others are turned off.
- 

## Load and Sense Connections

The following figure illustrates three units connected in parallel. Note the following recommendations:

- Always install the paralleled units relatively close to each other.
- Keep the cables from the power supplies to the load as short as possible and twist or bundle the leads to reduce lead inductance and noise pickup. The goal is to minimize the loop area or physical space between the + and - output leads from the bus bars to the load.
- If the paralleled units cannot be located close together, a symmetrical arrangement of separate load-wire pairs of **equal** length connecting to a common load point is highly recommended. This provides the best possible dynamic response.

## 2 Installing the Instrument

- Bus bars can be used to parallel the output terminals in a stacked configuration. Ensure that the cross-section area of the bus bars will accommodate the total output current of the stack. Bus bars can be placed on either side of the output terminals. Exposed bus bar surfaces must either be enclosed in a cabinet or insulated so that no accidental contact with lethal voltages can occur.
- Use remote sensing to maintain the specified load regulation with paralleled units. Sense wires can either be daisy-chained or all connected directly to the sense point at the load. Twist the sense wire pair. Do not mix remote sensing with local sensing.

Although the following figure shows the recommended use of remote sensing, local sensing may be used if absolutely necessary. With local sensing however, the sharing circuits will work properly only if the voltage drop measured *between* the local sense points of any unit to the local sense points of any other paralleled unit is less than 0.5% of the maximum voltage rating of the units.

### Parallel connection example

**WARNING**

**SHOCK HAZARD, LETHAL VOLTAGES** - Many models generate output voltages up to 2,000 VDC! Ensure that all instrument connections, load wiring, load and sense connections are insulated using high-voltage wire. Always attach the safety cover provided, so that no accidental contact with lethal voltages can occur.

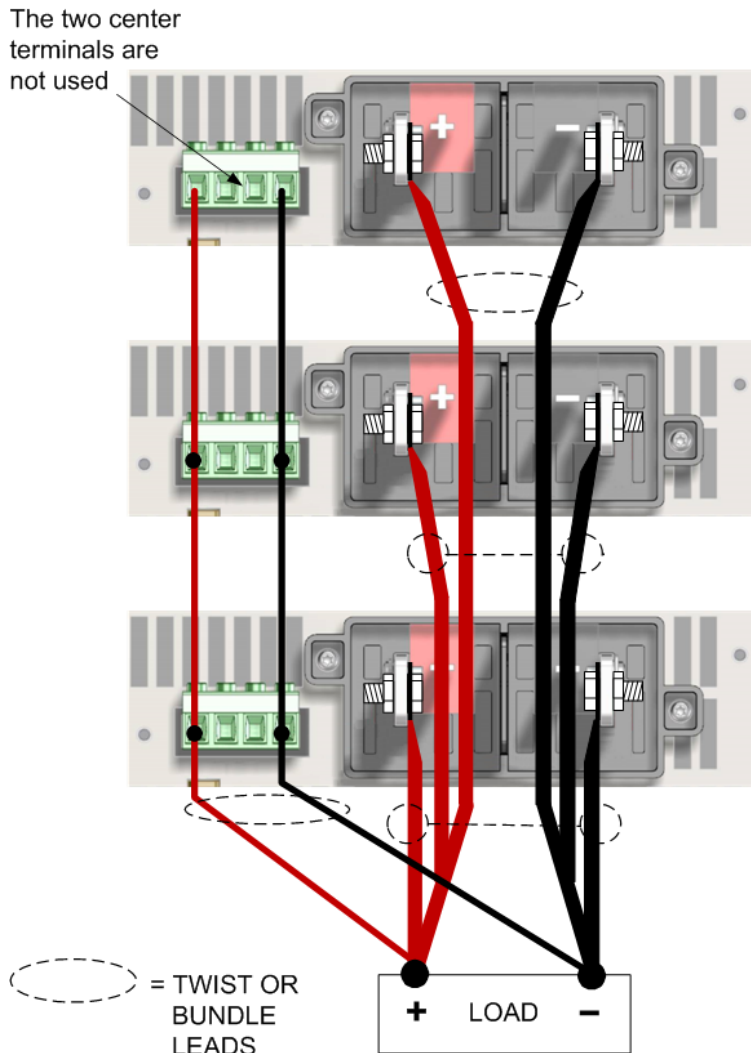



## Primary/Secondary Connections

A primary/secondary configuration can be used when connecting units in parallel. This allows one designated unit to be the primary controller of all of the units in the paralleled stack. The primary/secondary communication uses a digital RS485 bus. Connections are made using the supplied, shielded CAT6A cable as shown in the following figure. For further information about primary/secondary configurations, refer to [Parallel Operation](#).

The figure also shows the termination switch settings for the paralleled stack. The unit designated as the primary unit must be located at one end of the parallel stack with its switch set as shown in the "Primary termination" figure. The other end unit in the stack must have its switch set as shown in the "End termination" figure. The switches of the in-between units must be set as shown under "Unterminated". If only two units are connected in a primary/secondary configuration, one unit must have its switches set as the primary, and the other must have its switches set as the end units. A current-sharing fault (CSF) may occur if the switches are set incorrectly.

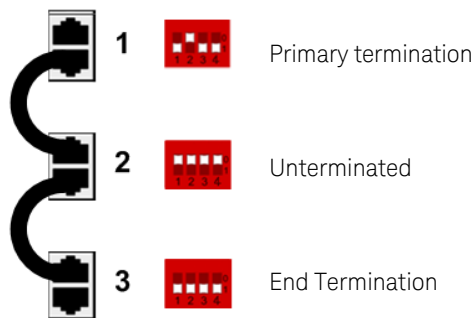

Do not install units into a primary/secondary configuration that are not actively being used as part of the primary/secondary group.

## Series Connections

Series connections are not permitted under any circumstances.

### **WARNING**

**SHOCK HAZARD/LETHAL VOLTAGES** Series connections are not permitted for many reasons. One reason is that exceeding the maximum float voltages ratings given in the characteristics tables is extremely dangerous and it is impossible to guarantee safe voltage balance when using bidirectional instruments in series.

---

## Interface Connections

### GPIB Connections

### USB Connections

### LAN Connections - site and private

### Digital Port Connections

### Interface Cover Installation

This section describes how to connect to the various communication interfaces on your unit. For further information about configuring the remote interfaces, refer to **Remote Interface Configuration**.

If you have not already done so, install the latest Keysight IO Libraries Suite from [www.keysight.com](http://www.keysight.com).

**NOTE**

For detailed information about interface connections, refer to the documentation included with the Keysight IO Libraries Suite.

## GPIB Connections

The following figure illustrates a typical GPIB interface system.

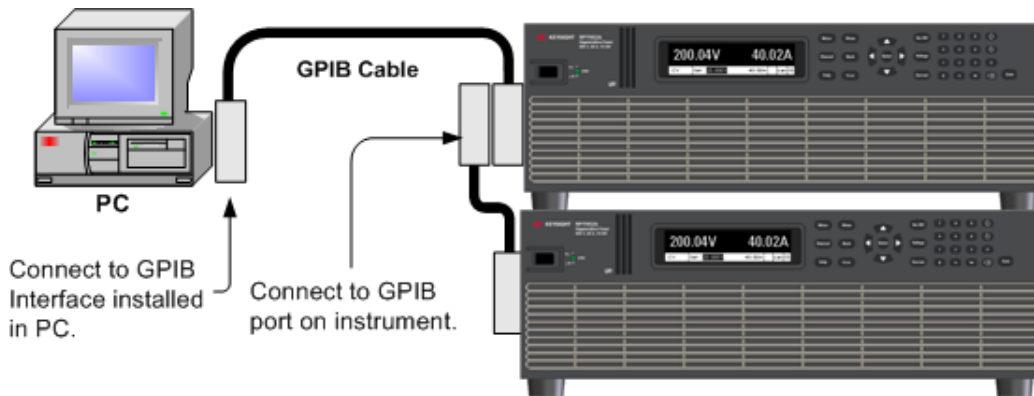

1. Connect your instrument to the GPIB interface card using a GPIB interface cable.
2. Use the Connection Expert utility of the Keysight IO Libraries Suite to configure the GPIB card's parameters.
3. You can now use Interactive IO within the Connection Expert to communicate with your instrument, or you can program your instrument using the various programming environments.

## USB Connections

The following figure illustrates a typical USB interface system.

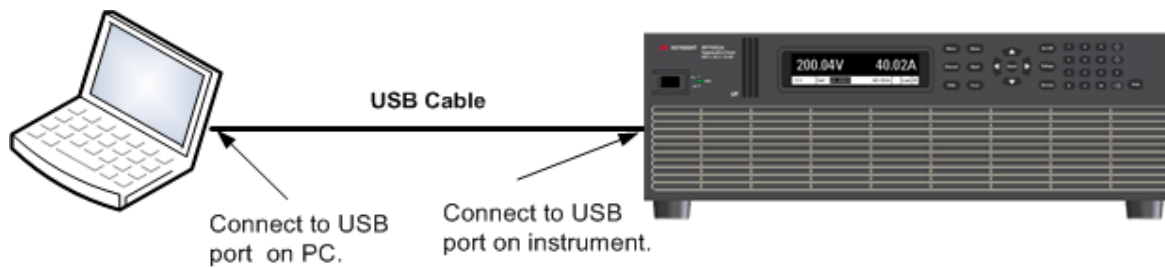

1. Connect your instrument to the USB port on your computer.
2. With the Connection Expert utility of the Keysight IO Libraries Suite running, the computer will automatically recognize the instrument. This may take several seconds. When the instrument is recognized, your computer will display the VISA alias, IDN string, and VISA address. This information is located in the USB folder.
3. You can now use Interactive IO within the Connection Expert to communicate with your instrument, or you can program your instrument using the various programming environments.

### LAN Connections - site and private

A site LAN is a local area network in which LAN-enabled instruments and computers are connected to the network through routers, hubs, and/or switches. They are typically large, centrally-managed networks with services such as DHCP and DNS servers. The following figure illustrates a typical site LAN system.

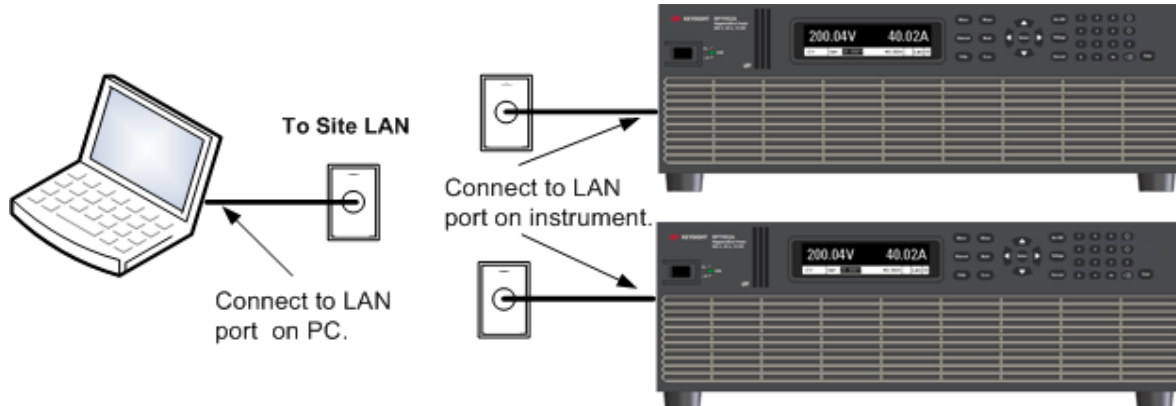

A private LAN is a network in which LAN-enabled instruments and computers are directly connected, and not connected to a site LAN. They are typically small, with no centrally-managed resources. The following figure illustrates a typical private LAN system.

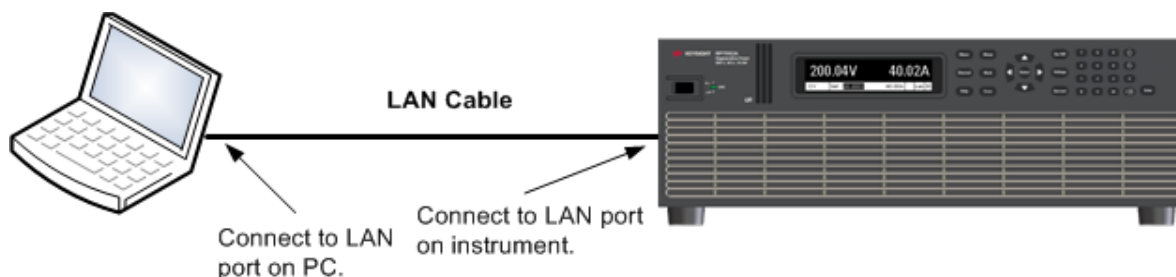

## 2 Installing the Instrument

1. Connect the instrument to the site LAN or to your computer using a LAN cable. The as-shipped instrument LAN settings are configured to automatically obtain an IP address from the network using a DHCP server (DHCP is set On). The DHCP server will register the instrument's hostname with the dynamic DNS server. The hostname as well as the IP address can then be used to communicate with the instrument. If you are using a private LAN, you can leave all LAN settings as they are. Most Keysight products and most computers will automatically choose an IP address using auto-IP if a DHCP server is not present. Each assigns itself an IP address from the block 169.254.nnn. The front panel **Lan** indicator will come on when the LAN port has been configured.
2. Use the Connection Expert utility of the Keysight IO Libraries Suite to add the instrument and verify a connection. To add the instrument, you can request the Connection Expert to discover the instrument. If the instrument cannot be found, add the instrument using the instrument's hostname or IP address.
3. You can now use Interactive IO within the Connection Expert to communicate with your instrument, or you can program your instrument using the various programming environments. You can also use the Web browser on your computer to communicate with the instrument as described under [Using the Web Interface](#).

### Digital Port Connections

#### NOTE

It is good engineering practice to twist or shield all signal wires to and from the digital connector. If shielded wire is used, connect only one end of the shield to chassis ground to prevent ground loops.

An 8-pin connector and a quick-disconnect connector plug are provided for accessing the digital port functions. Disconnect the connector plug to make your wire connections. The connector plug accepts wires sizes from AWG 14 (1.5 mm<sup>2</sup>) to AWG 28 (0.14 mm<sup>2</sup>). Wire sizes smaller than AWG 24 (0.25 mm<sup>2</sup>) are not recommended. Strip wire insulation back 7 mm.

1. Insert wires
2. Tighten screws
3. Fault/Inhibit configurable pins (observe INH polarity)
4. Output Couple configurable pins
5. Digital IO-configurable pins
6. Signal common

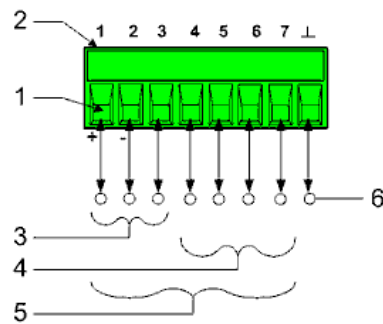

Information on using the digital port is found under [Programming the Digital Port](#). The electrical characteristics are described in the [Common Characteristics](#) tables.

## Interface Cover Installation

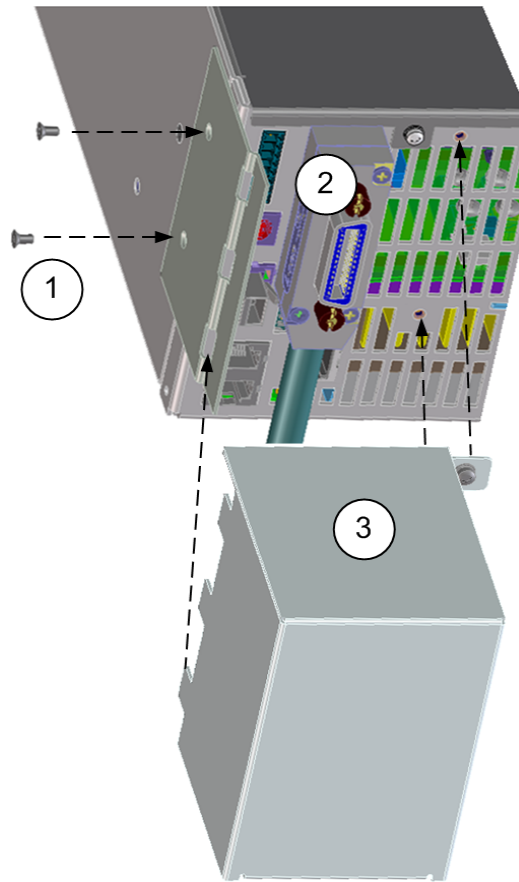

The ESD cover and hardware are shipped with the unit (see **Items Supplied**).

1. Connect the cover flange to the side of the instrument using the two screws provided. **IMPORTANT** - This must be done *before* rack mounting the unit.
2. Connect the LAN, USB, GPIB cable, and digital IO wires (GPIB shown) to the appropriate rear panel connector.
3. Insert the cover tabs into the flange. Attach the ESD cover to the back of the unit using the two captive cover screws.



# 3

## Getting Started

**Using the Front Panel**

**Remote Interface Configuration**

## Using the Front Panel

**Turn the Unit On**

**Set the Output Voltage**

**Set the Output Current**

**Set Over-voltage Protection**

**Enable the Output**

**Use Built-in Help System**

### Turn the Unit On

**WARNING**

**SHOCK HAZARD, LETHAL VOLTAGES** - Many models generate output voltages up to 2,000 VDC! Ensure that all instrument connections, load wiring, load and sense connections are insulated using high-voltage wire. Always attach the safety cover provided, so that no accidental contact with lethal voltages can occur.

---

Verify that the line cord is connected and plugged in.

Turn the unit on with the front panel power switch. The front panel display will light up after a few seconds. A power-on self-test occurs automatically when you turn the unit on. This test assures you that the power supply is operational.

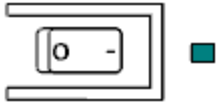

**NOTE**

It may take about 30 seconds or so for the power supply to initialize before it is ready for use.

---

If the instrument does not turn on, verify that the power cord is firmly connected (power-line voltage is automatically sensed at power-on). Also make sure that the instrument is connected to an energized power source. If the LED next to the power switch is off, there is no ac power connected. If the LED is amber, the instrument is in standby mode with ac power connected, and if it is green, the instrument is on.

**NOTE**

If a self-test error occurs, a message is displayed on the front panel. For other self-test errors, see **Service and Maintenance** for instructions on returning the instrument for service.

---

### Set the Output Voltage

#### Method 1



Use the left and right navigation keys to navigate to the setting that you wish to change.

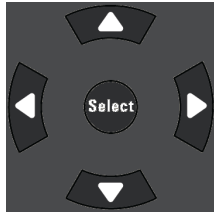

In the following display, the voltage setting is selected. Enter a value using the numeric keypad. Then press **Select**.



You can also use the numeric arrow keys to adjust the value up or down. Values become effective when the output is turned on.

In voltage priority mode, the unit will maintain the output voltage at its programmed setting. In current priority mode, the unit will limit the output voltage when it reaches the specified voltage limit value. Refer to **Set the Output Mode** for more information.

## Method 2

Use the **Voltage** key to select the voltage entry field. In the display below, the voltage setting is selected. Enter the desired setting using the numeric keypad. Then press **Enter**.



If you make a mistake, either use the backspace key to delete the number, press **Back** to back out of the menu, or press **Meter** to return to meter mode.

## Set the Output Current

### Method 1

Use the left and right navigation keys to navigate to the setting that you wish to change.

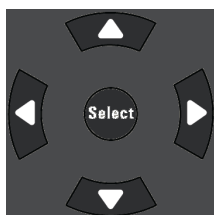

### 3 Getting Started

In the display below, the current limit setting is selected. Use the up and down navigation keys to toggle between the + and - limit entries. Enter a value using the numeric keypad. Then press **Select**.



You can also use the numeric arrow keys to adjust the value up or down. You can set both positive and negative current values. Values become effective when the output is turned on.

In current priority mode, the unit will maintain the output current at its programmed setting. In voltage priority mode, the unit will limit the output current when it reaches the specified current limit value. Refer to **Set the Output Mode** for more information.

#### Method 2

Use the **Current** key to select the current entry field. In the display below, the current setting is selected. Enter the desired setting using the numeric keypad. Then press **Enter**.

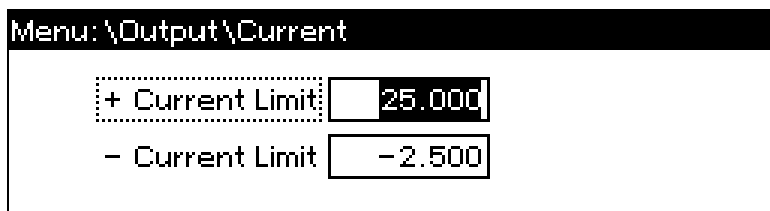

If you make a mistake, either use the backspace key to delete the number, press **Back** to back out of the menu, or press **Meter** to return to meter mode.

### Set Over-voltage Protection

#### Using the front panel menu.

The front panel command menu lets you access most of the instrument's functions. The actual function controls are located at the lowest menu level. Briefly:

- Press the **Menu** key to access the command menu.
- Press the left and right (<, >) navigation keys to move across the menu commands.
- Press the center **Select** key to select a command and move down to the next level in the menu.
- Press the **Help** key at the lowest menu level to display help information about the function controls.
- To exit the command menu press the **Meter** key to immediately return to meter mode, or press the **Menu** key to return to the top level.

For a map of the front panel menu commands, refer to **Front Panel Menu Reference**.

Menu example - setting over-voltage protection.

Press the **Menu** key to access the front panel command menu. The first line identifies the menu path. When the menu is first accessed, the menu is at the top or root, and the path is empty. The second line indicates the commands that are available at the present menu level. In this case, the top-level menu commands are shown, with the Output command highlighted. The third line indicates which commands are available under the Output command. If there are no lower level commands, a brief description of the highlighted command is displayed.

```
Menu:\
Output Measure Transient Protect States System
Voltage, Current, Mode, Sequence, Advanced
```

Press the right arrow navigation key > to traverse the menu until the Protect command is highlighted. Press the **Select** key to access the Protect commands.

```
Menu:\
Output Measure Transient Protect States System
OVP, UVP, OCP, Inhibit, WDog, Clear
```

Since the OVP command is already highlighted, press the Select key to access the OVP dialog.

```
Menu:\Protect
OVP UVP OCP Inhibit WDog Clear
Overvoltage protection settings.
```

The default OVP setting for all models is 120% of the output rating. You can change the OVP setting using the numeric entry keys and pressing **Enter** and **Select**. Press the **Meter** key to return to meter view.

```
Menu:\Protect\OVP
OVP Level: 2400.0
```

## Enable the Output

### **WARNING**

**SHOCK HAZARD, LETHAL VOLTAGES** - Many models generate output voltages up to 2,000 VDC! Ensure that all instrument connections, load wiring, load and sense connections are insulated using high-voltage wire. Always attach the safety cover provided, so that no accidental contact with lethal voltages can occur.

### 3 Getting Started

Use the **On/Off** key to enable the output. If a load is connected to the output, the front panel display will indicate that it is drawing current. Otherwise, the current reading will be zero. The status indicator shows the output's status. In this case, "CV" indicates the output is in constant voltage mode.

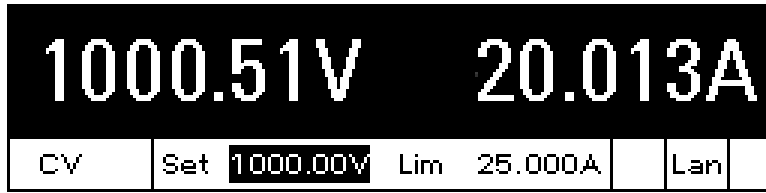

For a description of the status indicators, refer to [Front Panel Display at a Glance](#).

#### Use Built-in Help System

Press the **Help** key at the lowest menu level to display help information about the menu function controls.

Whenever a limit is exceeded or any other invalid configuration is found, the instrument will display a message, including Error code information.

Press **Meter** or **Back** to exit Help.

## Remote Interface Configuration

**USB Configuration**

**GPIB Configuration**

**LAN Configuration**

**Modifying the LAN Settings**

**Using the Web Interface**

**Using Telnet**

**Using Sockets**

**Interface Lockout**

### Introduction

This instrument supports remote interface communication over three interfaces: GPIB, USB, and LAN. All three interfaces are "live" at power up. To use the interfaces, you must first install the latest Keysight IO Libraries Suite from [www.keysight.com](http://www.keysight.com). Then connect your instrument to your PC.

The front panel **IO** indicator comes on whenever there is activity on the remote interfaces. The front panel **Lan** indicator comes on when the LAN port is connected and configured.

This instrument provides Ethernet connection monitoring. With Ethernet connection monitoring, the instrument's LAN port is continually monitored, and automatically reconfigured when the instrument is unplugged for a minimum of 20 seconds and then reconnected to a network.

### USB Configuration

There are no configurable USB parameters. You can retrieve the USB connect string using the front panel menu:

Front Panel Menu Reference	SCPI Command
Select <b>System\IO\USB</b> The dialog displays the USB connect string.	Not available

### GPIB Configuration

Each device on the GPIB (IEEE-488) interface must have a unique whole number address between 0 and 30. The instrument ships with the address set to 5. Your computer's GPIB interface card address must not conflict with any instrument on the interface bus. This setting is non-volatile; it will not be changed by power cycling or \*RST. Use the front panel menu to change the GPIB address:

Front Panel Menu Reference	SCPI Command
Select <b>System\IO\GPIOB</b> . Use the numeric keys to enter a new value from 0 to 30. Then press <b>Enter</b> .	Not available

## LAN Configuration

The following sections describe the primary LAN configuration functions on the front-panel menus. Note that there are no SCPI commands to configure the LAN parameters. All LAN configuration must be done from the front panel.

### NOTE

After changing the LAN settings, you must Save the changes. Select: **System\IO\LAN\Apply**. Selecting Apply activates the settings. LAN settings are non-volatile, they will not be changed by power cycling or \*RST. If you do not want to save your changes select: **System\IO\LAN\Cancel**. Selecting Cancel cancels all changes.

When shipped, DHCP is on, which may enable communication over LAN. The letters DHCP stands for Dynamic Host Configuration Protocol, a protocol for assigning dynamic IP addresses to devices on a network. With dynamic addressing, a device can have a different IP address every time it connects to the network.

## Viewing Active Settings

To view the currently active LAN settings:

Front Panel Menu Reference	SCPI Command
Select <b>System\IO\LAN\Settings</b> . Displays the active LAN settings. Use the up and down arrow key to scroll through the list.	Not available

The currently active settings for the IP Address, Subnet Mask, and Default Gateway may be different from the front panel configuration menu settings - depending on the configuration of the network. If the settings are different, it is because the network has automatically assigned its own settings

## Resetting the LAN

Resetting the LAN performs a LAN Configuration Initialize (LCI) reset of the instrument which enables DHCP, DNS and ping. It also resets the web site password to the factory default password. This does not reset the hostname or the mDNS service name.

You can also reset the LAN to the as-shipped (default) settings. This returns **ALL** LAN settings to the as-shipped values and restarts networking. All default LAN settings are listed under **Non-volatile Settings**.

Front Panel Menu Reference	SCPI Command
Select <b>System\IO\LAN\Reset</b>	Not available
Select <b>System\IO\LAN\Defaults</b>	
Selecting Reset activates the selected LAN settings and restarts networking.	

## Modifying the LAN Settings

### IP Address

Select IP to configure the addressing of the instrument. Press the **Menu** key, then select **System\IO\LAN\Config\IP**. The configurable parameters include:

Front Panel Menu Reference	SCPI Command
Select <b>System\IO\LAN\Modify\IP</b>	Not available
Select Auto or Manual. See below for a full description.	

- **Auto** - automatically configures the addressing of the instrument. When selected, the instrument will first try to obtain an IP address from a DHCP server. If a DHCP server is found, the DHCP server will assign an IP address, Subnet Mask, and Default Gateway to the instrument. If a DHCP server is unavailable, the instrument will try to obtain an IP address using AutoIP. AutoIP automatically assigns an IP address, Subnet Mask, and Default Gateway addresses on networks that do not have a DHCP server.
- **Manual** - allows you to manually configure the addressing of the instrument by entering values in the following three fields. These fields only appear when Manual is selected.
- **IP Address** - This value is the Internet Protocol (IP) address of the instrument. An IP address is required for all IP and TCP/IP communications with the instrument. An IP Address consists of 4 decimal numbers separated by periods. Each decimal number ranges from 0 through 255 with no leading zeros (for example, 169.254.2.20).
- **Subnet Mask** - This value is used to enable the instrument to determine if a client IP address is on the same local subnet. The same numbering notation applies as for the IP Address. When a client IP address is on a different subnet, all packets must be sent to the Default Gateway.
- **DEF Gateway** - This value is the IP Address of the default gateway that allows the instrument to communicate with systems that are not on the local subnet, as determined by the subnet mask setting. The same numbering notation applies as for the IP Address. A value of 0.0.0.0 indicates that no default gateway is defined.

Dot-notation addresses ("nnn.nnn.nnn.nnn" where "nnn" is a byte value from 0 to 255) must be expressed with care, as most PC web software interprets byte values with leading zeros as octal (base 8) numbers. For example, "192.168.020.011" is actually equivalent to decimal "192.168.16.9" because ".020" is interpreted as "16" expressed in octal, and ".011" as "9". To avoid confusion, use only decimal values from 0 to 255, with no leading zeros.

## Host Name

A hostname is the host portion of the domain name, which is translated into an IP address. To configure the hostname of the instrument:

Front Panel Menu Reference	SCPI Command
Select <b>System\IO\LAN\Modify\Name</b>	Not available
<p>You can enter any value from the numeric keypad. For additional characters, use the up/down navigation keys to enter an alpha character by scrolling through the selection list that appears when you press the keys. Use the left/right navigation keys to traverse the text field. Use the backspace key to delete a value. Press Enter when you are finished.</p>	

The **Host Name** field registers the supplied name with the selected naming service. If the field is left blank, no name is registered. A hostname may contain upper and lower case letters, numbers and dashes (-). The maximum length is 15 characters.

Each instrument is shipped with a default hostname with the format: K-modelnumber-serialnumber, where modelnumber is the unit's 7-character model number (e.g. RP7972A), and serialnumber is the last five characters of the 10-character serial number located on the label on the top of the unit (e.g. 45678 if the serial number is MY12345678).

## DNS Server

DNS is an internet service that translates domain names into IP addresses. It is also needed for the instrument to find and display its hostname assigned by the network. Normally, DHCP discovers the DNS address information; you only need to change this if DHCP is unused or not functional.

To manually configure the DNS services:

Front Panel Menu Reference	SCPI Command
Select <b>System\IO\LAN\Modify\DNS</b>	Not available
<p>Select Primary Address or Secondary Address. See below for a full description.</p>	

- **Primary Address** - This field enters the primary address of the server. Contact your LAN administrator for server details. The same numbering notation applies as for the IP Address. A value of 0.0.0.0 indicates that no default server is defined.
- **Secondary Address** - This field enters the secondary address of the server. Contact your LAN administrator for server details. The same numbering notation applies as for the IP Address. A value of 0.0.0.0 indicates that no default server is defined.

Dot-notation addresses ("nnn.nnn.nnn.nnn" where "nnn" is a byte value from 0 to 255) must be expressed with care, as most PC web software interprets byte values with leading zeros as octal (base 8) numbers. For example, "192.168.020.011" is actually equivalent to decimal "192.168.16.9" because ".020" is interpreted as "16" expressed in octal, and ".011" as "9". To avoid confusion, use only decimal values from 0 to 255, with no leading zeros.



## mDNS Service Name

The mDNS service name is registered with the selected naming service. To configure the mDNS service name of the instrument:

Front Panel Menu Reference	SCPI Command
Select <b>System\IO\LAN\Modify\mDNS</b>	Not available
<p>You can enter any value from the numeric keypad. For additional characters, use the up/down navigation keys to enter an alpha character by scrolling through the selection list that appears when you press the keys. Use the left/right navigation keys to traverse the text field. Use the backspace key to delete a value. Press Enter when you are finished.</p>	

- **mDNS Service Name** - This field registers the service name with the selected naming service. If the field is left blank, no name is registered. A service name may contain upper and lower case letters, numbers and dashes(-).
- Each instrument is shipped with a default service name with the format: Keysight-modelnumber-description-serialnumber, where modelnumber is the unit's 7-character model number, description is the description, and serialnumber is the 10-character serial number located on the label on the top of the unit (e.g. MY12345678).

## Services

This selects the LAN services to enable or disable.

Front Panel Menu Reference	SCPI Command
Select <b>System\IO\LAN\Modify\Services</b>	Not available
<p>Check or uncheck the services that you wish to enable or disable.</p>	

- The configurable services include: VXI-11, Telnet, Web control, Sockets, mDNS, and HiSLIP.
- You must enable Web control if you wish to remotely control your instrument using its built-in Web interface.

## Using the Web Interface

Your instrument has a built-in Web interface that lets you control it directly from the Web browser on your computer. With the Web interface, you can access the front panel control functions including the LAN configuration parameters. Up to six simultaneous connections are allowed. With additional connections, performance will be reduced.

### NOTE

The built-in Web interface only operates over the LAN. A Web browser is required to use the Web Interface.

The Web interface is enabled when shipped. To launch the Web interface:

### 3 Getting Started

1. Open the Web browser on your computer.
2. Enter the instrument's hostname or IP address into the browser's Address field. The following home page will appear.
3. Click on the Web Control tab on the top of the page to begin controlling your instrument.
4. For additional help about any of the pages, click on the ?.

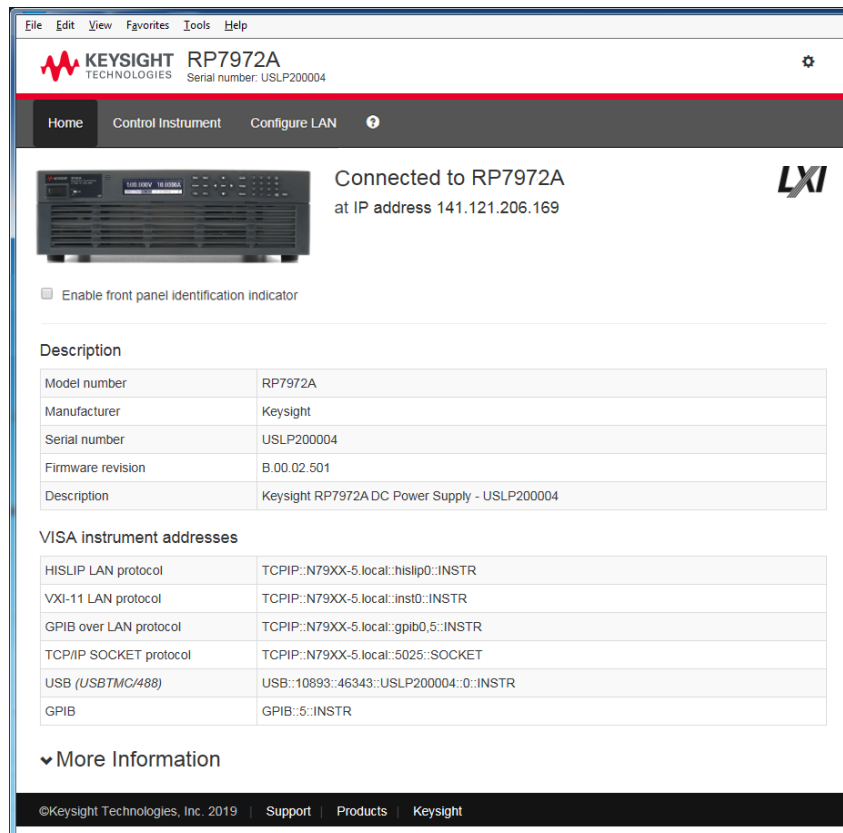

If desired, you can control access to the Web interface using password protection. As shipped, no password is set. To set a password, click on the Settings (gear) icon. Refer to the on-line help for additional information about setting a password.

### Using Telnet

#### NOTE

Power supplies allow any combination of up to six simultaneous telnet, data socket, and control socket connections to be made.

In an MS-DOS Command Prompt box type: telnet hostname 5024 where hostname is the unit's hostname or IP address, and 5024 is the instrument's telnet port.

You should get a Telnet session box with a title indicating that you are connected to the power supply. Type the SCPI commands at the prompt.

## Using Sockets

Keysight instruments have standardized on using port 5025 for SCPI socket services. A data socket on this port can be used to send and receive ASCII/SCPI commands, queries, and query responses. All commands must be terminated with a newline for the message to be parsed. All query responses will also be terminated with a newline.

The socket programming interface also allows a control socket connection. The control socket can be used by a client to send device clear and to receive service requests. Unlike the data socket, which uses a fixed port number, the port number for a control socket varies and must be obtained by sending the following SCPI query to the data socket: **SYSTem:COMMunicate:TCPIP:CONTRol?**

After the port number is obtained, a control socket connection can be opened. As with the data socket, all commands to the control socket must be terminated with a newline, and all query responses returned on the control socket will be terminated with a newline.

To send a device clear, send the string “DCL” to the control socket. When the power supply has finished performing the device clear it echoes the string “DCL” back to the control socket.

Service requests are enabled for control sockets using the Service Request Enable register. Once service requests have been enabled, the client program listens on the control connection. When SRQ goes true the instrument will send the string “SRQ +nn” to the client. The “nn” is the status byte value, which the client can use to determine the source of the service request.

## Interface Lockout

The USB interface, LAN interface, and the Web server are enabled when shipped. To enable or disable the interfaces from the front panel:

Front Panel Menu Reference	SCPI Command
Select <b>System\Admin\IO</b>	Not available
Enable or disable the interfaces by checking or unchecking the following items:	
Enable LAN, Enable GPIB, and Enable USB	

If you cannot access the Admin menu, it may be password protected.



# 4

## Using the Regenerative Power System

**Programming the Output**

**Parallel Operation**

**Current Sinking Operation**

**Programming Output Protection**

**Programming Output Transients**

**Sequencing the Output**

**Making Measurements**

**External Data Logging**

**Programming the Digital Port**

**System-Related Operations**

**Priority Mode Tutorial**

**Photovoltaic Simulator Operation**

## Programming the Output

**Set the Output Priority Mode**

**Set the Output Voltage and Low Voltage Limit**

**Set the Output Current**

**Set the Slew Rate**

**Set the Output Resistance**

**Set the Output Bandwidth**

**Set the Output Turn-On/Turn-Off Mode**

**Enable the Output**

### WARNING

**SHOCK HAZARD, LETHAL VOLTAGES** - Many models generate output voltages up to 2,000 VDC! Ensure that all instrument connections, load wiring, load and sense connections are insulated using high-voltage wire. Always attach the safety cover provided, so that no accidental contact with lethal voltages can occur.

### NOTE

When the unit is first turned on, it may take about 30 seconds or so to initialize the instrument before it is ready for use.

## Set the Output Priority Mode

Select either voltage priority, current priority, or SAS operating mode. Refer to **Priority Mode Operation** for more information.

**Voltage priority** - this mode keeps the output voltage constant. The output voltage remains at its programmed setting, provided the load current remains within the + or - current limit setting.

**Current priority** - this mode keeps the output current constant. The output current remains at its programmed setting, provided the load voltage remains within the voltage limit setting.

**SAS mode** - selects solar array simulator operation. Refer to **Photovoltaic Simulator Operation** for details.

Front Panel Menu Reference	SCPI Command
Select <b>Output\Mode</b> . Select Voltage or Current priority. Then press <b>Select</b> .	To specify current or voltage priority mode: <b>FUNC CURR VOLT</b>

### NOTE

When switching between modes, the output is turned off and the output settings revert to their power-on or RST values.

## Set the Output Voltage

When the unit is in voltage priority mode, the output voltage remains at its programmed setting as long as the load current remains within its programmed positive or negative limit.

Front Panel Menu Reference	SCPI Command
Press the <b>Voltage</b> key. Enter a value and press Select.	To set the output voltage to 400 volts: <b>VOLT 400</b>

When the unit is in current priority mode, you can specify a voltage limit which limits the output voltage at the specified value. The output current remains at its programmed setting, provided the load voltage remains within the voltage limit setting.

Front Panel Menu Reference	SCPI Command
Press the <b>Voltage</b> key. Specify a + Voltage limit. Then press <b>Select</b> .	To set the voltage limit: <b>VOLT:LIM 420</b>

## Set the Low Voltage Limit

Sets the low voltage limit when in current priority mode. This prevents the voltage from dropping below the low voltage limit when discharging a battery. When the low voltage limit is reached, the unit transitions from current priority mode to low voltage limit mode, which stops discharging the battery. The low voltage limit is annunciated by the **VL-** status bit.

The low voltage limit also prevents the output from turning on when the output voltage is below the programmed low voltage limit. If you need to turn the output on, you must first disable the low voltage limit. Note that this feature is different from the **under-voltage protection** function.

Front Panel Menu Reference	SCPI Command
Press the <b>Voltage</b> key. The Low Voltage Limit field only appears when the unit is set to operate in Current Priority mode.	To set the low voltage limit: <b>VOLT:LIM:LOW 4</b>
Specify the low voltage limit. Then check Enable (uncheck to disable). Then press <b>Select</b> .	To enable the low voltage limit: <b>VOLT:LIM:LOW:STAT ON</b>

## Set the Output Current

When the unit is in voltage priority mode, you can specify a positive and negative current limit, which limits the output current at the specified value.

Front Panel Menu Reference	SCPI Command
Press the <b>Current</b> key.	To set the positive current limit: <b>CURR:LIM 12</b>
Specify a positive or negative Current limit. Then press <b>Select</b> .	To set the negative current limit: <b>CURR:LIM:NEG -3</b>

## 4 Using the Regenerative Power System

When the unit is in current priority mode, you can specify a positive or negative output current level, which will be maintained as long as the output voltage remains within its programmed limit.

Front Panel Menu Reference	SCPI Command
Press the <b>Current</b> key.	To set the current to +5 amperes: <b>CURR 5</b>
Enter a positive or negative value. Then press <b>Select</b> .	To set the current to -5 amperes: <b>CURR -5</b>

### Set the Slew Rate

The voltage slew rate determines the rate at which the voltage changes to a new setting. This only applies to voltage settings while operating in voltage priority mode. When set to MAXimum, INFINITY, or to a very large value, the slew rate will be limited by the unit's listed programming speed and bandwidth. This setting can be used to prevent crossover into current limit while up- and down-programming capacitive loads, or to limit programming response to a controlled rate. Use the following equation to calculate the maximum slew rate limit to ensure smooth and linear up- and down-programming performance.

$$\text{Max slew rate (V/s)} = (\text{Current limit setting (A)} - \text{Load current (A)}) / (\text{Load capacitance (F)})$$

The current slew rate determines the rate at which the current changes to a new programmed setting. This only applies to current settings while operating in current priority mode. When set to MAXimum, INFINITY, or to a very large value, the slew rate will be limited by the unit's listed programming speed and bandwidth.

Front Panel Menu Reference	SCPI Command
Select <b>Output\Advanced\Slew</b> Then select Voltage or Current	To set the voltage slew rate to 5 V/s <b>VOLT:SLEW 5</b>
Enter the voltage or current slew rate in the Slew Rate field.	To set the current slew rate to 1 A/s <b>CURR:SLEW 1</b>
Check Max slew rate to program the fastest slew rate.	To set the fastest slew rate: <b>VOLT:SLEW MAX</b>

### Set the Output Resistance

Output resistance programming is mainly used in battery testing applications and only applies in voltage priority mode. It is used to emulate the internal resistance of a non-ideal voltage source such as a battery. Values are programmed in ohms. Refer to the **Supplemental characteristics** table for the model-specific resistance programming ranges.

Front Panel Menu Reference	SCPI Command
Select <b>Output\Advanced\Resistance</b> . Specify an Output Resistance value. Then check the <b>Enable</b> box. Then press <b>Select</b> .	To select a resistance of 0.5 ohms: <b>VOLT:RES 0.5</b>  To enable output resistance: <b>VOLT:RES:STAT ON</b>



**NOTE**

When units are connected in parallel, the maximum output resistance is reduced. The programmable resistance for a single unit must be divided by the total number of paralleled units.

## Set the Output Bandwidth

### Voltage compensation

Voltage compensation modes let you optimize output response time with capacitive loads. The **Capacitive Load Boundary** graphs in the Characteristics section illustrate the minimum ESR as a function of DUT capacitance to allow for stable operation. The **Output Impedance** graphs illustrate the effect that the compensation modes have on the small-signal output impedance.

**0 Fast** (high speed/small capacitive load) – provides the fastest programming speed and transient response time. Best suited for resistive DUTs with low capacitance. Default frequency = 5000 Hz.

**1 Medium** (medium speed/medium capacitive load) – provides intermediate programming speed and transient response time. Best suited for DUTs with higher capacitance with some trade-off in programming speed and transient response. Default frequency = 450 Hz.

**2 Slow** (slow speed/large capacitive load) – is best suited for DUTs with high capacitance/low ESR with the trade-off of slower programming speed and transient response. Default frequency = 12 Hz.

**<frequency>** specifies the low-pass corner frequency of a filter applied to the programming signal. The programmed voltage is a digitized signal which passes through a first-order low pass filter where the pole is specified in Hertz. This filter has the effect of slowing down the output with respect to changes in the programmed voltage or current.

Specifying the low-pass corner frequency of the filter, in combination with the configurable slew setting, allows for a trade-off between programming speed and output voltage or current overshoot. For example, raising the filter frequency increases the programming speed and decreases the settling time, which may result in output overshoot. Lowering the filter frequency will decrease the programming speed and increase the settling time, which reduces any output overshoot. The effect of adjusting the filter frequency also depends on the compensation setting and the load impedance. The filter frequency setting does not affect the unit's transient response to a load change.

The following table summarizes the effect that the compensation settings have on the CV Programming Speed Characteristics for all models.

Setting	Step Conditions	Frequency	Rise/fall time 10%-90% of step	Settling time to 0.1% of step
0 Fast	no load, 0.1%-100% of rating	100 kHz	0.2 ms	1 ms
1 Medium	no load, 0.1%-100% of rating	100 kHz	0.5 ms	2.5 ms
2 Slow	no load, 0.1%-100% of rating	100 kHz	33 ms	110 ms

The following table describes the CV small signal bandwidth characteristics for all models

## 4 Using the Regenerative Power System

CV programming small signal bandwidth (-3dB) at no load	
Setting	Frequency
0 Fast	2.5 kHz
1 Medium	1 kHz
2 Slow	350 Hz

Front Panel Menu Reference	SCPI Command
Select <b>Output\Advanced\Bandwidth\Voltage</b> . Select either 0, 1, or 2. If desired, enter the pole frequency in the Frequency field. Then press <b>Select</b> .	To set the voltage compensation bandwidth: <b>VOLT:BWID:RANG 0   1   2</b>  To specify the pole frequency: <b>VOLT:BWID:LEV 0   1   2, &lt;frequency&gt;</b>

### Current compensation

The current compensation provided is suited to handle a wide, range of total lead and DUT inductance with a relatively fast programming response (see **Inductance Load Boundary** graph). To reduce the impact of load lead inductance, paralleling additional sets of load leads to lower the net inductance can help, especially if load lead lengths are long.

**<frequency>** - specifies the low-pass corner frequency of a filter applied to the programming signal. Refer to the previous description under Voltage Compensation modes for a description of use case tradeoffs of changing the **<frequency>** setting.

The following table summarizes the effect that the compensation settings have on the CC Programming Speed Characteristics for all models.

Step Conditions	Frequency	Rise/fall time 10%-90% of step	Settling time to 0.1% of step
AC short at >10% Vrating, 0.1%-100% of rating	100 kHz	100 μs	200 μs

The CC programming small signal bandwidth characteristic at -3dB is 3.5 kHz for all models.

Front Panel Menu Reference	SCPI Command
Select <b>Output\Advanced\Bandwidth\Current</b> . There is only one compensation bandwidth. If desired, enter the pole frequency in the Frequency field. Then press <b>Select</b> .	To specify the pole frequency: <b>CURR:BWID:LEV 0, &lt;frequency&gt;</b>

### Set the Output Turn-On/Turn-Off Mode

#### NOTE

The turn-on/turn-off setting only applies when the unit is operating in voltage priority mode. In current priority mode, the turn-on/turn-off behavior is set to High impedance.

The voltage priority turn-on and turn-off behavior can be set to either high or low impedance mode.

**Low impedance** mode is for devices like power converters. During output transitions, current is sourced or discharged for fast output voltage response.

**High impedance** mode is for devices like batteries, where output transitions are controlled to minimize output current.

Front Panel Menu Reference	SCPI Command
Select <b>Output\Advanced\Tmode</b> .	To select high impedance turn-on: <b>OUTP:TMOD:ON HIGHZ</b>
Select either High impedance or Low impedance for turn-on and turn-off modes.	To select low impedance turn-off: <b>OUTP:TMOD:OFF LOWZ</b>
Check <b>Coupled</b> to couple the turn-on and turn-off modes. Then press <b>Select</b> .	To couple the turn-on and turn-off modes: <b>OUTP:TMOD:COUP ON</b>

## Enable the Output

**WARNING** SHOCK HAZARD, LETHAL VOLTAGES - Many models generate output voltages up to 2,000 VDC! Ensure that all instrument connections, load wiring, load and sense connections are insulated using high-voltage wire. Always attach the safety cover provided, so that no accidental contact with lethal voltages can occur.

Because of internal circuit start-up procedures and any installed relay options, OUTPut ON may take tens of milliseconds to complete its function. OUTPut OFF delays may also be in effect. For more information regarding output turn-on and turn-off delays, refer to **Turn-On/Turn-Off Delays**.

Front Panel Menu Reference	SCPI Command
Press the <b>On/Off</b> key.	<b>OUTP ON OFF</b>

In addition to the front panel and SCPI Output On and Output Off commands, you can also use OnCouple and OffCouple signals to enable and disable the output. Refer to **Output Couple Control** for more information. When coupling is enabled, changing the turn-on setting also changes the turn-off setting and vice-versa.

**NOTE** During a 1-cycle ac line dropout the unit may reboot. The output will remain off after reboot until the operator reinstates the previous settings, either by the front panel controls or using a computer program. This behavior is consistent with safe operating procedures.

## Parallel Operation

### Introduction

### Primary/Secondary Configuration

### Primary/Secondary Front Panel Display

### Primary/Secondary Programming Considerations

### Primary/Secondary Power Rating Considerations

### Primary/Secondary Command Details

### Troubleshooting

## Introduction

### WARNING

**SHOCK HAZARD** All paralleled units must be connected to ground through a grounded power cord at all times. Any interruption of the protective (grounding) conductor or disconnection of the protective earth terminal on any unit will cause a potential shock hazard that could result in injury or death.

---

### CAUTION

**To Prevent Possible Equipment Damage:**

- Connect no more than twenty units **of identical input and output voltage ratings**. All units must have the same voltage rating but current ratings can be different. All units must have the same version firmware. Refer to **Instrument Identification** for the firmware version.
  - Always turn the **ac power** on and off together. Never leave any units powered on while the others are turned off.
- 

Parallel operation lets you connect multiple power supplies together to create a system with higher total current and power. This applies for current sourcing as well as current sinking operation. In primary/secondary operation, the paralleled group is controlled through the primary unit, and appears as a single higher-power supply. The primary unit provides the aggregate of most source and measurement functions.

Remember to connect the primary/secondary cables and configure the termination switches before attempting to turn on and discover the secondary units (refer to **Multiple Unit Connections** for details).

## Primary/Secondary Configuration

The configuration procedure for primary/secondary operation is as follows:

- Configure one unit as the primary
- Configure the other units as secondary units with unique bus addresses

- Select the connection mode and auto-connect delay time
- Perform a one-time discovery on the primary - it saves the primary/secondary configuration
- At power-on, the primary can connect to the secondary units automatically or manually
- If the primary/secondary configuration is subsequently changed, it needs to be re-discovered

Configure each paralleled instrument as either a Primary or Secondary.

Front Panel Menu Reference	SCPI Command
Select <b>System\Group\Function</b> In the dialog box, select either Primary, Secondary, or None. Then press Select.	To configure the paralleled unit: <b>INST:GRO:FUNC PRIM SEC NON</b>

If the unit is the primary, a delay may be programmed to allow the secondary units enough time to boot up before the primary auto-connects to the secondary. If there is a delay in powering up the secondary units, the primary auto-connect may fail. "None" is for non-paralleled operation. Do not connect units configured as None to the primary/secondary bus; this may cause a CSF fault.

Front Panel Menu Reference	SCPI Command
Select <b>System\Group\Delay</b> In the dialog box, set the auto-connect delay. Then press Select.	To set the auto-connect delay to 10: <b>INST:GRO:PRIM:DEL 10</b>

If the unit is a secondary, each secondary unit must be assigned a unique bus address (from 1 - 19).

Front Panel Menu Reference	SCPI Command
Select <b>System\Group\Secondary</b> In the dialog box, select the address of the secondary unit. Values can range from 1 - 19. Then press Select.	To set the Secondary address to 1: <b>INST:GRO:SEC:ADDR 1</b>

Specify the primary unit's connection mode.

**AUTO** - the primary unit will automatically connect to the previously discovered secondary units at power-on.

**MANual** - the primary will connect to the previously discovered secondary units when it receives a connection command from the front panel or from **INST:GRO:PRIM:CONN:MODE MAN**.

Front Panel Menu Reference	SCPI Command
Select <b>System\Group\Mode</b> In the dialog box, select the connection mode. Then press Select.	Set the primary unit's connection mode: <b>INST:GRO:PRIM:CONN:MODE AUTO</b>

After the secondary unit address configuration, run "Discover" on the primary unit to initiate communication with all secondary units. After initial discovery, the discovery process does not need to be run again unless the primary/secondary configuration changes.

## 4 Using the Regenerative Power System

Front Panel Menu Reference	SCPI Command
Select <b>System\Group\Discover</b> In the dialog box select Discover to discover all secondary units. Then press Select.	To discover the secondary units: <b>INST:GRO:PRIM:DISC</b>

To manually connect the primary unit to all previously discovered secondary units.

Front Panel Menu Reference	SCPI Command
Select <b>System\Group\Connect</b> In the dialog box select Connect to connect all secondary units to the primary. Then press Select.	To connect the primary unit to all discovered secondary units: <b>INST:GRO:PRIM:CONN</b>

### Primary/Secondary Front Panel Display

The current value read from the front panel of the primary unit is the aggregate of the values of the primary and the secondary units. The secondary units return their individual current values.

The following example illustrates the front panel displays during primary/secondary operation. Three units are connected in in a primary/secondary configuration. The units are operating in voltage priority mode.

**This is the 20 kW primary unit.**

"P" indicates the primary unit. The current displayed (30 A) is the total output current of all paralleled units. This unit is only contributing 10 A to the total.



**This is the 20 kW secondary unit.**

"S" indicates a secondary unit. The current displayed (10 A) is the current that this unit is contributing to the total.



**This is the 20 kW secondary unit.**

"S" indicates a secondary unit. The current displayed (10 A) is the current that this unit is contributing to the total.



### Primary/Secondary Programming Considerations

Program the output voltage and current settings of the primary unit the same as you would an individual unit. The current limits will reflect the total capacity of the paralleled units. Refer to **Set the Output Voltage** and **Set the Output Current** for details. The secondary units are locked; you cannot program the settings of the secondary units.

Set both positive and negative current limits high to allow extra headroom for both up- and down-programming transient dynamics. Transient dynamics are mainly a result of DUT capacitance charging currents. Note that the primary unit's current limit and current setting are automatically proportioned among the paralleled group according to the current rating of each unit.

Reduce the slew rates to mitigate imperfect voltage programming synchronization. By default, the slew rates are set to their maximum values.

**NOTE**

In current priority mode, set the output current of the primary unit to the desired value. Set the voltage limit to a higher value than the expected operating voltage of the unit.

---

### Operation at Maximum Current

Due to individual circuit tolerances between the paralleled units in a primary/secondary configuration, the current contributed by each unit may differ slightly from the ideal amount, which assumes that all units share current equally. When operating at the maximum current rating of the paralleled group, these individual circuit tolerances could cause one or more of the units to depart from CV operation and enter into  $\pm$  current limit. The maximum current rating of the group will still be available, but the dynamic transient response may change due to the transition of one of the units into current limit.

If strict CV operation is required under all operating conditions, especially at the maximum current rating of the paralleled group, it is recommended to set the current limit to the maximum programmable value on the primary unit. If this is not sufficient, reduce the total requested load current, or consider adding an extra unit to provide additional headroom for the group to maintain CV operation under maximum load conditions.

### Current Level Triggers

Current level triggers (see **TRIGger:ACQuire:CURRent**) are available in primary/secondary mode but may have performance limitations. The measured current on the primary unit generates the measurement trigger. Since current sharing between units may be temporarily degraded during fast load current changes, the trigger timing could be affected. Therefore, this feature must be characterized on a user's configuration to determine if the performance is sufficient. These limitations do not apply when the output current is stable or the current change is relatively slow.

### Primary/Secondary Communication

While connected, the primary unit periodically polls the secondary units for status. If communication with any secondary fails, for example if a secondary unit is turned on or off, the primary and remaining secondary units go into primary/secondary protection (PSP). When the remaining secondary units detect that the primary has disconnected, they also go into PSP. Additionally, a current-sharing fault (CSF) will likely occur if the **termination switches** are not set correctly.

Secondary units use the periodic primary status poll as a timer to trip PSP. If the secondary does not receive a status poll every 10 seconds or less, it goes into PSP.

Secondary units may go into PSP 10 seconds after power-on. Once these units are discovered, the primary unit will establish communication with the secondary units, thereby clearing the PSP.

### Primary/Secondary Protection

If the primary unit goes into protection, it sends a protection command to the secondary units. The primary unit indicates the type of protection event that has occurred. The secondary units indicate

## 4 Using the Regenerative Power System

PROT. Once the protection condition is corrected, clearing protection on the primary clears protection on all units (see **Clearing Protection**).

If a secondary unit goes into protection, the primary and the secondary unit on which the protection event occurred indicate the type of protection event. All other secondary units indicate PROT. Once the protection condition is corrected, clearing protection on the primary clears protection on all units.

When using the **Fault** or **Inhibit** functions on the rear panel digital connector, connect the Fault/Inhibit pins only on the primary unit. You do not need to connect the Fault/Inhibit pins of the secondary units.

### Primary/Secondary Power Rating Considerations

#### CAUTION

Connect no more than twenty units of identical input and output voltage ratings.

---

The following special considerations apply when paralleling units with unequal power ratings.

While it is possible to parallel 20 kW and 30 kW units, the paralleling system operates on output current - not output power. The output current is divided between the Primary and Secondary units in proportion to the maximum output current capability of each unit. Some 30 kW models have different auto-ranging characteristics than their 20 kW counterparts. When operating in a parallel configuration these units (either the 20 kW or the 30 kW units) will reach their maximum output current limits before achieving their maximum power limit. If the maximum output current limit is exceeded, the over-power protection (OP+ or OP-) will trip.

If necessary, the full power output may be achieved by disabling the Primary/Secondary groups and operating the units separately. Set the larger unit for CV operation and the smaller one for CC to provide additional current. Units of different maximum voltages must never be paralleled.

#### Power Limitation when paralleling 2 kV, 20 kW units with 2 kV, 30 kW units

The following graph illustrates the Power Limitation when paralleling one 2 kV, 20 kW unit with one 2 kV, 30 kW unit.

When using a parallel configuration to current-share among mixed 2 kV models, the 20 kW units can generate their full output power, but the 30 kW units are limited to 20 kW. This is shown by the green portion of the graph, which illustrates that 10 kW are unavailable. Therefore, a power limitation of 40 kW applies to this parallel configuration.



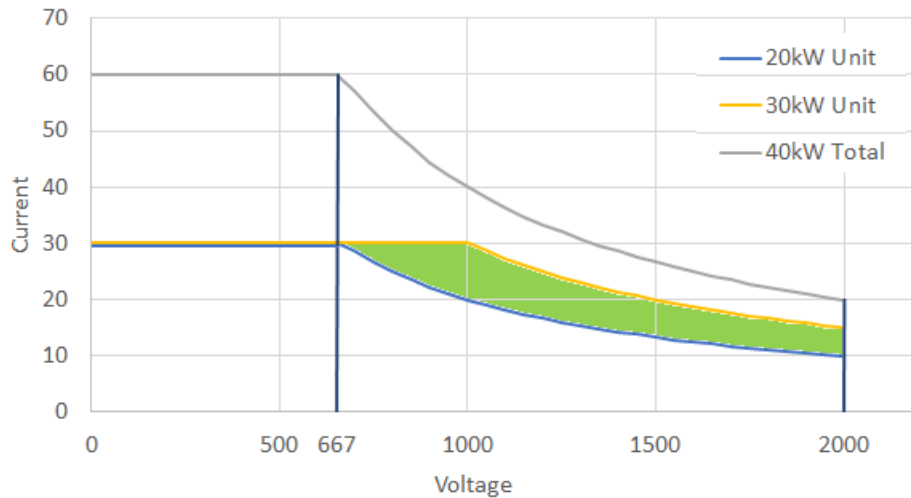

#### No Power Limitation when paralleling 1 kV, 20 kW units with 1 kV, 30 kW units

There is no power limitation when paralleling 1 kV units with unequal power ratings.

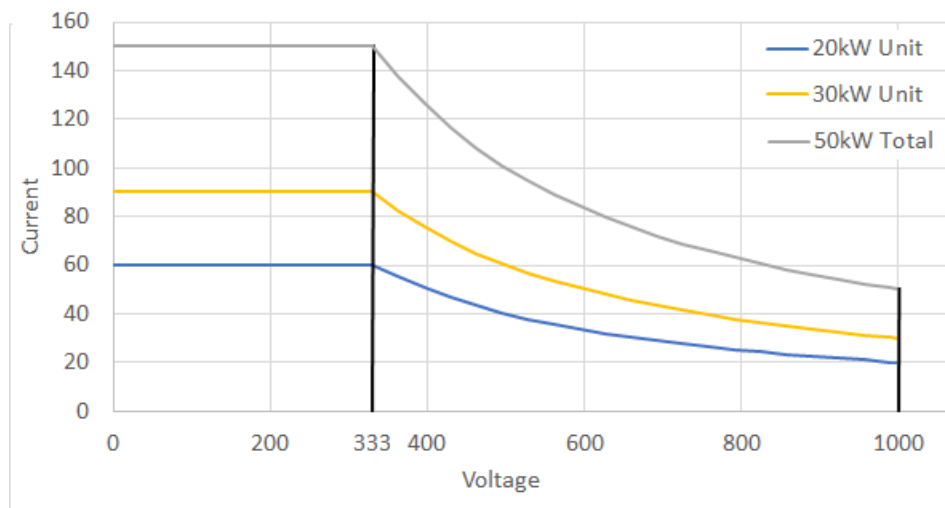

#### Power Limitations when paralleling 30 kW units using 200/208 Vac input mains

The output power of all 30 kW units when operating at 200/208 Vac nominal will be limited to 15 kW. The output current of these units will also be limited to one half of their rated current. Because the 30 kW units can operate at either 200/208 or 380/480 Vac, the following limitations also apply:

- All secondary units must be using the **same** ac mains line voltage as the primary unit. You cannot have some primary or secondary units using a 200/208 Vac input and others using a 380/480 Vac input, or an error (332) will occur.
- When an operating state is saved when the unit is operating on a specific ac line voltage, and the ac line voltage is subsequently changed, that saved state will not be able to be recalled (\*RCL). An error (341) will occur. This also occurs with units in a primary secondary configuration if any of their output states were previously saved when operating at a different ac line voltage.

### Primary/Secondary Command Details

Once connected, the group of units are controlled through the primary and appear as a single higher power unit. All programming commands should be sent to the primary unit. The following SCPI commands are **not supported** in primary/secondary mode:

<code>CALibrate</code>	all <code>CALibrate</code> commands except <code>CAL:STAT</code>
<code>ELOG:CURRent&lt;:MAX :MIN&gt;</code>	all <code>ELOG:CURR :MAX</code> and <code>:MIN</code> commands
<code>OUTPut:COUPle&lt;:STATe :OFFSet&gt;</code>	all <code>:STAT</code> and <code>:OFFS</code> commands

The following SCPI commands can be sent to the secondary unit in primary/secondary mode. Other commands may be allowed, but could disrupt control of the secondary unit by the primary unit.

<code>INSTRument:GROup:FUNCTion</code>	Enables the Primary/Secondary function
<code>INSTRument:SECondary:ADDResS</code>	Sets the secondary bus address
<code>LXI:IDENtify:STATe</code>	Turn on front panel LXI Identify indicator
<code>LXI:MDNS:STATe</code>	Sets the LXI MDNS state
<code>SYSTem:REBoot*</code>	Reboot command

\*The Reboot command can also be sent to the primary unit, but will not propagate to the secondary units.

### Troubleshooting

In primary/secondary mode, the following status indicators and messages may appear on the front panel:

#### PSP - primary/secondary protection

There has been a communication loss between the primary and secondary units. Check that the **CAT6A cables** are installed in the primary/secondary connectors, not in the in the LAN or Safety Disconnect.

#### CSF - Current sharing fault

There has been a current sharing fault due to the primary/secondary loop being out of regulation. This can occur if the **termination switches** are set incorrectly or if one of the units in the parallel stack is turned off. It can also occur temporarily if there has been a mode crossover from a load transient or due to rapid up/down programming. If this is the case, set the current limit to a higher value. CSF can also occur if the loop can no longer regulate the current imbalance between units. CSF can also be an initial indication of communication loss with the primary unit; which will transition to PSP.

#### No secondary units discovered or 1 secondary discovered (if expecting multiple secondary units)

Check that there are no duplicate secondary addresses.

#### Error 332, Primary/Secondary Error

This most often indicates that the primary unit has lost communication with a secondary, and is usually accompanied by PSP. Check that the primary/secondary **CAT6A cables** are installed correctly. This

can also occur when changing the primary/secondary configuration. Always set the primary unit to None when changing primary/secondary configurations.

This error also occurs when there is a wrong ac line voltage that has been detected on a secondary unit that is different than the ac line voltage of the primary unit to which it is connected. Always make sure that the secondary units are using the same ac line voltage as the primary unit.

# Current Sinking Operation

## Current Sinking

## Regenerative Operation

### Current Sinking

Current sinking, also referred to as down-programming, is the ability to pull current into the positive terminal of the power supply. For example, the power supply pulls or sinks current into the positive terminal whenever a lower output voltage is programmed. This is necessary because stored energy from the power supply's output capacitor and external capacitance from the load, including the wiring, must be discharged to lower the voltage at the output terminals.

The ability to rapidly transition from a higher to a lower constant voltage level greatly improves the power supply's output response time. At some point, some of this energy may be returned to the ac mains by the power supply. This is the most commonly used application of the regenerative function of the unit, which is automatic and completely transparent to the user.

The power supply can also continuously sink up to 100% of its rated current for an indefinite time. This **two-quadrant** sourcing and sinking capability of the power supply allows for seamless transitions between sourcing and sinking current without changing the power supply's output characteristics or introducing any disruptive behavior. The following controls are provided to fully utilize the two-quadrant output capability of the supply.

#### Current Limit control in voltage priority mode

When operating in voltage priority mode, you can program a negative and positive **current limit**. This will limit any current overshoots that may occur during rapid up- or down-programming.

#### Current setting control in current priority mode

When operating in current priority mode, you can program the output current to seamlessly cross the zero point when transitioning from positive to negative or negative to positive. Additionally, when operating in the negative current quadrant, you can program a negative **current setting** that will hold the sink current at the specified value. This is useful, for example, for discharging a battery at a constant current rate.

If your application requires precise control of the sourcing and sinking current, current **slew controls** are available to specify a current slew rate when sourcing and sinking current.

### Regenerative Operation

Regenerative operation is automatic and requires no programming on the part of the user. Whenever the unit is sinking current, either by rapidly down-programming the output, or by discharging an energy source such as a battery, the unit will return the excess energy to the ac mains. Refer to **AC Mains Considerations** for additional information.

## Programming Output Protection

**Set the Over-Voltage Protection**

**Set the Over-Current Protection**

**Output Watchdog Timer**

**Set the Under-Voltage Protection**

**Clear Output Protection**

### Introduction

Keysight RPS models have many protection functions. These functions disable the output to protect the device under test (DUT) as well as the power supply. A front panel status indicator will turn on when a protection function has been set. Most protection functions are latching, which means that they must be cleared once they have been set.

#### CAUTION

All protections cause a high impedance output disconnect. The output is disconnected without actively sinking current, so any voltage discharge of the DUT depends on the DUT characteristics. The DUT and load lead inductance must be within the specified hardware limits to safely absorb any stored energy. Refer to the Maximum Load Inductance limits under **Supplemental characteristics**.

Of the following protection functions, the OV, OC, PROT, INH, and UV are user-programmable.

**OV** Over-voltage protection compares the voltage measured by the sense leads to the user-programmed positive OVP level. If the sense voltage exceeds this level the unit goes into a latched protection state. OV protection is always enabled.

**OV-** Negative over-voltage protection trips if the remote sense leads are accidentally reversed. This protection minimizes the resulting rise in output voltage by comparing the voltage measured by the sense leads to a fixed negative voltage level of 20% of the unit's rated voltage. If the sense voltage exceeds this level the unit goes into a latched protection state. OV- protection is always enabled.

**OC** Over-current protection can be enabled or disabled. When enabled, the unit goes into a latched protection state when the output current reaches the current limit setting. This prevents persistent operation in current limit when operating in voltage priority mode.

**OP+** Positive over-power protection compares the output power to the rated sourcing power. A OP+ protection occurs when the rated power threshold is exceeded. OP+ protection is always enabled.

**OP-** Negative over-power protection compares the sinking power to the rated sinking power. A OP- protection occurs when the rated power threshold is exceeded. OP- protection is always enabled.

**OT** Over-temperature protection monitors a number of internal temperatures and compares them to pre-defined temperature limits. If an internal temperature exceeds the pre-defined limit, the unit goes into a latched protection state. The **OUTP:PROT:TEMP:MARG?** query can be used to return the margin remaining between the temperature sensor reading and the over-temperature trip level. OT

## 4 Using the Regenerative Power System

protection is always enabled. **Note** that If an over-temperature condition occurs on the ac input converter of the instrument, the unit will shut down immediately without warning and will not generate an OT status.

**PF** Power-fail protection detects ac line disturbances that might cause a malfunction. If an ac line disturbance is detected, the unit goes into a latched protection state. PF protection is always enabled.

**Prot** Protection indicates the output is disabled because the programmed output watchdog timer expired. It also indicates that a PSP fault has occurred on a secondary unit.

**EDP** excessive dynamic protection

protects the instrument from damage in the event of excessive large repetitive voltage swings. These can be caused by a list, CD arb, SCPI voltage programming, or load-induced output voltage changes. If left unchecked, excessive voltage dynamics could cause capacitors in the instrument to experience rms currents (resulting in self-heating) that is beyond their design limits, potentially resulting in premature failure. When tripped, the unit will go into a latched protection. EDP should not engage under normal conditions. EDP protection is always enabled.

**INH** The Inhibit input (pin 3) on the rear panel digital connector can be programmed to act as an external shutdown signal. Refer to **Inhibit Input** for details.

**UV** Under-voltage protection is a user-programmable function that can be enabled or disabled. When enabled, it provides an under-voltage shutdown that prevents the output voltage from going below a safe level when discharging a battery. If the voltage measured at the remote sense leads falls below the user-programmed under-voltage level, the unit will go into a latched protection state.

**PSP** A Primary/Secondary Protection fault has occurred in the paralleled group. All outputs of all paralleled units are disabled. PSP is always enabled. Refer to **Parallel Protection** for details.

**DOV+** Positive DUT over-voltage is active when the output is off and then turned on in HIGHZ mode. If the DUT is applying a voltage on the output terminals less than the following voltage levels, the output will not turn on to prevent excessive current from flowing **into** the unit.

Voltage priority: if the DUT voltage exceeds the programmed voltage + 1% of the unit's rated voltage.

Current priority: if the DUT voltage exceeds the positive voltage limit + 1% of the unit's rated voltage.

**DOV-** Negative DUT over-voltage is active when the output is off and then turned on. If the DUT is applying a voltage on the output terminals less than the following voltage levels, the output will not turn on to prevent excessive current from flowing **out** of the unit.

Voltage priority: if the DUT voltage is less than - 1% of the unit's rated voltage.

Current priority: if the DUT voltage is less than the negative voltage limit - 1% of the unit's rated voltage.

**LOV+** Positive local over-voltage protection trips if the remote sense leads are accidentally shorted. This protection minimizes the resulting rise in output voltage by comparing the voltage on the output terminals to a voltage level that is 1 volt plus 10% of rating above the user-programmed positive OVP level. If the output voltage exceeds this level the unit goes into a latched protection state. LOV is always enabled.

**LOV-** Negative local over-voltage protection is not available on two-quadrant models.

**OCF+** Positive over-current fault is active when the DUT applies a reverse voltage to the output terminals. It minimizes the resulting peak current at the output terminals by comparing the actual output current to a fixed level of 105% of the unit's rated current. If the current exceeds this level, the unit will go into a latched protection.

**OCF-** Negative over-current fault is active in current priority mode, when the DUT applies a voltage to the output terminals that is greater than the positive current limit setting. It minimizes the resulting peak current at the output terminals by comparing the actual output current to a fixed level of 105% of the unit's rated current. If the current exceeds this level, the unit will go into a latched protection.

## Set the Over-Voltage Protection

The over-voltage protection will turn the output off if the output voltage reaches the programmed over-voltage limit. The OVP circuit monitors the voltage at the + and – sense terminals. An OVP shutdown will automatically occur if the + and – sense leads are accidentally shorted to each other.

Front Panel Menu Reference	SCPI Command
Select <b>Protect\OVP</b> Enter a value in the OVP level box. Then press <b>Select</b> .	To set the OVP level to 400 volts: <b>VOLT:PROT 400</b>

## Set the Over-Current Protection

### Enable OCP

With over-current protection enabled, the output turns off when the output current reaches the current limit setting and transitions from constant voltage (CV) to current limit (CL+ or CL-).

Front Panel Menu Reference	SCPI Command
Select <b>Protect\OCP</b> Check <b>Enable OCP</b> . Then press <b>Select</b> .	To enable OCP: <b>CURR:PROT:STAT ON</b>

### Delay OCP

You can specify an OCP delay to prevent momentary output settings, load, and status changes from tripping the over-current protection. In most cases these momentary conditions would not be considered an over-current protection fault, and having an OCP condition disable the output when they occur would be a nuisance. Specifying an OCP delay lets the OCP circuit ignore these momentary changes during the specified delay period. Once the OCP delay time has expired and the over-current condition persists, the output will shut down. The following selections control the start of the over-current delay timer:

**Settings change** - this starts the over-current delay whenever a command changes the output settings. It includes changes made by the transient system so that the timer is started at each list step and at each Arb output change. It also includes voltage and current slew changes, so that the timer is restarted throughout the entire slew time.

**Current limit** - starts the over-current delay timer by any transition of the output into current limit.

## 4 Using the Regenerative Power System

The delay can be programmed from 0 to 0.255 seconds. You can specify if the OCP delay timer is started by any transition of the output into current limit, or only at the end of a settings change in voltage, current, or output state.

Front Panel Menu Reference	SCPI Command
Select <b>Protect\OCP</b>	To specify a 10 millisecond delay: <b>CURR:PROT:DEL 0.01</b>
Enter a delay value. Then press <b>Select</b> .	
By default, the delay timer will be started by an output "Settings Change".	To start the delay timer by an output settings change: <b>CURR:PROT:DEL:STAR SCH</b>
Check "CC Transition" to start the delay timer by ANY output transition into CL mode.	To start the delay timer by ANY output transition into CL mode: <b>CURR:PROT:DEL:STAR CCTR</b>

### Delay considerations

Factors that influence how long the settings or load change may last include: difference between old output value and new output value, the current limit setting, and the load capacitance in voltage priority mode or load inductance in current priority mode. The delay required must be determined empirically; the output programming-response time characteristics may be used as guidelines.

Also note that the time it takes the output to go into current limit (CL) varies - depending on the magnitude of the over-current condition compared to the current limit setting. For example, if the over-current is only slightly greater than the current limit setting, it may take several tens of milliseconds for the output to set the CC status bit. If the over-current is significantly greater than the current limit setting, it may only take a few hundred microseconds or less for the output to set the CL status bit. To determine when the output will shut down, you must add the time it takes for the CL status bit to the over-current protection delay time. If the over-current persists beyond the sum of both time intervals, the output will shut down.

### Primary/secondary considerations

In primary/secondary operation, current sharing during fast load current transitions could lead to false protection tripping if OCP is programmed independently on each unit. It is recommended that OCP is only programmed for the primary unit. The primary/secondary OCP is implemented by the primary unit's firmware polling the status of each secondary unit. Note however, that this may result in delay timing to be off by a factor of up to 0.5 seconds.

### Output Watchdog Timer

When enabled, the output watchdog timer causes the output to go into protection mode if there is no SCPI I/O activity on the remote interfaces (USB, LAN, GPIB) within the user-specified time period. Note that the watchdog timer function is NOT reset by activity on the front panel - the output will still shut down after the time period has elapsed.

After the time period has expired, the output will be disabled, but the programmed output state is not changed. The Prot bit in the status questionable register as well as the Prot indicator on the front panel will be set. A watchdog protect can be cleared as described under Clear Output Protection.



The watchdog delay can be programmed from 1 to 3600 seconds in 1-second increments. To enable the watchdog timer and specify a delay value, proceed as follows:

Front Panel Menu Reference	SCPI Command
Select <b>Protect\WDog</b>	To enable the watchdog timer:
Check Enable Watchdog to enable the watchdog timer.	<b>OUTP:PROT:WDOG ON</b>
Enter a value in the Watchdog Delay box. Then press <b>Select</b> .	To set the watchdog timer to 120 seconds:
	<b>OUTP:PROT:WDOG:DEL 120</b>

## Set the Under-Voltage Protection

The under-voltage protection will disable the output if the output voltage falls below the programmed low voltage setting. The voltage circuit monitors the voltage at the + and – sense terminals.

This protection function is different from the **low voltage** setting that is programmed in current priority mode, which only **prevents** the output voltage from dropping below the low voltage limit when discharging a battery.

When enabled, the under-voltage protection is always "armed". Therefore, the output voltage must be greater than the protection setting to prevent it from tripping. There are two ways to prevent this protection from tripping during the voltage transition when the output is turned on:

- Disable the under-voltage protection and turn the output on. When the output voltage is at the target value, turn under-voltage protection on. Of course, if the voltage value (or voltage limit in current priority mode) is less than the protection setting, the under-voltage protection will still trip.
- Enable the under-voltage protection, but set a delay that is longer than the output up-programming time to prevent the protection from tripping during the voltage up-programming time. The under-voltage protection will be held-off during the delay period to allow the output voltage to transition to the target value.

The under-voltage protection delay can be programmed from 20.48 microseconds to 2611 seconds in 20.48 microsecond increments. To enable the under-voltage protection and specify a delay value, proceed as follows:

Front Panel Menu Reference	SCPI Command
Select <b>Protect\UVP</b>	To set the UVP level to 2 volts:
Enter a value in the UVP level box.	<b>VOLT:PROT:LOW 2</b>
Then check <b>Enable UVP</b>	To enable low-voltage protection:
Enter a value in the UVP Delay box.	<b>VOLT:PROT:LOW:STAT ON</b>
Then press <b>Select</b> .	To specify a protection delay of 5 seconds:
	<b>VOLT:PROT:LOW:DEL 5</b>

## Clear Output Protection

If an over-voltage, over-current, over-temperature, power-fail, power-limit, inhibit, or any other protection condition occurs, the output is disconnected into a high-impedance state. The appropriate operating status indicator on the front panel will be on. To clear the protection function and restore normal operation, first remove that condition that caused the protection fault. Then, clear the protection function as follows:

Front Panel Menu Reference	SCPI Command
Select <b>Protect\Clear</b> Select Clear.	To clear a protection fault: <b>OUTP:PROT:CLE</b>

**NOTE**

The output is re-enabled once the output protection function is cleared.

## Programming Output Transients

### Common Actions for All Transients

#### Programming a Step Transient

#### Programming a List Transient

#### Programming an Arbitrary Waveform

### Introduction

An output transient is defined as a triggered action that causes a change in output voltage or current. The three available transient types are: step, list, and arbitrary waveforms.

**Step** - a one-time event that steps the output voltage or current up or down in response to a trigger.

**List** - describes a precisely timed, complex sequence of output steps or changes.

**Arbitrary Waveform** - allows the output to generate complex user-defined voltage or current waveforms of up to 65,535 data points.

### Common Actions for All Transients

- Enable the output transient function
- Program the transient parameters
- Select the trigger source
- Initiate the transient system
- Trigger the transient

The transient trigger process is illustrated below. This applies to all transient types. The arrows on the right are specific to List transients. For an overview of the trigger system, refer to [Trigger Overview](#).

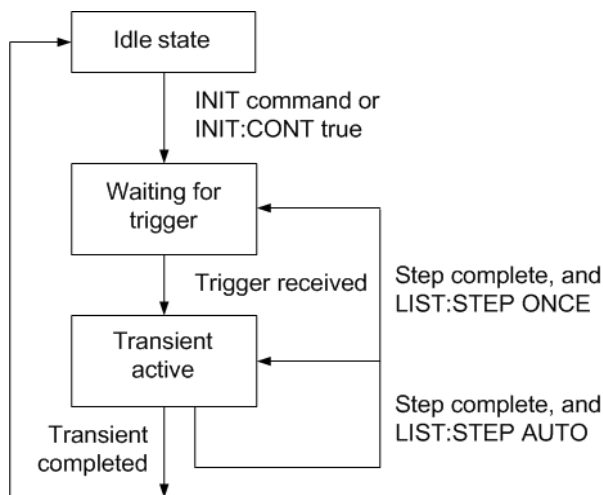

### Enable the output transient function

First, you must enable the output to respond to transient triggers. Unless an output transient function is enabled, nothing will happen even if you have programmed the transient parameters and generated a transient trigger.

Front Panel Menu Reference	SCPI Command
<p>Select <b>Transient\Mode</b>.</p> <p>If you are operating in voltage priority mode select Voltage mode. If you are operating in current priority mode select Current mode.</p> <p>In the dropdown list, select Step, List or Arb transients. Then press <b>Select</b>.</p>	<p>To enable the transient function, use:</p> <p><b>VOLT:MODE STEP</b>  <b>VOLT:MODE LIST</b>  <b>VOLT:MODE:ARB</b></p> <p>or</p> <p><b>CURR:MODE STEP</b>  <b>CURR:MODE:LIST</b>  <b>CURR:MODE:ARB</b></p>

**NOTE** In Step mode, the triggered value becomes the immediate value when the trigger is received. In Fixed mode, trigger signals are ignored; the immediate values remain in effect when a trigger is received.

### Program the transient parameters

For example, set the triggered voltage level if you are programming a voltage step:

Front Panel Menu Reference	SCPI Command
<p>Select <b>Transient\Step</b>.</p> <p>Select the Trig Voltage box to set the voltage. Enter a value and press Select.</p>	<p>To set a voltage step level of 15 V use:</p> <p><b>VOLT:TRIG 15</b></p>

### Select the trigger source

**NOTE** A TRIGger:TRANsient[:IMMEDIATE] command over the bus will always generate an immediate transient trigger, regardless of the selected trigger source.

Unless you are using the front panel menu or a TRIGger:TRANsient[:IMMEDIATE] command to trigger the transient, select a trigger source from the following:

Trigger Source	Description
Bus	Selects GPIB device trigger, *TRG, or <GET> (Group Execute Trigger).
External	Selects ANY pin that has been configured as a trigger input on the digital control port.
Immediate	Triggers the transient as soon as it is INITiated.
Pin<1-7>	Selects a specific pin<n> that is configured as a Trigger Input on the digital control port.

Use the following commands to select a trigger source:

Front Panel Menu Reference	SCPI Command
Select <b>Transient\TrigSource</b> .	To select Bus triggers:
To select Bus triggers, select Bus.	<b>TRIG:TRAN:SOUR BUS</b>
To select immediate triggers, select Imm.	To select an immediate trigger:
To select digital pin 5 as the trigger, select Pin 5, or EXT.	<b>TRIG:TRAN:SOUR IMM</b>
	To select digital pin 5 as the trigger:
	<b>TRIG:TRAN:SOUR PIN5</b>
	To select any pin configured as a trigger:
	<b>TRIG:TRAN:SOUR EXT</b>

## Initiate the transient system

When the unit is turned on, the trigger system is in the idle state. In this state, the trigger system is disabled, ignoring all triggers. The INITiate commands enable the trigger system to receive triggers.

Front Panel Menu Reference	SCPI Command
Select <b>Transient\Control</b> .	To initiate the transient trigger system:
Scroll to Initiate. Then press <b>Select</b> .	<b>INIT:TRAN</b>

It takes a few milliseconds for the instrument to be ready to receive a trigger signal after receiving the INITiate:TRANsient command. If a trigger occurs before the trigger system is ready for it, the trigger will be ignored. You can test the WTG\_tran bit in the operation status register to know when the instrument is ready to receive a trigger after being initiated.

Front Panel Menu Reference	SCPI Command
Select <b>Transient\Control</b> .	To query the WTG_tran bit (bit 4):
The Trig state field indicates "Initiated".	<b>STAT:OPER:COND?</b>

If a bit value of 16 is returned in the query, the WTG\_tran bit is true, and the instrument is ready to receive the trigger signal. Refer to [Status Tutorial](#).

### NOTE

Unless INITiate:CONTinuous:TRANsient is programmed, the instrument executes one transient each time a trigger signal is received. Thus, it will be necessary to initiate the trigger system each time another triggered transient is desired.

## Trigger the transient

The trigger system is waiting for a trigger signal in the initiated state. You can immediately trigger the transient as follows:

Front Panel Menu Reference	SCPI Command
Select <b>Transient\Control</b> .	To generate a transient trigger:
Select Trigger to generate an immediate trigger signal regardless of the trigger source setting.	<b>TRIG:TRAN</b>
	Alternatively, if the trigger source is BUS, you can also program a <b>*TRG</b> or an IEEE-488 <get> command.

## 4 Using the Regenerative Power System

If a digital pin is configured as the trigger source, the instrument will wait indefinitely for the trigger signal. If the trigger does not occur, you must manually return the trigger system to the idle state. The following commands return the trigger system to the idle state:

Front Panel Menu Reference	SCPI Command
Select <b>Transient\Control</b> . Then select the Abort control.	<b>ABOR:TRAN</b>

When a trigger is received, the triggered functions are set to their programmed transient values. When the triggered actions are completed, the trigger system returns to the idle state.

You can test the TRAN-active bit in the Operation Status register to know when the transient trigger system has returned to the idle state.

Front Panel Menu Reference	SCPI Command
Select <b>Transient\Control</b> . The Trig state field indicates "Idle".	To query the TRAN-active bit (bit 6): <b>STAT:OPER:COND?</b>

If a bit value of 64 is returned in the query, the TRAN-active bit is true, and the transient action is NOT complete. When the TRAN-active bit is false, the transient action is complete. Refer to [Status Tutorial](#) for more information.

### Programming a Step Transient

- [Enable the step function](#)
- [Program the step level](#)
- [Generate a trigger signal](#)

#### Enable the step function

First, you must enable the step transient function.

Front Panel Menu Reference	SCPI Command
Select <b>Transient\Mode</b> . In voltage priority mode select Voltage mode. In current priority mode select Current mode. In the dropdown list, select Step. Then press <b>Select</b> .	To enable the transient function, use: <b>VOLT:MODE STEP</b> or <b>CURR:MODE STEP</b>

#### Program the step Level

Use the following commands to program the triggered output step level. The output will go to this level when the trigger is received. In the front panel menu, you can only program the step level based on the priority mode that you are operating in - voltage or current priority.

Front Panel Menu Reference	SCPI Command
Select <b>Transient\Step</b> .	To set a voltage step level of 15 V use: <b>VOLT:TRIG 15</b>
Select the Trig Voltage box to set the voltage. Select the Trig Current box to set the current. Enter a value and press <b>Select</b> .	To set a current step level of 1 A use: <b>CURR:TRIG 1</b>

### Generate a trigger signal

The output step can generate a trigger signal that can be routed to a pin on the digital port that has been configured as a trigger output (TOUT). Use the following commands to generate a trigger signal when the step occurs:

Front Panel Menu Reference	SCPI Command
Select <b>Transient\Step</b> .	To program a Step trigger signal, use: <b>STEP:TOUT ON</b>
Check Enable Trigger Output. Then press <b>Select</b> .	

### Programming a List Transient

- **Enable the list function**
- **Program the list levels**
- **Program the dwell times**
- **Specify the list pacing**
- **Specify any trigger signals that the list should generate**
- **Specify how many times you want the list to repeat**
- **Specify how you want the list to end**

Lists let you generate complex sequences of output changes with rapid, precise timing, which may be synchronized with internal or external signals. In contrast to an output step, which is a one-time output change, an output list is a sequence of output changes. Lists can contain up to 512 individually programmed steps, and can be programmed to repeat themselves. Only the parameters associated with one of the priority modes, either voltage or current priority, may be list controlled.

The voltage and current lists are paced by a separate dwell list that defines the duration or dwell of each step. Each of the up to 512 steps can have a unique dwell time associated with it, which specifies the time in seconds that the list will remain at that step before moving on to the next step. Refer to **LIST:DWEL** for information about the dwell range and resolution.

Lists can also be trigger-paced, in which the list advances one step for each trigger received. This is useful if you need an output list to closely follow triggered events. With a trigger-paced list, triggers that are received during the dwell period are ignored. You can set the list dwell time to zero ensure that no triggers are lost.

## 4 Using the Regenerative Power System

Lists can also generate trigger signals at specified steps. This is accomplished by two additional lists: a beginning-of-step (BOST) and an end-of-step (EOST) list. These lists define which steps will generate a trigger signal and if the trigger occurs at the beginning or end of the step. These trigger signals can be used to synchronize other events with the list.

All lists (voltage, current, dwell, BOST, EOST) must be set to the same number of steps, otherwise an error occurs when the list is initiated. For convenience, a list may be programmed with only one step or value. In this case, a single-step list is treated as if it had the same number of steps as the other lists, with all values being equal to the one value.

### NOTE

List data is not saved as part of a saved instrument state.

### Enable the list function

First, you must enable the list transient function.

Front Panel Menu Reference	SCPI Command
Select <b>Transient\Mode</b> . In voltage priority mode select Voltage mode. In current priority mode select Current mode. In the dropdown list, select List. Then press <b>Select</b> .	To enable the transient function, use: <b>VOLT:MODE LIST</b> or <b>CURR:MODE LIST</b>

### Program the list levels

**Example 1** If you are programming a voltage pulse or pulse train, set the amplitude of the pulse. For example, to generate a pulse with an amplitude of 15 V, program the amplitude for the pulse (step 0), and the amplitude for the off time (step 1).

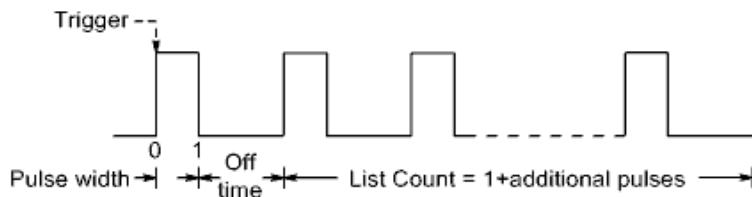

Front Panel Menu Reference	SCPI Command
Select <b>Transient&gt;List\Config</b> . Select List Step 0 (the pulse) and enter a voltage value of 15. Press Select. Select List Step 1 (the off time) and enter a voltage value of 0. Press Select. Use the numeric up/down arrows to select the next step.	To program the amplitude for step 0 (the pulse) and step 1 (the off time): <b>LIST:VOLT 15,0</b>

**Example 2** If you are programming a voltage list, specify the amplitudes for the list. The order in which the values are entered determines the order in which the values will be output. To generate the voltage list shown in the figure, a list may include the following values: 9, 0, 6, 0, 3, 0:



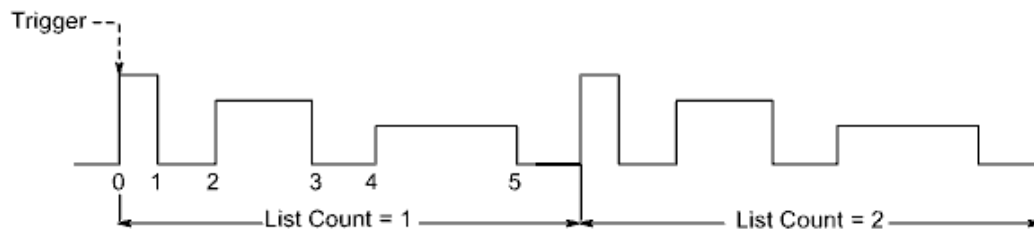

Front Panel Menu Reference	SCPI Command
Select <b>Transient\List\Config</b> .	To program a voltage list of 5 steps:
Select the List Step number and enter a voltage value. Press Select.	<b>LIST:VOLT 9,0,6,0,3,0</b>
Repeat this for each step. Use the numeric up/down arrows to select the next step.	

### Program the dwell times

**Example 1** If you are programming a voltage pulse, set the dwell time of the pulse width. Also specify the dwell of the off time. This is necessary if you are generating a pulse train, since the off time determines the time between pulses. To generate a pulse with a pulse width of one second and an off time of two seconds, use:

Front Panel Menu Reference	SCPI Command
Select <b>Transient\List\Config</b> .	To program the dwell for step 0 (the pulse) and step 1 (the off time):
Select List Step 0 (the pulse) and enter a dwell value of 1. Press Select.	<b>LIST:DWEL 1,2</b>
Select List Step 1 (the off time) and enter a dwell value of 2. Press Select. Use the numeric up/down arrows to select the next step.	

You have now configured a single pulse. If you wish to generate a pulse train, simply specify the number of pulse repetitions as described under "Specify How Many Times the List Repeats".

**Example 2** If you are programming a voltage list, specify the amplitudes for the list. The dwell values determine the time interval, in seconds, that the output remains at each step in the list before it advances to the next step. To specify six dwell intervals with following values: 2, 3, 5, 3, 7, 3:

Front Panel Menu Reference	SCPI Command
Select <b>Transient\List\Config</b> .	To program a dwell of 5 values, use:
Select the List Step number and enter a dwell value. Press Select.	<b>LIST:DWEL 2,3,5,3,7,3</b>
Repeat this for each step. Use the numeric up/down arrows to select the next step.	

#### NOTE

The number of dwell steps must equal the number of voltage steps. If a dwell list has only one value, that value will be applied to all steps in the list.

### Specify the list pacing

You can specify if the list will be dwell or trigger-paced. The default selection is dwell-paced.

In a dwell paced list, each step is assigned a dwell time. The dwell time determines the time that the output remains at the step. As each dwell time elapses, the next step is immediately output.

In a trigger-paced list, the list advances one step for each trigger received. You can also specify a dwell period if you want to ignore triggers during the dwell time, or guarantee a minimum dwell time between triggered list steps.

Front Panel Menu Reference	SCPI Command
Select <b>Transient\List\Pace</b> .	To set the list pacing to dwell-paced:
Select either Dwell paced or Trigger paced. Then press <b>Select</b> .	<b>LIST:STEP AUTO</b>
	To set the list pacing to trigger-paced:
	<b>LIST:STEP ONCE</b>

### Specify any trigger signals that the list should generate

You can generate trigger signals that can be routed to other destinations. For example, you can use trigger signals to trigger actions on any external equipment connected to the digital port. The following figure gives an example of generating four trigger signals on the voltage list of Example 2.

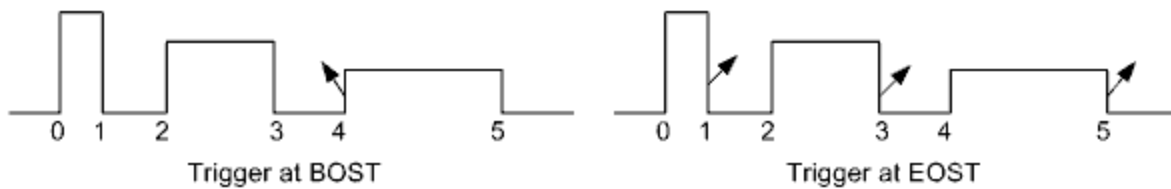

Front Panel Menu Reference	SCPI Command
Select <b>Transient\List\Config</b> .	To program a trigger at the beginning of step 4:
Select the List Step number 4. To generate a trigger, enter a 1 in the Tout Begin Step field.	<b>LIST:TOUT:BOST 0,0,0,0,1,0</b>
Select the List Step numbers 0, 2, and 4. To generate a trigger, enter a 1 in the Tout End Step field.	To program a trigger at the end of step 0, 2, and 4:
If zeroes are entered in the fields, no trigger is generated for the step.	<b>LIST:TOUT:EOST 1,0,1,0,1,0</b>

### Specify how many times you want the list to repeat

You can specify how many times you want the list (or pulse) to repeat. At reset, the list count is set to one repetition. Sending the INfinity parameter in the SCPI command makes the list repeat indefinitely.

Front Panel Menu Reference	SCPI Command
Select <b>Transient\List\Repeat</b> .	To program the list to repeat twice:
Enter the number of list repetitions (2) and press <b>Select</b> .	<b>LIST:COUN 2</b>

## Specify how you want the list to end

Specify the output state after the list has completed. There are two choices: the output returns to the value that was in effect before the list started, or the output remains at the value of the last list step.

Front Panel Menu Reference	SCPI Command
Select <b>Transient\List\Terminate</b> .	To return the output to the pre-list state: <b>LIST:TERM:LAST OFF</b>
Select either Return to Start, or Stop at Last Step and press Select.	To keep the output at the end list state: <b>LIST:TERM:LAST ON</b>

## Programming an Arbitrary Waveform

- **Enable the Arb function**
- **Specify the Arb type and dwell**
- **Configure the Arb**
- **Specify how many times you want the Arb to repeat**
- **Specify how you want the Arb to end**

### NOTE

Certain output amplitude and frequency combinations can exceed the instrument's dynamic response capability and cause the output to shut down, especially under no-load conditions. Refer to **Output Dynamic Response** for more information.

The output of the instrument can be modulated using its built-in arbitrary waveform generator. This allows the output to generate complex user-defined voltage or current waveforms. The following are key features of the constant-dwell arbitrary waveform generator:

- Generate voltage or current arbitrary waveforms.
- Arb's can contain up to 65,535 data points.
- A single dwell value applies to every point in the constant-dwell arbitrary waveform (see **ARB:VOLT:CDW:DWEL** for dwell information).
- Only the Arb that corresponds to the active priority mode, either voltage or current priority, may be generated.

## Enable the Arb function

First, you must enable the Arb waveform function.

Front Panel Menu Reference	SCPI Command
Select <b>Transient\Mode</b> . In voltage priority mode select Voltage mode. In current priority mode select Current mode. In the dropdown list, select Arb. Then press <b>Select</b> .	To enable the transient function, use: <b>VOLT:MODE ARB</b> or <b>CURR:MODE ARB</b>

### Specify the Arb type and dwell

To specify the Arb type and dwell:

Front Panel Menu Reference	SCPI Command
Select <b>Transient\Arb\Config</b> . In the dropdown list, pick either a voltage or a current Arb. Then press <b>Select</b> .	To specify a voltage or current Arb: <b>ARB:FUNC:TYPE VOLT</b> <b>ARB:FUNC:TYPE CURR</b>
Enter a dwell value in the Dwell field. Then press <b>Select</b> .	To specify a dwell time of 1 millisecond: <b>ARB:VOLT:CDW:DWEL 0.001</b> <b>ARB:CURR:CDW:DWEL 0.001</b>

### Configure the Arb

Note that you can use the numeric up/down arrows to view arb points in the front panel **Transient\Arb\Config** dialog. You cannot *program* Arb data from the front panel. You must use the SCPI **ARB:CURRENT:CDWell** or **ARB:VOLTage:CDWell** commands to program the Arb data.

Front Panel Menu Reference	SCPI Command
Select <b>Transient\Arb\Config</b> . If Arb points have been imported or programmed using the SCPI command, the Points field displays the number of points in the Arb.	To program 10 points in a current Arb: <b>ARB:CURR:CDW 1,2,2,3,4,4,3,2,2,1</b>
View the amplitude of any Arb point by entering the point number in the Point # field. The Level field displays the amplitude.	To query the number of Arb points: <b>ARB:CURR:CDW:POIN?</b>  To query the Arb point values: <b>ARB:CURR:CDW?</b>

### Specify how many times you want the Arb to repeat

Depending on your application, specify how many times you want the Arb to repeat. Sending the **INFINITY** parameter in the SCPI command makes the Arb repeat indefinitely. At reset, the Arb count is set to 1.

Front Panel Menu Reference	SCPI Command
Select <b>Transient\Arb\Repeat</b> . Enter the number of list repetitions (2) and press <b>Select</b> .	To program the Arb to repeat twice: <b>ARB:COUN 2</b>

### Specify how you want the Arb to end

Specify the output state after the Arb has completed. There are two choices: the output returns to the state it was in before the Arb started, or the output remains at the values of the last Arb point.

Front Panel Menu Reference	SCPI Command
Select <b>Transient\Arb\Terminate</b> . Select either Return to Start, or Stop at Last Step and press <b>Select</b> .	To return the output to the pre-Arb state: <b>ARB:TERM:LAST OFF</b>  To keep the output at the Arb end point: <b>ARB:TERM:LAST ON</b>

## Sequencing the Output

This section describes how you can synchronize output turn-on and turn-off sequences on single and multiple units.

### Turn-On/Turn-Off Delays

### Coupling the Output

### Sequencing Multiple Units

### Output Turn-On/Turn-Off Behavior

## Turn-On/Turn-Off Delays

All power supplies exhibit an internal delay offset that applies from the time that a command to turn on the output is received until the output actually turns on. Specifying a common delay offset serves as a reference point for any user-programmed turn-on delays. This user-defined offset also makes it possible to connect multiple power supplies together and program accurate turn-on sequences across multiple outputs. The user-programmed turn-on delay will then be added to the common user-defined reference point.

There is no need to specify a common delay offset when outputs turn off. Outputs start executing their turn-off delays as soon as an Output Off command is received. The internal delay offset is shown in the following table.

	Voltage Priority	Current Priority
Stand-alone power supply	≤ 8 milliseconds	≤ 7 milliseconds

## Coupling the Output

In addition to the front panel and SCPI Output On and Output Off commands, you can also use OnCouple and OffCouple signals to enable and disable the output. These signals provide an additional level of control when sequencing the output on individual and multiple units.

The following figure illustrates the programming path when using the OnCouple and OffCouple signals to control the output.

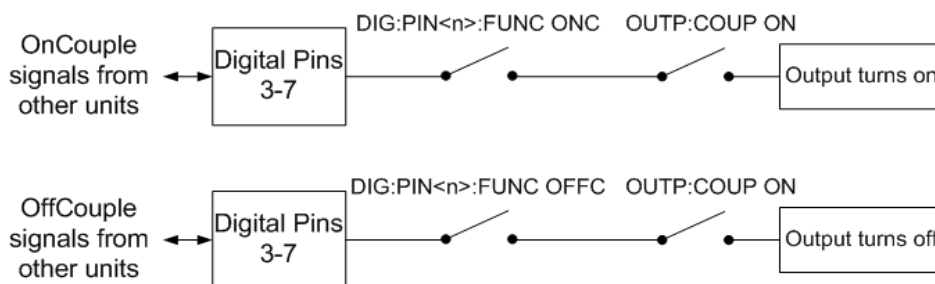

As shown in the figure, you can configure digital ports pins 3 through 7 to provide the OnCouple and OffCouple signals that enable or disable the output. The output is enabled or disabled when the

corresponding signal is true. Refer to **Output Couple Control** for more information on configuring the digital port pins.

Lastly, you must enable output sequencing to use OnCouple and OffCouple signals to enable or disable the output. Refer to Enable Output Sequencing below.

### Sequencing Multiple Units

To sequence the output turn-on for multiple units:

1. Connect and configure the digital connector pins of all units.
2. Enable the sequence function on each unit.
3. Specify the user-programmed turn-on delay for each unit.
4. This step is required if you have power supplies with **different** minimum delay offsets (see below). Specify a common delay offset for all of the sequenced units. The common delay offset must be larger or equal to the largest maximum delay offset. When the common delay offset completes, the user-programmed turn-on delays will start.

### Connect and Configure the Digital Connector Pins

The digital connector pins of the sequenced units must be connected together and configured. Refer to **Output Couple Control** for more information.

### Enable Output Sequencing

Output turn-on sequencing must be enabled on each unit that will participate in output turn-on synchronization.

Front Panel Menu Reference	SCPI Command
Select <b>Output\Sequence\Couple</b> .	To enable, send:
Check Enable to enable sequencing.	<b>OUTP:COUP ON</b>
Uncheck to disable.	To disable, send:
	<b>OUTP:COUP OFF</b>

### Specify the Turn-On and Turn-Off Delays for each Unit

Turn-on delays can be specified for all coupled units. Any delay sequence can be implemented. There are no restrictions on what the sequence is or what unit comes up first.

Front Panel Menu Reference	SCPI Command
Select <b>Output\Sequence\Couple</b> .	Program a turn-on delay:
Specify the Turn-on delay in seconds.	<b>OUTP:DEL:RISE .02</b>
Repeat for each additional unit.	Repeat for each instrument.

Turn-off delays can also be specified for all coupled units. Any delay sequence can be implemented. There are no restrictions on what the sequence is or what unit turns off first.

Front Panel Menu Reference	SCPI Command
Select <b>Output\Sequence\Delay</b> .	Program a turn-off delay: <b>OUTP:DEL:FALL .01</b>
Specify the Turn-off delay in seconds.	Repeat for each instrument.
Repeat for each additional unit.	

### Specify the Common Delay Offset

#### NOTE

There is no need to specify a common delay offset when outputs turn off. Outputs start executing their turn-off delays as soon as an Output Off command is received (and any user-programmed turn-off delay has expired).

Specifying a common delay offset lets you accurately synchronize the user-programmed turn-on delays when sequencing power supplies with different internal delay offsets.

In the figure on the left, you can see how the internal delay offsets are appended to the user-programmed delay times. The internal delay offsets vary based on priority mode.

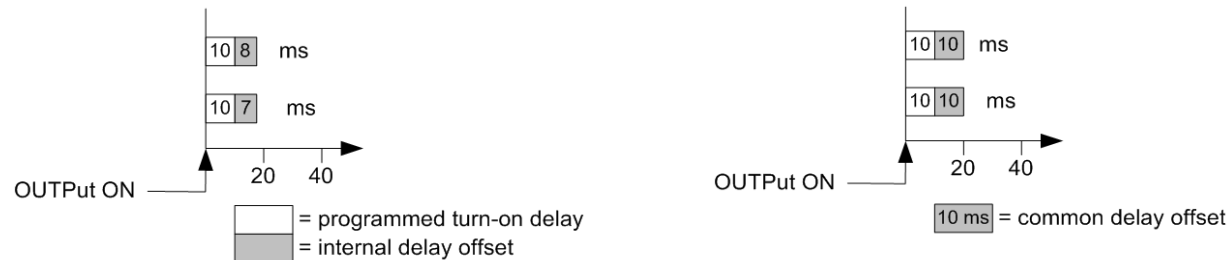

Although you cannot eliminate the internal delay offset times, you can specify a common delay offset to accurately synchronize the user-programmed turn on delays with each other. If in the figure on the left, you were to program a common delay offset of 10 ms as shown in the figure on the right, that common delay offset would then supersede the different internal delay times of the coupled units. The 10 ms common offset would in effect synchronize the internal delay of the coupled units.

The common delay offset assures that the user-programmed turn-on delays will be synchronized to start at the completion of the common delay offset. Query the delay offset of each unit and use the slowest delay as the common delay offset.

Front Panel Menu Reference	SCPI Command
Select <b>Output\Sequence\Couple</b> .	To query the delay offset of the slowest unit: <b>OUTP:COUP:MAX:DOFF?</b>
The Max delay offset for this frame field displays the delay offset of the unit. Enter the delay offset value of the slowest unit in the Delay offset field in milliseconds. Then press <b>Select</b> .	Use the delay offset of the slowest unit to specify the common delay offset <b>OUTP:COUP:DOFF &lt;value&gt;</b>

### Output Turn-On Turn-Off Behavior

The turn-on and turn-off sequences are primarily controlled by three factors: the user-programmed turn-on/turn-off delays, and the voltage and current priority mode settings.

## 4 Using the Regenerative Power System

The following table documents the output impedance setting for the turn-on and turn-off sequences. You can specify either Low or High output impedance when operating in Voltage priority mode.

Output turn-on/turn-off impedance for	Voltage Priority	Current Priority
RP797xA; RP798xA	Impedance is user-selectable via <b>OUTPut:TMODE</b> command	High impedance turn-on High impedance turn-off

The following Output-On and Output-Off sequence descriptions are illustrated in the accompanying flowchart.

### Output-On Sequence

The internal power circuits are connected to the output by a solid-state switch. Upon the receipt of an Output On command, the power supply waits for the duration of the user-programmed turn-on delay.

In voltage priority with LowZ, the power supply programs its internal circuits to a voltage of zero and sets the current limits to their user-programmed values. In voltage priority with HighZ, the power supply matches its internal voltage to the DUT voltage.

In current priority, the power supply also matches its internal voltage to the DUT voltage. This ensures that when a source such as a battery is connected to the output, that there is no current surge into the power supply from the DUT when the output is turned on.

The power supply's solid-state output switch is then closed, connecting the output to the internal power circuits. The output voltage and current are programmed to their user-settings. The output follows the slew rate setting.

### Output-Off Sequence

Upon the receipt of an Output Off command, the power supply waits for the duration of the user-programmed turn-off delay.

In voltage priority with LowZ, the power supply programs the voltage to zero. It then waits up to 250 ms to discharge any current from the DUT. It then programs the current limits to their minimum settings. In voltage priority with HighZ, the power supply only programs the current limits to their minimum settings.

In current priority, the power supply programs the current to zero. It then waits up to 250 ms to discharge any current from the DUT.

The power supply's solid-state output switch is then opened, disconnecting the output from the internal power circuits.

#### NOTE

If you wish to program a voltage turn-off slew rate, you must set the slew rate and program the output voltage to zero *before* you send the output off command.

### Output-Off Protection Sequence

The turn-off protection sequence differs from the normal turn-off sequence in that it turns off the output as fast as possible. When a protection event is detected, the power supply immediately opens the solid-state output switch. This typically takes less than 50  $\mu$ s following the initial detection.



Turn-On/Turn-Off Flowchart

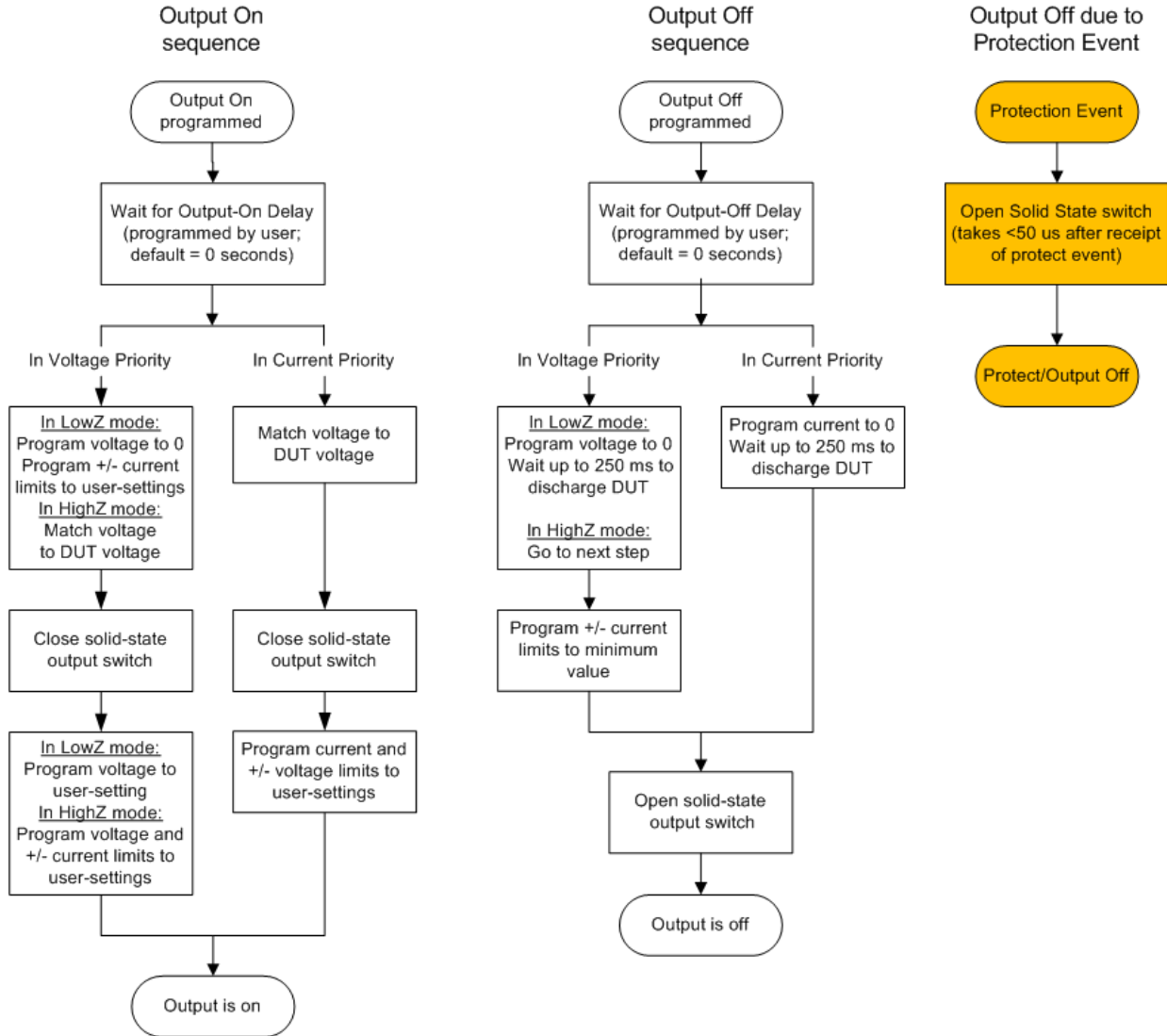

## Making Measurements

### Average Measurements

#### Measurement Sweep

#### Measurement Windowing

#### Amp-hour & Watt-hour measurement

#### Digitized Measurements

#### Measurement Triggering

### Average Measurements

Keysight RPS models have a fully integrated voltmeter and ammeter to measure the actual voltage and current that is being supplied to the load.

Whenever the power supply is on, the front panel automatically measures output voltage and current by acquiring a number of measurements over the specified number of power line cycles, and averaging the samples. The default number of power line cycles is 1 cycle. At 1 cycle, the number of samples (or points) is 3255 @60 Hz and 3906 @50 Hz. The default sample interval is 5.12 microseconds. Use the following commands to make a measurement:

Front Panel Menu Reference	SCPI Command
Select the <b>Meter</b> key.	To measure average (dc) output voltage, current, or power:
Repeatedly press the key to cycle through the following measurement functions:	<b>MEAS:VOLT?</b>
Voltage, Current	<b>MEAS:CURR?</b>
Voltage, Power	<b>MEAS:POW?</b>
Voltage, Current, Power	To return measurement data from the previously acquired array:
If dashes are displayed, the front panel measurement is interrupted because a remote interface measurement is taking place.	<b>FETC:VOLT?</b>
	<b>FETC:CURR?</b>
	<b>FETC:POW?</b>

### Measurement Sweep

You can set the measurement time in number of power line cycles (NPLC). Using an integer number of power line cycles can reduce measurement noise from line frequency sources.

Front Panel Menu Reference	SCPI Command
Select <b>Measure\Sweep</b>	To set the number of power line cycles to 10:
Enter the number of power line cycles in the NPLC field.	<b>SENS:SWE:NPLC 10</b>
Then press <b>Select</b> .	

#### NOTE

The ac line frequency is detected automatically for SENSE:SWEep:NPLC.

## Measurement Windowing

Windowing is a signal conditioning process that reduces the error in average measurements made in the presence of periodic signals and noise. Two window functions are available: Rectangular and Hanning. At power-on, the measurement window is Rectangular.

The Rectangular window calculates average measurements without any signal conditioning. However, in the presence of periodic signals such as ac line ripple, a Rectangular window can introduce errors when calculating average measurements. This can occur when a non-integral number of cycles of data has been acquired due to the last partial cycle of acquired data.

One way of dealing with ac line ripple is to use a Hanning window. The Hanning window applies a  $\cos^4$  weighting function to the data when calculating average measurements. This attenuates the ac noise in the measurement window. The best attenuation is achieved when at least three or more waveform cycles are in the measurement.

Front Panel Menu Reference	SCPI Command
Select <b>Measure\Window</b> . Select either Rectangular or Hanning. Then press <b>Select</b> .	To set the sense window to Hanning: <b>SENS:WIND HANN</b>

## Amp-hour & Watt-hour measurement

Amp-hour and watt-hour measurements are made independently of other measurements.

The amp-hour and watt-hour measurements are created by accumulating full range current and power measurements at approximately 200k samples/second. The accumulators can hold enough data for at least 100,000 hours.

The approximate limit of accumulated charge is  $\pm(900,000,000 \cdot I_{\text{rating}})$  in Coulombs or  $\pm(250,000 \cdot I_{\text{rating}})$  in Amp-hours.

The approximate limit of accumulated energy is  $\pm(1,100,000,000 \cdot P_{\text{rating}})$  in Joules or  $\pm(310,000 \cdot P_{\text{rating}})$  in Watt-hours.

$I_{\text{rating}}$  is the current rating of the unit.  $P_{\text{rating}}$  is the power rating of the unit.

To return Amp-hours and Watt-hours measurements:

Front Panel Menu Reference	SCPI Command
Select <b>Measure\AHWH</b> . Displays the accumulated Amp-hours and Watt-hours.	To return the Amp-hours and Watt hours: <b>FETC:AHO?</b> <b>FETC:WHO?</b>

To reset the Amp-hours and Watt-hours measurements:

Front Panel Menu Reference	SCPI Command
Select <b>Measure\AHWH</b> .	To reset Amp-hours and Watt-hours:
Select <b>Reset</b> to return the measurements to zero.	<b>SENS:AHO:RES</b> <b>SENS:WHO:RES</b>

## Digitized Measurements

In addition to the average voltage, current, and power measurements, which are available from both the front panel and via SCPI commands, digitized measurements can also be returned. Digitized measurements differ from average measurements because you can select the type of measurement returned and fine tune the measurement quality.

### Measurement Types

The following digitized measurements are available. These can only be measured using the corresponding SCPI command.

**ACDC** is a calculation that returns the total rms measurement (ac + dc).

**HIGH** level is a calculation that generates a histogram of the waveform using 16 bins between the maximum and minimum data points. The bin containing the most data points above the 50% point is the high bin. The average of all the data points in the high bin is returned as the High level. If no high bin contains more than 1.25% of the total number of acquired points, then the maximum data point is returned.

**LOW** level is a calculation that generates a histogram of the waveform using 16 bins between the maximum and minimum data points. The bin containing the most data points below the 50% point is the low bin. The average of all the data points in the low bin is returned as the Low level. If no low bin contains more than 1.25% of the total number of acquired points, then the minimum data point is returned.

**MAX** is the maximum value of the digitized measurement.

**MIN** is the minimum value of the digitized measurement.

Array queries are also available to return ALL values in the voltage and current measurement buffer. No averaging is applied, only raw data is returned from the buffer.

Front Panel Menu Reference	SCPI Command
Not available	To measure rms voltage & current: <b>MEAS:VOLT:ACDC?</b> <b>MEAS:CURR:ACDC?</b>
	To measure the high level of a pulse: <b>MEAS:VOLT:HIGH?</b> <b>MEAS:CURR:HIGH?</b>
	To measure the low level of a pulse: <b>MEAS:VOLT:LOW?</b> <b>MEAS:CURR:LOW?</b>

To measure the maximum value:

MEAS:VOLT:MAX?  
 MEAS:CURR:MAX?  
 MEAS:POW:MAX?

To measure the minimum value:

MEAS:VOLT:MIN?  
 MEAS:CURR:MIN?  
 MEAS:POW:MIN?

To take a measurement and return array data:

MEAS:ARR:VOLT?  
 MEAS:ARR:CURR?  
 MEAS:ARR:POW?

## Measurement Quality

The following figure illustrates the relationship between measurement samples (or points), and the time interval between samples in a typical measurement. You can fine tune the measurement by specifying the number of points in the measurement acquisition as well as the time interval between points.

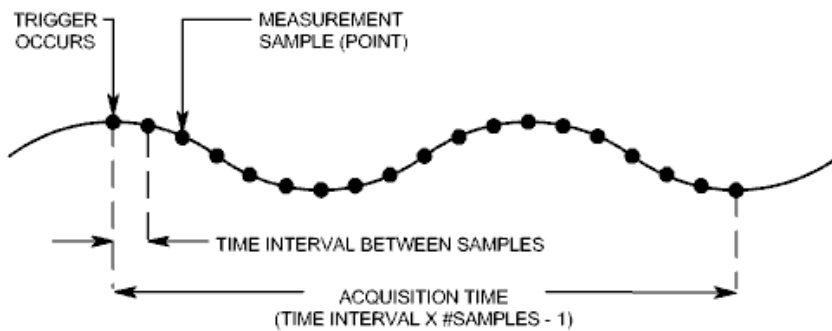

You can configure the measurement acquisition as follows:

Front Panel Menu Reference	SCPI Command
Select <b>Measure\Sweep</b> .	To set the time interval to 60µs with 4096 samples:
Enter the number of points. Then press <b>Select</b> .	SENS:SWE:TINT 60E-6
Enter the time interval. Then press <b>Select</b> .	SENS:SWE:POIN 4096

The maximum number of sample points available for all measurements is 512 K points (K = 1024). Time interval values range from 5.12 microseconds to 40,000 microseconds for both voltage and current measurements. Values above 5.12 microseconds are rounded to the nearest 5.12 microseconds increment. Values above 10.24 microseconds are rounded to the nearest 10.24 microseconds increment. Values above 20.48 µs are rounded to the nearest 20.48 microseconds increment.

Note that Keysight RPS models also support the **NPLC** (number of power line cycles) command to configure measurement tint and points as previously discussed. The NPLC command automatically increases the number of points to maintain the shortest possible time interval. If the maximum number of points for that time interval is reached, it increases the time interval.

## Measurement Triggering

- Capture pre-trigger data, if desired
- Select the trigger source
- Initiate the acquisition system
- Trigger the measurement
- Fetch the measurement
- Multiple trigger events per measurement

Use the acquisition trigger system to synchronize the digitized measurements with a trigger signal from a number of trigger sources. Then use FETCh commands to return voltage or current information from the acquired data.

The following figure illustrates the measurement acquisition process. This process applies to both measurement triggers and external data logging. For an overview of the trigger system, refer to [Trigger Overview](#).

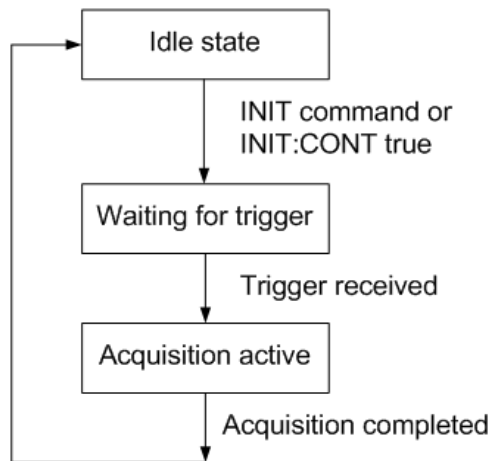

### Capture pre-trigger data, if desired

The measurement system lets you capture data before, after, or at the trigger signal. As shown in the following figure, you can move the block of data being read into the acquisition buffer with reference to the trigger. This allows pre- or post-trigger data sampling.

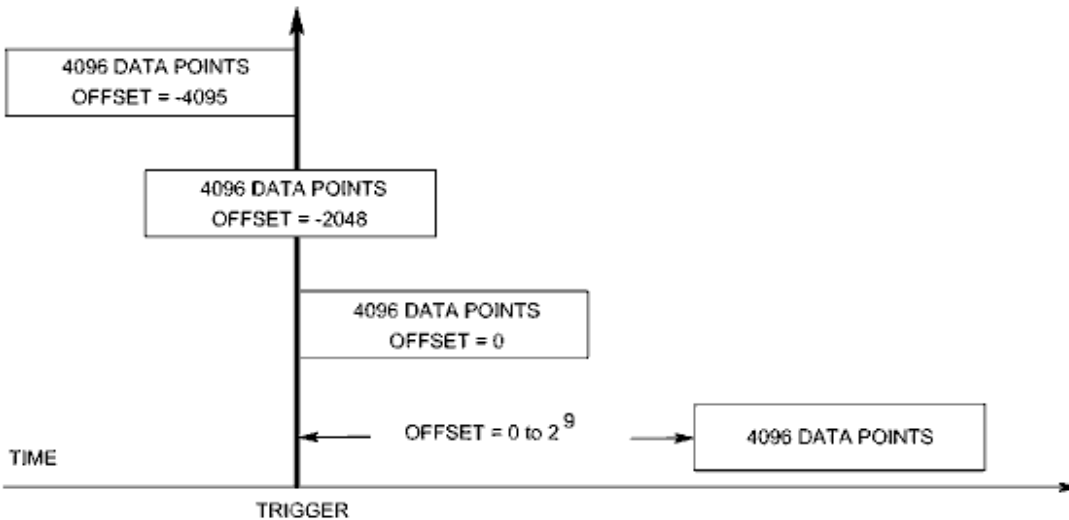

To offset the beginning of the acquisition buffer relative to the acquisition trigger:

Front Panel Menu Reference	SCPI Command
Select <b>Measure\Sweep</b> . Enter an Offset value. Then press <b>Select</b> .	To offset the measurement by 100 points: <b>SENS:SWE:OFFS:POIN 100</b>

When the value is 0, all measurement samples are taken after the trigger. Positive values represent the delay after the trigger occurs but before the samples are acquired. This can be used to exclude measurement samples that occur during the delay time. (Delay time = offset x sample period). Negative values represent data samples taken prior to the trigger. This lets you acquire measurement samples prior to the trigger.

### Select the trigger source

#### NOTE

A TRIGger:ACQuire[:IMMediate] command over the bus will always generate an immediate measurement trigger, regardless of the selected trigger source.

Unless you are using TRIGger:ACQuire[:IMMediate], select a trigger source from the following:

Trigger Source	Description
Bus	Selects GPIB device trigger, *TRG, or <GET> (Group Execute Trigger).
Current	Selects an output current level.
External	Selects ANY pin that has been configured as a trigger input on the digital control port.
Pin<1-7>	Selects a specific pin<n> that is configured as a Trigger Input on the digital control port.
Transient	Selects the unit's transient system. You must also set up the transient system to generate a trigger out signal. See <b>Programming Output Transients</b> .
Voltage	Selects an output voltage level.

Use the following commands to select a trigger source:

## 4 Using the Regenerative Power System

Front Panel Menu Reference	SCPI Command
Not available	To select Bus triggers: <b>TRIG:TRAN:SOUR BUS</b>  To select digital pin 5 as the trigger: <b>TRIG:ACQ:SOUR PIN5</b>  To select a voltage or current level: <b>TRIG:ACQ:SOUR VOLT</b> <b>TRIG:ACQ:SOUR CURR</b>  To select an output transient as trigger: <b>TRIG:ACQ:SOUR TRAN</b>

### Initiate the acquisition system

When the unit is turned on, the trigger system is in the idle state. In this state, the trigger system is disabled, ignoring all triggers. The INITiate commands enable the trigger system to receive triggers.

Front Panel Menu Reference	SCPI Command
Not available	To initiate the measurement trigger system: <b>INIT:ACQ</b>

It takes a few milliseconds for the instrument to be ready to receive a trigger signal after receiving the INITiate:ACQuire command. If a trigger occurs before the trigger system is ready for it, the trigger will be ignored. You can test the WTG\_meas bit in the operation status register to know when the instrument is ready to receive a trigger after being initiated.

Front Panel Menu Reference	SCPI Command
Select <b>Measure\Control</b> . The Trig state field indicates "Initiated".	To query the WTG_meas bit (bit 3): <b>STAT:OPER:COND?</b>

If bit 3 is set in the query response, the WTG\_meas bit is true, and the instrument is ready to receive the trigger signal. Refer to [Status Tutorial](#) for more information.

#### NOTE

The instrument executes one measurement acquisition each time a bus, pin, transient, or level trigger command is received. Thus, it will be necessary to initiate the trigger system each time a triggered measurement is desired.

### Trigger the Measurement

The trigger system is waiting for a trigger signal in the initiated state. You can immediately trigger the measurement as follows:

Front Panel Menu Reference	SCPI Command
Not available	To generate a measurement trigger: <b>TRIG:ACQ</b>  Alternatively, if the trigger source is BUS, you can also program a <b>*TRG</b> or an IEEE-488 <get> command.



As previously discussed, a trigger can also be generated by a digital pin, an output transient, and an output voltage or current level. If a digital pin is configured as the trigger source, the instrument will wait indefinitely for the trigger signal. If the trigger does not occur, you must manually return the trigger system to the idle state. The following commands return the trigger system to the idle state:

Front Panel Menu Reference	SCPI Command
Select <b>Measure\Control</b> . Then select the Abort control.	<b>ABOR:ACQ</b>

### Fetch the measurement

After a trigger is received and the measurement completes, the trigger system will return to the idle state. Once the measurement completes, FETCh queries can retrieve the most recent measurement data without initiating a new measurement or altering the data in the measurement buffer.

Front Panel Menu Reference	SCPI Command
Not available	To return rms voltage & current: <b>FETC:VOLT:ACDC?</b> <b>FETC:CURR:ACDC?</b>
	To return the high level of a pulse: <b>FETC:VOLT:HIGh?</b> <b>FETC:CURR:HIGh?</b>
	To return the low level of a pulse: <b>FETC:VOLT:LOW?</b> <b>FETC:CURR:LOW?</b>
	To return the maximum value: <b>FETC:VOLT:MAX?</b> <b>FETC:CURR:MAX?</b> <b>FETC:POW:MAX?</b>
	To return the minimum value: <b>FETC:VOLT:MIN?</b> <b>FETC:CURR:MIN?</b> <b>FETC:POW:MIN?</b>
	To return array data: <b>FETC:ARR:VOLT?</b> <b>FETC:ARR:CURR?</b> <b>FETC:ARR:POW?</b>

If a FETCh query is sent before the measurement is finished, the response will be delayed until the measurement trigger occurs and the acquisition completes. To prevent this from occurring, you can poll the MEAS\_active bit after the measurement is initiated to determine when the measurement is complete and then send the FETCh query.

You can test the MEAS\_active bit in the operation status register to know when the trigger system has returned to the idle state.

## 4 Using the Regenerative Power System

Front Panel Menu Reference	SCPI Command
Select <b>Measure\Control</b> . The Trig state field indicates "Idle".	To query the MEAS_active bit (bit 5): <b>STAT:OPER:COND?</b>

If bit 5 is set in the query response, the MEAS\_active bit is true, and the measurement is NOT complete. When the MEAS\_active bit is false, you can retrieve the measurement. Refer to **Status Tutorial** for more information.

### Multiple trigger events per measurement

The measurement system can capture other triggers that occur during the acquisition, return the number and position of those triggers, and calculate dc values based on a subset of the data surrounding those triggers. The basic concept is that a single long acquisition may contain several events of interest, and that these events are marked by locations where additional triggers occurred. The locations of these events are described as an index into the acquisition's store of acquired data. Indices range from 0 to 1 less than the number of acquired readings (see **SENse:SWEp:POINTs**).

You can query and return the indices where additional triggers occurred during the measurement. The number of indices returned matches the number of triggers that occurred.

Front Panel Menu Reference	SCPI Command
Not available	To query how many (if any) additional triggers occurred: <b>TRIG:ACQ:IND:COUN?</b>
	To return the indices where the triggers occurred: <b>TRIG:ACQ:IND?</b>

You can also return the actual measurement data that was captured after any of the aforementioned trigger indices.

Front Panel Menu Reference	SCPI Command
Not available	To return DC voltage or current calculated after the trigger indices: <b>FETC:VOLT? [&lt;start_index&gt;, &lt;points&gt;]</b> <b>FETC:CURR? [&lt;start_index&gt;, &lt;points&gt;]</b>
	To return instantaneous voltage or current data after the trigger indices: <b>FETC:ARR:VOLT? [&lt;start_index&gt;, &lt;points&gt;]</b> <b>FETC:ARR:CURR? [&lt;start_index&gt;, &lt;points&gt;]</b>

## External Data Logging

Select the Measurement Function

Specify the Integration Period

Select the Elog Trigger Source

Initiate and Trigger the Elog

Periodically Retrieve the Data

Terminate the Elog

### Introduction

#### NOTE

The external data logging function can only be programmed using SCPI commands.

Keysight RPS models have an "external" data logging function (Elog) that lets you continuously log voltage and current measurements. Data logging is external to the instrument because logging must be done using a PC to fetch recent measurements from the unit and then put them into a log file on the PC. Voltage and current measurement data is temporarily stored in a FIFO (first-in, first-out) buffer in the instrument. As this buffer is only large enough to hold about 20 seconds of data, you must periodically empty the buffer to an external log file; otherwise the data in the buffer will be overwritten.

The following table details the various data logging functions.

Function	Description
Data Storage	Buffers measurements for about 20 seconds and requires that the computer periodically reads measurements to prevent the internal buffer from overflowing. The computer needs to provide the external data storage.
Measurement Functions	Both output voltage and output current can be logged.
Integration Period	During the specified integration period, the samples are averaged, and min and max values are tracked.
Data viewing	No front panel view or control. Data is collected and viewed externally.

Note that the Elog function uses the **acquire trigger process** to make the measurements.

### Select the Measurement Function

The following commands select a measurement function:

Front Panel Menu Reference	SCPI Command
Not available	To enable voltage or current measurements: <b>SENS:ELOG:FUNC:VOLT ON</b> <b>SENS:ELOG:FUNC:CURR ON</b>  To enable min/max measurements: <b>SENS:ELOG:FUNC:VOLT:MINM ON</b> <b>SENS:ELOG:FUNC:CURR:MINM ON</b>

## Specify the Integration Period

The integration period can be set from a minimum of 102.4 microseconds to a maximum of 60 seconds.

Front Panel Menu Reference	SCPI Command
Not available	To set an integration period of 600 microseconds: <b>SENS:ELOG:PER 0.0006</b>

During the integration period, Elog samples are averaged, and the minimum and maximum values are tracked. At the end of each integration period the average, minimum, and maximum values are added to the internal FIFO buffer.

Although the absolute minimum integration period is 102.4 microseconds, the actual minimum depends on the number of measurements that are being logged. The formula is  $102.4_{\text{microseconds}} \times \#_{\text{of\_measurements}}$ . For example:

**102.4 microseconds:** 1 measurement (voltage or current)

**204.8 microseconds:** 2 measurements (voltage and current)

**409.6 microseconds:** 4 measurements (voltage+min+max+current)

If the specified integration period is at or near the minimum logging intervals, the data format must be specified as binary. If the REAL format is not specified, the data will be in ASCII format and the minimum logging intervals will typically be up to five times longer than what can be achieved with binary format.

Front Panel Menu Reference	SCPI Command
Not available	To set the data format to REAL: <b>FORM[:DATA] REAL</b>

## Select the Elog Trigger Source

The TRIGger:ELOG command generates an immediate trigger regardless of the trigger source. Unless you are using this command, select a trigger source from the following:

Trigger Source	Description
<b>Bus</b>	Selects GPIB device trigger, *TRG, or <GET> (Group Execute Trigger).
<b>External</b>	Selects ANY pin that has been configured as a trigger input on the digital control port.
<b>Immediate</b>	Triggers the measurement as soon as it is INITiated.
<b>Pin&lt;1-7&gt;</b>	Selects a specific pin<n> that is configured as a Trigger Input on the digital control port.

Use the following commands to select one of the available trigger sources:

Front Panel Menu Reference	SCPI Command
Not available	<p>To select Bus triggers: <b>TRIG:ELOG:SOUR BUS</b></p> <p>To select an immediate trigger: <b>TRIG:ELOG:SOUR IMM</b></p> <p>To select digital pin 5 as the trigger: <b>TRIG:ELOG:SOUR PIN5</b></p> <p>To select any pin configured as a trigger input: <b>TRIG:ELOG:SOUR EXT</b></p>

## Initiate and Trigger the Elog

When the power supply is turned on, the trigger system is in the Idle state. In this state, the trigger system is disabled, ignoring all triggers. The INITiate command enables the measurement system to receive triggers. To initiate and trigger the Elog:

Front Panel Menu Reference	SCPI Command
Not available	<p>To initiate the Elog: <b>INIT:ELOG</b></p> <p>To trigger the Elog: <b>TRIG:ELOG</b></p> <p>Alternatively, if the trigger source is BUS, you can also program a <b>*TRG</b> or an IEEE-488 &lt;get&gt; command.</p>

When triggered, the Elog starts placing data in the internal measurement buffer. Because the buffer is only large enough to hold 20 seconds of accumulated measurement your PC application must periodically retrieve (or fetch) the data from this buffer.

## Periodically Retrieve the Data

Each FETCh command returns number of requested records of the data in the buffer and removes them, making room available for more data. The Elog continues until it is aborted.

An Elog record is one set of voltage and current readings for one time interval. The exact format of a record depends on which functions have been enabled for Elog sensing. If all functions are enabled, then one record will contain the following data in the specified order:

- Current average
- Current minimum
- Current maximum
- Voltage average
- Voltage minimum
- Voltage maximum

Front Panel Menu Reference	SCPI Command
Not available	<p>To retrieve a maximum of 1000 records: <b>FETC:ELOG? 1000</b></p>

## 4 Using the Regenerative Power System

ASCII data (the default format) is returned as comma-separated ASCII numeric data sets of average/min/max values terminated by a newline. REAL data is returned as a definite length block, with the byte order specified by the FORMat:BORe command.

### Terminate the Elog

Front Panel Menu Reference	SCPI Command
Not available	To abort the Elog: <b>ABOR:ELOG</b>

## Programming the Digital Port

### Bi-Directional Digital I/O

### Digital Input only

### External Trigger I/O

### Fault Output

### Inhibit Input

### Fault/Inhibit System Protection

### Output Couple

## Digital Control Port

A Digital Control Port consisting of seven I/O pins is provided to access various control functions. Each pin is user-configurable. The following control functions are available for the I/O pins. See [SCPI Programming Reference](#) for details on the SCPI commands to program the Digital Port.

The following table describes the possible pin configuration for the digital port functions. For a complete description of the electrical characteristics of the digital control port, refer to the [Specifications](#) section.

Function	Description
DIO	General-purpose ground-referenced digital input/output function. The output can be set with <a href="#">[SOURCE:]DIGit-al:OUTPut:DATA</a> .
DINPut	Digital input-only mode. The digital output data of the pin is ignored.
FAULt	Applies only to pin 1. Pin 1 functions as an isolated fault output. The fault signal is true when any output is in a protected state. Pin 2 serves as the isolated common for pin 1. When pin 1 is set to the FAULt function, the instrument ignores any commands to program pin 2. Queries of pin 2 will return FAULt. If pin 1 is changed from FAULt to another function, pin 2 is set to DINPut.
INHibit	Applies only to pin 3. When pin 3 is configured as an inhibit input; a true signal at the pin will disable the output.
ONCOuple	Applies only to pins 4-7. The ONCOuple pin synchronizes the output On state between instruments. Only one pin can be configured as an ONCOuple. The pin functions as both an input and an output.
OFFCOuple	Applies only to pins 4-7. The OFFCOuple pin synchronizes the output Off state between instruments. Only one pin can be configured as an OFFCOuple. The pin functions as both an input and an output.
TINPut	A trigger input pin can be selected as the source for measurement and transient trigger signals. See <a href="#">TRIGger-:ACQuire:SOURce</a> and <a href="#">TRIGger:TRANsient:SOURce</a>
TOUTput	A trigger output pin will generate output triggers from any subsystem that has been configured to output trigger signals.
Common	Applies only to pin 8. Connected to ground.

## 4 Using the Regenerative Power System

In addition to the configurable pin functions, the signal polarity (Positive or Negative) for each pin is also configurable. For level signals, POSitive indicates a voltage high at the pin. NEGative indicates a voltage low at the pin. For edge signals, POSitive means a rising edge and NEGative means a falling edge.

### Bi-Directional Digital I/O

Each of the seven pins can be configured as general purpose bi-directional digital inputs and outputs. The polarity of the pins can also be configured. Pin 8 is the signal common for the digital I/O pins. Data is programmed according to the following bit assignments:

Pin	7	6	5	4	3	2	1
Bit Weight	6 (MSB)	5	4	3	2	1	0 (LSB)

The digital I/O pin can be used to control both relay circuits as well as digital interface circuits. The following figure illustrates typical relay circuits as well as digital interface circuit connections using the digital I/O functions

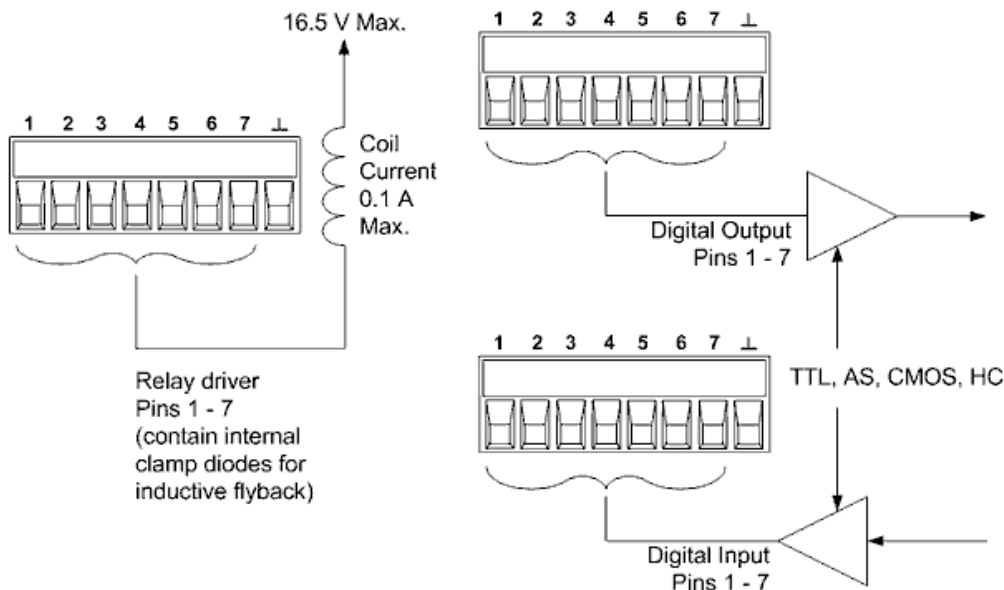

To configure the pins for digital I/O:

Front Panel Menu Reference	SCPI Command
Select <b>System\IO\DigPort\Pins</b> .	To select the pin function: <b>DIG:PIN&lt;1-7&gt;:FUNC DIO</b>
Select a pin in the Pin field.	
In the Function field, select Dig IO.	To select the pin polarity: <b>DIG:PIN&lt;1-7&gt;:POL POS</b>
In the Polarity field, select either Positive or Negative.	
To send data to the pins, select <b>System\IO\DigPort\Data</b> .	To configure pins 1 through 7 as "0000111": <b>DIG:OUTP:DATA 7</b>
Select the Data Out field and enter the binary word.	



## Digital Input

Each of the seven pins can be configured as digital input only. The polarity of the pins can also be configured. Pin 8 is the signal common for the digital input pins. The pin status reflects the true condition of the external signal that is applied to the pin. The pin state is not affected by the setting of DIGital:OUTPut:DATA. To configure the pins for digital input only:

Front Panel Menu Reference	SCPI Command
Select <b>System\IO\DigPort\Pins</b> . Select a pin in the Pin field.	To select the pin function: <b>DIG:PIN&lt;1-7&gt;:FUNC DINP</b>
In the Function field, select <b>Dig In</b> . In the Polarity field, select either Positive or Negative.	To select the pin polarity: <b>DIG:PIN&lt;1-7&gt;:POL POS</b>
To read the data from the pins, select <b>System\IO\DigPort\Data</b> . The input data is displayed as a binary number in the Data In field.	To read the data on the pins: <b>DIG:INP:DATA?</b>

## External Trigger I/O

Each of the seven pins can be configured as trigger inputs or trigger outputs. The polarity of the pins can also be configured. When you program trigger polarity, POSitive means a rising edge and NEGative means a falling edge. Pin 8 is the signal common for the trigger pins. For an overview of the trigger system, refer to [Trigger Overview](#).

When configured as a trigger input, you can apply either a negative-going or a positive-going pulse to the designated trigger input pin. The trigger latency is 5 microseconds. The minimum pulse width is 4 microseconds for positive-going signals, and 10 microseconds for negative-going signals. The pin's polarity setting determines which edge generates a trigger-in event.

When configured as a trigger output, the designated trigger pin will generate a 10 microsecond-wide pulse when a Trigger Out occurs. Depending on the polarity setting, it can be either positive-going (rising edge) or negative-going (falling-edge) when referenced to common.

Front Panel Menu Reference	SCPI Command
Select <b>System\IO\DigPort\Pins</b> . Select a pin in the Pin field.	To select the trigger output function for pin 1: <b>DIG:PIN1:FUNC TOUT</b>
In the Function field, select either the Trig In or Trig Out function. In the Polarity field, select either Positive or Negative.	To select the trigger input function for pin 2: <b>DIG:PIN2:FUNC TINP</b>  To select the pin polarity: <b>DIG:PIN1:POL POS</b> <b>DIG:PIN2:POL POS</b>

## Fault Output

Pins 1 and 2 can be configured as a fault-output pair. The Fault Output function enables a fault condition to generate a protection fault signal on the digital port. Refer to **Programming Output Protection** for a list of protection signals.

Both pins 1 and 2 are dedicated to this function. Pin 1 is the Fault output; pin 2 is the common for pin 1. This provides for an optically-isolated output. The polarity of pin 1 can also be configured. When the pin polarity is POSitive, a fault condition causes the isolated output to conduct. Note that the Fault output signal remains latched until the fault condition is removed and the protection circuit is cleared. as explained under **Clear Output Protection**.

### NOTE

Pin 2's selected function is ignored. Pin 2 should be connected to the ground of the external circuit.

Front Panel Menu Reference	SCPI Command
Select <b>System\IO\DigPort\Pins</b> .	To configure the Fault function: <b>DIG:PIN1:FUNC FAUL</b>
Select pin 1, then Function, then Fault Out.	
In the Polarity field, select either Positive or Negative.	To select the pin polarity: <b>DIG:PIN1:POL POS</b>

## Inhibit Input

Pin 3 can be configured as a remote inhibit input. The Inhibit Input function lets an external input signal control the output state of instrument. The input is level triggered. The signal latency is 5 microseconds. Pin 8 is the common for pin 3. The following non-volatile inhibit input modes can be programmed:

**LATCHing** - causes a logic-true transition on the Inhibit input to disable the output. The output will remain disabled after the inhibit signal is received.

**LIVE** - allows the enabled output to follow the state of the Inhibit input. When the Inhibit input is true, the output is disabled. When the Inhibit input is false, the output is re-enabled.

**OFF** - The Inhibit input is ignored.

To configure the Inhibit Input function:

Front Panel Menu Reference	SCPI Command
Select <b>System\IO\DigPort\Pins</b> .	To select the Inhibit function: <b>DIG:PIN3:FUNC INH</b>
Select pin 3, then Function, then Inhibit In.	
In the Polarity field, select either Positive or Negative.	To select the pin polarity: <b>DIG:PIN3:POL POS</b>
Select <b>Protect\Inhibit</b> .	
Select either Latching or Live.	To specify the Inhibit mode: <b>OUTP:INH:MODE LATC</b>
To disable the Inhibit signal, select Off.	<b>OUTP:INH:MODE LIVE</b> <b>OUTP:INH:MODE OFF</b>

## Fault/Inhibit System Protection

As shown in the following figure, when the Fault outputs and Inhibit inputs of several instruments are daisy-chained, an internal fault condition in one of the units will disable all outputs without intervention by either the controller or external circuitry. Note that when using the Fault/Inhibit signals in this manner, both signals must be set to the same polarity.

Also, as shown in the figure, you can also connect the Inhibit input to a manual switch or external control signal that will short the Inhibit pin to common whenever it is necessary to disable all outputs. **Negative** polarity must be programmed for all pins in this case. You can also use the Fault output to drive an external relay circuit or signal other devices whenever a protection fault occurs.

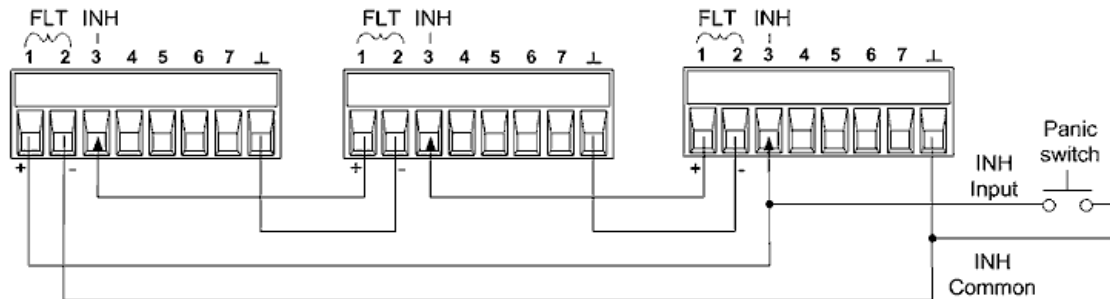

## Clearing a System Protection Fault

To restore all instruments to a normal operating condition when a fault condition occurs in a daisy-chained system protection configuration, two fault conditions must be removed:

1. The initial protection fault or external Inhibit signal.
2. The subsequent daisy-chained fault signal (which is sourced by the Inhibit signal).

### NOTE

Even when the initial fault condition or external signal is removed, the fault signal is still active and will continue to shut down the outputs of all the units.

To clear the daisy-chained fault signal if the operating mode of the Inhibit input is Live, simply clear the output protection on any ONE unit as explained under **Clearing Protection Functions**. If the operating mode of the Inhibit input is Latched, turn off the Inhibit input on ALL units individually. To re-enable the chain, re-program the Inhibit input on each unit to Latched mode.

## Output Couple Control

This function lets you connect multiple instruments together and synchronize the output on/off sequence across all units. Each unit that will be sequenced must also be "coupled" to the other units.

1. Couple the output on each unit as described under **Sequencing the Output**.
2. Set the delay offset of each individual unit to match the longest delay offset of the group.
3. Connect and configure the digital connector pins of the sequenced units as shown below.

## 4 Using the Regenerative Power System

Only pins 4 through 7 can be configured as "coupled" pins. The designated pins will function as both an input and an output, with a negative transition on one pin providing the sequence signal to the other pins. The polarity of the pins is not programmable; it is set to NEGative.

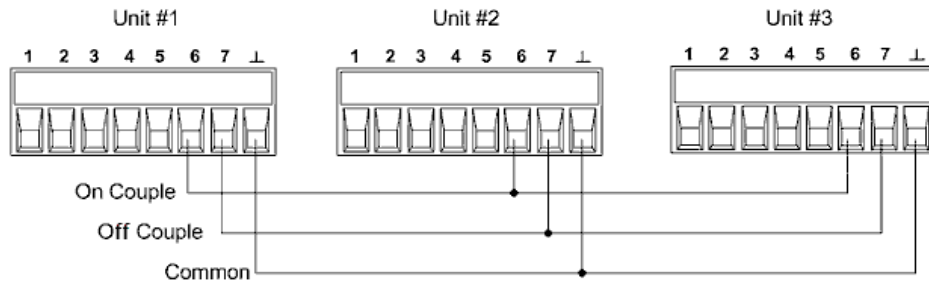

In this example, pin 6 is configured as the output On control. Pin 7 is configured as the output Off control. The ground or Common pins are connected together.

Front Panel Menu Reference	SCPI Command
Select <b>System\IO\DigPort\Pins</b> .	To set pin 6 of unit 1 as the ON control:
Select pin 6, then Function, then On Couple.	<b>DIG:PIN6:FUNC ONC</b>
Select <b>Pins.</b> , select pin7, then Function, then Off Couple.	To configure pin 7 of unit 1 as the OFF control:
Repeat these steps for units #2 and #3	<b>DIG:PIN7:FUNC OFFC</b>
	Repeat commands for units 2 and 3.

Once configured and enabled, turning the output on or off on any coupled unit will cause all coupled units to turn on or off according to their user-programmed delays.

## System-Related Operations

Though not directly related to output programming, these functions also control instrument operation.

### Instrument Identification

### Instrument State Storage

### Front Panel Display

### Front Panel Lock-Out

### Password Protection

## Instrument Identification

You can query the model number, serial number, options, and firmware revision. SCPI commands return information with the \*IDN? and \*OPT? queries.

Front Panel Menu Reference	SCPI Command
Select <b>System\About\Frame</b> .	To return manufacturer, model number, serial number, and firmware revision: <b>*IDN?</b> To return the installed options: <b>*OPT?</b>

## Instrument State Storage

The power supply has ten storage locations in non-volatile memory to store instrument states. The states are numbered 0 through 9. Any state previously stored in the same location will be overwritten.

Front Panel Menu Reference	SCPI Command
Select <b>States\SaveRecall</b> .	To save a state in location 1:
In the SaveRecall field, enter a location from 0 to 9.	<b>*SAV 1</b>
Then press <b>Select</b> .	To recall a state from location 1:
Select <b>Save</b> to save the state to <b>Recall</b> to recall a state.	<b>*RCL 1</b>

- For 30 kW units only, when an operating state is saved when the unit is operating on a specific ac line voltage, and the ac line voltage is subsequently changed, an error (341) will occur.

### Specifying a power-on state

When shipped, the power supply is configured to automatically recall the reset (\*RST) settings at power-on. However, you can configure the power supply to use the settings you have stored in memory location 0 at power-on.

Front Panel Menu Reference	SCPI Command
Select <b>States\PowerOn</b> .	<b>OUTP:PON:STAT RCL0</b>
Select <b>Recall State 0</b> . Then press <b>Select</b> .	

## Front Panel Display

The power supply has a front panel screen saver that significantly increases the life of the LCD display by dimming it during periods of inactivity. The delay can be set from 30 to 999 minutes in 1 minute increments. As shipped, the screen saver comes on one hour after activity on the front panel or interface has ceased.

When the screen saver is active, the front panel display turns off, and the LED next to the Line switch turns from green to amber. To restore the front panel display, simply press one of the front panel keys. The first action of the key turns the display on. Subsequently, the key will revert to its normal function.

If the Wake on I/O function is selected, the display is restored whenever there is activity on the remote interface. This also resets the timer on the screen saver. As shipped, Wake on I/O is active.

Front Panel Menu Reference	SCPI Command
Select <b>System\Preferences\Display\Saver</b> Enable or disable the screen saver by checking or unchecking the Screen Saver checkbox. Then press <b>Select</b> . Enter a value in minutes in the Saver Delay field to specify the time when the screen saver will activate. Check Wake on I/O to activate the display with I/O bus activity.	To turn the front panel screen saver on or off: <b>DISP:SAV ON OFF</b>

## Specifying the power-on view

You can specify which measurement functions are displayed at power-on as follows. However, the SCPI commands only change the present view; not the power-on view.

Front Panel Menu Reference	SCPI Command
Select <b>System\Preferences\Display\View</b> . From the dropdown menu select: Voltage,Current; Voltage,Power; or Volt,Curr,Power. Then press <b>Select</b> .	To change the present meter view: <b>DISP:VIEW METER_VI</b> <b>DISP:VIEW METER_VP</b> <b>DISP:VIEW METER_VIP</b>

## Front Panel Lock-Out

You can lock the front panel keys to prevent unwanted control of the instrument from the front panel. This is the most secure way of locking the front panel keys because you need a password to unlock the front panel. This parameter is saved in non-volatile memory. Therefore, the front panel remains locked even after ac power is cycled.

Front Panel Menu Reference	SCPI Command
Select <b>System\Preferences\Lock</b> In the dialog box, enter the password to unlock the front panel. Then select Lock.	Not available

The menu to unlock the front panel appears every time a key is pressed. Enter the password to unlock the front panel.

**NOTE**

If the password is lost, the **SYSTem:PASSword:FPANel:RESet** command can reset the front panel lockout password.

The **SYSTem:COMMunicate:RLState RWLock** command can also lock and unlock the front panel. This command is completely independent of the front panel lockout function. If you use this command to lock the front panel, the front panel will be unlocked when ac power is cycled.

## Password Protection

You can password-protect all functions located in the Admin menu. These include: instrument calibration, interface access, non-volatile memory reset, firmware update, password updates.

As shipped, the Admin menu password is 0 (zero). This means that you do not have to enter a password to access the Admin menu. Simply select **System\Admin>Login** and press Enter. To password-protect the Admin menu:

Front Panel Menu Reference	SCPI Command
Select <b>System\Admin&gt;Password</b>	Enter calibration mode using the original password <b>CAL:STAT ON, &lt;password&gt;</b>
Enter a numeric password, up to 15 digits long. Then press Select.	To change the password: <b>CAL:PASS &lt;password&gt;</b>
Log out of the Admin menu to activate the password. You can now only enter the Admin menu by providing the correct password in the Password field.	To exit calibration mode and activate the password: <b>CAL:STAT OFF</b>

If the password is lost, access can be restored by setting an internal switch to reset the password to 0. If the message “Locked out by internal switch setting” or “Calibration is inhibited by switch setting” appears, the internal switch is set to prevent the password from being changed. Refer to **Calibration Switches** for more information.

## Clock Setup

The system clock is used to provide time stamp information for the BenchVue Power Control and Analysis software, which is its only function. When shipped, the system clock is set to Greenwich mean time. To set the clock:

Front Panel Menu Reference	SCPI Command
Select <b>System\Preferences\Display\Clock</b> .	To set the date: <b>SYSTem:DATE 2018,06,30</b>
Enter the date in the Month, Day and Year fields.	To set the time: <b>SYSTem:TIME 20,30,0</b>
Enter the time in the Hour, Minute, and Second fields. Press Select to set the date and time.	

## Photovoltaic (SAS) Operation

### Introduction

### Programming Curve Parameters

### Programming Table Parameters

### Programming Multiple Tables

### Programming Additional Parameters

### SAS Command Details

### Troubleshooting

### Model Equations

#### NOTE

The Keysight **DG9000** Advanced/multi-input PV inverter test software lets you control the output of from one to twelve RPS instruments.

## Introduction

Keysight RPS instruments only operate as a solar array simulator when the SAS:MODE command specifies either Curve or Table mode.

In Curve mode, a solar array characteristic is created from four input parameters and a curve shape (either space or terrestrial):

**Imp** – the current at the maximum power point

**Isc** – the short-circuit current

**Vmp** – the voltage at the maximum power point

**Voc** – the open-circuit voltage

In Table mode, a solar array characteristic is created from three to 1024 voltage and current points.

You can specify solar array operation as follows:

Front Panel Menu Reference	SCPI Command
Select <b>Output\Mode</b> . Under SAS mode, select Curve or Table. Select Fixed to exit SAS mode. Then press <b>Select</b> .	Specify the SAS operation: <b>SAS:MODE CURV</b> <b>SAS:MODE TABL</b> <b>SAS:MODE FIX</b> (to exit)

- The output is turned off when switching between Fixed mode and Curve or Table modes.
- When switching between Fixed and Curve/Table modes, all settings will be returned to their \*RST values.
- When switching between Curve and Table modes, solar array settings will be preserved.



The front panel display indicates when the instrument is operating as a solar array simulator, in either Curve or Table modes. The settings shown on the display are the true  $V_{mp}$  and  $I_{mp}$  values. These values are calculated based on the running curve parameters or table points.

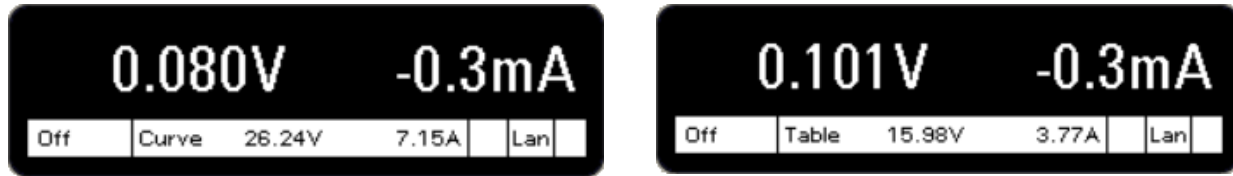

## Programming the Curve Parameters

In Curve mode, the output has an I-V characteristic that follows a mathematical model of a solar array. You must first specify the set of equations on which the curve is based – either space or terrestrial. Refer to [SAS Equations](#), where the model equations are listed.

Front Panel Menu Reference	SCPI Command
Select <b>Output\SAS\Curve\Shape</b> . Specify either Space or Terrestrial. To activate the shape, select Set Curve in the Curve\Settings dialog (see below).	Specify the curve shape: <b>SAS:CURV:SHAP SPACe</b> <b>SAS:CURV:SHAP TERRestrial</b>

After specifying the shape, you must specify I-V characteristic of the curve using the four parameters:  $I_{mp}$ ,  $I_{sc}$ ,  $V_{mp}$ , and  $V_{oc}$ . These can be programmed individually, but when programming a new curve, it is best to send all of the curve parameters on the same line. this method effects an instant curve change.

The curve parameters can be entered in any order – the instrument determines if all parameters are within acceptable limits. Any parameter not programmed retains the value of the previously programmed curve.

Front Panel Menu Reference	SCPI Command
Select <b>Output\SAS\Curve\Settings</b> . In the dialog, enter a value for each of the four I-V curve parameters. Then press <b>Set Curve</b> .	Specify the $I_{mp}$ , $I_{sc}$ , $V_{mp}$ , and $V_{oc}$ on the same line: <b>SAS:CURV:IMP &lt;n&gt;; ISC &lt;n&gt;; VMP &lt;n&gt;; VOC &lt;n&gt;</b>

- If the curve parameters are sent individually, an error can occur if the parameter value is outside the allowable curve characteristic determined by the three existing parameters. Additionally, it may take up to four curve changes to obtain the final curve.

## Programming the Table Parameters

In this mode, a table of I-V points specifies the curve. A table can be programmed with a maximum of 1024 I-V points per table. Table values are **not** saved as part of the instrument state. You can load up to two tables into instrument memory. The table lists must satisfy the following requirements.

## 4 Using the Regenerative Power System

For both current and voltage lists:

- The number of points in each list can range from 3 to 1024.
- Both lists must contain the same number of points.

For the voltage list:

- The first value must be 0 (a range of  $\pm 10$  mV is allowed).
- The point values must be strictly monotonically increasing. Adjacent values cannot be equal.

For the current list:

- The point values must be monotonically decreasing. Adjacent values cannot be equal.
- The last value must be 0 (a range of  $\pm 0.3$  mA is allowed).

Use the following commands to program the table parameters into the instrument's memory:

Front Panel Menu Reference	SCPI Command
Not available	To program a current table list: <code>SAS:TABL[1 2]:CURR &lt;current&gt;{,&lt;current&gt;}</code>  To program a voltage table list: <code>SAS:TABL[1 2]:VOLT &lt;voltage&gt;{,&lt;voltage&gt;}</code>

Use the following command to activate the table, which runs the curve using the table points.

Front Panel Menu Reference	SCPI Command
Select <b>Output\SAS\Table</b> . Select either table 1 or table 2.	To activate the current and voltage tables: <code>SAS:TABLE:ACT 1</code>

- If the points do not represent a valid data set, an error will be generated.

Use the following commands to query the number of data points in the current and voltage tables.

Front Panel Menu Reference	SCPI Command
Select <b>Output\SAS\Table</b> . The dialog shows which table is active.	To query the current and voltage table points: <code>SAS:TABL[1 2]:CURR:POIN?</code> <code>SAS:TABL[1 2]:VOLT:POIN?</code>

### Programming Multiple Tables

#### NOTE

If no table number is specified [1 or 2], the commands default to Table 1.

As previously discussed, and shown in the top part of the following diagram, SAS:TABLE commands load voltage or current data into the memory of the instrument. To use a table once it has been loaded into memory, it must be transferred into the SAS system location. The SAS:TABLE:ACTivate command moves (updates) the data into the SAS system and selects the table for the power stage.

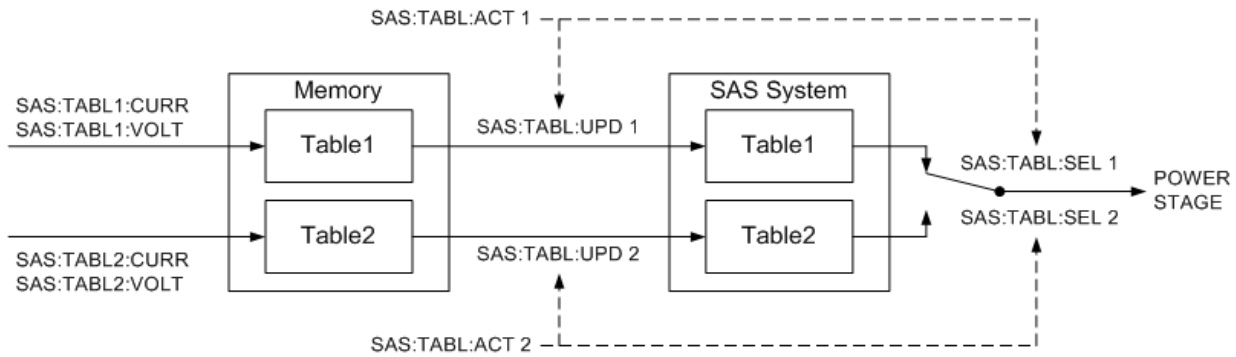

To quickly switch between tables to generate different curve characteristics, you can transfer data from two tables into the SAS system location using SAS:TABLE:UPDate ahead of time, and then instantly switch the power stage from one to the other using SAS:TABLE:SElect. The tables will be switched without turning the output off.

It is also possible to use the SAS:TABLE:ACTivate command to perform the same function as SAS:TABLE:UPDate and SAS:TABLE:SElect. However, because it takes a considerable amount of time to load data from memory into the SAS system, you cannot instantly switch from one table to another using only the SAS:TABLE:ACTivate command.

A sequence of tables can be executed by loading a table into table1 and selecting it. Then a new table can be loaded into table2 and selected. A third table can then be loaded into table1 and so on.

Front Panel Menu Reference	SCPI Command
Not available	To update the table in the SAS system: <b>SAS:TABL:UPD 1</b>

- An error will be generated if the points do not represent a valid data set.
- You can update both tables in the SAS system.
- Updating a table that is presently selected will impact the running curve.
- The update command only updates the table. It does not select the table.

Once loaded into the SAS system, you can then use the SAS:TABLE:SElect command to run the table. You can also use this command to switch between the two tables in the SAS system location without turning off the output.

Front Panel Menu Reference	SCPI Command
Not available	To select and run table 1 in the SAS system: <b>SAS:TABL:SEL 1</b> to switch and run table 2 <b>SAS:TABL:SEL 2</b>

## Programming Additional Parameters

### Scale Factors

You can program scale factors for the current and voltage SAS curves.

Front Panel Menu Reference	SCPI Command
Select <b>Output\SAS\Scale</b> . Enter a scale factor in percent for the current and/or voltage tables. Then press <b>Select</b> .	To program current and voltage scale factors: <b>SAS:SCAL:CURR &lt;percent&gt;</b> <b>SAS:SCAL:VOLT &lt;percent&gt;</b>

- This function is active in both Curve and Table modes. All of the voltages and currents on the SAS curve are multiplied by these scale factors.
- The scale factor settings take effect immediately without turning off the output.

### Bandwidth

There are two SAS bandwidth ranges available to optimize for stability or performance for a wide variety of inverter devices. These ranges apply in both Curve and Table modes.

0 - the slow bandwidth range is stable when testing a wide variety of inverter devices.

1 - the fast bandwidth range is optimized for inverter devices with faster MPPT algorithms.

Front Panel Menu Reference	SCPI Command
Select <b>Output\SAS\Bandwidth</b> . Select the bandwidth range: 0 slow or 1 fast. Then press <b>Select</b> .	To program the SAS bandwidth: <b>SAS:BWID:RANG 0   1</b>

## SAS Command Details

In primary/secondary operation, all SAS commands must be sent to the primary unit. Secondary units are locked; you cannot program the settings of the secondary units.

The following SCPI commands are not supported in SAS mode:

CALibrate:STATe	Enable calibration mode
CURRent:BWIDth	all CURR:BWID commands
CURRent[:LEVel]	all CURR[:LEV] commands
CURRent:LIMit	all CURR:LIM commands
CURRent:MODE STEP LIST ARB	all CURR:MODE commands except FIXEd
CURRent:PROTection:STATe	Enable current protection state
CURRent:SLEW	Current slew setting
FUNction CURR VOLT	Priority mode setting
OUTput[:STATe]:TMODe	Output turn-on mode

VOLTage:BWIDth	all VOLT:BWID commands
VOLTage[:LEVel]	all VOLT[:LEV] commands
VOLTage:LIMit	all VOLT:LIM commands
VOLTage:MODE STEP LIST ARB	all VOLT:MODE commands except FIXEd
VOLTage:RESistance	all VOLT:RES commands

The following SAS commands are not available in Curve mode.

TABLE:ACTivate 1 2	Activates a table
TABLE:SELEct 1 2	Selects a table
TABLE:UPDate 1 2	Updates a table

## Troubleshooting

In normal solar array operation, the front panel status annunciator reports CC (constant-current) status. If the solar array curve operates outside the normal operating boundaries, the front panel status annunciator reports either VL+ (positive voltage limit) or CL- (negative current limit) status.

Most SAS errors involve curve and table parameters being outside of the acceptable parameter limits. For example:

**Error 335, VMP must be less than VOC** (when the curve shape is set to Space)

**Error 337, IMP must be less than or equal to ISC** (when the curve shape is set to Space)

**Error 336, VMP must be less than 0.99 \* VOC** (when the curve shape is set to Terrestrial)

**Error 338, IMP must be less than 0.99 \* ISC** (when the curve shape is set to Terrestrial)

Other errors can occur if the VMP or IMP is less than the allowable range of values, if the computed (or true) VOC exceeds the maximum voltage setting of the instrument, or if the slope of the curve is greater than the allowable maximum  $dI/dV$  of 1.947.

**Error 339, VMP and/or IMP too small**

**Error 340, Computed VOC exceeds max voltage setting** (when the curve shape is set to Terrestrial)

**Error 315, Settings conflict error;  $dI/dV$  is <calculated value>, maximum is 1.947**

## Model Equations

When operating in Curve mode, you may select from two sets of equations to model a solar array. These are referred to as the space curve shape and terrestrial curve shape. Refer to the **SASimulator:CURVe:SHAPE** command.

### Space Curve Shape

The following equations describe the solar array simulator space model using the parameters  $R_s$ ,  $N$ , and  $a$ , which are defined as functions of the four input parameters  $V_{oc}$ ,  $V_{mp}$ ,  $I_{sc}$ , and  $I_{mp}$ .

$$R_s = \frac{V_{oc} - V_{mp}}{I_{mp}}$$

#### 4 Using the Regenerative Power System

$$N = \frac{\ln(2 - 2^a)}{\ln\left(\frac{I_{mp}}{I_{sc}}\right)}$$

$$a = \frac{V_{mp}\left(1 + \frac{R_s I_{sc}}{V_{oc}}\right) + R_s(I_{mp} - I_{sc})}{V_{oc}}$$

$$V = \frac{\frac{V_{oc} \ln\left(2 - \left(\frac{I}{I_{sc}}\right)^N\right)}{\ln(2)} - R_s(I - I_{sc})}{1 + \frac{R_s I_{sc}}{V_{oc}}}$$

This model is described in the paper: Britton, Lunscher, and Tanju, "A 9 KW High-Performance Solar Array Simulator", Proceedings of the European Space Power Conference, August 1993 (ESA WPP-054, August 1993)

#### Terrestrial Curve Shape

The following equations describe the solar array simulator terrestrial model using the parameters  $I_0$  and  $C_{aq}$ , which are defined as functions of the four input parameters  $V_{oc}$ ,  $V_{mp}$ ,  $I_{sc}$ , and  $I_{mp}$ .

$$I_0 = I_{sc} \left(1 - \frac{I_{mp}}{I_{sc}}\right)^{\frac{1}{1 - \frac{V_{mp}}{V_{oc}}}}$$

$$C_{aq} = \frac{\frac{V_{mp}}{V_{oc}} - 1}{\ln\left(1 - \frac{I_{mp}}{I_{sc}}\right)}$$

$$I = I_{sc} - I_0 \left(e^{\frac{V}{V_{oc} C_{aq}}} - 1\right)$$

The above equations are derived from equations C.9, C.10, and C.5 in European Standard EN50530 (April 2010), "Overall efficiency of grid connected photovoltaic inverters".

These equations also are mathematically equivalent to equations 8, 9, and 7 in the Sandia Inverter Performance Test Protocol, "Performance Test Protocol for Evaluating Inverters Used in Grid-Connected Photovoltaic Systems". To establish this equivalence, the following variable substitutions must be made:

EN 50530	Sandia
$I_0$	$I_{sc} * C_1$
$C_{aq}$	$C_2$

## Priority Mode Tutorial

### Voltage Priority

### Current Priority

### Voltage Priority

In voltage priority mode, the output is controlled by a constant-voltage feedback loop, which maintains the output voltage at its programmed setting as long as the load current remains within the positive or negative current limit settings. Voltage priority mode is best suited for use with resistive or high impedance loads, and loads that are sensitive to voltage overshoots. Do not use voltage priority mode with low-impedance sources such as batteries, power supplies, or large charged capacitors.

In voltage priority mode, the output voltage should be programmed to the desired value. A positive and negative current limit value should also be set. The current limit should always be set to a value that is greater than the actual output current requirement of the external load. The following figure shows the voltage priority operating locus of the output. The area in the white quadrants shows the output as a source (sourcing power). The shaded quadrants show the output as a load (sinking power).

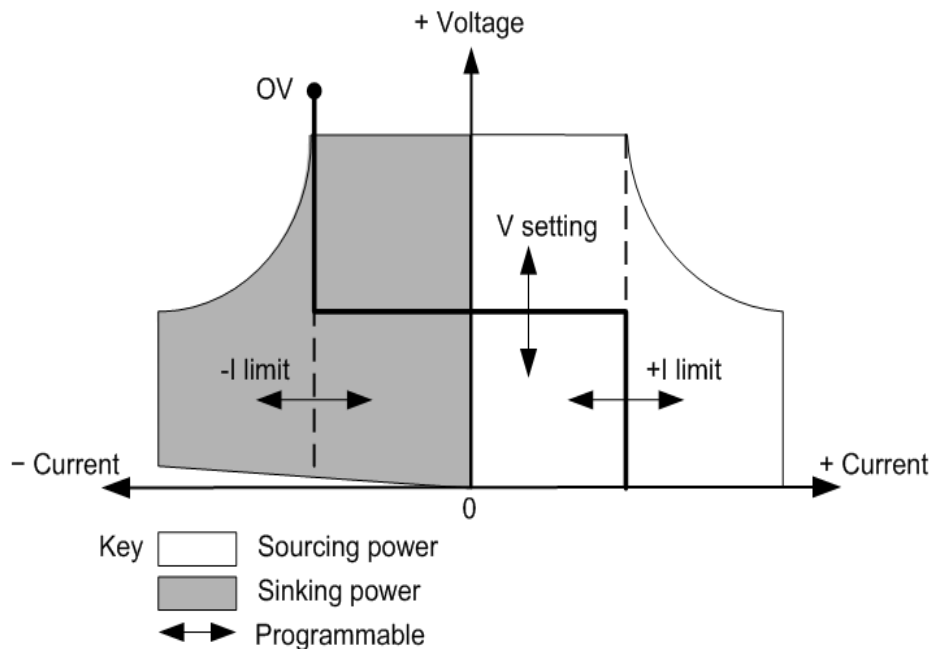

The heavy solid line illustrates the locus of possible operating points as a function of the output load. As shown by the horizontal portion of the line, the output voltage remains regulated at its programmed setting as long as the load current remains within the positive or negative current limit setting. A CV (constant voltage) status indicates that the output voltage is being regulated and the output current is within its limit settings.

Note that when the output current reaches the positive or negative current limit, the unit no longer operates in constant voltage mode and the output voltage is no longer held constant. Instead, the power supply will now regulate the output current at its current limit setting. A LIM+ (positive current

limit), or LIM- (negative current limit) status is set to indicate that a current limit has been reached. These conditions are annunciated by CL+ or CL- on the front panel.

As shown by the vertical portions of the load line, the output voltage may continue to increase in the positive direction or decrease in the negative direction as current is forced into or pulled out of the unit. When the output voltage exceeds the over-voltage protection setting, the output will shut down, the output relays will open, and the OV status bit will be set.

### Current Priority

In current priority mode, the output is controlled by a bi-polar constant current feedback loop, which maintains the output source or sink current at its programmed setting. The output current remains at its programmed setting, provided the load voltage remains within the voltage limit setting. Current priority mode is best suited for use with batteries, power supplies, large charged capacitors, and loads that are sensitive to current overshoots. It minimizes current overshoots during programming, turn-on, and turn-off transitions and seamlessly transitions between positive and negative currents.

In current priority mode, the output current should be programmed to the desired positive or negative value. A positive voltage limit value should also be set. The voltage limit should always be set to a value that is greater than the actual output voltage requirement of the external load. The following figure shows the current priority operating locus of the output. The area in the white quadrants shows the output as a source (sourcing power). The shaded quadrants show the output as a load (sinking power).

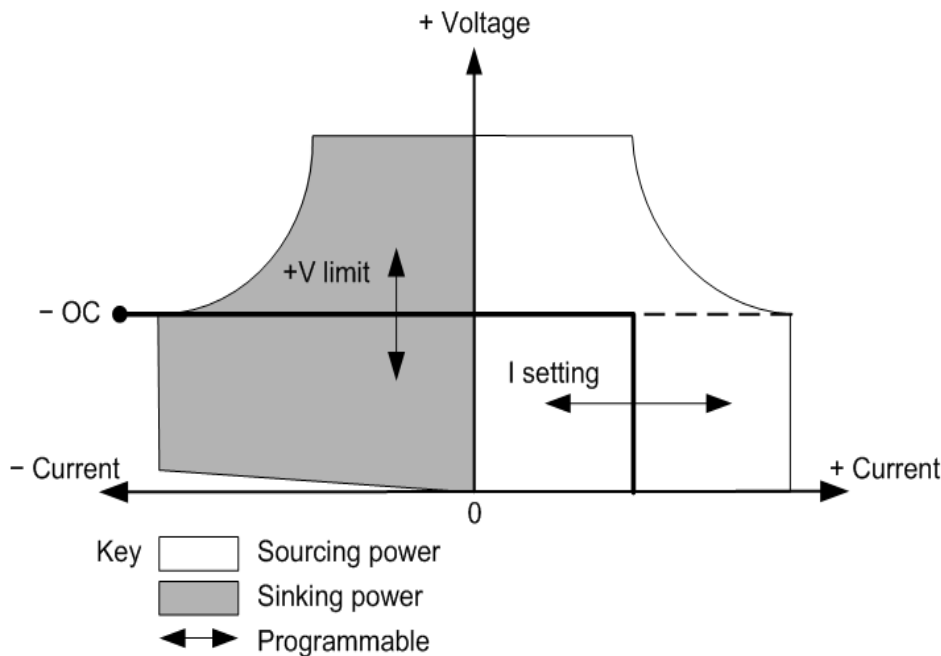

The heavy solid line illustrates the locus of possible operating points as a function of the output load. As shown by the vertical portion of the line, the output current remains regulated at its programmed setting as long as the output voltage remains within its limit setting. A CC (constant current) status indicates that the output current is being regulated and the output voltage is within its limit settings.



Note that when the output voltage reaches the voltage limit, the unit no longer operates in constant current mode and the output current is no longer held constant. Instead, the power supply will now regulate the output voltage at its voltage limit setting. A LIM+ (positive voltage limit) status is set to indicate that the voltage limit has been reached. This condition is annunciated by VL+ on the front panel.

As shown by the horizontal portion of the load line, when the unit is sinking power, the output current may continue to increase in the negative direction as more current is forced into the unit. This can happen when the load is a power source such as a battery, and its output voltage is higher than the voltage limit setting of the power supply. Once the current exceeds the built-in negative over-current limit, the output will shut down, the output relays will open, and the OCF status bits will be set. In such a case, it is important to set the voltage limit properly in order prevent this protection shutdown.

**NOTE**

For additional information on priority mode operation during output turn-on/turn-off, refer to **Turn-On Turn-Off Behavior**.

---



# 5

# SCPI Programming Reference

**[Related Software](#)**

**[SCPI Introduction](#)**

**[Commands by Subsystem](#)**

**[Status Tutorial](#)**

**[Trigger Tutorial](#)**

**[Reset State](#)**

**[SCPI Error Messages](#)**

**[Compatibility Commands](#)**

## Related Software

### **BV9200B and BV9201B PathWave BenchVue Advanced Power Control and Analysis Software**

The BV9200 software provides fast and easy access to the advanced sourcing and measurement functionality of your RP7900 Series Regenerative Power System without any programming. The BV9200B will allow you to control up to four instruments at once, while the BV9201B will allow you to control a single instrument. These are flexible tools for any application, which let you control any of the RP7900 Series' 20 models. Note that this software does not support primary/secondary operation. Learn more and download a free trail at: [www.keysight.com/find/BV9200](http://www.keysight.com/find/BV9200).

### **DG9000 Advanced/Multi-Input PV Inverter Test Software**

The DG9000 software lets you control the output of up to twelve RPS instruments (or primary/secondary combinations), as well as easily create, visualize, and download solar/photovoltaic I-V curves to the instrument using the PV Model Workspace. Once a curve has been downloaded to the instrument, you can enable the output and watch as their PV inverter searches for the maximum power point, gaining insight into your MPPT algorithm.

### **IO Libraries and Instrument Drivers**

You can download the Keysight IO Libraries Suite software, along with IVI-COM and LabVIEW drivers from the Keysight Developer Network at [www.keysight.com/find/adn](http://www.keysight.com/find/adn).

### **Interface Documentation**

For detailed information about interface connections, refer to the documentation included with the Keysight IO Libraries Suite. Or you can download the guide from the Web at [www.keysight.com/find/connectivity](http://www.keysight.com/find/connectivity).

### **Web Interface**

The Keysight RPS provides a Web interface that is built into the instrument. You can use this interface over LAN for remote access and control of the instrument via a Web browser. See [Using the Web Interface](#) for details.

## SCPI Introduction

### Keywords

### Queries

### Command Separators and Terminators

### Syntax Conventions

### Parameter Types

### Device Clear

### Typical Command Processing Times

## Introduction

This instrument complies with the rules and conventions of the present SCPI version (see **SYSTem:VERSion?**).

SCPI (Standard Commands for Programmable Instruments) is an ASCII-based instrument command language designed for test and measurement instruments. SCPI has two types of commands, common and subsystem.

### IEEE-488.2 Common Commands

The IEEE-488.2 standard defines a set of common commands that perform functions such as reset, self-test, and status operations. Common commands always begin with an asterisk (\*), are three characters in length, and may include one or more parameters. The command keyword is separated from the first parameter by a blank space. Use a semicolon (;) to separate multiple commands as shown below:

### Subsystem Commands

Subsystem commands perform specific instrument functions. They are comprised of alphabetically arranged commands that extend one or more levels below the root in a hierarchical structure, also known as a *tree system*. In this structure, associated commands are grouped together under a common node or root, thus forming *subsystems*. A portion of the OUTPut subsystem is shown below to illustrate the tree system. Note that some [optional] commands have been included for clarity.

```
OUTPut
  [:STATe] OFF|0|ON|1
  :DELay
    :FALL <value>|MIN|MAX
    :RISE <value>|MIN|MAX
  :INHibit
    :MODE LATChing|LIVE|OFF
```

## Keywords

Keywords, also referred to as headers, are instructions recognized by the instrument. Common commands are also keywords.

OUTPut is the root keyword, DELay is a second-level keyword, FALL and RISE are third-level keywords. Colons ( : ) separate the keyword levels.

The command syntax shows most commands (and some parameters) as a mixture of upper- and lower-case letters. The upper-case letters indicate the abbreviated spelling for the command. For shorter program lines, you can send the abbreviated form. For better program readability, you can send the long form.

In the above examples, OUTP and OUTPUT are both acceptable forms. You can use upper- or lower-case letters. Therefore, OUTPUT, outp, and Outp are all acceptable. Other forms such as OUT, are not valid and will generate an error.

## Queries

Following a keyword with a question mark ( ? ) turns it into a query (Example: VOLTage?, VOLTage:TRIGgered?). If a query contains parameters, place the query indicator at the end of the last keyword, before the parameters. Insert a space between the query indicator and the first parameter.

You can query the programmed value of most parameters. For example, you can query the previously set OUTPut:DELay:FALL time by sending:

```
OUTPut:DELay:FALL?
```

You can also query the minimum or maximum allowable fall time as follows:

```
OUTPut:DELay:FALL? MIN
OUTPut:DELay:FALL? MAX
```

You must read back all the results of a query before sending another command to the instrument. Otherwise, a *Query Interrupted* error will occur and the unreturned data will be lost.

## Command Separators and Terminators

### Separators

Colons ( : ) separate keyword levels. Blank spaces must be used to separate command parameters from their corresponding keyword. If a command requires more than one parameter, use a comma to separate adjacent parameters. In the following example, the optional *startindex* and *points* parameters must be separated with a comma. Note the space between CURRent? and the first parameter.

```
FETCh:CURRent? [<start_index>, <points>]
```

Semicolons (;) separate commands within the same subsystem. This lets you send several subsystem commands within the same message string. For example, sending the following command string:

```
OUTPut:STATe ON;DELAy:RISE 1;FALL 2
```

is the same as sending the following commands:

```
OUTPut ON
OUTPut:DELAy:RISE 1
OUTPut:DELAy;FALL 2
```

Note that the semicolon follows the implied path of the hierarchical tree structure. In the above example, the optional :STATe keyword must follow the OUTput keyword to place the command parser at the second level in the hierarchy. This allows the use of the DELay keyword after the semicolon, since DELay is a second-level keyword. Next, the command parser is placed at the third level in the hierarchy by the :RISE keyword. This allows the use of the FALL keyword after the second semicolon, since FALL is a third-level keyword.

You can also combine commands of different subsystems within the same message string. In this case, you must use a colon to return the command parser to the root level in order to access another subsystem. For example, you could clear the output protection and check the status of the Operation Condition register in one message by using a root specifier as follows:

```
OUTPut:PROTEction:CLEar;:STATus:OPERation :CONDition?
```

Note the use of the colon *after* the semicolon in order to return the command parser to the root.

## Terminators

A command string sent to the instrument must terminate with a new line (<NL>) character. The IEEE-488 EOI (End-Or-Identify) message is interpreted as a <NL> character and can be used to terminate a command string in place of an <NL>. A carriage return followed by a new line (<CR><NL>) is also accepted. Command string termination will always reset the current SCPI command path to the root level.

## Syntax Conventions

- Triangle brackets (< >) indicate that you must specify a value for the enclosed parameter. For example, in the OUTPut:DELAy syntax statements shown above, the <value> parameter is enclosed in triangle brackets. The brackets are not sent with the command string. You must specify a value for the parameter (Example: "OUTP:DEL:FALL 0.1") unless you select another option shown in the syntax (Example: "OUTP:DEL:FALL MIN").
- A vertical bar (|) separates multiple parameter choices for a given command string. For example, LATChing|LIVE|OFF in the OUTPut:INHibit command indicates that you can specify "LATChing", "LIVE", or "OFF". The bar is not sent with the command string.

- Square brackets ( [ ] ) enclose some syntax elements – nodes and parameters for example. This indicates that the element is optional and can be omitted. The brackets are not sent with the command string. In the case of an optional parameter, if you do not specify a value for an optional parameter the instrument will ignore the parameter. In the FETCh:CURRent? example above, the optional <startindex> and <points> parameters let you return array data starting at startindex and containing the specified number of data points. If these parameters are not specified, the query returns all of the array data.
- Braces ( { } ) indicate parameters that may be repeated zero or more times. It is used especially for showing lists. The notation <value>{,<value>} shows that the first value must be entered, while additional values may be omitted or may be entered one or more times.

### Parameter Types

The SCPI language defines several data formats to be used in commands and queries.

#### Numeric Parameters

Commands that require numeric parameters will accept all commonly used decimal representations of numbers including optional signs, decimal points, and scientific notation. If a command accepts only certain specific values, the instrument will automatically round the input numeric parameters to the accepted values. The following command requires a numeric parameter for the voltage value:

```
[SOURce:]VOLTage 50V|MIN|MAX
```

Note that special values for numeric parameters such as MINimum, MAXimum, and INFinity are also accepted. Instead of selecting a specific value for the voltage parameter, you can substitute MIN to set the voltage to its minimum allowable value, MAX to set it to its maximum allowable value.

You can also send engineering unit suffixes with numeric parameters (e.g., V for volts, A for amperes, W for Watts). All parameters values are in base units.

#### Discrete Parameters

Discrete parameters are used to program settings that have a limited number of values (like IMMEDIATE, EXTERNAL, or BUS). They may have a short form and a long form just like command keywords. You can use upper- or lower-case letters. Query responses will always return the short form in all upper-case letters. The following command requires a discrete parameter for the display settings:

```
DISPlay:VIEW METER_VI|METER_VP|METER VIP
```

#### Boolean Parameters

Boolean parameters represent a single binary condition that is either true or false. For a false condition, the instrument will accept "OFF" or "0". For a true condition, the instrument will accept "ON" or "1". When you query a Boolean setting, the instrument will always return "0" or "1". The following command requires a Boolean parameter:

```
DISPlay OFF|0|ON|1
```



## ASCII String Parameters

String parameters can contain virtually any set of ASCII characters. A string must begin and end with matching quotes; either with a single quote or a double quote. You can include the quote delimiter as part of the string by typing it twice without any characters in between. The following command uses a string parameter:

```
CALibrate:DATE "12/12/12"
```

## Arbitrary Block Program or Response Data

Definite-length block data <Block> allows any type of device-dependent data to be programmed or returned as a series of 8-bit binary data bytes. This is particularly useful for transferring large quantities of data or 8-bit extended ASCII codes.

## Device Clear

Device Clear is an IEEE-488 low-level bus message that you can use to return the instrument to a responsive state. Different programming languages and IEEE-488 interface cards provide access to this capability through their own unique commands. The status registers, the error queue, and all configuration states are left unchanged when a Device Clear message is received.

Device Clear performs the following actions:

- If a measurement is in progress, it is aborted.
- The instrument returns to the trigger idle state.
- The instrument's input and output buffers are cleared.
- The instrument is prepared to accept a new command string.

### NOTE

The ABORt command is the recommended method to terminate an instrument operation.

---

## Typical Command Processing Times

The following table documents some typical, average command processing times for several types of setting commands and response queries. This can help you determine the impact of some commonly used SCPI commands on total test time. All times are in milliseconds.

Setting commands like VOLT <n> only account for the IO latency + command processing, not the time for the action to complete (like the output voltage to finish changing or output state completing turn on).

Query command times apply from when the command was sent to the instrument until the response is received.

## 5 SCPI Programming Reference

Commands	GPIB	VXI-11
Set the output voltage: VOLT <n>	0.24 ms	0.65 ms
Return the output setting: OUTP?	0.30 ms	1.35 ms
Set the unit to the reset state: *RST	5.01 ms	5.26 ms
10 point measurement		
Return 10 point measurement: MEAS:VOLT?	3.00 ms	3.30 ms
Return 10 point fetch: FETC:VOLT?	0.49	1.49 ms
1 NPLC measurement		
Return 1 NPLC measurement: MEAS:VOLT?	21.03 ms	20.96 ms
Return 1 NPLC fetch: FETC:VOLT?	0.63 ms	1.41 ms
25 k point measurement		
Return 25 k point measurement: MEAS:VOLT?	521.0 ms	521.1 ms
Return 25 k point fetch: FETC:VOLT?	5.07 ms	7.01 ms
Return 25 k point ASCII array fetch: FETC:ARR:VOLT?	4009.5 ms	1010.8 ms
Return 25 k point binary array fetch: FETC:ARR:VOLT?	694.25 ms	30.39 ms

## Commands by Subsystem

**ABORt**

**CALibrate**

**DISPlay**

**FETCh**

**FORMat**

**HCOPy**

**IEEE-488 Common**

**INITiate**

**INSTrument**

**LXI**

**MEASure**

**OUTPut**

**SENSe**

**[SOURce:]**

**ARB**

**CURRent**

**DIGital**

**FUNction**

**LIST**

**POWer**

**SASimulator (photovoltaic)**

**STEP**

**VOLTage**

**STATus**

**SYSTem**

**TRIGger**

## ABORt Subsystem

Abort commands cancel any active transients and return the trigger system back to the Idle state. Abort commands are also executed with the \*RST command.

### ABORt:ACQuire

### ABORt:ELOG

### ABORt:TRANsient

ABORt:ACQuire - Cancels any triggered measurements. It also resets the WTG-meas and MEAS-active bits in the Operation Status registers.

ABORt:ELOG - Stops external data logging. It also resets the WTG-meas and MEAS-active bits in the Operation Status registers.

ABORt:TRAN - Cancels any transients or Arbs. It also resets the WTG-tran and TRAN-active bits in the Operation Status registers. Note that this command does not turn off continuous triggers if INITiate:CONTInuous:TRANsient ON has been programmed. In this case, first turn off continuous triggers before sending the ABORt command.

Parameter	Typical Return
(none)	(none)
Aborts the triggered measurement: ABOR:ACQ	

## ARB Subsystem

ARB commands program the constant-dwell arbitrary waveforms. Constant-dwell waveforms can have up to 65,535 points assigned to them, with the same dwell time for each point.

**[SOURce:]ARB:COUNt <value>|MIN|MAX|INFinity**  
**[SOURce:]ARB:COUNt? [MIN|MAX]**

Specifies the number of times the Arb repeats. Use the INFinity parameter to repeat the Arb continuously.

Parameter	Typical Return
1 – 256, *RST 1	<count>
Programs a repeat count of 10: ARB:COUN 10	

**[SOURce:]ARB:CURRent:CDWell[:LEVel] <value>{,<value>}|<Block>**  
**[SOURce:]ARB:CURRent:CDWell[:LEVel]?**  
**[SOURce:]ARB:VOLTage:CDWell[:LEVel] <value>{,<value>}|<Block>**  
**[SOURce:]ARB:VOLTage:CDWell[:LEVel]?**

Specifies the level of each point in the Arb. Values are specified in either amperes or volts. The minimum and maximum values depend on the ratings of the unit.

Current and voltage Arbs share settings, so setting the current Arb resets the voltage Arb level to its default value and vice versa. For better performance, the list can be sent as single precision floating point values in definite length arbitrary block format instead of an ASCII list. The response format is dependent on the return format ASCII or REAL.

Parameter	Typical Return
-102% to 102% of current rating or 0 to 102% of voltage rating	<value> [,<value>] or <Block>
Programs a constant dwell Arb of 5 voltage points: ARB:VOLT:CDW 5,4,3,2,1	

**[SOURce:]ARB:CURRent:CDWell:DWELL <value>**  
**[SOURce:]ARB:CURRent:CDWell:DWELL?**  
**[SOURce:]ARB:VOLTage:CDWell:DWELL <value>**  
**[SOURce:]ARB:VOLTage:CDWell:DWELL?**

Specifies the dwell time of each point in the Arb. Values are in seconds and are rounded to the nearest 10.24-microsecond increment.

Current and voltage Arbs share settings, so setting this parameter for a current Arb changes the voltage dwell value and vice versa.

Parameter	Typical Return
0.00001024 – 0.30, *RST 0.001	<dwel value>
Programs a constant dwell time of 0.2 seconds: ARB:CURR:CDW:DWEL 0.2	

- You can program dwell times that are much faster than the response time of the instrument. The "extra" points and dwell times can serve the purpose of smoothing the resultant waveshape.

### [SOURce:]ARB:CURRent:CDWell:POINts?

### [SOURce:]ARB:VOLTage:CDWell:POINts?

Returns the number of points in the Arb.

Parameter	Typical Return
(none)	<points>
Returns the number of current points in the Arb: ARB:CURR:CDW:POIN?	

### [SOURce:]ARB:FUNcTion:TYPE CURRent|VOLTage

### [SOURce:]ARB:FUNcTion:TYPE?

Specifies either a voltage or current Arb. Only one type of Arb may be output at a time. The selection must match the priority mode.

Parameter	Typical Return
CURRent VOLTage, *RST VOLTage	VOLT or CURR
Specifies a voltage Arb: ARB:FUNC:TYPE VOLT	

### [SOURce:]ARB:TERMinate:LAST 0|OFF|1|ON

### [SOURce:]ARB:TERMinate:LAST?

Selects the output setting after the Arb ends. When ON (1), the output voltage or current remains at the last Arb value. The last Arb voltage or current value becomes the IMMEDIATE value when the ARB completes. When OFF (0), and also when the Arb is aborted, the output returns to the settings that were in effect before the Arb started.

Parameter	Typical Return
0 OFF 1 ON, *RST OFF	0 or 1
Terminate with the output at the last Arb value: ARB:TERM:LAST ON	

## CALibrate Subsystem

Calibrate commands calibrate the instrument.

**NOTE**

Read the **calibration section** before calibrating. Improper calibration reduces accuracy and reliability.

---

### CALibrate:COUNT?

Returns the number of times the unit has been calibrated. The count is incremented whenever the calibration (and date) is saved, the administration password is changed or reset, or the firmware is updated.

Parameter	Typical Return
(none)	<count>
Return the calibration count: CAL:COUNT?	

### CALibrate:CURRENT[:LEVEL] <value>

Calibrates the current programming and measurement. The value selects the range to calibrate.

Parameter	Typical Return
The maximum current of the output range.	(none)
Calibrates the current of the 10 A range: CAL:CURR 10	

### CALibrate:CURRENT:TC

Calibrates the temperature coefficient.

Parameter	Typical Return
(none)	(none)
Calibrates the temperature coefficient: CAL:CURR:TC	

### CALibrate:DATA <value>

Enters the calibration value read by the external meter. You must first select a calibration level for the value being entered. Data values are expressed in base units - either volts or amperes, depending on which function is being calibrated.

Parameter	Typical Return
Numeric value	(none)
Specify calibration value 0.0237: CAL:DATA 2.37E-2	

### **CALibrate:DATE <"date">** **CALibrate:DATE?**

Enters the calibration date in nonvolatile memory. Enter any ASCII string up to 15 characters. The query returns the date.

Parameter	Typical Return
<"date"> String program data. Enclose string parameters in single or double quotes.	<last cal date>
Enters the calibration date: CAL:DATE "12/12/12"	

### **CALibrate:LEVel P1|P2|P3** **CALibrate:LEVel?**

Advances to the next level in the calibration. P1 is the first level; P2 is the second; P3 is the third.

Parameter	Typical Return
P1 P2 P3	(none)
Selects the first calibration point: CAL:LEV P1	

- Some calibration sequences may require some settling time after sending CAL:LEV but before reading the data from the DVM and sending CAL:DATA.

### **CALibrate:PASSword <password>**

Sets a numeric password to prevent unauthorized calibration. This is the same as the **Admin** password.

Parameter	Typical Return
<password> A numeric value of up to 15 digits	(none)
Set a new password to a value of 1234: CAL:PASS 1234	

- If the password is set to 0, password protection is removed and the ability to enter calibration mode is unrestricted. The as-shipped setting is 0 (zero).
- To change the password: unsecure calibration memory with old code, then set the new code.
- If you forget your password, refer to **Calibration Switches**.
- This setting is non-volatile; it will not be changed by power cycling or \*RST.

### **CALibrate:SAVE**

Saves the calibration constants in non-volatile memory. Do this at the end of the calibration to avoid losing changes.



Parameter	Typical Return
(none)	(none)
Store calibration constants into non-volatile memory: CAL:SAVE	

### **CALibrate:STATE 0|OFF|1|ON [,<password>]** **CALibrate:STATE?**

Enables or disables calibration mode. Calibration mode must be enabled for the instrument to accept any calibration commands. The first parameter specifies the state. The second optional parameter is the password.

Parameter	Typical Return
0 OFF 1 ON, *RST OFF	0 or 1
<password> a numeric value up to 15 digits	(none)
Disable calibration: CAL:STAT OFF	
Enable calibration: CAL:STAT ON [,value]	

A password is required if <password> has been set to a non-zero value.

### **CALibrate:VOLTage[:LEVel] <value>**

Calibrates the local voltage programming and measurement. The value selects the range to calibrate.

Parameter	Typical Return
The maximum voltage of the output range.	(none)
Calibrates the voltage of the 20 V range: CAL:VOLT 20	

## CURRent Subsystem

Current commands program the output current of the instrument.

**[SOURce:]CURRent[:LEVel][:IMMediate][:AMPLitude] <value>|MIN|MAX**  
**[SOURce:]CURRent[:LEVel][:IMMediate][:AMPLitude]? [MIN|MAX]**  
**[SOURce:]CURRent[:LEVel]:TRIGgered[:AMPLitude] <value>|MIN|MAX**  
**[SOURce:]CURRent[:LEVel]:TRIGgered[:AMPLitude]? [MIN|MAX]**

Sets the immediate or triggered current level when the output is operating in current priority mode. The triggered level is a stored value that is transferred to the output when an output Step is triggered. Units are in amperes. The maximum value depends on the current rating of the unit. The minimum value is the most negative value.

Parameter	Typical Return
-102% to 102% of rating, *RST 0	<current level>
Sets the positive current to 2 A: CURR 2	

**[SOURce:]CURRent:BWIDth:LEVel 0, <value>|MIN|MAX**  
**[SOURce:]CURRent:BWIDth:LEVel? [MIN|MAX]**

Specifies the low-pass filter corner frequency applied to the programming setpoint signal with the current bandwidth. The value is in Hertz. The default frequency is optimized for maximum up-programming speed as well as the fastest transient response time. It can be reduced to compensate for output overshoots.

Parameter	Typical Return
0, (bandwidth range - required)	0
10 to 100,000, *RST 5,000	<corner frequency>
With the current bandwidth at 0, sets the frequency 60 Hz: CURR:BWID:LEV 0, 60	

**[SOURce:]CURRent:LIMit[:POSitive][:IMMediate][:AMPLitude] <value>|MIN|MAX**  
**[SOURce:]CURRent:LIMit[:POSitive][:IMMediate][:AMPLitude]? [MIN|MAX]**  
**[SOURce:]CURRent:LIMit:NEGative[:IMMediate][:AMPLitude] <value>|MIN|MAX**  
**[SOURce:]CURRent:LIMit:NEGative[:IMMediate][:AMPLitude]? [MIN|MAX]**

Sets the current limit when in voltage priority mode. Units are in amperes. The maximum value depends on the current rating of the unit. The minimum value is the most negative value.

Parameter	Typical Return
Positive: 0 to 102% of rating, *RST 1.02% of rating	<+current limit>
Negative: -102% of rating to 0, *RST -1.02% of rating	<-current limit>
Sets the positive current limit to 2 A: CURR:LIM 2	
Sets the negative current limit to -2 A: CURR:LIM:NEG -2	

**[SOURce:]CURRent:MODE FIXed|STEP|LIST|ARB**  
**[SOURce:]CURRent:MODE?**

Sets the transient mode. This determines what happens to the output current when the transient system is initiated and triggered.

**FIXed** keeps the output current at its immediate value.

**STEP** steps the output to the triggered level when a trigger occurs.

**LIST** causes the output to follow the list values when a trigger occurs.

**ARB** causes the output to follow the arbitrary waveform values when a trigger occurs.

Parameter	Typical Return
FIXed STEP LIST ARB, *RST FIXed	FIX, STEP, LIST, or ARB
Sets the current mode to Step: <code>CURR:MODE STEP</code>	

**[SOURce:]CURRent:PROTection:DELAy[:TIME] <value>|MIN|MAX**  
**[SOURce:]CURRent:PROTection:DELAy[:TIME]? [MIN|MAX]**

Sets the over-current protection delay. The over-current protection function will not be triggered during the delay time. After the delay time has expired, the over-current protection function will be active. This prevents momentary changes in output status from triggering the over-current protection function. Values up to 255 milliseconds can be programmed, with a resolution of 1 millisecond.

Parameter	Typical Return
0 – 0.255, *RST 0.020 s	<delay value>
Sets the protection delay to 0.2 seconds: <code>CURR:PROT:DEL 0.2</code>	

- The operation of over-current protection is affected by the setting of the current protection delay start event, which is specified by `CURRent:PROTection:DELAy:STARt`.

**[SOURce:]CURRent:PROTection:DELAy:STARt SCHange|CCTRans**  
**[SOURce:]CURRent:PROTection:DELAy:STARt?**

Specifies what starts the over-current protection delay timer.

**SCHange** starts the over-current delay whenever a command changes the output voltage, current, or output state.

**CCTRans** starts the over-current delay timer by any transition of the output into current limit mode.

Parameter	Typical Return
SCHange CCTRans, *RST SCHange	SCH or CCTR
Selects the CCTRans delay mode: <code>CURR:PROT:DEL:STAR CCTR</code>	

**[SOURce:]CURRent:PROTection:STATe 0|OFF|1|ON**  
**[SOURce:]CURRent:PROTection:STATe?**

Enables or disables the over-current protection. If the over-current protection function is enabled and the output goes into current limit, the output is disabled and the Questionable Condition status register OCP bit is set.

Parameter	Typical Return
0 OFF 1 ON, *RST OFF	0 or 1
Enable the current protection state: <code>CURR:PROT:STAT ON</code>	

- An over-current condition can be cleared with `OUTPut:PROTection:CLEar` after the cause of the condition is removed.

**[SOURce:]CURRent:SLEW[:IMMEdiate] <value>|MIN|MAX|INFIInity**  
**[SOURce:]CURRent:SLEW[:IMMEdiate]? [MIN|MAX]**

Sets the current slew rate. The slew rate is set in amps per second and affects all programmed current changes, including those due to the output state turning on or off. The slew rate can be set to any value between 0 and 9.9E+37. For very large values, the slew rate will be limited by the unit's listed programming speed and bandwidth. Keywords MAX or INFIInity set the slew rate to maximum.

Parameter	Typical Return
0 – 9.9E+37, *RST MAX	<max value>
Sets the output slew rate to 1 A per second: <code>CURR:SLEW 1</code>	

- The query returns the value that was sent. If the value is less than the minimum slew rate, the minimum value is returned. The resolution of the slew setting is the same as the minimum value. This can be queried using `CURRent:SLEW? MIN`. The exact value varies slightly based on calibration.

**[SOURce:]CURRent:SLEW:MAXimum 0|OFF|1|ON**  
**[SOURce:]CURRent:SLEW:MAXimum?**

Enables or disables the maximum slew rate override. When enabled, the slew rate is set to its maximum value. When disabled, the slew rate is set to the immediate value set by the `CURRent:SLEW` command. Use `CURRent:SLEW? MAX` to query the maximum slew rate that was set.

Parameter	Typical Return
0 OFF 1 ON, *RST ON	0 or 1
Enable the maximum slew rate: <code>CURR:SLEW:MAX ON</code>	

- The `CURRent:SLEW:MAX` command is coupled to the `CURRent:SLEW` command. If `CURRent:SLEW` sets the rate to MAX or INFIInity, `CURRent:SLEW:MAX` is enabled. If the slew rate is set to any other value, `CURRent:SLEW:MAX` is disabled.

## DIGital Subsystem

Digital commands program the digital control port on the rear panel of the instrument.

### [SOURce:]DIGital:INPut:DATA?

Reads the state of the digital control port. Returns the binary-weighted value of the state of pins 1 through 7 in bits 0 through 6 respectively.

Parameter	Typical Return
(none)	<bit value>
Reads the state of the digital control port: <code>DIG:INP:DATA?</code>	

### [SOURce:]DIGital:OUTPut:DATA <value>

### [SOURce:]DIGital:OUTPut:DATA?

Sets the state of the digital control port. This only affects the pins whose function has been set to Digital IO operation. The port has seven signal pins and a digital ground pin. In the binary-weighted value that is written to the port, the pins are controlled according to the following bit assignments:

Pin	1	2	3	4	5	6	7
Bit number	0	1	2	3	4	5	6
Decimal value	1	2	4	8	16	32	64

Bit values corresponding to digital port pins that are not configured as DIO are ignored.

Parameter	Typical Return
0 – 127, *RST 0	<bit value>
Programs pins 1, 3, and 5 on: <code>DIG:OUTP:DATA?</code>	

### [SOURce:]DIGital:PIN<1-7>:FUNctIon <function>

### [SOURce:]DIGital:PIN<1-7>:FUNctIon?

Sets the pin function. The functions are saved in non-volatile memory.

DIO	General-purpose ground-referenced digital input/output function.
DINPut	Digital input-only mode.
FAULt	Pin 1 functions as an isolated fault output. Pin 2 is common for pin 1
INHibit	Pin 3 functions as an inhibit input.
ONCouple	Pins 4 -7 synchronize the output On state.
OFFCouple	Pins 4 -7 synchronize the output Off state.
TINPut	A trigger input function.
TOUtput	A trigger output function

Parameter	Typical Return
DIO   DINPut   FAULt   INHibit   ONCouple   OFFCouple TINPut   TOUTput	DIO, DINP, FAUL, INH, ONC, OFFC, TINP, or TOUT
Sets pin 1 to FAULt mode: <code>DIG:PIN1:FUNC FAUL</code>	

**[SOURce:]DIGital:PIN<1-7>:POLarity POSitive|NEGative**  
**[SOURce:]DIGital:PIN<1-7>:POLarity?**

Sets the pin polarity.

**POSitive** means a logical true signal is a voltage high at the pin. For trigger inputs and outputs, POSitive means a rising edge.

**NEGative** means a logical true signal is a voltage low at the pin. For trigger inputs and outputs, NEGative means a falling edge. The pin polarities are saved in non-volatile memory.

Parameter	Typical Return
POSitive NEGative	POS or NEG
Sets pin 1 to POSitive polarity: <code>DIG:PIN1:POL POS</code>	

**[SOURce:]DIGital:TOUTput:BUS[:ENABLE] 0|OFF|1|ON**  
**[SOURce:]DIGital:TOUTput:BUS[:ENABLE]?**

Enables or disables BUS triggers on digital port pins. This allows a BUS trigger to be sent to any digital port pin that has been configured as a trigger output. A trigger out pulse is generated when the state is on and a bus trigger is received. A BUS trigger is generated using the \*TRG command.

Parameter	Typical Return
0 OFF 1 ON, *RST OFF	0 or 1
Enable BUS triggered signals on the digital pins: <code>DIG:TOUT:BUS ON</code>	

- The query returns 0 (OFF) if the trigger signal will NOT be generated with a BUS trigger command, and 1 (ON) if a trigger signal will be generated with a BUS trigger command.

## DISPlay Subsystem

Display commands control the front panel display.

**DISPlay[:WINDow][:STATe] 0|OFF|1|ON**  
**DISPlay[:WINDow][:STATe]?**

Turns the front panel display on or off.

Parameter	Typical Return
0 OFF 1 ON, *RST ON	0 or 1
Turns the front panel display off: <code>DISP OFF</code>	

**DISPlay[:WINDow]:VIEW METER\_VI|METER\_VP|METER\_VIP**  
**DISPlay[:WINDow]:VIEW?**

Selects the parameters to display on the front panel.

METER\_VI displays output voltage and current.

METER\_VP displays output voltage and power.

METER\_VIP displays output voltage, current, and power.

Parameter	Typical Return
METER_VI METER_VP METER_VIP, *RST METER_VI	METER_VI, METER_VP, or METER_VIP
To display voltage and power: <code>DISP:VIEW METER_VP</code>	

**DISPlay:SAVer[:STATe] 0|OFF|1|ON**  
**DISPlay:SAVer[:STATe]?**

Turns the front panel screen saver on or off.

Parameter	Typical Return
0 OFF 1 ON, *RST OFF	0 or 1
Turns the front panel screen saver on: <code>DISP:SAV ON</code>	

## FETCh Subsystem

Fetch commands return measurement data that has been previously acquired. FETCh queries do not generate new measurements, but allow additional measurement calculations from the same acquired data. The data is valid until the next MEASure or INITiate command occurs.

**FETCh[:SCALar]:CURRent[:DC]? [*<start\_index>*, *<points>*]**

**FETCh[:SCALar]:POWer[:DC]?**

**FETCh[:SCALar]:VOLTage[:DC]? [*<start\_index>*, *<points>*]**

Returns the averaged measurement. Values returned are either in amperes, volts, or watts.

Optional parameters specify a subset starting at *<startindex>* and of length *<points>*.

Parameter	Typical Return
[ <i>&lt;startindex&gt;</i> ] the start index [ <i>&lt;points&gt;</i> ] the number of points	<i>&lt;DC value&gt;</i>
Returns the measured dc current FETC:CURR?	

**FETCh[:SCALar]:CURRent:ACDC?**

**FETCh[:SCALar]:VOLTage:ACDC?**

Returns the rms measurement (ac + dc). Values returned are either in amperes, or volts.

Parameter	Typical Return
(none)	<i>&lt;ACDC value&gt;</i>
Returns the measured rms voltage FETC:VOLT:ACDC?	

**FETCh[:SCALar]:CURRent:HIGH?**

**FETCh[:SCALar]:VOLTage:HIGH?**

Returns the High level of a pulse waveform. Values returned are either in amperes, or volts. See [Measurement Types](#).

Parameter	Typical Return
(none)	<i>&lt;HIGH value&gt;</i>
Returns the measured high level current FETC:CURR:HIGH?	



**FETCh[:SCALar]:CURRent:LOW?**  
**FETCh[:SCALar]:VOLTage:LOW?**

Returns the Low level of a pulse waveform. Values returned are either in amperes, or volts. See [Measurement Types](#).

Parameter	Typical Return
(none)	<LOW value>
Returns the measured low level voltage <code>FETC:VOLT:LOW?</code>	

**FETCh[:SCALar]:CURRent:MAXimum?**  
**FETCh[:SCALar]:CURRent:MINimum?**  
**FETCh[:SCALar]:POWer:MAXimum]?**  
**FETCh[:SCALar]:POWer:MINimum]?**  
**FETCh[:SCALar]:VOLTage:MAXimum?**  
**FETCh[:SCALar]:VOLTage:MINimum?**

Returns the maximum or minimum value. Values returned are either in amperes, volts, or watts.

Parameter	Typical Return
(none)	<MIN value> <MAX value>
Returns the measured maximum current <code>FETC:CURR:MAX?</code>	
Returns the measured minimum voltage <code>FETC:VOLT:MIN?</code>	
Returns the measured maximum power <code>FETC:POW:MAX?</code>	

**FETCh:AHOur? [IGNORE\_OVLD]**  
**FETCh:WHour? [IGNORE\_OVLD]**

FETCh:AHOur? - Returns the accumulated amp-hours.

FETCh:WHour? - Returns the accumulated watt-hours.

See [Amp-Hour and Watt-Hour Measurements](#) for details.

If any measurement sample was overrange, the query returns SCPI Not a Number (9.91E37). If the optional IGNORE\_OVLD parameter is sent, the accumulated measurement will be returned even if some samples were outside of the measurement range.

Parameter	Typical Return
IGNORE_OVLD ignore overload measurements	<amp-hours> <watt-hours>
Returns the amp-hour measurement <code>FETC:AHO?</code>	
Returns the watt-hour measurement <code>FETC:WHO?</code>	

**FETCh:ARRay:CURRent[:DC]? [<start\_index>, <points>]**

**FETCh:ARRay:POWer[:DC]? [<start\_index>, <points>]**

**FETCh:ARRay:VOLTage[:DC]? [<start\_index>, <points>]**

Returns the instantaneous measurement. Values returned are either in amperes, volts, or watts.

Optional parameters specify a subset starting at <startindex> and of length <points>.

The return format depends on the settings of the FORMat:BORDER and FORMat[:DATA] commands. When the data format is set to ASCII, returned values are comma separated. When the data format is set to REAL, data is returned as single precision floating point values in definite length arbitrary block response format.

Parameter	Typical Return
[<startindex>] the start index	<value> [,<value>]
[<points>] the number of points	or <Block>

---

Returns the measured current array **FETC:ARR:CURR?**

### **FETCh:ELOG? <maxrecords>**

Returns the most recent external datalog records. Data must be read from the buffer periodically to avoid the buffer overflowing. Whenever data is read using FETCh:ELOG? then that buffer space is made available in the instrument for storing more acquired data.

Maxrecords is the maximum number of records of datalog data that the controller will return.

The return format depends on the settings of the FORMat:BORDER and FORMat[:DATA] commands. When the data format is set to ASCII, returned values are comma separated. When the data format is set to REAL, data is returned as single precision floating point values in definite length arbitrary block response format.

Parameter	Typical Return
[<maxrecords>] the number of records returned (1 to 16,384)	<value> [,<value>] or <Block>

---

Returns up to 100 data records **FETC:ELOG? 100**

## FORMat Subsystem

FORMat commands specify the format for transferring measurement data.

### FORMat[:DATA] ASCII|REAL FORMat[:DATA]?

Specifies the format of the returned data. This is used by queries that can return a block of data. **ASCII** returns data as ASCII bytes in numeric format as appropriate. The numbers are separated by commas. **REAL** returns data in a definite length block as IEEE single precision floating point values. In this case the 4 bytes of each value can be returned in either big-endian or little-endian byte order, determined by the FORMat:BORDER setting.

Parameter	Typical Return
ASCII REAL, *RST ASCII	ASCII or REAL
Sets the data format to ASCII: FORMat ASCII	

- The data format is used by a small sub set of queries that can return large quantities of data.

### FORMat:BORDER NORMAl|SWAPped FORMat:BORDER?

Specifies how binary data is transferred. This only applies when the FORMat:DATA is set to REAL. **NORMAl** transfers data in normal order. The most significant byte is returned first, and the least significant byte is returned last (big-endian). **SWAPped** transfers data in swapped-byte order. The least significant byte is returned first, and the most significant byte is returned last (little-endian).

Parameter	Typical Return
NORMAl SWAPped, *RST NORMAl	NORM or SWAP
Sets the data transfer to Swapped: FORM:BORD SWAP	

- The byte order is used when fetching real data from SCPI measurements.

**FUNCTION Command**

**[SOURce:]FUNCTION CURRent|VOLTage**  
**[SOURce:]FUNCTION?**

Sets the output regulation - voltage priority or current priority. In voltage priority mode, the output is controlled by a constant voltage feedback loop, which maintains the output voltage at its programmed setting. In current priority mode, the output is controlled by a constant current feedback loop, which maintains the output current at its positive or negative programmed setting.

Refer to [Priority Mode Tutorial](#) for more information.

Parameter	Typical Return
CURRent VOLTage, *RST VOLTage	CURR or VOLT
Sets the output regulation to current priority: FUNC CURR	

## HCOPy Subsystem

HCOPy commands return the display image.

### HCOPy:SDUMp:DATA? [BMP|GIF|PNG]

Returns an image of the front panel display. The format may be specified by the optional parameter. If no format is specified, the format is determined by HCOPy:SDUMp:DATA:FORMat.

The response is a SCPI 488.2 definite length binary block of the form: #<nonzero digit><digits><8 bit data-bytes> where:

<nonzero digit> specifies the number of digits to follow,  
<digits> specify the number of 8 bit data bytes to follow, and  
<8 bit data bytes> contain the data to be transferred.

Parameter	Typical Return
[BMP GIF PNG]	<Block>
Returns the image in GIF format: HCOP:SDUM:DATA? GIF	

### HCOPy:SDUMp:DATA:FORMat BMP|GIF|PNG HCOPy:SDUMp:DATA:FORMat?

Specifies the format for front panel images returned.

Parameter	Typical Return
BMP GIF PNG, *RST PNG	BMP, GIF, or PNG
Specify GIF as the image format: HCOP:SDUM:DATA:FORM GIF	

## IEEE-488 Common Commands

IEEE-488 Common commands generally control overall instrument functions, such as reset, status, and synchronization. All common commands consist of a three-letter mnemonic preceded by an asterisk: \*RST \*IDN? \*SRE 8.

### \*CLS

Clear status command. Clear Status Command. Clears the **event registers** in all register groups. Also clears the status byte and error queue. If \*CLS immediately follows a program message terminator (<NL>), then the output queue and the MAV bit are also cleared. Refer to **Status Tutorial** for more information.

Parameter	Typical Return
(none)	(none)
Clear event registers, status byte, and error queue: *CLS	

### \*ESE <value>

### \*ESE?

Event status enable command and query. Sets the value in the **enable register** for the **Standard Event Status** group. Each set bit of the register enables a corresponding event. All enabled events are logically ORed into the ESB bit of the status byte. The query reads the enable register. Refer to **Status Tutorial** for more information.

Parameter	Typical Return
A decimal value corresponding to the binary-weighted sum of the register's bits.	<bit value>
Enable bits 3 and 4 in the enable register: *ESE 24	

- The value returned is the binary-weighted sum of all enabled bits in the register. For example, with bit 2 (value 4) and bit 4 (value 16) set, the query returns +20.
- Any or all conditions can be reported to the ESB bit through the enable register. To set the enable register mask, write a decimal value to the register using \*ESE.
- \*CLS does not clear the enable register, but does clear the **event register**.

### \*ESR?

Event status event query. Reads and clears the **event register** for the **Standard Event Status** group. The event register is a read-only register, which latches all standard events. Refer to **Status Tutorial** for more information.

Parameter	Typical Return
(none)	<bit value>

---

Read event status enable register: **\*ESR?**

- The value returned is the binary-weighted sum of all enabled bits in the register.
- Any or all conditions can be reported to the ESB bit through the enable register. To set the enable register mask, write a decimal value to the register using \*ESE.
- Once a bit is set, it remains set until cleared by this query or \*CLS.

### \*IDN?

Identification Query. Returns instrument's identification string, which contains four comma-separated fields. The first field is the manufacturer's name, the second field is the instrument model number, the third field is the serial number, and the fourth field is the firmware revision.

Parameter	Typical Return
(none)	Keysight Technologies,RP7972A,MY12345678,A.01.01

---

Return the instrument's identification string: **\*IDN?**

### \*OPC

Sets the OPC (operation complete) bit in the standard event register. This occurs at the completion of the pending operation. Refer to [Status Tutorial](#) for more information.

Parameter	Typical Return
(none)	(none)

---

Set the Operation Complete bit: **\*OPC**

- The purpose of this command is to synchronize your application with the instrument.
- Used in conjunction with initiated acquisitions, transients, output state changes, and output settling time to provide a way to poll or interrupt the computer when these pending operations complete.
- Other commands may be executed before the operation complete bit is set.
- The difference between \*OPC and \*OPC? is that \*OPC? returns "1" to the output buffer when the current operation completes.

### \*OPC?

Returns a 1 to the output buffer when all pending operations complete. The response is delayed until all pending operations complete.

Parameter	Typical Return
(none)	1
Return a 1 when commands complete: *OPC?	

- The purpose of this command is to synchronize your application with the instrument.
- Other commands cannot be executed until this command completes.

**\*OPT?**

Returns a string identifying any installed options. A 0 (zero) indicates no options are installed.

Parameter	Typical Return
(none)	OPT 760
Returns installed options *OPT?	

**\*RCL <0-9>**

Recalls a saved instrument state. This restores the instrument to a state that was previously stored in locations 0 through 9 with the \*SAV command. All instrument states are recalled except: (1) the output state is set to OFF, (2) the trigger systems are set to the Idle state, (3) calibration is disabled, (4) all lists are set to their \*RST values, and (5) the non-volatile settings are not affected.

Parameter	Typical Return
0 - 9	(none)
Recall state from location 1: *RCL 1	

- Location 0 is automatically recalled at power turn-on when the Power-On state is set to RCL 0.
- Stored instrument states are not affected by \*RST.
- For 30 kW units only, when an operating state is saved when the unit is operating on a specific ac line voltage, and the ac line voltage is subsequently changed, an error (341) will occur.

**\*RST**

Resets the instrument to pre-defined values that are either typical or safe. These settings are described in [Reset State](#).

Parameter	Typical Return
(none)	(none)
Reset the instrument: *RST	

- \*RST forces the ABORt commands. This cancels any measurement or transient actions presently in process. It resets the WTG-meas, MEAS-active, WTG-tran, and TRAN-active status bits.



**\*SAV <0-9>**

Saves the instrument state to one of ten non-volatile memory locations. For safety reasons, when a saved state is recalled, the output state will be set to OFF.

Parameter	Typical Return
0 - 9	(none)
Save state to location 1: *SAV 1	

- If a particular state is desired at power-on, it should be stored in location 0. Location 0 is automatically recalled at power turn-on when the Power-On state is set to RCL 0.
- Output state, List data, and the calibration state is NOT saved as part of the \*SAV operation.
- Data saved in non-volatile memory, described under **Non-Volatile Settings**, is not affected by the \*SAV command.
- When shipped, locations 0 through 9 are empty.

**\*SRE <value>****\*SRE?**

Service request enable command and query. This sets the value of the Service Request Enable register. This determines which bits from the **Status Byte Register** are summed to set the Master Status Summary (MSS) bit and the Request for Service (RQS) summary bit. A 1 in any Service Request Enable register bit position enables the corresponding Status Byte register bit. All such enabled bits are then logically OR-ed to cause the MSS bit of the Status Byte register to be set. Refer to **Status Tutorial** for more information.

Parameter	Typical Return
A decimal value corresponding to the binary-weighted sum of the register's bits.	<bit value>
Enable bit 3 and bit 4 in the enable register: *SRE 24	

- When a serial poll is conducted in response to SRQ, the RQS bit is cleared, but the MSS bit is not. When \*SRE is cleared (by programming it with 0), the power supply cannot generate an SRQ.

**\*STB?**

Status byte query. Reads the **Status Byte Register**, which contains the status summary bits and the Output Queue MAV bit. The Status Byte is a read-only register and the bits are not cleared when it is read. Refer to **Status Tutorial** for more information.

Parameter	Typical Return
(none)	<bit value>
Read status byte: *STB?	

**\*TRG**

Trigger command. Generates a trigger when the trigger subsystem has BUS selected as its source. The command has the same effect as the Group Execute Trigger (<GET>) command.

Parameter	Typical Return
(none)	(none)
Generates an immediate trigger: <b>*TRG</b>	

**\*TST?**

Self-test query. Performs a instrument self-test. If self-test fails, one or more error messages will provide additional information. Use SYSTem:ERRor? to read error queue. See [SCPI Error Messages](#) for more information.

Parameter	Typical Return
(none)	0 (pass) or +1 (failed)
Perform self-test: <b>*TST?</b>	

- The power-on self-test is the same self-test performed by \*TST.
- \*TST? also forces an \*RST command.

**\*WAI**

Pauses additional command processing until all pending operations are complete. See [OPC](#) for more information.

Parameter	Typical Return
(none)	(none)
Wait until all pending operations complete. <b>*WAI</b>	

- \*WAI can only be aborted by sending the instrument a Device Clear command.

## INITiate Subsystem

Initiate commands arm the trigger system. This moves the trigger system from the "idle" state to the "wait-for-trigger" state; which enables the instrument to receive triggers. An event on the selected trigger source causes the trigger to occur.

### INITiate[:IMMediate]:ACQuire

### INITiate[:IMMediate]:ELOG

### INITiate[:IMMediate]:TRANSient

INITiate:ACQuire - Initiates the measurement trigger system.

INITiate:ELOG - Initiates external data logging.

INITiate:TRANSient - Initiates the transient trigger system.

Parameter	Typical Return
(none)	(none)
Initiate the measurement-trigger system: <code>INIT:ACQ</code>	

- It takes a few milliseconds for the instrument to be ready to receive a trigger signal after receiving the INITiate command.
- If a trigger occurs before the trigger system is ready for it, the trigger will be ignored. Check the WTG\_meas bit in the operation status register to know when the instrument is ready.
- Use ABORt commands to return the instrument to Idle.

### INITiate:CONTInuous:TRANSient 0|OFF|1|ON

### INITiate:CONTInuous:TRANSient?

Continuously initiates the transient trigger system. This allows multiple triggers to generate multiple output transients.

Parameter	Typical Return
0 OFF 1 ON, *RST ON	0 or 1
Continually initiates the output trigger system: <code>INIT:CONT:TRAN ON</code>	

- With initiate continuous disabled, the output trigger system must be initiated for each trigger using the INITiate:TRANSient command.
- ABORt:TRANSient does not turn off continuous triggers if INITiate:CONTInuous:TRANSient ON has been programmed. In this case, first turn off continuous triggers before sending the ABORt command.

## INSTrument Subsystem

Instrument commands program the primary/secondary function of the instrument. Primary/secondary operation is used when connecting a number of instruments in parallel to create a system with higher total current and, hence, higher power.

### NOTE

In this document the terms “master” and “slave” have been replaced with “primary” and “secondary.” The previous firmware version INSTrument Subsystem command syntax is still supported in this and later firmware versions.

### INSTrument:GROup:FUNcTION PRIMary|SECondary|NONE INSTrument:GROup:FUNcTION?

Set the function of an instrument in a primary/secondary configuration. This setting is saved in non-volatile memory.

**PRIMary** - Configures the instrument as the primary unit in a primary/secondary group.

**SECondary** - Configures the instrument as a secondary unit in a primary/secondary group.

**NONE** - disables the primary/secondary function. The unit operates independently.

Parameter	Typical Return
PRIMary SECondary NONE	PRIM, SEC, or NONE
Configures the instrument as the primary <code>INST:GRO:FUNc:PRIM</code>	

### INSTrument:GROup:PRIMary:CONNect[:STATe] [,0|OFF|1|ON]

Instructs the primary unit to connect to the previously discovered secondary units. If the secondary configuration on the bus matches the discovered one, the primary will start normal operation. Otherwise the command will fail with an error, and all units will operate independently.

Parameter	Typical Return
optional 0 OFF 1 ON	0 or 1
Connect the primary to the secondary units <code>INST:GRO:PRIM:CONN</code>	

### INSTrument:GROup:PRIMary:CONNect:DELay <value>|MIN|MAX INSTrument:GROup:PRIMary:CONNect:DELay? [MIN|MAX]

Set the delay after power-on before the primary unit attempts to connect to secondary units. This only applies if the connect mode is set to AUTO. This setting is saved in-volatile memory.

Parameter	Typical Return
0 to 120 seconds	0
Configures the connection delay for 10 seconds <code>INST:GRO:PRIM:CONN:DEL 10</code>	

## **INSTrument:GROup:PRIMary:CONNect:MODE AUTO|MANual** **INSTrument:GROup:PRIMary:CONNect:MODE?**

Specifies the connection mode of the primary unit. This setting is saved in non-volatile memory.

**AUTO** - the primary unit will try to connect to the previously discovered secondary units at power-on.

**MANual** - the primary will connect to the previously discovered secondary units when it receives a connection command from the front panel or from INST:GROUP:PRIM:CONN.

Parameter	Typical Return
AUTO   MANual	AUTO or MAN
Specifies automatic connection mode <code>INST:GRO:PRIM:CONN:MODE AUTO</code>	

## **INSTrument:GROup:PRIMary:DISCover**

Instructs the primary unit to discover all secondary units connected to the primary/secondary bus.

Parameter	Typical Return
(none)	(none)
Discover all secondary units <code>INST:GRO:PRIM:DISC</code>	

## **INSTrument:GROup:PRIMary:RESet**

Resets the primary-discovered secondary configuration. It disconnects any secondary-connected units and returns them to independent operation.

Parameter	Typical Return
(none)	(none)
Resets all secondary units <code>INST:GRO:PRIM:RES</code>	

## **INSTrument:GROup:SECondary:ADDRess <value>**

Sets the secondary unit's bus address. Each secondary unit in a primary/secondary group must have a unique bus address or bus communication will fail. This setting is saved in non-volatile memory.

Parameter	Typical Return
1 - 19	1
Set the secondary unit's address to 1 <code>INST:GRO:SEC:ADDR 1</code>	

## LIST Subsystem

List commands program an output sequence of multiple voltage or current settings. A comma-delimited list of up to 512 steps may be programmed. Note that these commands only apply in the presently active priority mode, either voltage priority or current priority.

**[SOURce:]LIST:COUNT <value>|MIN|MAX|INFINITY**  
**[SOURce:]LIST:COUNT? [MIN|MAX]**

Sets the list repeat count. This sets the number of times that a list is executed before it completes. The count range is 1 through 4096. Infinity runs the list continuously.

Parameter	Typical Return
1 – 4096, *RST 1	<count>
Sets the list count to 10: LIST:COUN 10	

**[SOURce:]LIST:CURREnt[:LEVel] <value>{,<value>}**  
**[SOURce:]LIST:CURREnt[:LEVel]?**  
**[SOURce:]LIST:VOLTage[:LEVel] <value>{,<value>}**  
**[SOURce:]LIST:VOLTage[:LEVel]?**

Specifies the setting for each list step. Values are specified in either amperes or volts.

Parameter	Typical Return
Voltage: 0 to 102% of rating Current: -102% to 102% of rating	<list value 1>,<list value 2>,<list value 3>
Programs a current list. The list contains 3 steps: LIST:CURRE 3,2,1	
Programs a voltage list. The list contains 3 steps: LIST:VOLT 20,10,5	

**[SOURce:]LIST:DWELL <value>{,<value>}**  
**[SOURce:]LIST:DWELL?**

Specifies the dwell time for each list step. Dwell time is the time that the output will remain at a specific step. Dwell times can be programmed from 0 through 262.144 seconds with the following resolution:

Range in seconds	Resolution
0 - 0.262144	1 microsecond
0.262144 - 2.62144	10 microseconds
2.62144 - 26.2144	100 microseconds
26.2144 - 262.144	1 millisecond

Parameter	Typical Return
0 – 262.144, *RST 1 ms	<list value 1>,<list value 2>,<list value 3>
Programs a dwell list. The list contains 3 steps: LIST:DWEL 0.2,0.8,1.6	

**[SOURce:]LIST:CURRent:POINts?**  
**[SOURce:]LIST:DWELL:POINts?**  
**[SOURce:]LIST:VOLTage:POINts?**  
**[SOURce:]LIST:TOUTput:BOStep:POINts?**  
**[SOURce:]LIST:TOUTput:EOStep:POINts?**

Returns the number of points in the specified list. Points are the same as steps. The queries do not return the point values.

Parameter	Typical Return
(none)	<points>
Returns the number of points in the dwell list: LIST:DWEL:POIN?	

**[SOURce:]LIST:STEP ONCE|AUTO**  
**[SOURce:]LIST:STEP?**

Specifies trigger or dwell pacing for the list.

**ONCE** causes the output to remain at the present step until a trigger advances it to the next step. Triggers that arrive during the dwell time are ignored.

**AUTO** causes the output to automatically advance to each step, after the receipt of an initial starting trigger. Steps are paced by the dwell list. As each dwell time elapses, the next step is immediately output.

Parameter	Typical Return
ONCE AUTO, *RST AUTO	ONCE or AUTO
Specifies the list steps to be paced by trigger signals: LIST:STEP ONCE	

**[SOURce:]LIST:TERMinate:LAST 0|OFF|1|ON**  
**[SOURce:]LIST:TERMinate:LAST?**

Determines the output value when the list terminates. When ON (1), the output voltage or current remains at the last list step. The value of the last voltage or current list step becomes the IMMEDIATE value when the list completes. When OFF (0), and also when the list is aborted, the output returns to the settings that were in effect before the list started.

Parameter	Typical Return
0 OFF 1 ON, *RST OFF	0 or 1
Terminate with the output at the last step value: LIST:TERM:LAST ON	

**[SOURce:]LIST:TOUTput:BOSTep[:DATA] 0|OFF|1|ON {,0|OFF|1|ON}**  
**[SOURce:]LIST:TOUTput:BOSTep[:DATA]?**  
**[SOURce:]LIST:TOUTput:EOSTep[:DATA] 0|OFF|1|ON {,0|OFF|1|ON}**  
**[SOURce:]LIST:TOUTput:EOSTep[:DATA]?**

Specifies which list steps generate a trigger signal at the beginning of step (BOSTep) or end of step (EOSTep). A trigger is only generated when the state is set to ON. The trigger signal can be used as a trigger source for measurements and transients of other units, and for digital port pins configured as trigger outputs.

Parameter	Typical Return
0 OFF 1 ON	0 or 1
To generate triggers at the beginning of the second step of a 3-step list: <b>LIST:TOUT:BOST OFF,ON,OFF</b>	



## LXI Subsystem

**LXI:IDENTify[:STATe] 0|OFF|1|ON**  
**LXI:IDENTify[:STATe]?**

Turns the front panel LXI identify indicator on or off. When turned on, the "LAN" status indicator on the front panel blinks on and off to identify the instrument that is being addressed.

Parameter	Typical Return
0 OFF 1 ON, *RST OFF	0 or 1
To blink the front panel LXI indicator: LXI:IDENT ON	

**LXI:MDNS[:STATe] 0|OFF|1|ON**  
**LXI:MDNS[:STATe]?**

Sets the MDNS state on or off.

Parameter	Typical Return
0 OFF 1 ON, *RST OFF	0 or 1
To set the MDNS state on: LXI:MDNS ON	

## MEASure Subsystem

Measure commands measure the output voltage or current. They trigger the acquisition of new data before returning the reading. Measurements are performed by digitizing the instantaneous output voltage or current for a specified measurement time, storing the results in a buffer, and calculating the value for the specified measurement type.

### MEASure[:SCALar]:CURRent[:DC]?

### MEASure[:SCALar]:POWer[:DC]?

### MEASure[:SCALar]:VOLTage[:DC]?

Initiates, triggers, and returns the averaged output measurement. Values returned are either in amperes, volts, or watts.

Parameter	Typical Return
(none)	<DC value>
Returns the measured dc current MEAS:CURR?	

### MEASure[:SCALar]:CURRent:ACDC?

### MEASure[:SCALar]:VOLTage:ACDC?

Initiates, triggers, and returns the total rms measurement (ac + dc). Values returned are either in amperes, or volts.

Parameter	Typical Return
(none)	<ACDC value>
Returns the measured rms voltage MEAS:VOLT:ACDC?	

### MEASure[:SCALar]:CURRent:HIGH?

### MEASure[:SCALar]:VOLTage:HIGH?

Initiates, triggers, and returns the High level of a pulse waveform. Values returned are either in amperes, or volts. See [Measurement Types](#).

Parameter	Typical Return
(none)	<HIGH value>
Returns the measured high level current MEAS:CURR:HIGH?	

**MEASure[:SCALar]:CURRent:LOW?**  
**MEASure[:SCALar]:VOLTage:LOW?**

Initiates, triggers, and returns the Low level of a pulse waveform. Values returned are either in amperes, or volts. See [Measurement Types](#).

Parameter	Typical Return
(none)	<LOW value>
Returns the measured low level voltage <code>MEAS:VOLT:LOW?</code>	

**MEASure[:SCALar]:CURRent:MAXimum?**  
**MEASure[:SCALar]:CURRent:MINimum?**  
**MEASure[:SCALar]:POWer:MAXimum?**  
**MEASure[:SCALar]:POWer:MINimum?**  
**MEASure[:SCALar]:VOLTage:MAXimum?**  
**MEASure[:SCALar]:VOLTage:MINimum?**

Initiates, triggers, and returns the maximum or minimum values of a measurement. Values returned are either in amperes, volts, or watts.

Parameter	Typical Return
(none)	<MIN value>, <MAX value>
Returns the measured maximum current <code>MEAS:CURR:MAX?</code>	
Returns the measured minimum voltage <code>MEAS:VOLT:MIN?</code>	
Returns the measured maximum power <code>MEAS:POW:MAX?</code>	

**MEASure:ARRay:CURRent[:DC]?**  
**MEASure:ARRay:POWer[:DC]?**  
**MEASure:ARRay:VOLTage[:DC]?**

Initiates and triggers a measurement; returns a list of the digitized output measurement samples. Values returned are either in amperes, volts, or watts.

The return format depends on the settings of the `FORMat:BORDER` and `FORMat[:DATA]` commands. When the data format is set to ASCII, returned values are comma separated. When the data format is set to REAL, data is returned as single precision floating point values in definite length arbitrary block response format.

Parameter	Typical Return
(none)	<value> [, <value>] or <Block>
Returns the measured current array <code>MEAS:ARR:CURR?</code>	

## OUTPut Subsystem

The Output subsystem controls the output state, power-on, protection, and relay functions.

### OUTPut [:STATe] 0|OFF|1|ON OUTPut[STATe]?

**WARNING**

**SHOCK HAZARD, LETHAL VOLTAGES** - Many models generate output voltages up to 2,000 VDC! Ensure that all instrument connections, load wiring, load and sense connections are insulated using high-voltage wire. Always attach the safety cover provided, so that no accidental contact with lethal voltages can occur.

Enables or disables the output. The state of a disabled output is a condition of zero output voltage and zero source current.

Parameter	Typical Return
0 OFF 1 ON, *RST OFF	0 or 1
Turns the output off: <code>OUTP OFF</code>	

- When output is enabled, the front-panel status indicator changes from **OFF** to indicate the operating status of the instrument (**CV**, **CC**, etc.).
- Separate delays can be programmed for the off-to-on and the on-to-off transition using `OUTPut:DElay:RISE` and `OUTPut:DElay:FALL`.
- Because of internal circuit start-up procedures, `OUTPut ON` may take 8 milliseconds to complete its function in voltage priority mode, and 7 milliseconds in current priority mode.

### OUTPut[:STATe]:COUPlE[:STATe] 0|OFF|1|ON OUTPut[:STATe]:COUPlE[:STATe]?

Enables or disables output coupling. Output coupling allows the outputs of multiple instruments to turn on and off sequentially according to their specified `OUTPut:DElay:RISE` and `OUTPut:DElay:FALL` programming delays. This parameter is saved in non-volatile memory.

Parameter	Typical Return
0 OFF 1 ON	0 or 1
Turns the output coupling state on: <code>OUTP:COUP ON</code>	

- You must connect and configure the `ONCouple` and `OFFCouple` digital connector pins of all synchronized instruments as described in the **Output Couple Control** section.
- Because some power supplies have different minimum delay offsets, you must also specify a common delay offset for all of the synchronized units. This value must be the largest delay offset of the synchronized group. Use `OUTPut:COUPlE:MAX:DOFFset?` to query the delay offset for each unit. The largest value returned must be specified as the common delay offset for each unit.

**OUTPut[:STATe]:COUPle:DOFFset <value>|MIN|MAX**  
**OUTPut[:STATe]:COUPle:DOFFset? [MIN|MAX]**

Sets a delay offset to synchronize coupled output state changes. Units are in seconds. Setting this time to the maximum delay offset specified for any instrument that is being coupled will cause all coupled outputs to synchronize to the turn-on times specified by OUTPut:DElay:RISE. This parameter is saved in non-volatile memory.

Parameter	Typical Return
0 to 1.023	<delay value>
Specifies a delay of 60 milliseconds: <b>OUTP:COUP:DOFF 0.06</b>	

**OUTPut[:STATe]:COUPle:MAX:DOFFset?**

Returns the delay offset required for this instrument. As a minimum, the OUTPut:COUPle:DElay:OFFSet value must be set to the maximum delay offset returned for any coupled output.

Parameter	Typical Return
(none)	<offset value>
Returns the maximum delay offset: <b>OUTP:COUP:MAX:DOFF?</b>	

**OUTPut[:STATe]:DElay:FALL <value>|MIN|MAX**  
**OUTPut[:STATe]:DElay:FALL? [MIN|MAX]**  
**OUTPut[:STATe]:DElay:RISE <value>|MIN|MAX**  
**OUTPut[:STATe]:DElay:RISE? [MIN|MAX]**

Specifies the delay in seconds that the instrument waits before turning the output on (rise) or off (fall). This allows multiple instruments to turn on or off in sequence. The output will not turn on or off until its delay time has elapsed. This command affects on-to-off state transitions. It does NOT affect transitions to off caused by protection functions. Delay times can be programmed with the following resolution:

Range in seconds	Resolution	Range in seconds	Resolution
0 to 1.023E-4	100 nanoseconds	1.03E-1 to 1.023E+0	1 millisecond
1.03E-4 to 1.023E-3	1 microsecond	1.03E+0 to 1.023E+1	10 milliseconds
1.03E-3 to 1.023E-2	10 microseconds	1.03E+1 to 1.023E+2	100 milliseconds
1.03E-2 to 1.023E-1	100 microseconds	1.03E+2 to 1.023E+3	1 second

Note that both Rise and Fall commands use the same resolution; which is determined by whichever delay time (fall or rise) is the longest.

Parameter	Typical Return
0 - 1023, *RST 0	<delay value>

Sets a delay of 0.5 s before turning the output on: `OUTP:DEL:RISE 0.5`

- Each instrument exhibits a minimum delay offset that applies from the time that a command to turn on the output is received until the output actually turns on. If you specify a turn-on delay, this delay will be added to the minimum delay offset, resulting in a turn-on delay that is actually longer than the one you programmed.
- Use `OUTput:COUPlE:MAX:DOFFset?` to query the delay offset that is required for each instrument.

### **OUTPut[:STATe]:TMODe:COUPlE 0|OFF|1|ON** **OUTPut[:STATe]:TMODe:COUPlE?**

When coupling is enabled, changing the turn-on setting also changes the turn-off setting and vice-versa. If the turn-on and turn-off settings are not the same and coupling is enabled, the turn-off setting will be changed to agree with the turn-on setting.

Parameter	Typical Return
0 OFF 1 ON	0 or 1

Couples the Turn-on/turn-off modes: `OUTP:REL:LOCK ON`

### **OUTPut[:STATe]:TMODe[:OFF] HIGHZ | LOWZ** **OUTPut:TMODe[:OFF]?** **OUTPut[:STATe]:TMODe:ON HIGHZ | LOWZ** **OUTPut:TMODe:ON?**

These commands set the output turn-on and turn-off behavior to Low impedance or High impedance.

**Low Impedance** - programs the output voltage to zero, then disconnects the output. Maximum negative current sinking occurs for up to 250 ms during the turn-off transition.

**High Impedance** - disconnects the output without actively sinking current.

Parameter	Typical Return
HIGHZ LOWZ	HIGHZ or LOWZ

Sets the turn-on state to high impedance: `OUTP:TMOD:ON HIGHZ`  
Sets the turn-off state to low impedance: `OUTP:TMOD:OFF LOWZ`

- The turn-on/turn-off setting only applies when the instrument is operating in voltage priority mode. In current priority mode, the turn-on/turn-off behavior is always high impedance.

## OUTPut:INHibit:MODE LATChing|LIVE|OFF OUTPut:INHibit:MODE?

Sets the operating mode of the remote inhibit digital pin. The inhibit function shuts down the output in response to an external signal on the Inhibit input pin. The Inhibit mode is stored in non-volatile memory. See [Programming the Digital Port](#).

**LATChing** - a logic-true signal on the Inhibit input causes the output state to latch OFF. The output remains disabled until the Inhibit input is returned to logic-false and the latched INH status bit is cleared by sending the OUTPut:PROTection:CLEAr command or a protection clear command from the front panel.

**LIVE** - allows the enabled output to follow the state of the Inhibit input. When the Inhibit input is true, the output is disabled. When the Inhibit input is false, the output is re-enabled.

**OFF** - The Inhibit input is ignored.

Parameter	Typical Return
LATChing LIVE OFF	LATC, LIVE, or OFF
Sets the Inhibit Input to Live mode: <code>OUTP:INH:MODE LIVE</code>	

## OUTPut:PON:STATe RST|RCL0 OUTPut:PON:STATe?

Sets the output power-on state. This determines whether the power-on state is set to the \*RST state (RST) or the state stored in memory location 0 (RCL0). Instrument states can be stored using the \*SAV command. This parameter is saved in non-volatile memory.

Parameter	Typical Return
RST RCL0	RST or RCL0
Sets the power-on state to the *RST state: <code>OUTP:PON:STAT RST</code>	

- If the power-on state is set to 0 with no state stored, a self-test error "file not found; 0 state" is generated and the instrument is set to the \*RST state.
- If a primary **auto-connect** command fails, the power-on state is set to \*RST.

## OUTPut:PROTection:CLEAr

Resets the latched protection. This clears the latched protection status that disables the output when a protection condition occurs (see [Programming Output Protection](#)).

Parameter	Typical Return
(none)	(none)
Clears the latched protection status: <code>OUTP:PROT:CLE</code>	

- All conditions that generate the fault must be removed before the latched status can be cleared. The output is restored to the state it was in before the fault condition occurred.
- If a protection shutdown occurs during an output list, the list continues running even though the output is disabled. When the protection status is cleared and the output becomes enabled again, the output will be set to the values of the step that the list is presently at.

### **OUTPut:PROTection:TEMPerature:MARGin?**

Returns the minimum difference between the internal temperature sensors and the over-temperature trip level. The margin is returned in degrees Celsius.

Parameter	Typical Return
(none)	<margin value>
Returns the temperature margin: <code>OUTP:PROT:TEMP:MARG?</code>	

### **OUTPut:PROTection:WDOG[:STATe] 0|OFF|1|ON OUTPut:PROTection:WDOG[:STATe]?**

Enables or disables the I/O watchdog timer. When enabled, the output will be disabled if there is no I/O activity on any remote interface within the time period specified by the `OUTPut:PROTection:WDOG:DELay` command. The output is latched off but the programmed output state is not changed.

Parameter	Typical Return
0 OFF 1 ON, *RST OFF	0 or 1
Enables the watchdog timer protection: <code>OUTP:PROT:WDOG ON</code>	

### **OUTPut:PROTection:WDOG:DELay <value>|MIN|MAX OUTPut:PROTection:WDOG:DELay? [MIN|MAX]**

Sets the watchdog delay time. When the watchdog timer is enabled, the output is disabled if there is no SCPI I/O activity on any remote interface (USB, LAN, GPIB) within the delay time. The watchdog timer function is NOT reset by activity on the front panel - the output will still shut down after the time period has elapsed. Programmed values can range from 1 to 3600 seconds in 1 second increments.

Parameter	Typical Return
0 - 3600, *RST 60 seconds	<delay value>
Sets a watchdog delay for 600 seconds: <code>OUTP:PROT:WDOG:DEL 600</code>	



**POWer Query****[SOURce:]POWer:LIMit?**

Returns the power limit of the instrument in Watts, either 20 kW or 30 kW.

Parameter	Typical Return
None	20,000 or 30,000
Return the power limit: POWer:LIMit?	

## SASimulator Subsystem

SASimulator commands only apply when the instrument is operating as a solar array simulator. SAS commands program the solar array simulator functions. They are not available when the SAS:MODE is set to FIXed. Error -315, Settings Conflict is generated when commands are not supported in the present operating mode. Refer to [Photovoltaic Simulator Operation](#) for more information.

**[SOURce:]SASimulator:ACTive:MPP:CURRent?**

**[SOURce:]SASimulator:ACTive:MPP:POWer?**

**[SOURce:]SASimulator:ACTive:MPP:VOLTage?**

These commands return the current, power, or voltage of the true maximum power point (MPP) of the curve that is presently running - the active curve. Note that in Curve mode, this value may differ slightly from the user-programmed MPP due to the algorithm that is used to calculate the curve. Likewise, in Table mode, the true MPP may not match any of the I-V table parameters that the user has programmed. Values returned are in amps, volts or watts.

Parameter	Typical Return
(none)	<max power point value>
Returns the current at the maximum power point: SAS:ACT:MPP:CURR?	

**[SOURce:]SASimulator:BWIDth:RANGe <range>**

**[SOURce:]SASimulator:BWIDth:RANGe?**

This command sets the SAS bandwidth range in both Curve and Table modes.

0 - the slow bandwidth range is stable when testing a wide variety of inverter devices.

1 - the fast bandwidth range is optimized for inverter devices with faster MPPT algorithms.

Parameter	Typical Return
0   1; *RST: 0	0   1
Sets the SAS bandwidth to the fast range: SAS:BWID:RANG:1	

**[SOURce:]SASimulator:CURVe:IMP <current>|MIN|MAX**

**[SOURce:]SASimulator:CURVe:IMP? [MIN|MAX]**

This command sets the current at the maximum power point of the SAS curve when operating in Curve mode. The value is amperes.

Parameter	Typical Return
0 to 102% of rating   MIN   MAX; *RST: 0.8% of rating	<Imp setting>
Sets the current of the maximum power point: SAS:CURV:IMP 10	
This sets all four parameters at once: SAS:CURV:IMP 10; ISC 12; VMP 100; VOC 120	

**[SOURce:]SASimulator:CURVe:ISC <current>|MIN|MAX**  
**[SOURce:]SASimulator:CURVe:ISC? [MIN|MAX]**

This command sets the short-circuit current when operating in Curve mode. The value is in amperes.

Parameter	Typical Return
0 to 102% of rating   MIN   MAX; *RST: 1% of rating	<Isc setting>
Sets the short-circuit current: SAS:CURV:ISC 12	
This sets all four parameters at once: SAS:CURV:IMP 10; ISC 12; VMP 100; VOC 120	

**[SOURce:]SASimulator:CURVe:SHAPE <shape>**  
**[SOURce:]SASimulator:CURVe:SHAPE?**

This command sets the curve shape when operating in Curve mode.

SPACE sets the curve shape according to the [space equations](#).

TERRestrial sets the curve shape according to the [terrestrial equations](#).

Parameter	Typical Return
SPACE TERRestrial, *RST: SPACE	SPAC or TERR
Sets the curve shape to TERRestrial: SAS:CURV:SHAP TERR	

**[SOURce:]SASimulator:CURVe:VMP <voltage>|MIN|MAX**  
**[SOURce:]SASimulator:CURVe:VMP? [MIN|MAX]**

This command sets the voltage at the maximum power point of the SAS curve when operating in Curve mode. The value is in volts.

Parameter	Typical Return
0 to 102% of rating   MIN   MAX; *RST: 0.8% of rating	<Vmp setting>
Sets the voltage of the maximum power point: SAS:CURV:VMP 100	
This sets all four parameters at once: SAS:CURV:IMP 10; ISC 12; VMP 100; VOC 120	

**[SOURce:]SASimulator:CURVe:VOC <voltage>|MIN|MAX**  
**[SOURce:]SASimulator:CURVe:VOC? [MIN|MAX]**

This command sets the open-circuit voltage when operating in Curve mode. The value is in volts.

Parameter	Typical Return
0 to 102% of rating   MIN   MAX; *RST: 1% of rating	<Voc setting>
Sets the open-circuit voltage: SAS:CURV:VOC 120	
This sets all four parameters at once: SAS:CURV:IMP 10; ISC 12; VMP 100; VOC 120	

**[SOURce:]SASimulator:MODE <mode>**  
**[SOURce:]SASimulator:MODE?**

This command sets the unit to operate as either a standard power supply or a solar array simulator.

**FIXed** - operates the unit as a standard CV/CC power supply.

**CURVe** - operates the unit as a solar array simulator. The output characteristic is determined by the Isc, Imp, Voc, Vmp, and Shape parameters.

**TABLE** -operates the unit as a solar array simulator. The output characteristic is determined by up to 1024 user-defined table points. The points are validated when using SAS:TABLE:ACT or SAS:TABLE:UPD. If the points do not represent a valid set, an error will be generated.

Parameter	Typical Return
FIXed CURVe TABLE; *RST: FIXed	FIX, CURV, or TABL
Set the unit to operate as a solar array simulator using user-defined table points: SAS:MODE:TABL	

**[SOURce:]SASimulator:SCALE:CURRent <percent>|MIN|MAX**  
**[SOURce:]SASimulator:SCALE:CURRent? [MIN|MAX]**  
**[SOURce:]SASimulator:SCALE:VOLTage <percent>|MIN|MAX**  
**[SOURce:]SASimulator:SCALE:VOLTage? [MIN|MAX]**

These commands set a scale factor for the curve in both Curve and Table modes. Both voltage and current can be scaled at the same time.

The output current will be equal to this percentage multiplied by the current computed from the SAS curve or table. This is often used to simulate variations in solar cell irradiance. The output voltage will be equal to this percentage multiplied by the voltage computed from the SAS curve or table. This is often used to simulate variations in solar cell temperature.

Parameter	Typical Return
1 to 100 (%); *RST: 100	<% value>
Sets the scale factor for the current to 90%: SAS:SCAL:CURR 90 Sets the scale factor for the voltage to 90%: SAS:SCAL:VOLT 90	

- When on, the output will respond immediately to any change in this setting.

**[SOURce:]SASimulator:TABLE:ACTivate 1|2**

This command activates the table points entered using SAS:TABLE:CURR and SAS:TABLE:VOLT.

Parameter	Typical Return
1 2	1 or 2
Activates table1: SAS:TABLE:ACT 1	

- This command is only active in Table mode; otherwise error -315 is generated.
- This command is equivalent to sending both SAS:TABL:UPD, then SAS:TABL:SEL.
- If the SAS:TABL:CURR and SAS:TABL:VOLT commands are sent after the table is activated, the SAS:TABL:ACT command must be sent again to activate the new table values.

### **[SOURce:]SASimulator:TABLE:SElect 1|2**

#### **[SOURce:]SASimulator:TABLE:SElect?**

Selects the active table to run from the two tables that have been entered into the SAS system location. You can only run one active table at a time, Using this command lets you switch between two active tables without turning off the output of the unit.

Parameter	Typical Return
1 2	1 or 2
Selects Table 2: SAS:TABL:SEL 2	

- This command is only active in Table mode.

### **[SOURce:]SASimulator:TABLE:UPDate 1|2**

Validates the data set and updates the specified table in the SAS system. This moves the table data from the memory location to the SAS system location, but does not select the table for use. To use this command, you must have previously loaded a table into the memory location of the unit using SAS:TABL:CURR and SAS:TABL:VOLT.

Parameter	Typical Return
(none)	(none)
Updates Table 2: SAS:TABL:UPD 2	

- This command is only active in Table mode.

### **[SOURce:]SASimulator:TABLE[1|2]:CURRent[:AMPlitude] <current>{,<current>}**

### **[SOURce:]SASimulator:TABLE[1|2]:VOLTage[:AMPlitude] <voltage>{,<voltage>}**

These commands set the voltage and current arrays that define the SAS characteristic when Table mode is selected. Each of these commands must contain a list of voltage or current points, separated by commas (.). The table lists must satisfy the following requirements:

- For each table, the number of points can range from 3 to 1024; however, both tables must contain the same number of points.
- The current point values must be monotonically decreasing. Adjacent values are permitted to be equal. The last value must be zero (a range of  $\pm 0.3$  mA is allowed).
- The voltage point values must be strictly monotonically increasing. Adjacent values are NOT permitted to be equal. The first value must be zero (a range of  $\pm 15$  mV is allowed).

## 5 SCPI Programming Reference

Parameter	Typical Return
Current: The <b>last</b> value must be 0. All previous values must range from 0 to 102% of the unit's current rating. *RST values: 1% of nominal, 0.8% of nominal, 0.0	<value 1>, <value 2>, <value 3>...
Voltage: The <b>first</b> value must be 0. All subsequent values must range from 0 to 102% of the unit's voltage rating. *RST values: 0.0, 0.8% of nominal, 1% of nominal	<value 1>, <value 2>, <value 3>...
Program a simple current table: SAS:TABLE:CURR 20,15,0 Program a simple voltage table: SAS:TABLE:VOLT 0,100,120	

- The points are validated when using SAS:TABLE:ACT or SAS:TABLE:UPD. If the points do not represent a valid set, an error will be generated.
- Table values are **not** saved as part of the instrument state with the \*SAV command.
- If no table number is specified [1 or 2], the commands default to TABLE 1.

### [SOURCE:]SASimulator:TABLE[1|2]:CURRENT:POINTS?

### [SOURCE:]SASimulator:TABLE[1|2]:VOLTAGE:POINTS?

These commands return the number of data points assigned to the voltage and current arrays that define the SAS characteristic when Table mode is selected.

Parameter	Typical Return
(none)	1024
Return the number of data points in a current table: SAS:TABLE:CURR:POIN? Return the number of data points in a voltage table: SAS:TABLE:VOLT:POIN?	

- If no table number is specified [1 or 2], the commands default to TABLE 1.

## SENSe Subsystem

Sense commands control the current measurement ranges and window as well as the data acquisition sequence.

### SENSe:AHOuR:RESet

### SENSe:WHOuR:RESet

Resets the amp-hour or watt-hour measurement to zero.

Parameter	Typical Return
(none)	(none)
Resets the amp-hour measurement: SENS:AHO:RES Resets the watt-hour measurement: SENS:WHO:RES	

### SENSe:ELOG:FUNcTION:CURRent 0|OFF|1|ON

### SENSe:ELOG:FUNcTION:CURRent?

### SENSe:ELOG:FUNcTION:VOLTage 0|OFF|1|ON

### SENSe:ELOG:FUNcTION:VOLTage?

Enables or disables the Elog current or voltage measurement function.

Parameter	Typical Return
0 OFF 1 ON, *RST OFF	0 or 1
Enables datalog current measurements: SENS:ELOG:FUNC:CURR ON Enables datalog voltage measurements: SENS:ELOG:FUNC:VOLT ON	

### SENSe:ELOG:FUNcTION:CURRent:MINMax 0|OFF|1|ON

### SENSe:ELOG:FUNcTION:CURRent:MINMax?

### SENSe:ELOG:FUNcTION:VOLTage:MINMax 0|OFF|1|ON

### SENSe:ELOG:FUNcTION:VOLTage:MINMax?

Enables or disables logging of the minimum and maximum current or voltage values.

Parameter	Typical Return
0 OFF 1 ON, *RST OFF	0 or 1
Enables current MIN/MAX logging values: SENS:ELOG:FUNC:CURR:MINM ON Enables voltage MIN/MAX logging values: SENS:ELOG:FUNC:VOLT:MINM ON	

### SENSe:ELOG:PERIOD <value>|MIN|MAX

### SENSe:ELOG:PERIOD? [MIN|MAX]

Sets the integration time of an Elog measurement.

Although the absolute minimum logging period is 102.4 microseconds, the actual minimum varies as a function of the number of readings that are being logged (see [Integration Period](#)).

Parameter	Typical Return
0.0001024 to 60, *RST MAX	<period>
Specifies a datalog period of 0.01 seconds: <code>SENS:ELOG:PER 0.01</code>	

**SENSe:FUNCTION:CURRENT 0|OFF|1|ON**

**SENSe:FUNCTION:CURRENT?**

**SENSe:FUNCTION:VOLTage 0|OFF|1|ON**

**SENSe:FUNCTION:VOLTage?**

Enables or disables current or voltage measurements.

Parameter	Typical Return
0 OFF 1 ON, *RST ON	0 or 1
Enables current measurements: <code>SENS:FUNC:CURR ON</code> Disables voltage measurements: <code>SENS:FUNC:VOLT OFF</code>	

**SENSe:SWEep:NPLCycles <value>|MIN|MAX**

**SENSe:SWEep:NPLCycles? [MIN|MAX]**

Sets the measurement time in number of power line cycles. Increasing the number of power line cycles reduces the measurement noise on current and voltage measurements. Changing the NPLC changes the number of points and time interval setting.

Parameter	Typical Return
0.0003072 to 1,258,290,000,000, *RST 1	<NPLC value>
Specifies 100 power line cycles: <code>SENS:SWE:NPLC 100</code>	

**SENSe:SWEep:OFFSet:POINts <value>|MIN|MAX**

**SENSe:SWEep:OFFSet:POINts? [MIN|MAX]**

Defines the offset in a data sweep for triggered measurements. Positive values represent the delay after the trigger occurs but before the samples are acquired. Negative values represent data samples taken prior to the trigger.

Parameter	Typical Return
-524,287 to 2,000,000,000, *RST 0	<offset points>
Specifies -2048 offset points: <code>SENS:SWE:OFFS:POIN -2048</code>	



**SENSe:SWEep:POINts <value>|MIN|MAX**  
**SENSe:SWEep:POINts? [MIN|MAX]**

Defines the number of points in a measurement. Note that points, TINTerval, and NPLC are interrelated. Setting either points or TINTerval changes the NPLC; setting NPLC can change both points and TINTerval. The default number of points result in a measurement of 1 NPLC.

Parameter	Typical Return
1 to 524,288 MIN MAX, *RST 3255 (60 Hz); 3906 (50 Hz)	<points>
Specifies 2048 points: SENS:SWE:POIN 2048	

**SENSe:SWEep:TINTerval <value>|MIN|MAX**  
**SENSe:SWEep:TINTerval? [MIN|MAX]**

Defines the time period between measurement samples. Units are in seconds. Values are rounded to the nearest 20.48 microsecond increment. Below 20.48 microseconds, values are rounded to the nearest 10.24 or 5.12 microsecond increment respectively.

Parameter	Typical Return
0.00000512 to 40,000, *RST 0.00000512	<time interval>
Specifies an interval of 1 ms between points: SENS:SWE:TINT 0.001	

**SENSe:WINDow[:TYPE] HANNing|RECTangular**  
**SENSe:WINDow[:TYPE]?**

Selects the measurement window. This sets a signal conditioning function used in scalar dc measurement calculations. Neither window function alters the instantaneous voltage or current data returned in the measurement array.

**Hanning** window is a "raised cosine" function. It is a signal conditioning function that reduces errors in dc measurement calculations in the presence of periodic signals such as ac line ripple. This window only works up to 4883 measurement points. The instrument will revert to a rectangular window when the points exceed 4883.

**Rectangular** window returns measurement calculations with no signal conditioning.

Parameter	Typical Return
HANNing RECTangular, *RST RECTangular	RECT or HANN
Specifies a Hanning window function: SENS:WIND HANN	

## **[SOURce] Subsystem**

The SOURce keyword is optional in many commands that set parameters for a source or output, such as [SOURce:]CURRent <value>.

Because SOURce subsystem commands are often used without the optional SOURce keyword, these commands are listed by their individual subsystems, below:

### **Subsystems and Commands Using the Optional [SOURce:] Keyword**

**ARB**

**CURRent**

**DIGital**

**FUNction**

**LIST**

**POWer:LIMit**

**SASimulator (photovoltaic)**

**STEP:TOUTput**

**VOLTage**

## STATus Subsystem

Status register programming lets you determine the operating condition of the instrument at any time. The instrument has three groups of status registers; Operation, Questionable, and Standard Event. The Operation and Questionable status groups each consist of the Condition, Enable, and Event registers as well as NTR and PTR filters.

The Status subsystem is also programmed using Common commands. Common commands control additional status functions such as the Service Request Enable and the Status Byte registers. Refer to [Status Tutorial](#) for more information.

### STATus:OPERation[:EVENT]

Queries the **event register** for the **Operation Status** group. This is a read-only register, which stores (latches) all events that are passed by the Operation NTR and/or PTR filter. Reading the Operation Status Event register clears it.

Parameter	Typical Return
(none)	<bit value>
Read the operation status event register: STAT:OPER?	

- The value returned is the binary-weighted sum of all enabled bits in the register. For example, with bit 3 (value 8) and bit 5 (value 32) set and enabled, the query returns +40.
- \*RST has no effect on this register.

### STATus:OPERation:CONDition?

Queries the **condition register** for the **Operation Status** group. This is a read-only register, which holds the live (unlatched) operational status of the instrument. Reading the Operation Status Condition register does not clear it.

Parameter	Typical Return
(none)	<bit value>
Read the operation status condition register: STAT:OPER:COND?	

- The value returned is the binary-weighted sum of all enabled bits in the register. For example, with bit 3 (value 8) and bit 5 (value 32) set and enabled, the query returns +40.
- The condition register bits reflect the current condition. If a condition goes away, the corresponding bit is cleared.
- \*RST clears this register, other than those bits where the condition still exists after \*RST.

**STATus:OPERation:ENABLE <value>****STATus:OPERation:ENABLE?**

Sets the value of the **enable register** for the **Operation Status** group. The enable register is a mask for enabling specific bits from the Operation Event register to set the OPER (operation summary) bit of the Status Byte register. STATus:PRESet clears all bits in the enable register.

Parameter	Typical Return
A decimal value corresponding to the binary-weighted sum of the register's bits.	<bit value>
Enable bit 3 and 4 in the enable register: STAT:OPER:ENAB 24	

- For example, with bit 3 (value 8) and bit 5 (value 32) set and enabled, the query returns +40.
- \*CLS does not clear the enable register, but does clear the **event register**.

**STATus:OPERation:NTRansition <value>****STATus:OPERation:NTRansition?****STATus:OPERation:PTRansition <value>****STATus:OPERation:PTRansition?**

Sets and queries the value of the **NTR** (Negative-Transition) and **PTR** (Positive-Transition) registers. These registers serve as a polarity filter between the Operation Condition and Operation Event registers.

When a bit in the NTR register is set to 1, then a 1-to-0 transition of the corresponding bit in the Operation Condition register causes that bit in the Operation Event register to be set.

When a bit in the PTR register is set to 1, then a 0-to-1 transition of the corresponding bit in the Operation Condition register causes that bit in the Operation Event register to be set.

STATus:PRESet sets all bits in the PTR registers and clears all bits in the NTR registers.

Parameter	Typical Return
A decimal value corresponding to the binary-weighted sum of the register's bits.	<bit value>
Enable bit 3 and 4 in the NTR register: STAT:OPER:NTR 24	
Enable bit 3 and 4 in the PTR register: STAT:OPER:PTR 24	

- If the same bits in both NTR and PTR registers are set to 1, then any transition of that bit at the Operation Condition register sets the corresponding bit in the Operation Event register.
- If the same bits in both NTR and PTR registers are set to 0, then no transition of that bit at the Operation Condition register can set the corresponding bit in the Operation Event register.
- The value returned is the binary-weighted sum of all enabled bits in the register.

**STATus:PRESet**

Presets all Enable, PTR, and NTR registers.

Operation register	Questionable register	Preset setting
STAT:OPER:ENAB	STAT:QUES<1 2>:ENAB	all defined bits are disabled
STAT:OPER:NTR	STAT:QUES<1 2>:NTR	all defined bits are disabled
STAT:OPER:PTR	STAT:QUES<1 2>:PTR	all defined bits are enabled

Parameter	Typical Return
(none)	(none)

Preset the Operation and Questionable registers: STAT:PRES

**STATus:QUEStionable<1|2>[:EVENT]?**

Queries the **event register** for the **Questionable Status** group. This is a read-only register, which stores (latches) all events that are passed by the Operation NTR and/or PTR filter. Reading the Questionable Status Event register clears it.

Parameter	Typical Return
(none)	<bit value>

Read questionable status event register #1: STAT:QUES1?

- The value returned is the binary-weighted sum of all enabled bits in the register. For example, with bit 2 (value 4) and bit 4 (value 16) set, the query returns +20.
- \*RST has no effect on this register.

**STATus:QUEStionable<1|2>:CONDition?**

Queries the **condition register** for the **Questionable Status** group. This is a read-only register, which holds the live (unlatched) operational status of the instrument. Reading the Questionable Status Condition register does not clear it.

Parameter	Typical Return
(none)	<bit value>

Read questionable status condition register #1: STAT:QUES1:COND?

- The value returned is the binary-weighted sum of all enabled bits in the register. For example, with bit 2 (value 4) and bit 4 (value 16) set, the query returns +20.
- The condition register bits reflect the current condition. If a condition goes away, the corresponding bit is cleared.
- \*RST clears this register, other than those bits where the condition still exists after \*RST.

**STATus:QUESTionable<1|2>:ENABLE <value>**  
**STATus:QUESTionable<1|2>:ENABLE?**

Sets the value of the **enable register** for the **Questionable Status** group. The enable register is a mask for enabling specific bits from the Operation Event register to set the QUES (questionable summary) bit of the Status Byte register. STATus:PRESet clears all bits in the enable register.

Parameter	Typical Return
A decimal value corresponding to the binary-weighted sum of the register's bits.	<bit value>
Enable bit 2 and 4 in the questionable enable register #1: STAT:QUES1:ENAB 20	

- For example, with bit 2 (value 4) and bit 4 (value 16) set, the query returns +20.
- \*CLS does not clear the enable register, but does clear the **event register**.

**STATus:QUESTionable<1|2>:NTRansition <value>**  
**STATus:QUESTionable<1|2>:NTRansition?**  
**STATus:QUESTionable<1|2>:PTRansition <value>**  
**STATus:QUESTionable<1|2>:PTRansition?**

Sets and queries the value of the **NTR** (Negative-Transition) and **PTR** (Positive-Transition) registers. These registers serve as a polarity filter between the Questionable Condition and Questionable Event registers.

When a bit in the NTR register is set to 1, then a 1-to-0 transition of the corresponding bit in the Questionable Condition register causes that bit in the Questionable Event register to be set.

When a bit in the PTR register is set to 1, then a 0-to-1 transition of the corresponding bit in the Questionable Condition register causes that bit in the Questionable Event register to be set.

STATus:PRESet sets all bits in the PTR registers and clears all bits in the NTR registers.

Parameter	Typical Return
A decimal value corresponding to the binary-weighted sum of the register's bits.	<bit value>
Enable bit 3 and 4 in the questionable NTR register #1: STAT:QUES1:NTR 24	
Enable bit 3 and 4 in the questionable PTR register #1: STAT:QUES1:PTR 24	

- If the same bits in both NTR and PTR registers are set to 1, then any transition of that bit at the Questionable Condition register sets the corresponding bit in the Questionable Event register.
- If the same bits in both NTR and PTR registers are set to 0, then no transition of that bit at the Questionable Condition register can set the corresponding bit in the Questionable Event register.
- The value returned is the binary-weighted sum of all enabled bits in the register.

## STEP Command

**[SOURce:]STEP:TOUTput 0|OFF|1|ON**

**[SOURce:]STEP:TOUTput?**

Specifies whether a trigger out is generated when a transient step occurs. A trigger is generated when the state is on (true).

Parameter	Typical Return
0 OFF 1 ON, *RST OFF	0 or 1
Sets the step trigger signal to ON: <b>STEP:TOUT ON</b>	

## SYSTEM Subsystem

System commands control system functions that are not directly related to output control, measurement, or status functions. Note that IEEE-488 Common commands also control system functions such as self-test, saving and recalling states, and others.

### SYSTEM:COMMunicate:LAN:CONTrol? SYSTEM:COMMunicate:TCPIP:CONTrol?

Returns the initial socket control connection port number. This connection is used to send and receive commands and queries. Unlike the data socket, which uses a fixed port number, the control socket port number varies and must be obtained using these queries.

Parameter	Typical Return
(none)	<port #> (0 if sockets not supported)

Query the Control connection port number:  
 SYST:COMM:LAN:CONT? or SYST:COMM:TCP:CONT?

### SYSTEM:COMMunicate:RLState LOCAL|REMOte|RWLock SYSTEM:COMMunicate:RLState?

Configures the remote/local state of the instrument. Remote and local do the same thing and are included for compatibility with other products. **LOCAL** sets instrument to front panel control. **REMOte** sets the instrument to front panel control. **RWLock** disables the front panel keys. The instrument can only be controlled via the remote interface. This programmable setting is completely independent from the front panel lock/unlock function.

Parameter	Typical Return
LOCAL REMOte RWLock, *RST LOCAL	LOC, REM, or RWL

Sets the remote/local state to remote: SYST:COMM:RLST REM

- The remote/local state is unaffected by \*RST or any SCPI commands other than SYSTEM:COMMunicate:RLState.
- The remote/local instrument state can also be set by other interface commands over the GPIB and some other I/O interface.
- When multiple remote programming interfaces are active, the interface with the most recently changed remote/local state determines the instrument's remote/local state.



## SYSTem:DATE <yyyy>, <mm>, <dd> SYSTem:DATE?

Sets the date of the system clock. Specify the year (2000 to 2099), month (1 to 12), and day (1 to 31). The system clock is only used in conjunction with the BenchVue Power Control and Analysis software.

Parameter	Typical Return
<yyyy>,<mm>,<dd>	+2018,+04,+30
Set the date to June 30, 2018: SYST:DATE 2018,06,30	

- The system clock does not adjust itself for time zone changes or daylight savings time.

## SYSTem:ERRor?

Reads and clears one error from the error queue.

Parameter	Typical Return
(none)	<+0,"No error">
Reads and clear first error in error queue: SYST:ERR?	

- The front-panel ERR annunciator turns on when one or more errors are currently stored in the error queue. Error retrieval is first-in-first-out (FIFO), and errors are cleared as you read them. When you have read all errors from the error queue, the ERR annunciator turns off.
- If more than 30 errors have occurred, the last error stored in the queue (the most recent error) is replaced with -350,"Error queue overflow". No additional errors are stored until you remove errors from the queue. If no errors have occurred when you read the error queue, the instrument responds with +0,"No error".
- The error queue is cleared by the \*CLS and when power is cycled. It is not cleared by a \*RST.
- Errors have the following format <error code>,<error string>. The error string may contain up to 255 characters. For a list of error codes and message strings, see [SCPI Error Messages](#).

## SYSTem:PASSword:FPANel:RESet

Resets the front panel lockout password to zero. This command does not reset the calibration password.

Parameter	Typical Return
(none)	<+0,"No error">
Resets the front panel password: SYST:PASS:FPAN:RES	

**SYSTem:REBoot**

Reboots the instrument to its power-on state.

Parameter	Typical Return
(none)	(none)
Reboots the instrument: SYST:REB	

**SYSTem:SECurity:IMMediate**

Clears all user memory and reboots the instrument. This command is typically used to prepare the instrument for removal from a secure area. It sanitizes all user data. It writes all zeros to flash memory and then performs a chip erase as per manufacturer's data sheet. Identification data (instrument firmware, model number, serial number, MAC address and calibration data) is not erased. After the data is cleared, the instrument is rebooted.

This procedure is not recommended for use in routine applications because of the possibility of unintended loss of data.

Parameter	Typical Return
(none)	(none)
Sanitizes the instrument: SYST:SEC:IMM	

**SYSTem:SET <block data>****SYSTem:SET?**

Get and set the instrument state. The query form of the command returns a definite length block that contains the instrument state. This block data can be sent back to the instrument to restore it to the state in the block.

Parameter	Typical Return
<block data>	<block data>
Sends the block state back to the instrument: SYST:SET <block data>	

**SYSTem:TIME <hh>, <mm>, <ss>****SYSTem:TIME?**

Sets the time of the system clock. Specify hours (0 to 23), minutes (0 to 59), and seconds (0 to 59). The real time clock is only used in conjunction with the BenchVue Power Control and Analysis software.

Parameter	Typical Return
<hh>,<mm>,<ss>	<hh,mm,ss>
Set the clock to 8:30 PM: SYST:TIME2018,06,30	

**SYSTem:VERSion?**

Returns the SCPI version that the instrument complies with. Cannot be determined from front panel.

Parameter	Typical Return
(none)	<"version">
Return the SCPI version: SYST:VERS?	

- The command returns a string in the form "YYYY.V", where YYYY represents the year of the version and V represents a version for that year.

## TRIGger Subsystem

Trigger commands control the transient and acquisition subsystems. Refer to [Trigger Overview](#) for more information.

### TRIGger:ACQuire[:IMMEDIATE]

### TRIGger:ELOG[:IMMEDIATE]

### TRIGger:TRANSient[:IMMEDIATE]

Generates an immediate trigger. This overrides any selected trigger source.

TRIGger:ACQuire triggers the acquisition system.

TRIGger:ELOG triggers the external datalogger.

TRIGger:TRANSient triggers the transient system.

Parameter	Typical Return
(none)	(none)

Generate a measurement trigger: TRIG:ACQ

### TRIGger:ACQuire:CURRent[:LEVel] <value>|MIN|MAX

### TRIGger:ACQuire:CURRent[:LEVel]? [MIN|MAX]

### TRIGger:ACQuire:VOLTage[:LEVel] <value>|MIN|MAX

### TRIGger:ACQuire:VOLTage[:LEVel]? [MIN|MAX]

Sets the triggered level of the output. Applies when the measurement trigger source is set to a level. Values are specified in either amperes or volts. The minimum and maximum values depend on the ratings of the unit.

Parameter	Typical Return
Voltage: 0 to 102% of rating, *RST 0 Current: -102% to 102% of rating	<level value>

Set the triggered current level to 3 A: TRIG:ACQ:CURR 3  
Set the triggered voltage level to 50 V: TRIG:ACQ:VOLT 50

### TRIGger:ACQuire:CURRent:SLOPe POSitive|NEGative

### TRIGger:ACQuire:CURRent:SLOPe?

### TRIGger:ACQuire:VOLTage:SLOPe POSitive|NEGative

### TRIGger:ACQuire:VOLTage:SLOPe?

Sets the slope of the signal. Applies when the measurement trigger source is set to a level. **POSitive** specifies a rising slope of the output signal. **NEGative** specifies a falling slope of the output signal.

Parameter	Typical Return
POSitive NEGative, *RST POSitive	POS or NEG
Set current slope to negative (falling edge): TRIG:ACQ:CURR:SLOP NEG Set voltage slope to negative (falling edge): TRIG:ACQ:VOLT:SLOP NEG	

### TRIGger:ACQuire:INDices[:DATA]?

Returns the indices into the acquired data where triggers were captured during the acquisition. The number of indices returned is the same as the value returned by TRIGger:ACQuire:INDices:COUNT?

Parameter	Typical Return
(none)	<time>
Returns the number of indices: TRIG:ACQ:IND?	

### TRIGger:ACQuire:INDices:COUNT?

Returns the number of triggers captured during the acquisition.

Parameter	Typical Return
(none)	<time>
Return the number of triggers: TRIG:ACQ:IND:COUN?	

### TRIGger:ACQuire:SOURce <source>

#### TRIGger:ACQuire:SOURce?

Selects the trigger source for the acquisition system:

<b>BUS</b>	Selects a remote interface trigger command.
<b>CURRent1</b>	Selects an output current level.
<b>EXTernal</b>	Selects ALL digital port pins that have been configured as trigger sources.
<b>PIN&lt;1-7&gt;</b>	Selects a digital port pin configured as a trigger input.
<b>TRANsient1</b>	Selects the transient system as the trigger source.
<b>VOLTage1</b>	Selects an output voltage level.

Parameter	Typical Return
BUS CURRent1   EXTernal   PIN<1-7>   TRANsient1   VOLTage1, *RST BUS	BUS, CURR1, EXT, PIN<n>, TRAN1, or VOLT1
Select digital port pin 1 as the measurement trigger source: TRIG:ACQ:SOUR PIN1	

**TRIGger:ACQuire:TOUTput[:ENABLE] 0|OFF|1|ON**  
**TRIGger:ACQuire:TOUTput[:ENABLE]?**

Enables measurement triggers to be sent to a digital port pin. The digital port pin must be configured as trigger output before it can be used as a trigger source (see **External Trigger I/O**).

Parameter	Typical Return
0 OFF 1 ON, *RST OFF	0 or 1
Enable sending measurement triggers to digital pins: TRIG:ACQ:TOUT ON	

**TRIGger:ARB:SOURce <source>**  
**TRIGger:ARB:SOURce?**  
**TRIGger:ELOG:SOURce <source>**  
**TRIGger:ELOG:SOURce?**  
**TRIGger:TRANSient:SOURce <source>**  
**TRIGger:TRANSient:SOURce?**

TRIG:ARB:SOURce - Selects the trigger source for arbitrary waveforms:

TRIG:ELOG:SOURce - Selects the trigger source for external data logging:

TRIG:TRANSient:SOURce - Selects the trigger source for the transient system:

<b>BUS</b>	Selects a remote interface trigger command.
<b>EXternal</b>	Selects ALL digital port pins that have been configured as trigger sources.
<b>IMMediate</b>	Triggers the transient as soon as it is INITiated.
<b>PIN&lt;1-7&gt;</b>	Selects a digital port pin configured as a trigger input.

Parameter	Typical Return
BUS   EXternal   IMMediate   PIN<1-7> *RST BUS	BUS, EXT, IMM, PIN<n>
Select digital port pin 1 as the Arb trigger source: TRIG:ARB:SOUR PIN1	
Select digital port pin 1 as the transient trigger source: TRIG:TRAN:SOUR PIN1	

## VOLTage Subsystem

Voltage commands program the output voltage of the instrument.

**[SOURce:]VOLTage[:LEVel][:IMMediate][:AMPLitude] <value>|MIN|MAX**  
**[SOURce:]VOLTage[:LEVel][:IMMediate][:AMPLitude]? [MIN|MAX]**  
**[SOURce:]VOLTage[:LEVel]:TRIGgered[:AMPLitude] <value>|MIN|MAX**  
**[SOURce:]VOLTage[:LEVel]:TRIGgered[:AMPLitude]? [MIN|MAX]**

Sets the immediate or triggered voltage level when the output is operating in voltage priority mode. The triggered level is the value that is transferred to the output when an output Step is triggered. Units are in volts. The maximum value depends on the voltage rating of the unit.

Parameter	Typical Return
0.1% to 102% of rating, *RST 0.1% of rating	<voltage level>
Sets the output voltage to 20 V: <code>VOLT 20</code> Sets the triggered voltage to 10 V: <code>VOLT:TRIG 10</code>	

**[SOURce:]VOLTage:BWIDth:LEVel 0 | 1 | 2, <value>|MIN|MAX**  
**[SOURce:]VOLTage:BWIDth:LEVel? 0 | 1 | 2, [MIN|MAX]**

Sets the programming corner frequency associated with each compensation range. The value is in Hertz. The default frequency is optimized for maximum up-programming speed as well as the fastest transient response time. It can be reduced to compensate for output overshoots.

Parameter	Typical Return
0   1   2 (bandwidth range)	0, 1, or 2
10 to 100,000 for all ranges, *RST: 5,000 (comp0), 450 (comp1), 12 (comp2)	<corner frequency>
Sets the voltage bandwidth range to 1, frequency 10 kHz: <code>VOLT:BWID:LEV 1, 10,000</code>	

**[SOURce:]VOLTage:BWIDth:RANGe 0 | 1 | 2**  
**[SOURce:]VOLTage:BWIDth:RANGe?**

Sets the voltage compensation range. This lets you optimize output response time with capacitive loads. These compensation modes only apply when the unit is operating in constant voltage (CV), both in voltage priority and in current priority (when in voltage limit). Refer to [Set the Output Bandwidth](#) for information about the effect that the compensation settings have on the Programming Speed Characteristics.

0 (High speed/Small capacitive load) – provides the fastest programming speed and transient response time.

1 (Medium speed/Medium capacitive load) – provides intermediate programming speed and transient response time. setting is optimized for stability with a wide range of output capacitors.

2 (Slow speed/Large capacitive load) – best suited for DUTs with high capacitance/low ESR with the trade-off of a slower programming speed and transient response.

Parameter	Typical Return
0 1 2, *RST 0	0, 1, or 2
Sets the voltage bandwidth to comp 1: VOLT:BWID:RANG 1	

**[SOURce:]VOLTage:LIMit[:POSitive][:IMMediate][:AMPLitude] <value>|MIN|MAX**  
**[SOURce:]VOLTage:LIMit[:POSitive][:IMMediate][:AMPLitude]? [MIN|MAX]**

Sets the voltage limit when in current priority mode. Units are in volts.

Parameter	Typical Return
0.1% to 102% of rating, *RST 1% of rating	<voltage limit>
Sets the voltage limit to 20 V: VOLT:LIM 20	

**[SOURce:]VOLTage:LIMit:LOW <value>|MIN|MAX**  
**[SOURce:]VOLTage:LIMit:LOW? [MIN|MAX]**

Sets the low voltage limit when in current priority mode. This prevents the voltage from dropping below the low voltage limit when discharging a battery. When the voltage drops to the specified low limit value, the output transitions from current priority to negative voltage limit and the discharging stops. This sets the LIM- bit in the Questionable Status Register.

Parameter	Typical Return
0 to 102% of rating, *RST 0	<low voltage limit>
Sets the low voltage limit to 2 V: VOLT:LIM:LOW 2	

- This command is coupled to the VOLTage:LIMit command. The voltage limit must always be programmed to a higher value than low voltage limit.
- The low voltage limit also prevents the output from turning on when the output voltage is below the programmed low voltage limit. Refer to VOLTage:PROTection:LOW:DElay.

**[SOURce:]VOLTage:LIMit:LOW:STATe 0|OFF|1|ON**  
**[SOURce:]VOLTage:LIMit:LOW:STATe?**

Enables or disables the low-voltage limit.

Parameter	Typical Return
0 OFF 1 ON, *RST OFF	0 or 1
Enable the low voltage limit state: VOLT:LIM:LOW:STAT ON	



**[SOURce:]VOLTage:MODE FIXed|STEP|LIST|ARB**  
**[SOURce:]VOLTage:MODE?**

Sets the transient mode. This determines what happens to the output voltage when the transient system is initiated and triggered.

**FIXed** keeps the output voltage at its immediate value.

**STEP** steps the output to the triggered level when a trigger occurs.

**LIST** causes the output to follow the list values when a trigger occurs.

**ARB** causes the output to follow the arbitrary waveform values when a trigger occurs.

Parameter	Typical Return
FIXed STEP LIST ARB, *RST FIXed	FIX, STEP, LIST, or ARB
Sets the voltage mode to Step: VOLT:MODE STEP	

**[SOURce:]VOLTage:PROTection[:LEVel] <value>|MIN|MAX**  
**[SOURce:]VOLTage:PROTection[:LEVel]? [MIN|MAX]**

Sets the over-voltage protection level. Units are in volts. If the output voltage exceeds the OVP level, the output is disabled and the Questionable Condition status register OV bit is set.

Parameter	Typical Return
0 to 120% of rating, *RST 120% of rating	<protect level>
Sets the over-voltage protection to 24 V: VOLT:PROT 24	

- An over-voltage condition can be cleared with the OUTput:PROTection:CLEar command after the cause of the condition has been removed.

**[SOURce:]VOLTage:PROTection:LOW[:LEVel] <value>|MIN|MAX**  
**[SOURce:]VOLTage:PROTection:LOW[:LEVel] ? [MIN|MAX]**

Prevents the output from turning on if the output voltage is below the low voltage protection level. When the low voltage condition is true, the Questionable Status Register UV bit is set.

Parameter	Typical Return
0 to 102% of rating, *RST 0	<low-voltage protect setting>
Sets the protection level to 2 V: VOLT:PROT:LOW 2	

**[SOURce:]VOLTage:PROTection:LOW:DELAy <value>|MIN|MAX**  
**[SOURce:]VOLTage:PROTection:LOW:DELAy? [MIN|MAX]**

Sets the low-voltage protection delay in seconds. The low voltage protection function will not be triggered during the delay time. After the delay time has expired, the low voltage protection function will be active. This can be used to suppress a false trip when low voltage protection has been enabled

and the output is turned on, or the voltage is programmed from 0 to a value above the low voltage protection level.

Note that if you enable low voltage protection and then turn on the output without using the delay, the protection will immediately trip as the output voltage starts rising from zero, which is below the low voltage protection level.

Parameter	Typical Return
0.00002048 – 2611 seconds, *RST 20.48 $\mu$ s	<delay value>
Sets the protection delay to 0.2 seconds: <code>VOLT:PROT:LOW:DEL 0.2</code>	

### **[SOURce:]VOLTage:PROTection:LOW:STATe 0|OFF|1|ON** **[SOURce:]VOLTage:PROTection:LOW:STATe?**

Enables or disables low-voltage protection.

Parameter	Typical Return
0 OFF 1 ON, *RST OFF	0 or 1
Enable the low voltage protection state: <code>VOLT:PROT:LOW:STAT ON</code>	

- A low voltage condition can be cleared with `OUTPut:PROTection:CLEar` after the cause of the condition is removed.

### **[SOURce:]VOLTage:RESistance[:LEVel][:IMMediate][:AMPLitude] <value>|MIN|MAX** **[SOURce:]VOLTage:RESistance[:LEVel][:IMMediate][:AMPLitude]? [MIN|MAX]**

Sets the output resistance level. Only applies in voltage priority mode. Units are in ohms. Refer to the [characteristics](#) tables for the model-specific resistance programming ranges.

Parameter	Typical Return
0 to maximum (model dependent)   MIN   MAX, *RST 0	0
Specifies an output resistance of 0.5 ohms: <code>VOLT:RES 0.5</code>	

- When units are connected in parallel, the maximum output resistance is reduced. The programmable resistance for a single unit must be divided by the total number of paralleled units.

### **[SOURce:]VOLTage:RESistance:STATe 0|OFF|1|ON** **[SOURce:]VOLTage:RESistance:STATe?**

Enables or disables output resistance programming. Only applies in voltage priority mode.

Parameter	Typical Return
0 OFF 1 ON, *RST OFF	0 or 1
Turns resistance programming on: <code>VOLT:RES:STAT ON</code>	

**[SOURce:]VOLTage:SLEW[:IMMEDIATE] <value>[MIN|MAX|INFINITY  
[SOURce:]VOLTage:SLEW[:IMMEDIATE]? [MIN|MAX]**

Sets the voltage slew rate. The slew rate is set in volts per second and affects all programmed voltage changes, including those due to the output state turning on or off. The slew rate can be set to any value between 0 and 9.9E+37. For very large values, the slew rate will be limited by the unit's listed programming speed and bandwidth. Keywords MAX or INFINITY set the slew rate to maximum.

Parameter	Typical Return
0 – 9.9E+37, *RST MAX	<max value>
Sets the output slew rate to 5 V per second: <code>VOLT:SLEW 5</code>	

- The query returns the value that was sent. If the value is less than the minimum slew rate, the minimum value is returned. The resolution of the slew setting is the same as the minimum value. This can be queried using `VOLTage:SLEW? MIN`. The exact value varies slightly based on calibration.

**[SOURce:]VOLTage:SLEW:MAXimum 0|OFF|1|ON  
[SOURce:]VOLTage:SLEW:MAXimum?**

Enables or disables the maximum slew rate override. When enabled, the slew rate is set to its maximum value. When disabled, the slew rate is set to the immediate value set by the `VOLTage:SLEW` command. Use `VOLTage:SLEW? MAX` to query the maximum slew rate that was set.

Parameter	Typical Return
0 OFF 1 ON, *RST ON	0 or 1
Enable the maximum slew rate override: <code>VOLT:SLEW:MAX ON</code>	

- The `VOLTage:SLEW:MAX` command is coupled to the `VOLTage:SLEW` command. If `VOLTage:SLEW` sets the rate to MAX or INFINITY, `VOLTage:SLEW:MAX` is enabled. If the slew rate is set to any other value, `VOLTage:SLEW:MAX` is disabled.

## Status Tutorial

This section provides a detailed description of the individual registers and register groups. The status diagram provides a graphical view of how the status registers and groups are interconnected.

### Status Registers

#### Operation Status Group

#### Questionable Status Groups

#### Standard Event Status Group

#### Status Byte Register

#### Error and Output Queues

#### Status Diagram

## Status Registers

The Operation and Questionable status groups use four different types of registers to track, qualify, flag, and enable instrument events. The Standard Event group only uses Event and Enable registers.

- A Condition register continuously monitors the state of the instrument. The bits in the condition register are updated in real time and the bits are not latched.
- An PTR/NTR register qualifies the signal that passes to the event register. When a PTR bit is set, signals with positive edge transition pass to the event register. When an NTR bit is set, signals with a negative edge transition pass to the event register. When both bits are set, all signal pass. When neither bits are set, no signals pass.
- An Event register latches transitions that pass through the PTR and NTR registers. When an event bit is set, it remains set until the Event register is read. Reading the Event register clears it.
- An Enable register defines which bits in the event register will be reported to the Status Byte register. You can write to or read from an enable register.

## Operation Status Group

These registers record signals that occur during normal operation. The groups consist of a Condition, PTR/NTR, Event, and Enable register. The outputs of the Operation Status register group are logically-ORed into the OPERation summary bit (7) of the Status Byte register. Refer to **Status Diagram**.

The following table describes the Operation Status register bit assignments.

Bit	Bit Name	Decimal Value	Definition
0	CV	1	Output is in constant voltage
1	CC	2	Output is in constant current
2	OFF	4	Output is programmed off or is in protection state
3	WTG-meas	8	Measurement system is waiting for a trigger
4	WTG-tran	16	Transient system is waiting for a trigger
5	MEAS-active	32	Measurement is initiated or in progress
6	TRAN-active	64	Transient is initiated or in progress
7-15	not used	not used	0 is returned

### Questionable Status Groups

These registers record signals that indicate abnormal operation. The groups consist of a Condition, PTR/NTR, Event, and Enable register. The outputs of the Questionable Status groups are logically-ORed into the QUESTIONABLE summary bit (3) of the Status Byte register. Refer to [Status Diagram](#).

The following table describes the Questionable1 Status register bit assignments.

Bit	Bit Name	Decimal Value	Definition
0	OV	1	Output is disabled by the over-voltage protection
1	OC	2	Output is disabled by the over-current protection
2	PF	4	Output is disabled by power-fail (low-line or brownout on ac line)
3	OP+	8	Output is disabled by the positive over-power limit
4	OT	16	Output is disabled by the over-temperature protection
5	OP-	32	Output is disabled by the negative over-power limit
6	OV-	64	Output is disabled by a negative over-voltage protection
7	LIM+	128	Output is in positive voltage or positive current limit
8	LIM-	256	Output is in negative voltage or negative current limit
9	INH	512	Output is disabled by an external INHibit signal
10	UNR	1024	Output is unregulated
11	PROT	2048	Output is disabled by a watchdog timer protection
12	EDP	4096	Output is disabled by excessive output dynamic protection
13-15	not used	not used	0 is returned

The following table describes the Questionable2 assignments.

Bit	Bit Name	Decimal Value	Definition
0	not used	not used	0 is returned
1	IPK+	2	Output is in positive peak current limit
2	IPK-	4	Output is in negative peak current limit
3	CSF	8	A current sharing fault has occurred
4	PSP	16	Output is disabled by a primary/secondary protection
5	not used	not used	0 is returned
6	UV	64	An under-voltage protection has tripped
7	OCF	128	An internal over-current fault has occurred
8	LOV	256	An internal over-voltage fault has occurred
9	DOV	512	A DUT-applied over-voltage fault has occurred
10-15	not used	not used	0 is returned

### Standard Event Status Group

These registers are programmed by Common commands. The group consists of an Event and Enable register. The Standard Event event register latches events relating to communication status. It is a read-only register that is cleared when read. The Standard Event enable register functions similarly to the enable registers of the Operation and Questionable status groups. Refer to [Status Diagram](#).

The following table describes the Standard Event Status register bit assignments.

Bit	Bit Name	Decimal Value	Definition
0	Operation Complete	1	All commands before and including *OPC have been executed.
1	not used	not used	0 is returned
2	Query Error	4	The instrument tried to read an empty output buffer, a new command was received before a previous query was read, or both the input and output buffers are full.
3	Device- specific Error	8	A device-specific error, including a self-test error, calibration error or other device-specific error occurred. <a href="#">Error Messages</a>
4	Execution Error	16	An execution error occurred. <a href="#">Error Messages</a>
5	Command	32	A command syntax error occurred. <a href="#">Error Messages</a>
6	not used	not used	0 is returned
7	Power On	128	Power has been cycled since the last time the event register was read or cleared.

## Status Byte Register

This register summarizes the information from all other status groups as defined in the IEEE 488.2 Standard Digital Interface for Programmable Instrumentation. Refer to [Status Diagram](#).

The following table describes the Status Byte register bit assignments.

Bit	Bit Name	Decimal Value	Definition
0	not used	not used	0 is returned
1	not used	not used	0 is returned
2	Error Queue	4	One or more errors in the Error Queue. Use <code>SYSTem:ERRor?</code> to read and delete errors.
3	Questionable Status Summary	8	One or more bits are set in the Questionable Data Register. Bits must be enabled, see <code>STATus:QUEStionable:ENABLE</code> .
4	Message Available	16	Data is available in the instrument's output buffer.
5	Event Status Summary	32	One or more bits are set in the Standard Event Register. Bits must be enabled, see <code>*ESE</code> .
6	Master Status Summary	64	One or more bits are set in the Status Byte Register and may generate a Request for Service. Bits must be enabled, see <code>*SRE</code> .
7	Operation Status Summary	128	One or more bits are set in the Operation Status Register. Bits must be enabled, see <code>STATus:OPERation:ENABLE</code> .

### Master Status Summary and Request for Service Bits

MSS is a real-time (unlatched) summary of all Status Byte register bits that are enabled by the Service Request Enable register. MSS is set whenever the instrument has one or more reasons for requesting service. `*STB?` reads the MSS in bit position 6 of the response but does not clear any of the bits in the Status Byte register.

The RQS bit is a latched version of the MSS bit. Whenever the instrument requests service, it sets the SRQ interrupt line true and latches RQS into bit 6 of the Status Byte register. When the controller does a serial poll, RQS is cleared inside the register and returned in bit position 6 of the response. The remaining bits of the Status Byte register are not disturbed.

### Error and Output Queues

The Error Queue is a first-in, first-out (FIFO) data register that stores numerical and textual description of an error or event. Error messages are stored until they are read with `SYSTem:ERRor?` If the queue overflows, the last error/event in the queue is replaced with error -350,"Queue overflow".

The Output Queue is a first-in, first-out (FIFO) data register that stores messages until the controller reads them. Whenever the queue holds messages, it sets the MAV bit (4) of the Status Byte register.

### Status Diagram

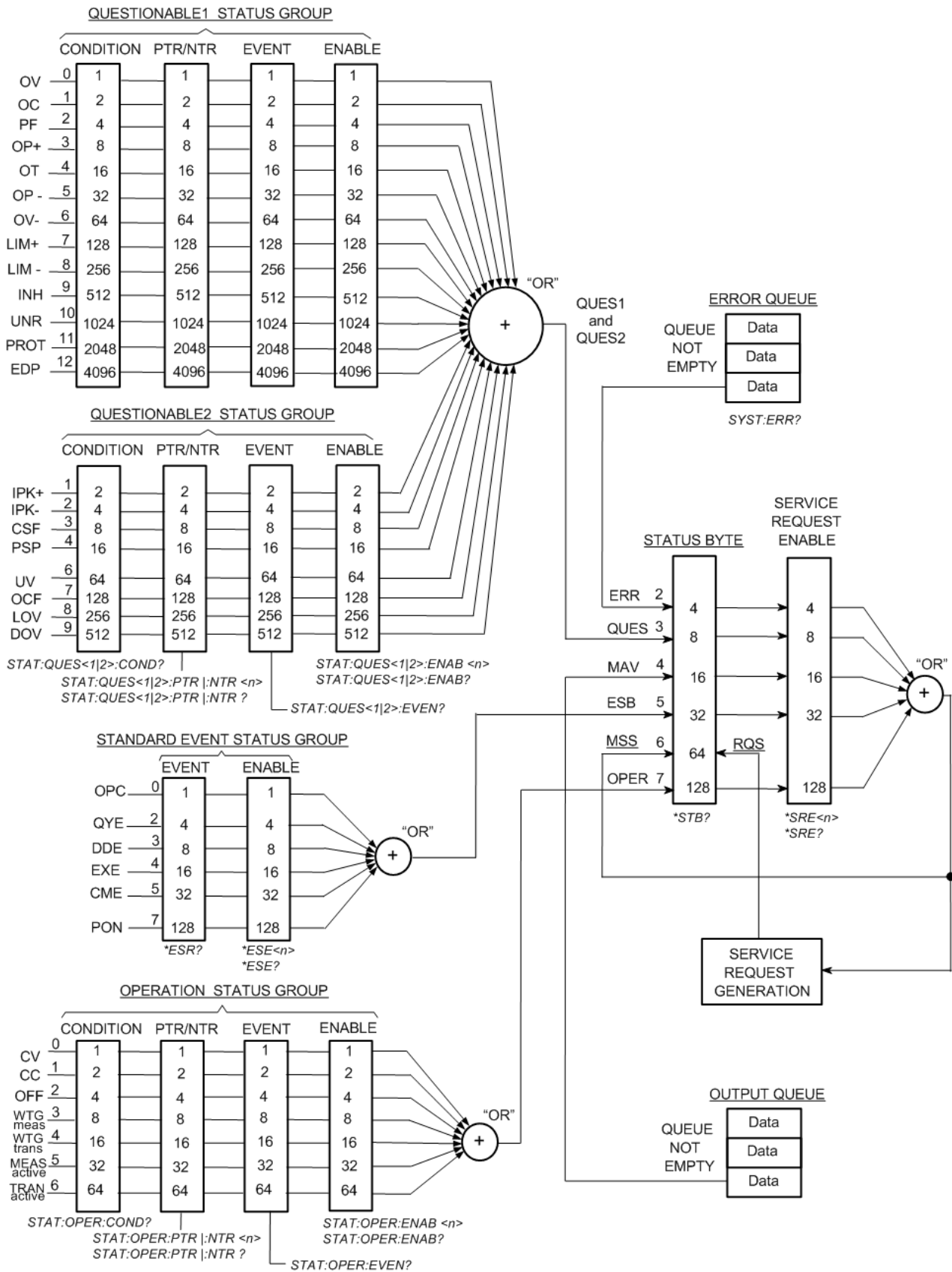



## Trigger Tutorial

The trigger system is a flexible, multi-purpose system that controls the operation of the instrument to suit a variety of user-defined applications. The trigger diagram below provides a graphical view of how the trigger sources and destinations are interconnected.

### Trigger Sources

### Trigger Destinations

### Trigger Diagram

## Trigger Sources

The following table describes the available trigger sources, which are shown on the left of the trigger diagram. Not all trigger sources can be applied to every trigger subsystem.

Source	Description
BUS	Enables GPIB device triggers, *TRG, or <GET> (Group Execute Trigger).
CURR1	Selects an output current level.
IMMediate	Triggers the transient as soon as it is INITiated.
PIN<n> EXtErnal	Selects a digital port pin configured as a trigger input. <n> specifies the pin number. EXtErnal selects ALL connector pins that have been configured as trigger inputs.
TRAN1	Selects the transient system as the trigger source.
TRIG:ACQ:IMM	Triggers the acquisition immediately.
TRIG:TRAN:IMM	Triggers the transient immediately.
VOLT1	Selects an output voltage level.

## Trigger Destinations

The following table describes the trigger system destinations.

Destination	Description
Digital pin	Sends the trigger to the designated digital pin. See <a href="#">Programming the Digital Port</a> .
Transient system	Sends the trigger to the designated transient (STEP, BOST, EOST)
Acquisition system	Sends the trigger to the acquisition system (TOUT)
Arb	Starts the arbitrary waveform. Note that the waveform must first be enabled and initiated. See <a href="#">Programming Output Transients</a> .

### Trigger Diagram

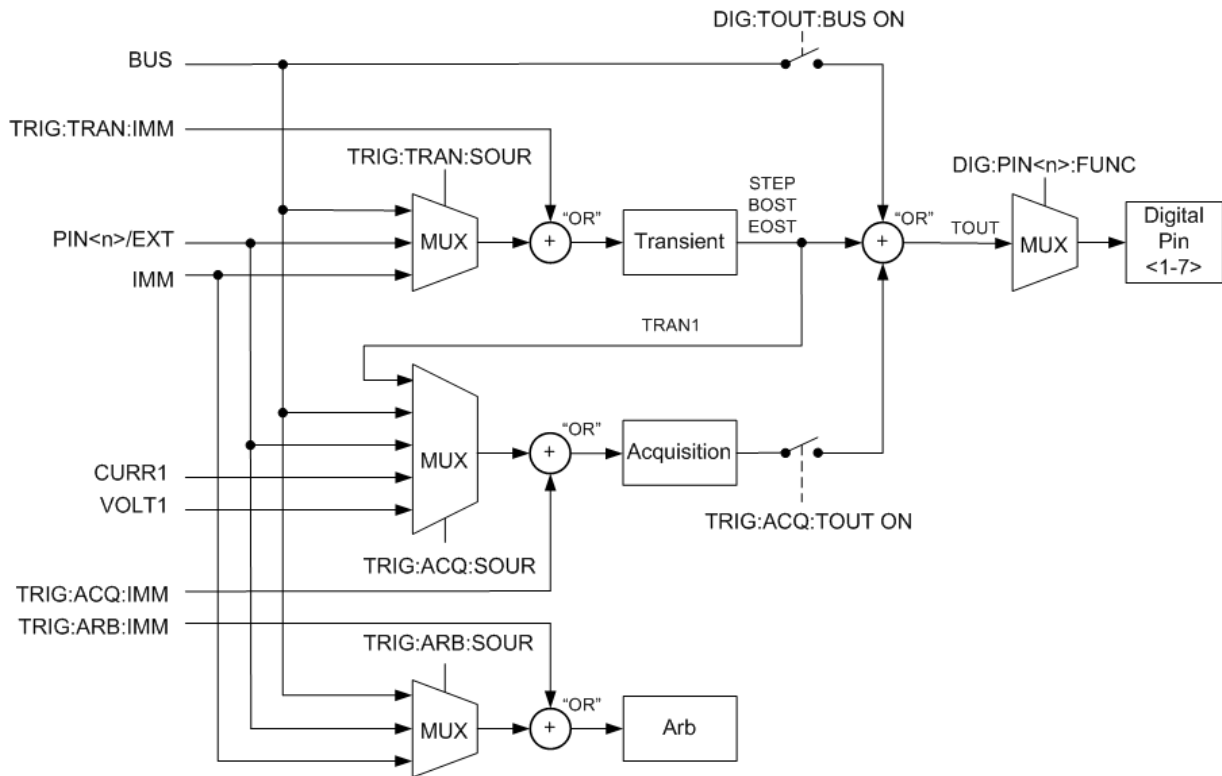

## Reset State (\*RST)

**NOTE**

The power-on/reset state may differ from that shown below if you have enabled power-on state recall mode from the **States** menu (see [Instrument State Storage](#)).

### Reset Settings

The following table shows the reset state. These parameters are reset to the indicated values at power-on or after \*RST.

SCPI Command	*RST Settings
ARB:COUNT	1
ARB:CURRENT:CDWell:DWELL	0.001
ARB:FUNCTION:SHAPE	CDW
ARB:FUNCTION:TYPE	VOLTage
ARB:TERMinate:LAST	OFF
ARB:VOLTage:CDWell:DWELL	0.001
CALibrate:STATE	OFF
CURRENT	0
CURRENT:LIMit	1.02% of rating
CURRENT:LIMit:NEGative	-1.02% of rating
CURRENT:MODE	FIXed
CURRENT:PROTECTION:DELay	20 ms
CURRENT:PROTECTION:DELay:START	SCHange
CURRENT:PROTECTION:STATE	OFF
CURRENT:SLEW	MAX
CURRENT:SLEW:MAXimum	ON
CURRENT:TRIGgered	0
DIGital:OUTPut:DATA	0
DIGital:TOUTput:BUS	OFF
DISPlay	ON
DIGital:OUTPut:DATA	0
DIGital:TOUTPut:BUS	OFF

## 5 SCPI Programming Reference

SCPI Command	*RST Settings
FORMat:DATA	ASCII
FORMat:BORDer	NORMal
FUNCTion	VOLTage
INITialize:CONTInuous:TRANSient	OFF
LIST:COUNT	1
LIST:CURRent	1 step set to 0
LIST:DWELL	1 step set to 0.001
LIST:STEP	AUTO
LIST:TERMinate:LAST	OFF
LIST:TOUTput:BOSTep	1 step set to OFF
LIST:TOUTput:EOSTep	1 step set to OFF
LIST:VOLTage	1 step set to 0.1% of rating
LXI:IDENtify	OFF
LXI:MDNS	ON
OUTPut	OFF
OUTPut:DELAy:FALL	0
OUTPut:DELAy:RISE	0
OUTPut:PROTEction:WDOG	OFF
OUTPut:PROTEction:WDOG:DELAy	60
RESistance	0
RESistance:STATe	0
SASimulator:BWIDth:RANGe	0
SASimulator:CURVe:IMP	0.8% of nominal rating
SASimulator:CURVe:ISC	1% of nominal rating
SASimulator:CURVe:VMP	0.8% of nominal rating
SASimulator:CURVe:VOC	1% of nominal rating
SASimulator:CURVe:SHAPE	SPACE
SASimulator:SCALE:CURRent	100%
SASimulator:SCALE:VOLTage	100%

SCPI Command	*RST Settings
SASimulator:MODE	FIXed
SENSe:CURRent:RANGe:AUTO	0
SENSe:FUNCTion:CURRent	1
SENSe:FUNCTion:VOLTage	1
SENSe:SWEep:NPLCycles	1
SENSe:SWEep:OFFSet:POINts	0
SENSe:SWEep:POINts	3255 (60 Hz); 3906 (50 Hz)
SENSe:SWEep:TINTerval	5.12E-6
SENSe:WINDow	RECTangular
STEP:TOUTput	OFF
TRIGger:ACQuire:CURRent	0
TRIGger:ACQuire:CURRent:SLOPe	POSitive
TRIGger:ACQuire:SOURce	BUS
TRIGger:ACQuire:TOUTput	OFF
TRIGger:ACQuire:VOLTage	0
TRIGger:ACQuire:VOLTage:SLOPe	POSitive
TRIGger:ARB:SOURce	BUS
TRIGger:TRANSient:SOURce	BUS
VOLTage	0.1% of rating
VOLTage:LIMit	1.02% of rating
VOLTage:LIMit:LOW:STATe	0
VOLTage:MODE	FIXed
VOLTage:PROTection	120% of rating
VOLTage:PROTection:LOW:STATe	0
VOLTage:RESistance	0
VOLTage:RESistance:STATe	OFF
VOLTage:SLEW	MAX
VOLTage:SLEW:MAXimum	ON
VOLTage:TRIGgered	0.1% of rating

## Non-Volatile Settings

The following table shows the as-shipped settings of the **non-volatile** parameters. These are not affected by power cycling or \*RST.

SCPI Command	As-shipped Settings
CALibrate:DATE	empty string
CALibrate:PASSword	0
DIGital:PIN<all>:FUNction	DINPut
DIGital:PIN<all>:POLarity	POSitive
DISPlay:VIEW	METER_VI
INSTrument:GROup:FUNction	NONE
INSTrument:GROup:SECOndary:ADDress	1
OUTPut:COUPle	OFF
OUTPut:COUPle:DOFFset	0
OUTPut:INHibit:MODE	OFF
OUTPut:PON:STATe	RST
OUTPut:RELAy:LOCK	OFF
SYSTem:LFRequency:MODE	AUTO
<b>Front Panel as-shipped settings</b>	
Front panel lockout password	Disabled
Firmware update password protected	Disabled
GPIB address	5
GPIB interface	Enabled
LAN interface	Enabled
USB interface	Enabled
Screen saver	Enabled
Screen saver delay	60 minutes
Wake on I/O	Enabled
<b>Interface as-shipped settings</b>	
Get GPIB Address	Automatic
Subnet mask	255.255.0.0

SCPI Command	As-shipped Settings
Default gateway	0.0.0.0
Host name	K-<modelName>-<last 5 digits of serial number>
mDNS service name	Keysight RP79xxx Regenerative Power System <serial number>
LAN service - VXI-11	Enabled
LAN service - Telnet	Enabled
LAN service - mDNS	Enabled
LAN service - Web server	Enabled
LAN service - sockets	Enabled
Web password	Blank (web password is disabled)

## SCPI Error Messages

The Keysight instrument returns error messages in accord with the SCPI standard.

- Up to 20 errors can be stored in each interface-specific error queue (one each for GPIB, USB, VXI-11, and Telnet/Sockets.) Errors appear in the error queue of the I/O session that caused the error.
- The front-panel ERR annunciator turns on when there are one or more errors in the error queue.
- A special global error queue holds all power-on and hardware-related errors (i.e. power-fail).
- Error retrieval is first-in-first-out (FIFO), and errors are cleared as you read them. Once you have read all interface-specific errors, the errors in the global error queue are retrieved. When you have read all errors from the error queue, the ERR annunciator turns off.
- If more than 30 errors have occurred, the last error stored in the queue (the most recent error) is replaced with -350, "Error queue overflow". No additional errors are stored until you remove errors from the queue. If no errors have occurred when you read the error queue, the instrument responds with +0, "No error".
- The front panel reports errors from all I/O sessions and the global error queue. To display the error queue on the front panel, press the Error key. Displaying the errors clears the error queue.
- Error conditions are also summarized in the Status Byte Register. See [Status Subsystem Introduction](#) for details
- The interface-specific error queues are cleared by power cycles and \*CLS. The error queue is not cleared by \*RST.
- **SCPI:** SYSTem:ERRor? *Read and clear one error from the queue*

Errors have the following format (the error string may contain up to 255 characters):

-113 "Undefined header".

### **Error Device-dependent Errors (these errors set Standard Event Status register bit #3)**

0 No error

This is the response to the ERR? query when there are no errors.

101 Calibration state is off

Calibration is not enabled. The instrument will not accept calibration commands.

102 Calibration password is incorrect

The calibration password is incorrect.

103 Calibration is inhibited by switch setting

Calibration mode is locked out by the calibration switch.

104 Bad sequence of calibration commands

Calibration commands have not been entered in the proper sequence.



## 105 Unexpected output current

The measured output current is outside the acceptable range.

## 106 Zero measurement out of range error

The “zero” measurement value is outside the acceptable range.

## 107 Programming cal constants out of range

The programmed calibration constant is outside the acceptable range.

## 108 Measurement cal constants out of range

The measurement calibration constant is outside the acceptable range.

## 109 Over voltage cal constants out of range

The over voltage calibration constant is outside the acceptable range.

## 110 Wrong V+I

The instrument was unable to set the correct voltage or current value.

## 114 Wrong status

An incorrect status function has been reported.

## 116 Locked out by internal switch setting

This function has been locked out by an internal switch.

## 117 Calibration error

A calibration error has occurred. Do not save calibration constants. Try re-calibrating the unit.

## 200 Hardware error channel &lt;1&gt;

A hardware error has occurred on the output.

## 201 Invalid configuration

An invalid parallel configuration is not allowed.

## 202 Selftest Fail

A selftest failure has occurred. See selftest failure list for details.

## 203 Compatibility function not implemented

The requested compatibility function is not available.

## 204 NVRAM checksum error

A checksum error has occurred in the instrument’s nonvolatile random access memory.

## 205 NVRAM full

The nonvolatile random access memory of the instrument is full.

## 5 SCPI Programming Reference

### 206 File not found

The internal calibration file or the internal channel attribute file was not found in NVRAM.

### 207 Cal file version error

The calibration file was written or read using old firmware. Firmware must be updated.

### 208 Running backup firmware

The instrument is presently running the backup (previous) version of the firmware.

### 210 Frame NVRAM error

A non-volatile RAM error has occurred in the instrument.

### 212 State file not loaded

A previously saved output state file has failed to load.

### 214 Line frequency error

A discrepancy has occurred between the line frequency and the line frequency setting.

### 215 Hardware failure

A hardware failure has occurred on the power supply

### 302 Option not installed

The option that is programmed by this command is not installed.

### 303 There is not a valid acquisition to fetch from

There is no valid data in the measurement buffer.

### 304 Volt and curr in incompatible transient modes

Voltage and current cannot be in Step and List mode at the same time.

### 305 A triggered value is on a different range

A triggered value is on a different range than the one that is presently set.

### 306 Too many list points

Too many list points have been specified.

### 307 List lengths are not equivalent

One or more lists are not the same length.

### 308 This setting cannot be changed while transient trigger is initiated

Setting cannot be changed while the instrument is waiting for or executing a trigger sequence.

### 309 Cannot initiate, voltage and current in fixed mode

Cannot initiate transient generator. Either the voltage or current function is set to Fixed mode.

310 The command is not supported by this model

This instrument does not have either the hardware or options required to support this command.

315 Settings conflict error

A data element could not be programmed because of the present instrument state.

316 Mass storage error

The mass storage memory has been exceeded.

317 Invalid format

An invalid data format was found in the command string.

320 Firmware update error

This may be due to the instrument hardware not being able to support the firmware version.

324 Inconsistent arb settings

The arb settings are inconsistent; most likely a mismatch in the arb lengths.

327 Initiated with no sense function enabled

A measurement has been initiated without specifying the measurement (sense) function.

328 Too many measurement points

Too many measurement points have been specified.

331 Illegal parameter value

The parameter value is out of range or does not exist.

332 Primary/secondary error

An error has occurred in the primary/secondary configuration.

334 Table number is invalid

The table number must be either 1 or 2.

335 VMP must be less than VOC; VMP setting is <setting>, VOC setting is <setting>

The VMP curve parameter is equal to or greater than the VOC parameter when shape = space

336 VMP must be less than  $0.99 * \text{VOC}$ ; VMP setting is <setting>, VOC setting is <setting>

The VMP curve parameter is equal to or greater than the VOC parameter when shape = terrestrial

337 IMP must be less than or equal to ISC

The IMP curve parameter is greater than the ISC parameter when shape = space

338 IMP must be less than  $0.99 * \text{ISC}$

The IMP curve parameter is greater than the ISC parameter when shape = terrestrial

339 VMP and/or IMP too small

The VMP and/or IMP are less than the allowable range of values

340 Computed VOC exceeds max voltage setting; computed VOC is <setting>, max voltage is <setting>

The computed (or true) VOC exceeds the maximum voltage of the instrument when shape = terrestrial

341 Recall state conflict

Frame AC line voltage does not match with recalled state.

### **Command Errors (these errors set Standard Event Status register bit #5)**

-100 Command error

Generic syntax error.

-101 Invalid character

An invalid character was found in the command string.

-102 Syntax error

Invalid syntax was found in the command string. Check for blank spaces.

-103 Invalid separator

An invalid separator was found in the command string. Check for proper use of , ; :

-104 Data type error

A different data type than the one allowed was found in the command string.

-105 GET not allowed

A group execute trigger is not allowed in a command string.

-108 Parameter not allowed

More parameters were received than were expected.

-109 Missing parameter

Fewer parameters were received than were expected.

-110 Command header error

An error was detected in the header.

-111 Header separator error

A character that was not a valid header separator was found in the command string.

-112 Program mnemonic too long

The header contains more than 12 characters.

-113 Undefined header

A command was received that was not valid for this instrument.

-114 Header suffix out of range

The value of the numeric suffix is not valid.

-120 Numeric data error

Generic numeric data error.

-121 Invalid character in number

An invalid character for the data type was found in the command string.

-123 Exponent too large

The magnitude of the exponent was larger than 32000.

-124 Too many digits

The mantissa of a numeric parameter contained more than 255 digits, excluding leading zeros.

-128 Numeric data not allowed

A numeric parameter was received but a character string was expected.

-130 Suffix error

Generic suffix error

-131 Invalid suffix

A suffix was incorrectly specified for a numeric parameter.

-134 Suffix too long

The suffix contains more than 12 characters.

-138 Suffix not allowed

A suffix is not supported for this command.

-140 Character data error

Generic character data error

-141 Invalid character data

Either the character data element contains an invalid character, or the element is not valid.

-144 Character data too long

The character data element contains more than 12 characters.

-148 Character data not allowed

A discrete parameter was received, but a string or numeric parameter was expected.

-150 String data error

Generic string data error

-151 Invalid string data

An invalid character string was received. Check that the string is enclosed in quotation marks.

-158 String data not allowed

A character string was received, but is not allowed for this command.

-160 Block data error

Generic block data error

-161 Invalid block data

The number of data bytes sent does not match the number of bytes specified in the header.

-168 Block data not allowed

Data was sent in arbitrary block format but is not allowed for this command.

**Execution Errors (these errors set Standard Event Status register bit #4)**

-200 Execution error

Generic syntax error

-220 Parameter error

A data element related error occurred.

-221 Settings conflict

A data element could not be executed because of the present instrument state.

-222 Data out of range

A data element could not be executed because the value was outside the valid range.

-223 Too much data

A data element was received that contains more data than the instrument can handle.

-224 Illegal parameter value

An exact value was expected but not received.

-225 Out of memory

The device has insufficient memory to perform the requested operation.

-226 Lists not same length

One or more lists are not the same length.

-230 Data corrupt or stale

Possible invalid data. A new reading was started but not completed.

-231 Data questionable

The measurement accuracy is suspect.

-232 Invalid format

The data format or structure is inappropriate.

-233 Invalid version

The version of the data format is incorrect to the instrument.

-240 Hardware error

The command could not be executed because of a hardware problem with the instrument.

-241 Hardware missing

The command could not be executed because of missing hardware, such as an option.

### **Query Errors (these errors set Standard Event Status register bit #2)**

-400 Query Error

Generic error query

-410 Query INTERRUPTED

A condition causing an interrupted query error occurred.

-420 Query UNTERMINATED

A condition causing an unterminated query error occurred.

-430 Query DEADLOCKED

A condition causing a deadlocked query error occurred.

-440 Query UNTERMINATED after indefinite response

A query was received in the same program message after a query indicating an indefinite response was executed.

## Compatibility Commands

This section describes the compatibility commands of the Keysight RP7900 Series Regenerative Power System - PV mode with earlier RPS models.

### **Keysight RP793xA, RP794xA, RP795xA, RP796xA**

[SOURce]

:RESistance

:STATe <Bool>

Enables or disables output resistance programming.

VOLTage

:BWIDth LOW|HIGH1

Sets the voltage compensation (RP795xA, RP796xA)



# 6

## Verification and Calibration

**Test Equipment and Setups**

**Performance Verification**

**Instrument Calibration**

**Test Record Forms**

## Test Equipment and Setups

### Test Equipment

#### Measurement Setups

### Test Equipment

The test equipment recommended for the performance verification and adjustment procedures is listed below. If the exact instrument is not available, substitute calibration standards of equivalent accuracy.

Instrument	Requirements	Recommended Model	Use <sup>1</sup>
Digital Multimeter	Resolution: 10 nV @ 1V; Readout: 8 1/2 digits Accuracy: 20 ppm	Keysight 3458A	V, C
Current Shunt <sup>2</sup>	50 A (0.05 $\Omega$ ) 0.01%, TC=4ppm/ $\Omega$ C 100 A (0.01 $\Omega$ ) 0.01%, TC=4ppm/ $\Omega$ C	Guildline 9230A/50 Guildline 9230A/100	V, C
Electronic load/source <sup>2</sup>	1000 V, 90 A, 30 kW 2000 V, 30 A, 30 kW 1500 V, 60 A, 30 kW	Keysight RP7982A Keysight RP7983A Keysight RP7984A	V
GPIB controller	Full GPIB capabilities	Keysight 82350B or equivalent	V, C
Oscilloscope	Sensitivity: 1 mV Bandwidth: 20 MHz Probe: 100:1 with RF tip	Keysight DSO6054A or equivalent  Keysight 10076C	V
RMS Voltmeter	Bandwidth: 10 MHz	Rhode and Schwartz URE3, Keysight 3458A, or equivalent	V
Voltage divider	5kV:5V (1000:1) Accuracy <0.01%	Ohms-Lab KVVB-5-5 or equivalent	V, C
Differential Amplifier	Bandwidth: 20 MHz	LeCroy 1855A, DA1850A, or equivalent	V
Differential Probe	100:1	LeCroy DXC100A, or equivalent	V
Terminations	50 $\Omega$ BNC termination		V

<sup>1</sup>V=Verification; C=Calibration

<sup>2</sup>Dependent on rating of model being tested

## Measurement Setups

### Voltmeter

To ensure that the values read by the voltmeter during both the verification procedure and the calibration procedure are not affected by the instantaneous measurement of the ac peaks of the output current ripple, make several dc measurements and average them.

If you are using a Keysight 3458A DMM, you can set up the voltmeter to do this automatically. From the instrument's front panel, program 100 power line cycles per measurement. Press NPLC 100 ENTER. Additionally, turn on auto-calibration (ACAL) and the autorange function (ARANGE).

### Current Shunt

The 4-terminal current shunt is used to eliminate output current measurement error caused by voltage drops in the load leads and connections. It has special current-monitoring terminals inside the load connection terminals. Connect the voltmeter directly to these current-monitoring terminals.

### Electronic Load

Many of the test procedures require the use of a variable load capable of dissipating the required power. For all tests, a Keysight RP79xxA unit can be used as a load. The RP79xxA load unit is considerably easier to use than load resistors.

Fixed load resistors may be used in place of a variable load, with minor changes to the test procedures. To avoid contact with any high voltages during operation, use switches to connect, disconnect, or short the load resistors.

Also, if computer controlled test setups are used, the relatively slow (compared to computers and system voltmeters) settling times and slew rates of the unit under test may have to be taken into account. "Wait" statements can be used in the test program if the test system is faster than the unit under test.

## Performance Verification

### Introduction

### Verification Setups

### Test Considerations

### Voltage Programming and Readback Accuracy

### Constant Voltage Load Effect

### Constant Voltage Ripple and Noise

### Transient Recovery Time

### Current Programming and Readback Accuracy

### Constant Current Load Effect

### Current Sink Capability Verification

### Test Record Forms

## Introduction

### WARNING

**SHOCK HAZARD, LETHAL VOLTAGES** - Many models generate output voltages up to 2,000 VDC! Ensure that all instrument connections, load wiring, load and sense connections are insulated using high-voltage wire. Always attach the safety cover provided, so that no accidental contact with lethal voltages can occur.

---

Use the performance verification tests to verify that the unit under test (UUT) is operating normally and meets its published specifications. You can perform two different levels of performance verification tests:

- **Performance Verification Tests** An extensive set of tests that are recommended as an acceptance test when you first receive the instrument or after performing adjustments.
- **Calibration-Tests** These tests verify that the instrument is operating within its calibration limits.

The performance verification tests are recommended as acceptance tests when you first receive the instrument. The acceptance test results should be compared against the instrument specifications.

Keysight Technologies recommends that you repeat the performance verification tests at every calibration interval. This ensures that the instrument will remain within specifications for the next calibration interval and provides the best long-term stability. Performance data measured using this method may be used to extend future calibration intervals.

Perform the verification tests before calibrating your power supply. If the instrument passes the verification tests, the unit is operating within its calibration limits and does not need to be re-calibrated.

If the instrument fails any of the tests or if abnormal test results are obtained, try calibrating the unit. If calibration is unsuccessful, return the unit to a Keysight Technologies Service Center.

Refer to the **Recommended Test Equipment and Setups** section for a list of the equipment and test setups required for verification. Also refer to the **Measurement Setups** section for information about connecting the voltmeter, current shunt, and load.

**WARNING**

**SHOCK HAZARD, LETHAL VOLTAGES** - Many models generate output voltages up to 2,000 VDC! Ensure that all instrument connections, load wiring, load and sense connections are insulated using high-voltage wire. Always attach the safety cover provided, so that no accidental contact with lethal voltages can occur.

Always turn off the output when connecting or disconnecting any equipment on the sense or output terminals of the unit.

---

**CAUTION**

**Equipment Damage** It is recommended to set the over-voltage protection function of the instrument slightly higher than its operating point during the verification procedure. This will prevent damage to any external equipment (electronic load, differential amplifier) that may occur if the output voltage is accidentally programmed higher than the prescribed voltage setting.

---

**NOTE**

Turn the unit off or send a Reset command after completing the verification procedure to return all instrument settings to their default values.

---

### Verification Setups

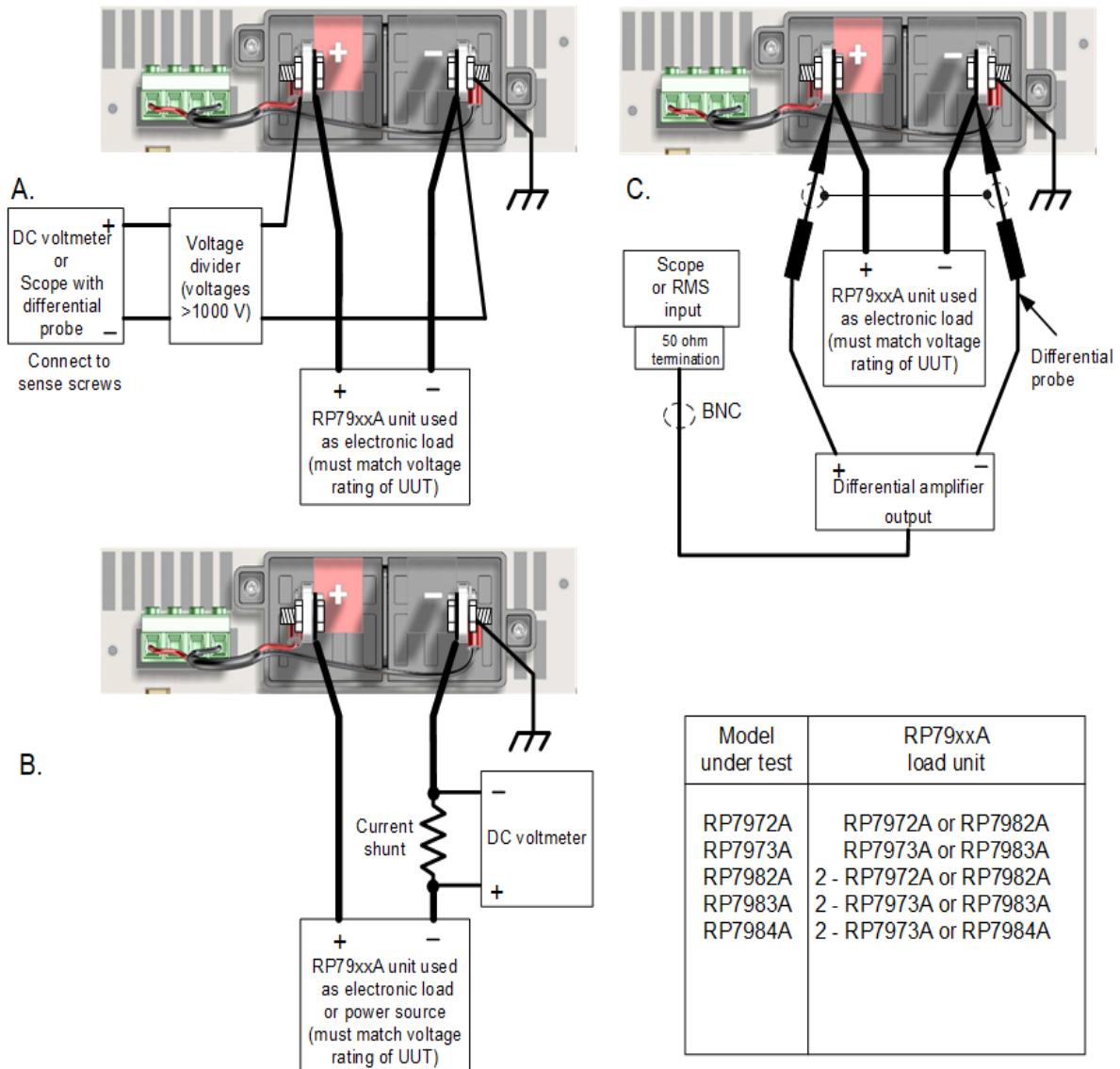

### Test Considerations

For optimum performance, all verification and calibration procedures should comply with the following:

- Ambient temperature is stable, within 23 °C ±2°C.
- Ambient relative humidity is less than 80%.
- 30 minute warm-up period before verification or adjustment.
- Cables as short as possible, twisted or shielded to reduce noise.

## Verification Procedure

### Voltage Programming and Readback Accuracy

This test verifies that the voltage programming and measurement functions are within specifications.

Step 1. Turn off the unit under test. Only connect the DMM to the sense screws (see **Test Setup A**). Do **NOT** connect the RP79xxA load unit.

Step 2. Turn on the unit under test and program the instrument settings as described in the test record form under “Voltage Programming & Readback, Min Voltage”. Turn the output on. The output status should be “CV”, with the output current close to zero.

Step 3. Record the output voltage reading from the DMM ( $V_{out}$ ) and the voltage measured by the instrument over the interface. The readings should be within the limits specified in the test record form for the appropriate model under “Voltage Programming & Readback, Minimum Voltage”.

**WARNING** The next step applies the full output voltage of the unit under test to the output.

---

Step 4. Program the instrument settings as described in the test record form under “Voltage Programming & Readback, High Voltage”.

Step 5. Record the output voltage reading from the DMM ( $V_{out}$ ) and the voltage measured by the instrument over the interface. The readings should be within the limits specified in the test record form for the appropriate model under “Voltage Programming & Readback, High Voltage”.

### Constant Voltage Load Effect

This test measures the change in voltage resulting from a change in current from full load to no load.

Step 1. Turn off the unit under test. Connect the DMM to the sense screws and connect the RP79xxA load unit (see **Test Setup A**).

Step 2. Turn on the unit under test and program the instrument settings as described in the test record form under “CV Load Effect”. Turn the output on.

Step 3. Set the RP79xxA load for the rated output current of the unit under test as described in the test record form under “CV Load Effect”. Turn the output on. The output status of the unit under test should be “CV”. If it isn’t, adjust the load so that the output current drops slightly.

Step 4. Record the output voltage reading from the DMM.

Step 5. Turn off the output of the RP79xxA load. Record the voltage reading from the DMM again. The difference between the DMM readings in steps 4 and 5 is the load effect, which should not exceed the value listed in the test record form for the appropriate model under “CV Load Effect”.

### Constant Voltage Ripple and Noise

Periodic and random deviations in the output combine to produce a residual ac voltage superimposed on the dc output voltage. This residual voltage is specified as the rms or peak-to-peak noise in the indicated frequency range (refer to the **Specifications** section).

## 6 Verification and Calibration

Step 1. Turn off the unit under test. Connect the RP79xxA load unit, differential amplifier, and an oscilloscope (ac coupled) to the output (see **Test Setup C**).

Step 2. As shown in the diagram, use the differential probes to connect the differential amplifier to the + and - output terminals. Connect the shields of the two probes together. Connect the output of the differential amplifier to the oscilloscope with a 50  $\Omega$  termination at the input of the oscilloscope.

Step 3. Set the probe to 1:100 and set the inputs of the differential amplifier to match the probe setting. Set the inputs to ac coupling. Set the input resistance to 1 M $\Omega$ . Set the oscilloscope's time base to 5 ms/div, and set the vertical scale to the maximum sensitivity without clipping the waveform. Turn the bandwidth limit on (usually 20 MHz), and set the sampling mode to peak detect.

Step 4. Turn on the unit under test and program the instrument settings as described in the in the test record form under "CV Ripple and Noise". Turn the output on. Program the RP79xxA load as shown in the test record card and turn the output on. Let the oscilloscope run for a few seconds to generate enough measurement points. On the Keysight Infiniium scope, the maximum peak-to-peak voltage measurement is indicated at the bottom of the screen on the right side. The result should not exceed the peak-to-peak limits in the test record form under "CV Ripple and Noise, peak-to-peak".

### NOTE

If the measurement contains any question marks, clear the measurement and try again. This means that some of the scope data received was questionable.

---

Step 5. Disconnect the oscilloscope and connect an rms voltmeter in its place. Do not disconnect the 50 ohm termination. Divide the reading of the rms voltmeter according to the differential amplifier setting. The result should not exceed the rms limits in the test record form for the appropriate model under "CV Ripple and Noise, rms".

## Transient Recovery Time

This test measures the time for the output voltage to recover to within the specified value following a 50% change in the instrument's rated load current.

Step 1. Turn off the unit under test. Connect an oscilloscope with the specified probe across the sense terminals (see **Test Setup A**). Connect the RP79xxA load unit to the output terminals.

Step 2. Turn on the unit under test and program the instrument settings as described in the test record form under "Transient Response".

Step 3. Set the RP79xxA load's list generator to generate a 100 Hz current waveform with a duty cycle of 50%. If using 2 - RP797xA units as a load, set one unit in CC to pull a constant current, and use the second unit to create the current step. Use the following commands to program the list:

FUNC:CURR - specifies current priority

VOLT:LIM MAX - specifies the voltage limit

DIAG:OF:CURR:BWID:LEV 3 - specifies bandwidth level 3, which generates a 40  $\mu$ s risetime step in the load list

CURR:MODE LIST - specifies current priority

LIST:CURR <low\_value>,<high\_value> - refer to test record card for low and high current values

LIST:DWEL 0.005, 0.005 - specifies a 100 Hz current waveform with a 50% duty cycle

LIST:COUN INF - sets the list count to infinity

INIT:TRAN - initiates the transient system

TRIG:TRAN - triggers the transient system

OUTP:ON - turns on the load



Step 4. Adjust the oscilloscope for a waveform similar to that shown in the following figure.

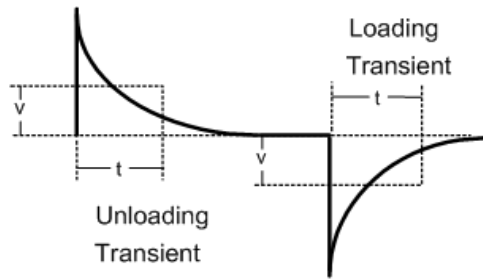

Step 5. The output voltage should return to within the specified voltage at the specified time after the load change. Check both loading and unloading transients by triggering on the positive and negative slope. Record the voltage at time “t” in the performance test record form under “Transient Response”.

### Current Programming and Readback Accuracy

This test verifies that the current programming and measurement functions are within specifications.

Step 1. Turn off the unit under test. Connect the current shunt directly across the output terminals. Connect the DMM directly across the current shunt (see **Test Setup B**). Note that the RP79xxA load is not used in this portion of the test.

Step 2. Turn on the unit under test and program the instrument settings as described in the test record form under “Current Programming & Readback, Min Current”. The output status should be “CC”, with the output voltage close to zero. Wait 5 minutes for the temperature to settle.

Step 3. Divide the voltage drop (DMM reading) across the current shunt by the shunt resistance to convert to amps and record this value. ( $I_{out}$ ). Also, record the current measured by the instrument over the interface. The readings should be within the limits specified in the test record form under “Current Programming & Readback, Minimum Current”.

Step 4. Program the instrument settings as described in the test record form under “Current Programming & Readback, High Current”. Wait 5 minutes for the temperature to settle.

Step 5. Divide the voltage drop (DMM reading) across the current shunt by the shunt resistance to convert to amps and record this value. ( $I_{out}$ ). Also, record the current reading measured by the instrument over the interface. The readings should be within the limits specified in the test record form under “Current Programming & Readback, High Current”.

### Constant Current Load Effect

This test measures the change in current resulting from a change in voltage from a short to full scale.

Step 1. Turn off the unit under test. Connect the current shunt directly across the output terminals. Connect the DMM directly across the current shunt (see **Test Setup B**). Note that the RP79xxA load is not used in this portion of the test.

Step 2. Turn on the unit under test and program the instrument settings as described in the test record form under “CC Load Effect”. The output status should be “CC”, with the output voltage be close to zero. Wait 5 minutes for the temperature to settle.

## 6 Verification and Calibration

Step 3. Divide the voltage drop (DMM reading) across the current shunt by the shunt resistance to convert to amps and record this value.

Step 4. Turn off the unit under test and connect the RP79xxA load unit between the current shunt and the output terminals (see **Test Setup B**).

Step 5. Set the RP79xxA load for voltage priority mode and program its voltage and current limit as described in the test record under “CC Load Effect”. Enable the load's output.

Step 6. Program the unit under test to the settings as described in the test record under “CC Load Effect”. Enable the output of the unit under test. The output status should be “CC”. If it isn't, adjust the load so that the output voltage drops slightly.

Step 7. Divide the voltage drop (DMM reading) across the current shunt by the shunt resistance to convert to amps and record this value. The difference in this current reading and the reading in step 3 is the load effect, which should not exceed the value listed in the test record for the appropriate model under “CC Load Effect”.

### Current Sink Capability Verification

This test checks the ability of the power supply to sink up to 100% of its rated output current.

Step 1. Turn off the unit under test and connect the RP79xxA unit as an external source to the + and - output terminals (see **Test Setup B**). Make sure that the voltage rating of the RP79xxA external source is at least half of the voltage rating of the unit under test.

Step 2. Set the RP79xxA external source for voltage priority mode and program it to the voltage as described in the test record under “100% of Current Rating (Isink)”.

Step 3. Turn on the unit under test. Set the operating mode to current priority. Program the instrument settings as described in the test record under “100% of Current Rating (Isink)”.

Step 4. Check the front panel display of the unit under test and verify that it is sinking 100% of its rated current and has a -CL status. Divide the voltage drop (DMM reading) across the current shunt by the shunt resistance to convert to amps and record this value. The readings should be within the limits specified in the test record form under “Current Sink Tests”.

# Instrument Calibration

## Introduction

### Calibration Interval

### Calibration Setups

### Test Considerations

### Enter Calibration Mode

### Voltage Programming and Measurement Calibration

### Current Temperature Coefficient Calibration

### Current Programming and Measurement Calibration

### Enter a Calibration Date

### Save Calibration and Log Out

## Introduction

### **WARNING**

SHOCK HAZARD, LETHAL VOLTAGES - Many models generate output voltages up to 2,000 VDC! Ensure that all instrument connections, load wiring, load and sense connections are insulated using high-voltage wire. Always attach the safety cover provided, so that no accidental contact with lethal voltages can occur.

---

The instrument features closed-case electronic calibration; no internal mechanical adjustments are required. The instrument calculates correction factors based on input reference values that you set and stores correction factors in non-volatile memory until the next calibration adjustment is performed. This EEPROM calibration memory is not changed by cycling power or \*RST.

Refer to the [Recommended Test Equipment and Setups](#) section for a list of the equipment and test setups required for calibration. Also refer to the [Measurement Setups](#) section for information about connecting the voltmeter, current shunt, and load. Additional information about calibration follows.

- The correct password is required to enter the Admin menu, which contains the calibration function. The password is pre-set to 0 (zero). You can change the password once calibration mode is entered to prevent unauthorized access to the calibration mode. Refer to [Password Protection](#) for more information.
- When calibrating the unit using SCPI commands, most steps involve sending a \*OPC? query to synchronize with the power supply's command completion before proceeding. The response from the instrument must be read each time \*OPC? is given. In some steps, it may take up to 30 seconds for \*OPC? to respond.
- Once started, you must complete each calibration section in its entirety. As each calibration section is completed, the instrument calculates new calibration constants and begins using them. These constants are not saved in nonvolatile memory until a SAVE command is explicitly given.

## 6 Verification and Calibration

- Exit the calibration mode either by logging out of the Admin menu or by sending CAL:STAT OFF. Note that any calibration section that was calibrated but not saved will revert to its previous calibration constants.

### Calibration Interval

#### One Year Calibration Interval

The instrument should be calibrated on a regular interval determined by the accuracy requirements of your application. A **one-year** interval is adequate for most applications. Accuracy specifications are warranted only if adjustment is made at regular calibration intervals. Published accuracy specifications are not warranted beyond the one-year calibration interval.

#### Three Year Calibration Interval

Voltage and current programming and measurement accuracy specifications can be extended to a three-year period calibration interval by multiplying (or increasing) the one-year calibration accuracy specifications shown in the verification Test Record Forms by a factor of three.

### Calibration Setups

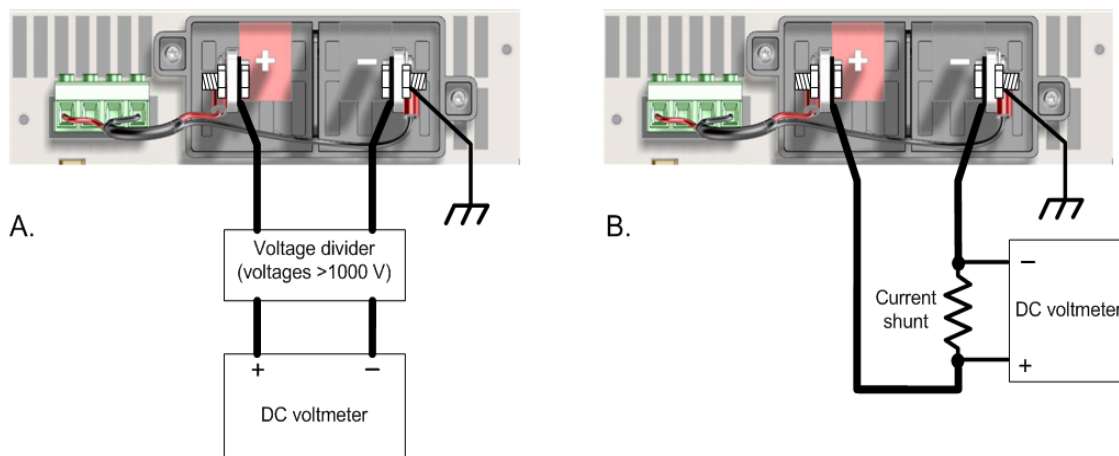

### Test Considerations

For optimum performance, all verification and calibration procedures should comply with the following:

- Ambient temperature is stable, within  $23\text{ }^{\circ}\text{C} \pm 2^{\circ}\text{C}$ .
- Ambient relative humidity is less than 80%.
- 30 minute warm-up period before verification or adjustment.
- Cables as short as possible, twisted or shielded to reduce noise.

## Calibration Procedure

### Enter Calibration Mode

Front Panel Menu Reference	SCPI Command
Select <b>System\Admin&gt;Login</b> . Enter your password in the Password field. Then press <b>Select</b> .	<b>CAL:STAT ON &lt;password&gt;</b>

### Voltage Programming and Measurement Calibration

Step 1. Connect the voltage input of the Keysight 3458A DMM to the output (see **Cal Setup A**).

Step 2. Select the voltage programming and measurement calibration.

Front Panel Menu Reference	SCPI Command
Select <b>System\Admin\Cal\Vprog</b> . Check that the voltmeter is connected and select Next.	Specify the full-scale voltage range. Full scale ranges vary by model. This selects the 1000 V range: <b>CAL:VOLT 1000</b>

Step 3. Select the first voltage calibration point. Measure the output voltage with the DMM and enter the data.

Front Panel Menu Reference	SCPI Command
Display shows: "Enter P1 measured data". Enter the data from the external DMM. Press Enter when done.	<b>CAL:LEV P1</b> <b>*OPC?</b> <b>CAL:DATA &lt;data&gt;</b>

#### **WARNING**

The next step applies 70% of the rated output voltage of the unit under test to the output.

Step 4. Select the second voltage calibration point. Wait 5 minutes for the temperature to settle. Measure the output voltage with the DMM and enter the data.

Front Panel Menu Reference	SCPI Command
Display shows: "Enter P2 measured data". Enter the data from the external DMM. Press Enter when done. Press Back to finish.	<b>CAL:LEV P2</b> <b>*OPC?</b> <b>CAL:DATA &lt;data&gt;</b>

## Current Temperature Coefficient Calibration

**NOTE**

The temperature coefficient calibration procedure must be performed **Before** any other current calibration procedures.

Step 1. Connect a precision shunt resistor to the output. The shunt resistor should be able to measure the output's **full-scale** current (see **Cal Setup B**). Connect the Keysight 3458A DMM across the shunt resistor.

Step 2. Select the temperature coefficient calibration.

Front Panel Menu Reference	SCPI Command
Select <b>System\Admin\Cal\Misc\CurrTC</b> .	<b>CAL:CURR:TC</b>
Check that the shunt is connected and select Next.	

Step 3. Select the first current calibration point. Wait 5 minutes for the temperature to settle. Calculate the shunt current ( $I=V/R$ ) and enter the data.

Front Panel Menu Reference	SCPI Command
Display shows: "Enter P1 measured data". This should be about 50% of the full-scale current rating. Press Enter when done.	<b>CAL:LEV P1</b> <b>*OPC?</b> <b>CAL:DATA &lt;data&gt;</b>

Step 4. Select the second current calibration point. Wait 5 minutes for the temperature to settle. Calculate the shunt current ( $I=V/R$ ) and enter the data.

Front Panel Menu Reference	SCPI Command
Display shows: "Enter P2 measured data". Enter the data from the external DMM. This should be about 80% of the full-scale current rating. Press Enter when done.	<b>CAL:LEV P2</b> <b>*OPC?</b> <b>CAL:DATA &lt;data&gt;</b>

Step 5. Select the third current calibration point. Wait 5 minutes for the temperature to settle. Calculate the shunt current ( $I=V/R$ ) and enter the data.

Front Panel Menu Reference	SCPI Command
Display shows: "Enter P3 measured data". Enter the data from the external DMM. This should be about 100% of the full-scale current rating. Press Enter when done. Press Back to finish.	<b>CAL:LEV P3</b> <b>*OPC?</b> <b>CAL:DATA &lt;data&gt;</b>

## Current Programming and Measurement Calibration

Step 1. Disconnect all equipment from the output terminals.

Step 2. Select the current programming and measurement calibration.

Front Panel Menu Reference	SCPI Command
Select <b>System\Admin\Cal\Curr\Iprog.</b> Check that nothing is connected to the output and select Next.	Specify the full-scale current range. Full scale ranges vary by model. This selects the 30 A range: <b>CAL:CURR 30</b>

Step 3. Wait 5 minutes for the temperature to settle. Select the first current calibration point.

Front Panel Menu Reference	SCPI Command
Wait 5 minutes, then select Next again.	<b>CAL:LEV P1</b> <b>*OPC?</b>

Step 4. Connect a precision shunt resistor to the output. The shunt resistor should be able to measure at least 70% of the output's full-scale current (see **Cal Setup B**). Connect the Keysight 3458A DMM across the shunt resistor.

Front Panel Menu Reference	SCPI Command
Check that the shunt is connected and select Next.	Not applicable

Step 5. Select the second current calibration point. Wait 5 minutes for the temperature to settle. Calculate the shunt current ( $I=V/R$ ) and enter the data.

Front Panel Menu Reference	SCPI Command
Display shows: "Enter P2 measured data". Enter the data from the external DMM. This should be about 70% of the full-scale current rating. Press Enter when done. Press Back to finish.	<b>CAL:LEV P2</b> <b>*OPC?</b> <b>CAL:DATA &lt;data&gt;</b>

### Enter a Calibration Date

Front Panel Menu Reference	SCPI Command
Select <b>System\Admin\Cal\Date.</b> Enter the calibration date in the Date field. If desired, you can enter alphanumeric data in this field.	<b>CAL:DATE "&lt;date&gt;"</b>

### Save Calibration and Log Out

Front Panel Menu Reference	SCPI Command
Select <b>System\Admin\Cal\Save.</b> Select Save to save all calibration data.	To save calibration data: <b>CAL:SAVE</b>
Select <b>System\Admin\Logout</b> to exit calibration mode.	To exit calibration mode: <b>CAL:STAT OFF</b>

## Test Record Forms - RPS family

### Keysight RP7972A

RP7972A Test Record	Report Number _____	Date _____	
Test Description	Min. Specs	Results	Max. Specs
Voltage Programming & Readback			
Minimum voltage (Vout):	0.9246	_____	1.0754
Voltage measured over interface:	Vout - 0.0754	_____	Vout + 0.0754
High voltage (Vout):	999.525	_____	1000.475
Voltage measured over interface:	Vout - 0.475	_____	Vout + 0.475
CV Load Effect:	- 0.05	_____	+ 0.05
CV Ripple and Noise			
peak-to-peak:	N/A	_____	1.5
rms:	N/A	_____	0.2
Transient response @ 300 μs:	- 10	_____	+ 10
Current Programming & Readback			
Minimum current (Iout):	- 0.006	_____	0.006
Current measured over interface:	Iout - 0.006	_____	Iout + 0.006
High current (Iout):	59.976	_____	60.024
Current measured over interface:	Iout - 0.024	_____	Iout + 0.024
CC Load Effect:	- 0.008	_____	+ 0.008
Current Sink Tests			
100% of current rating:	- 60.024	_____	- 59.974

	RP7972A UUT Settings	RP7972A or RP7982A Load Settings
Voltage Programming & Readback Min:	Voltage priority: 1 V, 5 A	not used
Voltage Programming & Readback High:	Voltage priority: 1000 V, 5 A	not used
CV Load Effect:	Voltage priority: 333 V, 61 A	Current priority: 335 V, -60 A
CV Ripple and Noise*:	Voltage priority: 333 V, 61 A	Current priority: 335 V, -60 A
Transient Response:	Voltage priority: 333 V, 61 A, Comp 0	Current priority: 550 V, -24 A to -54 A, slew=max, Comp 3**
Current Programming & Readback Min:	Current priority: 335 V, 0 A	Voltage priority: 333 V, 0 A
Current Programming & Readback High:	Current priority: 335 V, 60 A	Voltage priority: 333 V, -61 A
CC Load Effect:	Current priority: 1010 V, 20 A	Voltage priority: 1000 V, -20.5 A
100% of Current Rating (Isink):	Current priority: 335 V, -60 A	Voltage priority: 333 V, 61 A

\* **CAUTION** Equipment damage. The LeCroy DXC100A probe is limited to 500 V. Only connect for CV Ripple and Noise test.

\*\* Current comp 3 generates a 40 μs risetime step in the load list, which is required for the transient response test.



## Keysight RP7973A

RP7973A Test Record	Report Number _____	Date _____	
Test Description	Min. Specs	Results	Max. Specs
Voltage Programming & Readback			
Minimum voltage (Vout):	1.8492	_____	2.1508
Voltage measured over interface:	Vout - 0.1508	_____	Vout + 0.1508
High voltage (Vout):	1999.05	_____	2000.95
Voltage measured over interface:	Vout - 0.95	_____	Vout + 0.95
CV Load Effect:	- 0.1	_____	+ 0.1
CV Ripple and Noise			
peak-to-peak:	N/A	_____	3
rms:	N/A	_____	0.4
Transient response @ 300 $\mu$ s:	- 20	_____	+ 20
Current Programming & Readback			
Minimum current (Iout):	- 0.003	_____	0.003
Current measured over interface:	Iout - 0.003	_____	Iout + 0.003
High current (Iout):	29.988	_____	30.012
Current measured over interface:	Iout - 0.012	_____	Iout + 0.012
CC Load Effect:	- 0.004	_____	+ 0.004
Current Sink Tests			
100% of current rating:	- 30.012	_____	- 29.988

	RP7973A UUT Settings	RP7973A or RP7983A Load Settings
Voltage Programming & Readback Min:	Voltage priority: 2 V, 5 A	not used
Voltage Programming & Readback High:	Voltage priority: 2000 V, 5 A	not used
CV Load Effect:	Voltage priority: 666 V, 30.5 A	Current priority: 670 V, -30 A
CV Ripple and Noise*:	Voltage priority: 500 V, 30.5 A	Current priority: 520 V, -30 A
Transient Response:	Voltage priority: 666 V, 30.5 A, Comp 0	Current priority: 1100 V, -12 A to -27 A, slew=max, Comp 3**
Current Programming & Readback Min:	Current priority: 670 V, 0 A	Voltage priority: 666 V, 0 A
Current Programming & Readback High:	Current priority: 670 V, 30 A	Voltage priority: 666 V, -30.5 A
CC Load Effect:	Current priority: 2040 V, 10 A	Voltage priority: 2000 V, -10.2 A
100% of Current Rating (Isink):	Current priority: 670 V, -30 A	Voltage priority: 666 V, 30.5 A

\* **CAUTION** Equipment damage. The LeCroy DXC100A probe is limited to 500 V. Only connect for CV Ripple and Noise test.

\*\* Current comp 3 generates a 40  $\mu$ s risetime step in the load list, which is required for the transient response test.

## Keysight RP7982A

**NOTE**

Verification requires the use of 3-phase 380/480 Vac mains input connections.

RP7982A Test Record		Report Number _____	Date _____
Test Description	Min. Specs	Results	Max. Specs
Voltage Programming & Readback			
Minimum voltage (Vout):	0.9247	_____	1.0753
Voltage measured over interface:	Vout - 0.0753	_____	Vout + 0.0753
High voltage (Vout):	999.625	_____	1000.375
Voltage measured over interface:	Vout - 0.375	_____	Vout + 0.375
CV Load Effect:	- 0.05	_____	+ 0.05
CV Ripple and Noise			
peak-to-peak:	N/A	_____	1.5
rms:	N/A	_____	0.2
Transient response @ 300 μs:	- 10	_____	+ 10
Current Programming & Readback			
Minimum current (Iout):	- 0.009	_____	0.009
Current measured over interface:	Iout - 0.009	_____	Iout + 0.009
High current (Iout):	89.964	_____	90.036
Current measured over interface:	Iout - 0.036	_____	Iout + 0.036
CC Load Effect:	- 0.012	_____	+ 0.012
Current Sink Tests			
100% of current rating:	- 90.03	_____	- 89.97

	RP7982A UUT Settings	2 - RP7972A or RP7982A Load Settings
Voltage Programming & Readback Min:	Voltage priority: 1 V, 5 A	not used
Voltage Programming & Readback High:	Voltage priority: 1000 V, 5 A	not used
CV Load Effect, CV Ripple and Noise*:	Voltage priority: 333 V, 91 A	Current priority: 505 V, -90 A
Transient Response:	Voltage priority: 333 V, 91 A, Comp 0	Current priority: 550 V, -36 A to -81 A, slew=max, Comp 3**
Current Programming & Readback Min:	Current priority: 505 V, 0 A	Voltage priority: 500 V, 0 A
Current Programming & Readback High:	Current priority: 505 V, 90 A	Voltage priority: 333 V, -91 A
CC Load Effect:	Current priority: 1020 V, 30 A	Voltage priority: 1000 V, -30.5 A
100% of Current Rating (Isink):	Current priority: 505 V, -90 A	Voltage priority: 333 V, 91 A

\* **CAUTION** Equipment damage. The LeCroy DXC100A probe is limited to 500 V. Only connect for CV Ripple and Noise test.

\*\* Current comp 3 generates a 40 μs risetime step in the load list, which is required for the transient response test.

When using two RP7973A units as the load, set the first RP7973A in CC to -36 A, and the second RP7973A to create a 0 to -45 A pulse.

## Keysight RP7983A

**NOTE**

Verification requires the use of 3-phase 380/480 Vac mains input connections.

RP7983A Test Record	Report Number _____	Date _____	
Test Description	Min. Specs	Results	Max. Specs
Voltage Programming & Readback			
Minimum voltage (Vout):	1.8494	_____	2.1506
Voltage measured over interface:	Vout - 0.1506	_____	Vout + 0.1506
High voltage (Vout):	1999.25	_____	2000.75
Voltage measured over interface:	Vout - 0.75	_____	Vout + 0.75
CV Load Effect:	- 0.1	_____	+ 0.1
CV Ripple and Noise			
peak-to-peak:	N/A	_____	3.0
rms:	N/A	_____	0.4
Transient response @ 300 µs:	- 20	_____	+ 20
Current Programming & Readback			
Minimum current (Iout):	- 0.003	_____	0.003
Current measured over interface:	Iout - 0.003	_____	Iout + 0.003
High current (Iout):	29.988	_____	30.012
Current measured over interface:	Iout - 0.12	_____	Iout + 0.12
CC Load Effect:	- 0.004	_____	+ 0.004
Current Sink Tests			
100% of current rating:	- 30.012	_____	- 29.988

	RP7983A UUT Settings	2 - RP7973A or RP7983A Load Settings
Voltage Programming & Readback Min:	Voltage priority: 2 V, 5 A	not used
Voltage Programming & Readback High:	Voltage priority: 2000 V, 5 A	not used
CV Load Effect	Voltage priority: 1000 V, 30.5 A	Current priority: 1010 V, -30 A
CV Ripple and Noise*:	Voltage priority: 500 V, 30.5 A	Current priority: 520 V, -30 A
Transient Response:	Voltage priority: 500 V, 30.5 A, Comp 0	Current priority: 1500 V, -12 A to -27 A, slew=max, Comp 3**
Current Programming & Readback Min:	Current priority: 1010 V, 0 A	Voltage priority: 1000 V, 0 A
Current Programming & Readback High:	Current priority: 1010 V, 30 A	Voltage priority: 1000 V, -30.5 A
CC Load Effect:	Current priority: 2040 V, 15 A	Voltage priority: 2000 V, -15.2 A
100% of Current Rating (Isink):	Current priority: 1010 V, -30 A	Voltage priority: 1000 V, 30.5 A

\* **CAUTION** Equipment damage. The LeCroy DXC100A probe is limited to 500 V. Only connect for CV Ripple and Noise test.

\*\* Current comp 3 generates a 40 µs risetime step in the load list, which is required for the transient response test.

When using two RP7973A units as the load, set the first RP7973A in CC to -12 A, and the second RP7973A to create a 0 to -15 A pulse.

## Keysight RP7984A

**NOTE**

Verification requires the use of 3-phase 380/480 Vac mains input connections.

RP7984A Test Record		Report Number _____	Date _____
Test Description	Min. Specs	Results	Max. Specs
Voltage Programming & Readback			
Minimum voltage (Vout):	1.39955	_____	1.60045
Voltage measured over interface:	Vout - 0.10045	_____	Vout + 0.10045
High voltage (Vout):	1499.45	_____	1500.55
Voltage measured over interface:	Vout - 0.55	_____	Vout + 0.55
CV Load Effect:			
	- 0.075	_____	+ 0.075
CV Ripple and Noise			
peak-to-peak:	N/A	_____	2.25
rms:	N/A	_____	0.3
Transient response @ 300 µs:			
	- 15	_____	+ 15
Current Programming & Readback			
Minimum current (Iout):	- 0.006	_____	0.006
Current measured over interface:	Iout - 0.006	_____	Iout + 0.006
High current (Iout):	59.976	_____	60.024
Current measured over interface:	Iout - 0.024	_____	Iout + 0.024
CC Load Effect:			
	- 0.008	_____	+ 0.008
Current Sink Tests			
100% of current rating:	-60.024	_____	-59.976

	RP7984A UUT Settings	2 - RP7973A or RP7984A Load Settings
Voltage Programming & Readback Min:	Voltage priority: 1.5 V, 5 A	not used
Voltage Programming & Readback High:	Voltage priority: 1500 V, 5 A	not used
CV Load Effect:	Voltage priority: 500 V, 61.2 A	Current priority: 550 V, -60 A
CV Ripple and Noise*:	Voltage priority: 500 V, 61.2 A	Current priority: 520 V, -60 A
Transient Response:	Voltage priority: 500 V, 61.2 A, Comp 0	Current priority: 1100 V, -24 A to -54 A, slew=max, Comp 3**
Current Programming & Readback Min:	Current priority: 1010 V, 0 A	Voltage priority: 1000 V, 0 A
Current Programming & Readback High:	Current priority: 510 V, 60 A	Voltage priority: 500 V, -61.2 A
CC Load Effect:	Current priority: 1515 V, 20 A	Voltage priority: 1500 V, -20.5 A
100% of Current Rating (Isink):	Current priority: 760 V, -60 A	Voltage priority: 500 V, 61.2 A

\* **CAUTION** Equipment damage. The LeCroy DXC100A probe is limited to 500 V. Only connect for CV Ripple and Noise test.

\*\* Current comp 3 generates a 40 µs risetime step in the load list, which is required for the transient response test.

When using two RP7973A units as the load, set the first RP7973A in CC to -24 A, and the second RP7972A to create a 0 to -30 A pulse.

# 7

## Service and Maintenance

**Introduction**

**Self-Test Procedure**

**Firmware Update**

**Instrument Sanitize**

**Calibration Switches**

**Battery Replacemst**

**Disassembly**

## Introduction

### Repair Service Available

If your instrument fails during the warranty period, Keysight Technologies will repair or replace it under the terms of your warranty. After your warranty expires, Keysight offers repair services at competitive prices.

Many Keysight products have optional service contracts that extend coverage after the standard warranty expires.

### Obtaining Repair Service (Worldwide)

To obtain service for your instrument, contact your nearest **Keysight Technologies Service Center**. They will arrange to have your unit repaired or replaced, and can provide warranty or repair–cost information where applicable. Ask the Keysight Technologies Service Center for shipping instructions, including what components to ship. Keysight recommends that you retain the original shipping carton for return shipments.

### Before Returning the Unit

Before returning the unit, make sure the failure is in the instrument rather than any external connections. Also make sure that the instrument was accurately calibrated within the last year (see **Calibration Interval**).

If the unit is inoperative, verify that:

- the ac power cord is securely connected to the instrument
- the ac power cord is plugged into a live outlet
- the front-panel Power On/Standby switch has been pushed

If self-test failed, verify that:

Ensure that all connections (front and rear) are removed when self-test is performed. During self-test, errors may be induced by signals present on external wiring, such as long test leads that can act as antennae.

### Repackaging for Shipment

To ship the unit to Keysight for service or repair:

- Attach a tag to the unit identifying the owner and indicating the required service or repair. Include the model number and full serial number.
- Place the unit in its original container with appropriate packaging material.

- Secure the container with strong tape or metal bands.
- If the original shipping container is unavailable, Keysight strongly recommends obtaining one of the following packaging kits to ensure that the unit is not damaged in shipment:  
P/N 5188-9520 - Packaging kit for models RP7972A/RP7973A.

Keysight suggests that you always insure shipments.

## Cleaning

**WARNING** SHOCK HAZARD To prevent electric shock, disconnect the ac mains before cleaning.

---

Clean the outside of the instrument with a soft, lint-free, slightly damp cloth. Do not use detergent. Disassembly is not required or recommended for cleaning.

## Self-Test Procedure

### Power-On Self-Test

Each time the instrument is powered on, a self-test is performed. This test assures you that the instrument is operational.

Self-test checks that the minimum set of logic and power mesh systems are functioning properly. Self-test does not enable the output or place any voltages on the output. It leaves the instrument in the **reset state**.

### User-Initiated Self-Test

The user-initiated self-test is the same as the power-on self-test.

Front Panel Menu Reference	SCPI Command
Cycle ac power.	<b>*TST?</b>
If self-test fails, the front panel ERR indicator comes on. Press the Error key to display the list of errors.	If 0, self-test passed. If 1, self-test failed. If self test-fails, use <b>SYSTem:ERRor?</b> to view the self-test error.

For a list of errors, see **SCPI Error Messages**.



## Firmware Update

**NOTE**

Refer to **Instrument Identification** to determine which firmware version is installed on your instrument. All units in a primary/secondary configuration must have identical firmware.

---

### Software Required

To update the firmware you need to download the following two items onto your computer from the firmware download page at [www.keysight.com/find/RPSfirmware](http://www.keysight.com/find/RPSfirmware).

- The Universal Firmware Update Utility
- The latest firmware version

### Update Procedure

Once you have copied both items to your computer, proceed as follows:

1. Run the Universal Firmware Update Utility
2. Browse to the location of the firmware that you just downloaded. Press Next.
3. Select the interface that you are using to communicate with your instrument and enter the address or connections string. Press Next.
4. Verify that the information is correct for the instrument you are updating. Press Begin Update.

The update utility will now update the firmware and restart your instrument.

### Restricting Access

Note that you can restrict access to the instrument by the firmware update utility. This prevents unauthorized users from updating the firmware.

Front Panel Menu Reference	SCPI Command
Select <b>System\Admin\Update</b>	Not available
Check the Must log in as admin box.	
This requires a user to log into the Admin menu before the firmware update utility performs a firmware update.	

---

## Instrument Sanitize

**NOTE**

This procedure is not recommended for use in routine applications because of the possibility of unintended loss of data.

This procedure sanitizes all user data. It writes all zeros to flash memory and then performs a full chip erase as per the manufacturer's data sheet. Identification data such as instrument firmware, model number, serial number, MAC address, and calibration data is not erased. After the data is cleared, the instrument is rebooted.

If you cannot access the Admin menu, it may be password protected.

Front Panel Menu Reference	SCPI Command
Select <b>System\Admin\Sanitize</b>	<b>SYST:SEC:IMM</b>
Select Sanitize.	
Selecting Sanitize removes all user-data from the instrument and cycles power.	

Refer to <http://rfmw.em.keysight.com/aerospace/index.aspx> for detailed information.

### Turn-on after Sanitization

The first time the unit is turned on after it has been sanitized, several NVRAM checksum errors will be generated. These errors annunciate the fact that two files were missing, which have been recreated with default values. Reboot the unit one more time to remove the errors.

### Sanitizing an Inoperative Instrument

If the instrument is no longer functioning and you are unable to use the sanitization procedure described above, you must physically remove the P600 board from the instrument and destroy it. Refer to **Disassembly**.

## Calibration Switches

**WARNING**

**SHOCK HAZARD** Only qualified, service-trained personnel who are aware of the hazards involved should remove instrument covers. Always disconnect the power cable and any external circuits before removing the instrument cover. Some circuits are active and have power for a short time even when the power switch is turned off.

Two switches control the access to calibration commands. The switches are on the interface board and are accessible by removing the top cover.

### Accessing the Calibration Switch

1. Remove the instrument cover as described under **Disassembly**.
2. The calibration switch is on the interface board at the rear corner of the unit. To change the calibration switch settings, use a small screwdriver to move the switches. As shipped, all switches are set toward the ON position (see below).
3. Replace the top cover when finished.

**CAUTION**

Do not use a pencil to move the switches. Any graphite dust that gets on the switches will conduct electricity.

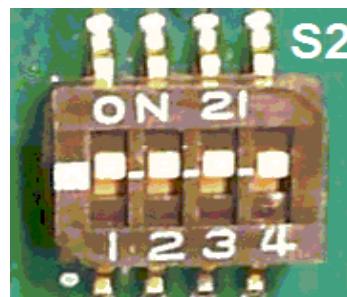
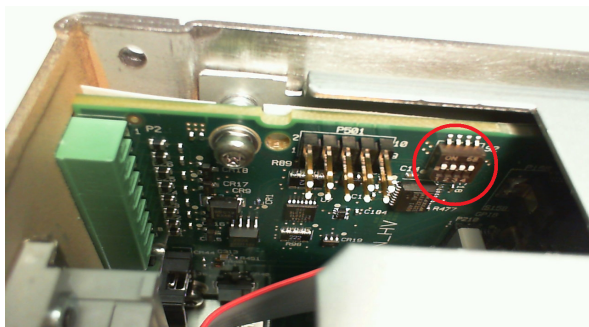

### Switch Functions

Switches 1 and 2 set the calibration configuration as follows. Switches 3 and 4 are not used.

	Switch 1	Switch 2	Description
Normal	ON	ON	This is the as-shipped switch setting. The calibration functions are accessible after entering a numeric password. The default password is 0 (zero).
Clear Password	OFF	ON	The admin/calibration password is reset to 0 when the instrument is first powered on. Use this setting if you have forgotten the password.
Inhibit Calibration	ON	OFF	All calibration commands are disabled. This is useful where access is guarded by instrument seals.

## Battery Replacement

**WARNING**

**SHOCK HAZARD** Only qualified, service-trained personnel who are aware of the hazards involved should remove instrument covers. Always disconnect the power cable and any external circuits before removing the instrument cover. Some circuits are active and have power for a short time even when the power switch is turned off.

---

The internal battery powers the system clock. The primary function of the clock is to provide time stamp information for the BenchVue Power Control and Analysis Software. If the battery fails, the time will not be available for the software. No other instrument functions are affected.

Under normal use at room temperature, the lithium battery has a life expectancy between seven and ten years. Note that battery life will be reduced if the instrument is stored for a prolonged period at temperatures above 40 degrees C.

The part number of the battery is Panasonic CR 2032.

### Replacement Procedure

1. Remove the instrument cover as described under **Disassembly**.
2. Remove the Control board as described under **Disassembly**.
3. The battery is located on the Constellation board under the ribbon cable.



4. To access the battery, release the ribbon cables by pulling up on the locking tab.

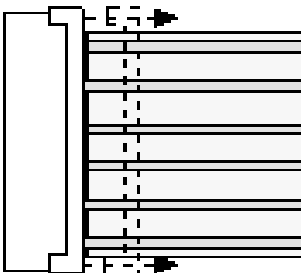

5. Use a flat-bladed screwdriver and carefully pry up on the side of the battery indicated by the arrow.

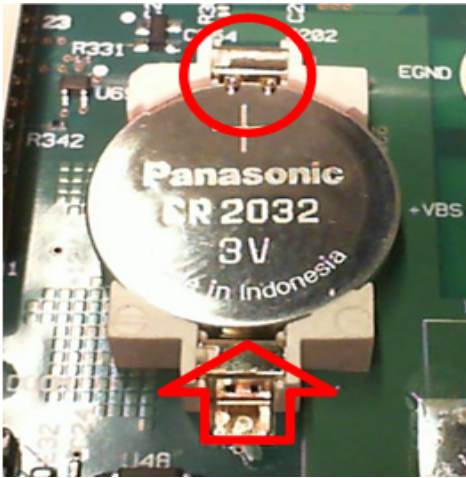

6. Install the new battery. Make sure that the positive side (+) is facing up. Place the battery *under* the small spring clips indicated by the circle, then push down on the opposite end of the battery indicated by the red arrow. The top of the small spring clips should be visible after the battery is seated (see red circle).
7. Replace the ribbon cables by fully inserting the cables into the connector; then pushing down on the locking tab to secure the cables.
8. Replace the Control board and top cover when finished. When reassembling, torque all screws to 9 in-lbs.
9. Reset the date and time (see [Clock Setup](#)).

## Disassembly

**WARNING**

**SHOCK HAZARD** Only qualified, service-trained personnel who are aware of the hazards involved should remove instrument covers. Always disconnect the power cable and any external circuits before removing the instrument cover. Some circuits are active and have power for a short time even when the power switch is turned off.

---

### Electrostatic Discharge (ESD) Precautions

Almost all electrical components can be damaged by electrostatic discharge (ESD) during handling. Component damage can occur at electrostatic discharge voltages as low as 50 V.

The following guidelines will help prevent ESD damage during service operations:

- Disassemble instruments only in a static-free work area.
- Use a conductive work area to reduce static charges.
- Use a conductive wrist strap to reduce static charge accumulation.
- Minimize handling.
- Keep replacement parts in original static-free packaging.
- Remove all plastic, foam, vinyl, paper, and other static-generating materials from the immediate work area.

### Tools Required

- T10 Torx driver for cover and board disassembly
- T8 Torx driver for P600 disassembly
- Small flat bladed screwdriver for battery removal

### Cover Disassembly

1. Turn off the power. Remove all cables from the instrument.
2. Remove the 7 (or 3) flat-head screws located on the top, the 10 flat-head screws along the sides, and the 2 pan-head screws on the back (see figure below). Place the screws in a container so that you do not lose them.
3. Remove the instrument cover.

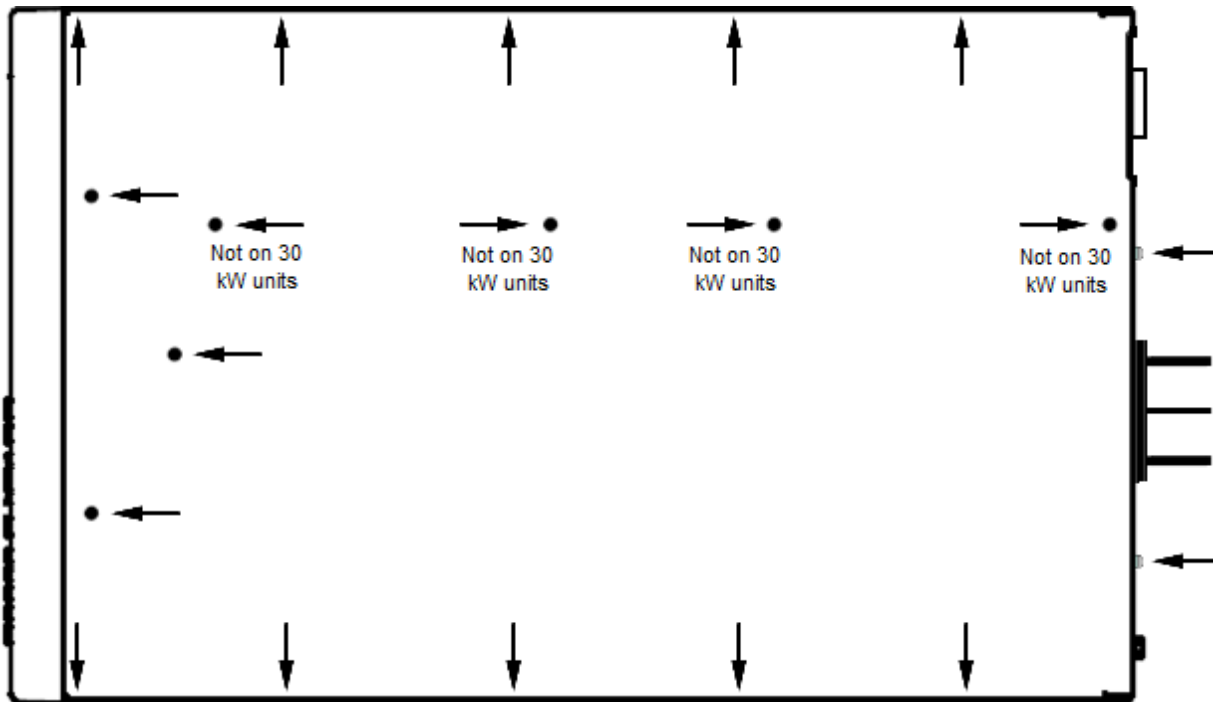

### Control Board Disassembly

The Control board is located on the outside of the Constellation board. It must be removed to provide access to the battery and the P600 board, which are both located on the Constellation board.

1. As indicated below, first remove the two screws along the top of the Control board. Place the screws in a container so that you do not lose them.

Remove  
screws



2. You can now lift the board out of its socket and move it to the side.  
(When reassembling the Control board, don't forget to replace the insulator behind the board.)

### Constellation Board Disassembly

If you have trouble accessing the Constellation board after you have moved the Control board out of the way, you can remove the Constellation board assembly.

1. Remove the three screws along the side of the chassis that attach the Constellation board. Place the screws in a container so that you do not lose them.



## 7 Service and Maintenance

Remove  
screws

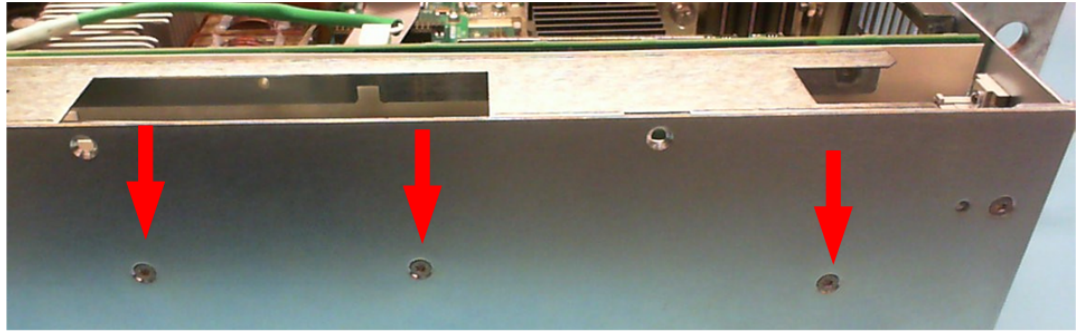

2. You can now lift the Constellation assembly out of the unit to access the P600 board and battery.
3. To access the P600 board, use a T8 Torx driver to remove the four heatsink screws. You can now remove the P600 board from its socket.

Remove 4  
heatsink  
screws to  
remove the  
P600 board

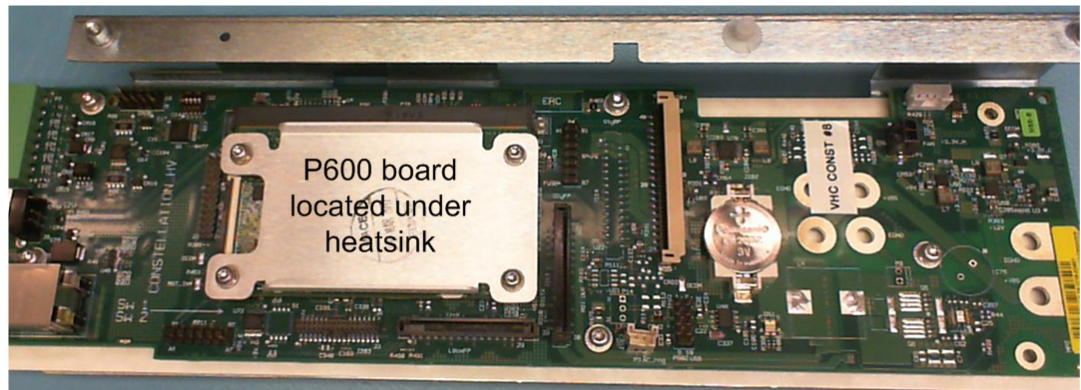

4. When reassembling, torque all screws to 9 in-lbs.



# Index

- \*  
\*CLS 194
- \*ESE 194
- \*ESR? 194
- \*IDN? 195
- \*OPC 195
- \*OPC? 195
- \*OPT? 196
- \*RCL 196
- \*RST 196
- \*SAV 197
- \*SRE 197
- \*STB? 197
- \*TRG 198
- \*TST? 198
- \*WAI 198

## A

- ABORt Subsystem 176
- AC dropout 103
- AC input
  - details 41
- AC mains
  - considerations 62
- Accessories 35
- Air flow 59
- Amp-hour
  - measurements 135

- ARB Subsystem 177
- Arbitrary waveform 127
- Average measurements 134

## B

- Battery replacement 288

## C

- CALibrate Subsystem 179
- Calibration 271
  - interval 272
  - switches 287
  - test equipment 262
- Capacitive load
  - boundary 51
- Characteristics 37
  - common 38
- Cleaning 13, 283
- Clear Status 252
- Clearing
  - protection 118
- Clock setup 155
- CLS 194, 252
- Command
  - processing times 173
  - quick reference 25
  - separators 170
  - subsystems 175
  - terminators 170

- communication
  - GPIB 89
  - LAN 90
  - lockout 95
  - remote interface 89
  - sockets 95
  - telnet 94
  - USB 89
  - web interface 93
- Compatibility
  - commands 260
- Compensation 101-102
- Connections
  - AC mains 62
  - bus bar 66
  - interface 78
  - parallel 75
  - primary/secondary 77
  - sense 66, 70
  - series 77
  - single unit 66
- Contacting
  - Keysight 15
- Current 85
  - compensation 102
  - sharing 104
  - sinking 112
- CURRent Subsyetem 182
- Curve parameters 157

**D**

- Data logging 143
  - retrieving 145
  - triggering 144
- DC offset 87
- Digital port
  - bi-directional 148
  - external trigger 149
  - fault output 150
  - inhibit input 150
  - input 149
  - output couple 151
- DIGital Subsyetem 185
- Digitized measurements 136
- Disassembly 290
- Display
  - lockout 154
  - saver 154
- DISPlay Subsystem 187

**E**

- EDP
  - graph 55
  - protection 114
- End-Or-Identify 171
- Environment 59
- Error messages 252

- ESE 194
- ESR? 194

**F**

- Factory reset 196, 247
- Features 16
- FETCh Subsystem 188
- FIFO 252
- Firmware Update 285
- First-in-first-out 252
- Float voltage 72
- FORMat Subsystem 191
- front-panel menus 22
- front panel 17, 20-22
- FUNction Command 192

**G**

- GPIB 252

**H**

- HCOPy Subsystem 193
- Help 88
- Help system 88

**I**

- I/O 252
  - queue 252
- IDN? 195
- IEEE-488 Common Com-  
mands 194
- Imp 156

- Impedance graphs 45
- Inductive load
  - boundary 49
- INITiate Subsystem 199
- Inspect 58
- Instrument
  - identification 153
- Instrument Sanitize 286
- INSTrument Subsystem 200
- Introduction 169
  - SCPI Language 169
- Isc 156

**K**

- Keywords 170

**L**

- Lead inductance 74
- Legal information 9
- LIST Subsyetem 202
- Load capacitance 73
- Load inductance
  - limitations 72
- LXI Command 205

**M**

- Making measurements 134
- MEASure Subsystem 206
- Measurement
  - accuracy w/NPLC 55

Measurements  
  sweep 134  
  triggering 138  
  windowing 135  
menus 22  
Message Available 197  
Models 35

**N**

Non-volatile settings 250

**O**

Offset  
  DC voltage 87  
OPC 195  
OPC? 195  
OPT? 196  
Options 35  
Output  
  bandwidth 101  
  current 85  
  enable 103  
  list 123  
  on/off behavior 131  
  on/off delay 129  
  on/off flowchart 133  
  on/off mode 102  
  sequencing 129  
  step 122  
  transient 119

  voltage 84  
OUTPut Subsystem 208  
Over-current  
  protection 115  
Over-voltage 86  
  protection 115

**P**

Parallel  
  connections 75  
  operation 104  
Parallel operation 104  
Parameter Types 172  
Password  
  setting 155  
Photovoltaic 156  
  curve parameters 157  
  table parameters 157  
Power cable 63  
POWer Query 213  
Primary/secondary  
  operation 104  
  power rating 108  
  programming 106  
  troubleshooting 110  
Priority Mode  
  current 164  
  setting 98  
  voltage 163

Programming  
  ARB 127  
  bandwidth 101  
  current 99  
  current sinking 112  
  digital port 147  
  priority 98  
  protection 113  
  resistance 100  
  slew rate 100  
  transients 119  
  voltage 99  
Programming response  
  small signal 54  
Protection  
  clearing 118  
  over-current 113  
  over-temperature 113  
  over-voltage 113

**Q**

Queries 170  
Querying  
  Status Byte Register 197  
Questionable Data Summary 197  
Queue 252  
  I/O 252  
Quick command  
  reference 25

## R

- Rack mounting 59
- RCL 196
- rear panel 18
- REFErence 25
- Regenerative
  - operation 17, 62, 112
- Remote interface 89
- Repackaging for shipment 282
- Repair service 282
- Reset state
  - settings 247
- RST 196

## S

- Safety 58
  - cover 67
  - notices 12
- SAS
  - bandwidth 160
  - equations 161
  - scale factors 160
  - troubleshooting 161
- SASimulator
  - Subsystem 214
- SAV 197
- SCPI 169
  - quick reference 25

- SCPI Language 169
  - Introduction 169
- SCPI Status System 252
- Self-test 198
- Self-test procedure 284
- SENSE Subsystem 219
- Service request
  - enable 197
- Set
  - DC Offset voltage 87
  - output current 85
  - output voltage 84
  - over-voltage 86
- SOURCE Subsystem 222
- Space curve equations 161
- Specifications 36
- SRE 197
- Stacking 59
- Standard Event
  - Summary 197
- Standard Operation Register 197
- Standard Operation Summary 197
- State storage 153
- Status
  - diagram 244
  - operation status 240
  - questionable status 241
  - standard event 242

- status byte 197, 243
- STATus Subsystem 223
- Status tutorial 240
- STB? 197
- STEP Command 227
- Subsystem commands 175
- Syntax Conventions 171
- SYSTEM Subsystem 228

## T

- Table arameters 157
- Terrestrial curve
  - equations 162
- Test record forms 276
- Transient Voltage Deviation 73
- TRG 198
- Trigger
  - diagram 246
  - tutorial 245
- TRIGger Subsystem 232
- TST? 198

## U

- Under-voltage
  - protection 117
- Using Device Clear 173

## V

- Verification 264
  - test equipment 262

Vmp 156

Voc 156

Voltage 84

    compensation 101

    low limit 99

VOLTage Subsystem 235

## W

WAI 198

Wait-for-trigger 198

Watchdog timer 116

Watt-hour

    measurements 135

Wire size 67

# Systeme d'alimentations régénératrices Keysight Séries RP7970 et RP7980

Guide d'utilisation  
et de maintenance



<b>Informations légales et de sécurité</b> .....	<b>9</b>
<b>Mentions légales</b> .....	<b>9</b>
<b>Symboles de sécurité et réglementaires</b> .....	<b>11</b>
<b>Consignes de sécurité</b> .....	<b>12</b>
<b>1 Aide-mémoire</b> .....	<b>15</b>
<b>Présentation de l'instrument</b> .....	<b>16</b>
Présentation succincte du système d'alimentations régénératrices .....	16
Présentation succincte du panneau avant .....	18
Présentation succincte du panneau arrière .....	19
Présentation succincte de l'écran du panneau avant .....	21
Présentation succincte des touches du panneau avant .....	22
<b>Aide-mémoire des menus du panneau avant</b> .....	<b>24</b>
<b>Aide-mémoire des commandes</b> .....	<b>27</b>
<b>Fonctionnalités et options des modèles</b> .....	<b>37</b>
Fonctionnalités des modèles .....	37
Options/Accessoires .....	38
<b>Spécifications et caractéristiques</b> .....	<b>39</b>
Spécifications .....	39
Caractéristiques supplémentaires .....	41
Caractéristiques communes .....	42
Efficacité de l'entrée CA, facteur de puissance et DHT .....	45
Graphiques des impédances de sortie .....	48
Limite de charge inductive pour un fonctionnement en courant constant (CC) .....	52
Limite de charge capacitive pour un fonctionnement en tension constante (CV) .....	54
Réponse à la programmation des petits signaux .....	57
Précision et résolution de la mesure - avec des intervalles de mesure plus courts .....	58
Protection dynamique excessive (tous les modèles) .....	58
Quadrants d'entrée .....	59
<b>2 Installation de l'instrument</b> .....	<b>61</b>
<b>Avant l'installation ou l'utilisation</b> .....	<b>62</b>
Inspection de l'appareil .....	62
Vérification des composants livrés .....	62
Examen des informations de sécurité .....	62
Observation des conditions environnementales .....	63
Circulation d'air adéquate .....	63
Déplacement des instruments .....	63
Empilage des instruments .....	64
Accessoires de montage en baie .....	64
Schéma de principe pour les modèles de 20 kW .....	65
Schéma de principe pour les modèles de 30 kW .....	66
<b>Connexions de l'alimentation secteur</b> .....	<b>67</b>
Caractéristiques communes de l'alimentation secteur .....	67
Connexions des câbles d'alimentation .....	68
<b>Connexions de sortie d'un appareil unique</b> .....	<b>72</b>
Connexions de sortie .....	72
Connexions de charge unique .....	74



Connexions de charges multiples .....	75
Connexions de mesure à distance .....	76
Autres considérations relatives à la charge .....	78
<b>Connexions de sortie de plusieurs appareils .....</b>	<b>83</b>
Connexions en parallèle .....	83
Connexions de mesure et de charge .....	83
Connexions principale/secondaire .....	85
Connexions en série .....	86
<b>Connexions de l'interface .....</b>	<b>87</b>
Connexions GPIB .....	87
Connexions USB .....	88
Connexions réseau (LAN) - locales et privées .....	88
Connexions du port numérique .....	89
Installation du capot de l'interface .....	90
<b>3 Mise en route .....</b>	<b>93</b>
<b>Utilisation du panneau avant .....</b>	<b>94</b>
Mise sous tension de l'appareil .....	94
Définition de la tension de sortie .....	95
Définition du courant de sortie .....	96
Définition de la protection contre les surtensions .....	97
Activation de la sortie .....	98
Utilisation du système d'aide intégrée .....	98
<b>Configuration de l'interface de commande à distance .....</b>	<b>100</b>
Introduction .....	100
Configuration USB .....	100
Configuration GPIB .....	100
Configuration LAN .....	101
Modification des paramètres LAN .....	102
Utilisation de l'interface Web .....	105
Utilisation de Telnet .....	106
Utilisation de sockets .....	106
Verrouillage de l'interface .....	107
<b>4 Utilisation du système d'alimentations régénératrices .....</b>	<b>109</b>
<b>Programmation de la sortie .....</b>	<b>110</b>
Définir le mode de priorité de sortie .....	110
Définition de la tension de sortie .....	111
Définition du courant de sortie .....	112
Définir la vitesse de balayage .....	112
Définir la résistance de sortie .....	113
Définir la bande passante de sortie .....	113
Régler le mode d'activation/de désactivation de la sortie .....	115
Activation de la sortie .....	116
<b>Fonctionnement en parallèle .....</b>	<b>117</b>
Introduction .....	117
Configuration principale/secondaire .....	117
Écran du panneau avant principal/secondaire .....	119
Considérations relatives à la programmation principale/secondaire .....	120

Détails sur la commande principale/secondaire .....	121
Dépannage .....	122
<b>Utilisation de la fonction d'absorption de courant .....</b>	<b>123</b>
Absorption de courant .....	123
Fonctionnement régénératif .....	124
<b>Programmation de la protection des sorties .....</b>	<b>125</b>
Introduction .....	125
Définir la protection contre les surtensions .....	127
Définir la protection contre les surintensités .....	128
Temporisateur de surveillance de la sortie .....	129
Définir la protection contre les sous-tensions .....	130
Supprimer la protection de la sortie .....	131
<b>Programmation des transitoires de sortie .....</b>	<b>132</b>
Introduction .....	132
Actions communes à tous les transitoires .....	132
Programmation d'un transitoire de palier .....	136
Programmation d'un transitoire de liste .....	137
Programmation d'un signal arbitraire .....	141
<b>Séquencement de la sortie .....</b>	<b>144</b>
Délais d'activation/de désactivation .....	144
Couplage de la sortie .....	144
Séquencement de plusieurs appareils .....	145
Comportement d'activation ou de désactivation à la sortie .....	147
<b>Réalisation de mesures .....</b>	<b>150</b>
Mesures moyennes .....	150
Balayage de mesure .....	150
Fenêtrage de la mesure .....	151
Mesures en ampères-heures et en watts-heures .....	151
Mesures numérisées .....	152
Déclenchement de la mesure .....	154
<b>Enregistrement de données externe .....</b>	<b>160</b>
Introduction .....	160
Sélectionnez la fonction de mesure. ....	160
Spécifier la période d'intégration .....	161
Sélectionner la source de déclenchement des données externes (Elog) .....	161
Démarrer et déclencher l'enregistrement de données externe .....	162
Récupérer régulièrement les données .....	163
Interrompre l'enregistrement de données externe (Elog) .....	163
<b>Programmation du port numérique .....</b>	<b>164</b>
Port de commande numérique .....	164
Entrées/sorties numériques bidirectionnelles .....	165
Entrée numérique .....	166
E/S de déclenchement externe .....	166
Sortie de défaillance .....	167
Entrée d'inhibition .....	167
Protection du système de défaillance/inhibition .....	168
Commande de couplage des sorties .....	169
<b>Opérations système .....</b>	<b>171</b>

Identification de l'instrument .....	171
Stockage des configurations de l'instrument .....	171
Affichage du panneau avant .....	172
Verrouillage du panneau avant .....	173
Protection par mot de passe .....	173
Clock Setup (Réglage de l'horloge) .....	174
<b>Fonctionnement photovoltaïque (SAS) .....</b>	<b>175</b>
Introduction .....	175
Programmation des paramètres de Courbe .....	176
Programmation des paramètres de Tableau .....	177
Programmation de tableaux multiples .....	178
Programmation des paramètres supplémentaires .....	179
Détails sur les commandes SAS .....	180
Dépannage .....	180
Équations du modèle .....	181
<b>Didacticiel du mode de priorité .....</b>	<b>183</b>
Priorité de tension .....	183
Priorité de courant .....	184
<b>5 Aide-mémoire de la programmation SCPI .....</b>	<b>187</b>
<b>Logiciels associés .....</b>	<b>188</b>
<b>Présentation du SCPI .....</b>	<b>189</b>
Introduction .....	189
Mots-clés .....	190
Requêtes .....	190
Séparateurs et caractères de fin de commande .....	190
Conventions syntaxiques .....	191
Types de paramètres .....	192
Device Clear .....	193
Temps de traitement de commande type .....	194
<b>Commandes par sous-système .....</b>	<b>195</b>
Sous-système ABORt .....	196
Sous-système ARB .....	197
Sous-système CALibrate .....	199
Sous-système CURRent .....	202
Sous-système DIGital .....	206
Sous-système DISPlay .....	208
Sous-système FETCh .....	209
Sous-système FORMat .....	212
Commande FUNCtion .....	213
Sous-système HCOPy .....	214
Commandes courantes IEEE-488 .....	215
Sous-système INITiate .....	221
Sous-système INSTRument .....	222
Sous-système LIST .....	225
Sous-système LXI .....	228
Sous-système MEASure .....	229
Sous-système OUTPut .....	231

Requête POWer .....	237
Sous-système SASimulator .....	238
Sous-système SENSE .....	244
Sous-système [SOURce] .....	248
Sous-système STATus .....	249
Commande STEP .....	254
Sous-système SYSTem .....	255
Sous-système TRIGger .....	260
Sous-système VOLTage .....	263
<b>Didacticiel d'état .....</b>	<b>269</b>
Registres d'état .....	269
Groupe d'état de fonctionnement .....	269
Groupes d'état suspects .....	270
Groupe d'états d'événement standard .....	271
Registre d'octet d'état .....	272
Files d'erreurs et de sortie .....	273
Schéma d'état .....	274
<b>Didacticiel de déclenchement .....</b>	<b>275</b>
Sources de déclenchement .....	275
Destinations de déclenchement .....	275
Schéma de déclenchement .....	276
<b>État de réinitialisation (*RST) .....</b>	<b>277</b>
<b>Messages d'erreur SCPI .....</b>	<b>282</b>
<b>Commandes de compatibilité .....</b>	<b>291</b>
<b>6 Vérification et étalonnage .....</b>	<b>293</b>
<b>Équipement et configurations de test .....</b>	<b>294</b>
Équipement de test .....	294
Configurations de mesure .....	295
<b>Vérification du fonctionnement .....</b>	<b>296</b>
Introduction .....	296
Configurations de vérification .....	298
Considérations relatives aux tests .....	298
Procédure de vérification .....	299
<b>Étalonnage de l'instrument .....</b>	<b>304</b>
Introduction .....	304
Fréquence de l'étalonnage .....	305
Configurations d'étalonnage .....	305
Considérations relatives aux tests .....	306
Procédure d'étalonnage .....	306
<b>Formulaires de relevé de test - Gamme RPS .....</b>	<b>310</b>
<b>7 Maintenance et réparation .....</b>	<b>315</b>
<b>Introduction .....</b>	<b>316</b>
Service de réparation disponible .....	316
Avant de retourner l'appareil .....	316
Remballage pour l'expédition .....	316
Nettoyage .....	317
<b>Procédure d'autotest .....</b>	<b>318</b>

Autotest à la mise sous tension .....	318
Autotest initié par l'utilisateur .....	318
<b>Mise à jour du microprogramme .....</b>	<b>319</b>
Logiciel requis .....	319
Procédure de mise à jour .....	319
Restriction de l'accès .....	319
<b>Nettoyage de la mémoire de l'instrument .....</b>	<b>321</b>
Activation après le nettoyage .....	321
Nettoyage d'un instrument inopérant .....	321
<b>Commutateurs d'étalonnage .....</b>	<b>322</b>
Accès au commutateur d'étalonnage .....	322
Fonctions de commutation .....	322
<b>Remplacement de la batterie .....</b>	<b>323</b>
<b>Démontage .....</b>	<b>326</b>
Précautions contre les décharges électrostatiques (ESD) .....	326
Outils nécessaires .....	326
Démontage du capot .....	326
Démontage de la carte de commande .....	327
Démontage de la carte Constellation .....	327
<b>Index .....</b>	<b>329</b>

## Informations légales et de sécurité

### Mentions légales

### Symboles de sécurité et réglementaires

### Consignes de sécurité

## Mentions légales

© Copyright Keysight Technologies 2020, 2021

Édition 3, octobre 2021

Numéro de référence du manuel RP7900-90951

Conformément aux lois internationales relatives à la propriété intellectuelle, toute reproduction, tout stockage électronique et toute traduction de ce manuel, totaux ou partiels, sous quelque forme et par quelque moyen que ce soit, sont interdits sauf consentement écrit préalable de la société Keysight Technologies.

Dans ce document, les termes « maître » et « esclave » ont été remplacés par les termes « principal » et « secondaire ».

Keysight Technologies  
550 Clark Drive, Suite 101  
Budd Lake, NJ 07828 États-Unis

## Logiciels

Ce produit utilise Microsoft Windows CE. Keysight recommande instamment que tous les ordinateurs sous Windows connectés aux instruments sous Windows CE utilisent un antivirus courant.

Le matériel et le logiciel décrits dans ce document sont protégés par un accord de licence ; leur utilisation ou leur reproduction est soumise aux termes et conditions de ladite licence.

## Fichiers de licences

Dans le code source gifencode C :

- \* Code extrait de ppmtogif.c, du kit pbmplus basé sur GIFENCOD
- \* de David Rowley <mgardi@watdscu.waterloo.edu>. A Lempel-Zim
- \* compression basée sur « compress ». Modifié par Marcel Wijkstra
- \* <wijkstra@fwi.uva.nl> Copyright (C) 1989 de Jef Poskanzer. L'autorisation
- \* d'utiliser, de copier, de modifier et de distribuer ce logiciel et sa
- \* documentation pour tout usage et sans frais est accordée par les présentes,
- \* à condition que l'avis de droit d'auteur ci-dessus apparaisse dans toutes les copies et que
- \* cet avis de droit d'auteur et cet avis d'autorisation apparaissent dans
- \* la documentation à l'appui. Ce logiciel est fourni « tel quel » sans
- \* garantie expresse ou implicite. Le format Graphics Interchange Format(c) est le
- \* propriété intellectuelle de CompuServe Incorporated. GIF(sm) est un service
- \* Marquer la propriété intellectuelle de CompuServe Incorporated. ;

## Garantie

Les informations contenues dans ce document sont fournies "en l'état" et peuvent faire l'objet de modifications sans préavis dans les éditions ultérieures. Par ailleurs, dans les limites de la législation en vigueur, Keysight exclut en outre toute garantie, expresse ou implicite, concernant ce manuel et les informations qu'il contient, y compris, mais non exclusivement, les garanties de qualité marchande et d'adéquation à un usage particulier. Keysight ne saurait en aucun cas être tenu responsable des erreurs ou des dommages incidents ou indirects, liés à la fourniture, à l'utilisation ou à l'exactitude de ce document ou aux performances de tout produit Keysight auquel il se rapporte. Si Keysight a passé un contrat écrit avec l'utilisateur et que certains termes de ce contrat semblent contradictoires avec ceux de ce document, les termes et conditions de la garantie prévalent.

## Certificat

Keysight Technologies certifie que ce produit était conforme à ses spécifications publiées au moment de son expédition de l'usine. Keysight Technologies certifie en outre la traçabilité des mesures d'étalonnage conformément à l'United States National Institute of Standards and Technology, aux extensions autorisées par l'établissement d'étalonnage de l'Institut et aux établissements d'étalonnage des autres membres de l'organisation Internationale de Normalisation (ISO).

## Droits du Gouvernement des États-Unis

Le Logiciel est un « logiciel informatique commercial » tel que défini par la Federal Acquisition Regulation (« FAR ») 2.101. Conformément aux FAR 12.212 et 27.405-3 et à l'addenda FAR du Ministère de la Défense (« DFARS ») 227.7202, le gouvernement des États-Unis acquiert des logiciels informatiques commerciaux dans les mêmes conditions que celles dans lesquelles les logiciels sont habituellement fournis au public. Par conséquent, Keysight met le Logiciel à la disposition des clients du gouvernement des États-Unis dans le cadre de sa licence commerciale standard, qui est intégrée dans son Contrat de licence utilisateur final (CLUF), dont une copie est disponible à l'adresse suivante : [www.keysight.com/find/sweula](http://www.keysight.com/find/sweula). La licence mentionnée dans le CLUF représente l'autorité exclusive par laquelle le gouvernement des États-Unis est autorisé à utiliser, modifier, distribuer ou divulguer le Logiciel. Le CLUF et la licence qui y sont mentionnés, n'exigent ni ne permettent, entre autres, que Keysight : (1) Fournisse des données techniques relatives aux logiciels informatiques commerciaux ou à la documentation afférente qui ne sont pas mis habituellement à la disposition du public ; ou (2) Renonce aux droits gouvernementaux ou confère les droits gouvernementaux en plus des droits habituellement mis à la disposition du public pour utiliser, modifier, reproduire, publier, exécuter, afficher ou divulguer des logiciels informatiques commerciaux ou la documentation afférente. Aucune exigence gouvernementale additionnelle outre que celles énoncées dans le CLUF ne s'applique, sauf si ces conditions, droits ou licences sont explicitement exigés par tous les fournisseurs de logiciels informatiques commerciaux conformément à la FAR et aux DFARS et sont énoncés expressément par écrit ailleurs dans le CLUF. Keysight n'est en aucun cas tenu de mettre à jour, de réviser ou de modifier de quelque façon que ce soit le Logiciel. En ce qui concerne toutes les données techniques telles que définies par la FAR 2.101, conformément aux FAR 12.211 et 27.404.2 et au DFARS 227.7102, le gouvernement des États-Unis acquiert des droits n'excédant pas les Droits limités tels que définis dans la FAR 27.401 ou le DFARS 227.7103-5 (c), applicables dans toutes les données techniques.

## Directive européenne 2012/19/EU relative aux déchets d'équipements électriques et électroniques (DEEE)

Le symbole de poubelle barrée suivant indique que la collecte sélective des déchets d'équipements électriques et électroniques (DEEE) est obligatoire, conformément à la DIRECTIVE 2012/19/EU et à d'autres lois nationales.

Ne pas éliminer avec les ordures ménagères. Veuillez vous reporter à [about.keysight.com/en/companyinfo/environment/takeback.shtml](http://about.keysight.com/en/companyinfo/environment/takeback.shtml) pour comprendre vos options d'échange avec Keysight en plus des instructions de reprise des produits.



## Symboles de sécurité et réglementaires

### AVERTISSEMENT

La mention AVERTISSEMENT signale un danger pour la sécurité de l'opérateur. Elle attire l'attention sur une procédure ou une pratique qui, si elle n'est pas respectée ou correctement réalisée, peut se traduire par des accidents graves, voire mortels. En présence de la mention AVERTISSEMENT, il convient de s'interrompre tant que les conditions indiquées n'ont pas été parfaitement comprises et respectées.

### ATTENTION

La mention ATTENTION signale un danger pour le matériel. Elle attire l'attention sur une procédure ou une pratique qui, si elle n'est pas respectée ou correctement réalisée, peut se traduire par un endommagement de l'appareil ou une perte de données importante. En présence de la mention ATTENTION, il convient de ne pas continuer tant que les conditions indiquées n'ont pas été parfaitement comprises et respectées.



Courant continu



Courant alternatif



Borne reliée au cadre ou au châssis



Alimentation en mode veille. L'appareil n'est pas complètement déconnecté du secteur si l'interrupteur est éteint.



**AVERTISSEMENT** risque d'électrocution



**AVERTISSEMENT** consultez la documentation fournie



Borne de mise à la terre



Le marquage CE est une marque déposée de la Communauté européenne.

Le marquage CAN ICES/NMB-001(A) indique la conformité du produit aux Normes canadiennes sur le matériel brouilleur (Canadian Interference-Causing Equipment Standard).

Le marquage ISM GRP 1-A indique un appareil industriel, scientifique et médical de classe A et du groupe 1 (CISPER 11, clause 4).



La marque ETL est une marque déposée de la société Intertek. Le texte indique la conformité du produit aux Normes canadiennes des Équipements provoquant des Interférences (Canadian Interference-Causing Equipment Standard - ICES-001).



La marque RCM est une marque déposée de l'Australian Communications and Media Authority.



Indique que la conformité a été évaluée au Royaume-Uni.



Contient une ou plusieurs des 6 substances dangereuses supérieures à la valeur de concentration maximale (MCV), période d'utilisation de protection environnementale (EPUP) de 40 ans.



Déclaration sud-coréenne de CEM de classe A.

Cet équipement a été jugé conforme pour une utilisation dans des environnements professionnels. Dans un environnement résidentiel, cet équipement pourrait causer des interférences radio. Cette déclaration de CEM s'applique à cet équipement pour une utilisation dans un environnement professionnel uniquement.



<b>사 용 자 안 내 문</b>
--------------------

<p>이 기기는 업무용 환경에서 사용할 목적으로 적합성평가를 받은 기기로서 가정용 환경에서 사용하는 경우 전파간섭의 우려가 있습니다.</p>
------------------------------------------------------------------------------------

※ 사용자 안내문은 "업무용 방송통신기자재"에만 적용한다.

## Consignes de sécurité

Les consignes de sécurité présentées dans cette section doivent être appliquées au cours des différentes phases d'utilisation de cet instrument. Le non-respect de ces précautions ou des avertissements et instructions spécifiques mentionnés dans ce manuel constitue une violation des normes de sécurité établies lors de la conception, de la fabrication et de l'usage normal de l'instrument. Keysight Technologies ne saurait être tenu pour responsable du non-respect de ces consignes.

L'équipement est à usage industriel. Les opérateurs de l'équipement doivent respecter toutes les réglementations de sécurité applicables. En plus des avertissements et avis de sécurité présents dans ce manuel, toutes les réglementations pertinentes relatives à la sécurité, la prévention des accidents et l'environnement doivent être respectées. Il convient en particulier de noter que les opérateurs de l'équipement :

- doivent être informés des exigences de sécurité pertinentes ;
- doivent avoir lu et compris le guide d'utilisation avant d'utiliser l'équipement ;
- doivent utiliser l'équipement de sécurité désigné et recommandé.

**AVERTISSEMENT**

### Généralités

N'utilisez ce produit que de la manière préconisée par le fabricant. Les fonctions de sécurité de ce produit peuvent être perturbées si vous ne respectez pas les consignes d'utilisation.

**AVERTISSEMENT**

### Conditions d'environnement

N'utilisez jamais l'instrument en dehors des conditions environnementales spécifiées décrites dans les Conditions ambiantes des spécifications.

**AVERTISSEMENT**

### Poids élevé.

Danger relatif aux mains et aux pieds. Afin d'éviter toute blessure ou dommage à l'instrument, utilisez toujours un chariot solide ou tout autre appareil adéquat pour déplacer l'instrument. Ne soulevez jamais l'instrument seul(e) ; veillez à toujours être au moins deux personnes pour soulever l'instrument.



**AVERTISSEMENT**

**RISQUE D'ÉLECTROCUTION** Mise à la terre de l'instrument

Ce produit comporte une borne de terre de protection. Afin de réduire les risques d'électrocution, l'instrument doit être relié à une source de courant alternatif par l'intermédiaire d'un cordon d'alimentation secteur pourvu d'un fil de terre connecté fermement à une terre électrique (terre de sécurité) au niveau de la prise de courant. Toute interruption du conducteur de protection (mise à la terre) ou tout débranchement de la borne de terre de protection entraîne un risque d'électrocution pouvant provoquer des accidents graves, voire mortels.

---

**AVERTISSEMENT**

**Avant la mise sous tension**

Vérifiez que vous avez bien respecté toutes les consignes de sécurité. Tous les branchements doivent être effectués alors que l'unité est hors tension, et ils doivent être réalisés par du personnel qualifié conscient des dangers inhérents. Toute action inappropriée est susceptible de provoquer des blessures mortelles et d'endommager l'équipement. Lisez les mentions apposées sur l'extérieur de l'instrument décrites à la section "Symboles de sécurité".

---

**AVERTISSEMENT**

**RISQUE D'ÉLECTROCUTION, TENSION LÉTALES** De nombreux modèles génèrent des tensions allant jusqu'à 2 000 V CC ! Assurez-vous que toutes les connexions des instruments, le câblage de charge ainsi que les connexions de charge et de mesure sont isolés à l'aide de fils haute tension. Fixez toujours le capot de sécurité fourni, de sorte qu'aucun contact accidentel avec des tensions mortelles ne puisse se produire.

---

**AVERTISSEMENT**

**RISQUE D'ÉLECTROCUTION** Ne touchez jamais les câbles ou les connexions immédiatement après avoir éteint l'appareil. En fonction du modèle, des tensions létales demeurent aux bornes de sortie pendant plusieurs secondes après la mise hors tension. Vérifiez qu'il n'y a pas de tension dangereuse sur les bornes de sortie ou de mesure avant de les toucher.

---

**AVERTISSEMENT**

**RISQUE D'ÉLECTROCUTION** avec les sources d'énergie externes.

Étant donné que l'instrument peut être utilisé comme charge pour courant absorbé, des tensions dangereuses provenant d'une source d'énergie externe telles qu'une batterie peuvent être présentes sur les bornes de sortie même si l'appareil est éteint. Prévoyez de débrancher la source d'énergie externe avant de toucher les bornes de sortie ou de mesure.

---

**AVERTISSEMENT**

**Ne pas utiliser en atmosphère explosive**

N'utilisez pas l'instrument en présence de gaz ou de vapeurs inflammables.

---

**AVERTISSEMENT**

**Ne pas démonter le capot de l'instrument**

Seules des personnes qualifiées, formées à la maintenance et conscientes des risques d'électrocution encourus peuvent démonter les capots de l'instrument. Débranchez toujours le cordon d'alimentation secteur et tous les circuits externes avant de démonter le capot de l'instrument.

---

**AVERTISSEMENT**

**Ne pas modifier l'instrument**

Ne pas installer de composants de rechange et ne pas apporter de modifications non autorisées à l'appareil. Pour garantir les caractéristiques de sécurité de l'instrument, retournez-le à votre bureau de vente et d'après-vente Keysight le plus proche en vue d'une opération de maintenance et de réparation.

---

**AVERTISSEMENT**

**Fusibles**

L'instrument contient un fusible interne non accessible à l'utilisateur.

---

**AVERTISSEMENT**

**Nettoyage**

Pour éviter toute électrocution, débranchez toujours la source de courant alternatif avant le nettoyage. Utilisez un chiffon sec ou légèrement humidifié avec de l'eau pour nettoyer les parties externes. N'utilisez pas de détergent ou de solvant. Ne tentez aucune opération de nettoyage interne.

---

**AVERTISSEMENT**

**En cas de dommages**

Les instruments endommagés ou défectueux doivent être désactivés et protégés contre toute utilisation involontaire jusqu'à ce qu'ils aient été réparés par une personne qualifiée.

---

# 1

# Aide-mémoire

## Informations légales et de sécurité

## Présentation de l'instrument

## Aide-mémoire des menus du panneau avant

## Aide-mémoire des commandes

## Fonctionnalités et options des modèles

## Spécifications et caractéristiques

Ce document contient des informations sur l'utilisation, la maintenance et la programmation de la gamme de systèmes d'alimentations régénératrices (RPS) Keysight.

## Documentation, microprogramme et assistance technique

Vous pouvez télécharger la dernière version de ce document à l'adresse [www.keysight.com/find/RPSPV-doc](http://www.keysight.com/find/RPSPV-doc).

Vous pouvez télécharger la dernière version de ce document à l'adresse [www.keysight.com/find/PV8900-doc](http://www.keysight.com/find/PV8900-doc).

Pour obtenir la dernière version du microprogramme, accédez à la page [Mises à jour du microprogramme](#).

Pour toute question concernant votre livraison ou pour obtenir des informations sur la garantie, la maintenance ou l'assistance technique, contactez Keysight Technologies.

## Contactez Keysight Technologies

Pour pouvoir contacter Keysight dans le monde entier, ou votre représentant Keysight Technologies, rendez-vous sur [www.keysight.com/find/assist](http://www.keysight.com/find/assist).

## Présentation de l'instrument

**Présentation succincte du système d'alimentations régénératrices**

**Présentation succincte du panneau avant**

**Présentation succincte du panneau arrière**

**Présentation succincte de l'écran du panneau avant**

**Présentation succincte des touches du panneau avant**

### Présentation succincte du système d'alimentations régénératrices

La série RPS (système d'alimentations régénératrices) de Keysight comprend des modules d'alimentation en courant continu montables sur baie 3U et 5U dotés de performances et de fonctionnalités optimisées pour les systèmes de test automatisés. Les caractéristiques de sortie et système sont décrites ci-dessous. La section **Modèles et options** décrit les fonctionnalités qui s'appliquent à certains modèles.

#### Caractéristiques de sortie

- Des fonctionnalités de programmation complètes pour toute la plage de tension et de courant de sortie
- Commutation automatique de plage de sortie pour une plus grande flexibilité
- La sortie peut fonctionner en mode priorité de tension, priorité de courant ou photovoltaïque (SAS)
- Programmation de sortie amont et aval haut débit
- Programmation de la résistance de sortie
- Possibilité de programmer une forme d'onde arbitraire et une liste de sortie
- Les délais d'activation/de désactivation permettent de séquencer l'activation et la désactivation de la sortie sur plusieurs appareils
- Fonctionnalité de partage de courant pour les sorties parallèles
- La capacité de protection comprend la surtension, la surintensité et la surchauffe
- Interrupteur général de sortie statique pour une protection rapide et des transitions marche/arrêt en douceur
- Le fonctionnement sur deux quadrants offre une capacité d'alimentation en courant ou d'absorption de courant
- Modèles dotés de valeurs nominales à 20 kW et 30 kW

#### Fonctionnalités de mesure

- Fréquence d'échantillonnage de 5,12 microsecondes
- Mesures de puissance en temps réel
- Mesures en ampères-heures et en watts-heures
- Capacité de mesures numérisées

### Caractéristiques du système

- Enregistrement et rappel de 10 configurations d'instrument maximum dans la mémoire non volatile
- Les interfaces de programmation à distance GPIB (IEEE-488), LAN et USB sont intégrées
- Configuration du menu du panneau avant pour les paramètres GPIB et LAN
- Conforme à la spécification de l'appareil 1.5 LXI 2016, avec serveur Web intégré
- Compatibilité SCPI (Standard Commands for Programmable Instruments)
- La fonction principal/secondaire permet de contrôler des sorties composites et l'affichage sur un appareil

### Fonctionnement régénératif

Chaque fois que le RPS absorbe du courant, soit par programmation aval rapide de la sortie, soit par déchargement d'une source d'énergie comme une batterie, l'appareil dirigera la puissance excessive vers la source de courant alternatif. Vous ne pouvez pas désactiver le fonctionnement régénératif.

Lors du fonctionnement régénératif, le facteur de puissance de 0,99 est maintenu. La distorsion du courant sinusoïdal est inférieure à 2 % à pleine charge. Cela garantit la qualité du signal CA qui est renvoyé à la source de courant alternatif.

Lorsqu'une panne secteur est détectée, les relais galvaniques déconnectent la source de courant alternatif et l'appareil s'arrête. Pour protéger votre appareil testé, le RPS fournit un « anti-îlotage » qui détecte que le réseau est sous tension avant de régénérer l'alimentation du réseau.

Reportez-vous à la section **Caractéristiques communes de l'alimentation secteur** pour obtenir plus d'informations sur l'arrêt et le redémarrage de l'appareil.

## Présentation succincte du panneau avant

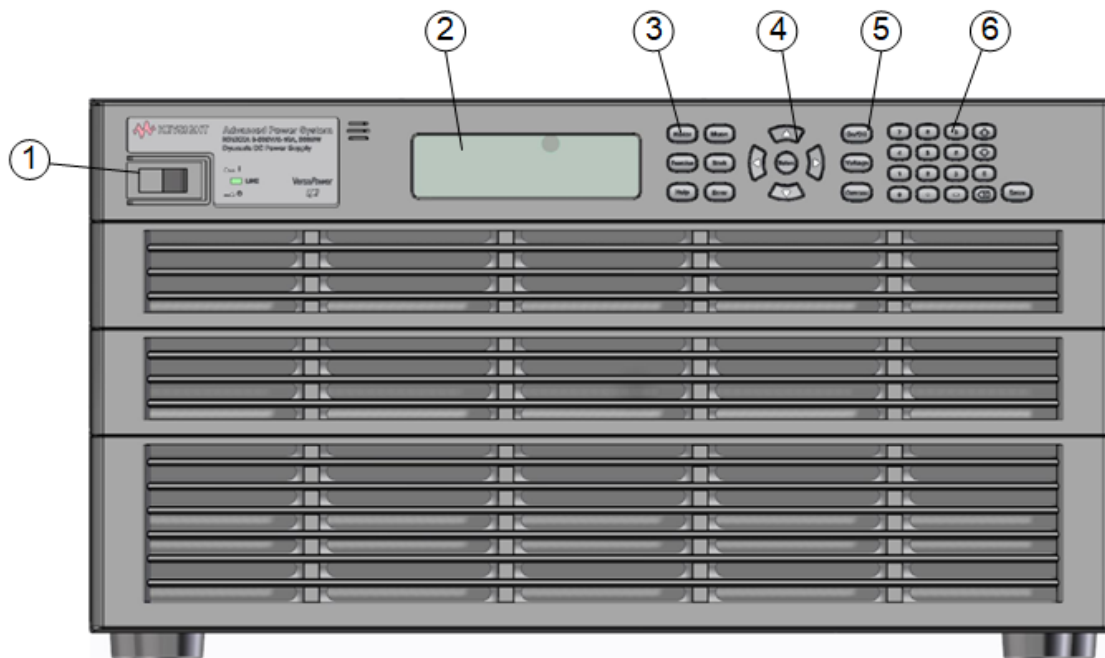
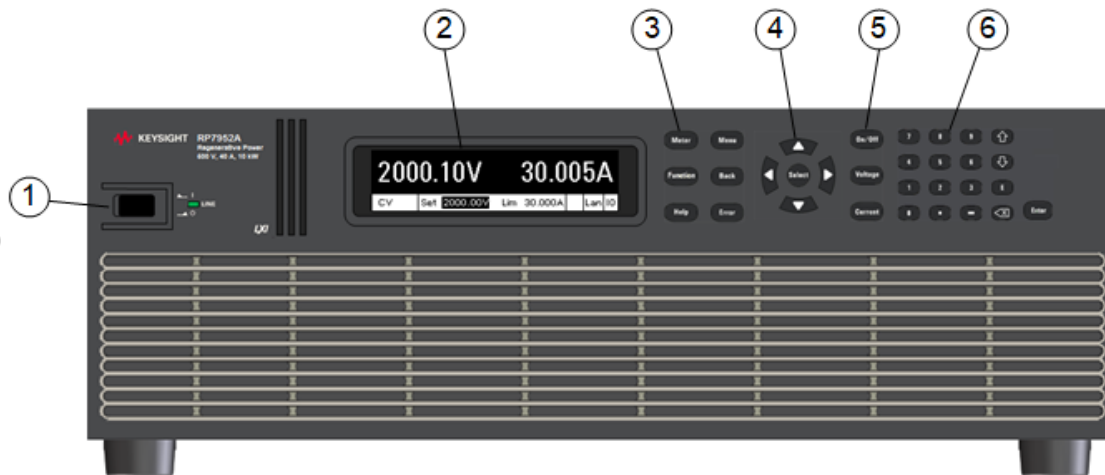

1. **Commutateur et voyant On/Off (Marche/arrêt)** : le voyant indique que l'appareil est sous tension. Un voyant vert indique un fonctionnement normal. Le voyant orange indique un écran en mode veille.
2. **Affichage** : s'éteint après une heure d'inactivité. Appuyez sur une touche pour rallumer l'écran.
3. **Touches du système** : sélectionnent la fonction de mesure. Accédez aux menus de commande, d'aide et d'erreur du panneau avant.
4. **Touches de navigation** : placent le curseur sur un élément de menu. Sélectionnent l'élément de menu en surbrillance.
5. **Touches de sortie** : activent ou désactivent les sorties. Permettent la saisie des valeurs de tension ou de courant.

6. **Touches d'entrée numérique** : permettent de saisir des valeurs. Les touches fléchées augmentent ou diminuent les paramètres numériques.

### Présentation succincte du panneau arrière

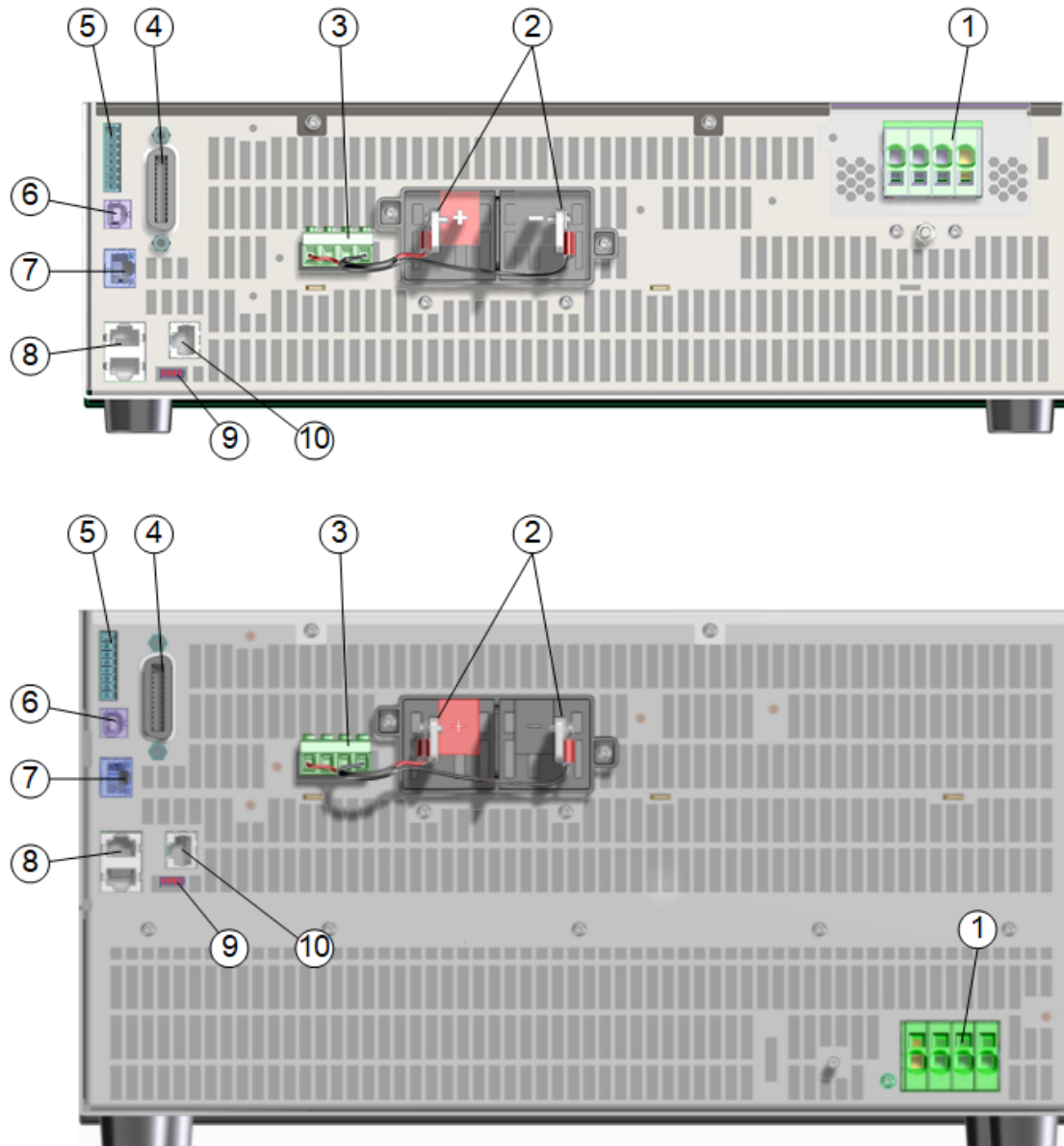

1. **Entrée CA** : entrée CA triphasée. Nécessite des connexions triphasées L1, L2, L3 et neutre. Un plot de terre du châssis est situé sous le connecteur pour les connexions de terre. L'entrée CA est bidirectionnelle.
2. **Sorties CC** : bornes de sortie positives et négatives.
3. **Mesures** : bornes de mesure à distance, connectées en mode de mesure locale.
4. **GPIB** : connecteur de l'interface GPIB.
5. **E/S numérique** : connecteur d'E/S numérique. Les broches sont configurables par l'utilisateur.



## 1 Aide-mémoire

6. **USB** : connecteur de l'interface USB.
7. **LAN** : le voyant de gauche 10/100/1000 Base-T indique l'activité. Le voyant de droite indique l'intégrité de la liaison.
8. **Principal/secondaire** : connecteurs pour le regroupement d'appareils en parallèle.
9. **Commutateurs de terminaison** : spécifie les types de terminaison principal/secondaire.
10. **Déconnexion de sécurité** : non disponible pour utilisation.

## Présentation succincte de l'écran du panneau avant

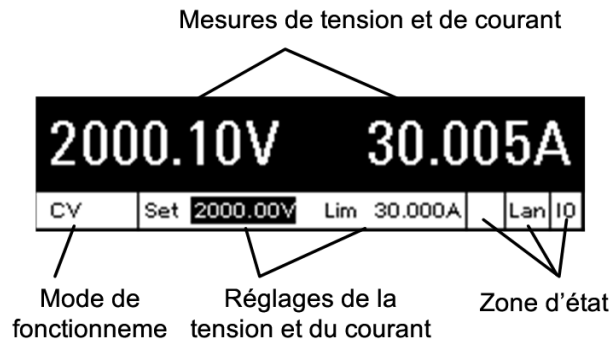

<b>Mesures de tension et de courant</b>	Affiche la valeur réelle de la tension et du courant de sortie
<b>Mode de fonctionnement</b>	<p>Indique l'une des options suivantes :</p> <p>OFF = la sortie est désactivée</p> <p>CV = la sortie est en mode de tension constante</p> <p>CC = la sortie est en mode de courant constant</p> <p>Unr = la sortie n'est pas régulée</p> <p>IPK+/- = la sortie se trouve dans la limite de courant de crête positive ou négative</p> <p>VL+/- = la sortie est en mode de limitation de tension positive ou négative</p> <p>CL+/- = la sortie est en mode de limitation de courant positive ou négative</p> <p>T-on = la sortie est activée</p> <p>T-off = la sortie est désactivée</p> <p>OV+/- = la sortie est désactivée par la protection contre les surtensions positives ou négatives</p> <p>OP+/- = la sortie est désactivée par la limite de surpuissance positive ou négative</p> <p>OC = la sortie est désactivée par la protection contre les surintensités</p> <p>OT = la sortie est désactivée par la protection contre les surchauffes</p> <p>PF = la sortie est désactivée par une panne d'alimentation</p> <p>Inh = la sortie est désactivée par un signal d'inhibition externe</p> <p>Prot = la sortie est désactivée par une condition de protection sur un autre appareil</p> <p>EDP = la sortie est désactivée par une protection contre les dynamiques de sortie excessives</p> <p>CSF = une erreur de partage de courant s'est produite</p> <p>PSP = une protection principale/secondaire s'est produite</p> <p>UV = la sortie est désactivée par la protection contre les sous-tensions</p> <p>LOV+/- = la tension de sortie a dépassé une limite interne positive ou négative</p> <p>DOV+/- = une tension appliquée par le DUT a dépassé la limite de tension positive ou négative</p> <p>OCF+/- = les limites internes de courant positives ou négatives sont dépassées : éventuellement en raison  d'une tension appliquée par un DUT qui a dépassé la limite de tension positive ou négative</p>
<b>Réglages de la tension et du courant</b>	Affiche la tension et le courant programmés. Il est possible que ces réglages ne correspondent pas à la tension ou au courant de sortie réel. Par exemple, dans le cas d'un mode en tension constante, la limite de courant peut être défini à 1 A, mais le courant de sortie réel doit être inférieur à 1 A pour que la sortie demeure en mode de tension constante. Si la limite de courant est atteinte, la sortie ne fonctionnera plus en mode de tension constante, mais en mode de limite de courant. Dans ce cas, la tension de sortie réelle sera maintenant inférieure au réglage de la tension.

## Zone d'état

Indique l'activité d'interface de commande à distance suivante :

Err = une erreur s'est produite (appuyez sur la touche Erreur pour afficher le message d'erreur)

Lan = le réseau local est connecté et a été configuré

IO = l'une des interfaces de programmation à distance est active

## Présentation succincte des touches du panneau avant

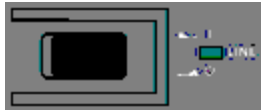

L'interrupteur marche/arrêt permet d'allumer ou d'éteindre l'appareil. Le voyant indique que le module est sous tension. Un voyant **vert** indique un fonctionnement normal. Un voyant **jaune** indique que l'écran est en mode écran de veille. Il est également jaune pendant le processus de démarrage. Appuyez sur une touche quelconque pour quitter le mode écran de veille.



Les touches de système permettent d'accéder aux menus de mesure et de commande du panneau avant suivants :

La touche Meter (Multimètre) renvoie l'affichage en mode appareil de mesure. Bascule également entre les mesures de courant et de puissance.

La touche Menu permet d'accéder au menu des commandes.

La touche Function (Fonction) est réservée à une utilisation future.

La touche Back (Précédent) permet de quitter un menu sans valider les modifications.

La touche Help (Aide) permet d'accéder à des informations sur la commande de menu affichée.

La touche Error (Erreur) permet d'afficher tous les messages d'erreurs de la file d'erreurs. L'affichage des erreurs efface la file d'attente des erreurs.

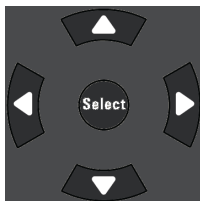

Les touches de navigation permettent d'effectuer les actions suivantes :

Les touches fléchées permettent de se déplacer dans les menus de commandes. Elles permettent également de sélectionner des caractères alphabétiques dans les champs de saisie alphanumériques.

La touche Select (Sélectionner) permet d'effectuer un choix dans les menus de commandes. Elle permet également d'activer le mode de modification des paramètres numériques.

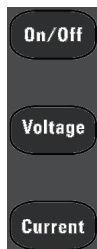

Les touches de sortie permettent d'effectuer les actions suivantes :

On/Off (Activer/Désactiver) contrôle la sortie.

La touche Voltage (Tension) vous permet de modifier le réglage de tension.

La touche Current (Courant) vous permet de modifier le réglage de courant.



Les touches du clavier numérique permettent d'effectuer les actions suivantes :

Les touches de 0 à 9 permettent de saisir des chiffres.

La touche (.) est le séparateur décimal.

La touche - permet de saisir un signe moins.

Les touches fléchées haut/bas permettent d'augmenter ou de diminuer les valeurs de tension ou de courant. Elles permettent également de sélectionner des lettres dans les champs de saisie alphabétique.

La touche E permet de saisir un exposant. Ajoutez la valeur à droite de la lettre E.

La touche de retour arrière permet de supprimer des chiffres et de les corriger.

La touche Enter permet de valider la saisie d'une valeur. Si vous quittez un champ sans avoir appuyé sur la touche Enter, la valeur est ignorée.

**REMARQUE**

Appuyez sur la touche Help (Aide) pour accéder à l'aide contextuelle.

## Aide-mémoire des menus du panneau avant

Appuyez sur la touche **Menu** pour accéder aux menus du panneau avant. Pour obtenir un bref didacticiel, reportez-vous à **Utilisation du menu du panneau avant**. Si une option du menu est grisée, elle n'est pas disponible pour le mode en cours de programmation.

Parmi les exemples de modes qui affectent les éléments du menu, on peut citer les fonctions Fixe, SAS et Principale/secondaire.

1er niveau du menu	2ème niveau	3ème et 4ème niveaux	Description	
<b>Output</b>	Voltage		Programme une la tension de sortie ou la limite de tension	
	Current		Programme le courant de sortie ou la limite de courant	
	Mode		Programme le mode de priorité de tension ou de courant et le mode de fonctionnement du SAS	
	SAS	Curve	Shape	Précise la forme de la courbe : spatiale ou terrestre
			Settings	Programme les paramètres de la courbe SAS : Imp, Isc, Vmp et Voc
		Table	Active l'un des tableaux chargés	
		Scale		Sélectionne un facteur d'échelle pour les courbes de courant et de tension
		Bandwidth		Programme la bande passante SAS
	Sequence	Delay		Programme le délai d'activation/de désactivation des sorties
		Couple		Configure le couplage des états de sortie
	Advanced	Slew	Current	Programme la vitesse de balayage du courant de sortie
			Voltage	Programme une vitesse de balayage de tension de sortie
		Resistance		Programme la résistance de sortie
		Bandwidth	Current	Programme la bande passante de courant
Voltage	Programme la bande passante de tension			
	Tmode		Programme les modes d'activation/de désactivation de la sortie	
<b>Measure</b>	Sweep		Configure l'échantillonnage de mesure	
	Window		Sélectionne une fenêtre de mesure	
	Control		Initialise, déclenche et interrompt les acquisitions ; affiche l'état de déclenchement	
	AhWh		Mesure ou réinitialise les ampères-heures et les watts-heures	
<b>Transient</b>	Mode		Sélectionne les modes de transitoire de tension et de courant	

1er niveau du menu	2ème niveau	3ème et 4ème niveaux	Description
	Step		Configure les paliers de tension ou de courant et les signaux de déclenchement
	List	Pace	Définit une liste de temps de palier ou de pas de déclenchement
		Repeat	Indique le nombre de répétitions de la liste ou une liste continue
		Terminate	Indique les conditions de terminaison de la liste
		Config	Configure les paramètres individuels des paliers de la liste
		Reset	Annule la liste et rétablit tous les paramètres correspondants
	Arb	Repeat	Indique le nombre de répétitions du signal arbitraire ou un signal arbitraire continu
		Terminate	Indique les conditions de terminaison du signal arbitraire
		Config	Configure les paramètres individuels du signal arbitraire
	TrigSource		Indique la source de déclenchement du transitoire et du signal arbitraire CD
	Control		Initialise, déclenche et interrompt les transitoires ; affiche l'état de déclenchement
<b>Protect</b>	OVP		Configure les paramètres de protection contre les surtensions
	UVP		Configure les paramètres de protection contre les sous-tensions
	OCP		Configure les paramètres de protection contre les surintensités
	Inhibit		Configure les paramètres du mode d'entrée d'inhibition
	WDog		Configure les paramètres de protection du temporisateur de surveillance de sortie
	Clear		Efface les conditions de protection et indique l'état de la sortie
<b>States</b>	Reset		Rétablit tous les réglages de l'instrument à l'état de réinitialisation (*RST)
	SaveRecall		Enregistre et rappelle les réglages de l'instrument
	PowerOn		Sélectionne l'état de mise sous tension de l'instrument
<b>System</b>	IO	LAN	Settings Affiche les paramètres réseau actuellement activés
			Modify Modifie la configuration du réseau (IP, Nom, DNS, mDNS, Services)
			Apply Applique les changements de configuration et redémarre l'appareil
			Cancel Annule les changements de configuration
			Reset Effectue une réinitialisation LXI LCI des paramètres LAN et redémarre l'appareil
			Defaults Rétablit les paramètres d'usine par défaut du réseau et redémarre l'appareil

## 1 Aide-mémoire

1er niveau du menu	2ème niveau	3ème et 4ème niveaux	Description
		USB	Affiche la chaîne d'identification USB
		GPIB	Affiche ou modifie l'adresse GPIB
		DigPort	Pins Configure les broches individuelles du port numérique
		Data	Lit/écrit les données vers le port numérique
	Groups	Fonction	Spécifie la fonction principale/secondaire
		Primary	Découvre et connecte le principal des appareils secondaires
		Secondary	Indique l'adresse secondaire
	Preferences	Horloge	Règle l'horloge du système
		Display	Configure le mode écran de veille et multimètre de démarrage
		Lock	Verrouille les touches du panneau avant à l'aide d'un mot de passe
	Admin	Login	Saisit un mot de passe pour accéder aux fonctions d'administration
		Cal	Vprog Étalonne la programmation de la tension
			Curr Étalonne la programmation et la mesure du courant
			Misc Étalonne la monnaie
		Count	Affiche le nombre de points d'étalonnage
		Date	Enregistre la date d'étalonnage
		Save	Enregistre les données d'étalonnage
		IO	Active/désactive les services USB, GPIB et LAN
		Sanitize	Effectue un effacement sécurisé NISPOM de toutes les données utilisateur
		Update	Met à jour le microprogramme avec une protection par mot de passe
		Password	Modifie le mot de passe Admin
	About		Affiche le modèle, les options, le numéro de série et la version du microprogramme

## Aide-mémoire des commandes

Certaines commandes [facultatives] ont été ajoutées à des fins de clarté. Toutes les commandes des paramètres correspondent à une requête. Voir la section **Conventions syntaxiques** du langage SCPI.

### ABORT

:ACQuire	Annule toutes les mesures déclenchées.
:ELOG	Arrête l'enregistrement de données externe.
:TRANsient	Annule les transitoires ou Arbs.

### CALibrate

:COUNT?	Renvoie le nombre de fois que l'appareil a été étalonné.
:CURRent	
[:LEVel] <valeur>	Étalonne la programmation et la mesure du courant.
:TC	Étalonne le coefficient de température.
:DATA <valeur>	Saisit la valeur d'étalonnage relevée sur le multimètre externe.
:DATE <"date">	Enregistre la date d'étalonnage dans la mémoire non volatile.
:LEVel P1 P2 P3	Passe au niveau d'étalonnage suivant.
:PASSword <valeur>	Définit un mot de passe numérique pour empêcher tout étalonnage non autorisé.
:SAVE	Enregistre les constantes d'étalonnage dans la mémoire non volatile.
:STATe 0 OFF 1 ON	Active ou désactive le mode d'étalonnage.
:VOLTage	
[:LEVel] <valeur>	Étalonne la programmation et la mesure de la tension locale.

### DISPlay

[:WINDow]	
[:STATe] 0 OFF 1 ON	Allume ou éteint l'écran du panneau avant.
:VIEW METER_VI METER_VP METER_VIP	Sélectionne les paramètres à afficher sur le panneau avant.
:SAVer	
[:STATe] 0 OFF 1 ON	Allume ou éteint l'écran de veille du panneau avant.

### FETCh

[:SCALar]	
:CURRent	
[:DC]? [<start_index>, <points>]	Renvoie la mesure moyenne.
:ACDC?	Renvoie la mesure de valeur efficace vraie (CA + CC).
:HIGH?	Renvoie le niveau élevé d'un signal d'impulsion.
:LOW?	Renvoie le niveau faible d'un signal d'impulsion.
:MAXimum?	Renvoie la valeur maximale.
:MINimum?	Renvoie la valeur minimale.
:POWer	
[:DC]?	Renvoie la mesure moyenne.
:MAXimum?	Renvoie la valeur maximale.
:MINimum?	Renvoie la valeur minimale.



## 1 Aide-mémoire

:VOLTage	
[:DC]? [<start_index>, <points>]	Renvoie la mesure moyenne.
:ACDC?	Renvoie la mesure de valeur efficace vraie (CA + CC).
:HIGH?	Renvoie le niveau élevé d'un signal d'impulsion.
:LOW?	Renvoie le niveau faible d'un signal d'impulsion.
:MAXimum?	Renvoie la valeur maximale.
:MINimum?	Renvoie la valeur minimale.
:AHOuR? [IGNORE_OVLD]	Renvoie les ampères-heures cumulés.
:ARRAY	
:CURRent	
[:DC]? [<start_index>, <points>]	Renvoie la mesure instantanée.
:POWer	
[:DC]? [<start_index>, <points>]	Renvoie la mesure instantanée.
:VOLTage	
[:DC]? [<start_index>, <points>]	Renvoie la mesure instantanée.
:ELOG <nbre max d'enregistrements>	Renvoie les enregistrements de données externes les plus récents.
:WHOuR? [IGNORE_OVLD]	Renvoie les watts-heures cumulés.

### FORMat

[:DATA] ASCII   REAL	Indique le format des données renvoyées.
:BORDER NORMAl   SWAPped	Indique comment les données binaires sont transférées.

### HCOPy

:SDUMp	
:DATA? [BMP GIF PNG]	Renvoie une image de l'écran du panneau avant.
:DATA	
:FORMat BMP GIF PNG	Spécifie le format des images du panneau avant renvoyées.

### Commandes courantes IEEE-488

*CLS	Commande d'effacement de l'état.
*ESE <valeur>	Commande et requête d'activation de l'état des événements.
*ESR?	Requête d'événement de l'état des événements.
*IDN?	Requête d'identification.
*OPC	Active le bit OPC (opération terminée) dans le registre des événements standard.
*OPC?	Renvoie la valeur 1 dans le tampon de sortie une fois toutes les opérations en attente terminées.
*OPT?	Renvoie une chaîne identifiant toutes les options installées.
*RCL <valeur>	Rappelle un état d'instrument enregistré.
*RST	Rétablit les valeurs prédéfinies de l'instrument qui sont des valeurs types ou sûres.
*SAV <valeur>	Enregistre l'état de l'instrument à l'un des dix emplacements de mémoire non volatile.
*SRE <valeur>	Commande et requête d'activation des demandes de service.
*STB?	Requête de l'octet d'état.
*TRG	Commande de déclenchement.
*TST?	Requête d'autotest.

\*WAI Interrompt momentanément le traitement des commandes supplémentaires jusqu'à ce que toutes les opérations en attente soient terminées.

## INITiate

[:IMMediate]  
 :ACQuire Démarre le système de déclenchement de mesure.  
 :ELOG Démarre l'enregistrement de données externe.  
 :TRANSient Démarre le système de déclenchement de transitoire.  
 :CONTinuous  
 :TRANSient 0|OFF|1|ON Démarre continuellement le système de déclenchement de transitoire.

## INSTrument

:GROup  
 :FUNCTion PRIMary|SECOndary|NONE Définit la fonction principale/secondaire  
 :PRIMary (Principale)  
 :CONNect  
 [:STATe] 0|OFF|1|ON Connecte le principal aux appareils secondaires précédemment découverts.  
 :DELay <délai> Indique un délai de connexion automatique après la mise sous tension.  
 :MODE AUTO|MANual Connexion automatique à la mise sous tension ou par commande.  
 :DISCover Découvre les appareils principaux connectés par bus  
 :RESet Réinitialise la configuration principale  
 :SECOndary  
 :ADDRes <adresse bus> Définit l'adresse du bus secondaire.

## LXI

:IDENTify  
 [:STATe] 0|OFF|1|ON Allume ou éteint le voyant d'identification LXI du panneau avant.  
 :MDNS  
 [:STATe] 0|OFF|1|ON Définit l'état MDNS.

## MEASure

[:SCALar]  
 :CURRent  
 [:DC]? Effectue une mesure ; renvoie le courant moyen.  
 :ACDC? Effectue une mesure ; renvoie le courant efficace vrai (CA + CC).  
 :HIGH? Effectue une mesure ; renvoie le niveau élevé d'une impulsion de courant.  
 :LOW? Effectue une mesure ; renvoie le niveau faible d'une impulsion de courant.  
 :MAXimum? Effectue une mesure ; renvoie le courant maximal.  
 :MINimum? Effectue une mesure ; renvoie le courant minimal.  
 :POWer  
 [:DC]? Effectue une mesure ; renvoie la puissance moyenne.  
 :MAXimum? Effectue une mesure ; renvoie la puissance maximale.  
 :MINimum? Effectue une mesure ; renvoie la puissance minimale.

## 1 Aide-mémoire

:VOLTage	
[:DC]?	Effectue une mesure ; renvoie la tension moyenne.
:ACDC?	Effectue une mesure ; renvoie la tension efficace vraie (CA + CC).
:HIGH?	Effectue une mesure ; renvoie le niveau élevé d'une impulsion de tension.
:LOW?	Effectue une mesure ; renvoie le niveau faible d'une impulsion de tension.
:MAXimum?	Effectue une mesure ; renvoie la tension maximale.
:MINimum?	Effectue une mesure ; renvoie la tension minimale.
:ARRAY	
:CURREnt [:DC]?	Effectue une mesure ; renvoie le courant instantané.
:POWEr[:DC]?	Effectue une mesure ; renvoie la puissance instantanée.
:VOLTage [:DC]?	Effectue une mesure ; renvoie la tension instantanée.

## OUTPut

[:STATe] 0 OFF 1 ON	Active ou désactive la sortie.
:COUPle	
[:STATe] 0 OFF 1 ON	Active ou désactive la fonction de couplage des sorties.
:DOffset <valeur>	Définit un décalage de délai pour synchroniser les modifications de l'état de sortie couplé.
:MAX	
:DOffset?	Renvoie le décalage de délai requis pour cet instrument.
:DELay	
:FALL <valeur>	Règle le délai de la séquence de désactivation de la sortie.
:RISE <valeur>	Règle le délai de la séquence d'activation de la sortie.
:TMODE	
:COUPle 0 OFF 1 ON	Couple les réglages d'activation et de désactivation.
[:OFF] LOWZ HIGHZ	Sélectionne le mode de désactivation de la sortie.
:ON LOWZ HIGHZ	Sélectionne le mode de mise sous tension de la sortie.
:INHibit	
:MODE LATCHing LIVE OFF	Définit le mode de fonctionnement de la broche numérique d'inhibition à distance.
:PON	
:STATe RST RCL0	Définit la configuration de mise sous tension de la sortie.
:PROTection	
:CLEar	Réinitialise la protection verrouillée.
:TEMPerature	
:MARGin?	Renvoie la marge restante avant les déclenchements en surchauffe.
:WDOG	
[:STATe] 0 OFF 1 ON	Active ou désactive le temporisateur de surveillance des E/S.
:DELay <valeur>	Définit le délai de surveillance.

## SENSe

:AHOuR	
:RESet	Réinitialise la mesure en ampères-heures ou en watts-heures à zéro.
:ELOG	
:FUNcTion	

:CURRent 0 OFF 1 ON	Active ou désactive l'enregistrement du courant externe.
:MINMax 0 OFF 1 ON	Active ou désactive l'enregistrement du courant min/max.
:VOLTage 0 OFF 1 ON	Active ou désactive l'enregistrement externe de la tension externe.
:MINMax 0 OFF 1 ON	Active ou désactive l'enregistrement de la tension min/max.
:PERiod <valeur>	Règle le temps d'intégration de l'enregistrement externe.
:FUNction	
:CURRent 0 OFF 1 ON	Active ou désactive les mesures de courant.
:VOLTage 0 OFF 1 ON	Active ou désactive les mesures de tension.
:SWEep	
:NPLCycles <valeur>	Définit le temps de mesure en nombre de cycles de tension d'alimentation.
:OFFSet	
:POINts <valeur>	Définit le décalage d'un balayage de données pour les mesures déclenchées.
:POINts <valeur>	Définit le nombre de points d'une mesure.
:TINTerval <valeur>	Définit la période qui s'écoule entre les échantillons de mesure.
:WHOUr	
:RESet	Réinitialise la mesure des watts-heures cumulés.
:WINDow	
[TYPE] HANNing RECTangular	Sélectionne la fenêtre de mesure.

## [SOURce:]

**ARB**

:COUNT <valeur> INfinity	Indique le nombre de répétitions du signal arbitraire.
:CURRent	
:CDWell	
[:LEVel] <valeur>{,<valeur>}<Bloc>	Indique le temps de chaque point dans le signal arbitraire.
:DWELL <valeur>	Indique le temps de palier de chaque point dans le signal arbitraire.
:POINts?	Renvoie le nombre de points dans le signal arbitraire.
:FUNction	
:TYPE CURRent VOLTage	Indique un signal arbitraire de tension ou de courant.
:TERMinate	
:LAST 0 OFF 1 ON	Sélectionne le réglage de sortie à la fin du signal arbitraire.
:VOLTage	
:CDWell	
[:LEVel] <valeur>{,<valeur>}<Bloc>	Indique le temps de chaque point dans le signal arbitraire.
:DWELL <valeur>	Indique le temps de palier de chaque point dans le signal arbitraire.
:POINts?	Renvoie le nombre de points dans le signal arbitraire.

## [SOURce:]

**CURRent**

[:LEVel]	
[:IMMediate]	
[:AMPLitude] <valeur>	Définit le courant de sortie en mode de priorité de courant.
:TRIGgered	
[:AMPLitude] <valeur>	Définit le courant de sortie déclenché.

## 1 Aide-mémoire

:BWiDth	
:LEVel 0, <valeur>	Définit la fréquence de compensation.
:LiMit	
[:POSitive]	
[:IMMediate]	
[:AMPLitude] <valeur>	Définit la limite de courant en mode de priorité de tension.
:NEGative	
[:IMMediate]	
[:AMPLitude] <valeur>	Définit la limite de courant en mode de priorité de tension.
:MODE FIXed STEP LIST ARB	Définit le mode de transitoire.
:PROTection	
:DELay	
[:TIME] <valeur>	Définit le délai de protection contre les surintensités.
:STARt SCHange CCTRans	Indique l'événement déclencheur du temporisateur de protection contre les surintensités.
:STATe 0 OFF 1 ON	Active ou désactive la fonction de protection contre les surintensités.
:SLEW	
[:IMMediate] <valeur> INFinity	Définit la vitesse de balayage du courant.
:MAXimum 0 OFF 1 ON	Active ou désactive le remplacement de la vitesse de balayage maximale.

[SOURce:]

### DIGital

:INPut	
:DATA?	Lit l'état du port de commande numérique.
:OUTPut	
:DATA <valeur>	Définit l'état du port de commande numérique.
:PIN<1-7>	
:FUNcTion <fonction>	Définit la fonction de la broche. DIO DINPut FAULt INHibit ONCouple OFFCouple TOUTput TINPut
:POLarity POSitive NEGative	Définit la polarité de la broche.
:TOUtput	
:BUS	
[:ENABle] 0 OFF 1 ON	Active ou désactive les déclencheurs BUS sur les broches du port numérique.

[SOURce:]

**FUNcTion** CURRent|VOLTage      Définit la régulation de sortie : priorité de tension ou priorité de courant.

[SOURce:]

### LIST

:COUnT <valeur> INFinity	Définit le nombre de répétitions de la liste.
:CURRent	
[:LEVel] <valeur>{,<valeur>}	Indique le réglage de chaque palier de liste.
:POINts?	Renvoie le nombre de points de courant.
:DWELL <valeur>{,<valeur>}	Indique la durée de chaque palier de liste.

:POINTS?	Renvoie le nombre de points de palier.
:STEP ONCE AUTO	Spécifie le rythme de déclenchement ou de palier.
:TERMinate	
:LAST 0 OFF 1 ON	Détermine la valeur de sortie lorsque la liste s'arrête.
:TOUtput	
:BOSTep	
: [DATA] <Booléen>{,<Booléen>}	Génère un signal de sortie de déclenchement en début de palier (Beginning Of Step).
:POINTS?	Renvoie le nombre de points de la liste BOST (fin de palier).
:EOSTep	
: [DATA] <Booléen>{,<Booléen>}	Génère un signal de sortie de déclenchement en fin de palier (End Of Step).
:POINTS?	Renvoie le nombre de points de la liste EOST (fin de palier).
:VOLTage	
: [LEVel] <valeur>{,<valeur>}	Indique le réglage de chaque palier de liste.
:POINTS?	Renvoie le nombre de points de tension.

[SOURce:]

**POWer**

:LIMit? Renvoie la limite de puissance de sortie de l'instrument.

[SOURce:]

**SASimulator**

:ACTive	
:MPP	
:CURRent?	Renvoie le courant au point de puissance maximum.
:POWer?	Renvoie le point de puissance maximum.
:VOLTage?	Renvoie la tension au point de puissance maximum.
:BWIDth	
:RANGe 0   1	Définit la compensation SAS.
:CURve	
:IMP <valeur>	Règle le courant au point de puissance maximum de la courbe.
:ISC <valeur>	Règle le courant de court-circuit.
:SHApe SPACe TERRestrial	Définit la forme de la courbe.
:VMP <valeur>	Règle la tension au point de puissance maximum de la courbe.
:VOC <valeur>	Règle la tension en circuit ouvert.
:MODE FIXed CURVe TABLe	Définit le mode de fonctionnement de l'appareil.
:SCALe	
:CURRent <valeur>	Définit un facteur d'échelle pour la courbe dans les modes SAS et Tableau.
:VOLTage <valeur>	Définit un facteur d'échelle pour la courbe dans les modes SAS et Tableau.
:TABLe	
:ACTivate 1 2	Charge et exécute le tableau créé à l'aide des commandes MEMory.
:SElect 1 2	Exécute l'un des deux tableaux qui ont été chargés.

## 1 Aide-mémoire

:UPDate 1 2	Met à jour un tableau.
:TABLe[1 2]	
:CURRent	
[:AMPLitude] <valeur>{,<valeur>}	Programme une liste de points de courant en mode Tableau.
:POINts?	Renvoie le nombre de points de courant dans le tableau de courant.
:VOLTag	
[:AMPLitude] <valeur>{,<valeur>}	Programme une liste de points de tension en mode tableau.
:POINts?	Renvoie le nombre de points de courant dans le tableau de tension.

[SOURce:]

### STEP

:TOUtput 0|OFF|1|ON Indique si une sortie de déclenchement est générée lorsqu'un palier de transitoire se produit.

[SOURce:]

### VOLTag

:LEVel	
[:IMMediate]	
[:AMPLitude] <valeur>	Définit la tension de sortie en mode de priorité de tension.
:TRIGgered	
[:AMPLitude] <valeur>	Règle la tension de sortie déclenchée.
:BWIDth	
:LEVel 0   1   2, <valeur>	Définit la fréquence de compensation.
:RANGe 0   1   2	Définit la plage de compensation de tension.
:LIMit	
[:POSitive]	
[:IMMediate]	
[:AMPLitude] <valeur>	Définit la limite de tension en mode de priorité de courant.
:LOW <valeur>	Définit la limite basse de tension.
:STATe 0 OFF 1 ON	Active ou désactive la limite de sous-tensions.
:MODE FIXed STEP LIST ARB	Définit le mode de transitoire.
:PROTection	
[:LEVel] <valeur>	Règle le niveau de protection contre les surtensions.
:LOW	
[:LEVel] <valeur>	Définit le niveau de protection contre les sous-tensions.
:DELay <valeur>	Définit le délai de protection contre les sous-tensions.
:STATe 0 OFF 1 ON	Active ou désactive la protection contre les surtensions.
:RESistance	
[:LEVel]	
[:IMMediate]	
[:AMPLitude] <valeur>	Définit le niveau de résistance de sortie.
:STATe 0 OFF 1 ON	Active ou désactive la programmation de résistance de sortie.
:SLEW	
[:IMMediate] <valeur> INFinity	Définit la vitesse de balayage de tension.
:MAXimum 0 OFF 1 ON	Active ou désactive le remplacement de la vitesse de balayage maximale.

**STATus**

:OPERation	
[:EVENT]?	Effectue une recherche dans le registre des événements de fonctionnement.
:CONDition?	Effectue une recherche dans le registre des conditions de fonctionnement.
:ENABle <valeur>	Définit le registre d'activation du fonctionnement.
:NTRansiton <valeur>	Règle le filtre de transition négative.
:PTRansiton <valeur>	Règle le filtre de transition positive.
:PRESet	Prédéfini tous les registres d'activation, PTR et NTR.
:QUEStionable <1 2>	
[:EVENT]?	Effectue une recherche dans le registre des événements suspects.
:CONDition?	Effectue une recherche dans le registre des conditions suspects.
:ENABle <valeur>	Définit le registre d'activation suspect.
:NTRansiton <valeur>	Règle le filtre de transition négative.
:PTRansiton <valeur>	Règle le filtre de transition positive.

**SYSTem**

:COMMunicate	
:LAN TCPip:CONTRol?	Renvoie le numéro de port de connexion par socket de contrôle initial.
:RLState LOCal REMOte RWLock	Configure la configuration distante/locale de l'instrument.
:DATE <aaaa>, <mm>, <jj>	Règle la date de l'horloge système.
:ERRor?	Lit et efface une erreur dans la file d'erreurs.
:PASSword	
:FPANel	
:RESet	Réinitialise le mot de passe de verrouillage du panneau avant à zéro.
:REBoot	Redémarre l'instrument à son état de mise sous tension.
:SECurity	
:IMMediate	Efface toute la mémoire utilisateur et redémarre l'instrument.
:SET <données de bloc>	Obtient et définit l'état de l'instrument.
:TIME <hh>, <mm>, <ss>	Règle l'heure de l'horloge système.
:VERSion?	Renvoie la version SCPI à laquelle l'instrument est conforme.

**TRIGger**

:ACQUIRE	
[:IMMediate]	Génère un événement de déclenchement immédiat.
:CURRent	
[:LEVel] <valeur>	Définit le niveau déclenché de la sortie.
:SLOPe POSitive NEGative	Définit la pente du signal.
:INDices	
[:DATA]?	Renvoie les indices où les déclenchements ont été capturés.
:COUNT?	Renvoie le nombre de déclenchements capturés pendant l'acquisition.
:SOURce <source>	Définit la source de déclenchement : BUS CURRent1 EXTernal PIN<1-7> TRANSient1 VOLTage1
:TOUTput	



## 1 Aide-mémoire

[:ENABle]	Active les déclencheurs de mesure à envoyer à une broche de port numérique.
:VOLTagE	
[:LEVel] <valeur>	Définit le niveau déclenché de la sortie.
:SLOPe POSitive NEGative	Définit la pente du signal.
:ARB	
:SOURce <source>	Sélectionne la source de déclenchement des signaux arbitraires : BUS  EXTernal  IMMediate  PIN<1-7>
:ELOG	
[:IMMediate]	Génère un événement de déclenchement immédiat.
:SOURce <source>	Sélectionne la source de déclenchement de l'enregistrement de données externe : BUS  EXTernal  IMMediate  PIN<1-7>
:TRANsient	
[:IMMediate]	Génère un événement de déclenchement immédiat.
:SOURce <source>	Sélectionne la source de déclenchement de transitoire : BUS  EXTernal  IMMediate  PIN<1-7>

## Fonctionnalités et options des modèles

### Fonctionnalités des modèles

Fonctionnalité	RP7972A	RP7973A	RP7982A	RP7983A	RP7984A
Valeurs nominales de tension, courant et puissance	0 à 1000 V 0 à ±60 A ±20 kW	0 à 2000 V 0 à ±30 A ±20 kW	0 à 1000 V 0 à ±90 A ±30 kW	0 à 2000 V 0 à ±30 A ±30 kW	0 à 1500 V 0 à ±60 A ±30 kW
Fonctionnement par absorption/sur source à 2 quadrants	Source 60 A Absorption -60 A	Source 30 A Absorption -30 A	Source 90 A Absorption -90 A	Source 30 A Absorption -30 A	Source 60 A Absorption -60 A
Fonctionnement photovoltaïque	Oui	Oui	Oui	Oui	Oui
Commutation automatique de plage de sortie	Oui	Oui	Oui	Oui	Oui
Entrée triphasée, 380-480 V CA L-à-L	Oui	Oui	Oui	Oui	Oui
Listes de sortie	Oui	Oui	Oui	Oui	Oui
Signaux arbitraires	Oui	Oui	Oui	Oui	Oui
Largeur de bande réglable	V, I, et vérification de performances	V, I, et vérification de performances	V, I, et vérification de performances	V, I, et vérification de performances	V, I, et vérification de performances
Principal/secondaire	Oui	Oui	Oui	Oui	Oui
Programmation de la tension et du courant	Oui	Oui	Oui	Oui	Oui
Programmation de la résistance de sortie	Oui	Oui	Oui	Oui	Oui
Mesure de la tension et du courant	Oui	Oui	Oui	Oui	Oui
Mesure Ampères-heures, Watts-heures et puissance	Oui	Oui	Oui	Oui	Oui
Relecture de tableau	Oui	Oui	Oui	Oui	Oui
Échantillonnage réglable	Oui	Oui	Oui	Oui	Oui
Enregistrement de données externe	Oui	Oui	Oui	Oui	Oui
Protection contre les sous-tensions	Oui	Oui	Oui	Oui	Oui
Déconnexion de la sortie statique	Oui	Oui	Oui	Oui	Oui

## Options/Accessoires

Option/Accessoire	Description
Option UK6	Étalonnage commercial avec données des résultats de test
Keysight 1CP108A	Kit de montage en baie avec poignées : à utiliser avec RP7972A, RP7973A
Keysight 1CP120A	Kit de montage en baie avec poignées : à utiliser avec RP7982A, RP7983A, RP7984A
Keysight RP7908A	Rails pour baies Keysight ou de conception similaire
Keysight <b>DG9000</b>	Logiciel de test des onduleurs PV avancés/à entrées multiples pour un maximum de 12 instruments
Keysight <b>BV9200B/BV9201B</b>	Fonctionnalités avancées de recherche et de mesure pour un seul instrument ou jusqu'à quatre instruments

## Spécifications et caractéristiques

### Spécifications

### Caractéristiques supplémentaires

### Caractéristiques communes

### Efficacité de l'entrée CA, facteur de puissance et DHT

### Graphiques des impédances de sortie

### Limite de charge inductive pour un fonctionnement en courant constant (CC)

### Limite de charge capacitive pour un fonctionnement en tension constante (CV)

### Précision et résolution de la mesure

### Protection dynamique excessive

### Quadrants d'entrée

## Spécifications

Sauf indication contraire, les spécifications sont garanties sur la plage de température ambiante comprise entre 0 et 40 °C après un délai de préchauffage de 30 minutes. Les spécifications s'appliquent aux terminaux de sortie, avec détection locale.

Spécifications	RP7972A	RP7973A	RP7982A	RP7983A	RP7984A
Valeurs nominales en courant continu					
Source de tension :	0 à 1000 V	0 à 2000 V	0 à 1000 V	0 à 2000 V	0 à 1500 V
Source et absorption de courant :	0 à ±60 A	0 à ±30 A	0 à ±90 A	0 à ±30 A	0 à ±60 A
Puissance :	0 à ±20 kW	0 à ±20 kW	0 à ±30 kW	0 à ±30 kW	0 à ±30 kW
Ondulation et bruit de sortie					
Valeur crête à crête en mode CV : <sup>1</sup>	1,5 V	3 V	1,5 V	3 V	2,25 V
Valeur efficace en mode CV : <sup>2</sup>	200 mV	400 mV	200 mV	400 mV	300 mV
Régulation de charge					
Voltage (Tension) : <sup>3</sup>	50 mV	100 mV	50 mV	100 mV	75 mV
Current (Courant) :	8 mA	4 mA	12 mA	4 mA	8 mA
Précision de programmation et de mesure de la tension : <sup>4</sup>					
	0,04% + 75 mV	0,04% + 150 mV	0,03% + 75 mV	0,03% + 150 mV	0,03% + 100 mV
Précision de programmation et de mesure du courant : <sup>4</sup>					
	0,03% + 6 mA	0,03% + 3 mA	0,03% + 9 mA	0,03% + 3 mA	0,03% + 6 mA
Réponse transitoire <sup>5</sup>					
Temps de récupération :	300 µs	300 µs	300 µs	300 µs	300 µs
Bande de stabilisation :	10 V	20 V	10 V	20 V	15 V

<sup>1</sup> De 20 Hz à 20 MHz (bande passante de -3dB) avec charge résistive, bornes non raccordées à la masse ou bornes raccordées à la masse

<sup>2</sup> De 20 Hz à 10 MHz (bande passante de -3dB) avec charge résistive, bornes non raccordées à la masse ou bornes raccordées à la masse

<sup>3</sup> S'applique également à la mesure à distance avec une chute de tension  $\leq 1$  V par fil de charge : voir [Section des fils](#) et [Connexions de mesure à distance](#) pour plus d'informations.

<sup>4</sup> Pourcentage de valeur + décalage à 25°C  $\pm 5$  °C après un délai de préchauffage de 30 minutes ; NPLC de mesure = 1 ; valide pendant 1 an. Voir [Intervalle d'étalonnage](#);

avec une chute de tension  $\leq 1$  V par fil de charge : voir [Section des fils](#) pour des informations sur la chute de tension des fils de charge

## 1 Aide-mémoire

supplémentaires

5 Temps nécessaire pour revenir à la bande de stabilisation après une variation de palier de 40 à 90 % et de 90 à 40 % de la charge totale à Comp  
0 avec temps de montée et de descente du courant de 40  $\mu$ s)

## Caractéristiques supplémentaires

Les caractéristiques supplémentaires ne sont pas garanties, mais décrivent les performances déterminées par définition ou par test type. Les caractéristiques supplémentaires sont standard, sauf indication contraire.

Caractéristique	RP7972A	RP7973A	RP7982A	RP7983A	RP7984A
Programmation de la tension					
Plage :	+1 V à +1020 V	+2 V à +2040 V	+1 V à +1020 V	+2 V à +2040 V	+1,5 V à +1530 V
Résolution :	10 mV	20 mV	10 mV	20 mV	15 mV
Programmation du courant					
Plage :	-61,2 A à +61,2 A	-30,6 A à +30,6 A	-91,8 A à +91,8 A	-30,6 A à +30,6 A	-61,2 A à +61,2 A
Résolution :	1,2 mA	0,6 mA	1,8 mA	0,6 mA	1,2 mA
Programmation de la résistance					
Plage :	0 à 69 $\Omega$	0 à 277 $\Omega$	0 à 43,8 $\Omega$	0 à 394 $\Omega$	0 à 98,6 $\Omega$
Résolution :	0,55 m $\Omega$	2,2 m $\Omega$	0,4 m $\Omega$	3,2 m $\Omega$	0,8 m $\Omega$
Précision :	0,06% + 0,55 m $\Omega$	0,06% + 2,2 m $\Omega$	0,05% + 0,4 m $\Omega$	0,05% + 3,2 m $\Omega$	0,05% + 0,8 m $\Omega$
Plage de mesure					
Voltage (Tension) :	0 à 1200 V	0 à 2400 V	0 à 1200 V	0 à 2400 V	0 à 1800 V
Current (Courant) :	-153 A à 153 A	-76,5 A à 76,5 A	-229,5 A à 229,5 A	-76,5 A à 76,5 A	-153 A à 153 A
Programmation et mesure tempCo/°C <sup>1</sup>					
Voltage (Tension) :	0,002 % + 7 mV	0,002 % + 14 mV	0,002 % + 7 mV	0,002 % + 14 mV	0,002 % + 7 mV
Current (Courant) :	0,005 % + 240 $\mu$ A	0,005 % + 120 $\mu$ A	0,005 % + 360 $\mu$ A	0,005 % + 120 $\mu$ A	0,005 % + 240 $\mu$ A
Ondulation et bruit de sortie (de 20 Hz à 20 MHz)					
Valeur efficace en mode CC :	30 mA	15 mA	30 mA	15 mA	30 mA
Courant de mode commun					
Valeur efficace vraie :	2,5 mA	2,5 mA	2,5 mA	2,5 mA	2,5 mA
Crête à crête :	30 mA	30 mA	30 mA	30 mA	30 mA
Protection contre les surtensions					
Réglage maximal :	1200 V	2400 V	1200 V	2400 V	1800 V
Précision :	0,04% + 75 mV	0,04% + 150 mV	0,03% + 75 mV	0,03% + 150 mV	0,02% + 150 mV
Temps de réponse : <sup>2</sup>	< 30 $\mu$ s	< 30 $\mu$ s	< 30 $\mu$ s	< 30 $\mu$ s	< 30 $\mu$ s
Programmation amont ou aval de tension, comp 0 <sup>3</sup>					
Temps de montée/descente de 10% à 90% du palier :	0,2 ms	0,2 ms	0,2 ms	0,2 ms	0,2 ms
Temps d'établissement à 0,1% du palier :	1 ms	1 ms	1 ms	1 ms	1 ms
Programmation amont ou aval de tension, comp 1 <sup>3</sup>					
Temps de montée/descente de 10% à 90% du palier :	0,5 ms	0,5 ms	0,5 ms	0,5 ms	0,5 ms
Temps d'établissement à 0,1% du palier :	2,5 ms	2,5 ms	2,5 ms	2,5 ms	2,5 ms
Programmation amont ou aval de tension, comp 2 <sup>3</sup>					
Temps de montée/descente de 10% à 90% du palier :	33 ms	33 ms	33 ms	33 ms	33 ms
Temps d'établissement à 0,1% du palier :	110 ms	110 ms	110 ms	110 ms	110 ms

## 1 Aide-mémoire

Caractéristique	RP7972A	RP7973A	RP7982A	RP7983A	RP7984A
Programmation amont ou aval du courant, comp 0 <sup>4</sup>	100 µs	100 µs	100 µs	100 µs	100 µs
Temps de montée/descente de 10% à 90% du palier :	200 µs	200 µs	200 µs	200 µs	200 µs
Temps d'établissement à 1% du palier :					
Sortie selon le délai de temporisation <sup>5</sup>					
Priorité de tension - impédance élevée :	8,1 ms	8,1 ms	8,1 ms	8,1 ms	8,1 ms
Priorité de tension - faible impédance :	8,1 ms	8,1 ms	8,1 ms	8,1 ms	8,1 ms
Priorité de courant :	7,1 ms	7,1 ms	7,1 ms	7,1 ms	7,1 ms
Inductance en charge maximale : <sup>6</sup>	185 µH	740 µH	80 µH	490 µH	490 µH
Régulation de secteur					
Tension et courant :	Voir la note <sup>7</sup>	Voir la note <sup>7</sup>	Voir la note <sup>7</sup>	Voir la note <sup>7</sup>	Voir la note <sup>7</sup>
Courant de fuite typique					
Sortie désactivée, ou débranchée de l'alimentation secteur :	0,75 mA	0,75 mA	0,4 mA	0,4 mA	1 mA
Résistance de purge					
Terminal +/- à la terre du châssis :	68 MΩ	68 MΩ	68 MΩ	68 MΩ	68 MΩ

<sup>1</sup> Valable pour des températures ambiantes supérieures à 30°C ou inférieures à 20°C

<sup>2</sup> Entre l'occurrence d'une surtension et le début de l'arrêt

<sup>3</sup> Avec une charge nulle et une variation de palier comprise entre 0,1 % et 100 % de la valeur de la tension nominale ; fréquence de la bande passante = 100 kHz

<sup>4</sup> Avec un courant alternatif court et un palier > 10 % de la tension de sortie nominale ; fréquence de la bande passante = 100 kHz

<sup>5</sup> Temps entre la réception de la commande d'activation de sortie et le début de l'activation de la sortie

<sup>6</sup> **ATTENTION** L'appareil est susceptible d'être endommagé à l'intérieur si les limites d'inductance de charge maximale sont dépassées en courant nominal.

<sup>7</sup> En raison des circuits de pré-régulation dans l'appareil, la régulation de secteur n'est pas mesurable

## Caractéristiques communes

Caractéristique commune	Tous les modèles
Temps de traitement des commandes	≤ 1 ms entre la réception de la commande et le début du changement de la sortie. S'applique aux commandes de paramètres simples sur l'interface GPIB (voir <b>Temps de traitement de commande type</b> )
Signaux arbitraires à palier constant	Jusqu'à 65 535
Nombre de points :	Un paramètre de temporisation s'applique à l'ARB entier, de 10,24 µs à 0,30 seconde
Plage de temporisation :	Les valeurs sont arrondies à l'incrément de 10,24 microsecondes le plus proche
Résolution de temporisation :	
Interfaces informatiques	
Version LXI :	Spécification de l'appareil LXI 1.5 2016
Fonctions LXI étendues :	Découverte et identification des appareils LXI IPv6, LXI HiSLIP, LXI VXI VXI-11
LAN :	LAN 10 Mb, 100 Mb, 1 Gb
USB :	USB 2.0 (protocole USB-TMC488)
GPIB :	Interface conforme SCPI - 1993, IEEE 488.2

Caractéristique commune	Tous les modèles
<b>Port numérique</b>	
Tension nominale max. :	+16,5 V CC/- 5 V CC entre les broches
Broches 1 et 2 en tant que sortie de défaillance :	Tension de sortie de niveau faible maximale = 0,5 V à 4 mA Courant absorbé de niveau faible maximal = 4 mA Courant de fuite de niveau élevé type = 1 mA à 16,5 V CC
Broches 1-7 en tant que sorties :	Tension de sortie de niveau faible maximale = 0,5 V à 4 mA ; 1 V à 50 mA ; 1,75 V à 100 mA Courant absorbé de niveau faible maximal = 100 mA Courant de fuite de niveau élevé type = 0,8 mA à 16,5 V CC
Broches 1-7 en tant qu'entrées :	Tension d'entrée de niveau faible maximale = 0,8 V Tension d'entrée de niveau élevé minimale = 2 V Courant de niveau faible type = 2 mA à 0 V (résistance interne 2,2 k) Courant de fuite de niveau élevé type = 0,12 mA à 16,5 V CC
Broche 8 :	La broche 8 est commune (connectée en interne à la masse du châssis)
<b>Déclaration acoustique</b> (Directive européenne relative aux machines)	
	Émission de bruit acoustique LpA 80,92 dB à l'emplacement de l'utilisateur : <sup>1</sup> LpA 75,57 dB à proximité LpA 62,04 à la vitesse du ventilateur inactif Mode de fonctionnement normal conforme à la norme ISO 7779
<b>Conditions environnementales</b>	
Conditions de fonctionnement :	Utilisation interne, catégorie d'installation III, degré de pollution 2
Plage de températures :	0 à 55 °C (le courant continu maximal est déclassé à 1 % de la puissance nominale par degré C entre 40 et 55 °C)
Humidité relative :	95% au maximum (sans condensation)
Altitude :	Jusqu'à 2 000 mètres
Température de stockage :	-30 à 70°C
<b>Conformité réglementaire</b>	
CEM :	Conforme à la directive CEM relative aux produits de test et de mesure. Conforme à la norme Australienne et porte la marque C-Tick. Cet appareil ISM est conforme à la norme ICES-001 du Canada. Cet appareil ISM est conforme à la norme NMB-001 du Canada.
Sécurité :	Conforme à la directive basse tension européenne et porte la marque CE. Conforme aux réglementations de sécurité américaines et canadiennes.  Vous pouvez télécharger sur Internet les déclarations de conformité concernant ce produit. Accédez à la page <a href="http://www.keysight.com/go/conformity">http://www.keysight.com/go/conformity</a> et cliquez sur Déclarations de conformité.
<b>Entrée secteur</b>	
Connexions :	L1, L2, L3, N, PE (ceci nécessite une connexion neutre)
Phase et plage :	Entrée triphasée, 380-480 V CA, valeur nominale, ligne à ligne ±10 %
Fréquence :	50/60 Hz
VA en entrée :	23 kVA pour les modèles de 20 kW, 34 kVA pour les modèles de 30 kW
Courant d'entrée par phase :	36 A pour les modèles de 20 kW, 52 A pour les modèles de 30 kW
Efficacité à pleine puissance :	90%
Facteur de puissance :	0,99 @ entrée nominale et puissance nominale



## 1 Aide-mémoire

Caractéristique commune	Tous les modèles
Isolation des bornes de sortie pour les appareils de 1 kV : pour les appareils de 1,5 kV et 2 kV :	Aucune borne de sortie ne doit être soumise à une tension de plus de $\pm 1\,000$ V CC par rapport à une autre borne ou à la masse du châssis Aucune borne de sortie ne doit être soumise à une tension de plus de $\pm 2\,000$ V CC par rapport à une autre borne ou à la masse du châssis
Poids type	82 livres. (37,3 kg) pour les modèles de 20 kW 126 livres. (57,2 kg) pour les modèles de 30 kW
Dimensions	Voir les <b>schémas de principe</b> pour plus de détails

<sup>1</sup> Un niveau de pression acoustique de 80 dBA au-dessus d'une pression acoustique de référence de 20  $\mu$ Pa est actuellement considéré par les autorités comme le seuil à partir duquel il y a un risque pour la santé. Des moyens spéciaux, tels que l'utilisation d'écouteurs de protection, peuvent rendre un niveau supérieur non dangereux pour un opérateur.

## Efficacité de l'entrée CA, facteur de puissance et DHT

Les graphiques suivants fournissent des détails supplémentaires sur l'efficacité de l'entrée CA, le facteur de puissance et la distorsion harmonique totale sur toute la gamme de puissance de l'instrument.

Pour les modèles de 20 kW RP7972A, RP7973A

Efficacité de la source/de l'absorption

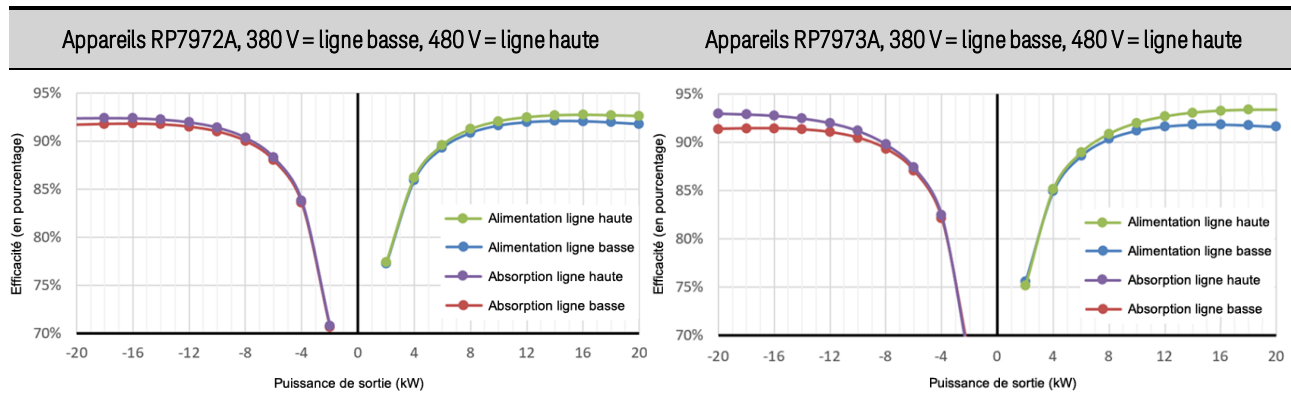

Facteur de puissance

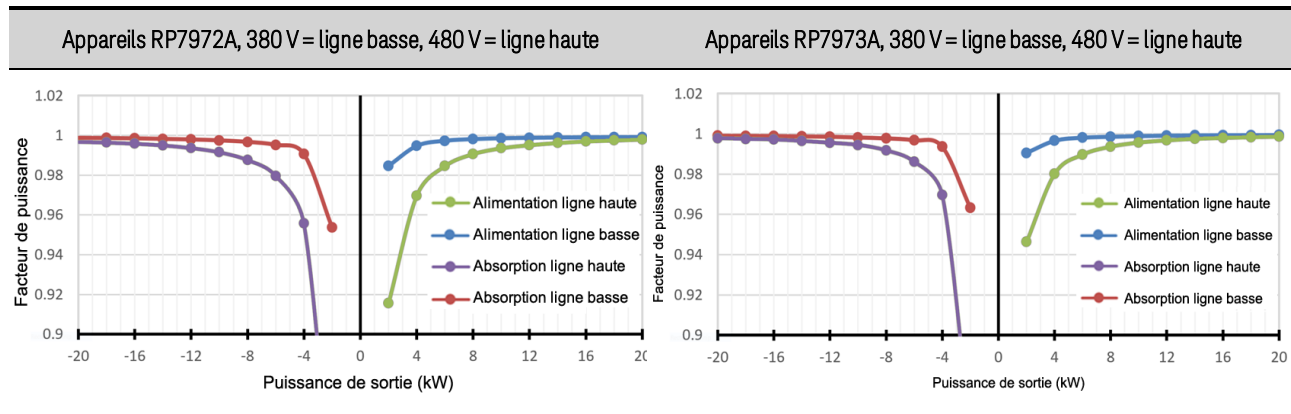

Distorsion harmonique totale

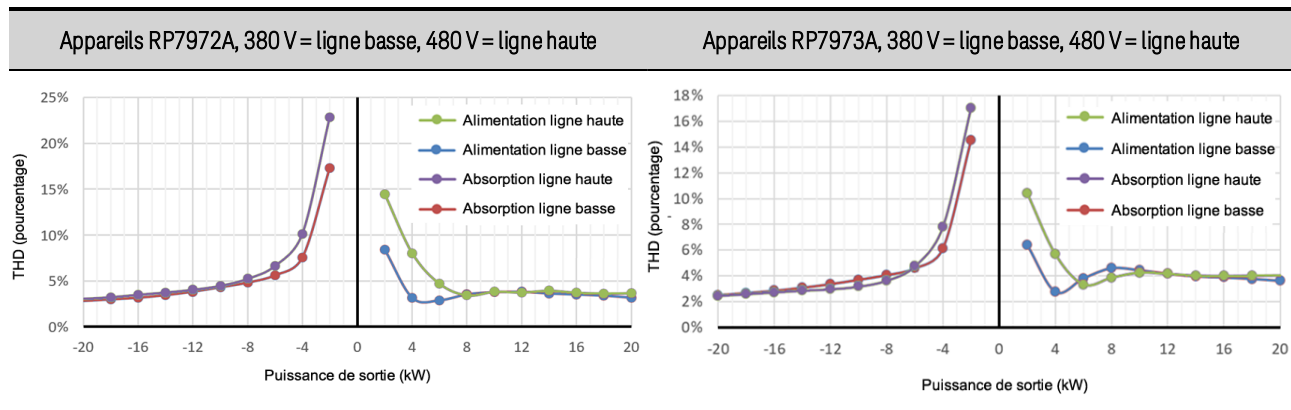

# 1 Aide-mémoire

## Pour les modèles de 30 kW RP7982A, RP7983A

### Efficacité de la source/de l'absorption

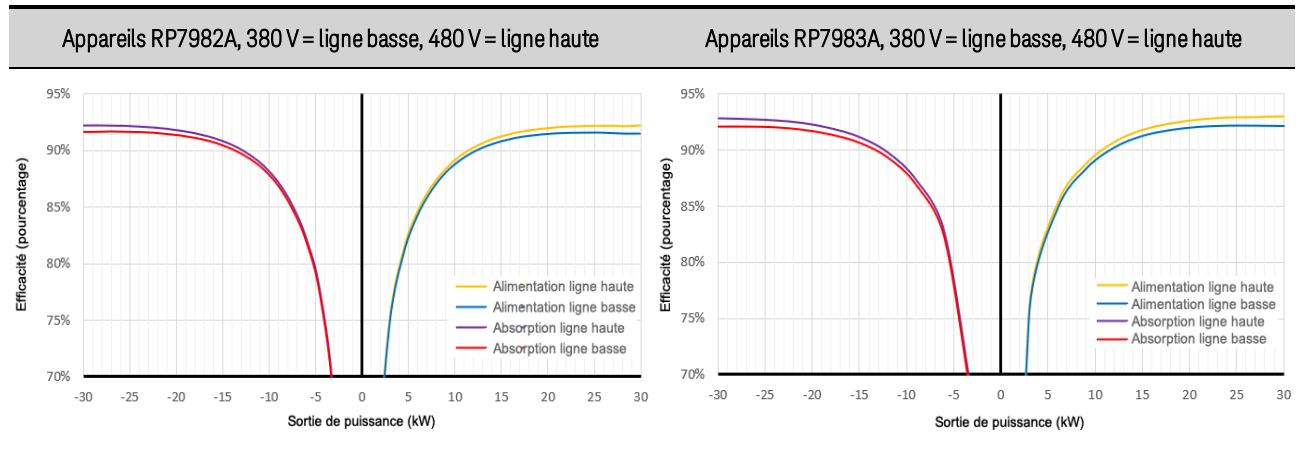

### Facteur de puissance

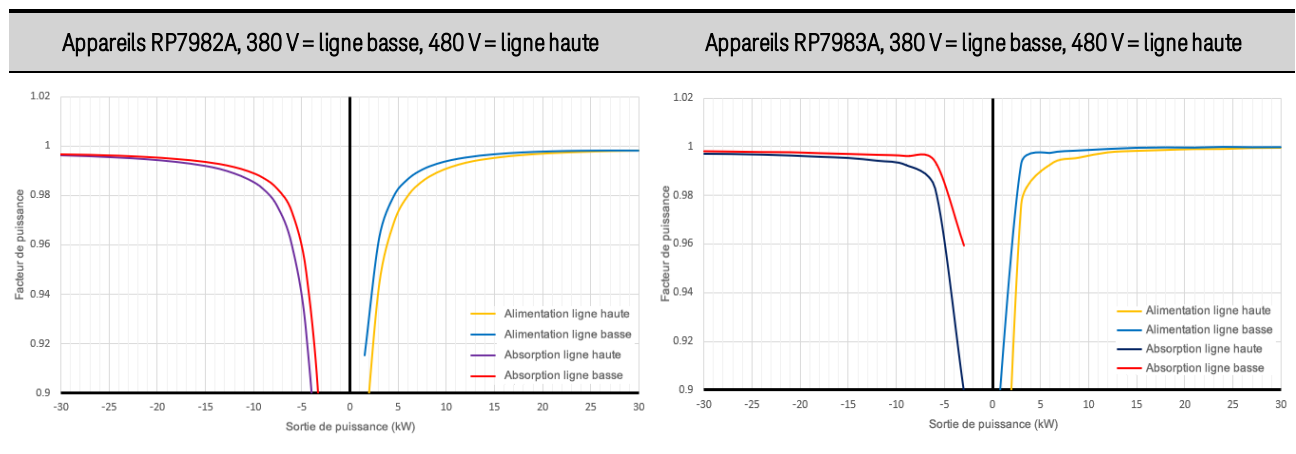

### Distorsion harmonique totale

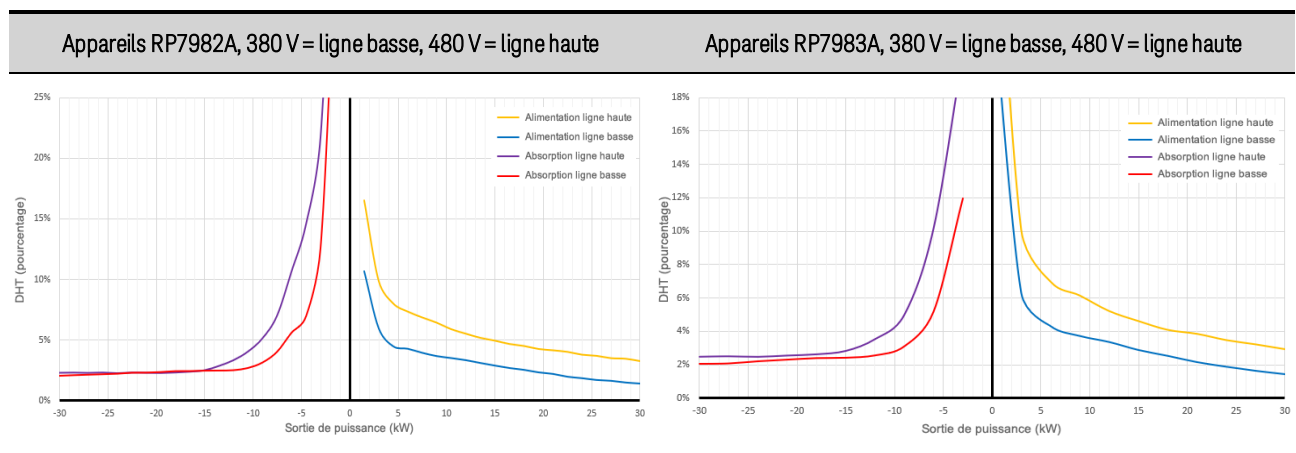

## Pour les modèles de 30 kW RP7984A

Efficacité de la source/de l'absorption

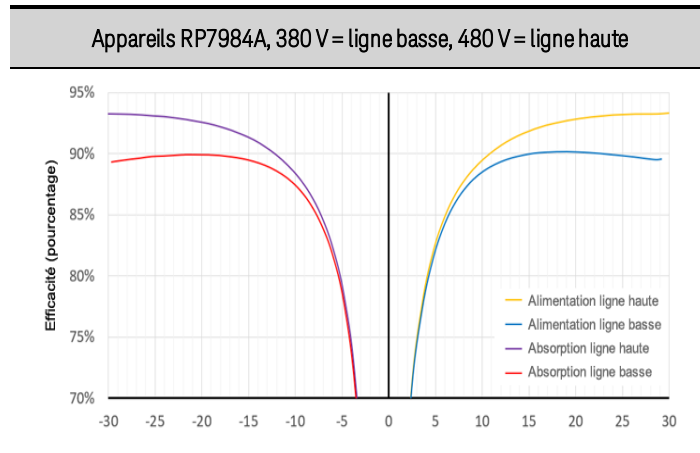

Facteur de puissance

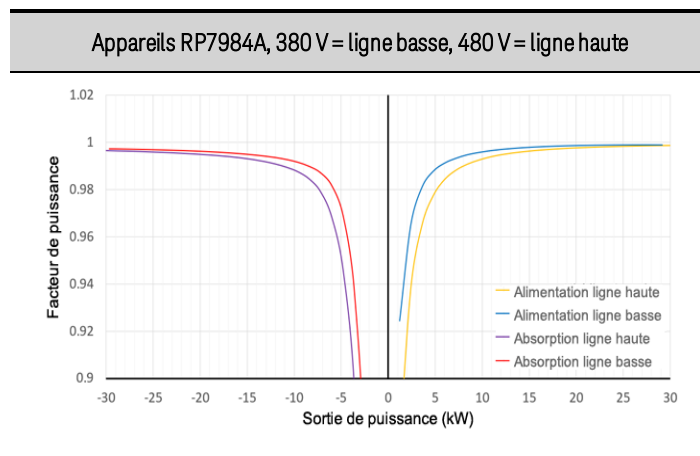

Distorsion harmonique totale

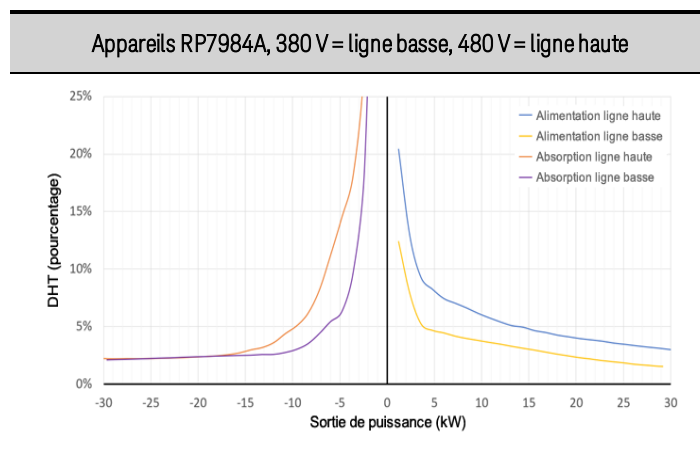

## Graphiques des impédances de sortie

Les graphiques suivants indiquent l'impédance de sortie des signaux faibles des modes de compensation pour un fonctionnement en tension constante (CV) et en courant constant (CC).

Pour les modèles de 20 kW RP7972A, RP7973A

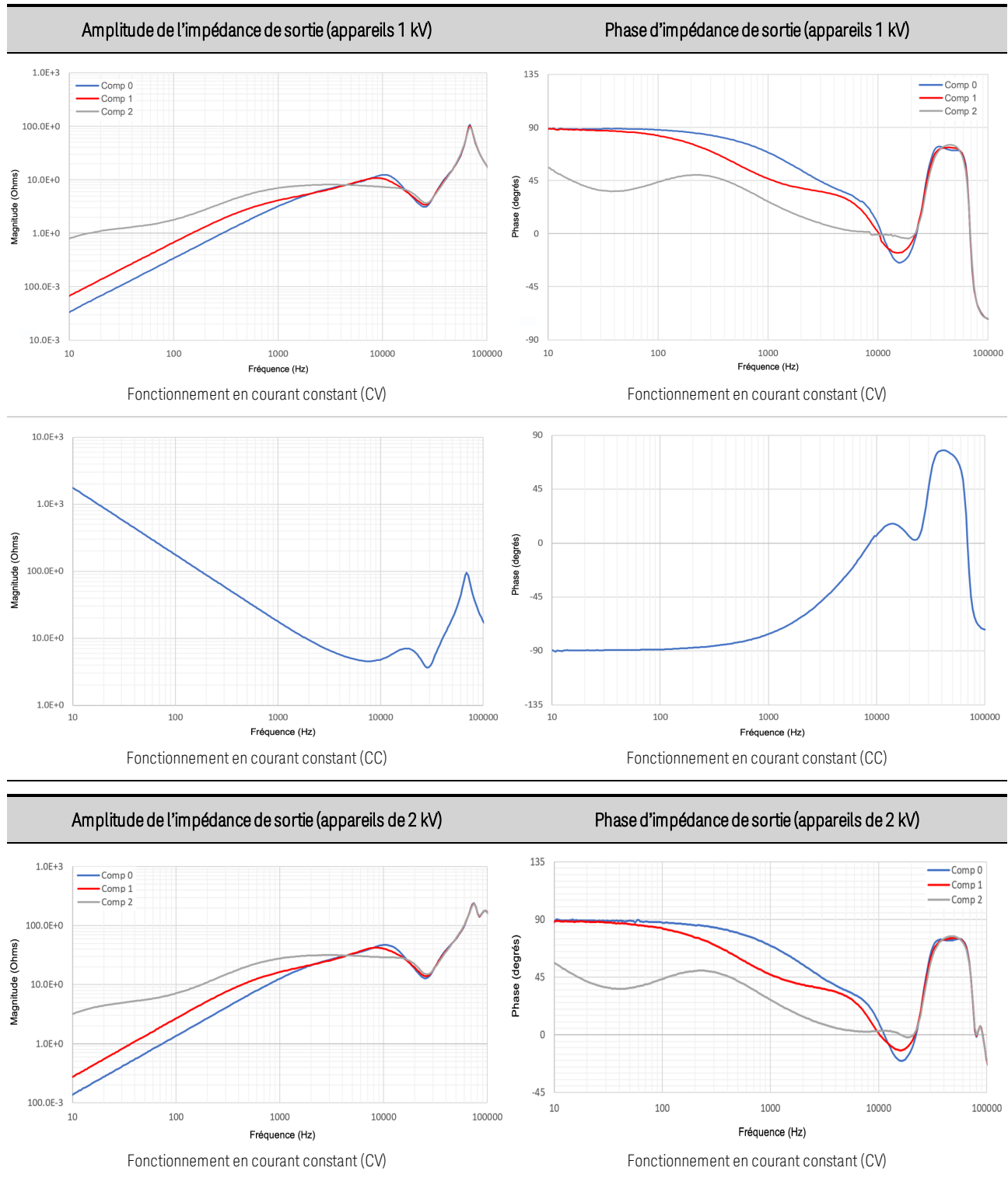

Amplitude de l'impédance de sortie (appareils de 2 kV)

Phase d'impédance de sortie (appareils de 2 kV)

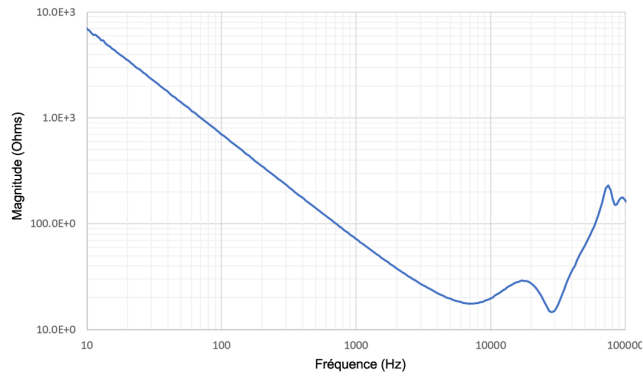

Fonctionnement en courant constant (CC)

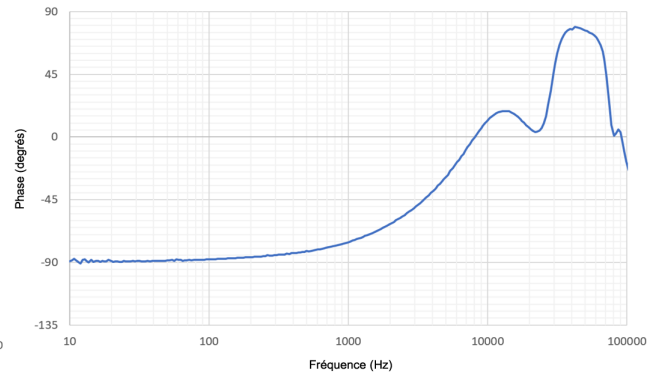

Fonctionnement en courant constant (CC)

Pour les modèles de 30 kW RP7982A, RP7983A, RP7984A

Amplitude de l'impédance de sortie (appareils 1 kV)

Phase d'impédance de sortie (appareils 1 kV)

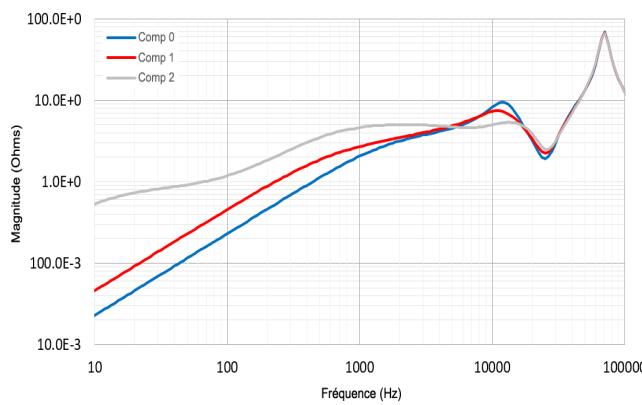

Fonctionnement en courant constant (CV)

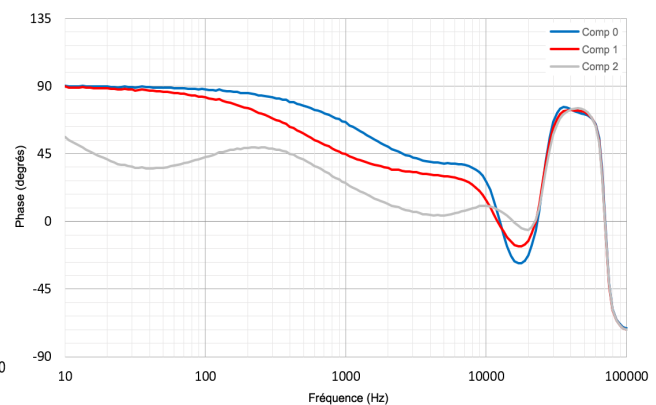

Fonctionnement en courant constant (CV)

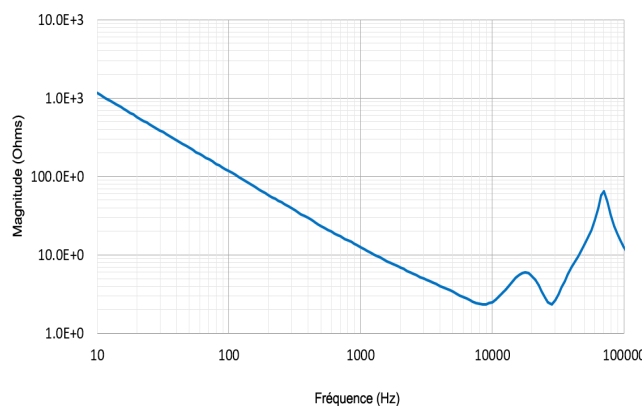

Fonctionnement en courant constant (CC)

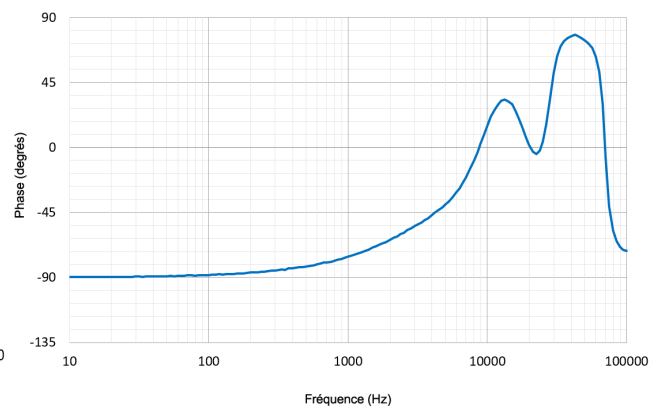

Fonctionnement en courant constant (CC)

**Amplitude de l'impédance de sortie (appareils 2 kV)      Phase d'impédance de sortie (appareils 2 kV)**

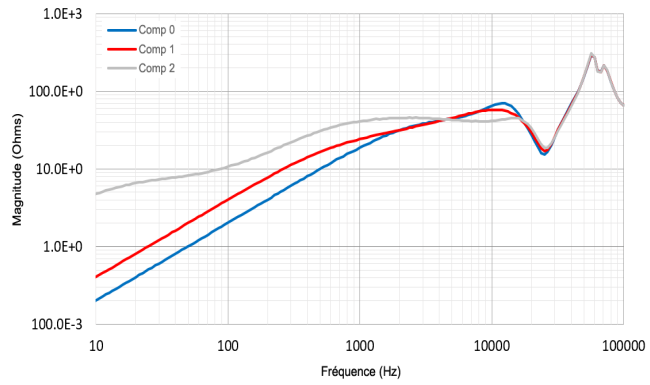

Fonctionnement en courant constant (CV)

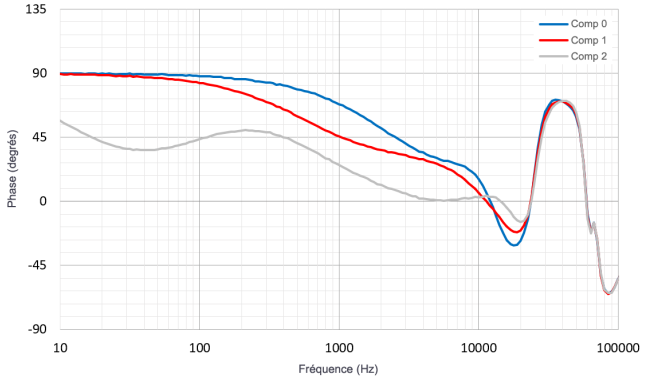

Fonctionnement en courant constant (CV)

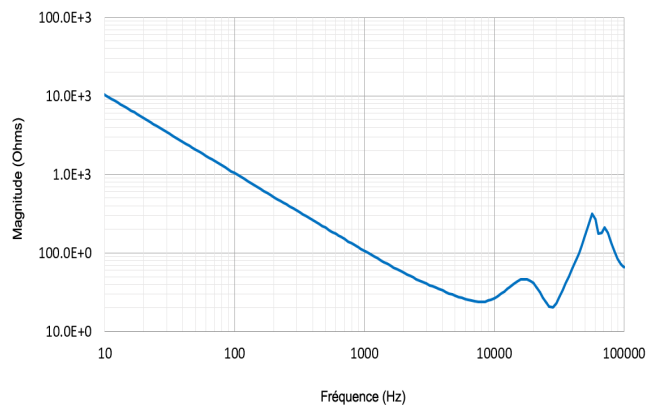

Fonctionnement en courant constant (CC)

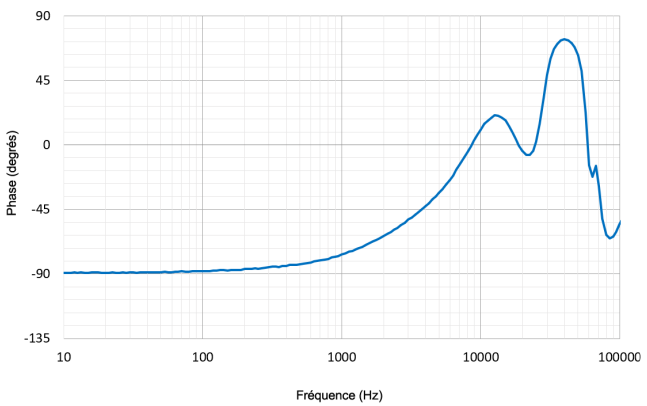

Fonctionnement en courant constant (CC)

**Amplitude de l'impédance de sortie (appareils 1,5 kV)      Phase d'impédance de sortie (appareils 1,5 kV)**

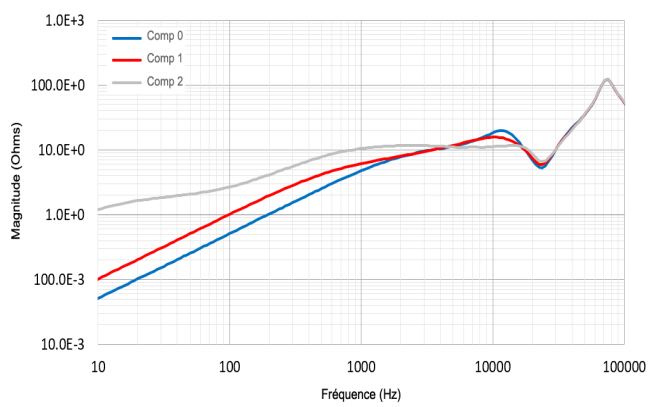

Fonctionnement en courant constant (CV)

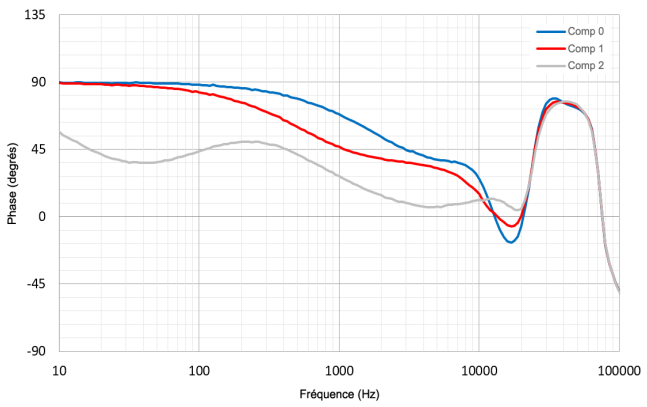

Fonctionnement en courant constant (CV)

Amplitude de l'impédance de sortie (appareils 1,5 kV)

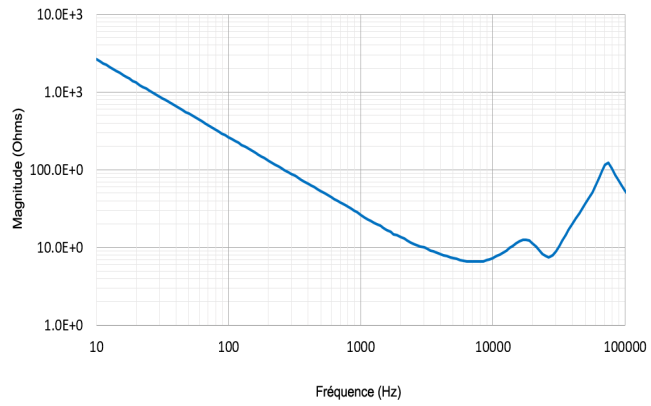

Fonctionnement en courant constant (CC)

Phase d'impédance de sortie (appareils 1,5 kV)

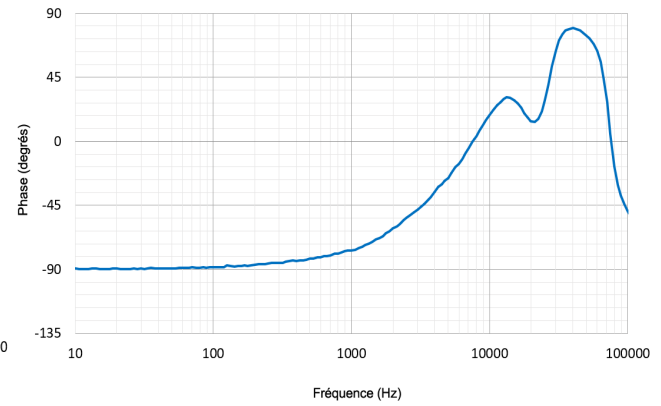

Fonctionnement en courant constant (CC)



## Limite de charge inductive pour un fonctionnement en courant constant (CC)

Les figures suivantes indiquent les limites maximales des charges inductives avec la résistance série équivalente (ESR) pour un fonctionnement en courant constant. Tout fonctionnement en dessous des lignes de stabilité marginale rouges peut entraîner une instabilité de la sortie. Notez que la résistance du fil et celle de l'appareil testé ainsi que l'inductance sont indifférenciables dans ce contexte. Il est également important de tenir compte de la chute de tension et de la dissipation d'énergie dans les fils en raison de la résistance accrue des fils. Reportez-vous à la section **Considérations relatives à l'inductance** pour plus de détails.

**ATTENTION**

**DOMMAGES MATÉRIELS** Les fixations internes du niveau de tension d'alimentation sont sensibles aux dommages thermiques lorsque la sortie est coupée brusquement à pleine charge si l'inductance du fil dépasse la caractéristique d'**Inductance de charge maximale** dépendante du modèle.

Pour les modèles de 20 kW RP7972A, RP7973A

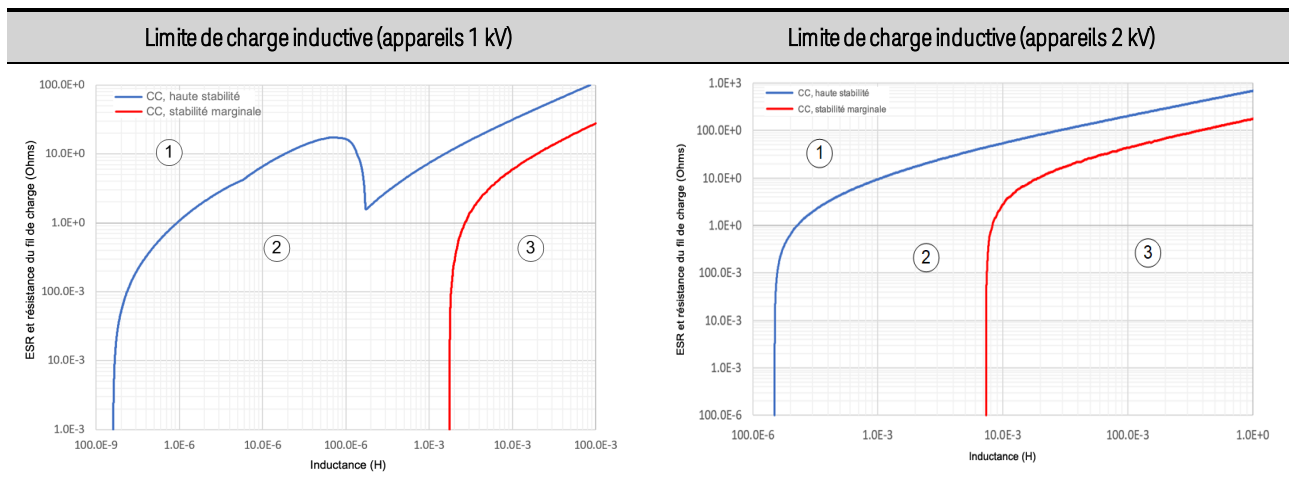

Pour les modèles de 30 kW RP7982A, RP7983A, RP7984APV8931A

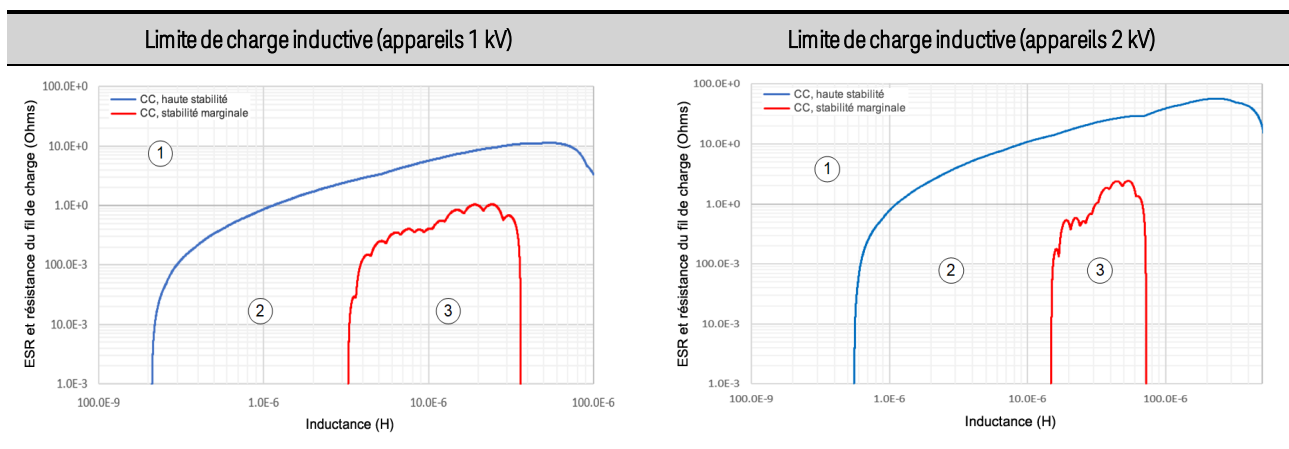

1. La sortie est stable dans cette région
2. La sortie peut dépasser les prévisions dans cette région
3. La sortie peut être instable dans cette région

## Limite de charge inductive (appareils 1,5 kV)

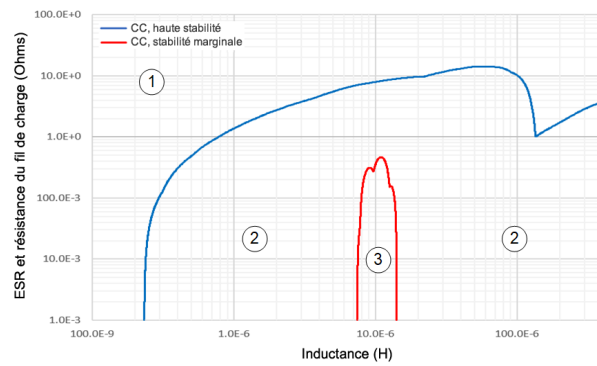

1. La sortie est stable dans cette région
2. La sortie peut dépasser les prévisions dans cette région
3. La sortie peut être instable dans cette région

## Limite de charge capacitive pour un fonctionnement en tension constante (CV)

Les figures suivantes indiquent les limites maximales des charges capacitives avec une résistance série équivalente (ESR) pour un fonctionnement à courant constant. Un fonctionnement en dessous des lignes de stabilité rouge marginales avec les réglages de largeur de bande de **Compensation** peut entraîner une instabilité de sortie. Il n'y a pas de limites absolues pour la capacité de l'appareil testé, car la stabilité est aussi une fonction de l'ESR. Reportez-vous à la section **Capacité de charge et Considérations relatives à l'inductance des fils** pour plus de détails.

Pour les modèles de 20 kW RP7972A, RP7973A

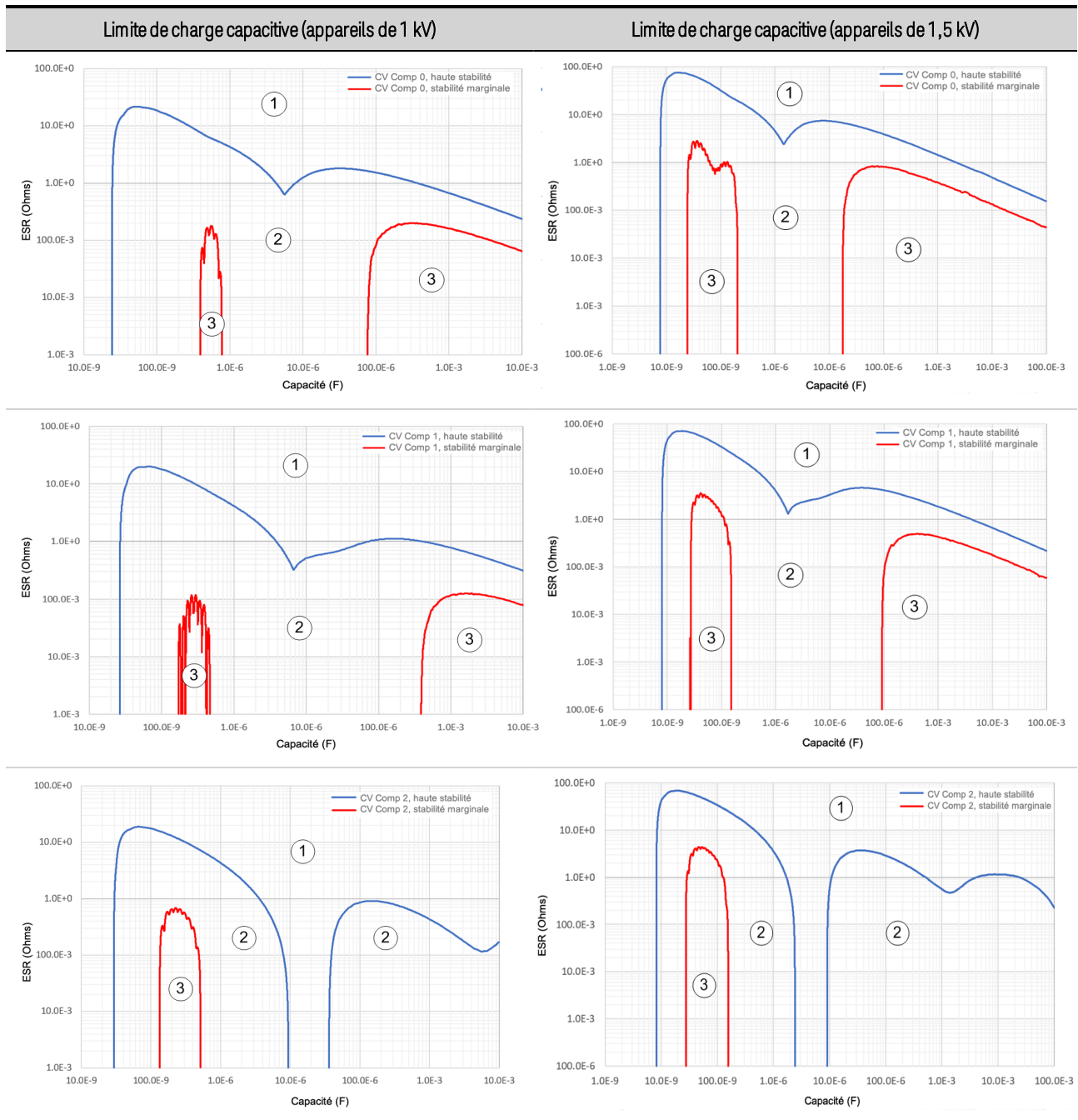

1. La sortie est stable dans cette région ; 2. La sortie peut dépasser les prévisions dans cette région ; 3. La sortie peut être instable dans cette région

Pour les modèles de 30 kW RP7982A, RP7983A, RP7984A

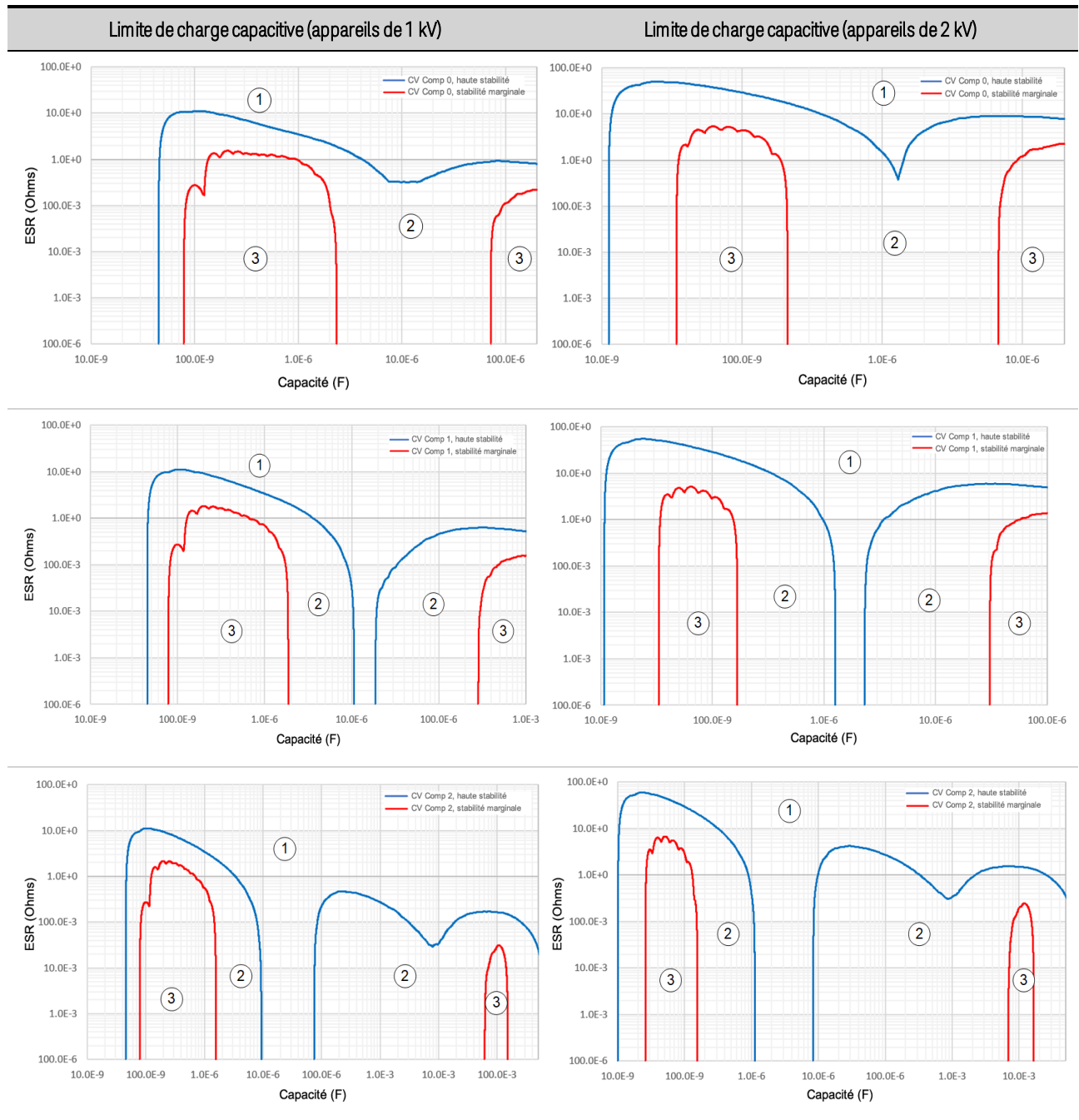

1. La sortie est stable dans cette région ;  
 2. La sortie peut dépasser les prévisions dans cette région  
 3. La sortie peut être instable dans cette région

# 1 Aide-mémoire

## Limite de charge capacitive (appareils de 1,5 kV)

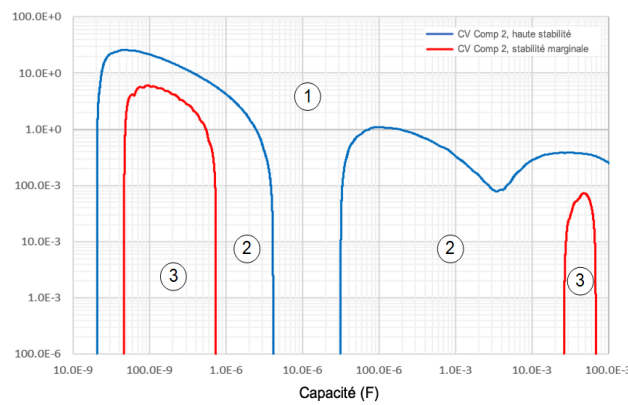
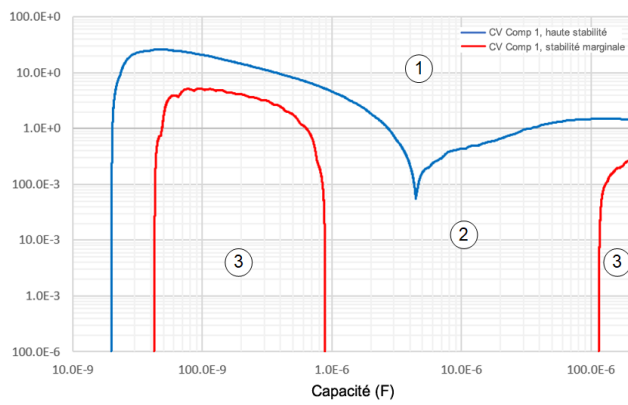
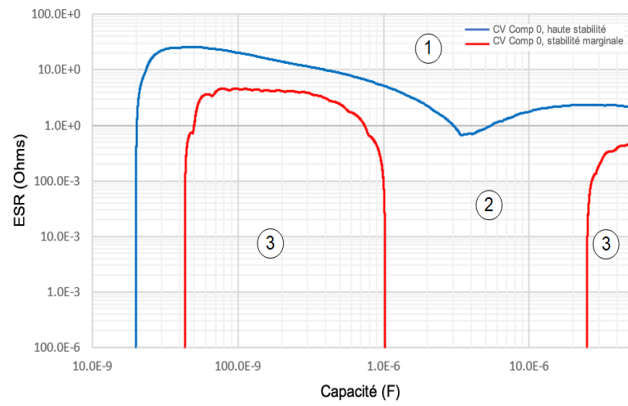

1. La sortie est stable dans cette région
2. La sortie peut dépasser les prévisions dans cette région
3. La sortie peut être instable dans cette région

## Réponse à la programmation des petits signaux

Les graphiques suivants illustrent les caractéristiques de réponse de programmation de la tension et du courant de sortie. La réponse de la tension s'applique à vide (circuit ouvert). La réponse du courant s'applique dans des conditions de court-circuit CA où l'appareil testé (DUT) a une faible impédance CA. La caractéristique est valable lorsque le fonctionnement est supérieur à 10 % de la puissance nominale de l'appareil.

Pour les modèles de 20 kW et de 30 kW

Amplitude de la bande passante de programmation (appareils de et 1 kV, 2 kV et 1,5 kV)

Phase de la bande passante de programmation (appareils de et 1 kV, 2 kV et 1,5 kV)

Réponse de programmation de la tension (Comp 0-2)

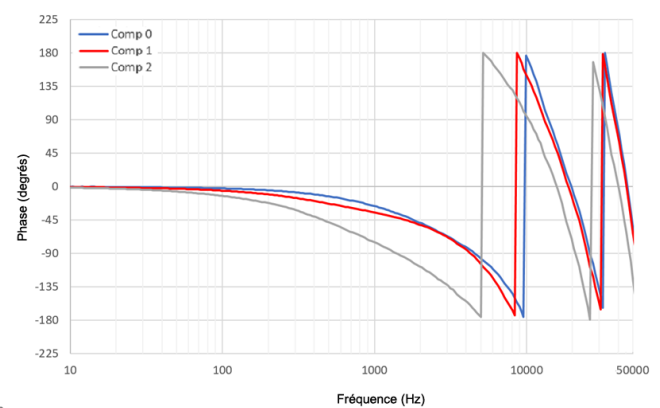
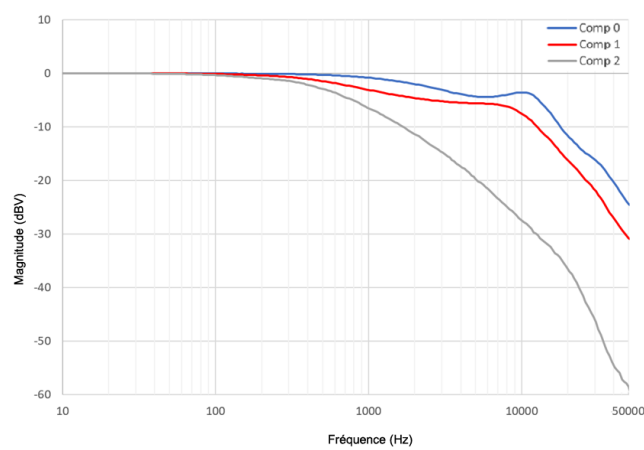

Réponse de programmation du courant

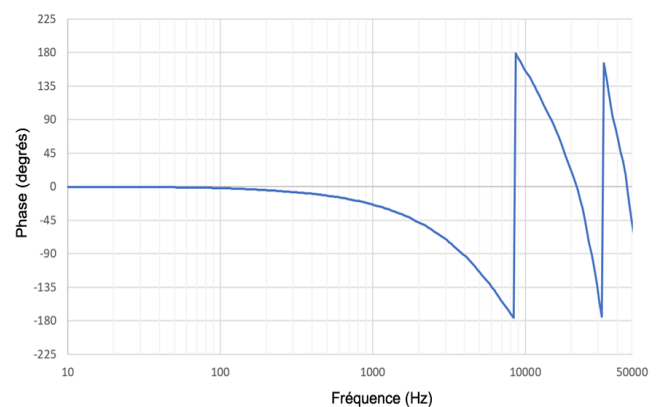
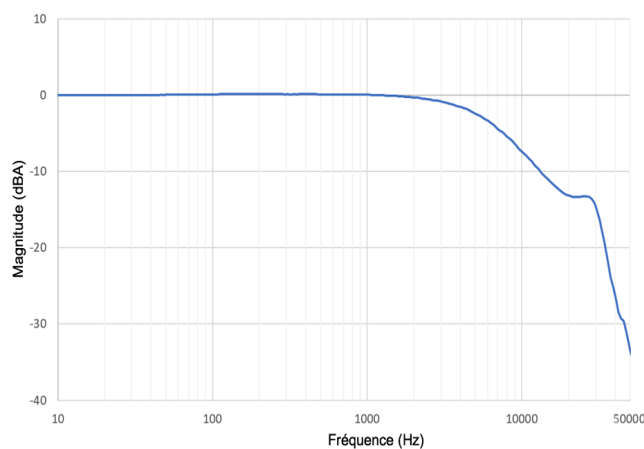

## Précision et résolution de la mesure - avec des intervalles de mesure plus courts

Le tableau suivant illustre les modifications apportées à la précision et la résolution de la mesure à court terme avec divers paramètres de mesure du nombre de cycles de tension d'alimentation (PLC). Les modifications sont dues aux performances de bruit du convertisseur A-D. La ligne de base du tableau est 1 NPLC sans bruit ajouté. Pour déterminer la précision de la mesure à intervalles de pondération plus courts, il suffit de calculer le pourcentage de plage à ajouter, puis de l'ajouter à la valeur de décalage dans le tableau des spécifications.

Par exemple, pour déterminer le pourcentage de plage à ajouter à la spécification de précision de la mesure de tension lors de la réalisation de mesures à 0,003 NPLC, multipliez simplement la tension nominale totale par « % de plage ajouté à la valeur spécifiée » comme suit :  $2000 \text{ V} \times 0,0015 \% = 30 \text{ mV}$ . Ajoutez ce nombre à la partie de décalage de la spécification de précision de la mesure :  $150 \text{ mV} + 30 \text{ mV}$ . La nouvelle précision de mesure de la tension est  $0,04 \% + 180 \text{ mV}$  à 0,003 NPLC.

NPLC à 60Hz	Nombre de points moyennés	Mesure de tension	
		% de plage ajouté à la valeur spécifiée	Mesure du courant % de plage ajouté à la valeur spécifiée
1	3255	0	0
0,3	1000	0,0004%	0,0015%
0,1	325	0,0007%	0,003%
0,01	33	0,0009%	0,008%
0,003	10	0,0015%	0,016%
0,0003	1	0,005%	0,056%

## Protection dynamique excessive (tous les modèles)

Pour éviter que l'appareil ne désactive la sortie en raison d'une condition de protection dynamique excessive (EDP), vous devez limiter l'amplitude de toute forme d'onde arbitraire définie par l'utilisateur en fonction de la fréquence de sortie.

Le graphique suivant représente la tension crête à crête de sortie maximale admissible qui peut être générée en toute sécurité par le système de forme d'onde arbitraire à une fréquence spécifique. Les valeurs sont normalisées en termes de tension crête à crête à pleine échelle. Tous les modèles sont donc représentés.

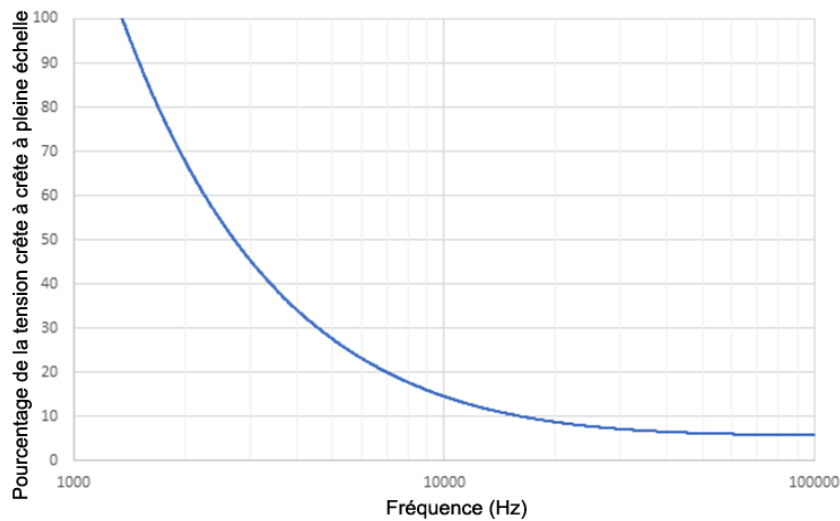

### Quadrants d'entrée

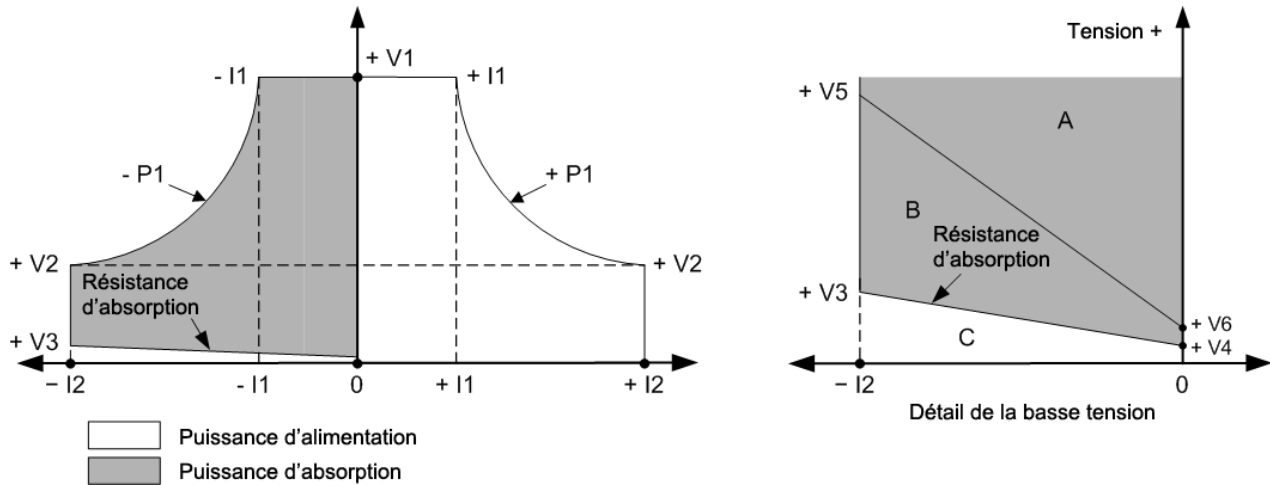

Modèle	+V1	+V2	+V3	+V4	+V5	+V6	+/- I1	+/- I2	+/- P1	Résistance d'absorption
RP7972A	1000 V	333 V	7,8 V	2,5 V	25,5 V	3 V	20 A	60 A	20 kW	130 mΩ
RP7973A	2000 V	666 V	15 V	5 V	51 V	6 V	10 A	30 A	20 kW	500 mΩ
RP7982A	1000 V	500 V	7,2 V	2,5 V	25,5 V	3 V	30 A	90 A	30 kW	80 mΩ
RP7983A	2000 V	1000 V	18 V	5 V	51 V	6 V	15 A	30 A	30 kW	600 mΩ
RP7984A	1500 V	500 V	10,5 V	0 V	33 V	3 V	20 A	60 A	30 kW	175 mΩ

### Détail de la basse tension

A. L'appareil fonctionne normalement dans cette région

B. La tension et le courant de sortie se régulent correctement, mais l'état peut indiquer qu'ils ne sont pas régulés. En outre, l'ondulation crête-à-crête et efficace peut être plus élevée et le temps de stabilisation et la réponse transitoire peuvent être plus lents.



## 1 Aide-mémoire

C. L'appareil n'opérera pas dans cette région. Cette région est délimitée par la limite de résistance à l'enfoncement. Les limites entre A, B et C sont approximatives.

# 2

## Installation de l'instrument

### Avant l'installation ou l'utilisation

#### Connexions de l'alimentation secteur

#### Connexions de sortie d'un appareil unique

#### Connexions de sortie de plusieurs appareils

#### Connexions de l'interface

**AVERTISSEMENT**

Poids élevé.

Danger relatif aux mains et aux pieds. Afin d'éviter toute blessure ou dommage à l'instrument, utilisez toujours un chariot solide ou tout autre appareil adéquat pour déplacer l'instrument. Ne soulevez jamais l'instrument seul(e) ; veillez à toujours être au moins deux personnes pour soulever l'instrument.



## Avant l'installation ou l'utilisation

### Inspection de l'appareil

À la réception de l'appareil RPS, inspectez celui-ci pour détecter tout dommage évident dû au transport. Si vous en constatez la présence, faites les réserves d'usage auprès du transporteur et prévenez immédiatement le bureau commercial et d'assistance Keysight le plus proche ([www.keysight.com/find/assist](http://www.keysight.com/find/assist)). Conservez le carton d'expédition et les éléments d'emballage au cas où l'appareil devrait être retourné.

### Vérification des composants livrés

Avant de commencer, vérifiez la liste suivante et la bonne réception des éléments suivants. Si un composant est manquant, contactez votre bureau commercial et d'assistance Keysight le plus proche.

Éléments fournis	Description	Numéro de référence
Prise de connecteur de mesure avec câble (installé)	Prise de connecteur de mesure haute tension à 4 broches avec câble haute tension à deux fils pour la mesure de la tension + et -	Keysight 5188-9651 Prise uniquement : Keysight 0360-3228 (Phoenix Contact 1714294)
Prise du connecteur de mesure (installée)	Connecteur de mesure haute tension à 4 broches (Les deux bornes centrales ne sont pas utilisées)	Keysight 0360-3228 (Phoenix Contact 1714294)
Le kit du capot inclut :		Keysight 5066-2117
Fiche de connecteur numérique	Connecteur 8 broches pour le port numérique	Phoenix Contact 1840421
Câble principal/secondaire	Câble de 1 m (CAT6A) pour la communication en parallèle	
Capot de sécurité d'entrée CA	Capot de sécurité d'entrée CA avec bague serre-câble	
Capot de sécurité de sortie	Capot de sécurité de la barre conductrice de sortie à haute tension	
Noyau de ferrite	Noyau de ferrite installé sur les câbles de sortie (pour RP7973A, RP7982A, RP7983A)	
Capot contre les décharges électrostatiques avec bride	Capot contre les décharges électrostatiques pour connexions d'interface à distance	
Kit de connexion à barres conductrices	Matériel de connexion pour les barres conductrices à haute tension	Keysight 5067-6031
Certificat d'étalonnage	Certificat d'étalonnage renvoyant au numéro de série	Aucun

### Examen des informations de sécurité

Ce système d'alimentation est un instrument de mesure de la catégorie de sécurité 1 avec une borne de terre de protection. Celle-ci doit être reliée à la terre via une prise secteur munie d'une borne de

terre. Pour obtenir des informations générales sur la sécurité, reportez-vous à la section **Consignes de sécurité**. Avant l'installation ou l'utilisation, consultez toujours ce guide pour connaître les avertissements et les instructions de sécurité spécifiques situés aux endroits appropriés du guide.

**AVERTISSEMENT**

**RISQUE D'ÉLECTROCUTION, TENSION LÉTALES** De nombreux modèles génèrent des tensions allant jusqu'à 2 000 V CC ! Assurez-vous que toutes les connexions des instruments, le câblage de charge ainsi que les connexions de charge et de mesure sont isolés à l'aide de fils haute tension. Fixez toujours le capot de sécurité fourni, de sorte qu'aucun contact accidentel avec des tensions mortelles ne puisse se produire.

---

## Observation des conditions environnementales

**AVERTISSEMENT**

N'utilisez pas l'instrument en présence de gaz ou de vapeurs inflammables.

---

Les conditions environnementales du système d'alimentation sont décrites dans la section **Caractéristiques communes**. En règle générale, l'appareil doit être uniquement utilisé dans des locaux abrités, dans un environnement contrôlé. N'utilisez pas l'appareil dans des espaces où la température ambiante est supérieure à +55 degrés Celsius. Cela concerne le montage en baie, ainsi que l'utilisation en paillasse.

## Circulation d'air adéquate

**ATTENTION**

N'obstruez pas l'entrée de ventilation à l'avant de l'instrument ou la sortie à l'arrière.

---

Les dimensions de votre bloc d'alimentation ainsi qu'un schéma de principe sont fournis dans la section **Schéma de principe**. Des ventilateurs refroidissent l'appareil en aspirant de l'air à l'avant et en le rejetant à l'arrière. L'appareil doit être installé à un emplacement prévoyant un espace suffisant d'au moins 30,5 cm (12 pouces) à l'avant et à l'arrière afin d'assurer une ventilation adéquate.

En cas de température ambiante excessive ou de blocage du flux d'air à l'entrée ou à la sortie de l'instrument, une protection contre la surchauffe désactivera la sortie pour protéger l'alimentation électrique et l'appareil testé.

## Déplacement des instruments

**ATTENTION**

Les modèles Keysight RPS pèsent jusqu'à 57 Kg (126 livres). (57,2 kg). Utilisez toujours un chariot robuste ou un autre dispositif approprié pour déplacer l'instrument. Il faut deux personnes pour l'installation. Ne soulevez ou ne déplacez pas l'appareil seul. Évitez de déplacer l'appareil à la main. Si cela est inévitable, soulevez uniquement le châssis de l'appareil ; ne soulevez pas l'appareil par les bornes de sortie ou le panneau avant.

---

### Empilage des instruments

**ATTENTION** N'empilez jamais plus de trois appareils à 20 kW les uns sur les autres dans une installation autonome. De plus, en raison de leur poids accru, les appareils de 30 kW (RP7982A, RP7983APV8931A) ne peuvent pas être empilés.

---

### Accessoires de montage en baie

Accessoires	Description
Keysight 1CP108A	Kit de montage en baie avec poignées : à utiliser avec RP7972A, RP7973A
Keysight 1CP120A	Kit de montage en baie avec poignées : à utiliser avec RP7982A, RP7983A
Keysight RP7908A	Rails pour baies Keysight ou de conception similaire

Schéma de principe pour les modèles de 20 kW

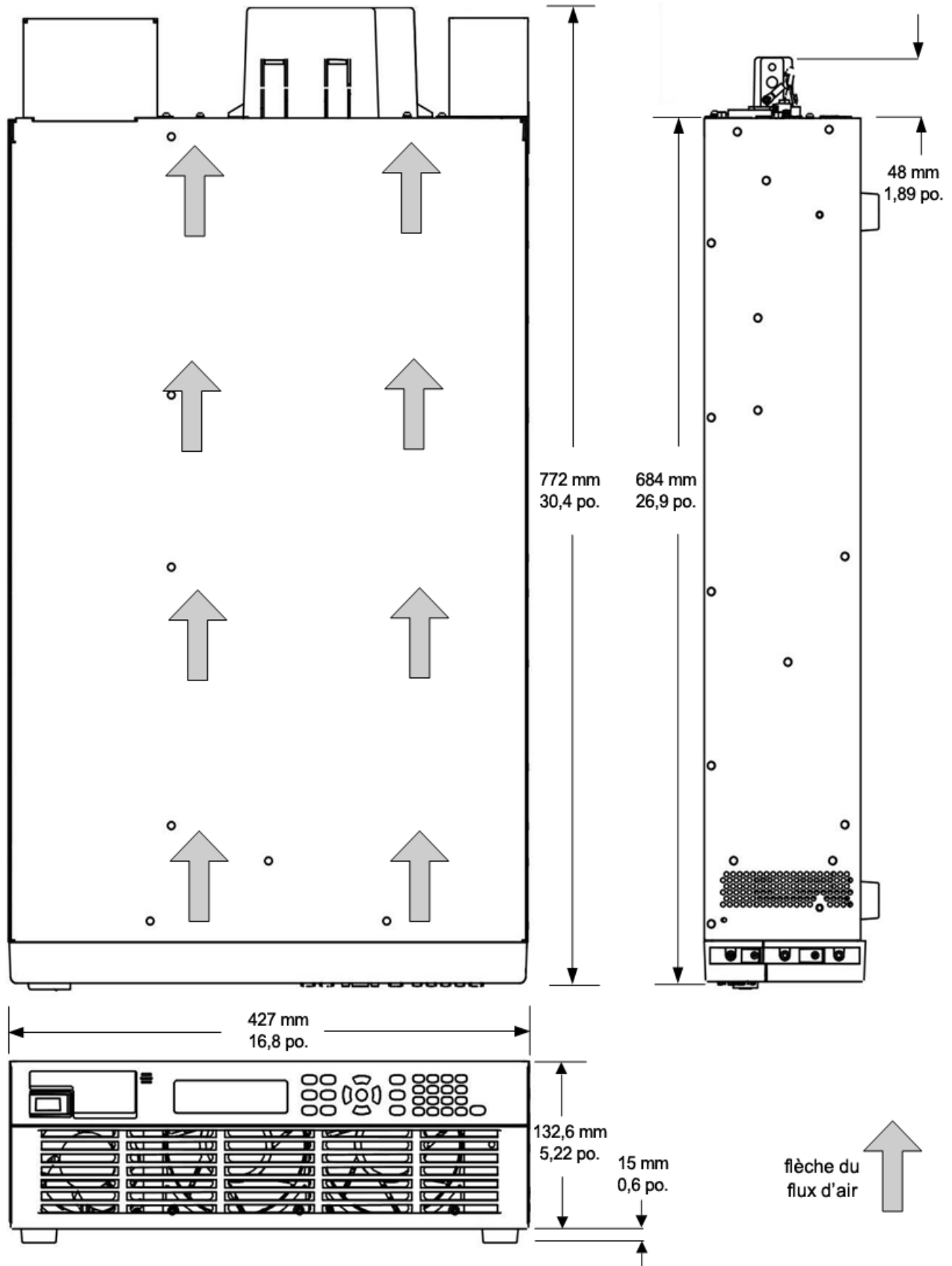

### Schéma de principe pour les modèles de 30 kW

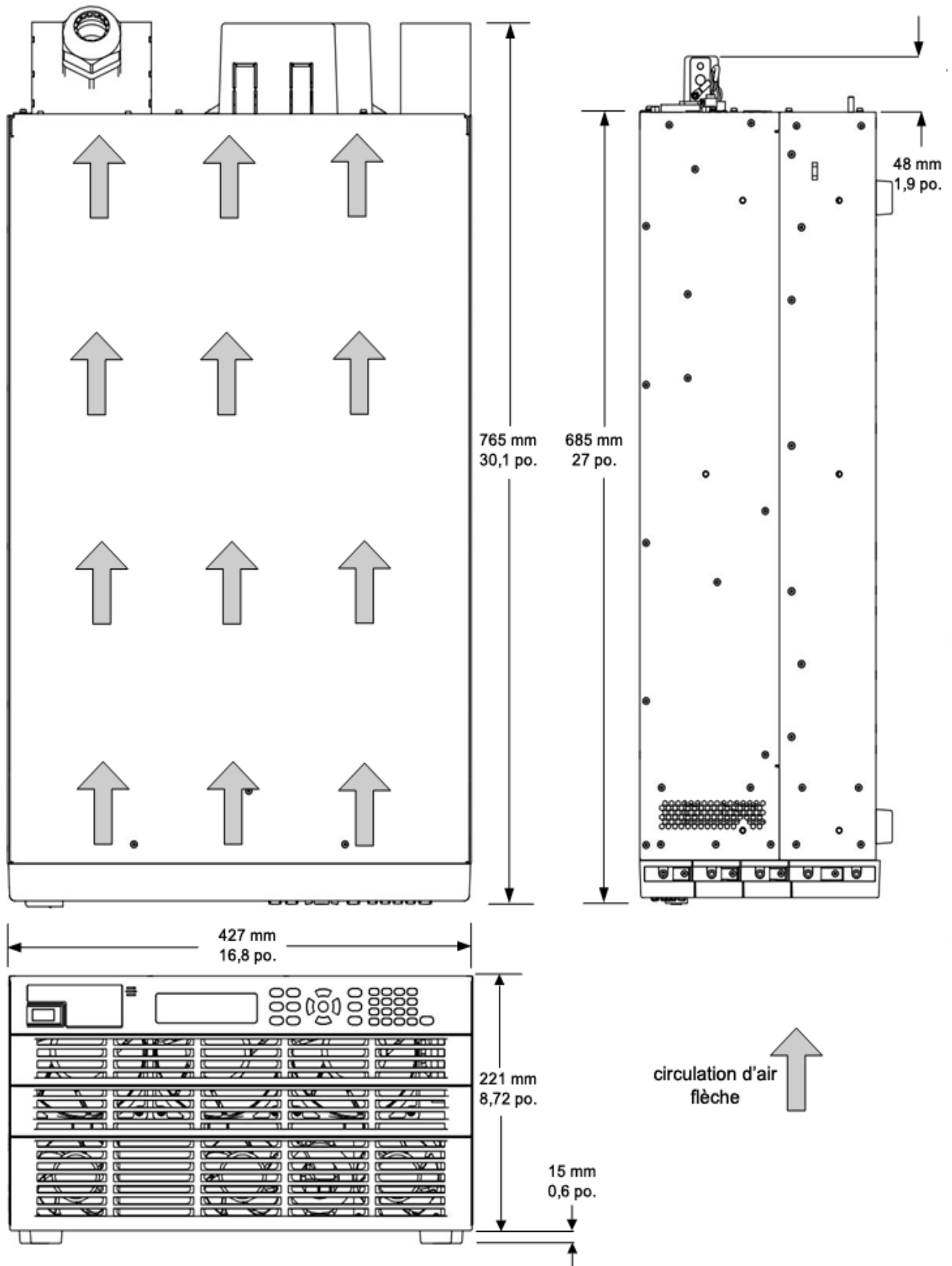

## Connexions de l'alimentation secteur

### Caractéristiques communes de l'alimentation secteur

#### Connexions des câbles d'alimentation

### Caractéristiques communes de l'alimentation secteur

Les modèles Keysight RPS sont équipés d'un convertisseur d'entrée CA triphasé entièrement bidirectionnel, qui permet un flux de puissance bidirectionnel et sans faille entre l'alimentation secteur et les bornes de sortie CC.

Dans une alimentation électrique standard, l'énergie circule uniquement des bornes de sortie du courant alternatif vers les bornes de sortie du courant continu. Dans une alimentation électrique régénérative, l'énergie circule également des bornes de sortie en courant continu vers l'alimentation secteur lorsque l'appareil fonctionne en courant d'absorption, soit en raison d'une programmation en aval rapide de la sortie ou de la décharge d'une source d'énergie telle qu'une batterie. Ce retour de l'énergie à l'alimentation secteur est appelé fonctionnement régénératif.

Le convertisseur d'entrée CA de l'appareil RPS utilise des algorithmes de microprogramme pour maintenir un facteur de puissance élevé et une faible distorsion harmonique totale dans un large éventail de conditions de fonctionnement. Pour plus d'informations, veuillez vous reporter à la partie consacrée à l'entrée CA dans la section **Caractéristiques**.

Suivez toutes les instructions de câblage pour le cordon d'alimentation fournies dans cette section du manuel. Par exemple, l'appareil RPS utilise une connexion au conducteur neutre de l'entrée CA. Le courant neutre est très faible, mais l'instrument ne s'allumera pas si cette connexion n'est pas assurée.

**ATTENTION** Le dépassement de la tension d'entrée CA ou un mauvais câblage de la connexion de ligne peut créer des dommages permanents dans les appareils suivants.

Les composants suivants sont utilisés pour assurer l'immunité contre les transitoires ligne à ligne jusqu'à 2 kV et les transitoires ligne à terre jusqu'à 4 kV :

- Des limiteurs de tension de 300 Vrms sont installés entre les connexions de ligne et neutres.
- Des limiteurs de tension de 600 Vrms sont installés entre les connexions ligne à ligne.
- Un tube de décharge de gaz est installé entre la connexion neutre et la masse du châssis.

Plusieurs fonctions de protection internes sont utilisées pour protéger l'instrument contre les conditions anormales de la ligne tout en empêchant l'ilotage de l'alimentation secteur. Les conditions suivantes provoquent l'arrêt de l'instrument :

- Si la tension de ligne est supérieure à 120 % de la valeur nominale la plus élevée pour un cycle de ligne.



## 2 Installation de l'instrument

- Si la tension de ligne est inférieure à 50 % de la valeur nominale la plus basse pour trois cycles de ligne.
- Si le courant de ligne est supérieur à 120 % du courant de ligne le plus élevé attendu pendant environ une seconde.
- Si la fréquence de ligne se décale de plus de 2 Hz par rapport à la fréquence de ligne initiale pendant plus d'une seconde.
- En cas d'abandon d'une ligne à un cycle.

L'instrument redémarre automatiquement si la condition de défaillance n'est plus présente. La sortie restera désactivée après le redémarrage jusqu'à ce que l'opérateur rétablisse les réglages précédents, soit grâce aux commandes du panneau avant, soit à l'aide d'un programme informatique. Ce comportement est conforme aux procédures d'exploitation sécuritaires.

Les conditions suivantes forceront la sortie dans un état de protection et produiront un indicateur d'état de panne de courant (PF). Une remise sous tension sera nécessaire pour annuler la fonction de protection :

- Si la tension de ligne est inférieure à 83 % de la valeur nominale la plus basse pendant plus d'une seconde.
- Si une surtension extrême ligne à ligne approchant 2 kV se produit.

La condition suivante empêchera l'instrument de se mettre en marche :

- Si la fréquence de la ligne est en dehors de la plage de 46,5 Hz à 63,5 Hz.

En cas de panne secteur, l'appareil se déconnecte automatiquement de la ligne. Cela se produira avec l'appareil qu'il soit en courant d'alimentation ou en courant d'absorption.

### Connexions des câbles d'alimentation

**REMARQUE** Le respect de toutes les réglementations pour l'exploitation et la connexion au réseau public d'équipement de récupération d'énergie est obligatoire.

Les connexions à l'alimentation secteur doivent être effectuées par un électricien qualifié qui connaît bien les équipements de récupération d'énergie afin de s'assurer que toutes les exigences de sécurité applicables ont été suivies et toutes les conditions nécessaires respectées. Il doit également connaître les circuits triphasés et toutes les normes et exigences de sécurité applicables.

***Aucun cordon d'alimentation secteur n'est fourni avec l'appareil.***

Consultez le tableau suivant pour obtenir les exigences de capacité en courant maximale pour chaque câble conducteur. Si des codes d'électricité locaux l'exigent, installez un fusible ou un disjoncteur entre l'alimentation secteur et l'appareil.

Modèle	Valeur nominale de l'appareil	L1 I <sub>max</sub>	L2 I <sub>max</sub>	L3 I <sub>max</sub>
RP7972A, RP7973A	20 kW, 380-480 V CA, ligne à ligne	36 A	36 A	36 A

Modèle	Valeur nominale de l'appareil	L1 $I_{\max}$	L2 $I_{\max}$	L3 $I_{\max}$
RP7982A, RP7983A	30 kW, 380-480 V CA, ligne à ligne	52 A	52 A	52 A

**AVERTISSEMENT**

La section du câble doit être adaptée au courant d'entrée maximum de l'instrument. Le câble de masse doit avoir la même section que le câble de phase.

**REMARQUE**

Les exigences de sécurité des organismes stipulent qu'il doit être possible de déconnecter physiquement le câble d'alimentation secteur de l'appareil. Un appareil de coupure (interrupteur ou disjoncteur) doit être fourni dans l'installation finale. L'appareil de coupure doit être proche de l'équipement, être facilement accessible et être marqué en tant qu'appareil de coupure de cet équipement. Il doit satisfaire aux exigences de valeurs d'entrée répertoriées dans le tableau suivant.

Raccourcissez au maximum les cordons d'alimentation secteur. Plus le câble est long, plus la baisse de tension est importante en raison de la résistance du câble.

Une distribution d'alimentation secteur de type Y est nécessaire. Cependant, une tension entre phases correcte doit être appliquée. **Une distribution d'alimentation secteur de type delta ne peut pas être utilisée** car une connexion Neutre est nécessaire. Il faut également prévoir une mise à la terre du raccordement à la terre du PE par un conducteur distinct.

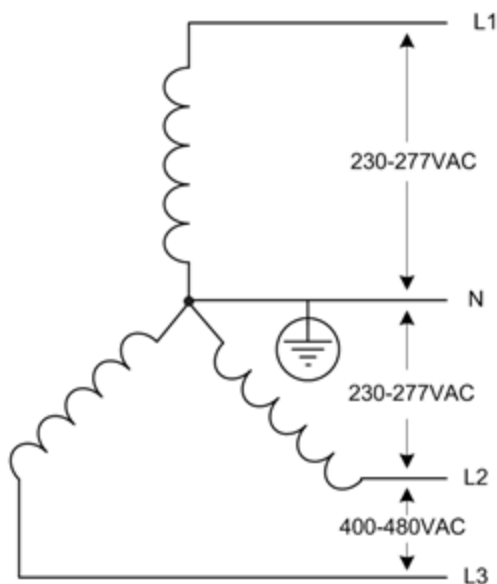

## 2 Installation de l'instrument

### AVERTISSEMENT

**RISQUE D'ÉLECTROCUTION** L'instrument requiert un raccordement à la terre du châssis via un conducteur distinct. Le secteur doit comporter une connexion à la masse.

Dans les cas où l'appareil n'est pas câblé au système électrique, un schéma de connecteur de verrouillage doit être utilisé tel que UL 498, CEI 60309, ou équivalent. Consultez un électricien local pour connaître le schéma de connexion adapté à votre région.

Exemple 480V/60A :

<https://www.elecdirect.com/pin-sleeve-devices/60-amp-pin-and-sleeve-devices/ip67-iec309-pin-sleeve-plug-60a-3-phase-277-480-4-pole-5-wire-watertight>

- En cas de fixation, retirez le capot de sécurité de l'appareil.
- Insérez les terminaisons du cordon d'alimentation dans le serre-câble du capot de sécurité.  
La bague serre-câble du capot de sécurité peut recevoir un câble métallique ou des fils individuels.  
Diamètre intérieur minimal : 15 mm (0,6 po.).  
Diamètre intérieur maximal : 25,4 mm (1 po.)
- Ne serrez pas le serre-câble tant que toutes les connexions ne sont pas effectuées.
- Une fois que toutes les connexions de fils sont terminées, fixez le couvercle de sécurité à l'appareil et serrez le serre-câble.

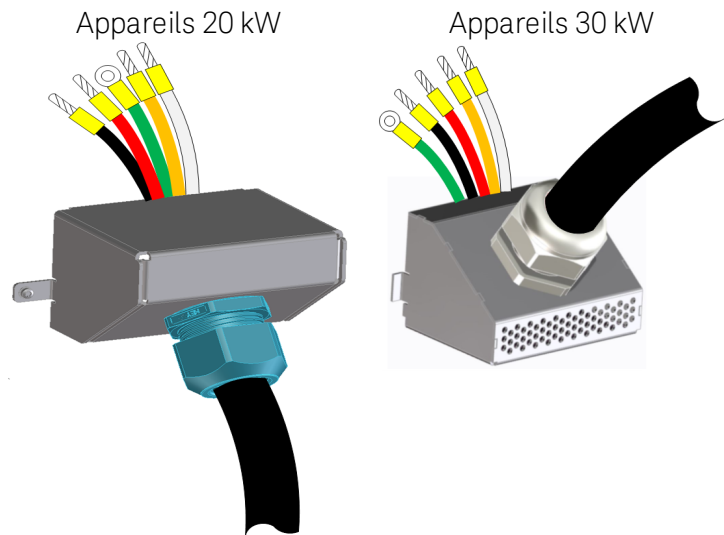

- Reliez les fils des lignes aux bornes de l'alimentation secteur (code de couleur américain indiqué).  
Section maximale du fil : 6 AWG (16 mm<sup>2</sup>)  
Longueur de dénudage des fils : 18 mm  
Utilisez toujours un tournevis à lame plate pour libérer et ouvrir complètement le bornier.
- Suggestion de virole facultative :  
Pour 8 AWG : WAGO 216-289  
Pour 10 AWG : WAGO 216-288  
(Reportez-vous au fabricant pour plus de détails.)
- Connectez le fil de masse au goujon du châssis situé *sous* le connecteur CA. Le diamètre du goujon est M5. Serrez l'écrou de combinaison M5 à 2,259 Nm.

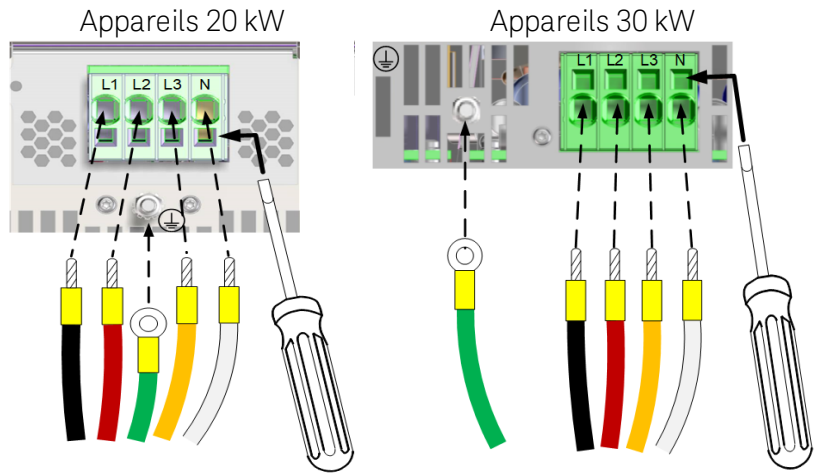

**ATTENTION** **Dégâts matériels** Le fil neutre doit être connecté. Assurez-vous qu'aucun fil autre que le fil neutre n'est connecté au port « N ».

## Connexions de sortie d'un appareil unique

### Connexions de sortie

### Connexions de charge unique

### Connexions de charges multiples

### Connexions de mesure à distance

### Autres considérations relatives à la charge

## Connexions de sortie

### Connexions de mesure

Vérifiez que le câble de mesure est installé à l'arrière de l'instrument comme illustré. Le seul moment où le câble de mesure doit être déconnecté des barres conductrices de sortie est lors de la **mesure à distance**.

Les deux bornes centrales ne sont pas utilisées.

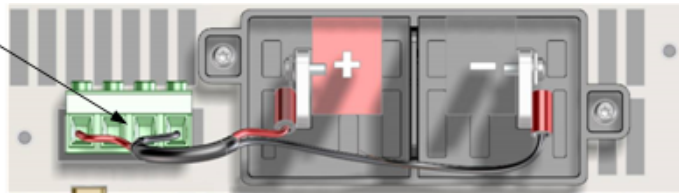

Si le câble de mesure n'est pas installé avant la mise sous tension de l'instrument ou s'il est débranché, l'appareil continuera à fonctionner. La tension à vide aux **bornes de sortie** sera supérieure à la valeur programmée car le point de régulation est maintenant maintenu par des résistances internes de protection de mesure. La tension réelle aux bornes de sortie sera supérieure par le pourcentage indiqué ci-dessous, même si la tension de relecture reflète toujours la valeur programmée.

Modèle	Δ Augmentation de la tension de sortie
RP7972A, RP7982A	1%
RP7973A, RP7983A, RP7984A	1,65%

### Connexions de barre conductrice

#### AVERTISSEMENT

**RISQUE D'ÉLECTROCUTION, TENSION LÉTALES** De nombreux modèles génèrent des tensions allant jusqu'à 2 000 V CC ! Assurez-vous que toutes les connexions des instruments, le câblage de charge ainsi que les connexions de charge et de mesure sont isolés à l'aide de fils haute tension. Fixez toujours le capot de sécurité fourni, de sorte qu'aucun contact accidentel avec des tensions mortelles ne puisse se produire.

Les facteurs suivants doivent être pris en compte lors du raccordement de la charge à l'alimentation :

- Température du fil de charge, capacité de transport de courant et chute de tension
- La valeur nominale de l'isolation des fils de charge et de mesure doit être équivalente à la valeur nominale de tension de sortie
- Effets du bruit et de l'impédance sur les fils de charge

### Section des fils

**AVERTISSEMENT** **RISQUE D'INCENDIE** Pour satisfaire aux exigences de sécurité, les fils de charge doivent avoir une section suffisante pour ne pas surchauffer lors du passage du courant de sortie de court-circuit maximal. En présence de charges multiples, toute paire de fils de charge doit pouvoir conduire en toute sécurité le courant nominal maximal de l'appareil. Des fils de charge connectés en parallèle peuvent être nécessaires pour les modèles ayant un courant permanent admissible supérieur.

Le tableau suivant répertorie les caractéristiques du fil de cuivre AWG (American Wire Gauge).

AWG	Équivalent en mm <sup>2</sup>	Format métrique le plus proche	Courant permanent admissible (remarque 1)	Résistance (remarque 2)
18	0,82	1,0 mm <sup>2</sup>	Jusqu'à 14 A	6,385 Ω
16	1,31	1,5 mm <sup>2</sup>	Jusqu'à 18 A	4,016 Ω
14	2,1	2,5 mm <sup>2</sup>	Jusqu'à 25 A	2,525 Ω
12	3,3	4 mm <sup>2</sup>	Jusqu'à 30 A	1,588 Ω
10	5,3	6 mm <sup>2</sup>	Jusqu'à 40 A	0,999 Ω
8	8,4	10 mm <sup>2</sup>	Jusqu'à 60 A	0,628 Ω
6	13,3	16 mm <sup>2</sup>	Jusqu'à 80 A	0,395 Ω
4	21,2	25 mm <sup>2</sup>	Jusqu'à 105 A	0,248 Ω
2	33,6	35 mm <sup>2</sup>	Jusqu'à 140 A	0,156 Ω

Remarque 1 Le courant permanent admissible est basé sur un seul conducteur **à l'air libre**, température ambiante comprise entre 26 et 30 °C, le conducteur étant calibré à 60 °C. Le courant permanent admissible diminue à des températures plus élevées.

Remarque 2 La résistance est exprimée en ohms/300 m (1 000 pieds) à une température de fil de 20 °C.

En plus du courant permanent admissible, vous devez également tenir compte de la chute de tension dans le câble de charge due aux fils de dimensionnement de la résistance. Le bloc d'alimentation tolère une chute de tension de 1 V par fil tout en assurant la précision de la programmation spécifiée, de la mesure et de la régulation de charge (voir les **spécifications**). Des chutes de tension allant jusqu'à 25 % de la tension de sortie nominale par conducteur seront tolérées. Ce qui se traduira par une régulation de tension supplémentaire de 4 mV pour chaque volt supplémentaire abandonné par fil de charge. Naturellement, toute chute de tension dans les fils de charge réduit la tension maximale disponible au niveau de la charge. Soustrayez la chute de tension dans les fils de charge de la tension de sortie nominale de l'appareil pour déterminer la tension maximale disponible au niveau de la charge.

## Connexions de charge unique

1. Comme illustré dans la figure suivante, dotez tous les fils de charge de cosses solidement fixées aux bornes. N'utilisez pas de fils nus pour raccorder la charge au bloc d'alimentation.
2. Faites passer les fils à travers le capot de sécurité avant de les fixer aux barres conductrices. Des alvéoles perforables sont prévues pour les fils d'un diamètre supérieur. La figure illustre le matériel recommandé pour brancher les fils aux barres conductrices. Vous devez fournir tout le câblage. Assurez-vous que le matériel de montage des fils ne court-circuite pas les bornes de sortie.
3. Lorsque vous fixez les cosses de raccordement aux barres conductrices, ne placez pas de rondelles ou d'autres éléments entre la cosse et la barre conductrice. Assurez-vous qu'il y a suffisamment de place pour le capot de sécurité. Torsadez ou rassemblez les fils de charge afin de réduire les effets d'inductance et du bruit. L'objectif est de réduire les surfaces de boucle ou l'espace physique entre les fils de sortie + et - des barres conductrices et la charge.
4. **Fixez le capot de sécurité au panneau arrière.** Veillez à ne pas pincer les fils de mesure lorsque vous fixez le capot. Notez que les câbles lourds doivent être munis de dispositifs réducteurs de contrainte pour éviter la torsion du capot de sécurité ou des barres conductrices.

**ATTENTION** Le couple de serrage des boulons 8,8 mm ne doit pas dépasser 10,8 Nm. Le couple de serrage des boulons 5,5 mm ne doit pas dépasser 4,8 Nm.

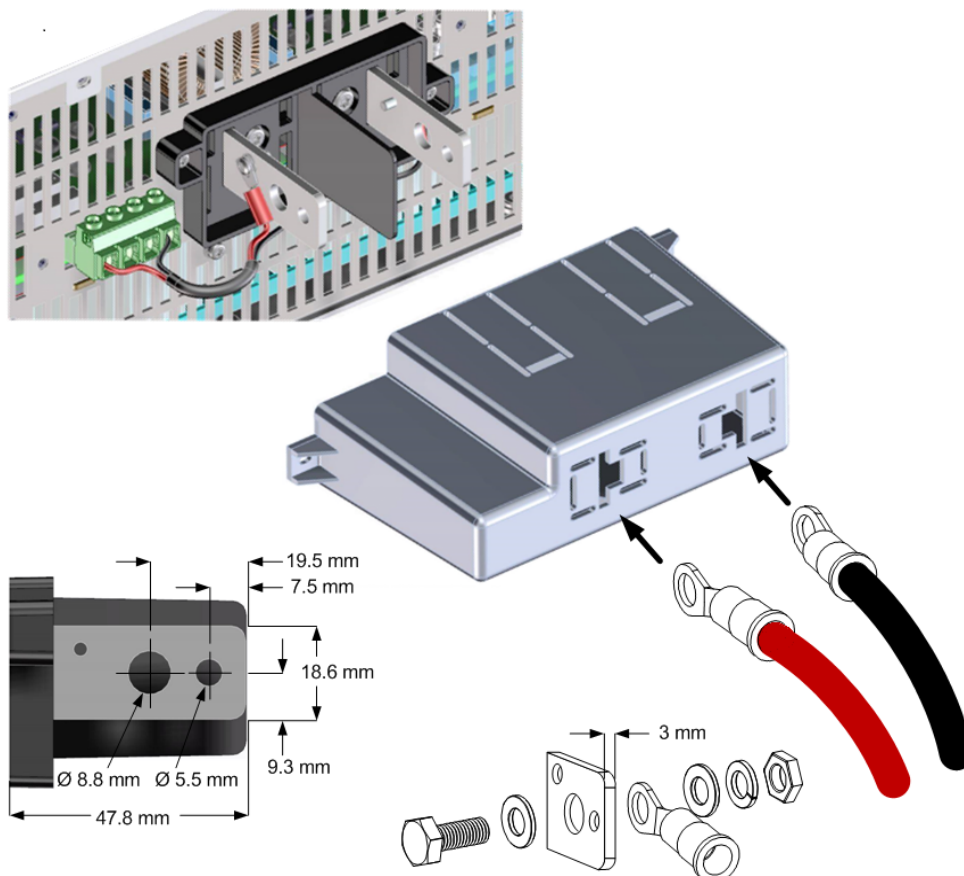

### Installation du noyau de ferrite : pour les modèles RP7973A, RP7982A, RP7983A uniquement

Pour les appareils concernés, installez le noyau de ferrite fourni pour réduire les interférences électromagnétiques (EMI).

Passez chaque fil de sortie trois fois dans le noyau. Si vous utilisez la télédétection (non illustrée), faites également passer chaque sonde par le noyau trois fois.

Placez le noyau le plus près possible du capot de sortie tel qu'illustré.

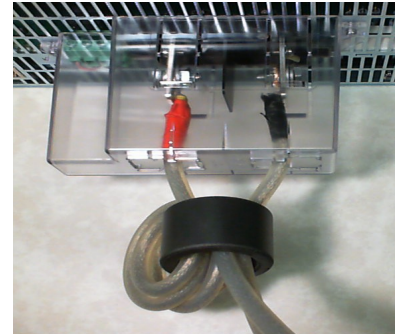

### Connexions de charges multiples

#### AVERTISSEMENT

**RISQUE D'ÉLECTROCUTION, TENSION LÉTALES** De nombreux modèles génèrent des tensions allant jusqu'à 2 000 V CC ! Assurez-vous que toutes les connexions des instruments, le câblage de charge ainsi que les connexions de charge et de mesure sont isolés à l'aide de fils haute tension. Fixez toujours le capot de sécurité fourni, de sorte qu'aucun contact accidentel avec des tensions mortelles ne puisse se produire.

Si vous utilisez les mesures locales et connectez plusieurs charges à une sortie, branchez chacune d'elles aux bornes de sortie à l'aide de fils de connexion distincts comme indiqué sur la figure suivante. Cela réduit les effets de couplage mutuel et permet de profiter pleinement de la faible impédance de sortie du bloc d'alimentation. Maintenez la paire de fils aussi courte que possible ; torsadez ou regroupez-la afin de réduire les effets d'inductance et de bruit. L'objectif est de réduire les surfaces de boucle ou l'espace physique entre les fils de sortie + et - des barres conductrices et la charge.

Si des considérations de charge requièrent l'utilisation de bornes situées à distance du bloc d'alimentation, torsadez ou rassemblez les fils entre les bornes de sortie et les bornes de distribution à distance. Branchez chaque charge séparément aux bornes de distribution. La régulation à distance de la tension est recommandée dans ces circonstances. Effectuez la mesure sur les bornes de distribution à distance ou, si une charge est plus sensible que les autres, directement sur cette dernière.



## 2 Installation de l'instrument

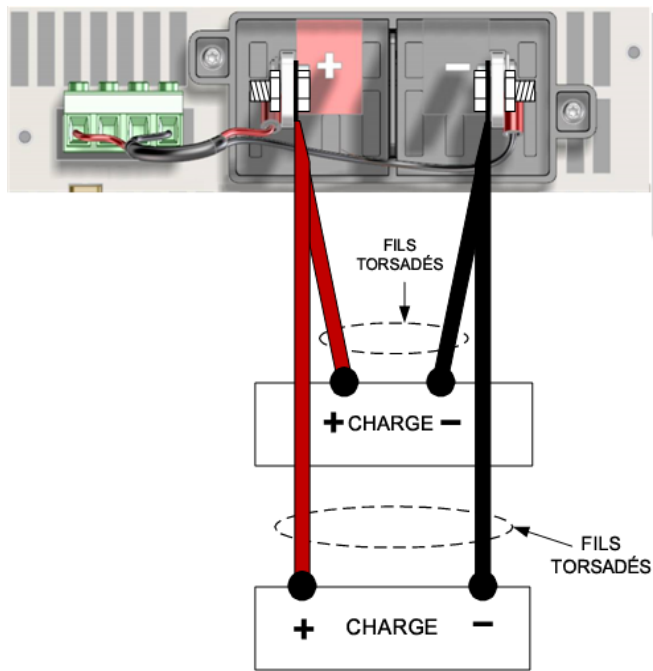

### Connexions de mesure à distance

#### AVERTISSEMENT

**RISQUE D'ÉLECTROCUTION, TENSION LÉTALES** De nombreux modèles génèrent des tensions allant jusqu'à 2 000 V CC ! Assurez-vous que toutes les connexions des instruments, le câblage de charge ainsi que les connexions de charge et de mesure sont isolés à l'aide de fils haute tension. Fixez toujours le capot de sécurité fourni, de sorte qu'aucun contact accidentel avec des tensions mortelles ne puisse se produire.

La mesure à distance améliore la régulation de la tension au niveau de la charge en la contrôlant directement en ce point plutôt qu'aux bornes de sortie. Ainsi, le bloc d'alimentation peut compenser automatiquement la chute de tension dans les fils de charge. La mesure à distance est particulièrement utile dans le cadre du fonctionnement en tension constante où les impédances de charge varient ou dont les fils présentent une résistance de fil de charge significative. En mode de priorité de courant, les réglages de la limite de tension sont surveillés aux connexions de mesure. La protection contre les surtensions est également surveillée au niveau des connexions de mesure.

Branchez l'appareil pour une mesure à distance en retirant d'abord le câble de mesure local reliant les bornes de mesure aux bornes de charge. Réalisez ensuite vos connexions de charge et de mesure (voir la figure ci-dessous). Notez que les deux bornes centrales du connecteur de détection ne sont pas utilisées.

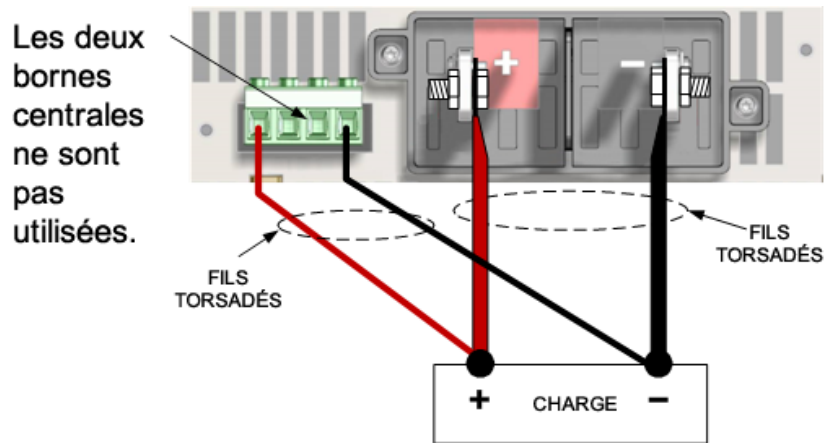

Maintenez les sections de fils de connecteurs de mesure comprises entre 1,5 mm<sup>2</sup> (AWG 16) maximum et 0,2 mm<sup>2</sup> (AWG 24) minimum. Retirez l'isolant du fil sur 10 mm. Serrez fermement les vis.

Connectez les fils de mesure aussi près que possible de la charge. Raccourcissez autant que possible la paire de fils de mesure, et torsadez-les ou rassemblez-les afin de réduire les effets de bruit. Ne regroupez PAS la paire de fils torsadée et les fils de charge ; maintenez les fils de charge à l'écart des fils de mesure. La section des fils de mesure est normalement inférieure à celle du câblage de charge.

Il est à noter que toute chute de tension dans les fils de mesure peut nuire à la régulation de la tension de sortie. Lorsque la chute de tension dans les fils de charge augmente, l'erreur de régulation de la tension de charge due à la résistance des fils de mesure augmente selon la formule suivante :

$$\Delta V_{\text{regulation}} = 2(V_{\text{load}}(R_{\text{sense}}/S_{\text{protect}}))$$

$R_{\text{sense}}$  est la résistance en ohms de chaque fil de mesure.

$V_{\text{load}}$  est la chute de tension dans chaque fil de mesure.

$S_{\text{protection}}$  est la résistance de protection interne de mesure (voir le tableau suivant).

La formule suppose que la chute de tension dans les fils de charge +/- est égale.

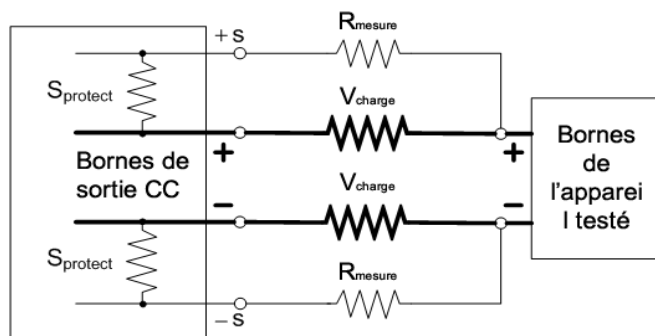

Modèle	Résistance $S_{\text{protect}}$	Modèle	Résistance $S_{\text{protect}}$
RP7972A, RP7982A	198 k $\Omega$	RP7984A	108 k $\Omega$
RP7973A, RP7983A	60 k $\Omega$		

Si les fils de mesure à distance s'ouvrent lors du fonctionnement en tension constante normale (en présence de courant de sortie), la variation de la tension de sortie **à la charge** dépend du courant de

## 2 Installation de l'instrument

charge et des résistances des fils concernés. Lorsque les fils de mesure s'ouvrent, l'appareil revient automatiquement à la mesure locale. La tension au point de mesure à distance précédent (habituellement à la charge) change d'une valeur donnée selon l'équation suivante :

$$\Delta V = K(V_{\text{set}}) - I_{\text{out}} \times (\text{résistance totale des fils de charge})$$

$K = 1\%$  pour les modèles 1 kV,  $1,2\%$  pour les modèles 1,5 kV et  $1,65\%$  pour les modèles 2 kV

$I_{\text{out}}$  = positif lorsque l'appareil fournit du courant d'alimentation ; négatif lorsque l'appareil fournit du courant d'absorption

Les fils de mesure en court-circuit sont détectés par la fonction de protection contre les surtensions. Cette fonction entraîne la désactivation de la sortie en raison d'une erreur de surtension (OV). Les fils de mesure inversés sont détectés par la fonction de protection contre les surtensions négatives. Cette fonction entraîne la désactivation de la sortie en raison d'une erreur de surtension négative (OV-). Reportez-vous aux **Autres considérations relatives à la charge** pour obtenir des informations sur l'inductance des fils lors de l'utilisation de la télédétection avec la capacité de charge et l'inductance des fils.

### Protection contre les surtensions

La fonctionnalité de protection contre les surtensions (OVP) assure une protection contre les surtensions configurable basée sur la tension des fils de mesure. Demander au circuit OVP de surveiller la tension des fils de mesure plutôt que la tension des bornes de sortie permet de contrôler plus précisément la tension directement sur la charge.

Notez qu'en cas de chute de tension dans les fils de charge, la tension mesurée à la sortie de l'alimentation peut être supérieure à celle qui est régulée au niveau de la charge. La tension aux bornes de sortie de l'alimentation ne devrait jamais dépasser la tension nominale de l'appareil.

### Bruit de sortie

Les bruits captés sur les fils de mesure apparaissent au niveau des bornes de sortie et peuvent avoir un effet néfaste sur la régulation de la charge CV. Torsadez les fils de mesure pour capter moins de bruits externes. Dans les environnements extrêmement bruyants, il peut être nécessaire de blinder les fils de mesure. Mettez le blindage à la terre seulement à l'extrémité du bloc d'alimentation ; n'utilisez pas le blindage comme conducteur de mesure.

Les spécifications de bruit décrites dans les tableaux de **spécification** s'appliquent aux bornes de sortie lorsque l'appareil est utilisé pour des mesures locales. Il se peut toutefois que des transitoires de tension soient générés au niveau de la charge par le bruit induit dans les fils ou par les états transitoires de courant de la charge agissant sur l'inductance et la résistance du fil de charge. S'il est souhaitable de conserver les niveaux de transitoires de tension au minimum, placez en travers de la charge un condensateur à couche haute tension avec une valeur de 10 microfarad/pied (30,5 cm) de fil de charge environ.

### Autres considérations relatives à la charge

#### Temps de réponse avec un condensateur externe

Lors d'une programmation en amont ou d'une programmation en aval de la tension de sortie avec un condensateur de charge externe, le temps de réponse de la tension peut être plus long qu'avec des charges purement résistives. En effet, l'alimentation électrique peut entrer en mode de fonctionnement à courant constant, ce qui ajoute un temps de réponse supplémentaire. En définissant le balayage de tension approprié lors de l'utilisation d'un condensateur externe, il peut être possible d'empêcher le basculement en mode de courant constant. La formule suivante permet d'évaluer le temps de réponse supplémentaire dû à la programmation :

$$\text{Temps de réponse} = \frac{(\text{condensateur de sortie ajouté} + C_x) \times (\text{changement de tension de sortie } V_{out})}{(\text{valeur limite de courant}) - (\text{courant de charge})}$$

Modèle	Capacité interne $C_x$	Modèle	Capacité interne $C_x$
RP7972A/ RP7982A	8,8 à 13,2 $\mu\text{F}$	RP7984A	2,1 $\mu\text{F}$
RP7973A/ RP7983A	2,2 à 1,5 $\mu\text{F}$		

### Tensions positive, négative et flottante

Vous pouvez obtenir des tensions positives ou négatives à la sortie par rapport à la masse en mettant l'une des bornes de sortie à la terre (commun). Utilisez toujours deux fils pour relier la charge à la sortie, quel(le) que soit l'emplacement ou la méthode de mise à la terre du système.

- Les appareils 1 000 V peuvent fonctionner avec toute borne de sortie portée à une tension de  $\pm 1\,000$  V CC, tension de sortie par rapport à la terre comprise.
- Les appareils 1 500 V et 2 000 V peuvent fonctionner avec toute borne de sortie portée à une tension de  $\pm 2\,000$  V CC, tension de sortie par rapport à la terre comprise.

**REMARQUE** Les modules d'alimentation Keysight sont optimisés pour une mise à la terre de la borne de sortie négative. La mise à la terre de la borne positive peut provoquer une augmentation du bruit de mesure du courant et une réduction de la précision de mesure du courant.

### Limites d'inductance de charge

**ATTENTION** DÉGÂTS MATÉRIELS. Les fixations internes du niveau de tension de l'appareil peuvent être endommagées thermiquement lorsque la sortie est coupée brusquement à pleine charge si l'inductance du fil dépasse l'inductance de charge maximale sous **Caractéristiques supplémentaires**.

Comme point de référence d'inductance des fils, une seule paire de fils de charge produit habituellement entre 500 nH et 1  $\mu\text{H}$  par mètre de longueur couplée (aller-retour), selon la section du fil, l'épaisseur de l'isolation et le couplage mécanique des fils. Pour obtenir de plus grandes longueurs de fil, l'inductance des fils peut être réduite au minimum en mettant en parallèle des faisceaux de fils de charge supplémentaires ou en utilisant un câblage spécialisé à faible inductance.

### Capacité de charge et considérations relatives à l'inductance des fils lors d'un fonctionnement en tension constante (CV)

Lors d'un fonctionnement CV, en mode de priorité de tension et en mode de priorité de courant (lorsque l'appareil se trouve en limite de tension), la configuration ressemble habituellement à celle de la figure suivante où l'appareil testé est de nature résistive ou à impédance élevée et peut avoir une certaine capacité de dérivation locale près de ses propres bornes. Il est recommandé d'utiliser la mesure à distance au niveau des bornes de l'appareil testé lorsqu'une régulation précise de la tension continue est nécessaire.

RP797xAet RP798xA

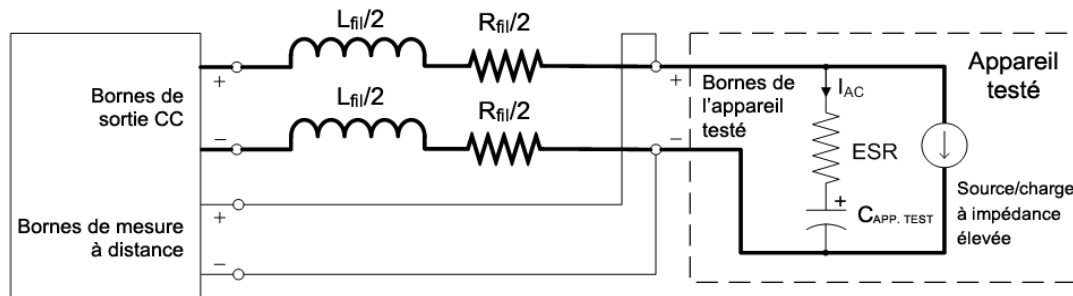

Lors d'un fonctionnement CV, les charges capacitatives importantes et des fils à inductance élevée peuvent créer une suroscillation et une tension dynamiquement instable au niveau de l'appareil testé lors de variations brutales de la charge ou de la tension. L'ESR tend à atténuer ce phénomène en amortissant la résonance qui se produit entre la capacité de charge et l'inductance des fils. La résistance des fils contribue aux effets d'amortissement de l'ESR, mais augmente également la chute de tension et la dissipation de puissance dans les fils de charge. Les graphiques des caractéristiques de la **limite de charge capacitive** ont des lignes directrices pour l'ESR minimum requis en fonction de la capacité de l'appareil testé. Il s'agit d'une fonction du **mode de compensation** de la tension.

Dans le cas d'un appareil testé qui a une capacité interne avec un ESR faible, comme le montrent les graphiques des limites de charge capacitive, tel que les condensateurs à couche ou les condensateurs céramiques, il est possible d'ajouter une capacité et une résistance en série supplémentaires en parallèle pour atténuer les effets de suroscillation, comme l'illustre la figure suivante. La capacité supplémentaire doit être d'au moins 1 à 4 fois la valeur de  $C_{DUT}$  et l'ESR désiré doit être choisi en fonction des tracés de limites de charge capacitive pour le  $C_{DUT}$ . Cela peut être réalisé par l'ajout d'un condensateur à couche haute tension et d'une résistance en série. La capacité parallèle et l'ESR doivent être en mesure de satisfaire aux exigences spécifiques à l'appareil testé, telles que l'ondulation du courant ou de la tension. De plus, la capacité parallèle limitera la capacité de l'alimentation à mesurer des fronts de courant rapides provenant directement de l'appareil testé, ainsi qu'à ralentir la vitesse de programmation de la tension et la bande passante.

Réseau amortisseur typique externe

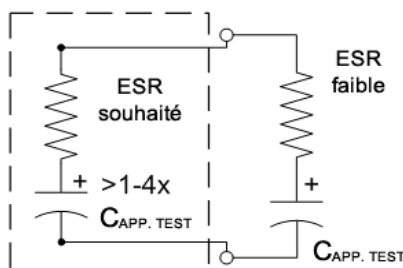

La réponse transitoire de tension spécifiée à un palier de courant de charge pour l'alimentation peut se dégrader en cas de mesure à distance avec de longs fils de charge, en particulier avec une faible capacité de dérivation au niveau de l'appareil testé. Cela peut se manifester par un mauvais amortissement de l'oscillation ou même par un bon amortissement de la réponse bien avec une variation maximale très importante. Cette question peut être particulièrement problématique lorsque l'on travaille à une tension plus basse avec un courant plus élevé. Pour atténuer ce phénomène, il est possible d'ajouter une capacité parallèle aux bornes concernées afin de réduire l'amplitude de la variation de tension. Il est probable qu'un réseau d'amortissement parallèle externe, comme illustré précédemment, soit nécessaire à la place ou en plus d'un condensateur pur. Généralement, un condensateur à faible ESR connecté en parallèle avec un condensateur à ESR élevé permet une bonne stabilité, une variation minimale de la tension de réponse transitoire, ainsi qu'un bon filtrage du bruit de tension.

### Considérations relatives à l'inductance du fil lors d'un fonctionnement à courant constant (CC)

Lors d'un fonctionnement CC, en mode de priorité de courant et en mode de priorité de tension (lorsque l'appareil se trouve en limite de courant), la configuration ressemble habituellement à celle de la figure suivante où l'appareil testé a une faible impédance ou source de tension. Les mesures de fils de mesure sont toujours utilisées pour détecter les événements de protection contre les surtensions/sous-tensions et lors du passage en mode CV.

RP797xAet RP798xA

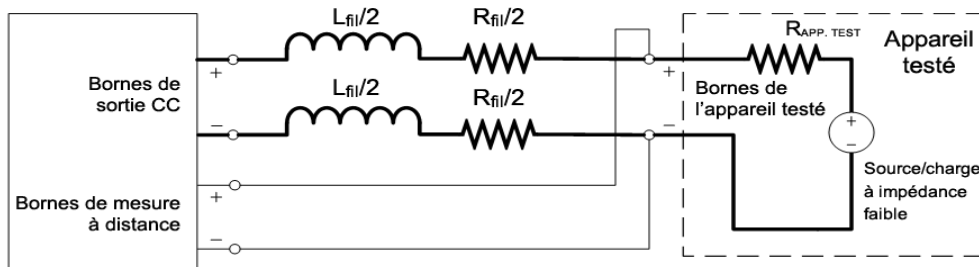

Lors d'un fonctionnement CC, de gros fils inductifs peuvent créer des suroscillations dans le courant de sortie lors des paliers de programmation du courant ou des variations de la tension de charge. Cet effet augmente à mesure que l'inductance augmente et que la résistance des fils diminue. Les graphiques des caractéristiques de la **limite de charge inductive** montrent la résistance minimale du fil pour atténuer le dépassement et la réponse instable de la programmation. Notez qu'il n'y a pas de condensateur de dérivation au niveau de l'appareil testé, la résistance du fil et celle de l'appareil testé sont indifférenciables dans ce contexte. Donc la résistance de l'appareil testé est ajoutée à la résistance effective des fils indiquée dans les graphiques.

### Programmation dynamique du courant avec de fortes charges inductives

D'autres contraintes peuvent être nécessaires lors de la programmation des paliers de courant avec des appareils testés ou des fils à inductance élevée. Lors de la programmation de paliers de courant importants, une dégradation supplémentaire de la vitesse et des dépassements peut survenir en raison des limites de tension inhérentes à l'alimentation. Sans réduction de l'inductance, il est impossible d'améliorer la dégradation de la vitesse. Cependant, il est possible d'atténuer ou de supprimer l'aspect de dépassement en diminuant progressivement le réglage du **pôle de programmation** ou de la **vitesse de balayage** jusqu'à ce que la performance souhaitée soit atteinte.

### Courant excessif en mode de priorité de courant

**ATTENTION**

Un courant de sortie excessif peut endommager l'appareil testé dans certaines conditions. Cela peut se produire, par exemple, si l'appareil testé court-circuite la sortie de l'instrument lorsque la limite inférieure de tension est réglée sensiblement au-dessus de zéro.

---

En mode priorité de courant, si la tension d'un appareil testé à faible impédance, comme une batterie ou un court-circuit, dépasse la limite supérieure de tension ou passe en dessous de la limite inférieure de tension, le courant peut dépasser la valeur nominale en régime permanent de l'appareil et potentiellement endommager l'appareil testé. Après un court délai, le flux de courant excessif entraînera l'activation de la protection contre les surintensités, ce qui désactivera la sortie de l'appareil.

## Connexions de sortie de plusieurs appareils

### Connexions en parallèle

### Connexions de mesure et de charge

### Connexions principale/secondaire

### Connexions en série

## Connexions en parallèle

Le fonctionnement en parallèle vous permet de connecter plusieurs alimentations pour créer un système avec un courant et une puissance totale plus élevés. Ceci s'applique aussi bien à l'alimentation en courant qu'à l'opération d'absorption de courant.

#### AVERTISSEMENT

**RISQUE D'ÉLECTROCUTION** Tous les appareils en parallèle doivent être raccordés à la masse en permanence par un cordon d'alimentation mis à la terre. Toute interruption du conducteur de protection (mise à la terre) ou tout débranchement de la borne de terre de protection d'un appareil vous expose à un risque d'électrocution susceptible de provoquer des blessures ou la mort.

#### ATTENTION

Pour éviter d'éventuels dommages de l'équipement :

- Ne connectez pas plus de vingt appareils **de tensions nominales identiques**. Tous les appareils doivent avoir la même tension, mais les valeurs nominales de courant peuvent varier. Tous les appareils doivent disposer de la même version du micro-programme. Reportez-vous au chapitre **Identification de l'instrument** pour la version du microprogramme.
- Activez et désactivez toujours simultanément l'**alimentation CA**. Ne laissez jamais d'appareils sous tension lorsque les autres sont éteints.

## Connexions de mesure et de charge

Les figures suivantes illustrent trois appareils connectés en parallèle. Observez les recommandations suivantes :

- Installez toujours les appareils connectés en parallèle relativement près les uns des autres.
- Raccourcissez autant que possible les câbles entre les systèmes d'alimentation et la charge, et torsadez ou rassemblez les fils afin de réduire les effets d'inductance et de bruit. L'objectif est de réduire les surfaces de boucle ou l'espace physique entre les fils de sortie + et - des barres conductrices et la charge.



## 2 Installation de l'instrument

- Si les appareils ne peuvent pas être situés les uns à proximité des autres, une configuration asymétrique de paires de fils conducteurs de charge distinctes de longueur **égale** connectées à un point de charge commun est hautement recommandée. Cela permet d'obtenir la meilleure réponse dynamique possible.
- Les barres conductrices peuvent être utilisées pour connecter en parallèle les bornes de sortie dans une configuration en pile. Vérifiez que la section des barres conductrices s'adapte au courant de sortie total de la pile. Des barres conductrices peuvent être placées de chaque côté des bornes de sortie. Les surfaces exposées des barres conductrices doivent être enfermées dans une armoire ou isolées afin d'éviter tout contact accidentel avec des tensions mortelles.
- Utilisez la télédétection pour maintenir la régulation de charge spécifiée avec des appareils en parallèle. Les fils de détection peuvent être connectés en chaîne ou directement au point de détection de la charge. Torsadez la paire de fils de mesure. N'utilisez pas la mesure à distance en même temps que la mesure locale.

Même si la figure suivante illustre l'utilisation recommandée de la mesure locale, cette fonction peut être utilisée en cas d'absolue nécessité. Cependant, dans le cas de la mesure locale, les circuits de partage ne fonctionneront correctement que si la chute de tension mesurée *entre* les points de mesure locaux d'un appareil et ceux d'un autre appareil connecté en parallèle est inférieure à 0,5 % de la tension nominale maximale des appareils.

### Exemple de connexion en parallèle

#### AVERTISSEMENT

**RISQUE D'ÉLECTROCUTION, TENSION LÉTALES** De nombreux modèles génèrent des tensions allant jusqu'à 2 000 V CC ! Assurez-vous que toutes les connexions des instruments, le câblage de charge ainsi que les connexions de charge et de mesure sont isolés à l'aide de fils haute tension. Fixez toujours le capot de sécurité fourni, de sorte qu'aucun contact accidentel avec des tensions mortelles ne puisse se produire.

---

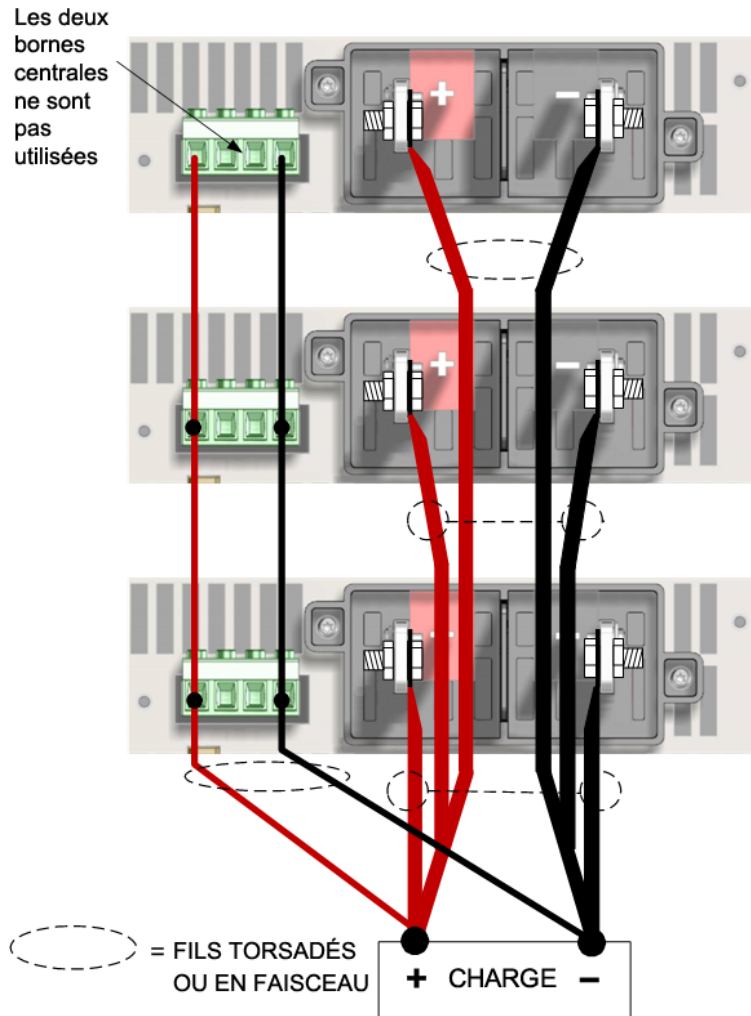

### Connexions principale/secondaire

Une configuration principale/secondaire peut être utilisée pour connecter des appareils en parallèle. Cela permet à un appareil désigné d'agir en tant que contrôleur principal de tous les appareils de la pile connectée en parallèle. La communication principale/secondaire utilise un bus numérique RS485. Les connexions sont effectuées à l'aide du câble CAT6A blindé fourni, comme le montre la figure suivante. Pour plus d'informations sur les configurations principale/secondaire, reportez-vous au **Fonctionnement en parallèle**.

La figure détaille également les paramètres des commutateurs de terminaison pour la pile en parallèle. L'appareil désigné comme l'appareil principal doit être situé à une extrémité de la pile en parallèle avec son interrupteur réglé comme indiqué dans la figure « terminaison principale ». L'autre appareil terminal de la pile doit avoir son commutateur réglé comme indiqué dans la figure « Terminaison finale ». Les commutateurs des appareils intermédiaires doivent être réglés sur « Terminaisons ouvertes ». Si seulement deux appareils sont connectés dans une configuration principale/secondaire, un appareil doit avoir ses commutateurs définis pour une terminaison principale et l'autre pour une terminaison finale. Une erreur de partage de courant (CSF) peut se produire si les commutateurs sont mal réglés.

## 2 Installation de l'instrument

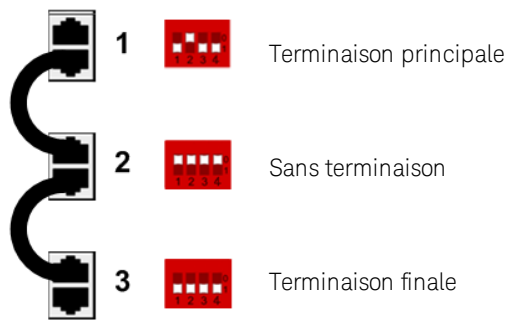

N'installez pas d'appareils dans une configuration principale/secondaire qui n'est pas activement utilisée dans le cadre du groupe principal/secondaire.

### Connexions en série

Les connexions en série ne sont autorisées en aucune circonstance.

**AVERTISSEMENT**

**RISQUE D'ÉLECTROCUTION/TENSIONS LÉTHALES** Les connexions en série ne sont pas autorisées pour de nombreuses raisons. L'une des raisons est que le dépassement des tensions flottantes maximales indiquées dans les tableaux de caractéristiques est extrêmement dangereux et qu'il est impossible de garantir un équilibre de tension sûr lors de l'utilisation d'instruments bidirectionnels en série.

---

## Connexions de l'interface

### Connexions GPIB

### Connexions USB

### Connexions réseau (LAN) - locales et privées

### Connexions du port numérique

### Installation du capot de l'interface

Cette section décrit la procédure à suivre pour connecter les diverses interfaces de communication à votre appareil. Pour de plus amples informations sur la configuration des interfaces de commande à distance, reportez-vous à la section **Configuration des interfaces de commande à distance**.

Si ce n'est pas déjà fait, installez la dernière version de Keysight IO Libraries Suite à partir de [www.keysight.com](http://www.keysight.com).

**REMARQUE** Pour de plus amples informations sur les connexions des interfaces, reportez-vous au document Keysight Technologies USB/LAN/GPIB Interfaces Connectivity Guide (en anglais), fourni avec la suite Keysight IO Libraries.

## Connexions GPIB

La figure ci-dessous illustre un système d'interface GPIB classique.

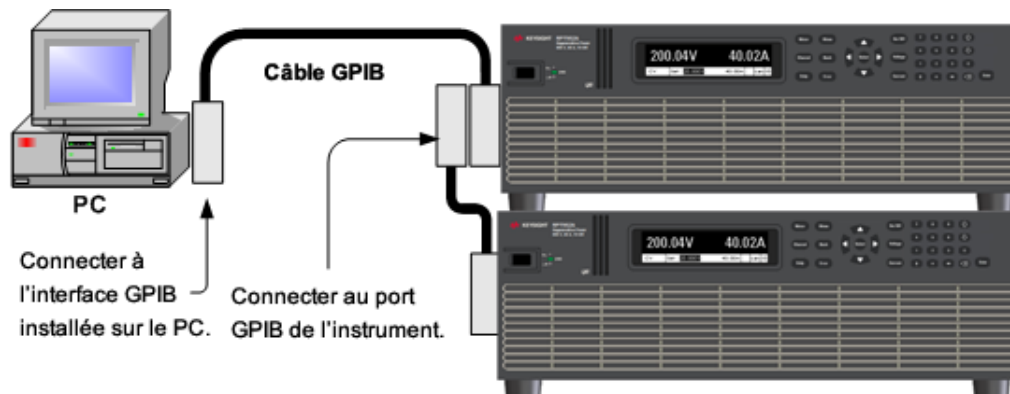

1. Branchez votre instrument à la carte d'interface GPIB à l'aide d'un câble GPIB.
2. Utilisez l'utilitaire Connection Expert de la suite Keysight IO Libraries Suite pour configurer les paramètres de la carte GPIB.
3. Vous pouvez désormais utiliser Interactive IO depuis l'utilitaire Connection Expert pour communiquer avec votre instrument, ou le programmer à l'aide des divers environnements de programmation.

## Connexions USB

La figure ci-dessous illustre un système d'interface USB classique.

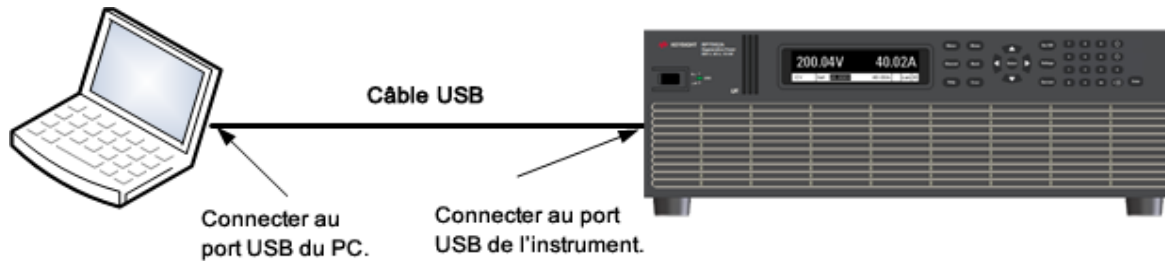

1. Branchez votre instrument au port USB de votre ordinateur.
2. Une fois l'utilitaire Connection Expert de la suite Keysight IO Libraries Suite exécuté, l'ordinateur reconnaît automatiquement l'instrument. Cette opération peut durer quelques secondes. Une fois l'instrument reconnu, votre ordinateur affiche l'alias VISA, la chaîne IDN et l'adresse VISA. Ces informations sont situées dans le dossier USB.
3. Vous pouvez désormais utiliser Interactive IO depuis l'utilitaire Connection Expert pour communiquer avec votre instrument, ou le programmer à l'aide des divers environnements de programmation.

## Connexions réseau (LAN) - locales et privées

Un LAN de site est un réseau local dans lequel les instruments et les ordinateurs sont connectés au réseau au moyen de routeurs, de concentrateurs et/ou de commutateurs. Il s'agit habituellement de grands réseaux administrés de manière centralisée, avec des services tels que des serveurs DHCP et DNS. La figure ci-dessous illustre un système LAN de site classique.

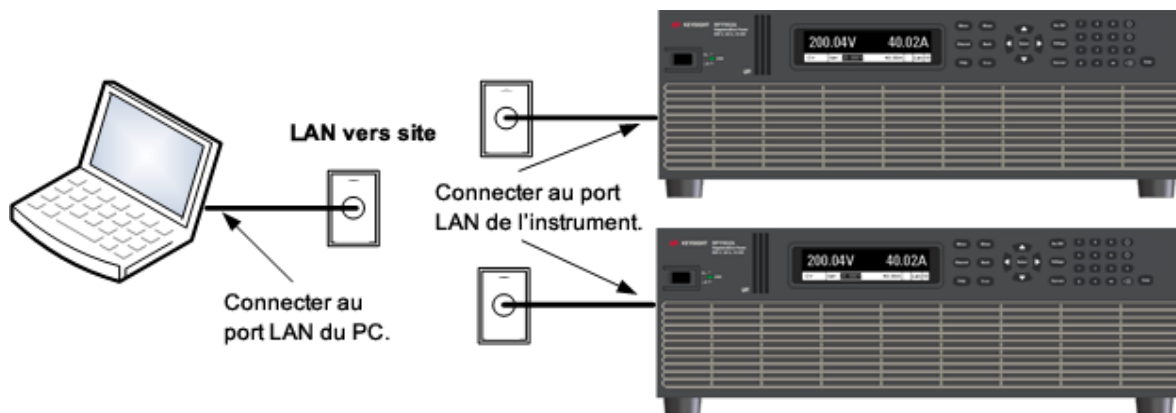

Un LAN privé est un réseau dans lequel les instruments et les ordinateurs sont reliés directement, et non branchés à un LAN de site. Il s'agit habituellement de petits réseaux, sans ressources administrées de manière centralisée. La figure ci-dessous illustre un système LAN privé classique.

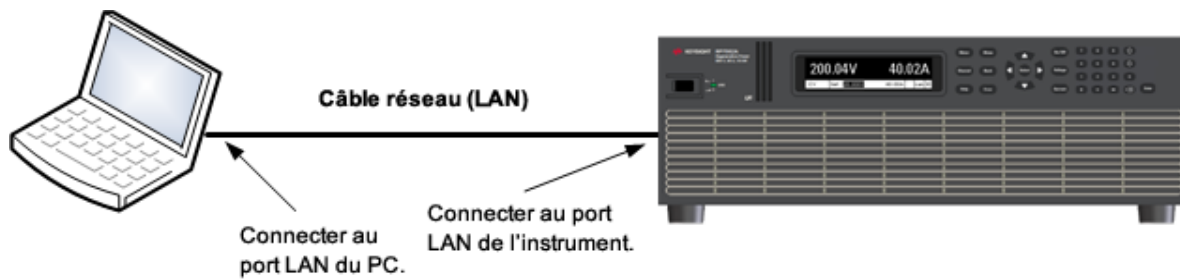

1. Branchez l'instrument au LAN de site ou à votre ordinateur à l'aide d'un câble LAN. Les paramètres LAN de l'instrument sont configurés en usine pour obtenir automatiquement une adresse IP du réseau à l'aide d'un serveur DHCP (DHCP est activé). Le serveur DHCP enregistre le nom d'hôte de l'instrument avec le serveur DNS dynamique. Le nom d'hôte ainsi que l'adresse IP permettent alors de communiquer avec l'instrument. Si vous utilisez un LAN privé, vous pouvez laisser tous les paramètres LAN tels quels. La plupart des produits Keysight et des ordinateurs choisissent automatiquement une adresse IP via l'option Auto-IP s'il n'existe pas de serveur DHCP. Chacun s'auto-attribue une adresse IP à partir du bloc 169.254.nnn. Le voyant **Lan** du panneau avant s'allume lorsque le port LAN a été configuré.
2. L'utilitaire Connection Expert de la Suite Keysight IO Libraries Suite permet d'ajouter l'instrument et de vérifier une connexion. Pour ajouter l'instrument, demandez à Connection Expert de le rechercher. Si l'instrument demeure introuvable, ajoutez-le à l'aide de son nom d'hôte et de son adresse IP.
3. Vous pouvez désormais utiliser Interactive IO depuis l'utilitaire Connection Expert pour communiquer avec votre instrument, ou le programmer à l'aide des divers environnements de programmation. Vous pouvez également utiliser le navigateur Web de votre ordinateur pour communiquer avec l'instrument comme décrit dans la section **Utilisation de l'interface Web**.

## Connexions du port numérique

### REMARQUE

Il est recommandé d'un point de vue technique de torsader ou de blinder tous les fils de signaux en direction et en provenance du connecteur numérique. Si les fils utilisés sont blindés, branchez uniquement une extrémité du blindage à la masse du châssis afin d'éviter les boucles de masse.

Un connecteur à 8 broches et une prise de déconnexion rapide sont fournis pour accéder aux fonctions du port numérique. Retirez la prise de connecteur avant de brancher les fils. Le bouchon accepte des fils de section comprise entre 1,5 mm<sup>2</sup> (AWG 14) et 0,14 mm<sup>2</sup> (AWG 28). Il n'est pas recommandé d'utiliser des fils d'une section inférieure à 0,25 mm<sup>2</sup> (AWG 24). Dénudez 7 mm de l'isolation des fils.

## 2 Installation de l'instrument

1. Insertion des fils
2. Serrage des vis
3. Broches de défaillance/inhibition configurables (observer la polarité INH)
4. Broches de couplage de sorties configurables
5. Broches E/S numériques configurables
6. Commun des signaux

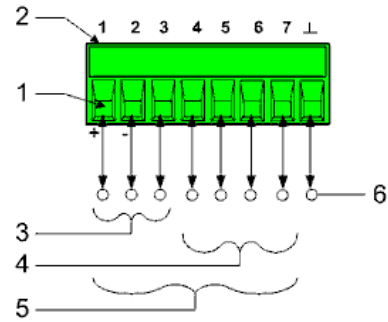

Pour plus d'informations sur l'utilisation du port numérique, reportez-vous à section **Programmation du port numérique**. Les caractéristiques électriques sont décrites dans la section **Caractéristiques communes**.

## Installation du capot de l'interface

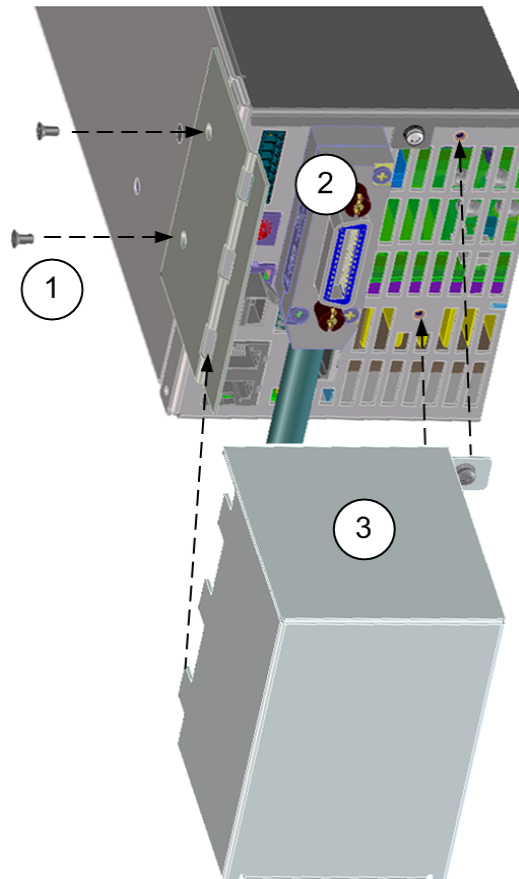

Le capot et le matériel protégeant contre les décharges électrostatiques sont livrés avec l'appareil (voir les **Éléments fournis**).

1. Branchez la bride du capot sur le côté de l'instrument à l'aide des deux vis fournies. **IMPORTANT** : ceci doit être effectué *avant* le montage en baie de l'appareil.

2. Branchez le câble LAN, USB ou GPIB (illustration du GPIB) au connecteur approprié du panneau arrière.
3. Insérez les tenons du couvercle dans la bride. Attachez le capot contre les décharges électrostatiques à l'arrière de l'appareil à l'aide des deux vis du couvercle captif.





# 3

## Mise en route

**Utilisation du panneau avant**

**Configuration de l'interface de commande à distance**

## Utilisation du panneau avant

### Mise sous tension de l'appareil

#### Définition de la tension de sortie

#### Définition du courant de sortie

#### Définition de la protection contre les surtensions

#### Activation de la sortie

#### Utilisation du système d'aide intégrée

### Mise sous tension de l'appareil

**AVERTISSEMENT** RISQUE D'ÉLECTROCUTION, TENSION LÉTALES De nombreux modèles génèrent des tensions allant jusqu'à 2 000 V CC ! Assurez-vous que toutes les connexions des instruments, le câblage de charge ainsi que les connexions de charge et de mesure sont isolés à l'aide de fils haute tension. Fixez toujours le capot de sécurité fourni, de sorte qu'aucun contact accidentel avec des tensions mortelles ne puisse se produire.

---

Vérifiez que le cordon d'alimentation est branché.

Mettez l'appareil sous tension à l'aide de l'interrupteur du panneau avant. Après quelques secondes, l'écran du panneau avant s'allume. Un autotest de mise sous tension est effectué automatiquement dès la mise sous tension de l'appareil. Il certifie que le bloc d'alimentation est opérationnel.



**REMARQUE** Un délai approximatif de 30 secondes peut être nécessaire pour que le bloc d'alimentation soit initialisé et prêt à être utilisé.

---

Si l'instrument ne s'allume pas, vérifiez que le cordon d'alimentation est solidement branché (la tension secteur est automatiquement détectée à la mise sous tension). Vérifiez également que l'instrument est connecté à une source d'alimentation sous tension. Si le voyant en regard de l'interrupteur d'alimentation est éteint, la tension secteur est absente. Si le voyant est orange, l'instrument est alimenté en courant secteur et en veille ; s'il est vert, l'instrument est en service.

**REMARQUE** Si une erreur d'autotest se produit, un message s'affiche sur le panneau avant. Pour connaître d'autres erreurs d'autotest, reportez-vous à la section **Maintenance et réparation** pour obtenir des instructions sur le retour de l'instrument en vue de son entretien.

---

## Définition de la tension de sortie

### Méthode 1

Utilisez les touches de navigation vers la gauche et vers la droite pour accéder au paramètre à modifier.

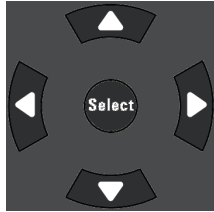

Sur l'écran suivant, le réglage de tension est sélectionné. Saisissez une valeur à l'aide du pavé numérique. Appuyez ensuite sur **Select**.



Vous pouvez également utiliser les touches numériques pour augmenter ou réduire la valeur. Les valeurs deviennent effectives lorsque la sortie est activée.

En mode de priorité de tension, l'appareil maintient la tension de sortie à sa valeur programmée. En mode de priorité de courant, l'appareil limite la tension de sortie lorsqu'il atteint la valeur limite de tension spécifiée. Pour de plus amples informations, reportez-vous à la section **Définir le mode de sortie**.

### Méthode 2

Utilisez la touche **Voltage** pour sélectionner le champ d'entrée de la tension. Sur l'écran ci-dessous, le réglage de tension est sélectionné. Entrez le paramètre désiré à l'aide du clavier numérique. Appuyez ensuite sur **Enter**.



En cas d'erreur, appuyez sur la touche de retour arrière pour effacer le nombre, sur Back pour quitter le menu ou sur Meter pour revenir au mode multimètre.

## Définition du courant de sortie

### Méthode 1

Utilisez les touches de navigation vers la gauche et vers la droite pour accéder au paramètre à modifier.

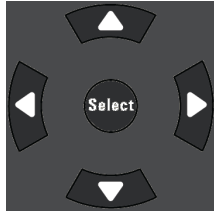

Le réglage de limite de courant est sélectionné dans l'écran ci-dessous. Utilisez les touches de navigation haut/bas pour basculer entre les entrées limites + et -. Saisissez une valeur à l'aide du pavé numérique. Appuyez ensuite sur **Select**.



Vous pouvez également utiliser les touches numériques pour augmenter ou réduire la valeur. Vous pouvez définir des valeurs de courant positives et négatives. Les valeurs deviennent effectives lorsque la sortie est activée.

En mode de priorité de courant, l'appareil maintient le courant de sortie à sa valeur programmée. En mode de priorité de tension, l'appareil limite le courant de sortie lorsqu'il atteint la valeur limite de courant spécifiée. Pour de plus amples informations, reportez-vous à la section **Définir le mode de sortie**.

### Méthode 2

Utilisez la touche **Current** pour sélectionner le champ d'entrée du courant. Le réglage de courant est sélectionné dans l'écran ci-dessous. Entrez le paramètre désiré à l'aide du clavier numérique. Appuyez ensuite sur **Enter**.

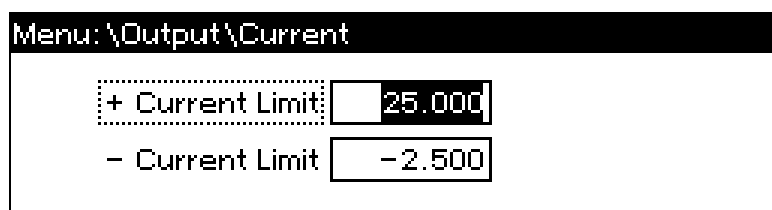

En cas d'erreur, appuyez sur la touche de retour arrière pour effacer le nombre, sur Back pour quitter le menu ou sur Meter pour revenir au mode multimètre.

## Définition de la protection contre les surtensions

### Utilisation du menu du panneau avant.

Le menu de commandes du panneau avant vous permet d'accéder à la plupart des fonctions de l'instrument. Les commandes de fonctions réelles sont situées au niveau le plus bas du menu. En résumé :

- Appuyez sur la touche **Menu** pour accéder au menu des commandes.
- Appuyez sur les touches de navigation vers la gauche et vers la droite (<, >) pour parcourir les commandes du menu.
- Appuyez sur la touche centrale **Select** pour sélectionner une commande et passer au niveau suivant du menu.
- Appuyez sur la touche **Help** située au niveau le plus bas du menu pour afficher des informations d'aide relatives aux commandes des fonctions.
- Pour quitter le menu des commandes, appuyez sur la touche **Meter** pour retourner immédiatement au mode multimètre, ou sur la touche **Menu** pour retourner au niveau supérieur.

Pour un plan des commandes du menu du panneau avant, reportez-vous à la section **Aide-mémoire des menus du panneau avant**.

### Exemple de menu - réglage de la protection contre les surtensions.

Appuyez sur la touche **Menu** pour accéder au menu des commandes du panneau avant. La première ligne identifie le chemin d'accès au menu. Lorsque vous accédez pour la première fois au menu, il s'affiche en haut ou en bas de l'écran et le chemin d'accès est vide. La deuxième ligne indique les commandes disponibles au niveau présent du menu. Dans le cas présent, les commandes du niveau supérieur du menu sont présentées, avec la commande Output en surbrillance. La troisième ligne indique les commandes disponibles sous la commande Output. S'il n'existe aucune commande de niveau inférieur, une brève description de la commande en surbrillance s'affiche.

```
Menu: \
Output Measure Transient Protect States System
Voltage, Current, Mode, Sequence, Advanced
```

Appuyez sur la touche de navigation vers la droite > pour parcourir le menu jusqu'à ce que la commande Protect soit mise en surbrillance. Appuyez sur la touche **Select** pour accéder aux commandes Protect.

```
Menu: \
Output Measure Transient Protect States System
OVP, UVP, OCP, Inhibit, WDog, Clear
```

### 3 Mise en route

Étant donné que la commande OVP est déjà mise en surbrillance, appuyez sur la touche Select pour accéder à la boîte de dialogue OVP.

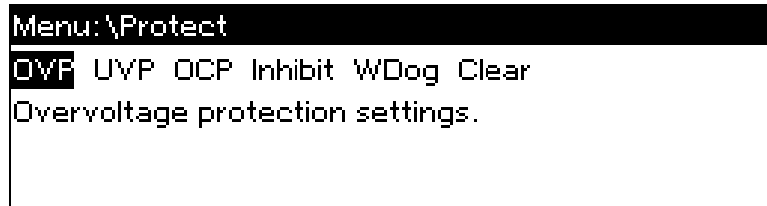

Le réglage OVP par défaut pour tous les modèles est 120 % de la tension nominale de sortie. Vous pouvez modifier le paramètre OVP en utilisant les touches de saisie numérique et en appuyant sur les touches **Enter** et **Select**. Appuyez sur la touche **Meter** pour retourner à la vue du multimètre.

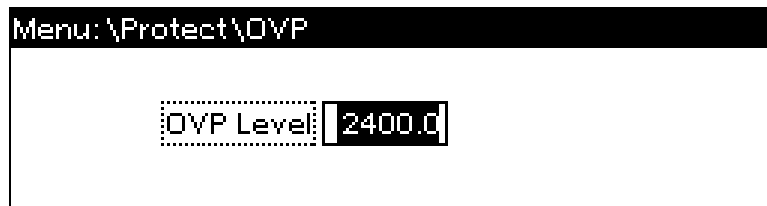

### Activation de la sortie

#### AVERTISSEMENT

**RISQUE D'ÉLECTROCUTION, TENSION LÉTALES** De nombreux modèles génèrent des tensions allant jusqu'à 2 000 V CC ! Assurez-vous que toutes les connexions des instruments, le câblage de charge ainsi que les connexions de charge et de mesure sont isolés à l'aide de fils haute tension. Fixez toujours le capot de sécurité fourni, de sorte qu'aucun contact accidentel avec des tensions mortelles ne puisse se produire.

Activez la sortie à l'aide de la touche **On/Off**. Si une charge est connectée à la sortie, l'écran du panneau avant indiquera qu'un courant est débité. Autrement, la lecture du courant sera nulle. Le voyant d'état indique l'état de la sortie. Dans ce cas, « CV » indique que la sortie est en mode de tension constante.



Pour une description des voyants d'état, reportez-vous à la section [Présentation succincte de l'écran du panneau avant](#).

### Utilisation du système d'aide intégrée

Au niveau le plus bas du menu, appuyez sur la touche **Help** pour afficher les informations d'aide relatives aux commandes des fonctions du menu.

Lorsqu'une limite est dépassée ou qu'une autre configuration incorrecte est détectée, l'instrument affiche un message, et notamment des informations sur le code d'erreur.

Appuyez sur **Meter** ou sur **Back** pour quitter l'aide.



## Configuration de l'interface de commande à distance

### Configuration USB

### Configuration GPIB

### Configuration LAN

### Modification des paramètres LAN

### Utilisation de l'interface Web

### Utilisation de Telnet

### Utilisation de sockets

### Verrouillage de l'interface

## Introduction

Cet instrument prend en charge les communications par interface de commande à distance sur 3 interfaces : GPIB, USB et LAN. Ces trois interfaces sont actives à la mise sous tension. Pour utiliser les interfaces, vous devez commencer par installer la dernière suite logicielle Keysight IO Libraries Suite, disponible à l'adresse [www.keysight.com](http://www.keysight.com). Branchez ensuite l'instrument à votre ordinateur.

Le voyant **IO** du panneau avant s'allume chaque fois qu'il y a une activité sur les interfaces de commande à distance. Le voyant **Lan** du panneau avant s'allume lorsque le port LAN est connecté et configuré.

Cet instrument assure la surveillance de la connexion Ethernet. Le port LAN de l'instrument est ainsi surveillé de manière continue, et reconfiguré automatiquement lorsque l'instrument est débranché pendant plus de 20 secondes puis rebranché au secteur.

## Configuration USB

Les paramètres USB ne peuvent pas être configurés. Vous pouvez extraire la chaîne de connexion USB via le menu du panneau avant :

Aide-mémoire des menus du panneau avant	Commande SCPI
Sélectionnez <b>System\IO\USB</b> .	Non disponible
La boîte de dialogue affiche la chaîne de connexion USB.	

## Configuration GPIB

Chaque périphérique connecté à l'interface GPIB (IEEE-488) doit avoir une adresse unique comprise entre 0 et 30. L'instrument est livré avec une adresse définie à 5. L'adresse de la carte d'interface GPIB

de votre ordinateur ne doit pas entrer en conflit avec un instrument sur le bus d'interface. Ce paramètre est non volatile ; une coupure/rétablissement de l'alimentation ou la commande \*RST ne le modifie pas. Utilisez le menu du panneau avant pour modifier l'adresse GPIB :

Aide-mémoire des menus du panneau avant	Commande SCPI
Sélectionnez <b>System\IO\GPIB</b> .	Non disponible
Saisissez une nouvelle valeur comprise entre 0 et 30 à l'aide du clavier numérique. Appuyez ensuite sur <b>Enter</b> .	

## Configuration LAN

Les paragraphes suivants décrivent les fonctions de base de configuration du réseau local via les menus du panneau avant. Notez qu'il n'existe aucune commande SCPI pour configurer les paramètres du réseau local. L'intégralité de la configuration du LAN doit être effectuée à partir du panneau avant.

**REMARQUE** Après avoir modifié les paramètres du LAN, vous devez enregistrer les modifications. Sélectionnez : **System\IO\LAN\Apply**. Sélectionnez Apply pour activer les paramètres. Les paramètres du LAN ne sont pas volatiles. Ils ne sont pas modifiés après une remise sous tension ou la commande \*RST. Si vous ne souhaitez pas enregistrer les modifications, sélectionnez : **System\IO\LAN\Cancel**. La sélection de l'option Cancel entraîne l'annulation de toutes les modifications.

Par défaut, le protocole DHCP est activé pour permettre les communications sur un réseau local. L'acronyme DHCP signifie Dynamic Host Configuration Protocol ; il s'agit d'un protocole d'attribution d'adresses IP dynamiques à des périphériques sur un réseau. Avec l'adressage dynamique, un périphérique peut avoir une adresse IP différente chaque fois qu'il se connecte au réseau.

### Affichage des paramètres actifs

Pour afficher les paramètres du réseau local actuellement activés :

Aide-mémoire des menus du panneau avant	Commande SCPI
Sélectionnez <b>System\IO\LAN\Settings</b>	Non disponible
Affiche les paramètres LAN actifs. Parcourez la liste à l'aide des touches fléchées haut/bas.	

Les paramètres actuellement actifs de l'adresse IP, du masque de sous-réseau et de la passerelle par défaut peuvent être différents de ceux du menu de configuration du panneau avant, selon la configuration du réseau. Les paramètres sont différents lorsque le réseau a affecté les siens automatiquement.

### Réinitialisation du réseau local

La réinitialisation du LAN effectue une réinitialisation LAN Configuration Initialize (LCI) de l'instrument qui active le DHCP, DNS et ping. Cela réinitialise également le mot de passe du site Web avec le mot de passe par défaut d'usine. Cela ne réinitialise pas le nom d'hôte ou le nom du service mDNS.

### 3 Mise en route

Vous pouvez également rétablir les paramètres (par défaut) configurés en usine du LAN. Cela permet de rétablir les valeurs configurées en usine de **TOUS** les paramètres du LAN et de redémarrer le réseau. Tous les paramètres par défaut du LAN sont répertoriés dans la section **Paramètres non volatiles**.

Aide-mémoire des menus du panneau avant	Commande SCPI
Sélectionnez <b>System\IO\LAN\Reset</b>	Non disponible
Sélectionnez <b>System\IO\LAN\Defaults</b>	
Cette option permet d'activer les paramètres de LAN sélectionnés et de redémarrer le réseau.	

## Modification des paramètres LAN

### Adresse IP

Sélectionnez une adresse IP pour configurer l'adressage de l'instrument. Appuyez sur la touche **Menu**, puis sélectionnez **System\IO\LAN\Config\IP**. Les paramètres suivants peuvent être configurés :

Aide-mémoire des menus du panneau avant	Commande SCPI
Sélectionnez <b>System\IO\LAN\Modify\IP</b>	Non disponible
Sélectionnez <b>Auto</b> ou <b>Manual</b> . Pour une description complète, voir ci-dessous.	

- **Auto** : permet de configurer automatiquement l'adressage de l'instrument. Lorsqu'il est sélectionné, l'instrument tente d'abord d'obtenir une adresse IP auprès d'un serveur DHCP. Si un serveur DHCP est détecté, celui-ci affecte une adresse IP, un masque de sous-réseau et une passerelle par défaut à l'instrument. En l'absence de serveur DHCP, l'instrument tente d'abord d'obtenir une adresse IP via la fonction AutoIP. AutoIP affecte automatiquement une adresse IP, un masque de sous-réseau et des adresses de passerelles par défaut sur les réseaux qui n'ont pas de serveur DHCP.
- **Manual** : vous permet de configurer manuellement l'adressage de l'instrument en saisissant des valeurs dans les trois champs suivants. Ces champs ne sont visibles que si l'option Manuel est sélectionnée.
- **IP Address** : ce paramètre correspond à l'adresse IP (Internet Protocol) de l'instrument. Une adresse IP est nécessaire pour toutes les communications IP et TCP/IP avec l'instrument. Une adresse IP comporte 4 nombres décimaux séparés par des points. Chaque nombre décimal est compris entre 0 et 255 et ne contient aucun zéro initial (par exemple, 169.254.2.20).
- **Subnet Mask** : ce paramètre permet à l'instrument de déterminer si l'adresse IP d'un client se trouve sur le même sous-réseau local. La même notation de numérotation s'applique à l'adresse IP. Lorsque l'adresse IP d'un client se trouve sur un sous-réseau différent, tous les paquets doivent être envoyés à la passerelle par défaut.

- **DEF Gateway** : ce paramètre correspond à l'adresse IP de la passerelle par défaut qui permet à l'instrument de communiquer avec des systèmes qui ne se trouvent pas sur le sous-réseau local, comme indiqué par le réglage du masque de sous-réseau. La même notation de numérotation s'applique à l'adresse IP. La valeur 0.0.0.0 indique qu'aucune passerelle par défaut n'est définie.

Les adresses notées par points (« nnn.nnn.nnn.nnn » où « nnn » est la valeur d'un octet comprise entre 0 et 255) doivent être soigneusement exprimées du fait que la plupart des logiciels des PC interprètent les octets avec des zéros initiaux comme des nombres en base 8. Par exemple, « 192.168.020.011 » est équivalent à la notation décimale « 192.168.16.9 » car « .020 » est interprété comme « 16 » en base 8 et « .011 » comme « 9 ». Pour éviter toute confusion, utilisez uniquement des valeurs décimales comprises entre 0 et 255 sans zéro d'en-tête.

## Nom d'hôte

Un nom d'hôte est la partie hôte du nom du domaine qui est traduite en adresse IP. Pour configurer le nom d'hôte de l'instrument :

Aide-mémoire des menus du panneau avant	Commande SCPI
Sélectionnez <b>System\IO\LAN\Modify\Name</b>	Non disponible
<p>Vous pouvez saisir une valeur sur le clavier numérique. Pour des caractères supplémentaires, saisissez un caractère alphanumérique à l'aide des touches de navigation haut/bas en parcourant la liste de sélection qui s'affiche lorsque vous appuyez sur les touches. Pour parcourir le champ de texte, utilisez les touches de navigation gauche/droite. Pour supprimer une valeur, utilisez la touche de retour. Appuyez sur Enter une fois l'opération terminée.</p>	

Le champ **Host Name** enregistre le nom fourni avec le service de désignation sélectionné. Si ce champ reste vide, aucun nom n'est enregistré. Un nom d'hôte peut contenir des lettres majuscules et minuscules, des nombres et des traits d'union (-). La longueur maximale est de 15 caractères.

Chaque instrument est livré avec un nom d'hôte par défaut au format suivant : K-numérodemodel-numérodésérie, où numérodemodel représente le numéro de modèle de l'appareil principal à 7 caractères (par exemple, RP7972A), et numérodésérie correspond aux cinq derniers caractères du numéro de série à 10 caractères situé sur l'étiquette placée au-dessus de l'appareil (par exemple, 45678 si le numéro de série est MY12345678).

## Serveur DNS

DNS est un service Internet qui traduit les noms de domaine en adresses IP. Il est également nécessaire pour que l'instrument recherche et affiche le nom d'hôte que le réseau lui a attribué. Normalement, DHCP recherche l'adresse DNS ; il vous suffit d'indiquer si le protocole DHCP est inutilisé ou non fonctionnel.

Pour configurer manuellement les services DNS :

Aide-mémoire des menus du panneau avant	Commande SCPI
Sélectionnez <b>System\IO\LAN\Modify\DNS</b>	Non disponible
<p>Sélectionnez Primary Address ou Secondary Address. Pour une description complète, voir ci-dessous.</p>	

### 3 Mise en route

- **Primary Address** : ce champ indique l'adresse principale du serveur. Pour de plus amples informations sur le serveur, contactez votre administrateur réseau. La même notation de numérotation s'applique à l'adresse IP. La valeur 0.0.0.0 indique qu'aucun serveur par défaut n'est défini.
- **Secondary Address** : ce champ indique l'adresse secondaire du serveur. Pour de plus amples informations sur le serveur, contactez votre administrateur réseau. La même notation de numérotation s'applique à l'adresse IP. La valeur 0.0.0.0 indique qu'aucun serveur par défaut n'est défini.

Les adresses notées par points (« nnn.nnn.nnn.nnn » où « nnn » est la valeur d'un octet comprise entre 0 et 255) doivent être soigneusement exprimées du fait que la plupart des logiciels des PC interprètent les octets avec des zéros initiaux comme des nombres en base 8. Par exemple, « 192.168.020.011 » est équivalent à la notation décimale « 192.168.16.9 » car « .020 » est interprété comme « 16 » en base 8 et « .011 » comme « 9 ». Pour éviter toute confusion, utilisez uniquement des valeurs décimales comprises entre 0 et 255 sans zéro d'en-tête.

#### Nom du service mDNS

Le nom du service mDNS est enregistré avec le service de désignation sélectionné. Pour configurer le nom du service mDNS de l'instrument :

Aide-mémoire des menus du panneau avant	Commande SCPI
Sélectionnez <b>System\IO\LAN\Modify\mDNS</b>	Non disponible
Vous pouvez saisir une valeur sur le clavier numérique. Pour des caractères supplémentaires, saisissez un caractère alphanumérique à l'aide des touches de navigation haut/bas en parcourant la liste de sélection qui s'affiche lorsque vous appuyez sur les touches. Pour parcourir le champ de texte, utilisez les touches de navigation gauche/droite. Pour supprimer une valeur, utilisez la touche de retour. Appuyez sur Enter une fois l'opération terminée.	

- **mDNS Service Name** : ce champ enregistre le nom du service avec le service de désignation sélectionné. Si ce champ reste vide, aucun nom n'est enregistré. Un nom de service peut contenir des lettres majuscules et minuscules, des nombres et des traits d'union (-).
- Chaque instrument est livré avec un nom de service par défaut au format suivant : Keysight-numérodemodel-description-numérodésérie, où numérodemodel représente le numéro de modèle de l'appareil principal à 7 caractères, description représente la description et numérodésérie correspond au numéro de série à 10 caractères situé sur l'étiquette placée au-dessus de l'appareil (par exemple, MY12345678).

#### Services

Cette option permet de sélectionner les services LAN à activer ou désactiver.

Aide-mémoire des menus du panneau avant	Commande SCPI
Sélectionnez <b>System\IO\LAN\Modify\Services</b>	Non disponible
Cochez ou désélectionnez les cases correspondant aux services que vous souhaitez activer ou désactiver.	

- Les services pouvant être configurés sont : VXI-11, Telnet, Contrôle Web, Sockets, mDNS et HiSLIP.
- Vous devez activer Web Control si vous souhaitez contrôler à distance votre instrument via son interface Web intégrée.

## Utilisation de l'interface Web

Votre instrument comprend une interface Web intégrée qui vous permet de le contrôler directement depuis le navigateur Web de votre ordinateur. Grâce à cette interface, vous pouvez accéder aux fonctions des commandes du panneau avant, notamment aux paramètres de configuration du réseau local. Jusqu'à six connexions simultanées sont autorisées. En cas de connexions supplémentaires, les performances seraient réduites.

**REMARQUE** L'interface Web intégrée ne fonctionne que sur le réseau local. Un navigateur Web est requis pour utiliser l'interface Web.

---

L'interface Web est activée lors de la livraison de l'appareil. Pour lancer l'interface Web :

1. Ouvrez le navigateur Web de votre ordinateur.
2. Saisissez le nom d'hôte ou l'adresse IP dans le champ d'adresse du navigateur. La page d'accueil suivante apparaît.
3. Cliquez sur l'onglet « Web Control » en haut de la page pour commencer à commander votre instrument.
4. Pour obtenir une aide supplémentaire sur l'une des pages, cliquez sur ?.

### 3 Mise en route

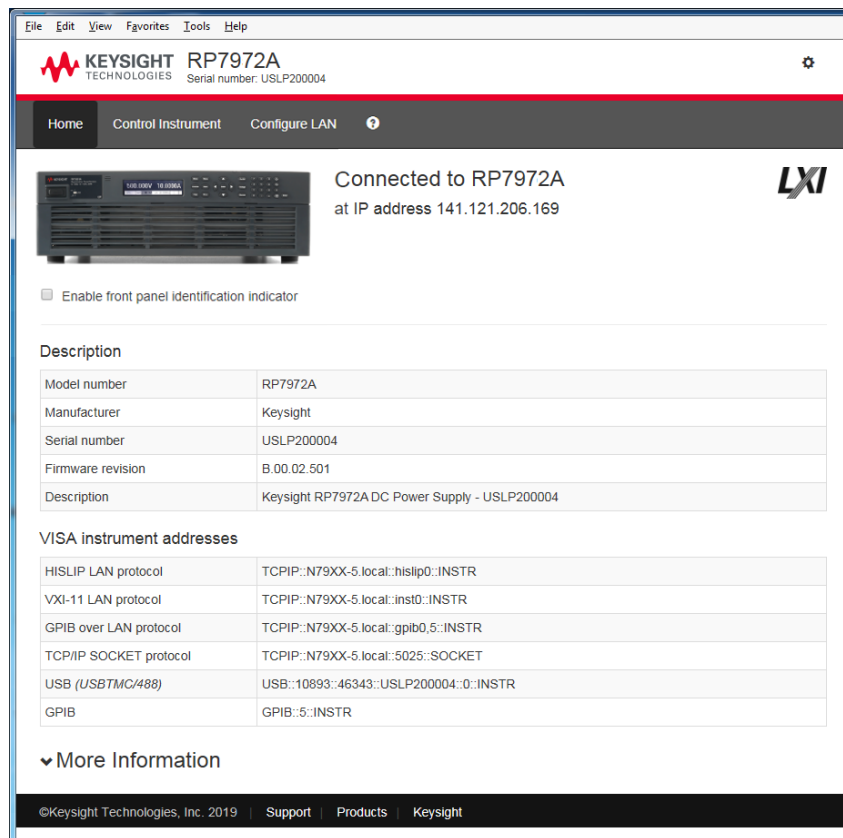

Si vous le désirez, vous pouvez restreindre l'accès à l'interface Web à l'aide d'une protection par mot de passe. Par défaut, aucun mot de passe n'est défini. Pour définir un mot de passe, cliquez sur l'icône Settings (engrenages). Pour de plus amples informations sur la définition d'un mot de passe, consultez l'aide en ligne.

### Utilisation de Telnet

**REMARQUE** Les blocs d'alimentation acceptent toute combinaison d'un maximum de six connexions par socket de données, socket de contrôle et telnet.

Dans une zone d'invite de commandes MS-DOS, saisissez : telnet nom\_hôte 5024, où nom\_hôte représente le nom d'hôte ou l'adresse IP de l'APS et 5024 le port telnet de l'appareil.

Vous devriez obtenir une fenêtre de session Telnet dont le titre indique que vous êtes connecté au bloc d'alimentation. Saisissez les commandes SCPI à l'invite.

### Utilisation de sockets

Les instruments Keysight ont normalisé l'utilisation du port 5025 pour les services de sockets SCPI. Un socket de données sur ce port permet d'émettre ou de recevoir des commandes, des demandes et des réponses ASCII/SCPI. Toutes les commandes doivent se terminer par une nouvelle ligne pour le message à traiter. Toutes les réponses doivent également se terminer par une nouvelle ligne.

L'interface de programmation par sockets permet en outre une connexion par socket de contrôle. Le socket de contrôle permet aux clients d'envoyer des commandes Device Clear et de recevoir des demandes de service. Contrairement au socket de données, qui utilise un numéro de port fixe, le numéro de socket de contrôle varie et doit être obtenu en envoyant la demande SCPI suivante au socket de données : **SYSTem:COMMunicate:TCPIp:CONTRol?**

Après avoir obtenu le numéro de port, ouvrez une connexion par socket de contrôle. Comme avec le socket de données, toutes les commandes envoyées au socket de contrôle doivent se terminer par une nouvelle ligne, et toutes les réponses renvoyées par le socket de contrôle sont terminées par une nouvelle ligne.

Pour envoyer une commande Device Clear, envoyez la chaîne « DCL » au socket de contrôle. Lorsque le système d'alimentation a terminé l'exécution de la commande Device Clear, il renvoie la chaîne « DCL » au socket de contrôle.

Les demandes de service sont activées pour les sockets de contrôle à l'aide du registre d'activation des demandes de service. Dès que les demandes de service ont été activées, le programme client écoute la connexion de contrôle. Lorsque SRQ devient vrai, l'instrument envoie la chaîne « SRQ +nn » au client. « nn » représente la valeur de l'octet d'état, que le client peut utiliser pour déterminer la source de la demande de service.

## Verrouillage de l'interface

L'interface USB, l'interface LAN et le serveur Web sont activés lors de la livraison. Pour activer ou désactiver les interfaces à partir du panneau avant :

Aide-mémoire des menus du panneau avant	Commande SCPI
Sélectionnez <b>System\Admin\IO</b>	Non disponible
Activez ou désactivez les interfaces en cochant ou en désélectionnant les cases suivantes :	
Enable LAN, Enable GPIB et Enable USB	

Si le menu Admin est inaccessible, il est probablement protégé par un mot de passe.





# 4

## Utilisation du système d'alimentations régénératrices

**Programmation de la sortie**

**Fonctionnement en parallèle**

**Utilisation de la fonction d'absorption de courant**

**Programmation de la protection des sorties**

**Programmation des transitoires de sortie**

**Séquencement de la sortie**

**Réalisation de mesures**

**Enregistrement de données externe**

**Programmation du port numérique**

**Opérations système**

**Didacticiel du mode de priorité**

**Fonctionnement du simulateur photovoltaïque**

## Programmation de la sortie

### Définir le mode de priorité de sortie

### Définition de la tension de sortie et limite de sous-tension

### Définition du courant de sortie

### Définir la vitesse de balayage

### Définir la résistance de sortie

### Définir la bande passante de sortie

### Régler le mode d'activation/de désactivation de la sortie

### Activation de la sortie

#### AVERTISSEMENT

**RISQUE D'ÉLECTROCUTION, TENSION LÉTALES** De nombreux modèles génèrent des tensions allant jusqu'à 2 000 V CC ! Assurez-vous que toutes les connexions des instruments, le câblage de charge ainsi que les connexions de charge et de mesure sont isolés à l'aide de fils haute tension. Fixez toujours le capot de sécurité fourni, de sorte qu'aucun contact accidentel avec des tensions mortelles ne puisse se produire.

#### REMARQUE

Lors de la mise sous tension initiale de l'appareil, l'instrument peut mettre environ 30 secondes à démarrer avant d'être prêt pour utilisation.

## Définir le mode de priorité de sortie

Sélectionnez la priorité de tension, la priorité de courant ou le mode de fonctionnement du SAS. Pour de plus amples informations, reportez-vous à la section [Utilisation du mode de priorité](#).

**Voltage priority (Priorité de tension)** : ce mode maintient la tension de sortie à une valeur constante. La tension de sortie conserve sa valeur programmée à condition que le courant de charge soit inférieur aux limites de courant + ou -.

**Current priority (Priorité de courant)** : ce mode maintient le courant de sortie à une valeur constante. Le courant de sortie conserve sa valeur programmée à condition que le courant de charge soit inférieur au réglage de la limite de courant.

**Mode SAS** : sélectionne le fonctionnement du simulateur de groupe de cellules solaires. Pour plus de détails, voir la section sur le [fonctionnement du simulateur photovoltaïque](#).

Sélectionnez <b>Output Mode</b> .	Pour spécifier le mode de priorité de courant ou de tension :
Sélectionnez la priorité Tension ou Courant. Appuyez ensuite sur <b>Select</b> .	<b>FUNC CURR VOLT</b>

**REMARQUE** Lors de la commutation entre les modes, la sortie est désactivée et les paramètres de sortie sont rétablis à leurs valeurs d'activation ou RST.

## Définition de la tension de sortie

Lorsque l'appareil fonctionne en mode de priorité de tension, la tension de sortie conserve sa valeur programmée dès lors que le courant de charge est inférieur à sa limite positive ou négative programmée.

Aide-mémoire des menus du panneau avant	Commande SCPI
Appuyez sur la touche <b>Voltage</b> (Tension). Saisissez une valeur et appuyez sur <b>Select</b> .	Pour régler la tension de sortie sur 400 volts : <b>VOLT 400</b>

Si l'appareil est en mode de priorité de courant, vous pouvez spécifier une limite de tension qui limite la tension de sortie à la valeur indiquée. Le courant de sortie conserve sa valeur programmée à condition que le courant de charge soit inférieur au réglage de la limite de courant.

Aide-mémoire des menus du panneau avant	Commande SCPI
Appuyez sur la touche <b>Voltage</b> (Tension). Spécifiez une limite de tension +. Appuyez ensuite sur <b>Select</b> .	Pour régler la limite de tension : <b>VOLT:LIM 420</b>

## Définir la limite de sous-tension

Définit la limite de sous-tension en mode de priorité de courant. Ceci permet d'éviter que la tension ne descende en dessous de la limite de sous-tension lors du déchargement d'une batterie. Lorsque la limite de sous-tension est atteinte, l'appareil passe du mode de priorité de courant au mode de priorité de tension, ce qui arrête le déchargement de la batterie. La limite de sous-tension est annoncée par le bit d'état **VL-**.

La limite de sous-tension empêche également la sortie de se mettre en marche lorsque la tension de sortie est inférieure à la limite de sous-tension programmée. Si vous devez activer la sortie, vous devez d'abord désactiver la limite de sous-tension. Notez que cette fonction est différente de la fonction de **protection contre les sous-tensions**.

Aide-mémoire des menus du panneau avant	Commande SCPI
Appuyez sur la touche <b>Voltage</b> (Tension). Le champ Low Voltage Limit n'apparaît que lorsque l'appareil est réglé pour fonctionner en mode Priorité du courant.	Pour définir la limite de sous-tension : <b>VOLT:LIM:LOW 4</b>
Spécifiez la limite de sous-tension. Cochez ensuite la case Enable (décochez pour désactiver). Appuyez ensuite sur <b>Select</b> .	Pour activer la limite de sous-tension : <b>VOLT:LIM:LOW:STAT ON</b>

## Définition du courant de sortie

Lorsque l'appareil est configuré en mode de priorité de tension, vous pouvez spécifier une limite de courant positive ou négative, qui limite le courant de sortie à la valeur indiquée.

Aide-mémoire des menus du panneau avant	Commande SCPI
Appuyez sur la touche <b>Current</b> (Courant).	Pour régler la limite de courant positive : <b>CURR:LIM 12</b>
Spécifiez une limite de courant positive ou négative. Appuyez ensuite sur <b>Select</b> .	Pour régler la limite de courant négative : <b>CURR:LIM:NEG -3</b>

Lorsque l'appareil fonctionne en mode de priorité de courant, vous pouvez spécifier un niveau de courant de sortie positif ou négatif, qui ne change pas dès lors que la tension de sortie est inférieure à sa limite programmée.

Aide-mémoire des menus du panneau avant	Commande SCPI
Appuyez sur la touche <b>Current</b> (Courant).	Pour régler le courant sur +5 ampères : <b>CURR 5</b>
Saisissez une valeur positive ou négative. Appuyez ensuite sur <b>Select</b> .	Pour régler le courant sur -5 ampères : <b>CURR -5</b>

## Définir la vitesse de balayage

La vitesse de balayage de tension détermine la vitesse à laquelle la tension passe à une nouvelle valeur. Cela ne s'applique qu'aux réglages de tension lorsque l'appareil fonctionne en mode de priorité de tension. Lorsqu'elle est définie sur MAXimum, INFINITY ou une valeur très élevée, la vitesse de balayage est limitée par la vitesse de programmation et la bande passante indiquées de l'appareil. Ce réglage permet d'éviter toute transition vers la limite de courant pendant la programmation amont et aval des charges capacitives ou de limiter la réponse de programmation à une vitesse contrôlée. Utilisez l'équation suivante pour calculer la vitesse de balayage limite maximale afin d'assurer des performances de programmation amont et aval linéaires et régulières.

Vitesse de balayage max. (V/s) = (limite de courant (A) – courant de charge (A))/(capacité de charge (F))

La vitesse de balayage de courant détermine la vitesse à laquelle le courant passe à une nouvelle valeur programmée. Cela ne s'applique qu'aux réglages de courant lorsque l'appareil fonctionne en mode de priorité du courant. Lorsqu'elle est définie sur MAXimum, INFINITY ou une valeur très élevée, la vitesse de balayage est limitée par la vitesse de programmation et la bande passante indiquées de l'appareil.

Aide-mémoire des menus du panneau avant	Commande SCPI
-----------------------------------------	---------------

Sélectionnez <b>Output\Advanced\Slew</b> .	Pour régler la vitesse de balayage de tension sur 5 V/s
Sélectionnez ensuite Voltage (Tension) ou Current (Courant).	<b>VOLT:SLEW 5</b>
Entrez la vitesse de balayage de tension ou de courant dans le champ Slew Rate (Vitesse de balayage).	Pour régler la vitesse de balayage de courant sur 1 A/s
Cochez la case Max slew rate (Vitesse de balayage max.) pour programmer la vitesse maximale.	<b>CURR:SLEW 1</b>
	Pour régler la vitesse de balayage maximale :
	<b>VOLT:SLEW MAX</b>

## Définir la résistance de sortie

La programmation de résistance de sortie est principalement utilisée dans les applications de test de batteries et ne s'applique qu'en mode de priorité de tension. On l'utilise pour émuler la résistance interne d'une source de tension non idéale, telle qu'une batterie. Les valeurs sont programmées en ohms. Pour connaître les plages de programmation de résistance spécifiques à un modèle, reportez-vous au tableau des **Caractéristiques supplémentaires**.

Aide-mémoire des menus du panneau avant	Commande SCPI
Sélectionnez <b>Output\Advanced\Resistance</b> .	Pour sélectionner une résistance de 0,5 ohms :
Indiquez une valeur de résistance de sortie. Cochez ensuite la case <b>Enable (Activer)</b> . Appuyez ensuite sur <b>Select</b> .	<b>VOLT:RES 0.5</b>
	Pour activer la résistance de sortie :
	<b>VOLT:RES:STAT ON</b>

**REMARQUE** Lorsque les appareils sont connectés en parallèle, la résistance de sortie maximale est réduite. La résistance programmable pour un seul appareil doit être divisée par le nombre total d'appareils connectés en parallèle.

## Définir la bande passante de sortie

### Compensation de tension

Les modes de compensation vous permettent d'optimiser le temps de réponse de la sortie avec des charges capacitives. Les graphiques de **Limite de charge capacitive** dans la section Caractéristiques illustrent l'ESR minimum en fonction de la capacité de l'appareil testé pour permettre un fonctionnement stable. Les graphiques d'**impédance** de sortie illustrent l'effet des modes de compensation sur l'impédance de sortie des petits signaux.

**0 Fast** (haute vitesse/charge capacitive faible) : indique la vitesse de programmation la plus rapide et le temps de réponse transitoire. Convient mieux aux appareils testés résistifs à faible capacité. Fréquence par défaut = 5000 Hz.

**1 Medium** (vitesse moyenne/charge capacitive moyenne) : indique la vitesse de programmation intermédiaire et le temps de réponse transitoire. Convient mieux aux appareils testés ayant une capacité plus élevée avec un compromis entre la vitesse de programmation et la réponse transitoire. Fréquence par défaut = 450 Hz.

## 4 Utilisation du système d'alimentations régénératrices

**2 Slow** (vitesse faible/charge capacitive élevée) : convient mieux aux appareils testés à haute capacité/faible ESR avec compromis entre la vitesse de programmation plus lente et la réponse transitoire. Fréquence par défaut = 12 Hz.

**<fréquence>** spécifie la fréquence d'angle passe-bas d'un filtre appliquée au signal de programmation. La tension programmée est un signal numérisé qui passe à travers un filtre passe-bas de premier degré où le pôle est indiqué en Hertz. Ce filtre a pour effet de ralentir la sortie en fonction des variations de la tension ou du courant programmé.

Ceci permet, en spécifiant la fréquence d'angle passe-bas d'un filtre, en association avec le réglage configurable de la vitesse, d'obtenir un compromis entre la vitesse de programmation et la tension de sortie ou le dépassement de courant. Par exemple, l'augmentation de la fréquence du filtre augmente la vitesse de programmation et diminue le temps de stabilisation, ce qui peut entraîner un dépassement de la sortie. La réduction de la fréquence du filtre diminue la vitesse de programmation et augmente le temps de stabilisation, ce qui réduit tout dépassement de la sortie. L'effet du réglage de la fréquence du filtre dépend également du réglage de la compensation et de l'impédance de charge. Ce réglage de fréquence de filtre n'affecte pas la réponse transitoire de l'appareil à un changement de charge.

Le tableau suivant résume l'effet des réglages de la compensation sur les caractéristiques de vitesse de programmation de CV pour tous les modèles.

Réglage	Conditions du palier	Fréquence	Temps de montée/descente 10 à 90 % du palier	Temps de stabilisation à 0,1 % du palier
0 Fast	à vide, 0,1 à 100 % de la valeur nominale	100 kHz	0,2 ms	1 ms
1 Medium	à vide, 0,1 à 100 % de la valeur nominale	100 kHz	0,5 ms	2,5 ms
2 Slow	à vide, 0,1 à 100 % de la valeur nominale	100 kHz	33 ms	110 ms

Le tableau suivant décrit les caractéristiques de la bande passante du faible signal de CV pour tous les modèles

Bande passante de signal faible de la programmation de CV (-3dB) à vide	
Réglage	Fréquence
0 Fast	2,5 kHz
1 Medium	1 kHz
2 Slow	350 Hz

Aide-mémoire des menus du panneau avant	Commande SCPI
Sélectionnez <b>Output\Advanced\Bandwidth\Voltage</b> . Sélectionnez 0, 1 ou 2. Si vous le souhaitez, saisissez la fréquence polaire dans le champ Frequency (Fréquence). Appuyez ensuite sur <b>Select</b> .	Pour régler la bande passante de compensation de tension : <b>VOLT:BWID:RANG 0   1   2</b> Pour spécifier la fréquence polaire : <b>VOLT:BWID:LEV 0   1   2, &lt;fréquence&gt;</b>

## Compensation du courant

La compensation de courant fournie est adaptée pour traiter une large gamme d'inductance pour les appareils testés et de charge totale avec une réponse de programmation relativement rapide (voir le graphique de la **limite de charge d'inductance**). Pour réduire l'impact de l'inductance des fils de charge, il peut être utile de mettre en parallèle des ensembles supplémentaires de fils de charge afin de réduire l'inductance nette, en particulier si les fils de charge sont longs.

**<fréquence>** : spécifie la fréquence d'angle passe-bas d'un filtre appliquée au signal de programmation. Reportez-vous à la description précédente sous Modes de compensation de tension pour obtenir une description des compromis de cas d'utilisation de la modification du réglage <fréquence>.

Le tableau suivant résume l'effet des réglages de la compensation sur les caractéristiques de vitesse de programmation de CC pour tous les modèles.

Conditions du palier	Fréquence	Temps de montée/descente 10 à 90 % du palier	Temps de stabilisation à 0,1 % du palier
CA court >10 % de la tension nominale, 0,1 à 100 % de la valeur nominale	100 kHz	100 µs	200 µs

La caractéristique de la bande passante du petit signal de programmation CC à -3dB est de 3,5 kHz pour tous les modèles.

Aide-mémoire des menus du panneau avant	Commande SCPI
<p>Sélectionnez <b>Output\Advanced\Bandwidth\Current</b>.</p> <p>Il n'y a qu'une seule bande passante de compensation.</p> <p>Si vous le souhaitez, saisissez la fréquence polaire dans le champ Frequency (Fréquence). Appuyez ensuite sur <b>Select</b>.</p>	<p>Pour spécifier la fréquence polaire :</p> <p><b>CURR:BWID:LEV 0, &lt;fréquence&gt;</b></p>

## Régler le mode d'activation/de désactivation de la sortie

### REMARQUE

Le réglage de l'activation ou de la désactivation ne s'applique que lorsque l'appareil fonctionne en mode de priorité de tension. En mode de priorité de courant, le comportement d'activation/de désactivation est toujours défini sur High impedance (Impédance élevée).

Le comportement d'activation et de désactivation de la priorité de tension peut être réglé en mode de haute ou de faible impédance.

Le mode **Low impedance (Faible impédance)** est destiné aux appareils tels que les convertisseurs de puissance. Lors des transitions de sortie, le courant est fourni ou déchargé pour une réponse rapide de la tension de sortie.



## 4 Utilisation du système d'alimentations régénératrices

Le mode **High impedance (Impédance élevée)** est destiné aux appareils tels que les batteries, où les transitions de sortie sont contrôlées pour réduire le courant de sortie.

Aide-mémoire des menus du panneau avant	Commande SCPI
Sélectionnez <b>Output\Advanced\Tmode</b> .	Pour sélectionner l'activation à impédance élevée :
Sélectionnez l'impédance élevée ou la faible impédance pour les modes d'activation et de désactivation.	<b>OUTP:TMOD:ON HIGHZ</b>
Cochez <b>Coupled (Couplage)</b> pour coupler les modes d'activation et de désactivation. Appuyez ensuite sur <b>Select</b> .	Pour sélectionner la désactivation à faible impédance :
	<b>OUTP:TMOD:OFF LOWZ</b>
	Pour coupler les modes d'activation et de désactivation :
	<b>OUTP:TMOD:COUP ON</b>

### Activation de la sortie

#### AVERTISSEMENT

**RISQUE D'ÉLECTROCUTION, TENSION LÉTALES** De nombreux modèles génèrent des tensions allant jusqu'à 2 000 V CC ! Assurez-vous que toutes les connexions des instruments, le câblage de charge ainsi que les connexions de charge et de mesure sont isolés à l'aide de fils haute tension. Fixez toujours le capot de sécurité fourni, de sorte qu'aucun contact accidentel avec des tensions mortelles ne puisse se produire.

En raison des procédures de démarrage de circuit internes et de toutes les options de relais installées, l'activation de la sortie (OUTPut ON) peut durer plusieurs dizaines de millisecondes. Des délais de désactivation de la sortie (OUTPut OFF) peuvent également être observés. Pour plus d'informations sur les délais d'activation et de désactivation de la sortie, reportez-vous à la section **Délais d'activation/désactivation**.

Aide-mémoire des menus du panneau avant	Commande SCPI
Appuyez sur la touche <b>On/Off</b> .	<b>OUTP ON OFF</b>

En plus des commandes d'activation et de désactivation de la sortie du panneau avant et SCPI, vous pouvez utiliser les signaux **OnCouple** et **OffCouple** pour activer et désactiver la sortie. Pour de plus amples informations, reportez-vous à la section **Commande de couplage des sorties**. Lorsque le couplage est activé, la modification du réglage d'activation change également le réglage de désactivation et vice-versa.

#### REMARQUE

Au cours d'une coupure de secteur sur 1 cycle, l'appareil peut redémarrer. La sortie restera désactivée après le redémarrage jusqu'à ce que l'opérateur rétablisse les réglages précédents, soit grâce aux commandes du panneau avant, soit en utilisant un programme informatique. Ce comportement est conforme aux procédures d'exploitation sécuritaires.

## Fonctionnement en parallèle

### Introduction

### Configuration principale/secondaire

### Écran du panneau avant principal/secondaire

### Considérations relatives à la programmation principale/secondaire

### Détails sur la commande principale/secondaire

### Dépannage

## Introduction

### AVERTISSEMENT

**RISQUE D'ÉLECTROCUTION** Tous les appareils en parallèle doivent être raccordés à la masse en permanence par un cordon d'alimentation mis à la terre. Toute interruption du conducteur de protection (mise à la terre) ou tout débranchement de la borne de terre de protection d'un appareil vous expose à un risque d'électrocution susceptible de provoquer des blessures ou la mort.

### ATTENTION

Pour éviter d'éventuels dommages de l'équipement :

- Ne connectez pas plus de vingt appareils de tensions nominales identiques. Tous les appareils doivent avoir la même tension, mais les valeurs nominales de courant peuvent varier. Tous les appareils doivent disposer de la même version du micro-programme. Reportez-vous au chapitre **Identification de l'instrument** pour la version du microprogramme.
- Activez et désactivez toujours simultanément l'alimentation CA. Ne laissez jamais d'appareils sous tension lorsque les autres sont éteints.

Le fonctionnement en parallèle vous permet de connecter plusieurs alimentations pour créer un système avec un courant et une puissance totale plus élevés. Ceci s'applique aussi bien à l'alimentation en courant qu'à l'opération d'absorption de courant. En fonctionnement principal/secondaire, le groupe connecté en parallèle est contrôlé par l'appareil principal et apparaît sous forme d'alimentation supérieure unique. L'appareil principal offre l'ensemble de la plupart des fonctions source et de mesure.

N'oubliez pas de connecter les câbles principaux/secondaires et de configurer les commutateurs de terminaison avant de tenter d'allumer et de découvrir les appareils secondaires (voir **Connexions de plusieurs appareils** pour plus de détails).

## Configuration principale/secondaire

La procédure de configuration pour le fonctionnement en mode principal/secondaire est la suivante :

## 4 Utilisation du système d'alimentations régénératrices

- Configurez un appareil en tant que principal
- Configurez les autres appareils en tant qu'appareils secondaires avec des adresses de bus uniques
- Sélectionnez le mode de connexion et le délai de connexion automatique
- Effectuez une découverte unique sur l'appareil principal, il enregistre la configuration principale/secondaire
- Lors de l'activation, l'appareil principal peut se connecter aux appareils secondaires automatiquement ou manuellement
- Si la configuration principale/secondaire a été modifiée ultérieurement, elle doit être retrouvée

Configurez chaque instrument en parallèle en tant que principal ou secondaire.

Aide-mémoire des menus du panneau avant	Commande SCPI
Sélectionnez <b>System\Group\Function</b> Dans la boîte de dialogue, sélectionnez Principal, Secondaire ou None (Aucun). Appuyez ensuite sur Select.	Pour configurer l'appareil en parallèle : <b>INST:GRO:FUNC PRIM SEC NON</b>

Si l'appareil est le principal, un délai peut être programmé pour permettre aux appareils secondaires de démarrer avant que le principal ne se connecte automatiquement au secondaire. En cas de délai de la mise sous tension des appareils secondaires, la connexion automatique du principal peut échouer. « None » correspond à une opération non parallèle. Ne connectez pas les appareils configurés comme None au bus principal/secondaire, cela risque de provoquer une erreur de partage de courant (CSF).

Aide-mémoire des menus du panneau avant	Commande SCPI
Sélectionnez <b>System\Group\Delay</b> Dans la boîte de dialogue, définissez le délai de connexion automatique. Appuyez ensuite sur Select.	Pour régler le délai de connexion automatique sur 10 : <b>INST:GRO:PRIM:DEL 10</b>

Si l'appareil est un secondaire, chaque appareil secondaire doit recevoir une adresse de bus unique (comprise entre 1 et 19).

Aide-mémoire des menus du panneau avant	Commande SCPI
Sélectionnez <b>System\Group\Secondary</b> Dans la boîte de dialogue, sélectionnez l'adresse de l'appareil secondaire. Les valeurs peuvent aller de 1 à 19. Appuyez ensuite sur Select.	Pour régler l'adresse secondaire sur 1 : <b>INST:GRO:SEC:ADDR 1</b>

Spécifiez le mode de connexion de l'appareil principal.

**AUTO** : l'appareil principal se connecte automatiquement aux appareils secondaires précédemment découverts lors de la mise sous tension.

**MANual** : l'appareil principal se connecte aux appareils secondaires précédemment découverts quand il reçoit une commande de connexion du panneau avant ou de **INST:GRO:PRIM:CONN:MODE MAN**.

Aide-mémoire des menus du panneau avant	Commande SCPI
Sélectionnez <b>System\Group\Mode</b> Dans la boîte de dialogue, sélectionnez le mode de connexion. Appuyez ensuite sur Select.	Réglez le mode de connexion de l'appareil principal : <b>INST:GRO:PRIM:CONN:MODE AUTO</b>

Après la configuration de l'adresse de l'appareil secondaire, sélectionnez « Discover » (Découvrir) sur l'appareil principal pour initier la communication avec tous les appareils secondaires. Après la découverte initiale, le processus de découverte n'a pas besoin d'être relancé à moins que la configuration principale/secondaire ne change.

Aide-mémoire des menus du panneau avant	Commande SCPI
Sélectionnez <b>System\Group\Discover</b> Dans la boîte de dialogue, sélectionnez Discover pour découvrir tous les appareils secondaires. Appuyez ensuite sur Select.	Pour découvrir les appareils secondaires : <b>INST:GRO:PRIM:DISC</b>

Pour connecter manuellement l'appareil principal à tous les appareils secondaires précédemment découverts.

Aide-mémoire des menus du panneau avant	Commande SCPI
Sélectionnez <b>System\Group\Connect</b> Dans la boîte de dialogue, sélectionnez Connect pour connecter tous les appareils secondaires au principal. Appuyez ensuite sur Select.	Pour connecter l'appareil principal aux appareils secondaires précédemment découverts : <b>INST:GRO:PRIM:CONN</b>

## Écran du panneau avant principal/secondaire

La valeur du courant lue sur le panneau avant de l'appareil principal correspond à l'ensemble des valeurs des appareils principal et secondaire. Les appareils secondaires renvoient leurs valeurs de courant individuelles.

L'exemple suivant illustre les affichages du panneau avant pendant le fonctionnement principal/secondaire. Trois appareils sont connectés dans une configuration principale/secondaire. Les appareils fonctionnent en mode de priorité de tension.

### Il s'agit de l'appareil principal de 20 kW.

« P » indique l'appareil principal. Le courant affiché (30 A) est le courant de sortie total de tous les appareils connectés en parallèle. Cet appareil ne contribue qu'à hauteur de 10 A au total.



### Il s'agit de l'appareil secondaire de 20 kW.

« S » indique un appareil secondaire. Le courant affiché (10 A) est le courant que cet appareil apporte au total.



Il s'agit de l'appareil secondaire de 20 kW.  
« S » indique un appareil secondaire. Le courant affiché (10 A) est le courant que cet appareil apporte au total.



### Considérations relatives à la programmation principale/secondaire

Programmer les réglages de la tension et du courant de sortie de l'appareil principal de la même manière que vous le feriez pour un appareil individuel. Les limites de courant refléteront la capacité totale des appareils en parallèle. Pour de plus amples informations, reportez-vous aux sections **Réglage de la tension de sortie** et **Réglage du courant de sortie**. Les appareils secondaires sont verrouillés ; vous ne pouvez pas programmer les réglages des appareils.

Définissez les limites de courant positive et négative à un niveau élevé pour permettre une marge libre supplémentaire des dynamiques transitoires de programmation amont et aval. Les dynamiques transitoires sont principalement le résultat des courants de charge de la capacité de l'appareil testé. Notez que la limite de courant et l'état actuel de l'appareil principal sont proportionnés automatiquement parmi le groupe connecté en parallèle selon le courant nominal de chaque appareil.

Réduisez les vitesses de balayage pour atténuer la synchronisation imparfaite de la programmation de la tension. Les vitesses de balayage par défaut sont définies à leurs valeurs maximales.

**REMARQUE** En mode de priorité de courant, réglez le courant de sortie de l'appareil principal sur la valeur souhaitée. Réglez la limite de tension à une valeur supérieure à la tension de service attendue de l'appareil.

### Fonctionnement à courant maximum

En raison des tolérances de circuit individuelles entre les appareils connectés en parallèle dans une configuration principale/secondaire, le courant fourni par chaque appareil peut varier légèrement par rapport à la « quantité idéale », ce qui suppose que tous les appareils partagent le courant exactement de manière égale. Ces tolérances de circuit individuelles peuvent faire en sorte qu'un ou plusieurs des appareils passent du fonctionnement CV et atteignent une limite de courant  $\pm$  lorsque le courant nominal maximal du groupe connecté en parallèle est atteint. Le courant nominal maximal du groupe restera disponible, mais la réponse transitoire dynamique peut changer en raison de la transition de l'un des appareils en limite de courant.

Si un fonctionnement CV strict est requis dans toutes les conditions de fonctionnement, en particulier au courant nominal maximal du groupe connecté en parallèle, il est recommandé de régler la limite de courant sur la valeur maximale programmable de l'appareil principal. Si cela n'est pas suffisant, réduisez le courant de charge total demandé ou envisagez l'ajout d'un appareil supplémentaire afin de laisser une marge libre supplémentaire pour que le groupe puisse maintenir le CV dans des conditions de charge maximale.

### Déclencheurs du niveau de courant

Les déclencheurs de niveau courant (voir **TRIGger:ACQuire:CURRent**) sont disponibles en mode principal/secondaire mais peuvent avoir des limites de performance. Le courant mesuré sur l'appareil

principal génère le déclenchement de mesure. Comme le partage du courant entre les appareils peut être temporairement dégradé lors de changements rapides du courant de charge, le moment de déclenchement pourrait être affecté. Par conséquent, cette caractéristique doit être caractérisée sur la configuration de l'utilisateur pour déterminer si la performance est suffisante. Ces limitations de performance ne s'appliquent pas lorsque le courant de sortie est stable ou que la variation du courant est relativement lente.

### Communication principale/secondaire

Lorsqu'il est connecté, l'appareil principal interroge régulièrement les appareils secondaires concernant leur état. Si la communication avec un appareil secondaire échoue, par exemple si un appareil secondaire est activé ou désactivé, l'appareil principal et les autres appareils secondaires passent en protection principale/secondaire (PSP). Lorsque les autres appareils secondaires détectent que l'appareil principal s'est déconnecté, ils se connectent également au PSP. De plus, une erreur de partage de courant (CSF) peut se produire si les **commutateurs de terminaison** sont mal réglés.

Les appareils secondaires utilisent le sondage périodique d'état du principal comme un temporisateur pour déclencher la PSP. Si le secondaire ne reçoit pas de sondage d'état toutes les 10 secondes max., il passe en PSP.

Les appareils secondaires peuvent passer en PSP 10 secondes après l'activation. Une fois que ces appareils sont découverts, l'appareil principal établit une communication avec les appareils secondaires, effaçant ainsi la PSP.

### Protection principale/secondaire

Si l'appareil principal entre en protection, il envoie une commande de protection aux appareils secondaires. L'appareil principal indique le type d'événement de protection qui s'est produit. Les appareils secondaires indiquent PROT. Une fois que la condition de protection est corrigée, l'effacement de la protection sur l'appareil principal effacera la protection sur tous les appareils (voir **Effacement de la protection**).

Si un appareil secondaire est protégé, l'appareil principal et l'appareil secondaire sur lequel l'événement de protection s'est produit indiquent le type d'événement de protection. Tous les autres appareils secondaires indiquent PROT. Une fois que la condition de protection est corrigée, l'effacement de la protection sur l'appareil principal effacera la protection sur tous les appareils.

En cas d'utilisation des fonctions **Fault** (Défaillance) ou **Inhibit** (Inhibition) sur le connecteur numérique du panneau arrière, connectez les broches Fault/Inhibit seulement sur l'appareil principal. Vous n'avez pas besoin de connecter les broches Fault/Inhibit (Défaillance/Inhibition) des appareils secondaires.

### Détails sur la commande principale/secondaire

Une fois connecté, le groupe d'appareils est commandé par le principal et apparaît comme alimentation supérieure unique. Toutes les commandes de programmation doivent être envoyées à l'appareil principal. Les commandes SCPI suivantes ne sont **pas prises en charge** en mode principal/secondaire :

## 4 Utilisation du système d'alimentations régénératrices

CALibrate	toutes les commandes CALibrate sauf CAL:STAT
ELOG:CURRent<:MAX :MIN>	toutes les commandes ELOG:CURR:MAX et :MIN
OUTPut:COUPle<:STATe :OFFSet>	toutes les commandes :STAT et :OFFS

Les commandes SCPI suivantes peuvent être envoyées à l'appareil secondaire en mode principal/secondaire. D'autres commandes peuvent être autorisées, mais pourraient perturber le contrôle de l'appareil secondaire par l'appareil principal.

INSTRument:GROup:FUNCTion	Active la fonction principale/secondaire
INSTRument:SECOndary:ADDRes	Définit l'adresse du bus secondaire.
LXI:IDENtify:STATe	Allume le voyant d'identification LXI du panneau avant
LXI:MDNS:STATe	Définit l'état LXI MDNS
SYSTem:REBooT*	Commande Reboot (Redémarrage)

\*La commande de redémarrage peut également être envoyée à l'appareil principal, mais ne se propagera pas aux appareils secondaires.

## Dépannage

En mode principal/secondaire, les indicateurs d'état et les messages suivants peuvent apparaître sur le panneau avant :

**PSP** : protection principale/secondaire

Il y a eu une perte de communication entre les appareils principal et secondaire. Vérifiez que les **câbles CAT6A** sont installés dans les connecteurs principal/secondaire, et non dans le réseau local ou dans le Safety Disconnect.

**CSF** : erreur de partage de courant

Il y a eu un défaut de partage de courant dû au fait que la boucle principale/secondaire n'est pas conforme aux règles. Cela peut se produire si les **commutateurs de terminaison** sont mal réglés ou si l'un des appareils de la pile parallèle est éteint. Cela peut également se produire temporairement en cas de croisement de mode à partir d'un transitoire de charge ou en raison d'une programmation amont/aval rapide. Dans ce cas, réglez la limite de courant à une valeur supérieure. Un CSF peut également se produire si la boucle ne peut plus réguler le déséquilibre de courant entre les appareils. Un CSF peut également être une indication initiale de perte de communication avec l'appareil principal, qui passera en PSP.

**Pas d'appareils secondaires découverts** ou **1 appareil secondaire découvert** (si plusieurs appareils secondaires sont attendus)

Vérifiez qu'il n'y a pas d'adresses secondaires en double.

### Erreur 332, erreur principale/secondaire

Ceci indique le plus souvent que l'appareil principal a perdu la communication avec un secondaire, et qu'elle est généralement accompagnée d'une PSP. Vérifiez que les **câbles CAT6A** principal/secondaire sont correctement installés. Ceci peut également se produire lors de la modification de la configuration principale/secondaire. Réglez toujours l'appareil principale sur Aucun lors du changement de configuration principale/secondaire.

## Utilisation de la fonction d'absorption de courant

### Absorption de courant

#### Fonctionnement régénératif

### Absorption de courant

L'absorption de courant, également appelée programmation en aval, est la capacité à injecter du courant dans la borne positive de l'alimentation. Par exemple, le bloc d'alimentation injecte ou dissipe du courant dans la borne positive chaque fois qu'une tension de sortie inférieure est programmée. Cette opération est nécessaire, car l'énergie stockée dans le condensateur de sortie du bloc d'alimentation et la capacité externe de la charge, notamment le câblage, doivent être déchargée pour réduire la tension aux bornes de sortie.

La capacité à passer rapidement d'un niveau de tension constante élevé à un niveau inférieur améliore considérablement le temps de réponse en sortie du bloc d'alimentation. À un moment donné, une partie de cette énergie peut être renvoyée au réseau électrique par l'alimentation électrique. Cette application est la plus couramment utilisée de la fonction régénératrice de l'appareil. Elle est automatique et entièrement transparente pour l'utilisateur.

L'alimentation électrique peut absorber continuellement jusqu'à 100 % de son courant nominal pendant une durée illimitée. Cette fonction d'alimentation et d'absorption à **deux quadrants** de l'alimentation électrique permet d'opérer des transitions fluides entre le courant d'alimentation et d'absorption sans altérer les caractéristiques de sortie de l'alimentation ni engendrer des perturbations. Les commandes suivantes sont fournies pour exploiter pleinement la capacité de sortie à deux quadrants de l'alimentation.

#### Commande de limite de courant en mode de priorité de tension

En mode de priorité de tension, vous pouvez programmer une **limite de courant** négative et positive. Cela réduit le nombre de dépassements de courant susceptibles de se produire pendant une programmation amont ou aval rapide.

#### Commande de réglage de courant en mode de priorité de courant

En mode de priorité de courant, vous pouvez programmer le courant de sortie afin qu'il traverse en douceur le point zéro lors du passage d'une valeur positive à une valeur négative et vice versa. De plus, lors d'un fonctionnement dans le quadrant de courant négatif, vous pouvez programmer une **valeur de courant** négative qui maintienne le courant absorbé à la valeur spécifiée. Cela est utile, par exemple, lors de la décharge d'une batterie à un niveau de courant constant.

Si votre application exige un contrôle précis des courants source et absorbés, des **commandes de balayage** de courant sont disponibles. Ces dernières permettent de spécifier une vitesse de balayage de courant lors de l'alimentation et de l'absorption de courant.



### **Fonctionnement régénératif**

Le fonctionnement régénératif est automatique et ne nécessite aucune programmation de la part de l'utilisateur. Chaque fois que l'appareil absorbe du courant, soit par programmation en aval rapide de la sortie, soit par déchargement d'une source d'énergie comme une batterie, l'appareil dirigera la puissance excessive vers la source de courant alternatif. Pour de plus amples informations, veuillez consulter la section **Caractéristiques communes de l'alimentation secteur**.

## Programmation de la protection des sorties

**Définir la protection contre les surtensions**

**Définir la protection contre les surintensités**

**Temporisateur de surveillance de la sortie**

**Définir la protection contre les sous-tensions**

**Supprimer la protection de la sortie**

### Introduction

Les modèles Keysight RPS incluent de nombreuses fonctions de protection. Ces dernières désactivent la sortie afin de protéger l'appareil testé (DUT), ainsi que le bloc d'alimentation. Un voyant d'état situé sur le panneau avant s'allume lorsqu'une fonction de protection a été activée. La plupart des fonctions de protection sont de type à verrouillage. Autrement dit, elles doivent être désactivées une fois qu'elles ont été activées.

#### ATTENTION

Toutes les protections provoquent une déconnexion de la sortie à impédance élevée. La sortie est déconnectée sans courant d'absorption actif, de sorte que toute décharge de tension du DUT dépend des caractéristiques du DUT. L'appareil testé et l'inductance des fils de charge doivent se situer dans les limites matérielles spécifiées pour absorber en toute sécurité l'énergie stockée. Reportez-vous aux limites d'inductance de charge maximale dans la section **Caractéristiques supplémentaires**.

Parmi les fonctions de protection suivantes, les fonctions OV, OC, PROT, INH et UV peuvent être programmées par l'utilisateur.

**OV** La protection contre les surtensions compare la tension mesurée par les fils de mesure au niveau OVP positif programmé par l'utilisateur. Si la tension de mesure dépasse ce niveau, l'appareil passe en état de protection verrouillée. La protection OV est toujours activée.

**OV-** La protection contre les surtensions négatives se déclenche si les fils de mesure sont accidentellement inversés. Cette protection minimise l'augmentation de la tension de sortie qui en résulte en comparant la tension mesurée par les fils de mesure à un niveau de tension négative fixe de 20 % de la tension nominale de l'appareil. Si la tension de mesure dépasse ce niveau, l'appareil passe en état de protection verrouillée. La protection OV- est toujours activée.

**OC** La protection contre les surintensités peut être activée ou désactivée. Lorsqu'elle est activée, l'appareil passe en mode de protection verrouillée quand le courant de sortie atteint la limite de courant fixée. Cela permet d'éviter un fonctionnement persistant en limite de courant lors d'un fonctionnement en mode de priorité de tension.

**OP+** La protection positive contre la surpuissance compare la puissance de sortie à la puissance nominale de la source d'approvisionnement. Une protection OP+ survient quand le seuil de puissance nominal est dépassé. La protection OP+ est toujours activée.

## 4 Utilisation du système d'alimentations régénératrices

**OP-** La protection contre la surpuissance négative compare la puissance d'absorption à la puissance d'absorption nominale. Une protection OP- survient quand le seuil est dépassé. La protection OP- est toujours activée.

**OT** La protection contre les surchauffes surveille un certain nombre de températures internes et les compare à des limites de température prédéfinies. Si une température interne dépasse la limite prédéfinie, l'appareil se met en état de protection verrouillée. La requête **OUTP:PROT:TEMP:MARG?** peut être utilisée pour retourner la marge restante entre la lecture du capteur de température et le niveau de déclenchement en surchauffe. La protection OT est toujours activée. **Notez** que si une condition de surchauffe se produit sur le convertisseur d'entrée CA de l'instrument, l'appareil s'éteindra immédiatement sans avertissement et ne générera pas d'état OT.

**PF** La protection contre les pannes de courant détecte les perturbations de la ligne de courant alternatif qui pourraient provoquer un dysfonctionnement. Si une perturbation de ligne de courant alternatif est détectée, l'appareil passe en état de protection verrouillée. La protection PF est toujours activée.

**Prot** Protection indique que la sortie est désactivée en raison d'une expiration du temporisateur de surveillance de sortie programmée. Cela indique également qu'une erreur PSP s'est produite sur un appareil secondaire.

### **EDP** Protection dynamique excessive

protège l'instrument contre les dommages en cas de variations de tension répétitives trop importantes. Elles peuvent être causées par une liste, un signal arbitraire à durée de palier constante, une programmation de tension SCPI ou des changements de tension de sortie induits par la charge. Si elle n'est pas contrôlée, une dynamique de tension excessive pourrait faire en sorte que les condensateurs de l'instrument subissent des courants efficaces (entraînant un auto-échauffement) qui dépassent leurs limites de conception. Ce qui pourrait entraîner une défaillance prématurée. Lorsqu'il est déclenché, l'appareil se met en protection verrouillée. La protection dynamique excessive ne devrait pas s'engager dans des conditions normales. La protection EDP est toujours activée.

**INH** L'entrée d'inhibition (broche 3) située sur le connecteur numérique du panneau arrière peut être programmée pour servir de signal d'arrêt externe. Pour plus de détails, reportez-vous à la section **Entrée d'inhibition**.

**UV** La protection contre les sous-tensions est une fonction programmable par l'utilisateur qui peut être activée ou désactivée. Lorsqu'elle est activée, elle fournit une coupure de sous-tension qui empêche la tension de sortie de descendre en dessous d'un niveau sûr lors de la décharge d'une batterie. Si la tension mesurée sur les fils de mesure tombe en dessous du niveau de sous-tension programmé par l'utilisateur, l'appareil se met en état de protection verrouillée.

**PSP** Une erreur de protection principale/secondaire s'est produite dans le groupe connecté en parallèle. Toutes les sorties de tous les appareils connectés en parallèle sont désactivées. La protection PSP est toujours activée. Pour plus de détails, reportez-vous à la section **Protection de la connexion en parallèle**.

**DOV+** La surtension positive d'appareil testé est active lorsque la sortie est désactivée puis activée en mode HIGHZ. Si l'appareil testé applique une tension sur les bornes de sortie inférieure aux niveaux de tension suivants, la sortie ne se mettra pas en marche pour empêcher un courant excessif

de circuler **dans** l'appareil.

Priorité à la tension : si la tension de l'appareil testé dépasse la tension programmée de + 1 % de la tension nominale de l'appareil.

Priorité de courant : si la tension de l'appareil testé dépasse la limite de tension positive + 1 % de la tension nominale de l'appareil.

**DOV-** La surtension négative de l'appareil testé est active lorsque la sortie est désactivée puis activée. Si l'appareil testé applique une tension sur les bornes de sortie inférieure aux niveaux de tension suivants, la sortie ne sera pas activée pour empêcher un courant excessif de **sortir** de l'appareil.

Priorité à la tension : si la tension de l'appareil testé est inférieure à - 1 % de la tension nominale de l'appareil.

Priorité de courant : si la tension de l'appareil testé est inférieure à la limite de tension négative - 1 % de la tension nominale de l'appareil.

**LOV+** La protection contre les surtensions positives locales se déclenche si les fils de mesure à distance sont raccourcis accidentellement. Cette protection minimise l'augmentation de la tension de sortie qui en résulte en comparant la tension aux bornes de sortie à un niveau de tension de 1 volt plus 10 % de la valeur nominale au-dessus du niveau OVP positif programmé par l'utilisateur. Si la tension de sortie dépasse ce niveau, l'appareil passe en état de protection verrouillé. La protection LOV est toujours activée.

**LOV-** La protection contre les surtensions locales négatives n'est pas disponible sur les modèles deux quadrants.

**OCF+** La protection contre les erreurs de surintensité positive est active lorsque l'appareil testé applique une tension inverse aux bornes de sortie. Elle minimise le courant de crête résultant aux bornes de sortie en comparant le courant de sortie réel à un niveau fixe de 105 % du courant nominal de l'appareil. Si le courant dépasse ce niveau, l'appareil passe en protection verrouillée.

**OCF-** La protection contre les erreurs de surintensité négative est active en mode de priorité du courant lorsque l'appareil testé applique une tension aux bornes de sortie qui est supérieure au paramètre à la limitation de courant positive. Elle minimise le courant de crête résultant aux bornes de sortie en comparant le courant de sortie réel à un niveau fixe de 105 % du courant nominal de l'appareil. Si le courant dépasse ce niveau, l'appareil passe en protection verrouillée.

## Définir la protection contre les surtensions

La fonction de protection contre les surtensions désactive la sortie si la tension de sortie atteint la limite de surtension programmée. Le circuit OVP contrôle la tension aux bornes de mesure + et -. Un arrêt de l'OVP se produit automatiquement si les fils de mesure + et - sont accidentellement court-circuités l'un avec l'autre.

Aide-mémoire des menus du panneau avant	Commande SCPI
Sélectionnez <b>Protect\OVP</b> . Saisissez une valeur dans la zone de niveau OVP. Appuyez ensuite sur <b>Select</b> .	Pour régler le niveau OVP sur 400 volts : <b>VOLT:PROT 400</b>

## Définir la protection contre les surintensités

### Enable OCP

Lorsque la fonction de protection contre les surintensités est activée, l'alimentation se désactive lorsque le courant de sortie atteint la valeur limite de courant et passe de la tension constante (CV) à la limite de courant (CL+ ou CL-).

Aide-mémoire des menus du panneau avant	Commande SCPI
Sélectionnez <b>Protect\OCP</b> . Cochez la case <b>Enable OCP</b> . Appuyez ensuite sur <b>Select</b> .	Pour activer OCP : <b>CURR:PROT:STAT ON</b>

### Delay OCP

Vous pouvez spécifier un délai de l'OCP afin d'éviter le déclenchement de la protection contre les surintensités dus aux réglages de sortie momentanés, à la charge et aux changements d'état. Dans la plupart des cas, ces conditions temporaires ne sont pas considérées comme une défaillance de protection contre les surintensités : il serait gênant que de telles conditions désactivent la sortie. L'indication d'un délai OCP permet au circuit OCP d'ignorer ces modifications temporaires pendant le délai de temporisation spécifié. Une fois le délai OCP expiré, si la condition de surintensité persiste, la sortie est interrompue. Les options suivantes contrôlent le démarrage du temporisateur de protection contre les surintensités :

**Settings Change (Modification des réglages)** : permet d'activer le délai de protection contre les surintensités chaque fois qu'une commande modifie les réglages de sortie. Cela inclut les modifications apportées par le système de transitoire de sorte que le temporisateur est démarré à chaque palier de liste et modification de la sortie du signal arbitraire. Sont également incluses les variations de la vitesse de balayage de tension et de courant de sorte que le temporisateur est redémarré pendant toute la durée du balayage.

L'option **Current Limit (Limite de courant)** permet de déclencher le temporisateur de protection contre les surintensités à chaque basculement de la sortie sur la limite de courant.

Le délai peut être programmé entre 0 et 0,255 secondes. Vous pouvez indiquer si le temporisateur de l'OCP est déclenché par un basculement de la sortie en mode de limite de courant ou uniquement à la fin d'un changement de valeur dans l'état de la tension, du courant ou de la sortie.

Aide-mémoire des menus du panneau avant	Commande SCPI
Sélectionnez <b>Protect\OCP</b> . Saisissez une valeur de délai. Appuyez ensuite sur <b>Select</b> . Par défaut, le temporisateur est activé par un « Settings Change » (Modification des réglages) de sortie. Cochez la case « CC Transition » (Transition CC) pour démarrer le temporisateur suite à un basculement de la sortie en mode CL.	Pour indiquer un délai de 10 millisecondes : <b>CURR:PROT:DEL 0.01</b>  Pour démarrer le temporisateur suite à une modification des réglages de sortie : <b>CURR:PROT:DEL:STAR SCH</b>  Pour démarrer le temporisateur suite à un basculement de la sortie en mode CL : <b>CURR:PROT:DEL:STAR CCTR</b>

### Considérations sur les délais

Les facteurs qui influent sur la durée du changement des réglages de sortie ou de charge sont les suivants : la différence entre l'ancienne et la nouvelle valeur de sortie, la limite de courant ou de tension, la capacité de la charge en mode de priorité de tension ou l'inductance de la charge en mode de priorité de courant. Le délai nécessaire doit être déterminé de manière empirique ; les caractéristiques du temps de réponse de programmation de la sortie peuvent être utilisées à titre de référence.

Il convient également de souligner que le temps nécessaire à la sortie pour basculer en mode de limite de courant (CL) varie selon l'importance de la surintensité par rapport à la valeur limite de courant. Par exemple, si la surintensité est légèrement supérieure à la limite de courant, plusieurs dizaines de millisecondes peuvent être nécessaires à la sortie pour activer le bit d'état CC. En revanche, si elle dépasse considérablement limite de courant, il peut suffire de quelques centaines de microsecondes à la sortie pour activer le bit d'état CL. Pour déterminer à quel moment la sortie sera interrompue, vous devez ajouter le temps nécessaire à l'activation du bit d'état CL au délai de protection contre les surintensités. Si la surintensité persiste au-delà de la somme des deux intervalles de temps, la sortie est interrompue.

### Considérations principale/secondaire

En fonctionnement principal/secondaire, le partage du courant pendant les transitions rapides du courant de charge pourrait entraîner un faux déclenchement de la protection si l'OCP est programmé indépendamment sur chaque appareil. Il est recommandé de programmer l'OCP uniquement pour l'appareil principal. L'OCP principale/secondaire est mis en œuvre par le microprogramme de l'appareil principal qui interroge l'état de chaque appareil secondaire. Notez cependant que cela peut entraîner un délai de 0,5 seconde.

### Temporisateur de surveillance de la sortie

Lorsqu'il est activé, le temporisateur de surveillance fait basculer la sortie en mode de protection en l'absence d'activité d'E/S SCPI sur les interfaces de commande à distance (USB, LAN, GPIB) dans le délai spécifié par l'utilisateur. Notez que la fonction de temporisateur de surveillance n'est PAS réinitialisée par une activité sur le panneau avant : la sortie est interrompue une fois le délai écoulé.

À l'expiration du délai, la sortie est désactivée, mais l'état de sortie programmé ne change pas. Le bit Prot (Protection) du registre des événements d'état suspect ainsi que le voyant Prot (Protection) du panneau avant sont activés. Une protection de veille peut être désactivée, comme décrit dans la section Supprimer la protection de la sortie.

Vous pouvez programmer le délai de surveillance entre 1 et 3 600 secondes par incréments de 1 seconde. Pour activer le temporisateur de surveillance et spécifier une valeur de délai, procédez comme suit :

Aide-mémoire des menus du panneau avant	Commande SCPI
-----------------------------------------	---------------

---

Sélectionnez <b>Protect\WDog</b> .	Pour activer le temporisateur de surveillance :
Cochez la case <b>Enable Watchdog</b> (Activer la surveillance) pour activer le temporisateur de surveillance.	<b>OUTP:PROT:WDOG ON</b>
Saisissez une valeur dans la zone <b>Watchdog Delay</b> (Délai de surveillance). Appuyez ensuite sur <b>Select</b> .	Pour régler le temporisateur de surveillance sur 120 secondes : <b>OUTP:PROT:WDOG:DEL 120</b>

---

### Définir la protection contre les sous-tensions

La fonction de protection contre les sous-tensions désactive la sortie si la tension de sortie passe sous le réglage de basse tension programmé. Le circuit de tension contrôle la tension aux bornes de mesure + et –.

Cette fonction de protection est différente du réglage de la **sous-tension** qui est programmé en mode priorité du courant, qui **empêche** uniquement la tension de sortie de descendre en dessous de la limite de sous-tension lors de la décharge d'une batterie.

Lorsqu'elle est activée, la protection contre les sous-tensions est toujours « armée ». Par conséquent, la tension de sortie doit être supérieure au réglage de la protection pour éviter qu'elle ne se déclenche. Il y a deux façons d'empêcher cette protection de se déclencher pendant la transition de tension lorsque la sortie est activée :

- Désactivez la protection contre les sous-tensions et activez la sortie. Lorsque la tension de sortie est à la valeur cible, activez la protection contre les sous-tensions. Bien entendu, si la valeur de la tension (ou la limite de tension en mode priorité du courant) est inférieure au réglage de la protection, la protection contre les sous-tensions se déclenche quand même.
- Activez la protection contre les sous-tensions, mais définissez un délai plus long que le temps de programmation de la sortie pour éviter que la protection ne se déclenche pendant le temps de programmation de la tension. La protection contre les sous-tensions sera maintenue pendant la période de délai pour permettre à la tension de sortie de passer à la valeur cible.

Vous pouvez programmer le délai de protection contre les sous-tensions entre 20,48 microsecondes et 2611 secondes par incréments de 20,48 microsecondes. Pour activer la protection contre les sous-tensions et spécifier une valeur de délai, procédez comme suit :

---

Aide-mémoire des menus du panneau avant	Commande SCPI
Sélectionnez <b>Protect\UVP</b> .	Pour régler le niveau UVP sur 2 volts :
Saisissez une valeur dans la zone de niveau UVP.	<b>VOLT:PROT:LOW 2</b>
Cochez ensuite <b>Enable UVP</b> .	Pour activer la protection contre les sous-tensions :
Saisissez une valeur dans la zone <b>UVP Delay</b> (Délai d'UVP).	<b>VOLT:PROT:LOW:STAT ON</b>
Appuyez ensuite sur <b>Select</b> .	Pour spécifier un délai de protection de 5 secondes : <b>VOLT:PROT:LOW:DEL 5</b>

---

## Supprimer la protection de la sortie

Si une surtension, une surintensité, une surchauffe, une panne de courant, une limitation de puissance, un blocage ou toute autre condition de protection se produit, la sortie est déconnectée dans un état d'impédance élevée. Le voyant d'état de fonctionnement approprié situé sur le panneau avant s'allume. Pour annuler la fonction de protection et retourner à un mode de fonctionnement normal, commencez par éliminer la condition à l'origine de la défaillance de protection. Ensuite, annulez la fonction de protection comme suit :

Aide-mémoire des menus du panneau avant	Commande SCPI
Sélectionnez <b>Protect\Clear</b> .	Pour corriger une défaillance de protection :
Sélectionnez <b>Clear</b> .	<b>OUTP:PROT:CLE</b>

**REMARQUE** La sortie est réactivée dès que la fonction de protection de sortie est effacée.



## Programmation des transitoires de sortie

### Actions communes à tous les transitoires

#### Programmation d'un transitoire de palier

#### Programmation d'un transitoire de liste

#### Programmation d'un signal arbitraire

### Introduction

Un transitoire de sortie se définit comme une action déclenchée qui provoque une variation de tension ou de courant en sortie. Les trois types de transitoires disponibles sont les suivants : palier, liste et signaux arbitraires.

**Step** : un palier de sortie est un événement ponctuel qui augmente ou réduit la tension ou le courant en réponse à un déclenchement.

**List** : une liste décrit une séquence complexe et parfaitement synchronisée des paliers ou variations de sortie.

**Arbitrary Waveform** : un générateur de signaux arbitraires (Arb) permet à la sortie de générer des signaux de tension ou de courant complexes définis par l'utilisateur et pouvant comporter jusqu'à 65 535 points de données.

### Actions communes à tous les transitoires

- Activer la fonction de transitoire de sortie
- Programmer les paramètres de transitoire
- Sélectionner la source de déclenchement
- Démarrer le système de transitoire
- Déclencher le transitoire

Le processus de déclenchement du transitoire est illustré ci-dessous. Ce dernier vaut pour tous les types de transitoires. Les flèches situées à droite sont propres aux transitoires de liste. Pour une vue d'ensemble du système de déclenchement, reportez-vous à la section **Présentation des déclenchements**.

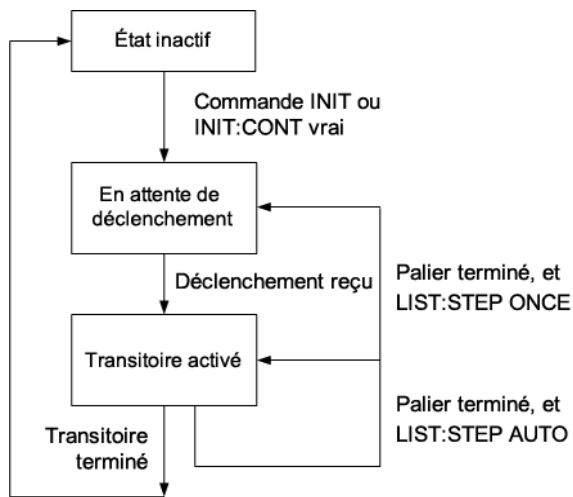

### Activer la fonction de transitoire de sortie

Tout d'abord, vous devez activer la sortie pour répondre aux déclenchements de transitoires. Si une fonction de transitoire de sortie n'est pas activée, aucune action ne se produit, même si vous avez programmé les paramètres de transitoire et généré un déclenchement de transitoire.

Aide-mémoire des menus du panneau avant	Commande SCPI
<p>Sélectionnez <b>Transient Mode</b>.</p> <p>Si vous opérez en mode de priorité de tension, sélectionnez le mode Voltage. Si vous êtes en mode de priorité de courant, sélectionnez le mode Current.</p> <p>Dans la liste déroulante, sélectionnez l'un des transitoires : Step (Palier), List (Liste) ou Arb transients (Transitoires arbitraires). Appuyez ensuite sur <b>Select</b>.</p>	<p>Pour activer la fonction de transitoire, utilisez la commande suivante :</p> <p><b>VOLT:MODE STEP</b>  <b>VOLT:MODE LIST</b>  <b>VOLT:MODE:ARB</b></p> <p>ou</p> <p><b>CURR:MODE STEP</b>  <b>CURR:MODE:LIST</b>  <b>CURR:MODE:ARB</b></p>

**REMARQUE** En mode Step, la valeur déclenchée devient la valeur immédiate à la réception du signal de déclenchement. En mode Fixed, les signaux de déclenchement sont ignorés ; les valeurs immédiates restent effectives à la réception d'un signal de déclenchement.

### Programmer les paramètres de transitoire

Par exemple, réglez le niveau de tension déclenché si vous programmez un palier de tension :

Aide-mémoire des menus du panneau avant	Commande SCPI
<p>Sélectionnez <b>Transient Step</b>.</p> <p>Sélectionnez la zone Trig Voltage pour régler la tension. Saisissez une valeur et appuyez sur Select.</p>	<p>Pour régler un niveau de palier de tension sur 15 V :</p> <p><b>VOLT:TRIG 15</b></p>

### Sélectionner la source de déclenchement

## 4 Utilisation du système d'alimentations régénératrices

### REMARQUE

L'exécution d'une commande TRIGger:TRANsient[:IMMediate] sur le bus génère toujours un déclenchement de transitoire immédiat, quelle que soit la source de déclenchement sélectionnée.

Si vous n'utilisez pas le menu du panneau avant ou une commande TRIGger:TRANsient[:IMMediate] pour déclencher le transitoire, sélectionnez une source de déclenchement à partir des options suivantes :

Source de déclenchement	Description
Bus	Sélectionne un déclenchement de périphérique GPIB, *TRG ou <GET> (Group Execute Trigger).
External	Sélectionne TOUTE broche configurée comme entrée de déclenchement sur le port de commande numérique.
Immediate	Déclenche le transitoire dès que la commande INITiated est exécutée.
Pin<1-7>	Sélectionne une broche <n> spécifique qui est configurée comme entrée de déclenchement sur le port de commande numérique.

Les commandes suivantes permettent de sélectionner une source de déclenchement :

Aide-mémoire des menus du panneau avant	Commande SCPI
Sélectionnez <b>Transient\TrigSource</b> . Pour sélectionner des déclenchements par bus, sélectionnez l'option Bus. Pour sélectionner des déclenchements immédiats, sélectionnez l'option Imm. Pour sélectionner la broche numérique 5 comme déclencheur, sélectionnez l'option Pin 5 (Broche 5) ou EXT (Externe).	Pour sélectionner des déclenchements par bus : <b>TRIG:TRAN:SOUR BUS</b> Pour sélectionner un déclencheur immédiat : <b>TRIG:TRAN:SOUR IMM</b> Pour sélectionner la broche numérique 5 comme déclencheur : <b>TRIG:TRAN:SOUR PIN5</b> Pour sélectionner n'importe quelle broche configurée comme déclencheur : <b>TRIG:TRAN:SOUR EXT</b>

### Démarrer le système de transitoire

Si l'appareil est sous tension, le système de déclenchement est à l'état inactif. Dans cet état, le système de déclenchement est désactivé, ignorant ainsi tous les déclenchements. Les commandes INITiate permettent au système de déclenchement de recevoir des signaux de déclenchement.

Aide-mémoire des menus du panneau avant	Commande SCPI
Sélectionnez <b>Transient\Control</b> . Parcourez la liste jusqu'à l'option Initiate. Appuyez ensuite sur <b>Select</b> .	Pour démarrer le système de déclenchement de transitoire : <b>INIT:TRAN</b>

Il ne faut que quelques millisecondes à l'instrument pour être prêt à recevoir un signal de déclenchement une fois la commande INITiate:TRANsient reçue. Si un déclenchement se produit

avant que le système de déclenchement soit prêt, le déclenchement est ignoré. Vous pouvez tester le bit WTG\_tran du registre d'état de fonctionnement pour savoir quand l'instrument est prêt à recevoir un signal de déclenchement après avoir été initialisé.

Aide-mémoire des menus du panneau avant	Commande SCPI
Sélectionnez <b>Transient\Control</b> . Le champ Trig state indique "Initiated".	Pour connaître le bit WTG_tran (bit 4) : <b>STAT:OPER:COND?</b>

Si la valeur de bit 16 est renvoyée par la requête, le bit WTG\_tran est vrai et l'instrument est prêt à recevoir le signal de déclenchement. Voir **Didacticiel d'état**.

**REMARQUE** À moins que la commande INITiate:CONTinuous:TRANsient ne soit programmée, l'instrument exécute un transitoire chaque fois qu'un signal de déclenchement est reçu. Ainsi, il sera nécessaire de démarrer le système de déclenchement chaque fois qu'un autre transitoire déclenché est souhaité.

## Déclencher le transitoire

Le système de déclenchement attend un signal de déclenchement à l'état initialisé. Vous pouvez déclencher immédiatement le transitoire comme suit :

Aide-mémoire des menus du panneau avant	Commande SCPI
Sélectionnez <b>Transient\Control</b> . Sélectionnez Trigger pour générer un signal de déclenchement immédiat, quelle que soit la valeur source de déclenchement.	Pour générer un déclenchement de transitoire : <b>TRIG:TRAN</b>  Autrement, si la source de déclenchement est BUS, vous pouvez également programmer une commande <b>*TRG</b> ou une commande IEEE-488 <get>.

Si une broche numérique est configurée comme source de déclenchement, l'instrument attend indéfiniment le signal de déclenchement. En l'absence de déclenchement, vous devez renvoyer manuellement le système de déclenchement à l'état inactif. Les commandes suivantes renvoient le système de déclenchement à l'état inactif :

Aide-mémoire des menus du panneau avant	Commande SCPI
Sélectionnez <b>Transient\Control</b> . Sélectionnez ensuite la commande Abort.	<b>ABOR:TRAN</b>

À la réception d'un signal de déclenchement, les fonctions déclenchées sont définies sur leurs valeurs de transitoire programmées. Une fois les actions déclenchées terminées, le système de déclenchement retourne à l'état inactif.

Vous pouvez tester le bit TRAN-actif dans le registre d'état de fonctionnement pour savoir quand le système de déclenchement de transitoire est retourné à l'état inactif.

Aide-mémoire des menus du panneau avant	Commande SCPI
-----------------------------------------	---------------

Sélectionnez **Transient\Control**.  
Le champ Trig state indique "Idle".

Pour connaître le bit TRAN-actif (bit 6) :  
**STAT:OPER:COND?**

Si la valeur du bit renvoyée par la requête est 64, le bit TRAN-actif est vrai et l'action de transitoire n'est PAS terminée. Si le bit TRAN-actif est faux, l'action de transitoire est terminée. Pour de plus amples informations, reportez-vous à la section **Didacticiel d'état**.

### Programmation d'un transitoire de palier

- **Activer la fonction de palier**
- **Programmer le niveau de palier**
- **Générer un signal de déclenchement**

#### Activer la fonction de palier

Tout d'abord, vous devez activer la fonction de transitoire de palier.

Aide-mémoire des menus du panneau avant	Commande SCPI
Sélectionnez <b>Transient\Mode</b> . En mode priorité de tension, sélectionnez le mode de tension. Dans le mode de priorité du courant, sélectionnez le mode de courant. Dans la liste déroulante, sélectionnez Step. Appuyez ensuite sur <b>Select</b> .	Pour activer la fonction de transitoire, utilisez la commande suivante : <b>VOLT:MODE STEP</b> ou <b>CURR:MODE STEP</b>

#### Programmer le niveau de palier

Les commandes suivantes permettent de programmer le niveau de palier de sortie déclenché. La sortie passe à ce niveau à la réception du signal de déclenchement. Dans le menu du panneau avant, vous pouvez uniquement programmer le niveau de palier selon le mode de priorité dans lequel vous vous trouvez : priorité de tension ou de courant.

Aide-mémoire des menus du panneau avant	Commande SCPI
Sélectionnez <b>Transient\Step</b> . Sélectionnez la zone Trig Voltage pour régler la tension. Sélectionnez la zone Trig Current pour régler le courant. Saisissez une valeur et appuyez sur Select.	Pour régler un niveau de palier de tension sur 15 V : <b>VOLT:TRIG 15</b>  Pour régler un niveau de palier de courant sur 1 A : <b>CURR:TRIG 1</b>

#### Générer un signal de déclenchement

Le palier de sortie peut générer un signal de déclenchement pouvant être acheminé vers une broche du port numérique qui a été configurée comme sortie de déclenchement (TOUT). Les commandes suivantes permettent de générer un signal de déclenchement lorsque le palier se produit :

Aide-mémoire des menus du panneau avant	Commande SCPI
<p>Sélectionnez <b>Transient\Step</b>.</p> <p>Cochez la case Enable Trigger Output (Activer la sortie de déclenchement). Appuyez ensuite sur <b>Select</b>.</p>	<p>Pour programmer un signal de déclenchement de palier, utilisez :</p> <p><b>STEP:TOUT ON</b></p>

## Programmation d'un transitoire de liste

- Activer la fonction de liste
- Programmer les niveaux de liste
- Programmer les durées de palier
- Spécifier la cadence de liste
- Spécifier tous les signaux de déclenchement que la liste doit générer
- Indiquer le nombre de fois que la liste doit se répéter
- Indiquer comment la liste doit se terminer

Les listes vous permettent de générer des séquences complexes de variations de sortie à l'aide d'une temporisation rapide et précise, qui peut être synchronisée avec des signaux internes ou externes. Contrairement à un palier de sortie, qui représente une variation de sortie ponctuelle, une liste de sortie est une séquence de variations de sortie. Les listes peuvent contenir jusqu'à 512 paliers programmés individuellement et peuvent être configurées pour se répéter. Seuls les paramètres associés à l'un des modes de priorité (priorité de tension ou priorité de courant) peuvent être contrôlés par une liste.

Les listes de tension et de courant sont cadencées par une liste de paliers distincte qui définit la durée ou pause de chaque palier. Chacun des 512 paliers peut être associé à une durée de palier unique, qui indique le temps en secondes durant lequel la liste demeure sur ce palier avant de passer au palier suivant. Reportez-vous à **LIST:DWEL** pour plus d'informations sur la plage et la résolution de temporisation.

Les listes peuvent également être à pas de déclenchement. Dans ce cas, la liste avance d'un palier à chaque déclenchement reçu. Cela est utile si vous souhaitez qu'une liste de sortie suive de près les événements déclenchés. Dans une liste à pas de déclenchement, les déclenchements reçus pendant la durée de palier sont ignorés. Vous pouvez régler le temps de palier de la liste sur zéro pour vous assurer qu'aucun déclenchement n'est perdu.

Les listes peuvent également générer des signaux de déclenchement sur des paliers spécifiques. Cette opération est effectuée par deux listes supplémentaires : une liste BOST (début de palier) et une liste EOST (fin de palier). Ces listes déterminent les paliers qui génèrent un signal de déclenchement et si ce dernier est généré au début ou à la fin du palier. Ces signaux de déclenchement permettent de synchroniser d'autres événements avec la liste.

Toutes les listes (tension, courant, palier, BOST, EOST) doivent être définies sur le même nombre de paliers. Sinon, une erreur se produit lorsque la liste est exécutée. Pour des raisons pratiques, une liste

## 4 Utilisation du système d'alimentations régénératrices

peut être programmée avec un palier ou une valeur unique. Dans ce cas, une liste à palier unique est traitée comme si elle contenait le même nombre de paliers que les autres listes, toutes les valeurs étant égales à une seule valeur.

**REMARQUE** Les données de la liste ne sont pas enregistrées avec l'état enregistré d'un instrument.

### Activer la fonction de liste

Tout d'abord, vous devez activer la fonction de transitoire de liste.

Aide-mémoire des menus du panneau avant	Commande SCPI
Sélectionnez <b>Transient\Mode</b> . En mode priorité de tension, sélectionnez le mode de tension. Dans le mode de priorité du courant, sélectionnez le mode de courant. Dans la liste déroulante, sélectionnez List. Appuyez ensuite sur <b>Select</b> .	Pour activer la fonction de transitoire, utilisez la commande suivante : <b>VOLT:MODE LIST</b> ou <b>CURR:MODE LIST</b>

### Programmer les niveaux de liste

**Exemple 1** Si vous programmez une impulsion de tension ou un train d'impulsions, réglez l'amplitude de l'impulsion. Par exemple, pour générer une impulsion d'une amplitude de 15 V, programmez l'amplitude de l'impulsion (palier 0) et l'amplitude du temps de désactivation (palier 1).

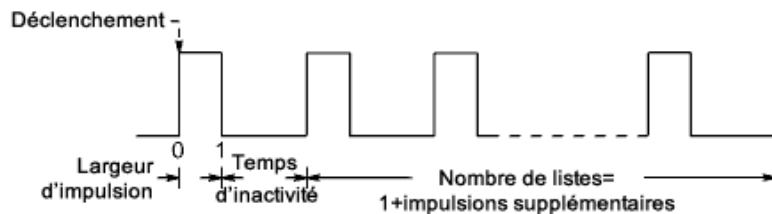

Aide-mémoire des menus du panneau avant	Commande SCPI
Sélectionnez <b>Transient&gt;List\Config</b> . Sélectionnez List Step 0 (Palier de liste 0) (l'impulsion) et saisissez une valeur de tension de 15. Appuyez sur Select. Sélectionnez List Step 1 (Palier de liste 1) (le temps de désactivation) et saisissez une valeur de tension de 0. Appuyez sur Select. Utilisez les flèches de direction vers le haut/bas pour sélectionner le palier suivant.	Pour programmer l'amplitude du palier 0 (l'impulsion) et le palier 1 (le temps de désactivation) : <b>LIST:VOLT 15,0</b>

**Exemple 2** Si vous programmez une liste de tensions, indiquez les amplitudes de la liste. L'ordre dans lequel les valeurs sont saisies détermine l'ordre dans lequel les valeurs seront générées. Pour générer la liste de tensions illustrée dans la figure, une liste peut inclure les valeurs suivantes : 9, 0, 6, 0, 3, 0 :

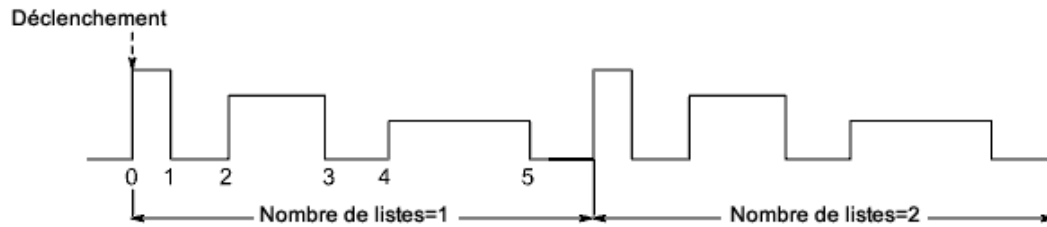

Aide-mémoire des menus du panneau avant	Commande SCPI
Sélectionnez <b>Transient&gt;List\Config</b> .	Pour programmer une liste de tensions de 5 paliers :
Sélectionnez le numéro de palier de liste et saisissez une valeur de tension. Appuyez sur Select.	<b>LIST:VOLT 9,0,6,0,3,0</b>
Répétez cette opération pour chaque palier. Utilisez les flèches de direction vers le haut/bas pour sélectionner le palier suivant.	

### Programmer les durées de palier

**Exemple 1** Si vous programmez une impulsion de tension, réglez le temps de palier de la largeur d'impulsion. Indiquez également le palier du temps de désactivation. Cela est nécessaire si vous générez un train d'impulsions, car le temps de désactivation détermine l'intervalle entre les impulsions. Pour générer une impulsion dotée d'une largeur d'une seconde et un temps de désactivation de deux secondes, utilisez la commande suivante :

Aide-mémoire des menus du panneau avant	Commande SCPI
Sélectionnez <b>Transient&gt;List\Config</b> .	Pour programmer le temps du palier 0 (l'impulsion) et du palier 1 (le temps de désactivation) :
Sélectionnez List Step 0 (Palier de liste 0) (l'impulsion) et saisissez une valeur de palier de 1. Appuyez sur Select.	<b>LIST:DWEL 1,2</b>
Sélectionnez List Step 1 (Palier de liste 1) (le temps de désactivation) et saisissez une valeur de palier de 2. Appuyez sur Select. Utilisez les flèches de direction vers le haut/bas pour sélectionner le palier suivant.	

Une impulsion unique est à présent configurée. Si vous souhaitez générer un train d'impulsions, indiquez simplement le nombre de répétitions d'impulsions comme décrit dans la section « Spécifier le nombre de répétitions de la liste ».

**Exemple 2** Si vous programmez une liste de tensions, indiquez les amplitudes de la liste. Les valeurs de palier déterminent l'intervalle, en secondes, durant lequel la sortie demeure sur chaque palier dans la liste avant de passer au palier suivant. Pour spécifier six intervalles de palier avec les valeurs suivantes : 2, 3, 5, 3, 7, 3 :

Aide-mémoire des menus du panneau avant	Commande SCPI
-----------------------------------------	---------------



Sélectionnez <b>Transient&gt;List\Config</b> .	Pour programmer un temps de palier de 5 valeurs, utilisez la commande suivante :
Sélectionnez le numéro de palier de liste et saisissez une valeur de palier. Appuyez sur <b>Select</b> .	<b>LIST:DWEL 2,3,5,3,7,3</b>
Répétez cette opération pour chaque palier. Utilisez les flèches de direction vers le haut/bas pour sélectionner le palier suivant.	

**REMARQUE** Le nombre de paliers de pause doit être égal au nombre de paliers de tension. Si une liste de paliers ne comporte qu'une seule valeur, cette dernière sera appliquée à tous les paliers de la liste.

### Spécifier la cadence de liste

Vous pouvez déterminer si la liste doit être à temps de palier ou à pas de déclenchement. Par défaut, la liste est à temps de palier.

Dans une liste à temps de palier, chaque palier se voit affecté un temps spécifique. Le temps de palier détermine la durée pendant laquelle la sortie demeure sur le palier. À l'expiration de chaque durée de palier, le palier suivant est immédiatement généré.

Dans une liste à pas de déclenchement, la liste avance d'un palier à chaque déclenchement reçu. Vous pouvez également spécifier une durée de palier si vous souhaitez ignorer les déclenchements pendant ce temps ou garantir un temps de palier minimal entre les paliers de liste déclenchés.

Aide-mémoire des menus du panneau avant	Commande SCPI
Sélectionnez <b>Transient&gt;List\Pace</b> .	Pour configurer la liste en fonction d'un temps de palier :
Sélectionnez <b>Dwell paced</b> (Temps de palier) ou <b>Trigger paced</b> (Pas de déclenchement). Appuyez ensuite sur <b>Select</b> .	<b>LIST:STEP AUTO</b>
	Pour configurer la liste en fonction d'un pas de déclenchement :
	<b>LIST:STEP ONCE</b>

### Spécifier tous les signaux de déclenchement que la liste doit générer

Vous pouvez générer des signaux de déclenchement pouvant être acheminés vers d'autres destinations. Par exemple, vous pouvez utiliser des signaux de déclenchement pour déclencher des actions sur un équipement externe raccordé au port numérique. La figure suivante contient un exemple de génération de quatre signaux de déclenchement sur la liste de tension fournie dans l'exemple 2.

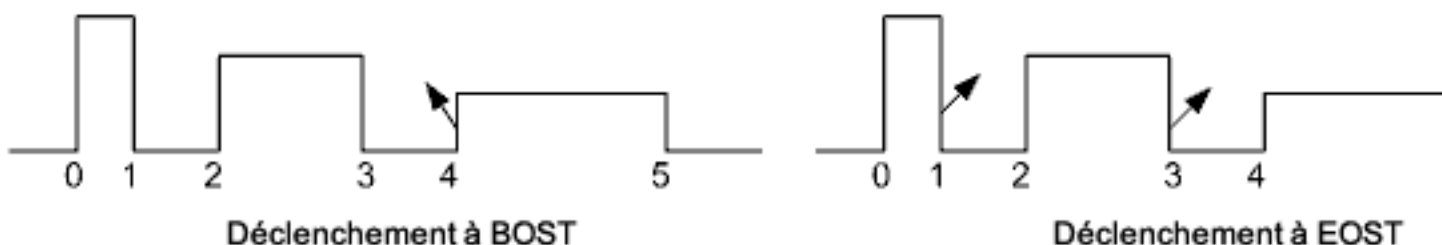

Aide-mémoire des menus du panneau avant	Commande SCPI
<p>Sélectionnez <b>Transient&gt;List\Config</b>.</p> <p>Sélectionnez le numéro de palier de liste 4. Pour générer un déclenchement, entrez 1 dans le champ Tout Begin Step (Palier de début de tension de sortie).</p> <p>Sélectionnez les numéros de palier de liste 0, 2 et 4. Pour générer un déclenchement, entrez 1 dans le champ Tout End Step (Palier de fin de tension de sortie).</p> <p>Si vous saisissez des zéros dans les champs, aucun déclenchement n'est généré pour le palier.</p>	<p>Pour programmer un déclenchement au début du palier 4 :</p> <p><b>LIST:TOUT:BOST 0,0,0,1,0</b></p> <p>Pour programmer un déclenchement à la fin des paliers 0, 2 et 4 :</p> <p><b>LIST:TOUT:EOST 1,0,1,0,1,0</b></p>

### Indiquer le nombre de fois que la liste doit se répéter

Vous pouvez déterminer le nombre de fois que vous souhaitez répéter la liste (ou l'impulsion). Lors de la réinitialisation, le nombre de répétitions de la liste est défini sur une. L'envoi du paramètre INFINITY à la commande SCPI permet de répéter la liste indéfiniment.

Aide-mémoire des menus du panneau avant	Commande SCPI
<p>Sélectionnez <b>Transient&gt;List\Repeat</b>.</p> <p>Saisissez le nombre de répétitions de liste (2) et appuyez sur Select.</p>	<p>Pour programmer la liste afin qu'elle soit répétée deux fois :</p> <p><b>LIST:COUN 2</b></p>

### Indiquer comment la liste doit se terminer

Spécifiez l'état de sortie une fois la liste terminée. Deux options possibles : la sortie retourne à la valeur qui était appliquée avant le démarrage de la liste, ou la sortie demeure sur la valeur du dernier palier de liste.

Aide-mémoire des menus du panneau avant	Commande SCPI
<p>Sélectionnez <b>Transient&gt;List\Terminate</b>.</p> <p>Sélectionnez Return to Start (Retour pour commencer) ou Stop at Last Step (Arrêter au dernier palier), puis appuyez sur Select.</p>	<p>Pour renvoyer la sortie à l'état précédant la liste :</p> <p><b>LIST:TERM:LAST OFF</b></p> <p>Pour maintenir la sortie à l'état de fin de la liste :</p> <p><b>LIST:TERM:LAST ON</b></p>

## Programmation d'un signal arbitraire

- Activer la fonction Arb
- Spécifier le type de signal arbitraire et le palier
- Configurer le signal arbitraire
- Indiquer le nombre de fois que le signal arbitraire doit se répéter
- Indiquer comment le signal arbitraire doit se terminer

## 4 Utilisation du système d'alimentations régénératrices

### REMARQUE

Certaines combinaisons d'amplitude et de fréquence de sortie peuvent dépasser la capacité de réponse dynamique de l'instrument et provoquer une interruption de la sortie, notamment en l'absence de charge. Pour de plus amples informations, reportez-vous à la section **Réponse dynamique de la sortie**.

La sortie de l'instrument peut être modulée à l'aide de son générateur de formes d'onde arbitraires intégré. Cela permet à la sortie de générer des signaux de tension ou de courant complexes définis par l'utilisateur. Vous trouverez ci-dessous les principales caractéristiques du générateur de signaux arbitraires à palier constant :

- Génèrent des signaux arbitraires de tension ou de courant.
- Les signaux arbitraires peuvent contenir jusqu'à 65 535 points de données.
- Une valeur de temps d'attente unique s'applique à chaque point du signal arbitraire constant (voir **ARB:VOLT:CDW:DWEL** pour les informations sur le temps d'attente).
- Seul le signal arbitraire correspondant au mode de priorité actif (tension ou courant) peut être généré.

### Activer la fonction Arb

Tout d'abord, vous devez activer la fonction de forme d'onde Arb.

Aide-mémoire des menus du panneau avant	Commande SCPI
Sélectionnez <b>Transient\Mode</b> . En mode priorité de tension, sélectionnez le mode de tension. Dans le mode de priorité du courant, sélectionnez le mode de courant. Dans la liste déroulante, sélectionnez Arb. Appuyez ensuite sur <b>Select</b> .	Pour activer la fonction de transitoire, utilisez la commande suivante : <b>VOLT:MODE ARB</b> ou <b>CURR:MODE ARB</b>

### Spécifier le type de signal arbitraire et le palier

Pour spécifier le type de signal arbitraire et le temps de palier :

Aide-mémoire des menus du panneau avant	Commande SCPI
Sélectionnez <b>Transient\Arb\Config</b> . Dans la liste déroulante, sélectionnez un signal arbitraire de tension ou de courant. Appuyez ensuite sur <b>Select</b> .	Pour spécifier un signal arbitraire de tension ou de courant : <b>ARB:FUNC:TYPE VOLT</b> <b>ARB:FUNC:TYPE CURR</b>
Saisissez une valeur de temps dans le champ Dwell (Temps de palier). Appuyez ensuite sur <b>Select</b> .	Pour spécifier un temps d'attente de 1 milliseconde : <b>ARB:VOLT:CDW:DWEL 0.001</b> <b>ARB:CURR:CDW:DWEL 0.001</b>

### Configurer le signal arbitraire

Notez que vous pouvez utiliser les flèches numériques haut et bas pour visualiser les points de signal arbitraire dans la boîte de dialogue de configuration de la face avant Transient\Arb\Config. Vous ne pouvez pas *programmer* de données de signal arbitraire à partir du panneau avant. Vous devez utiliser

les commandes SCPI `ARB:CURREnt:CDWell` ou `ARB:VOLTage:CDWell` pour programmer les données de signal arbitraire.

Aide-mémoire des menus du panneau avant	Commande SCPI
Sélectionnez <b>Transient\Arb\Config</b> .	Pour programmer 10 points dans un signal arbitraire de courant :
Si les points du signal arbitraire ont été importés ou programmés à l'aide de la commande SCPI, le champ Points indique le nombre de points du signal arbitraire.	<code>ARB:CURREnt:CDW 1,2,2,3,4,4,3,2,2,1</code>
Pour afficher l'amplitude d'un point de signal arbitraire, entrez le numéro de points dans le champ Point # (N° de point). Le champ Level (Niveau) indique l'amplitude.	Pour connaître le nombre de points du signal arbitraire : <code>ARB:CURREnt:CDW:POIN?</code>
	Pour connaître les valeurs de point du signal arbitraire : <code>ARB:CURREnt:CDW?</code>

### Indiquer le nombre de fois que le signal arbitraire doit se répéter

Selon votre application, indiquez le nombre de fois que le signal arbitraire doit être répété. L'envoi du paramètre INFINITY à la commande SCPI permet de répéter le signal arbitraire indéfiniment. Lors de la réinitialisation, le nombre de répétitions du signal arbitraire est défini sur 1.

Aide-mémoire des menus du panneau avant	Commande SCPI
Sélectionnez <b>Transient\Arb\Repeat</b> .	Pour programmer le signal arbitraire afin qu'il soit répété deux fois :
Saisissez le nombre de répétitions de liste (2) et appuyez sur Select.	<code>ARB:COUN 2</code>

### Indiquer comment le signal arbitraire doit se terminer

Spécifiez l'état de sortie une fois le signal arbitraire terminé. Deux options possibles : la sortie retourne à l'état dans lequel elle se trouvait avant le démarrage du signal arbitraire ou la sortie demeure sur les valeurs du dernier point de signal arbitraire.

Aide-mémoire des menus du panneau avant	Commande SCPI
Sélectionnez <b>Transient\Arb\Terminate</b> .	Pour renvoyer la sortie à l'état précédant le signal arbitraire :
Sélectionnez Return to Start (Retour pour commencer) ou Stop at Last Step (Arrêter au dernier palier), puis appuyez sur Select.	<code>ARB:TERM:LAST OFF</code>
	Pour maintenir la sortie sur le point final du signal arbitraire : <code>ARB:TERM:LAST ON</code>

## Séquence de la sortie

Cette section décrit la procédure à suivre pour synchroniser les séquences d'activation et de désactivation des sorties sur un ou plusieurs appareils.

### Délais d'activation/de désactivation

### Couplage de la sortie

### Séquence de plusieurs appareils

### Comportement d'activation/de désactivation de la sortie

#### Délais d'activation/de désactivation

Tous les blocs d'alimentation présentent un décalage de délai interne qui s'applique entre le moment où une commande d'activation est reçue et le moment où la sortie est réellement activée. L'indication d'un décalage de délai commun sert de point de référence pour les délais d'activation des sorties programmés par l'utilisateur. Ce décalage défini par l'utilisateur permet également de connecter plusieurs blocs d'alimentation ensemble et de programmer des séquences d'activation précises sur plusieurs appareils. Le délai d'activation programmé par l'utilisateur est ensuite ajouté au point de référence commun défini par l'utilisateur.

Il n'est pas nécessaire d'indiquer un décalage de délai commun lorsque les sorties sont désactivées. Les sorties commencent à exécuter leurs délais de désactivation dès qu'une commande de désactivation de la sortie est reçue. Le décalage de délai interne est décrit dans le tableau suivant.

	Priorité de tension	Priorité de courant
Alimentation électrique autonome	≤ 8 millisecondes	≤ 7 millisecondes

#### Couplage de la sortie

En plus des commandes d'activation et de désactivation de la sortie du panneau avant et SCPI, vous pouvez utiliser les signaux OnCouple et OffCouple pour activer et désactiver la sortie. Ces signaux offrent un niveau de contrôle supplémentaire lors du séquençage de la sortie sur un ou plusieurs appareils.

La figure suivante illustre le chemin de programmation suivi lorsque les signaux OnCouple et OffCouple sont utilisés pour contrôler la sortie.

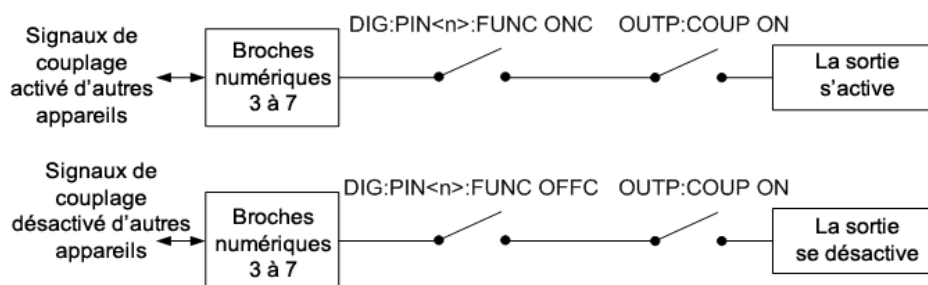

Comme indiqué dans la figure, vous pouvez configurer les broches 3 à 7 des ports numériques pour fournir les signaux OnCouple et OffCouple qui activent ou désactivent la sortie. La sortie est activée ou désactivée lorsque le signal correspondant est vrai. Pour de plus amples informations sur la configuration des broches de ports numériques, reportez-vous à la section **Commande de couplage des sorties**.

Enfin, vous devez activer le séquençement de sortie afin qu'il utilise des signaux OnCouple et OffCouple pour activer ou désactiver la sortie. Voir Activer le séquençement de sortie ci-dessous.

## Séquencement de plusieurs appareils

Pour définir l'activation de la sortie sur plusieurs appareils :

1. Connectez et configurez les broches du connecteur numérique de tous les appareils.
2. Activez la fonction de séquençement sur chaque appareil.
3. Spécifiez le délai d'activation programmé par l'utilisateur pour chaque appareil.
4. Cette étape est nécessaire si les blocs d'alimentation utilisés présentent **différents** décalages de délai minimaux (voir ci-dessous). Spécifiez un décalage de délai commun pour tous les appareils séquencés. Le décalage de délai commun doit être supérieur ou égal au décalage de délai maximal le plus grand. Une fois le décalage de délai commun terminé, les délais d'activation programmés par l'utilisateur sont appliqués.

## Connecter et configurer les broches du connecteur numérique

Les broches du connecteur numérique des appareils séquencés doivent être connectées ensemble et configurées. Pour de plus amples informations, reportez-vous à la section **Commande de couplage des sorties**.

## Activer le séquençement de sortie

Le séquençement d'activation des sorties doit être activé sur chaque appareil qui participe à la synchronisation d'activation des sorties.

Aide-mémoire des menus du panneau avant	Commande SCPI
Sélectionnez <b>Output\Sequence\Couple</b> .	Pour activer le séquençement, envoyez la commande suivante :
Cochez la case Enable (Activer) pour activer le séquençement.	<b>OUTP:COUP ON</b>
Désélectionnez-la pour la désactiver.	Pour désactiver le séquençement, envoyez la commande suivante :
	<b>OUTP:COUP OFF</b>

## Spécifier les délais d'activation et de désactivation pour chaque appareil

Les délais d'activation peuvent être spécifiés pour tous les appareils couplés. N'importe quelle séquence de délai peut être mise en œuvre. Il n'existe aucune restriction quant à la séquence ou à l'appareil qui est activé en premier.

## 4 Utilisation du système d'alimentations régénératrices

Aide-mémoire des menus du panneau avant	Commande SCPI
Sélectionnez <b>Output\Sequence\Couple</b> .	Pour programmer un délai d'activation :
Spécifiez le délai d'activation en secondes.	<b>OUTP:DEL:RISE 02</b>
Répétez cette opération pour chaque appareil supplémentaire.	Répétez cette opération pour chaque instrument.

Des délais de désactivation peuvent également être spécifiés pour tous les appareils couplés. N'importe quelle séquence de délai peut être mise en œuvre. Il n'existe aucune restriction quant à la séquence ou à l'appareil qui est désactivé en premier.

Aide-mémoire des menus du panneau avant	Commande SCPI
Sélectionnez <b>Output\Sequence\Delay</b> .	Pour programmer un délai de désactivation :
Spécifiez le délai de désactivation en secondes.	<b>OUTP:DEL:FALL .01</b>
Répétez cette opération pour chaque appareil supplémentaire.	Répétez cette opération pour chaque instrument.

### Spécifier le décalage de délai commun

**REMARQUE** Il n'est pas nécessaire d'indiquer un décalage de délai commun lorsque les sorties sont désactivées. Les sorties commencent à exécuter leurs délais de désactivation dès qu'une commande Output Off (Désactivation de sortie) est reçue (et que tout délai de désactivation programmé par l'utilisateur a expiré).

Spécifier un décalage de délai commun vous permet de synchroniser précisément les délais d'activation programmés par l'utilisateur lors du séquençage des alimentations avec différents décalages de délai internes.

Dans la figure de gauche, vous pouvez voir comment les décalages de délais internes sont ajoutés aux délais programmés par l'utilisateur. Les compensations internes de délai varient en fonction du mode de priorité.

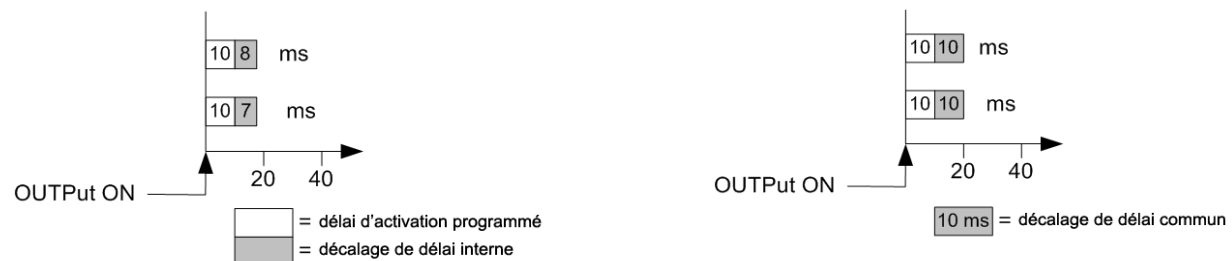

Même s'il n'est pas possible de supprimer les temps de décalage de délai interne, vous pouvez spécifier un décalage de délai commun afin de synchroniser avec précision les délais d'activation programmés par l'utilisateur. Si dans la figure de gauche, vous deviez programmer un décalage de délai commun de 10 ms comme indiqué sur la figure de droite, ce décalage de délai commun remplacerait alors les différents délais internes des appareils couplés. Le décalage commun de 10 ms synchroniserait effectivement le délai interne des appareils couplés.

Le décalage de délai commun veille à ce que la synchronisation des délais d'activation programmés par l'utilisateur démarre à la fin du décalage de délai commun. Recherchez le décalage de délai de chaque appareil et utilisez le délai le plus lent comme décalage de délai commun.

Aide-mémoire des menus du panneau avant	Commande SCPI
<p>Sélectionnez <b>Output\Sequence\Couple</b>.</p> <p>Le champ Max delay offset (Décalage de délai max.) pour cette trame indique le décalage de délai de l'appareil.</p> <p>Saisissez la valeur de décalage de délai de l'appareil le plus lent dans le champ Delay offset (Décalage de délai) en millisecondes. Appuyez ensuite sur <b>Select</b>.</p>	<p>Pour rechercher le décalage de délai de l'appareil le plus lent :</p> <p><b>OUTP:COUP:MAX:DOFF?</b></p> <p>Pour spécifier le décalage de délai commun à l'aide du décalage de délai de l'appareil le plus lent :</p> <p><b>OUTP:COUP:DOFF &lt;valeur&gt;</b></p>

## Comportement d'activation ou de désactivation à la sortie

Les séquences d'activation ou de désactivation sont principalement contrôlées par trois facteurs : les délais d'activation ou de désactivation programmés par l'utilisateur, ainsi que les réglages des modes de priorité de tension et de courant.

Le tableau suivant décrit le réglage de l'impédance de sortie pour les séquences d'activation/de désactivation. Vous pouvez spécifier une impédance de sortie faible ou élevée lorsque vous travaillez en mode de priorité de tension.

Impédance d'activation/de désactivation de sortie pour	Priorité de tension	Priorité de courant
RP797xA; RP798xA	L'impédance peut être sélectionnée par l'utilisateur via Commande <b>OUTPut:TMODe</b>	Activation de l'impédance élevée Désactivation de l'impédance élevée

Les descriptions des séquences d'activation et de désactivation des sorties suivantes sont illustrées dans l'organigramme ci-joint.

### Séquence de sortie activée

Les circuits d'alimentation internes sont reliés à la sortie par un commutateur statique. À réception d'une commande de sortie activée, l'alimentation patiente pendant toute la durée du délai d'activation programmé par l'utilisateur.

En mode de priorité de tension avec LowZ, l'alimentation programme ses circuits internes sur une tension de zéro et définit les limites de courant sur leurs valeurs programmées par l'utilisateur. En mode de priorité de tension avec HighZ, l'alimentation correspond à la tension de l'appareil testé.

En mode de priorité de courant, l'alimentation correspond également à la tension interne de l'appareil testé. Ceci garantit que lorsqu'une source telle qu'une batterie est connectée à la sortie, il n'y a pas de surtension dans l'alimentation de l'appareil testé lorsque la sortie est activée.

Le commutateur de sortie statique de l'alimentation est ensuite fermé, connectant ainsi la sortie aux circuits d'alimentation internes. La tension et le courant de sortie sont programmés selon les réglages de l'utilisateur. La sortie suit le réglage de la vitesse de balayage.

### Séquence de sortie désactivée



## 4 Utilisation du système d'alimentations régénératrices

À réception d'une commande de sortie désactivée, le bloc d'alimentation patiente pendant toute la durée du délai de désactivation programmé par l'utilisateur.

En priorité tension avec LowZ, l'alimentation programme la tension à zéro. Elle attend ensuite jusqu'à 250 ms pour décharger le courant de l'appareil testé. Elle programme ensuite les limites de courant sur leurs réglages minimums. En mode de priorité de tension avec HighZ, l'alimentation programme les limites de courant sur leurs réglages minimum.

En mode de priorité de courant, l'alimentation programme le courant sur zéro. Elle attend ensuite jusqu'à 250 ms pour décharger le courant de l'appareil testé.

Le commutateur de sortie statique de l'alimentation est ensuite ouvert, déconnectant ainsi la sortie des circuits d'alimentation internes.

**REMARQUE** Si vous souhaitez programmer une vitesse de balayage de désactivation de tension, vous devez régler la vitesse de balayage et programmer la tension de sortie à zéro *avant* d'envoyer la commande de désactivation de sortie.

---

### Séquence de protection de la sortie désactivée

La séquence de protection de désactivation diffère de la séquence de désactivation normale en ce qu'elle désactive la sortie le plus rapidement possible. Lorsqu'un événement de protection est détecté, l'alimentation ouvre immédiatement le commutateur de sortie statique. Cela prend généralement moins de 50  $\mu$ s après la détection initiale.

### Organigramme d'activation ou de désactivation

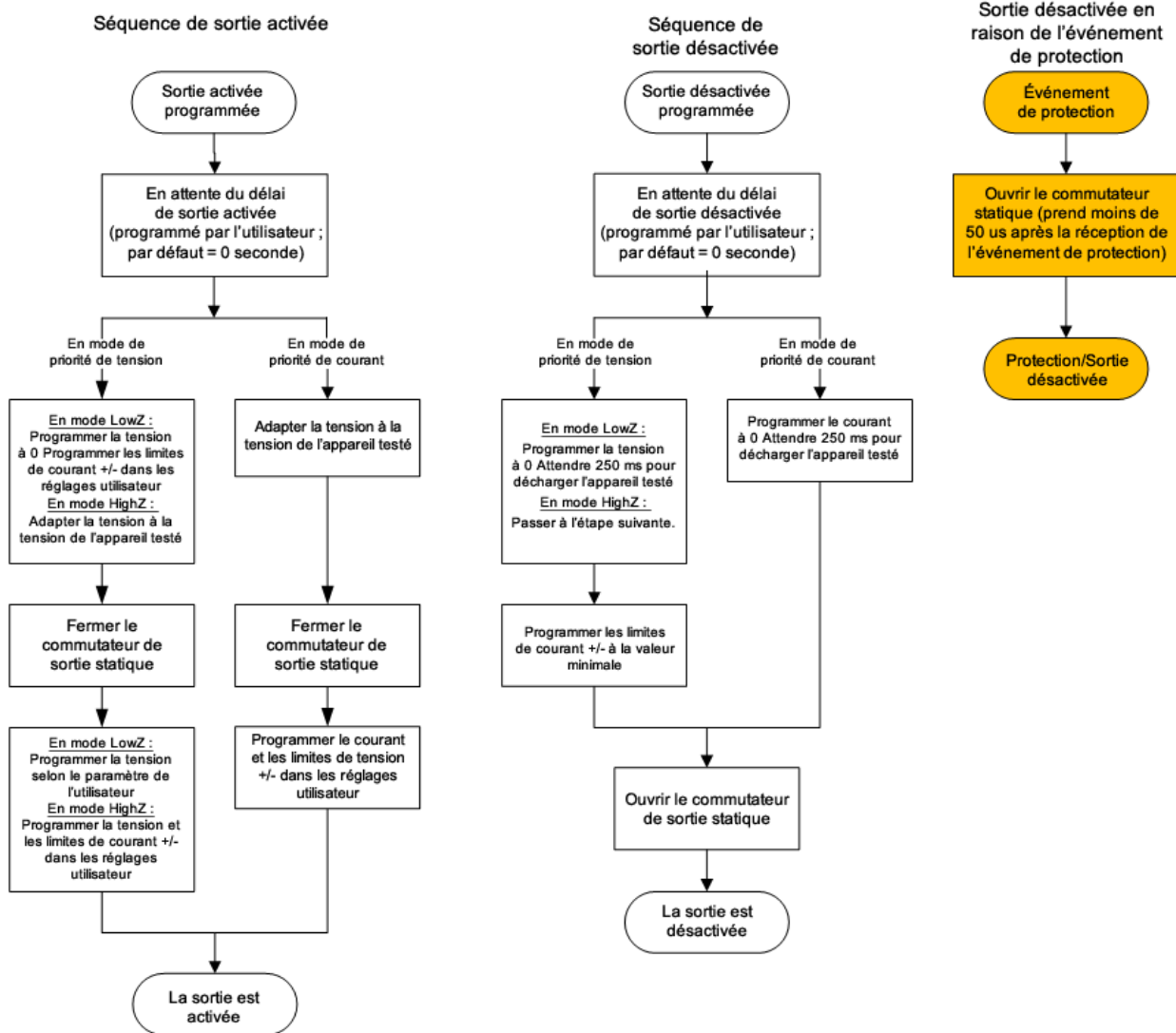

## Réalisation de mesures

### Mesures moyennes

### Balayage de mesure

### Fenêtrage de la mesure

### Mesures en ampères-heures et en watts-heures

### Mesures numérisées

### Déclenchement de la mesure

## Mesures moyennes

Les modèles Keysight RPS sont équipés d'un voltmètre et d'un ampèremètre entièrement intégrés qui permettent de mesurer la tension et le courant fournis à la charge.

Chaque fois que l'alimentation est activée, le panneau avant mesure automatiquement la tension et le courant de sortie en acquérant un certain nombre de mesures durant le nombre spécifié de cycles de tension d'alimentation et en calculant la moyenne des échantillons. Le nombre par défaut de cycles de tension d'alimentation est de 1 cycle. Dans 1 cycle, le nombre d'échantillons (ou points) est de 3 255 à 60 Hz et de 3 906 à 50 Hz. L'intervalle d'échantillonnage par défaut est de 5,12 microsecondes. Les commandes suivantes permettent d'effectuer une mesure :

Aide-mémoire des menus du panneau avant	Commande SCPI
Sélectionnez la touche <b>Meter</b> .	Pour mesurer la tension, le courant ou la puissance moyenne de sortie (CC) :
Appuyez continuellement sur la touche pour parcourir les fonctions de mesure suivantes :	<b>MEAS:VOLT?</b>
Voltage, Current (Tension, Courant)	<b>MEAS:CURR?</b>
Voltage, Power (Tension, Puissance)	<b>MEAS:POW?</b>
Voltage, Current, Power (Tension, Courant, Puissance)	Pour renvoyer les données de mesure du tableau précédemment acquis :
Si des tirets s'affichent, la mesure sur le panneau avant est interrompue, car une mesure est en cours sur l'interface de commande à distance.	<b>FETC:VOLT?</b>
	<b>FETC:CURR?</b>
	<b>FETC:POW?</b>

## Balayage de mesure

Vous pouvez définir le temps de mesure en nombre de cycles de tension d'alimentation (NPLC). L'utilisation d'un nombre entier de cycles de tension d'alimentation peut réduire le bruit de mesure provenant des sources de fréquence réseau.

Aide-mémoire des menus du panneau avant	Commande SCPI
-----------------------------------------	---------------

Sélectionnez **Measure\Sweep**.

Saisissez le nombre de cycles de tension d'alimentation dans le champ NPLC.

Appuyez ensuite sur **Select**.

Pour définir le nombre de cycles de tension d'alimentation à 10 :

**SENS:SWE:NPLC 10**

#### REMARQUE

La fréquence de secteur CA est détectée automatiquement pour SENSE:SWEep:NPLC.

## Fenêtrage de la mesure

Le fenêtrage est un processus de conditionnement des signaux qui réduit les erreurs dans les mesures de moyennes effectuées en présence de signaux périodiques et de bruit. Deux fonctions de fenêtre sont disponibles : Rectangulaire et de Hanning. À la mise sous tension, la fenêtre de mesure est rectangulaire.

La fenêtre rectangulaire calcule les mesures de moyennes sans aucun conditionnement de signal. Cependant, en présence de signaux périodiques, tels qu'une ondulation de ligne CA, une fenêtre rectangulaire peut introduire des erreurs lors du calcul des mesures de moyennes. Ce problème peut survenir lorsqu'un nombre non entier de cycles de données a été acquis en raison du dernier cycle partiel de données acquises.

L'une des manières de remédier à l'ondulation de la ligne CA consiste à utiliser une fenêtre de Hanning. La fenêtre Hanning applique une fonction de pondération  $\cos^4$  aux données pour calculer les mesures moyennes. De cette manière, le bruit CA est atténué dans la fenêtre de mesure. Une atténuation optimale est possible lorsque la mesure inclut au moins trois cycles de signaux.

Aide-mémoire des menus du panneau avant	Commande SCPI
Sélectionnez <b>Measure\Window</b> . Sélectionnez Rectangular (Rectangulaire) ou Hanning. Appuyez ensuite sur <b>Select</b> .	Pour définir la fenêtre de mesure en mode Hanning : <b>SENS:WIND HANN</b>

## Mesures en ampères-heures et en watts-heures

Les mesures en ampères-heures et en watts-heures sont effectuées indépendamment des autres mesures.

Les mesures en ampères-heures et en watts-heures sont créées en cumulant les mesures de courant et de puissance de toute la plage à une vitesse moyenne de 200 000 échantillons/seconde. Les accumulateurs peuvent contenir une quantité suffisante de données pendant au moins 100 000 heures.

La limite approximative de charge cumulée est  $\pm(900\,000\,000 \cdot I_{\text{nominale}})$  en coulombs ou  $\pm(250\,000 \cdot I_{\text{nominale}})$  en ampères-heures.

La limite approximative d'énergie cumulée est  $\pm(1,100,000,000 \cdot P_{\text{nominale}})$  en joules ou  $\pm(310\,000 \cdot I_{\text{nominale}})$  en watts-heures.

## 4 Utilisation du système d'alimentations régénératrices

$I_{nominale}$  correspond au courant nominal de l'appareil.  $P_{nominale}$  correspond à la puissance nominale de l'appareil.

Renvoyer des mesures d'ampères-heures et watts-heures :

Aide-mémoire des menus du panneau avant	Commande SCPI
Sélectionnez <b>Measure</b> VAHWH. Affiche les ampères-heures et les watts-heures cumulées.	Renvoyer des ampères-heures et watts-heures : <b>FETC:AHO?</b> <b>FETC:WHO?</b>

Réinitialiser les mesures d'ampères-heures et watts-heures :

Aide-mémoire des menus du panneau avant	Commande SCPI
Sélectionnez <b>Measure</b> VAHWH. Sélectionnez <b>Reset</b> pour remettre les mesures à zéro.	Pour réinitialiser les ampères-heures et watts-heures : <b>SENS:AHO:RES</b> <b>SENS:WHO:RES</b>

### Mesures numérisées

En plus des mesures de tension, de courant et de puissance moyennes, qui sont disponibles depuis le panneau avant et via les commandes SCPI, des mesures numérisées peuvent être renvoyées. Les mesures numérisées diffèrent des mesures moyennes, car vous pouvez sélectionner le type de mesure renvoyé et régler avec précision la qualité de la mesure.

#### Types de mesure

Les mesures numérisées suivantes sont disponibles. Ces dernières ne peuvent être mesurées qu'à l'aide de la commande SCPI correspondante.

**ACDC** est un calcul qui renvoie la mesure de valeur efficace vraie totale (CA + CC).

Le niveau **HIGH (FAIBLE)** est un calcul qui génère un histogramme du signal en utilisant 16 cases entre les points de données maximal et minimal. La case contenant la plupart des points de données au-delà du point de 50 % est la case élevée. La moyenne de tous les points de données dans la case élevée est indiquée comme niveau High (Élevé). Si aucune case élevée ne contient plus de 1,25 % du nombre total de points acquis, le point de données maximal est renvoyé.

Le niveau **LOW (FAIBLE)** est un calcul qui génère un histogramme du signal en utilisant 16 cases entre les points de données maximal et minimal. La case contenant la plupart des points de données en dessous du point de 50 % est la case faible. La moyenne de tous les points de données dans la case faible est indiquée comme niveau Low (Faible). Si aucune case faible ne contient plus de 1,25 % du nombre total de points acquis, le point de données minimal est renvoyé.

**MAX** est la valeur maximale de la mesure numérisée.

**MIN** est la valeur minimale de la mesure numérisée.

Des requêtes de tableau permettant de renvoyer TOUTES les valeurs dans le tampon de mesure de tension et de courant sont également disponibles. Aucune moyenne n'est appliquée, seules les données brutes sont renvoyées par la mémoire tampon.

Aide-mémoire des menus du panneau avant	Commande SCPI
Non disponible	Pour mesurer la tension et le courant efficaces : <b>MEAS:VOLT:ACDC?</b> <b>MEAS:CURR:ACDC?</b>  Pour mesurer le niveau élevé d'une impulsion : <b>MEAS:VOLT:HIGH?</b> <b>MEAS:CURR:HIGH?</b>  Pour mesurer le niveau faible d'une impulsion : <b>MEAS:VOLT:LOW?</b> <b>MEAS:CURR:LOW?</b>
	Pour mesurer la valeur maximale : <b>MEAS:VOLT:MAX?</b> <b>MEAS:CURR:MAX?</b> <b>MEAS:POW:MAX?</b>  Pour mesurer la valeur minimale : <b>MEAS:VOLT:MIN?</b> <b>MEAS:CURR:MIN?</b> <b>MEAS:POW:MIN?</b>  Pour effectuer une mesure et renvoyer les données de tableau : <b>MEAS:ARR:VOLT?</b> <b>MEAS:ARR:CURR?</b> <b>MEAS:ARR:POW?</b>

### Qualité de mesure

La figure suivante illustre la relation entre les échantillons (ou points) de mesure et l'intervalle qui sépare les échantillons dans une mesure type. Vous pouvez régler la mesure avec précision en indiquant le nombre de points dans l'acquisition de la mesure ainsi que l'intervalle entre les points.

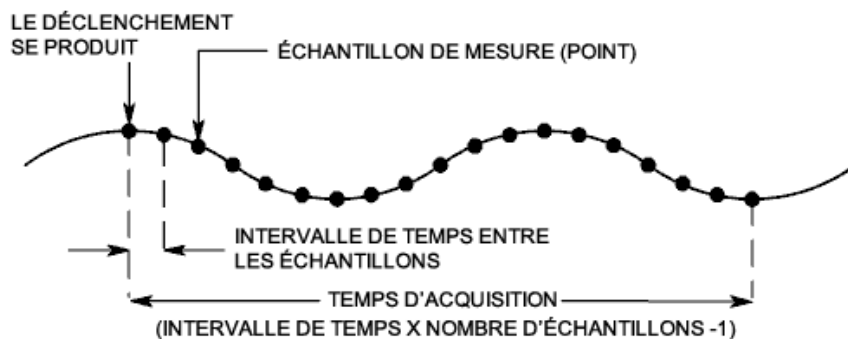

Vous pouvez configurer l'acquisition de la mesure comme suit :

Aide-mémoire des menus du panneau avant	Commande SCPI
-----------------------------------------	---------------

---

Sélectionnez <b>Measure Sweep</b> .	Pour définir l'intervalle à 60 µs avec
Entrez le nombre de points. Appuyez ensuite sur <b>Select</b> .	4 096 échantillons :
Entrez l'intervalle. Appuyez ensuite sur <b>Select</b> .	<b>SENS:SWE:TINT 60E-6</b>
	<b>SENS:SWE:POIN 4096</b>

---

Le nombre maximal de points d'échantillonnage disponibles pour toutes les mesures est de 512 K points (K = 1024). Les valeurs d'intervalle sont comprises entre 5,12 microsecondes et 40 000 secondes pour les mesures de tension et de courant. Les valeurs supérieures à 5,12 microsecondes sont arrondies à l'incrément de 5,12 microsecondes le plus proche. Les valeurs supérieures à 10,24 microsecondes sont arrondies à l'incrément de 10,24 microsecondes le plus proche. Les valeurs supérieures à 20,48 µs sont arrondies à l'incrément de 20,48 microsecondes le plus proche.

Notez que les modèles Keysight RPS prennent également en charge la commande **NPLC** (nombre de cycles de tension d'alimentation) pour configurer les nuances et les points de mesure comme précédemment décrit. La commande NPLC augmente automatiquement le nombre de points pour conserver l'intervalle le plus court possible. Si le nombre maximal de points pour cet intervalle est atteint, la commande augmente l'intervalle.

### Déclenchement de la mesure

- **Capturer au besoin les données de pré-déclenchement**
- **Sélectionner la source de déclenchement**
- **Démarrer le système d'acquisition**
- **Déclencher la mesure**
- **Récupérer la mesure**
- **Événements de déclenchement multiples par mesure**

Le système de déclenchement d'acquisition permet de synchroniser les mesures numérisées à l'aide d'un signal de déclenchement provenant d'un certain nombre de sources de déclenchement. Utilisez ensuite les commandes **FETCH** pour renvoyer les informations de tension ou de courant à partir des données acquises.

La figure suivante illustre le processus d'acquisition des mesures. Ce processus s'applique aux déclencheurs de mesure et à l'enregistrement de données externe. Pour une vue d'ensemble du système de déclenchement, reportez-vous à la section **Présentation des déclenchements**.

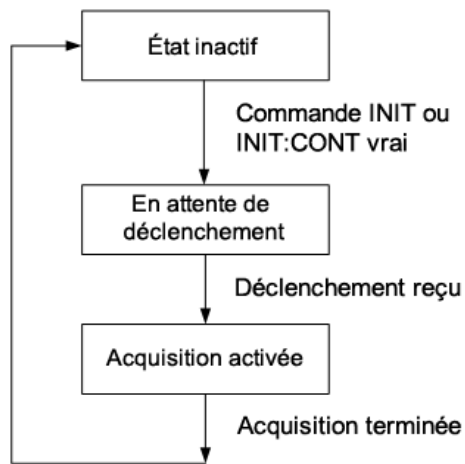

### Capter au besoin les données de pré-déclenchement

Le système de mesure vous permet de capturer des données avant, après ou sur le signal de déclenchement. Comme l'illustre la figure suivante, vous pouvez déplacer le bloc de données lue dans le tampon d'acquisition en faisant référence au déclenchement. Cela permet d'échantillonner les données avant ou après le déclenchement.

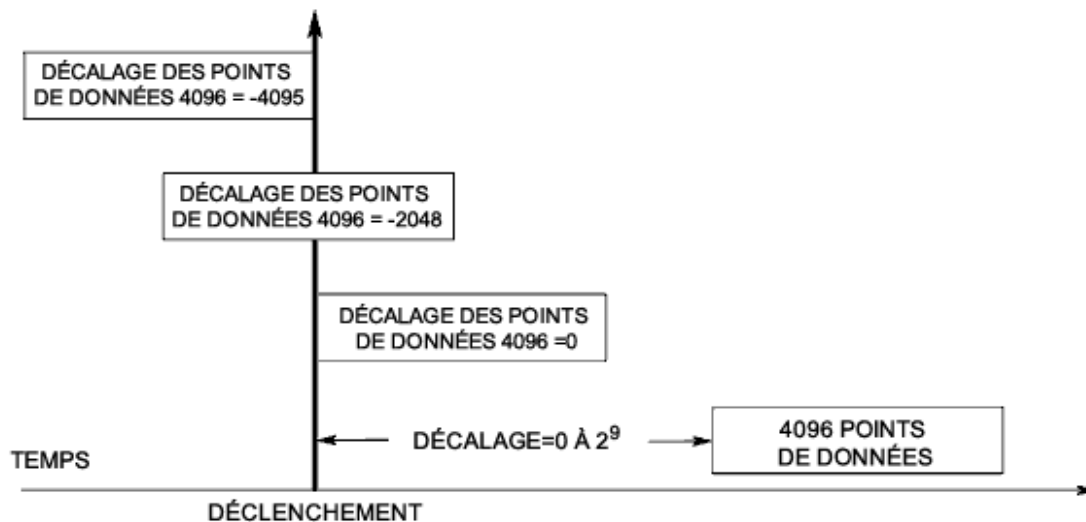

Pour décaler le début du tampon d'acquisition par rapport au déclenchement de l'acquisition :

Aide-mémoire des menus du panneau avant	Commande SCPI
Sélectionnez <b>Measure\Sweep</b> .	Pour décaler la mesure de 100 points :
Entrez une valeur de décalage. Appuyez ensuite sur <b>Select</b> .	<b>SENS:SWE:OFFS:POIN 100</b>

Si la valeur est égale à 0, tous les échantillons de mesure sont prélevés après le déclenchement. Les valeurs positives représentent le délai au-delà duquel le déclenchement se produit avant l'acquisition des échantillons. Cette option permet d'exclure les échantillons de mesure qui sont prélevés pendant le délai de temporisation. (Délai = décalage x période d'échantillonnage). Les valeurs négatives



## 4 Utilisation du système d'alimentations régénératrices

représentent les échantillons de données prélevés avant le déclenchement. Cela vous permet d'acquérir des échantillons de mesure avant le déclenchement.

### Sélectionner la source de déclenchement

**REMARQUE** L'exécution de la commande TRIGger:ACQuire[:IMMEDIATE] sur le bus génère toujours un déclenchement de mesure immédiat, quelle que soit la source de déclenchement sélectionnée.

Si vous n'utilisez pas la commande TRIGger:ACQuire[:IMMEDIATE], sélectionnez une source de déclenchement à partir des options suivantes :

Source de déclenchement	Description
Bus	Sélectionne un déclenchement de périphérique GPIB, *TRG ou <GET> (Group Execute Trigger).
Current	Sélectionne un niveau de courant de sortie.
External	Sélectionne TOUTE broche configurée comme entrée de déclenchement sur le port de commande numérique.
Pin<1-7>	Sélectionne une broche <n> spécifique qui est configurée comme entrée de déclenchement sur le port de commande numérique.
Transient	Sélectionne le système de transitoire de l'appareil. Vous devez également configurer le système de transitoire pour générer un signal de sortie de déclenchement. Voir <b>Programmation des transitoires de sortie</b> .
Voltage	Sélectionne un niveau de tension de sortie.

Les commandes suivantes permettent de sélectionner une source de déclenchement :

Aide-mémoire des menus du panneau avant	Commande SCPI
Non disponible	Pour sélectionner des déclenchements par bus : <b>TRIG:TRAN:SOUR BUS</b>  Pour sélectionner la broche numérique 5 comme déclencheur : <b>TRIG:ACQ:SOUR PIN5</b>  Pour sélectionner un niveau de tension ou de courant : <b>TRIG:ACQ:SOUR VOLT</b> <b>TRIG:ACQ:SOUR CURR</b>  Pour sélectionner un transitoire de sortie comme déclencheur : <b>TRIG:ACQ:SOUR TRAN</b>

### Démarrer le système d'acquisition

Si l'appareil est sous tension, le système de déclenchement est à l'état inactif. Dans cet état, le système de déclenchement est désactivé, ignorant ainsi tous les déclenchements. Les commandes INITiate permettent au système de déclenchement de recevoir des signaux de déclenchement.

Aide-mémoire des menus du panneau avant	Commande SCPI
Non disponible	Pour démarrer le système de déclenchement de mesure : <b>INIT:ACQ</b>

Il ne faut que quelques millisecondes à l'instrument pour être prêt à recevoir un signal de déclenchement une fois la commande INITiate:ACQuire reçue. Si un déclenchement se produit avant que le système de déclenchement soit prêt, le déclenchement est ignoré. Vous pouvez tester le bit WTG\_mes du registre d'état de fonctionnement pour savoir quand l'instrument est prêt à recevoir un signal de déclenchement après avoir été initialisé.

Aide-mémoire des menus du panneau avant	Commande SCPI
Sélectionnez <b>Measure\Control</b> . Le champ Trig state indique "Initiated".	Pour connaître le bit TRAN_meas (bit 3) : <b>STAT:OPER:COND?</b>

Si la valeur de bit 3 est renvoyée dans la réponse à la requête, le bit WTG\_mes est vrai et l'instrument est prêt à recevoir le signal de déclenchement. Pour de plus amples informations, reportez-vous à la section **Didacticiel d'état**.

**REMARQUE**

L'instrument effectue une acquisition de mesure chaque fois qu'une commande de déclenchement de bus, de broche, de transitoire ou de niveau est reçue. Ainsi, il est nécessaire de démarrer le système de déclenchement chaque fois qu'une mesure déclenchée est souhaitée.

## Déclencher la mesure

Le système de déclenchement attend un signal de déclenchement à l'état initialisé. Vous pouvez déclencher immédiatement la mesure comme suit :

Aide-mémoire des menus du panneau avant	Commande SCPI
Non disponible	Pour générer un signal de déclenchement de mesure : <b>TRIG:ACQ</b>  Autrement, si la source de déclenchement est BUS, vous pouvez également programmer une commande <b>*TRG</b> ou une commande IEEE-488 <get>.

Comme précédemment indiqué, un signal de déclenchement peut également être généré par une broche numérique, un transitoire de sortie et un niveau de tension ou de courant de sortie. Si une broche numérique est configurée comme source de déclenchement, l'instrument attend indéfiniment le signal de déclenchement. En l'absence de déclenchement, vous devez renvoyer manuellement le système de déclenchement à l'état inactif. Les commandes suivantes renvoient le système de déclenchement à l'état inactif :

Aide-mémoire des menus du panneau avant	Commande SCPI
Sélectionnez <b>Measure\Control</b> . Sélectionnez ensuite la commande Abort.	<b>ABOR:ACQ</b>

## Récupérer la mesure

Une fois un signal de déclenchement reçu et la mesure terminée, le système de déclenchement retourne à l'état inactif. Une fois la mesure terminée, les requêtes FETCh peuvent récupérer les données de mesure les plus récentes sans démarrer de nouvelle mesure ni altérer les données présentes dans le tampon de mesure.

Aide-mémoire des menus du panneau avant	Commande SCPI
Non disponible	<p>Pour renvoyer la tension et le courant efficaces :</p> <p><b>FETC:VOLT:ACDC?</b> <b>FETC:CURR:ACDC?</b></p> <p>Pour renvoyer le niveau élevé d'une impulsion :</p> <p><b>FETC:VOLT:HIGH?</b> <b>FETC:CURR:HIGH?</b></p> <p>Pour renvoyer le niveau faible d'une impulsion :</p> <p><b>FETC:VOLT:LOW?</b> <b>FETC:CURR:LOW?</b></p>
	<p>Pour renvoyer la valeur maximale :</p> <p><b>FETC:VOLT:MAX?</b> <b>FETC:CURR:MAX?</b> <b>FETC:POW:MAX?</b></p> <p>Pour renvoyer la valeur minimale :</p> <p><b>FETC:VOLT:MIN?</b> <b>FETC:CURR:MIN?</b> <b>FETC:POW:MIN?</b></p> <p>Pour renvoyer les données en tableau :</p> <p><b>FETC:ARR:VOLT?</b> <b>FETC:ARR:CURR?</b> <b>FETC:ARR:POW?</b></p>

Si une requête FETCh est envoyée avant que la mesure ne soit terminée, la réponse est reportée jusqu'à ce que le déclenchement de mesure se produise et que l'acquisition soit terminée. Pour éviter que cela ne se produise, vous pouvez interroger le bit MEAS\_active après le lancement de la mesure pour déterminer quand la mesure est terminée et ensuite envoyer la requête FETCh.

Vous pouvez tester le bit MEAS\_active dans le registre d'état de fonctionnement pour savoir à quel moment le système de déclenchement est revenu à l'état inactif.

Aide-mémoire des menus du panneau avant	Commande SCPI
<p>Sélectionnez <b>Measure\Control</b>.</p> <p>Le champ Trig state indique "Idle".</p>	<p>Pour connaître le bit MEAS_active (bit 5) :</p> <p><b>STAT:OPER:COND?</b></p>

Si le bit 5 est défini dans la réponse à la requête, le bit MES\_active est vrai et la mesure n'est PAS terminée. Si le bit MEAS\_active est false (faux), vous pouvez extraire la mesure. Pour de plus amples informations, reportez-vous à la section **Didacticiel d'état**.

## Événements de déclenchement multiples par mesure

Le système de mesure peut capturer des déclenchements qui se produisent pendant l'acquisition, renvoyer le nombre et la position de ces déclenchements, et calculer les valeurs CC selon un sous-ensemble de données autour de ces déclenchements. Le concept de base est qu'une acquisition unique de longue durée peut contenir plusieurs événements d'intérêt et que ces événements sont marqués par les emplacements où les déclenchements supplémentaires se sont produits. Les emplacements de ces événements sont décrits dans un index situé dans la banque de données de l'acquisition. Les indices sont compris entre 0 et 1 moins le nombre de lectures acquises (voir **SENse:SWEp:POINts**).

Vous pouvez rechercher et renvoyer les indices dans lesquels des déclenchements supplémentaires se sont produits pendant la mesure. Le nombre d'indices renvoyés correspond au nombre de déclenchements survenus.

Aide-mémoire des menus du panneau avant	Commande SCPI
Non disponible	<p>Pour savoir combien (le cas échéant) de déclenchements supplémentaires se sont produits :</p> <p><b>TRIG:ACQ:IND:COUN?</b></p> <p>Pour renvoyer les indices dans lesquels les déclenchements se sont produits :</p> <p><b>TRIG:ACQ:IND?</b></p>

Vous pouvez également renvoyer les données de mesure réelles qui ont été capturées après l'un des indices de déclenchement ci-dessus mentionnés.

Aide-mémoire des menus du panneau avant	Commande SCPI
Non disponible	<p>Pour renvoyer la tension ou le courant CC calculé après les indices de déclenchement :</p> <p><b>FETC:VOLT? [&lt;start_index&gt;, &lt;points&gt;]</b></p> <p><b>FETC:CURR? [&lt;start_index&gt;, &lt;points&gt;]</b></p> <p>Pour renvoyer les données de tension ou de courant instantanées après les indices de déclenchement :</p> <p><b>FETC:ARR:VOLT? [&lt;start_index&gt;, &lt;points&gt;]</b></p> <p><b>FETC:ARR:CURR? [&lt;start_index&gt;, &lt;points&gt;]</b></p>

## Enregistrement de données externe

**Sélectionnez la fonction de mesure.**

**Spécifier la période d'intégration**

**Sélectionner la source de déclenchement des données externes (Elog)**

**Démarrer et déclencher l'enregistrement de données externe**

**Récupérer régulièrement les données**

**Interrompre l'enregistrement de données externe (Elog)**

### Introduction

**REMARQUE**

La fonction d'enregistrement de données externe peut être uniquement programmée à l'aide de commandes SCPI.

Les modèles Keysight RPS incluent une fonction d'enregistrement de données « externe » (Elog) qui vous permet d'enregistrer continuellement les mesures de tension et de courant. L'enregistrement des données est externe à l'instrument car il doit être effectué à l'aide d'un ordinateur pour récupérer les mesures récentes de l'appareil et les mettre dans un fichier journal sur le l'ordinateur. Les données de mesure de la tension et du courant sont temporairement enregistrées dans une mémoire tampon FIFO (premier entré/premier sorti) dans l'instrument. Comme cette mémoire tampon est seulement assez grande pour contenir environ 20 secondes de données, vous devez périodiquement la vider vers un fichier journal externe, sinon les données du tampon seront écrasées.

Le tableau suivant décrit en détail les diverses fonctions d'enregistrement de données.

Fonction	Description
<b>Data Storage (Stockage des données)</b>	Met en mémoire tampon des mesures pendant environ 20 secondes et demande à l'ordinateur de lire régulièrement les mesures pour éviter tout dépassement de la mémoire tampon interne. L'ordinateur doit assurer le stockage de données externe.
<b>Measurement Functions (Fonctions de mesure)</b>	Le courant et la tension de sortie peuvent être enregistrés.
<b>Integration Period (Période d'intégration)</b>	Pendant la période d'intégration spécifiée, la moyenne des échantillons est calculée, et les valeurs minimale et maximale sont suivies.
<b>Data viewing (Affichage des données)</b>	Aucun affichage ou commande de panneau avant. Les données sont collectées et affichées en externe.

Notez que la fonction Elog utilise le **processus de déclenchement d'acquisition** pour effectuer les mesures.

### Sélectionnez la fonction de mesure.

Les commandes suivantes permettent de sélectionner une fonction de mesure :

Aide-mémoire des menus du panneau avant	Commande SCPI
Non disponible	Pour activer les mesures de la tension ou du courant : <b>SENS:ELOG:FUNC:VOLT ON</b> <b>SENS:ELOG:FUNC:CURR ON</b>  Pour activer les mesures des valeurs min./max. : <b>SENS:ELOG:FUNC:VOLT:MINM ON</b> <b>SENS:ELOG:FUNC:CURR:MINM ON</b>

## Spécifier la période d'intégration

La période d'intégration peut être comprise entre une valeur minimale de 102,4 microsecondes et une valeur maximale de 60 secondes.

Aide-mémoire des menus du panneau avant	Commande SCPI
Non disponible	Pour définir une période d'intégration de 600 microsecondes : <b>SENS:ELOG:PER 0.0006</b>

Pendant la période d'intégration, la moyenne des échantillons Elog est calculée, et les valeurs minimale et maximale sont suivies. À la fin de chaque période d'intégration, les valeurs moyenne, minimale et maximale sont ajoutées à la mémoire tampon FIFO interne.

Bien que la période d'intégration minimale absolue soit de 102,4 microsecondes, la valeur minimale réelle varie selon le nombre de mesures enregistrées. La formule se présente comme suit : 102,4\_ microsecondes X nombre\_de\_mesures. Par exemple :

**102,4 microsecondes** : 1 mesure (tension ou courant)

**204,8 microsecondes** : 2 mesures (tension et courant)

**409,6 microsecondes** : 4 mesures (tension + valeur min. + valeur max. + courant)

Si la période d'intégration spécifiée coïncide avec les intervalles d'enregistrement minimum ou est proche de ces derniers, le format de données binaire doit être spécifié. Si le format REAL n'est pas spécifié, les données adoptent le format ASCII et les intervalles d'enregistrement minimum sont généralement jusqu'à cinq fois plus longs que ceux obtenus avec le format binaire.

Aide-mémoire des menus du panneau avant	Commande SCPI
Non disponible	Pour définir le format de données sur REAL : <b>FORM[:DATA] REAL</b>

## Sélectionner la source de déclenchement des données externes (Elog)

La commande TRIGger:ELOG génère un déclenchement immédiat, quelle que soit la source de déclenchement. À moins d'utiliser cette commande, sélectionnez une source de déclenchement à partir des options suivantes :

## 4 Utilisation du système d'alimentations régénératrices

Source de déclenchement	Description
Bus	Sélectionne un déclenchement de périphérique GPIB, *TRG ou <GET> (Group Execute Trigger).
External	Sélectionne TOUTE broche configurée comme entrée de déclenchement sur le port de commande numérique.
Immediate	Déclenche la mesure dès que la commande INITiated est exécutée.
Pin<1-7>	Sélectionne une broche <n> spécifique qui est configurée comme entrée de déclenchement sur le port de commande numérique.

Les commandes suivantes permettent de sélectionner l'une des sources de déclenchement disponibles :

Aide-mémoire des menus du panneau avant	Commande SCPI
Non disponible	<p>Pour sélectionner des déclenchements par bus : <b>TRIG:ELOG:SOUR BUS</b></p> <p>Pour sélectionner un déclencheur immédiat : <b>TRIG:ELOG:SOUR IMM</b></p> <p>Pour sélectionner la broche numérique 5 comme déclencheur : <b>TRIG:ELOG:SOUR PIN5</b></p> <p>Pour sélectionner toute broche configurée comme entrée de déclenchement : <b>TRIG:ELOG:SOUR EXT</b></p>

### Démarrer et déclencher l'enregistrement de données externe

Si l'alimentation est sous tension, le système de déclenchement est à l'état inactif. Dans cet état, le système de déclenchement est désactivé, ignorant ainsi tous les déclenchements. La commande INITiate permet au système de mesure de recevoir les signaux de déclenchements. Pour démarrer et déclencher l'enregistrement de données externe :

Aide-mémoire des menus du panneau avant	Commande SCPI
Non disponible	<p>Pour démarrer l'enregistrement de données externe : <b>INIT:ELOG</b></p> <p>Pour déclencher l'enregistrement de données externe : <b>TRIG:ELOG</b></p> <p>Autrement, si la source de déclenchement est BUS, vous pouvez également programmer une commande <b>*TRG</b> ou une commande IEEE-488 &lt;get&gt;.</p>

Une fois déclenchée, la fonction d'enregistrement de données externe commence à placer les données dans la mémoire tampon de mesure interne. La mémoire tampon étant suffisamment volumineuse pour contenir 20 secondes de mesures cumulées, votre application logicielle doit régulièrement récupérer (ou rechercher) les données de cette mémoire.

## Récupérer régulièrement les données

Chaque commande FETCh renvoie le nombre d'enregistrements demandés des données contenues dans la mémoire tampon et les supprime, libérant ainsi de la place pour des données supplémentaires. L'exécution de la fonction Elog se poursuit jusqu'à son interruption par l'utilisateur.

Un enregistrement Elog comprend un jeu de lectures de tension et de courant pour un seul intervalle de temps. Le format exact d'un enregistrement dépend des fonctions qui ont été activées pour la mesure Elog. Si toutes les fonctions sont activées, alors un enregistrement contiendra les données suivantes dans l'ordre spécifié :

Courant moyen  
 Courant minimal  
 Courant maximal  
 Tension moyenne  
 Tension minimale  
 Tension maximale

Aide-mémoire des menus du panneau avant	Commande SCPI
Non disponible	Pour récupérer jusqu'à 1 000 enregistrements : <b>FETC:ELOG? 1000</b>

Les données ASCII (format par défaut) sont renvoyées sous forme d'ensembles de données numériques ASCII séparées par des virgules des valeurs moyennes/min/max et terminées par une nouvelle ligne. Les données REAL sont renvoyées sous forme de bloc de longueur définie, l'ordre des octets étant spécifié par la commande FORMat:BOARDer.

## Interrompre l'enregistrement de données externe (Elog)

Aide-mémoire des menus du panneau avant	Commande SCPI
Non disponible	Pour interrompre l'enregistrement de données externe : <b>ABOR:ELOG</b>



## Programmation du port numérique

### Entrées/sorties numériques bidirectionnelles

### Entrée numérique seulement

### E/S de déclenchement externe

### Sortie de défaillance

### Entrée d'inhibition

### Protection du système de défaillance/inhibition

### Output Couple

## Port de commande numérique

Un port de commande numérique comportant sept broches d'E/S est fourni pour permettre l'accès à plusieurs fonctions de contrôle. Chaque broche peut être configurée par l'utilisateur. Les fonctions de commande suivantes sont disponibles pour les broches d'E/S. Pour de plus amples informations sur les commandes SCPI permettant de programmer le port numérique, reportez-vous à la section [Référence de programmation SCPI](#).

Le tableau suivant décrit les configurations possibles des broches pour les fonctions du port numérique. Pour une description complète des caractéristiques électriques du port de commande numérique, reportez-vous à la section [Spécifications](#).

Fonction	Description
DIO	Fonction d'entrée/sortie numérique polyvalente référencée à la masse. La sortie peut être réglée avec <a href="#">[SOURCE:]DIGital:OUTPut:DATA</a> .
DINPut	Mode d'entrée numérique uniquement. Les données de sortie numériques de la broche sont ignorées.
FAULt	S'applique uniquement à la broche 1. La broche 1 fonctionne comme une sortie d'erreur isolée. Le signal de défaillance est vrai si une sortie est à l'état protégé. La broche 2 sert de commun isolé pour la broche 1. Lorsque la broche 1 est réglée sur la fonction FAULt, l'instrument ignore toutes les commandes de programmation de la broche 2. Les requêtes de la broche 2 renverront FAULt. Si la broche 1 passe de FAULt à une autre fonction, la broche 2 est réglée sur DINPut.
INHibit	S'applique uniquement à la broche 3. Si la broche 3 est configurée comme une entrée d'inhibition, un signal vrai au niveau de la broche désactive la sortie.
ONCOuple	S'applique uniquement aux broches 4-7. La broche ONCOuple synchronise l'état d'activation de la sortie entre les instruments. Vous ne pouvez configurer qu'une seule broche comme ONCOuple. La broche fonctionne comme une entrée et une sortie.
OFFCOuple	S'applique uniquement aux broches 4-7. La broche OFFCOuple synchronise l'état de désactivation de la sortie entre les instruments. Vous ne pouvez configurer qu'une seule broche comme OFFCOuple. La broche fonctionne comme une entrée et une sortie.

<b>TINPut</b>	Une broche d'entrée de déclenchement peut être sélectionnée comme source des signaux de déclenchement de mesure et de transitoire. Voir <b>TRIGger:ACQuire:SOURce</b> et <b>TRIGger:TRANSient:SOURce</b>
<b>TOUTput</b>	Une broche de sortie de déclenchement génère des déclenchements de sortie à partir de tout sous-système ayant été configuré pour générer des signaux de déclenchement.
<b>Common</b>	S'applique uniquement à la broche 8. Connecté à la masse.

Outre les fonctions de broche configurables, la polarité du signal (positive ou négative) de chaque broche peut également être configurée. Pour les signaux de niveau, POSitive indique une tension élevée au niveau de la broche. NEGative indique une tension faible sur la broche. Pour les signaux de front, POSitive signifie un front montant et NEGative un front descendant.

### Entrées/sorties numériques bidirectionnelles

Chacune des sept broches peut être configurée comme une entrée et sortie numériques bidirectionnelles universelles. La polarité des broches peut également être configurée. La broche 8 est le commun du signal pour les broches d'E/S numériques. Les données sont programmées conformément aux affectations de bits suivantes :

Broche	7	6	5	4	3	2	1
Poids du bit	6 (MSB)	5	4	3	2	1	0 (LSB)

Les broches d'E/S numériques permettent de contrôler les circuits de relais ainsi que les circuits d'interface numériques. La figure suivante illustre les circuits de relais types ainsi que les connexions de circuit d'interface numérique à l'aide des fonctions d'E/S numériques.

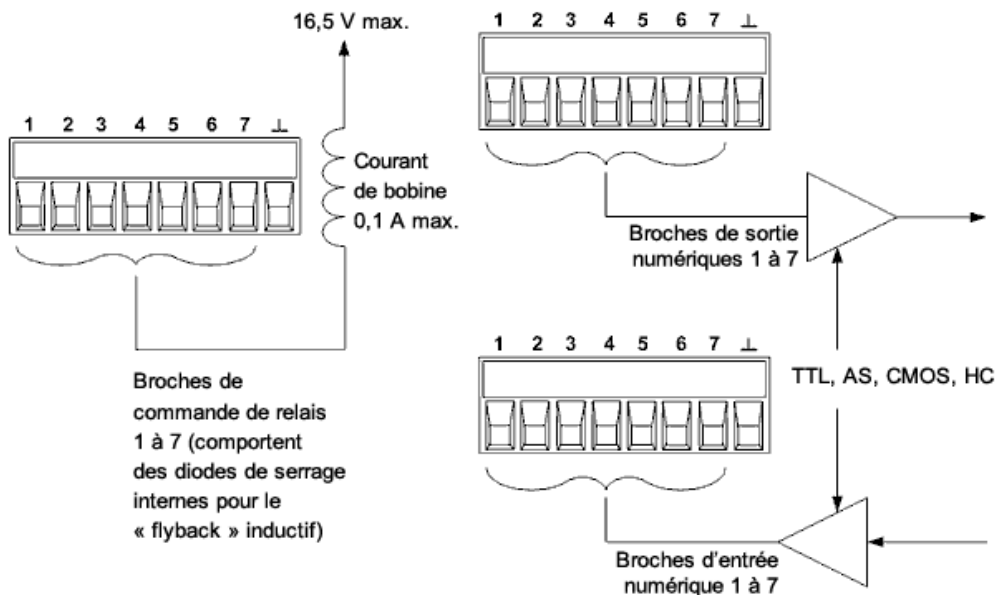

Pour configurer les broches d'E/S numériques :

Aide-mémoire des menus du panneau avant	Commande SCPI
-----------------------------------------	---------------

Sélectionnez <b>System\IO\DigPort\Pins</b> .	Pour sélectionner la fonction de la broche :
Sélectionnez une broche dans le champ Pin (Broche).	<b>DIG:PIN&lt;1-7&gt;:FUNC DIO</b>
Dans le champ Function (Fonction), sélectionnez Dig IO (E/S num.)	Pour sélectionner la polarité de la broche :
Dans le champ Polarity (Polarité), sélectionnez Positive (Positif) ou Negative (Négatif).	<b>DIG:PIN&lt;1-7&gt;:POL POS</b>
Pour envoyer les données aux broches, sélectionnez <b>System\IO\DigPort\Data</b> .	Pour configurer les broches 1 à 7 avec « 0000111 » :
Sélectionnez le champ Data Out (Sortie des données) et saisissez le mot binaire.	<b>DIG:OUTP:DATA 7</b>

### Entrée numérique

Chacune des sept broches peut être configurée uniquement comme entrée numérique. La polarité des broches peut également être configurée. La broche 8 est le commun du signal pour les broches d'entrée numériques. L'état de la broche reflète la condition du signal externe appliqué sur cette broche. Il n'est pas affecté par la valeur de la commande DIGital:OUTPut:DATA. Pour configurer les broches de l'entrée numérique uniquement :

Aide-mémoire des menus du panneau avant	Commande SCPI
Sélectionnez <b>System\IO\DigPort\Pins</b> .	Pour sélectionner la fonction de la broche :
Sélectionnez une broche dans le champ Pin (Broche).	<b>DIG:PIN&lt;1-7&gt;:FUNC DINP</b>
Dans le champ Function (Fonction), sélectionnez <b>Dig In (Entrée num)</b> .	Pour sélectionner la polarité de la broche :
Dans le champ Polarity (Polarité), sélectionnez Positive (Positif) ou Negative (Négatif).	<b>DIG:PIN&lt;1-7&gt;:POL POS</b>
Pour lire les données à partir des broches, sélectionnez <b>System\IO\DigPort\Data</b> .	Pour lire les données sur les broches :
Les données d'entrée sont affichées au format binaire dans le champ Data In (Entrée de données).	<b>DIG:INP:DATA?</b>

### E/S de déclenchement externe

Chacune des sept broches peut être configurée comme une entrée ou sortie de déclenchement. La polarité des broches peut également être configurée. Lorsque vous programmez une polarité de déclenchement, POSitive signifie un front montant et NEGative signifie un front descendant. La broche 8 est le commun du signal pour les broches de déclenchement. Pour une vue d'ensemble du système de déclenchement, reportez-vous à la section **Présentation des déclenchements**.

Lorsque la broche de déclenchement désignée est configurée comme une entrée de déclenchement, vous pouvez lui appliquer une impulsion à front négatif ou à front positif. Le temps de latence du déclenchement est de 5 microsecondes. La largeur d'impulsion minimale est de 4 microsecondes pour les signaux à front positif et de 10 microsecondes pour les signaux à front négatif. Le réglage de la polarité de la broche détermine le front qui produira un événement de déclenchement.

Configurée comme une sortie de déclenchement, la broche désignée délivre une impulsion de 10 microsecondes lorsqu'une sortie de déclenchement se produit. Selon le réglage de la polarité, ce peut être une impulsion à front positif (montant) ou négatif (descendant) par rapport au commun.

Aide-mémoire des menus du panneau avant	Commande SCPI
Sélectionnez <b>System\IO\DigPort\Pins</b> .	Pour sélectionner la fonction de sortie de déclenchement de la broche 1 :
Sélectionnez une broche dans le champ Pin (Broche).	<b>DIG:PIN1:FUNC TOUT</b>
Dans le champ Function (Fonction) sélectionnez la fonction Trig In (Entrée de déclenchement) ou Trig Out (Sortie de déclenchement).	Pour sélectionner la fonction d'entrée de déclenchement de la broche 2 :
Dans le champ Polarity (Polarité), sélectionnez Positive (Positif) ou Negative (Négatif).	<b>DIG:PIN2:FUNC TINP</b>
	Pour sélectionner la polarité de la broche :
	<b>DIG:PIN1:POL POS</b>
	<b>DIG:PIN2:POL POS</b>

## Sortie de défaillance

Les broches 1 et 2 peuvent être configurées comme une paire de sortie de défaillance. La fonction de sortie de défaillance permet à une condition de défaillance de générer un signal de défaillance de protection sur le port numérique. Pour une liste des signaux de protection, reportez-vous à la section **Programmation de la protection des sorties**.

Les broches 1 et 2 sont dédiées à cette fonction. La broche 1 est la sortie de défaillance ; la broche 2 est le commun de la broche 1. Cela fournit une sortie optiquement isolée. La polarité de la broche 1 peut également être configurée. Si la polarité de la broche est POSitive, une condition de défaillance déclenche la sortie isolée. Notez que le signal de sortie de défaillance demeure verrouillé tant que l'anomalie n'a pas été résolue et que le circuit de protection n'a pas été désactivé, comme expliqué dans la section **Désactivation des fonctions de protection de sortie**.

**REMARQUE** La fonction sélectionnée pour la broche 2 est ignorée. La broche 2 doit être reliée à la masse du circuit externe.

Aide-mémoire des menus du panneau avant	Commande SCPI
Sélectionnez <b>System\IO\DigPort\Pins</b> .	Pour configurer la fonction Fault (Défaillance) :
Sélectionnez pin 1 (broche 1), Function (Fonction), puis Fault Out (Sortie de défaillance).	<b>DIG:PIN1:FUNC FAUL</b>
Dans le champ Polarity (Polarité), sélectionnez Positive (Positif) ou Negative (Négatif).	Pour sélectionner la polarité de la broche :
	<b>DIG:PIN1:POL POS</b>

## Entrée d'inhibition

La broche 3 peut être configurée comme entrée d'inhibition à distance. La fonction d'entrée d'inhibition permet à un signal d'entrée externe de contrôler l'état de sortie de l'instrument. Cette entrée est déclenchée par niveau. Le temps de latence du signal est de 5 microsecondes. La broche 8 est le

## 4 Utilisation du système d'alimentations régénératrices

commun de la broche 3. Les modes d'entrée d'inhibition non volatiles suivants peuvent être programmés :

**LATChing** - une transition vers l'état logique vrai sur l'entrée d'inhibition désactivera la sortie. La sortie demeure désactivée une fois le signal d'inhibition reçu.

**LIVE** : permet à la sortie activée de suivre l'état de l'entrée d'inhibition. Lorsque l'entrée d'inhibition est à l'état vrai, la sortie est désactivée. Lorsque l'entrée d'inhibition est à l'état faux, la sortie est réactivée.

**OFF** : l'entrée d'inhibition est ignorée.

Pour configurer la fonction d'entrée d'inhibition :

Aide-mémoire des menus du panneau avant	Commande SCPI
Sélectionnez <b>System\IO\DigPort\Pins</b> .	Pour sélectionner la fonction Inhibit (Inhibition) :
Sélectionnez pin 3 (broche 3), Fonction (Fonction), puis Inhibit In (Entrée d'inhibition).	<b>DIG:PIN3:FUNC INH</b>
Dans le champ Polarity (Polarité), sélectionnez Positive (Positif) ou Negative (Négatif).	Pour sélectionner la polarité de la broche :
Sélectionnez <b>Protect\Inhibit</b> .	<b>DIG:PIN3:POL POS</b>
Sélectionnez Latching (Verrouillage) ou Live (Actif).	Indiquer le mode Inhibit (Inhibition) :
Pour désactiver le signal d'inhibition, sélectionnez Off (Désactivé).	<b>OUTP:INH:MODE LATC</b> <b>OUTP:INH:MODE LIVE</b> <b>OUTP:INH:MODE OFF</b>

### Protection du système de défaillance/inhibition

Comme le montre la figure suivante, lorsque les sorties de défaillance et les entrées d'inhibition de plusieurs instruments sont connectées en série, une condition de défaillance interne sur un appareil désactive toutes les sorties sans intervention du contrôleur ou des circuits externes. Sachez que pour utiliser les signaux Fault/Inhibit de cette façon, vous devez régler les deux signaux sur la même polarité.

Aussi, comme l'illustre la figure, vous pouvez également connecter l'entrée d'inhibition à un commutateur manuel ou à un signal de contrôle externe : celui-ci court-circuite la broche Inhibit (Inhibition) en commun chaque fois que cela est nécessaire afin de désactiver toutes les sorties. Dans ce cas, vous devez programmer la polarité **Negative (Négative)** pour toutes les broches. Vous pouvez également utiliser la sortie de défaillance pour diriger un circuit ou un signal de relais externe vers d'autres appareils chaque fois qu'une protection se déclenche.

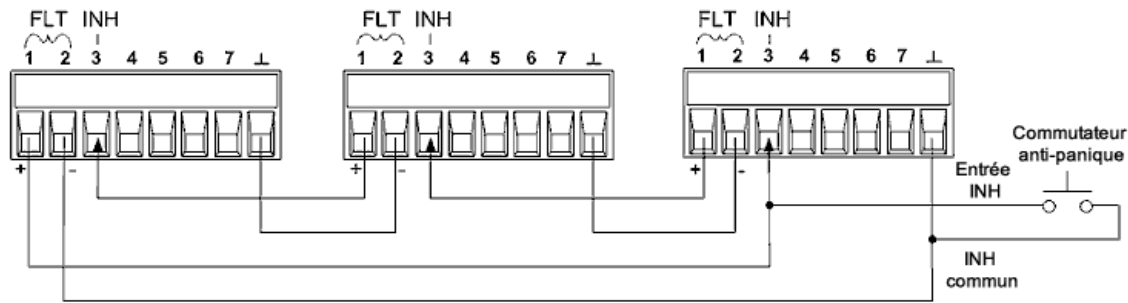

### Correction d'une défaillance de protection du système

Pour restaurer le fonctionnement normal de tous les instruments lorsqu'une condition de défaillance se produit dans une configuration de protection de systèmes connectés en série, vous devez supprimer les deux conditions de défaillance suivantes :

1. La défaillance de protection initiale ou le signal d'inhibition externe initial.
2. Le signal de défaillance en chaîne qui suit, délivré par le signal d'inhibition.

**REMARQUE** Même lorsque la condition de défaillance initiale ou le signal externe initial sont supprimés, le signal de défaillance demeure actif et continue de désactiver toutes les sorties de l'ensemble des appareils.

Pour corriger le signal de défaillance en série lorsque le mode de fonctionnement de l'entrée d'inhibition est activé, annulez la protection de sortie de n'importe quel appareil tel qu'expliqué dans le chapitre **Désactivation des fonctions de protection**. Si le mode de fonctionnement de l'entrée d'inhibition est verrouillé, désactivez l'entrée d'inhibition sur CHACUN des appareils. Pour réactiver la connexion en série, reprogrammez l'entrée d'inhibition sur chaque appareil sur le mode verrouillé.

### Commande de couplage des sorties

Cette fonction permet de connecter ensemble plusieurs instruments et de synchroniser la séquence d'activation ou de désactivation des sorties sur tous les appareils. Chaque appareil à séquencer doit également être « couplé » aux autres appareils.

1. Couplez la sortie sur chaque appareil, comme décrit dans la section **Séquencement de la sortie**.
2. Réglez le décalage de délai de chaque appareil afin qu'il corresponde à la valeur de décalage de délai la plus grande du groupe.
3. Connectez et configurez les broches du connecteur numérique des appareils séquencés comme indiqué ci-dessous.

Seules les broches 4 à 7 peuvent être configurées comme des broches « couplées ». Les broches désignées fonctionnent à la fois comme entrée et comme sortie, avec une transition négative sur une broche afin de fournir le signal de séquence aux autres broches. La polarité des broches n'est pas programmable ; elle est réglée sur NEGative.

## 4 Utilisation du système d'alimentations régénératrices

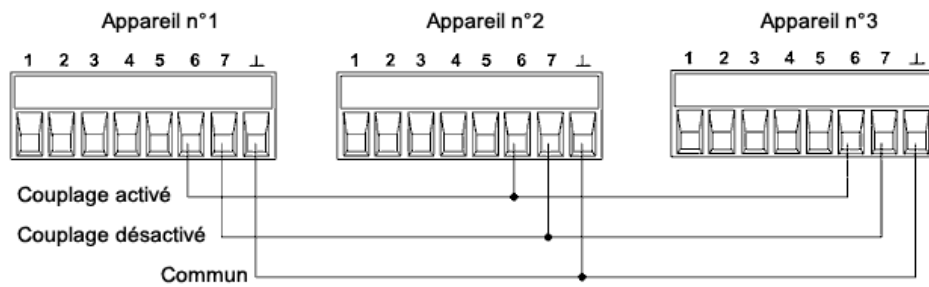

Dans cet exemple, la broche 6 est configurée comme commande d'activation de la sortie. La broche 7 est configurée comme commande de désactivation de la sortie. Les broches de masse ou Common sont reliées ensemble.

Aide-mémoire des menus du panneau avant	Commande SCPI
Sélectionnez <b>System\IO\DigPort\Pins</b> .	Pour régler la broche 6 de l'appareil 1 comme commande d'activation :
Sélectionnez pin 6 (broche 6), Fonction (Fonction), puis On Couple (Couplage activé).	<b>DIG:PIN6:FUNC ONC</b>
Sélectionnez <b>Pins (Broches)</b> , pin7 (broche7), Fonction (Fonction), puis Off Couple (Couplage désactivé).	Pour configurer la broche 7 de l'appareil 1 comme commande de désactivation :
Répétez ces étapes pour les appareils n° 2 et n° 3.	<b>DIG:PIN7:FUNC OFFC</b>
	Répétez ces commandes pour les appareils n° 2 et n° 3.

Une fois la sortie configurée et activée, l'activation ou la désactivation de n'importe quelle sortie couplée provoque l'activation ou la désactivation de toutes les sorties couplées, selon leurs délais programmés par l'utilisateur.

## Opérations système

Même si elles ne sont pas directement liées à la programmation des sorties, les fonctions suivantes contrôlent également le fonctionnement de l'appareil.

### Identification de l'instrument

#### Stockage des configurations de l'instrument

#### Affichage du panneau avant

#### Verrouillage du panneau avant

#### Protection par mot de passe

### Identification de l'instrument

Vous pouvez rechercher le numéro du modèle, le numéro de série, les options et la version du microprogramme. Les commandes SCPI renvoient des informations à l'aide des requêtes **\*IDN?** et **\*OPT?**.

Aide-mémoire des menus du panneau avant	Commande SCPI
Sélectionnez <b>System\About\Frame</b> .	Pour renvoyer le nom du fabricant, le numéro du modèle, le numéro de série et la version du microprogramme : <b>*IDN?</b> Pour renvoyer les options installées : <b>*OPT?</b>

### Stockage des configurations de l'instrument

Le bloc d'alimentation comporte dix registres dans la mémoire non volatile pour y enregistrer des configurations. Les emplacements sont numérotés de 0 à 9. Toute configuration précédemment enregistrée au même emplacement est remplacée.

Aide-mémoire des menus du panneau avant	Commande SCPI
Sélectionnez <b>States\SaveRecall</b> . Dans le champ <b>SaveRecall</b> , saisissez un emplacement compris entre 0 et 9. Appuyez ensuite sur <b>Select</b> . Sélectionnez <b>Save</b> (Enregistrer) pour enregistrer la configuration à l'état <b>Recall</b> (Rappeler) afin de rappeler une configuration.	Pour enregistrer une configuration à l'emplacement 1 : <b>*SAV 1</b> Pour rappeler une configuration à l'emplacement 1 : <b>*RCL 1</b>

### Indication d'une configuration de mise sous tension

Le bloc d'alimentation est configuré en usine pour rappeler automatiquement les paramètres de réinitialisation (**\*RST**) à la mise sous tension. Toutefois, vous pouvez configurer le bloc d'alimentation



## 4 Utilisation du système d'alimentations régénératrices

afin qu'il utilise les paramètres que vous avez enregistrés à l'emplacement mémoire 0 lors de la mise sous tension.

Aide-mémoire des menus du panneau avant	Commande SCPI
Sélectionnez <b>States\PowerOn</b> .	<b>OUTP:PON:STAT RCL0</b>
Sélectionnez Rappeler la configuration 0. Appuyez ensuite sur <b>Select</b> .	

### Affichage du panneau avant

Le panneau avant du bloc d'alimentation est doté d'un écran de veille : celui-ci augmente considérablement la durée de vie de l'écran LCD en atténuant sa luminosité pendant les périodes d'inactivité. Le délai peut être réglé entre 30 et 999 minutes par incréments de 1 minute. L'écran de veille est réglé en usine pour se déclencher après une heure d'inactivité sur le panneau avant ou de l'interface.

Lorsque l'écran de veille est actif, l'écran du panneau avant s'éteint et le voyant situé en regard de l'interrupteur passe du vert à l'orange. Pour restaurer l'écran du panneau avant, appuyez sur une touche du panneau avant. La sélection de la touche a pour effet d'allumer l'écran. Ensuite, la touche retourne à son mode de fonctionnement normal.

Si la fonction Wake on I/O (Réveil par l'E/S) est sélectionnée, l'écran est restauré en cas d'activité sur l'interface de commande à distance. Cela réinitialise également le temporisateur de l'écran de veille. Par défaut, la fonction de réveil par l'E/S est activée.

Aide-mémoire des menus du panneau avant	Commande SCPI
Sélectionnez <b>System\Preferences\Display\Saver</b> .	Pour activer ou désactiver l'écran de veille du panneau avant :
Activez ou désactivez l'écran de veille en cochant ou en désélectionnant la case Screen Saver (Écran de veille). Appuyez ensuite sur <b>Select</b> .	<b>DISP:SAV ON OFF</b>
Saisissez une valeur en minutes dans le champ Saver Delay (Délai d'activation) de l'écran de veille pour spécifier le temps d'inactivité au bout duquel l'écran de veille doit s'activer.	
Cochez la case Wake on I/O (Réveil par l'E/S) pour activer l'écran avec le réveil par l'E/S.	

### Indication de l'affichage à la mise sous tension

Vous pouvez spécifier les fonctions de mesure affichées à la mise en marche comme suit. Cependant, les commandes de l'IPAC ne modifient que la vue actuelle, et non la vue à la mise sous tension.

Aide-mémoire des menus du panneau avant	Commande SCPI
Sélectionnez <b>System\Preferences\Display\View</b> .	Pour changer la vue du compteur actuel :
Dans le menu déroulant, sélectionnez : Voltage,Current; Voltage,Power; ou Volt,Curr,Power. Appuyez ensuite sur <b>Select</b> .	<b>DISP:VIEW METER_VI</b> <b>DISP:VIEW METER_VP</b> <b>DISP:VIEW METER_VIP</b>

## Verrouillage du panneau avant

Vous pouvez verrouiller les touches du panneau avant afin d'empêcher tout contrôle indésirable de l'instrument par le biais du panneau avant. Cette méthode de verrouillage des touches du panneau avant est la plus sûre, car vous avez besoin d'un mot de passe pour déverrouiller le panneau avant. Ces paramètres sont enregistrés dans la mémoire non volatile. Par conséquent, le panneau avant demeure verrouillé, même après la remise sous tension de l'alimentation secteur.

Aide-mémoire des menus du panneau avant	Commande SCPI
Sélectionnez <b>System\Preferences\Lock</b> .  Dans la boîte de dialogue, saisissez le mot de passe pour déverrouiller le panneau avant. Sélectionnez ensuite l'option Lock (Verrouiller).	Non disponible

Le menu permettant de déverrouiller le panneau avant s'affiche chaque fois qu'une touche est enfoncée. Saisissez le mot de passe pour déverrouiller le panneau avant.

**REMARQUE** En cas de perte du mot de passe, la commande **SYSTem:PASSword:FPANel:RESet** peut réinitialiser le mot de passe de verrouillage du panneau avant.

La commande **SYSTem:COMMunicate:RLState RWLock** permet également de verrouiller et de déverrouiller le panneau avant. Cette commande est entièrement indépendante de la fonction de verrouillage du panneau avant. Si vous utilisez cette commande pour verrouiller le panneau avant, celui-ci est déverrouillé, même après la remise sous tension de l'alimentation secteur.

## Protection par mot de passe

Vous pouvez protéger toutes les fonctions situées dans le menu Admin à l'aide d'un mot de passe. Parmi ces fonctions figurent l'étalonnage de l'instrument, l'accès à l'interface, la réinitialisation de mémoire non volatile, la mise à jour de microprogramme et les mises à jour de mot de passe.

Par défaut, le mot de passe du menu Admin est 0 (zéro). Autrement dit, il n'est pas nécessaire de saisir un mot de passe pour accéder au menu Admin. Sélectionnez simplement **System\Admin>Login** et appuyez sur Enter. Pour protéger le menu Admin par mot de passe :

Aide-mémoire des menus du panneau avant	Commande SCPI
Sélectionnez <b>System\Admin&gt;Password</b>  Saisissez un mot de passe numérique d'une longueur maximale de 15 chiffres. Appuyez ensuite sur Select.  Connectez-vous au menu Admin pour activer le mot de passe. Vous ne pouvez maintenant accéder au menu Admin qu'en saisissant le mot de passe approprié dans le champ Password (Mot de passe).	Accédez au mode d'étalonnage à l'aide du mot de passe initial. <b>CAL:STAT ON, &lt;motdepasse&gt;</b>  Pour modifier le mot de passe : <b>CAL:PASS &lt;motdepasse&gt;</b>  Pour quitter le mode d'étalonnage et activer le mot de passe : <b>CAL:STAT OFF</b>

## 4 Utilisation du système d'alimentations régénératrices

En cas de perte du mot de passe, l'accès reste possible en réglant un commutateur interne permettant de réinitialiser le mot de passe sur 0. Si le message « Locked out by internal switch setting » ou « Calibration is inhibited by switch setting » apparaît, le commutateur interne est défini pour empêcher la modification du mot de passe. Pour de plus amples informations, reportez-vous à la section **Commutateurs d'étalonnage**.

### Clock Setup (Réglage de l'horloge)

L'horloge système permet de fournir des informations d'horodatage pour le logiciel de contrôle et d'analyse d'alimentation BenchVue ; il s'agit de sa seule fonction. Par défaut, l'horloge système est réglée sur l'heure de Greenwich. Pour régler l'horloge :

Aide-mémoire des menus du panneau avant	Commande SCPI
Sélectionnez <b>System\Preferences\Display\Clock</b> .	Pour régler la date :
Entrez la date dans les champs Month, Day et Year (Mois, Jour et Année).	<b>SYSTem:DATE 2018,06,30</b>
Entrez l'heure dans les champs Hour, Minute et Second (Heure, Minute et Seconde).	Pour régler l'heure :
Appuyez sur Select pour régler la date et l'heure.	<b>SYSTem:TIME 20,30,0</b>

## Fonctionnement photovoltaïque (SAS)

### Introduction

### Programmation des paramètres de Courbe

### Programmation des paramètres de Tableau

### Programmation de tableaux multiples

### Programmation des paramètres supplémentaires

### Détails sur les commandes SAS

### Dépannage

### Équations du modèle

**REMARQUE** Le logiciel de test Keysight **DG9000** des onduleurs PV avancés/à entrées multiples vous permet de contrôler la sortie d'un à douze instruments RPS.

---

## Introduction

Les instruments Keysight RPS fonctionnent comme simulateur de groupe de cellules solaires uniquement lorsque la commande SAS:MODE spécifie le mode Curve (Courbe) ou Table (Tableau).

En mode Courbe, une caractéristique de groupe de cellules solaires est créée à partir de quatre paramètres d'entrée et d'une forme de courbe (spatiale ou terrestre) :

**Imp** : le courant au point de puissance maximum

**Isc** : le courant de court-circuit

**Vmp** : la tension au point de puissance maximum

**Voc** : la tension en circuit ouvert

En mode Tableau, une caractéristique de groupe de cellules solaires est créée de trois à 1 024 points de tension et de courant.

Vous pouvez spécifier le fonctionnement de groupe de cellules solaires comme suit :

Aide-mémoire des menus du panneau avant	Commande SCPI
Sélectionnez <b>Output\Mode</b> .	Spécifiez le fonctionnement du SAS :
En mode SAS, sélectionnez Curve (Courbe) ou Table (Tableau).	<b>SAS:MODE CURV</b>
Sélectionnez Fixed pour quitter le mode SAS. Appuyez ensuite sur <b>Select</b> .	<b>SAS:MODE TABL</b>
	<b>SAS:MODE FIX</b> (pour quitter)

## 4 Utilisation du système d'alimentations régénératrices

- La sortie est désactivée lors du passage entre le mode Fixed et le mode Courbe ou Tableau.
- Lors du passage entre les modes Courbe/Tableau, tous les paramètres seront ramenés à leur valeur \*RST.
- En passant du mode Courbe au mode Tableau, les paramètres de groupe de cellules solaires sont conservés.

L'écran du panneau avant indique lorsque l'instrument fonctionne comme un simulateur de groupe de cellules solaires, en mode Courbe ou Tableau. Les paramètres affichés à l'écran sont les vraies valeurs  $V_{mp}$  et  $I_{mp}$ . Ces valeurs sont calculées sur la base des paramètres de la courbe courante ou des points du tableau.



### Programmation des paramètres de Courbe

En mode Courbe, la sortie possède une caractéristique I-V qui suit le modèle exponentiel d'un groupe de cellules solaires. Vous devez d'abord spécifier l'ensemble des équations sur lesquelles la courbe est basée, spatiales ou terrestres. Référez-vous aux **Équations SAS**, où les équations du modèle sont listées.

Aide-mémoire des menus du panneau avant	Commande SCPI
Sélectionnez <b>Output\SAS\Curve\Shape</b> . Spécifiez Spatial ou Terrestre. Pour activer la forme, sélectionnez Set Curve (Définir Courbe) dans la boîte de dialogue Curve\Settings (voir ci-dessous).	Spécifiez la forme de la courbe : <b>SAS:CURV:SHAP SPACE</b> <b>SAS:CURV:SHAP TERRestrial</b>

Après avoir spécifié la forme, vous devez spécifier la caractéristique I-V de la courbe en utilisant les quatre paramètres :  $I_{mp}$ ,  $I_{sc}$ ,  $V_{mp}$  et  $V_{oc}$ . Ceux-ci peuvent être programmés individuellement, mais lors de la programmation d'une nouvelle courbe, il est préférable d'envoyer tous les paramètres de courbe sur la même ligne. Cette méthode entraîne un changement de courbe instantané.

Les paramètres de la courbe peuvent être entrés dans n'importe quel ordre. L'instrument détermine si tous les paramètres sont dans des limites acceptables. Tout paramètre non programmé conserve la valeur de la courbe programmée précédemment.

Aide-mémoire des menus du panneau avant	Commande SCPI
Sélectionnez <b>Output\SAS\Curve\Settings</b> . Dans la boîte de dialogue, entrez une valeur pour chacun des quatre paramètres de la courbe I-V. Appuyez ensuite sur <b>Set Curve (Définir Courbe)</b> .	Spécifiez les paramètres $I_{mp}$ , $I_{sc}$ , $V_{mp}$ et $V_{oc}$ sur la même ligne : <b>SAS:CURV:IMP &lt;n&gt;; ISC &lt;n&gt;; VMP &lt;n&gt;; VOC &lt;n&gt;</b>

- Si les paramètres de la courbe sont envoyés individuellement, une erreur peut se produire si la valeur du paramètre est en dehors de la courbe caractéristique admissible, déterminée par les trois paramètres existants. En outre, il peut falloir jusqu'à quatre changements de courbe pour obtenir la courbe finale.

## Programmation des paramètres de Tableau

Dans ce mode, un tableau de points I-V spécifie la courbe. Un tableau peut être programmé avec un maximum de 1 024 points I-V par tableau. Les valeurs du tableau ne sont **pas** enregistrées avec la configuration enregistrée de l'instrument. Vous pouvez charger jusqu'à deux tableaux dans la mémoire de l'instrument. Les listes de tableaux doivent satisfaire aux exigences suivantes.

Pour les listes de courant et de tension :

- Le nombre de points dans chaque liste peut varier de 3 à 1 024.
- Les deux listes doivent contenir le même nombre de points.

Pour la liste de tensions :

- La première valeur doit être 0 (une plage de  $\pm 10$  mV est autorisée).
- Les valeurs des points doivent être strictement croissantes et monotones. Les valeurs adjacentes ne peuvent pas être égales.

Pour la liste de courants :

- Les valeurs des points doivent être décroissantes et monotones. Les valeurs adjacentes ne peuvent pas être égales.
- La dernière valeur doit être 0 (une plage de  $\pm 0,3$  mA est autorisée).

Utilisez les commandes suivantes pour programmer les paramètres de tableau dans la mémoire de l'instrument :

Aide-mémoire des menus du panneau avant	Commande SCPI
Non disponible	Pour programmer une liste de tableau de courant : <b>SAS:TABL[1 2]:CURR &lt;courant&gt;{,&lt;courant&gt;}</b>  Pour programmer une liste de tableau de tension : <b>SAS:TABL[1 2]:VOLT &lt;tension&gt;{,&lt;tension&gt;}</b>

Utilisez la commande suivante pour activer le tableau, laquelle exécute la courbe en utilisant les points du tableau.

Aide-mémoire des menus du panneau avant	Commande SCPI
Sélectionnez <b>Output\SAS\Table</b> . Sélectionnez le tableau 1 ou 2.	Pour activer les tableaux de courant et de tension : <b>SAS:TABL:ACT 1</b>

- Si les points ne représentent pas un ensemble de données valide, une erreur sera générée.

## 4 Utilisation du système d'alimentations régénératrices

Utilisez les commandes suivantes pour interroger le nombre de points de données dans les tableaux de courant et de tension.

Aide-mémoire des menus du panneau avant	Commande SCPI
Sélectionnez <b>Output\SAS\Table</b> . La boîte de dialogue indique quel tableau est actif.	Pour interroger les points de tableaux de courant et de tension : <b>SAS:TABL[1 2]:CURR:POIN?</b> <b>SAS:TABL[1 2]:VOLT:POIN?</b>

### Programmation de tableaux multiples

**REMARQUE** Si aucun numéro de tableau n'est spécifié [1 ou 2], les commandes se réfèrent par défaut au Tableau 1.

Comme indiqué précédemment, et illustré dans la partie supérieure du schéma suivant, les commandes SAS:TABLE chargent les données de courant ou de tension dans la mémoire de l'instrument. Pour utiliser un tableau une fois les données chargées en mémoire, elles doivent être transférées dans l'emplacement du système SAS. La commande SAS:TABLE:ACTivate déplace (met à jour) les données dans le système SAS et sélectionne une étape de puissance dans le tableau.

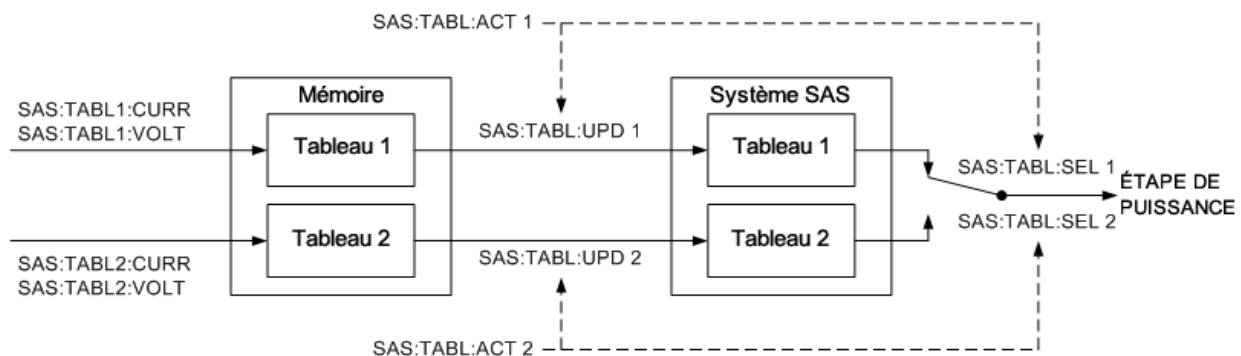

Pour passer rapidement d'un tableau à l'autre afin de générer des caractéristiques de courbe différentes, vous pouvez transférer les données de deux tableaux dans l'emplacement du système SAS en utilisant SAS:TABLE:UPDATE à l'avance, puis passer instantanément de l'un à l'autre en utilisant SAS:TABLE:SELECT. Les tableaux seront commutés sans que la sortie ne soit coupée.

Il est également possible d'utiliser la commande SAS:TABLE:ACTivate pour exécuter la même fonction que les commandes SAS:TABLE:UPDATE et SAS:TABLE:SELECT. Toutefois, comme il faut beaucoup de temps pour charger les données de la mémoire dans le système SAS, vous ne pouvez pas passer instantanément d'un tableau à l'autre en utilisant uniquement la commande SAS:TABLE:ACTivate.

Une séquence de tableaux peut être exécutée en chargeant un tableau dans le tableau 1 et en le sélectionnant. Ensuite, un nouveau tableau peut être chargé dans le tableau 2 et sélectionné. Un troisième tableau peut ensuite être chargé dans le tableau 1 et ainsi de suite.

Aide-mémoire des menus du panneau avant	Commande SCPI
Non disponible	Pour mettre à jour le tableau dans le système SAS : <b>SAS:TABL:UPD 1</b>

- Une erreur sera générée si les points ne représentent pas un ensemble de données valide.
- Vous pouvez mettre à jour les deux tableaux dans le système SAS.
- La mise à jour d'un tableau actuellement sélectionné aura un impact sur la courbe en cours.
- La commande de mise à jour ne met à jour que le tableau. Elle ne sélectionne pas le tableau.

Une fois chargé dans la mémoire du processeur, vous pouvez alors utiliser la commande SAS:TABLE:SElect pour exécuter le tableau. Vous pouvez également utiliser cette commande pour commuter entre deux tableaux dans l'emplacement du système SAS sans désactiver la sortie.

Aide-mémoire des menus du panneau avant	Commande SCPI
Non disponible	Pour sélectionner et exécuter le tableau 1 dans le système SAS : <b>SAS:TABL:SEL 1</b> pour commuter et exécuter le tableau 2 <b>SAS:TABL:SEL 2</b>

## Programmation des paramètres supplémentaires

### Facteurs d'échelle

Vous pouvez programmer des facteurs d'échelle pour les courbes SAS de courant et de tension.

Aide-mémoire des menus du panneau avant	Commande SCPI
Sélectionnez <b>Output\SAS\Scale</b> . Entrez un facteur d'échelle en pourcentage pour les tableaux de courant et/ou de tension. Appuyez ensuite sur <b>Select</b> .	Pour programmer les facteurs d'échelle de courant et de tension : <b>SAS:SCAL:CURR &lt;pourcentage&gt;</b> <b>SAS:SCAL:VOLT &lt;pourcentage&gt;</b>

- Cette fonction est active dans les modes Courbe et Tableau. Tous les tensions et courants de la courbe SAS sont multipliés par ces facteurs d'échelle.
- Les réglages du facteur d'échelle prennent effet immédiatement sans désactivation de la sortie.

### Bande passante

Deux plages de bande passante SAS sont disponibles pour optimiser la stabilité ou les performances d'une grande variété d'onduleurs. Ces plages s'appliquent à la fois en mode Courbe et Tableau.

**0** : la plage de bande passante lente est stable lors de l'essai d'une grande variété d'onduleurs.

**1** : la plage de bande passante rapide est optimisée pour les onduleurs avec des algorithmes MPPT plus rapides.



Aide-mémoire des menus du panneau avant	Commande SCPI
Sélectionnez <b>Output\SAS\Bandwidth</b> .	Pour programmer la bande passante SAS :
Sélectionnez la plage de bande passante : 0 lent ou 1 rapide. Appuyez ensuite sur <b>Select</b> .	<b>SAS:BWID:RANG 0   1</b>

## Détails sur les commandes SAS

En fonctionnement principal/secondaire, toutes les commandes SAS doivent être envoyées à l'appareil principal. Les appareils secondaires sont verrouillés ; vous ne pouvez pas programmer les réglages des appareils secondaires.

Les commandes SCPI suivantes ne sont pas prises en charge en mode SAS :

CALibrate:STATe	Active le mode d'étalonnage
CURRent:BWIDth	toutes les commandes CURR:BWID
CURRent[:LEVel]	toutes les commandes CURR[:LEV]
CURRent:LIMit	toutes les commandes CURR:LIM
CURRent:MODE STEP LIST ARB	toutes les commandes CURR:MODE sauf FIXed
CURRent:PROTection:STATe	Active l'état de protection du courant
CURRent:SLEW	Paramètre de réglage de la vitesse de balayage de courant
FUNCTION CURR VOLT	Paramètre du mode de priorité
OUTput[:STATe]:TMODe	Mode d'activation des sorties
VOLTage:BWIDth	toutes les commandes VOLT:BWID
VOLTage[:LEVel]	toutes les commandes VOLT[:LEV]
VOLTage:LIMit	toutes les commandes VOLT:LIM
VOLTage:MODE STEP LIST ARB	toutes les commandes VOLT:MODE sauf FIXed
VOLTage:RESistance	toutes les commandes VOLT:RES

Les commandes SAS suivantes ne sont pas disponibles en mode Courbe.

TABLE:ACTivate 1 2	Active un tableau
TABLE:SELection 1 2	Sélectionne un tableau
TABLE:UPDate 1 2	Met à jour un tableau

## Dépannage

En fonctionnement normal de groupe de cellules solaires, l'indicateur d'état du panneau avant indique l'état CC (courant constant). Si la courbe de groupe de cellules solaires fonctionne en dehors des limites normales de fonctionnement, l'indicateur d'état du panneau avant indique l'état VL+ (limite de tension positive) ou CL- (limite de courant négatif).

La plupart des erreurs du SAS impliquent que les paramètres de courbes et de tableaux se situent en dehors des limites acceptables des paramètres. Par exemple :

**Erreur 335, VMP doit être inférieur à VOC** (lorsque la forme de la courbe est réglée sur Spatial)

**Erreur 337, IMP doit être inférieur ou égal à ISC** (lorsque la forme de la courbe est réglée sur Spatial)

**Erreur 336, VMP doit être inférieur à 0,99 \* COV** (lorsque la forme de la courbe est réglée sur Terrestre)

**Erreur 338, IMP doit être inférieur à 0,99 \* ISC** (lorsque la forme de la courbe est réglée sur Terrestre)

D'autres erreurs peuvent se produire si VMP ou IMP est inférieur à la plage de valeurs autorisée, si le VOC calculé (ou vrai) dépasse le réglage de tension maximum de l'instrument, ou si la pente de la courbe est supérieure au dl/dV maximum autorisé de 1,947.

**Erreur 339, VMP et/ou IMP trop faible**

**Erreur 340, le VOC calculé dépasse le réglage de la tension maximale** (lorsque la forme de la courbe est réglée sur Terrestre)

**Erreur 315, erreur de conflit de paramètres ; dl/dV est <valeur calculée>, la valeur maximale est 1,947**

## Équations du modèle

En mode Courbe, vous pouvez choisir entre deux séries d'équations pour modéliser un groupe de cellules solaires. Il s'agit de la forme de la courbe spatiale et la forme de la courbe terrestre.

Reportez-vous à la commande **SASimulator:CURVe:SHAPE**.

### Forme de la courbe spatiale

Les équations suivantes décrivent le modèle exponentiel spatial de groupe de cellules solaires à l'aide des paramètres  $R_s$ ,  $N$  et  $a$ , qui sont définis comme fonctions des quatre paramètres d'entrée  $V_{oc}$ ,  $V_{mp}$ ,  $I_{sc}$ , and  $I_{mp}$ .

$$R_s = \frac{V_{oc} - V_{mp}}{I_{mp}}$$

$$N = \frac{\ln(2 - 2^a)}{\ln\left(\frac{I_{mp}}{I_{sc}}\right)}$$

$$a = \frac{V_{mp} \left(1 + \frac{R_s I_{sc}}{V_{oc}}\right) + R_s (I_{mp} - I_{sc})}{V_{oc}}$$

$$V = \frac{\frac{V_{oc} \ln\left(2 - \left(\frac{I}{I_{sc}}\right)^N\right)}{\ln(2)} - R_s (I - I_{sc})}{1 + \frac{R_s I_{sc}}{V_{oc}}}$$

#### 4 Utilisation du système d'alimentations régénératrices

Ce modèle est décrit dans le document : Britton, Lunscher, et Tanju, « A 9 KW High-Performance Solar Array Simulator », Actes de la conférence européenne sur l'énergie spatiale, août 1993 (ESA WPP-054, août 1993)

##### Forme de la courbe terrestre

Les équations suivantes décrivent le modèle exponentiel du simulateur de groupe de cellules solaires à l'aide des paramètres  $I_0$  et  $C_{aq}$ , qui sont définis comme fonctions des quatre paramètres d'entrée  $V_{oc}$ ,  $V_{mp}$ ,  $I_{sc}$ , and  $I_{mp}$ .

$$I_0 = I_{sc} \left( 1 - \frac{I_{mp}}{I_{sc}} \right)^{\frac{1}{1 - \frac{V_{mp}}{V_{oc}}}}$$

$$C_{aq} = \frac{\frac{V_{mp}}{V_{oc}} - 1}{\ln \left( 1 - \frac{I_{mp}}{I_{sc}} \right)}$$

$$I = I_{sc} - I_0 \left( e^{\frac{V}{V_{oc} C_{aq}}} - 1 \right)$$

Les équations ci-dessus sont dérivées des équations C.9, C.10 et C.5 de la norme européenne EN50530 (avril 2010), « Efficacité globale des onduleurs photovoltaïques raccordés au réseau ».

Ces équations sont également mathématiquement équivalentes aux équations 8, 9 et 7 du protocole de test de performance des onduleurs de Sandia, « Performance Test Protocol for Evaluating Inverters Used in Grid-Connected Photovoltaic Systems ». Pour établir cette équivalence, les substitutions de variables suivantes doivent être effectuées :

EN 50530	Sandia
$I_0$	$I_{sc} * C_1$
$C_{aq}$	$C_2$

## Didacticiel du mode de priorité

### Priorité de tension

### Priorité de courant

### Priorité de tension

En mode de priorité de tension, la sortie est contrôlée par une boucle de rétroaction à tension constante, qui maintient la tension de sortie à sa valeur programmée dès lors que le courant de charge demeure inférieur aux limites de courant positives ou négatives. Le mode de priorité de tension convient davantage à une utilisation avec des charges d'impédance résistives ou élevées, et des charges sensibles aux dépassements de tension. N'utilisez pas le mode de priorité de tension avec des sources de faible impédance, telles que les batteries, les blocs d'alimentation ou les condensateurs à forte charge.

En mode de priorité de tension, la tension de sortie doit être programmée sur la valeur souhaitée. Des valeurs limites de courant positive et négative doivent également être définies. La limite de courant doit toujours être définie à une valeur supérieure au courant de sortie réel requis de la charge externe. La figure suivante illustre le principe de fonctionnement de la priorité de tension de la sortie. La zone dans les quadrants blancs présente la sortie comme une source (puissance d'alimentation). Les quadrants grisés présentent la sortie comme une charge (puissance d'absorption).

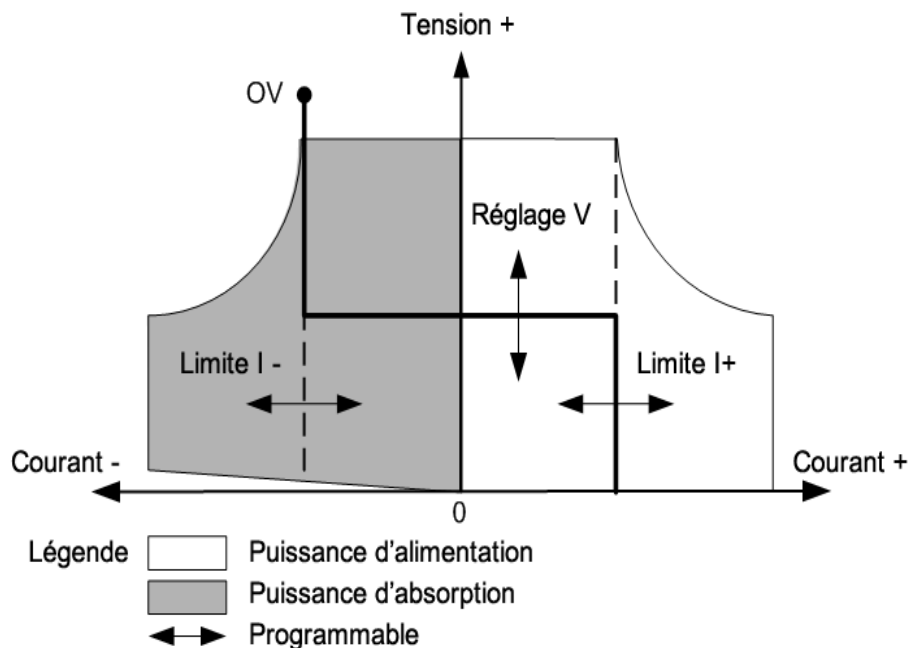

La grosse ligne pleine illustre l'espace des points de fonctionnement possibles comme une fonction de la charge de sortie. Comme l'indique la partie horizontale de la ligne, la tension de sortie demeure réglée sur sa valeur programmée dès lors que le courant de charge est inférieur aux limites de courant positives ou négatives. L'état CV (tension constante) signale que la tension de sortie est en cours de réglage et que le courant de sortie est inférieur à ses valeurs limites.

Notez que lorsque le courant de sortie atteint la limite de courant positive ou négative, l'appareil cesse de fonctionner en mode de tension constante et la tension de sortie n'est plus maintenue à un niveau constant. À la place, l'alimentation régule maintenant le courant de sortie à sa valeur limite de courant. Un état LIM+ (limite de courant positive) ou LIM- (limite de courant négative) est défini pour indiquer qu'une limite de courant a été atteinte. Ces conditions sont indiquées par l'état CL+ ou CL- sur le panneau avant.

Comme l'indiquent les parties verticales de la ligne de charge, la tension de sortie peut continuer d'augmenter dans le sens positif ou diminuer dans le sens négatif lorsque le courant est injecté ou évacué de l'appareil. Si la tension de sortie dépasse la valeur de protection contre les surtensions, la sortie est fermée, les relais de sortie s'ouvrent et l'octet d'état OV est activé.

### Priorité de courant

En mode de priorité de courant, la sortie est contrôlée par une boucle de rétroaction à courant constant bipolaire, qui maintient la source de sortie ou le courant absorbé à sa valeur programmée. Le courant de sortie conserve sa valeur programmée à condition que le courant de charge soit inférieur au réglage de la limite de courant. Le mode de priorité de courant est mieux adapté à une utilisation avec des batteries, des blocs d'alimentation, des condensateurs à forte charge et des charges sensibles aux dépassements de courant. Il minimise les dépassements de courant durant les transitions entre la programmation, la mise sous tension et la mise hors tension et assure des transitions fluides entre les courants positifs et négatifs.

En mode Priorité de courant, le courant de sortie doit être programmé en fonction de la valeur positive ou négative. Une valeur limite de tension positive doit également être définie. La limite de tension doit toujours être définie à une valeur supérieure à la tension de sortie réelle requise de la charge externe. La figure suivante illustre le principe de fonctionnement de la priorité de courant de sortie. La zone dans les quadrants blancs présente la sortie comme une source (puissance d'alimentation). Les quadrants grisés présentent la sortie comme une charge (puissance d'absorption).

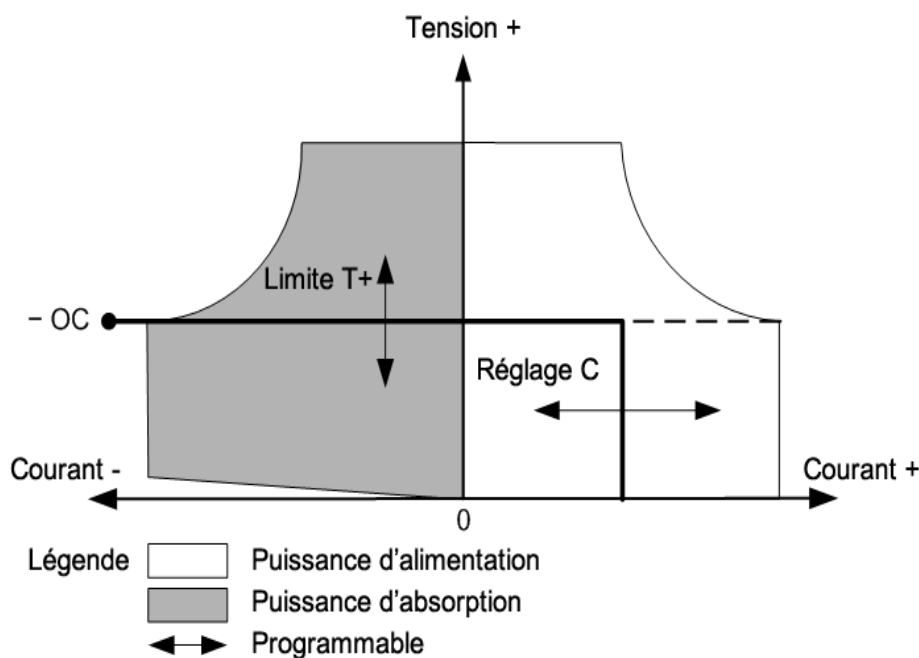

La grosse ligne pleine illustre l'espace des points de fonctionnement possibles comme une fonction de la charge de sortie. Comme l'indique la partie verticale de la ligne, le courant de sortie demeure réglé sur sa valeur programmée dès lors que la tension de sortie est inférieure à sa valeur limite. L'état CC (courant constant) signale que le courant de sortie est en cours de régulation et que la tension de sortie est inférieure à ses valeurs limites.

Notez que lorsque la tension de sortie atteint la limite de tension positive ou négative, l'appareil cesse de fonctionner en mode de courant constant et le courant de sortie n'est plus maintenu à un niveau constant. À la place, l'alimentation régule maintenant la tension de sortie à sa valeur limite de tension. L'état LIM+ (limite de tension positive) est activé pour indiquer que la limite de tension a été atteinte. Cette condition est signalée par l'état VL+ sur le panneau avant.

Comme l'indique la partie horizontale de la ligne de charge, lorsque l'appareil absorbe la puissance, le courant de sortie peut continuer d'augmenter dans le sens négatif à mesure qu'une plus grande quantité de courant est injectée dans l'appareil. Cette situation peut se produire lorsque la charge est une source d'alimentation comme une batterie et que sa tension de sortie est supérieure à la limite de tension du bloc d'alimentation. Lorsque le courant dépasse la limite de surintensité négative intégrée, la sortie est fermée, les relais de sortie s'ouvrent et les bits d'état OCF sont activés. Dans ce cas, il est important de régler correctement la limite de tension afin d'empêcher l'arrêt de cette protection.

**REMARQUE**

Pour plus d'informations sur le fonctionnement en mode prioritaire lors de l'activation/désactivation de la sortie, reportez-vous au chapitre **Comportement d'activation/désactivation**.

---



# 5

## Aide-mémoire de la programmation SCPI

**Logiciels associés**

**Présentation du SCPI**

**Commandes par sous-système**

**Didacticiel d'état**

**Didacticiel de déclenchement**

**État de réinitialisation**

**Messages d'erreur SCPI**

**Commandes de compatibilité**



## Logiciels associés

### **Logiciel avancé de contrôle et d'analyse d'alimentation BV9200B et BV9201B PathWave BenchVue**

Le logiciel BV9200 permet d'accéder rapidement et facilement aux fonctionnalités avancées d'alimentation et de mesure de votre système d'alimentation régénérative Série RP7900, sans aucune programmation. Le logiciel BV9200B vous permettra de contrôler jusqu'à quatre instruments à la fois, tandis que le logiciel BV9201B vous permettra de contrôler un seul instrument. Ce sont des outils flexibles pour toute application, qui vous permettent de contrôler n'importe lequel des 20 modèles de la Série RP7900. Notez que ce logiciel ne prend pas en charge le fonctionnement principal/secondaire. Pour en savoir plus et pour télécharger un essai gratuit, rendez-vous sur le site : [www.keysight.com/find/BV9200](http://www.keysight.com/find/BV9200).

### **Logiciel de test des onduleurs PV avancés/multi-entrées DG9000**

Le logiciel DG9000 vous permet de contrôler la sortie de jusqu'à douze instruments RPS (ou combinaisons principale/secondaire), ainsi que de créer, visualiser et télécharger facilement des courbes I-V solaires/photovoltaïques vers l'instrument en utilisant l'espace de travail du modèle PV. Une fois qu'une courbe a été téléchargée dans l'instrument, vous pouvez activer la sortie et observer de quelle manière l'onduleur PV recherche le point de puissance maximale, ce qui vous permet de mieux comprendre votre algorithme MPPT.

### **Bibliothèques d'E/S et pilotes de l'instrument**

Vous pouvez télécharger le logiciel Keysight IO Libraries Suite, ainsi que les pilotes IVI-COM et LabVIEW à partir du Réseau de développeurs Keysight à l'adresse [www.keysight.com/find/adn](http://www.keysight.com/find/adn).

### **Documentation de l'interface**

Pour de plus amples informations sur les connexions des interfaces, reportez-vous au document Keysight Technologies USB/LAN/GPIB Interfaces Connectivity Guide (en anglais), fourni avec la suite Keysight IO Libraries. Vous pouvez également télécharger le guide sur Internet à l'adresse [www.keysight.com/find/connectivity](http://www.keysight.com/find/connectivity).

### **Interface Web**

Le système Keysight RPS fournit une interface Web intégrée à l'instrument. Vous pouvez utiliser cette interface sur le réseau local pour accéder à distance à l'instrument et le contrôler à l'aide d'un navigateur Web. Pour de plus amples informations, reportez-vous à la section **Utilisation de l'interface Web**.

## Présentation du SCPI

### Mots-clés

### Requêtes

### Séparateurs et caractères de fin de commande

### Conventions syntaxiques

### Types de paramètres

### Device Clear

### Temps de traitement de commande type

## Introduction

Cet instrument est conforme aux règles et aux conventions de la version SCPI actuelle (voir **SYSTem:VERSion?**).

SCPI (Standard Commands for Programmable Instruments) est un langage de commande d'instrument ASCII conçu pour les instruments de test et de mesure. SCPI inclut deux types de commandes : courantes et de sous-système.

### Commandes courantes IEEE-488,2

La norme IEEE-488.2 définit un ensemble de commandes courantes qui exécutent des fonctions, telles que des opérations de réinitialisation, d'autotest et de configuration. Les commandes courantes commencent toujours par un astérisque (\*), sont composées de trois caractères et peuvent inclure un ou plusieurs paramètres. Le mot-clé d'une commande est séparé du premier paramètre par un espace blanc. Utilisez un point-virgule (;) pour séparer plusieurs commandes, comme indiqué ci-dessous :

### Commandes de sous-système

Les commandes de sous-système exécutent des fonctions spécifiques à l'instrument. Elles sont constituées de commandes organisées par ordre alphabétique qui s'étendent sous la racine sur un ou plusieurs niveaux dans une structure hiérarchique également appelée *arborescence*. Dans cette structure, les commandes associées sont regroupées dans un nœud (ou une racine) commun(e) pour former des *sous-systèmes*. Une partie du sous-système OUTPut est représentée ci-dessous pour illustrer l'arborescence. Notez que certaines commandes [facultatives] ont été ajoutées à des fins de clarté.

```

OUTPut
  [:STATe] OFF|0|ON|1
  :DELay
    :FALL <valeur>|MIN|MAX
    :RISE <valeur>|MIN|MAX
  :INHibit
    :MODE LATChing|LIVE|OFF

```

## Mots-clés

Les mots-clés, également appelés en-têtes, sont des instructions reconnues par l'instrument. Les commandes courantes sont également des mots-clés.

OUTPut est le mot-clé racine, DELay est un mot-clé de deuxième niveau, FALL et RISE sont des mots-clés de troisième niveau. Le signe des deux points (:) sépare les niveaux de mots-clés.

Cette syntaxe présente la plupart des commandes (et certains paramètres) sous la forme d'un mélange de lettres minuscules et majuscules. Les majuscules indiquent l'abréviation des commandes. Pour réduire la taille des lignes de programme, vous pouvez utiliser la forme abrégée. Pour une meilleure lisibilité des programmes, vous pouvez utiliser la forme complète.

Dans les exemples ci-dessus, OUPt et OUTPUT sont deux formes acceptables. Vous pouvez utiliser des majuscules ou minuscules. Par conséquent, les formes OUTPUT, outp et Outp sont toutes acceptables. D'autres formes, telles que OUT, ne sont pas valides et génèrent une erreur.

## Requêtes

Le fait d'ajouter un point d'interrogation (?) à la fin d'un mot-clé transforme ce dernier en requête (exemple : VOLTage?, VOLTage:TRIGgered?). Si une requête contient des paramètres, placez l'indicateur correspondant à la fin du dernier mot-clé, avant les paramètres. Insérez un espace entre l'indicateur de requête et le premier paramètre.

Vous pouvez rechercher la valeur programmée de la plupart des paramètres. Par exemple, vous pouvez obtenir le temps OUTPut:DELay:FALL précédemment réglé en envoyant la commande suivante :

```
OUTPut:DELay:FALL?
```

Vous pouvez également rechercher le temps de descente minimal ou maximal comme suit :

```
OUTPut:DELay:FALL? MIN  
OUTPut:DELay:FALL? MAX
```

Vous devez relire tous les résultats d'une requête avant d'envoyer une autre commande à l'instrument. Sinon, l'erreur *Query Interrupted* s'affiche et les données non renvoyées sont perdues.

## Séparateurs et caractères de fin de commande

### Séparateurs

Le signe des deux points (:) sépare les niveaux de mots-clés. Des espaces blancs doivent être utilisés pour séparer les paramètres de commande de leur mot-clé correspondant. Si une commande requiert plusieurs paramètres, utilisez une virgule pour séparer les paramètres adjacents. Dans l'exemple suivant, les paramètres *startindex* et *points* facultatifs doivent être séparés par une virgule. Notez l'espace entre CURRent? et le premier paramètre.

```
FETCh:CURRent? [<start_index>, <points>]
```

Les points-virgules (;) séparent les commandes dans un même sous-système. Vous pouvez ainsi envoyer plusieurs commandes de sous-système dans la même chaîne de message. Par exemple, envoyer la chaîne de commande suivante :

```
OUTPut:STATe ON;DELay:RISE 1;FALL 2
```

revient à envoyer les commandes suivantes :

```
OUTPut ON
OUTPut:DELay:RISE 1
OUTPut:DELay:FALL 2
```

Notez que le point-virgule suit le chemin implicite de la structure arborescente hiérarchique. Dans l'exemple ci-dessus, le mot-clé :STATe facultatif doit suivre le mot-clé OUTput pour placer l'analyseur de commande au deuxième niveau de la hiérarchie. Cela permet d'utiliser le mot-clé DELay après le point-virgule, car DELay est un mot-clé de deuxième niveau. Ensuite, l'analyseur de commande est placé au troisième niveau de la hiérarchie par le mot-clé :RISE. Cela permet d'utiliser le mot-clé FALL après le deuxième point-virgule, car FALL est un mot-clé de troisième niveau.

Vous pouvez également combiner des commandes de différents sous-systèmes dans la même chaîne de message. Dans ce cas, vous devez utiliser deux points pour renvoyer l'analyseur de commande au niveau de la racine afin d'accéder à un autre sous-système. Par exemple, vous pouvez annuler la fonction de protection et vérifier l'état du registre des conditions de fonctionnement dans un message à l'aide d'un spécificateur de racine comme suit :

```
OUTPut:PROTEction:CLEar;;STATus:OPERation :CONDition?
```

Notez l'utilisation des deux points *après* le point-virgule afin de renvoyer l'analyseur de commande vers la racine.

## Caractères de fin

Une chaîne de commande envoyée à l'instrument doit se terminer par un caractère de nouvelle ligne (<NL>). Le message IEEE-488 EOI (End-Or-Identify) est interprété comme un caractère <NL> et peut être utilisé à la place d'un <NL> pour terminer une chaîne de commande. Un retour chariot suivi d'une nouvelle ligne (<CR><NL>) est également accepté. Le caractère de fin de commande réinitialise toujours le chemin de la commande SCPI au niveau racine.

## Conventions syntaxiques

- Les crochets angulaires (< >) indiquent que vous devez indiquer une valeur pour le paramètre délimité. Par exemple, dans les instructions syntaxiques OUTPut:DELay ci-dessus, le paramètre <valeur> est entouré de crochets angulaires. Les crochets ne sont pas envoyés avec la chaîne de commande. Vous devez spécifier une valeur pour le paramètre (exemple : "OUTP:DEL:FALL 0.1"), sauf si vous sélectionnez une autre option indiquée dans la syntaxe (exemple : "OUTP:DEL:FALL MIN").

- Une barre verticale (|) sépare plusieurs paramètres dans une chaîne de commande donnée. Par exemple, la chaîne LATChing|LIVE|OFF dans la commande OUTPut:INHibit indique que vous pouvez spécifier « LATChing », « LIVE » ou « OFF ». La barre n'est pas envoyée avec la chaîne de commande.
- Les crochets ([ ]) entourent certains éléments syntaxiques, par exemple des nœuds et des paramètres. Cela indique que cet élément est facultatif. Les crochets ne sont pas envoyés avec la chaîne de commande. Dans le cas d'un paramètre facultatif, si vous ne spécifiez aucune valeur, l'instrument ignore ce paramètre. Dans l'exemple FETCh:CURRent? ci-dessus, les paramètres <startindex> et <points> vous permettent de renvoyer les données de tableau commençant à startindex et contenant le nombre de points de données spécifiés. Si ces paramètres ne sont pas spécifiés, la requête renvoie toutes les données de tableau.
- Les accolades ( { } ) indiquent les paramètres pouvant être répétés zéro fois ou plus. On les utilise plus particulièrement pour l'affichage de listes. La notation <valeur>{,<valeur>} indique que la première valeur doit être saisie, alors que les valeurs supplémentaires peuvent être omises ou saisies une ou plusieurs fois.

### Types de paramètres

Le langage SCPI définit plusieurs formats de données à utiliser dans les commandes et les requêtes.

#### Paramètres numériques

Les commandes qui nécessitent des paramètres numériques acceptent toutes les notations décimales courantes des nombres, y compris les signes facultatifs, les points décimaux et la notation scientifique. Si une commande accepte uniquement certaines valeurs, l'instrument arrondit automatiquement les paramètres numériques d'entrée aux valeurs admises. La commande suivante requiert un paramètre numérique pour la valeur de tension :

```
[SOURce:]VOLTage 50V|MIN|MAX
```

Notez que des valeurs spéciales, telles que MINimum, MAXimum et INFINITY, sont également admises pour les paramètres numériques. Au lieu de sélectionner une valeur donnée pour le paramètre de tension, vous pouvez utiliser MIN pour régler la tension à sa valeur minimale autorisée et MAX pour la définir à sa valeur maximale autorisée.

Vous pouvez également envoyer des suffixes d'unités techniques (par ex., V pour volts, A pour ampères, W pour watts). Toutes les valeurs de paramètre sont exprimées en unités de base.

#### Paramètres discrets

Les paramètres discrets permettent de programmer des réglages ayant un nombre limité de valeurs (par ex., IMMEDIATE, EXTERNAL ou BUS). Ils peuvent avoir une forme abrégée et une forme complète tout comme les mots-clés de commandes. Vous pouvez utiliser des majuscules ou minuscules. Les réponses aux requêtes renvoient toujours la forme abrégée en lettres majuscules. La commande suivante requiert un paramètre discret pour les paramètres d'affichage :

```
DISPlay:VIEW METER_VI|METER_VP|METER VIP
```

## Paramètres booléens

Les paramètres booléens représentent une condition binaire exclusivement vraie ou fausse. Pour une condition fausse, l'instrument accepte "OFF" ou "0". Pour une condition vraie, l'instrument accepte "ON" ou "1". Lorsque vous effectuez une requête sur un paramètre logique, l'appareil renvoie toujours "0" ou "1". La commande suivante nécessite un paramètre booléen :

```
DISPlay OFF|0|ON|1
```

## Paramètres de chaînes ASCII

Les paramètres de chaînes peuvent pratiquement contenir n'importe quelle combinaison de paramètres ASCII. Une chaîne de caractères doit commencer et se terminer par des guillemets simples ou doubles. Vous pouvez inclure le délimiteur de guillemets dans la chaîne de caractères en le tapant deux fois sans caractères entre eux. La commande suivante utilise un paramètre de chaîne de caractères :

```
CALibrate:DATE "12/12/12"
```

## Programme ou données de réponse de bloc arbitraire

Les données en bloc <Bloc> de longueur définie permettent de programmer ou de renvoyer les données dépendant d'un appareil sous forme d'un ensemble de données binaires sur 8 bits. Cela est particulièrement utile pour transférer de grandes quantités de données ou des codes ASCII étendus sur 8 bits.

## Device Clear

Device Clear est un message de bas niveau du bus IEEE-488 que vous pouvez utiliser pour ramener l'instrument à l'état réactif. Différents langages de programmation et cartes d'interface IEEE-488 permettent d'accéder à cette fonction au moyen de commandes uniques propres. Les registres d'état, la file d'erreurs et tous les états de configuration restent inchangés quand un message Device Clear message est reçu.

Device Clear effectue les actions suivantes :

- Si une mesure est en cours, elle est annulée.
- L'instrument revient à l'état de déclenchement inactif.
- Les tampons d'entrée et de sortie de l'instrument sont effacés.
- L'instrument est prêt à recevoir une nouvelle chaîne de commande.

**REMARQUE** La commande ABORt est la méthode recommandée pour interrompre une opération de l'instrument.

---

## Temps de traitement de commande type

Le tableau suivant décrit quelques-uns des temps moyens de traitement de commande type pour plusieurs types de commandes de réglage et requêtes de réponse. Vous pourrez ainsi déterminer l'impact de certaines commandes SCPI couramment utilisées sur la durée de test totale. Tous les temps sont exprimés en millisecondes.

Les commandes de réglage, telles que VOLT <n> prennent uniquement en compte la latence des E/S + le traitement de la commande, et non le temps nécessaire pour terminer l'action (comme le temps nécessaire à la modification effective de la tension de sortie ou l'activation de l'état de sortie).

Les temps de commande de requête s'appliquent entre le moment où la commande est envoyée à l'instrument et celui où la réponse est reçue.

Commandes	GPIB	VXI-11
Régler la tension de sortie : VOLT <n>	0,24 ms	0,65 ms
Renvoyer le réglage de sortie : OUPP?	0,30 ms	1,35 ms
Définir l'appareil à l'état de réinitialisation : *RST	5,01 ms	5,26 ms
Mesure de 10 points		
Renvoyer la mesure de 10 points : MEAS:VOLT?	3,00 ms	3,30 ms
Renvoyer la récupération de 10 points : FETC:VOLT?	0,49	1,49 ms
Mesure de 1 NPLC		
Renvoyer la mesure de 1 NPLC : MEAS:VOLT?	21,03 ms	20,96 ms
Renvoyer la récupération de 1 NPLC : FETC:VOLT?	0,63 ms	1,41 ms
Mesure de 25 000 points		
Renvoyer la mesure de 25 000 points : MEAS:VOLT?	521,0 ms	521,1 ms
Renvoyer la récupération de 25 000 points : FETC:VOLT?	5,07 ms	7,01 ms
Renvoyer la récupération du tableau ASCII de 25 000 points : FETC:ARR:VOLT?	4009,5 ms	1010,8 ms
Renvoyer la récupération du tableau binaire de 25 000 points : FETC:ARR:VOLT?	694,25 ms	30,39 ms

## Commandes par sous-système

**ABORt**

**CALibrate**

**DISPlay**

**FETCh**

**FORMat**

**HCOPy**

**IEEE-488 Common**

**INITiate**

**INSTrument**

**LXI**

**MEASure**

**OUTPut**

**SENSe**

**[SOURce:]**

**ARB**

**CURRent**

**DIGital**

**FUNCTion**

**LIST**

**POWer**

**SASimulator (photovoltaïque)**

**STEP**

**VOLTage**

**STATus**

**SYSTem**

**TRIGger**



## Sous-système ABORt

Les commandes Abort permettent d'annuler tous les transitoires déclenchés et de renvoyer le système de déclenchement à l'état inactif. Elles sont également exécutées avec la commande \*RST.

### ABORt:ACQuire

### ABORt:ELOG

### ABORt:TRANsient

ABORt:ACQuire : Annule toutes les mesures déclenchées. Cette commande réinitialise également les bits WTG-meas et MEAS-active dans les registres d'état de fonctionnement.

ABORt:ELOG : Arrête l'enregistrement de données externe. Cette commande réinitialise également les bits WTG-meas et MEAS-active dans les registres d'état de fonctionnement.

ABORt:TRAN : Annule les transitoires ou Arbs. Cette commande réinitialise également les bits WTG-tran et TRAN-actif dans les registres d'état de fonctionnement. Notez que cette commande ne désactive pas les déclenchements continus si la commande INITiate:CONTinuous:TRANsient ON a été programmée. Dans ce cas, désactivez d'abord les déclenchements continus avant d'envoyer la commande ABORt.

Paramètre	Renvoitype
(aucun)	(aucun)
Interrompt la mesure déclenchée : ABOR:ACQ	

## Sous-système ARB

Les commandes ARB permettent de programmer des signaux arbitraires à palier constant. Les signaux à palier constant peuvent se voir attribués jusqu'à 65 535 points, le même temps de palier étant appliqué à chaque point.

**[SOURce:]ARB:COUNT <valeur>|MIN|MAX|INFinity**  
**[SOURce:]ARB:COUNT? [{MIN|MAX}]**

Indique le nombre de répétitions du signal arbitraire. Utilisez le paramètre INFinity pour répéter continuellement le signal arbitraire.

Paramètre	Renvoi type
1 - 256, *RST 1	<nombre>
Programme 10 répétitions : ARB:COUN 10	

**[SOURce:]ARB:CURRent:CDWell[:LEVel] <valeur>{,<valeur>}<Bloc>**  
**[SOURce:]ARB:CURRent:CDWell[:LEVel]?**  
**[SOURce:]ARB:VOLTage:CDWell[:LEVel] <valeur>{,<valeur>}<Bloc>**  
**[SOURce:]ARB:VOLTage:CDWell[:LEVel]?**

Indique le temps de chaque point dans le signal arbitraire. Les valeurs sont exprimées en ampères ou en volts. Les valeurs minimale et maximale varient selon les valeurs nominales de l'appareil.

Les signaux arbitraires de courant et de tension partagent les mêmes réglages. Le réglage du signal arbitraire de courant entraîne donc la réinitialisation du niveau du signal arbitraire de tension à sa valeur par défaut et vice versa. Pour des performances optimales, vous pouvez envoyer la liste sous forme de valeurs à virgule flottante simple précision au format de bloc arbitraire de taille définie à la place d'une liste ASCII. Le format de la réponse dépend du format de retour ASCII ou REAL.

Paramètre	Renvoi type
-102 à 102 % du courant nominal ou 0 à 102 % de la tension nominale	<valeur> [,<valeur>] ou <Bloc>
Programme un signal arbitraire à palier constant de 5 points de tension : ARB:VOLT:CDW 5,4,3,2,1	

**[SOURce:]ARB:CURRent:CDWell:DWELL <valeur>**  
**[SOURce:]ARB:CURRent:CDWell:DWELL?**  
**[SOURce:]ARB:VOLTage:CDWell:DWELL <valeur>**  
**[SOURce:]ARB:VOLTage:CDWell:DWELL?**

Indique le temps de palier de chaque point dans le signal arbitraire. Les valeurs sont exprimées en secondes et sont arrondies à l'incrément de 10,24 microsecondes le plus proche.

## 5 Aide-mémoire de la programmation SCPI

Les signaux arbitraires de courant et de tension partagent les mêmes paramètres. La définition de ce paramètre pour un signal arbitraire de courant entraîne donc la modification de la valeur du palier de tension et vice versa.

Paramètre	Renvoi type
0.00001024 – 0.30, *RST 0.001	<valeur de palier>
Programme un temps de palier constant de 0,2 seconde : ARB:CURR:CDW:DWEL 0.2	

- Vous pouvez programmer des durées de palier beaucoup plus courtes que le temps de réponse de l'instrument. Les points « supplémentaires » et les durées de palier peuvent servir à lisser le signal obtenu.

### [SOURce:]ARB:CURRent:CDWWell:POINts?

### [SOURce:]ARB:VOLTage:CDWWell:POINts?

Renvoie le nombre de points dans le signal arbitraire.

Paramètre	Renvoi type
(aucun)	<points>
Renvoie le nombre de points de courant dans le signal arbitraire : ARB:CURR:CDW:POIN?	

### [SOURce:]ARB:FUNCtion:TYPE CURRent|VOLTage

### [SOURce:]ARB:FUNCtion:TYPE?

Indique un signal arbitraire de tension ou de courant. Un seul type de signal arbitraire peut être généré à la fois. La sélection doit correspondre au mode de priorité.

Paramètre	Renvoi type
CURRent VOLTage, *RST VOLTage	VOLT ou CURR
Indique un signal arbitraire de tension : ARB:FUNC:TYPE VOLT	

### [SOURce:]ARB:TERMinate:LAST 0|OFF|1|ON

### [SOURce:]ARB:TERMinate:LAST?

Sélectionne le réglage de sortie à la fin du signal arbitraire. Si cette commande est activée (1), la tension ou le courant de sortie sont maintenus à la dernière valeur du signal arbitraire. La dernière valeur de tension ou de courant du signal arbitraire devient la valeur IMMEDIATE une fois le signal arbitraire terminé. Si elle est désactivée (0) et que le signal arbitraire est interrompu, la sortie retourne aux paramètres qui étaient appliqués avant le début du signal arbitraire.

Paramètre	Renvoi type
0 OFF 1 ON, *RST OFF	0 ou 1
Interrompt avec la sortie définie à la dernière valeur du signal arbitraire : ARB:TERM:LAST ON	

## Sous-système CALibrate

Les commandes Calibrate permettent d'étalonner l'instrument.

**REMARQUE** Lisez la **section d'étalonnage** avant d'effectuer un étalonnage. Un étalonnage incorrect réduit la précision et la fiabilité de l'instrument.

### CALibrate:COUNT?

Renvoie le nombre de fois que l'appareil a été étalonné. Le nombre est incrémenté chaque fois que l'étalonnage (et la date) est enregistré, le mot de passe d'administration modifié ou réinitialisé, ou le microprogramme mis à jour.

Paramètre	Renvoi type
(aucun)	<nombre>
Renvoyer le nombre d'étalonnages : CAL:COUN?	

### CALibrate:CURRent[:LEVel] <valeur>

Étalonne la programmation et la mesure du courant. La valeur sélectionne la plage à étalonner.

Paramètre	Renvoi type
Courant maximal de la plage de sortie.	(aucun)
Étalonne le courant de la plage de 10 A : CAL:CURR 10	

### CALibrate:CURRent:TC

Étalonne le coefficient de température.

Paramètre	Renvoi type
(aucun)	(aucun)
Étalonne le coefficient de température : CAL:CURR:TC	

### CALibrate:DATA <valeur>

Saisit la valeur d'étalonnage relevée sur le multimètre externe. Vous devez d'abord sélectionner un niveau d'étalonnage pour la valeur saisie. Les valeurs de données sont exprimées en unités de base (volts ou ampères), selon la fonction en cours d'étalonnage.

Paramètre	Renvoi type
Valeur numérique	(aucun)
Spécifier la valeur d'étalonnage 0,0237 : CAL:DATA 2.37E-2	

**CALibrate:DATE <"date">****CALibrate:DATE?**

Enregistre la date d'étalonnage dans la mémoire non volatile. Saisissez une chaîne ASCII d'une longueur maximale de 15 caractères. La requête renvoie la date.

Paramètre	Renvoitype
<"date"> Données du programme de chaîne. Entourez les paramètres de chaînes de guillemets simples ou doubles.	< date du dernier étalonnage >
Saisit la date d'étalonnage : CAL:DATE "12/12/12"	

**CALibrate:LEVel P1|P2|P3****CALibrate:LEVel?**

Passes au niveau d'étalonnage suivant. P1 est le premier niveau, P2 le deuxième et P3 le troisième.

Paramètre	Renvoitype
P1 P2 P3	(aucun)
Sélectionne le premier point d'étalonnage : CAL:LEV P1	

- Certaines séquences d'étalonnage peuvent nécessiter un certain temps de stabilisation après l'envoi de la commande CAL:LEV, mais avant de lire les données sur le multimètre numérique et d'envoyer la commande CAL:DATA.

**CALibrate:PASSword <mot de passe>**

Définit un mot de passe numérique pour empêcher tout étalonnage non autorisé. Identique au mot de passe **Admin**.

Paramètre	Renvoitype
<motdepasse> Valeur numérique pouvant contenir jusqu'à 15 chiffres	(aucun)
Définir un nouveau mot de passe à la valeur 1234 : CAL:PASS 1234	

- Si le mot de passe est défini sur 0, la protection par mot de passe est supprimée et la possibilité de passer en mode d'étalonnage est illimitée. Le paramètre configuré en usine est égal à 0 (zéro).
- Modifier le mot de passe : libérez la mémoire d'étalonnage avec l'ancien code, puis configurez le nouveau code.
- Si vous avez oublié votre mot de passe, reportez-vous à la section **Commutateurs d'étalonnage**.
- Ce paramètre est non volatile ; une coupure/rétablissement de l'alimentation ou la commande \*RST ne le modifie pas.

**CALibrate:SAVE**

Enregistre les constantes d'étalonnage dans la mémoire non volatile. Effectuez cette opération à la fin de l'étalonnage pour éviter de perdre vos modifications.

Paramètre	Renvoi type
(aucun)	(aucun)
Enregistrer les constantes d'étalonnage en mémoire non volatile : <b>CAL:SAVE</b>	

**CALibrate:STATe 0|OFF|1|ON [, <mot de passe>]****CALibrate:STATe?**

Active ou désactive le mode d'étalonnage. Le mode d'étalonnage doit être activé pour que l'instrument accepte des commandes d'étalonnage. Le premier paramètre indique l'état. Le deuxième paramètre facultatif est le mot de passe.

Paramètre	Renvoi type
0 OFF 1 ON, *RST OFF	0 ou 1
<motdepasse> : valeur numérique d'une longueur maximale de 15 chiffres.	(aucun)
Désactiver l'étalonnage : <b>CAL:STAT OFF</b>	
Activer l'étalonnage : <b>CAL:STAT ON [,valeur]</b>	

Un mot de passe est nécessaire si <motdepasse> a été défini à une valeur différente de zéro.

**CALibrate:VOLTage[:LEVel] <valeur>**

Étalonne la programmation et la mesure de la tension locale. La valeur sélectionne la plage à étalonner.

Paramètre	Renvoi type
Courant maximal de la plage de sortie en cours d'étalonnage.	(aucun)
Étalonne la tension de la plage de 20 V : <b>CAL:VOLT 20</b>	

## Sous-système CURRent

Les commandes Current permettent de programmer le courant de sortie de l'instrument.

**[SOURce:]CURRent[:LEVel][:IMMEDIATE][:AMPLitude] <valeur>|MIN|MAX**  
**[SOURce:]CURRent[:LEVel][:IMMEDIATE][:AMPLitude]? [{MIN|MAX}]**  
**[SOURce:]CURRent[:LEVel]:TRIGgered[:AMPLitude] <valeur>|MIN|MAX**  
**[SOURce:]CURRent[:LEVel]:TRIGgered[:AMPLitude]? [{MIN|MAX}]**

Définit le niveau de courant immédiat ou déclenché lorsque la sortie fonctionne en mode de priorité de courant. Le niveau déclenché est une valeur enregistrée qui est transférée vers la sortie lors du déclenchement d'un palier de sortie. Les unités sont exprimées en ampères. La valeur maximale varie selon le courant nominal de l'appareil. La valeur minimale est la valeur la plus négative.

Paramètre	Renvoi type
-102 % à 102 % de la valeur nominale, *RST 0	<niveau du courant>
Règle le courant positif sur 2 A : CURR 2	

**[SOURce:]CURRent:BWIDth:LEVel 0, <valeur>|MIN|MAX**  
**[SOURce:]CURRent:BWIDth:LEVel? [{MIN|MAX}]**

Indique la fréquence d'angle du filtre passe-bas appliquée au signal du point de consigne de programmation avec la bande passante de courant. La valeur est en Hertz. La fréquence par défaut est optimisée pour une vitesse de programmation amont maximale, ainsi que pour le temps de réponse transitoire le plus rapide. Il est possible de la réduire pour compenser les dépassements de sortie.

Paramètre	Renvoi type
0, (plage de bande passante - obligatoire)	0
10 à 100,000, *RST 5,000	<Fréquence d'angle>
Avec la bande passante de courant à 0, fixe la fréquence à 60 Hz : CURR:BWID:LEV 0, 60	

**[SOURce:]CURRent:LIMit[:POSitive][:IMMEDIATE][:AMPLitude] <valeur>|MIN|MAX**  
**[SOURce:]CURRent:LIMit[:POSitive][:IMMEDIATE][:AMPLitude]? [{MIN|MAX}]**  
**[SOURce:]CURRent:LIMit:NEGative[:IMMEDIATE][:AMPLitude] <valeur>|MIN|MAX**  
**[SOURce:]CURRent:LIMit:NEGative[:IMMEDIATE][:AMPLitude]? [{MIN|MAX}]**

Définit la limite de courant en mode de priorité de tension. Les unités sont exprimées en ampères. La valeur maximale varie selon le courant nominal de l'appareil. La valeur minimale est la valeur la plus négative.

Paramètre	Renvoi type
Positive : 0 à 102 % de la valeur nominale, *RST 1,02 % de la valeur nominale	<limite de courant +> <limite de courant ->
Negative : -102 % de la valeur nominale à 0, *RST -1,02 % de la valeur nominale	
Règle la limite de courant positive sur 2 A : <code>CURR:LIM 2</code>	
Règle la limite de courant négative sur -2 A : <code>CURR:LIM:NEG -2</code>	

### **[SOURce:]CURRent:MODE FIXed|STEP|LIST|ARB** **[SOURce:]CURRent:MODE?**

Définit le mode de transitoire. Cette commande détermine ce qu'il advient du courant de sortie lorsque le système de transitoire est démarré et déclenché.

**FIXed** maintient le courant de sortie à sa valeur immédiate.

**STEP** (palier) fait passer la sortie au niveau déclenché lorsqu'un déclenchement se produit.

**ARB** entraîne la mise en conformité de la sortie aux valeurs de liste lorsqu'un déclenchement se produit.

**ARB** provoque la conformité de la sortie aux valeurs du signal arbitraire lorsqu'un déclenchement se produit.

Paramètre	Renvoi type
FIXed STEP LIST ARB, *RST FIXed	FIX, STEP, LIST ou ARB
Définit le mode de courant sur Step : <code>CURR:MODE STEP</code>	

### **[SOURce:]CURRent:PROTection:DELAy[:TIME] <valeur>|MIN|MAX** **[SOURce:]CURRent:PROTection:DELAy[:TIME]? [{MIN|MAX}]**

Définit le délai de protection contre les surintensités. La fonction de protection contre les surintensités n'est pas déclenchée pendant le délai de temporisation. Une fois le délai expiré, la fonction de protection contre les surintensités est activée. Cela permet d'éviter que les variations momentanées de l'état de sortie ne déclenchent la fonction de protection contre les surintensités. Les valeurs allant jusqu'à 255 millisecondes peuvent être programmées avec une résolution de 1 milliseconde.

Paramètre	Renvoi type
0 - 0,255, *RST 0.020 s	<valeur de délai>
Définit le délai de protection à 0,2 seconde : <code>CURR:PROT:DEL 0.2</code>	

- La fonction de protection contre les surintensités est affectée par le réglage de l'événement de démarrage du délai de protection contre les surintensités, qui est spécifié par la commande `CURRent:PROTection:DELAy:START`.

### **[SOURce:]CURRent:PROTection:DELAy:START SChange|CCTRans** **[SOURce:]CURRent:PROTection:DELAy:START?**

Indique l'événement déclencheur du temporisateur de protection contre les surintensités.



**SCHange** déclenche le délai de protection contre les surintensités chaque fois qu'une commande modifie la tension de sortie, le courant ou l'état de sortie.

**CCTRans** déclenche le temporisateur de protection contre les surintensités chaque fois que la sortie passe en mode de limite de courant.

Paramètre	Renvoi type
SCHange CCTRans, *RST SCHange	SCH ou CCTR
Sélectionne le mode de délai CCTRans : <b>CURR:PROT:DEL:STAR CCTR</b>	

### **[SOURce:]CURRent:PROTection:STATe 0|OFF|1|ON** **[SOURce:]CURRent:PROTection:STATe?**

Active ou désactive la fonction de protection contre les surintensités. Si la fonction de protection contre les surintensités est activée et que la sortie passe en mode de limite de courant, la sortie est désactivée et le bit d'état OCP du registre d'état des conditions suspectes est activé.

Paramètre	Renvoi type
0 OFF 1 ON, *RST OFF	0 ou 1
Activer l'état de protection contre les surintensités : <b>CURR:PROT:STAT ON</b>	

- Une condition de surintensité peut être annulée à l'aide de la commande **OUTPut:PROTection:CLEar** une fois la cause du problème isolée.

### **[SOURce:]CURRent:SLEW[:IMMediate] <valeur>|MIN|MAX|INFinity** **[SOURce:]CURRent:SLEW[:IMMediate]? [{MIN|MAX}]**

Définit la vitesse de balayage du courant. La vitesse de balayage est définie en ampères par seconde et concerne toutes les variations de courant programmées, notamment celles dues à l'activation ou la désactivation de l'état de sortie. La vitesse de balayage peut être réglée sur n'importe quelle valeur comprise entre 0 et  $9,9E + 37$ . Pour les valeurs très élevées, la vitesse de balayage est limitée par la vitesse de programmation et la bande passante indiquées de l'appareil. Les mots-clés **MAX** ou **INFinity** définissent la vitesse de balayage à la valeur maximale.

Paramètre	Renvoi type
0 - 9.9E+37, *RST MAX	<valeur max.>
Définit la vitesse de balayage de sortie à 1 A par seconde : <b>CURR:SLEW 1</b>	

- La requête renvoie la valeur qui a été envoyée. Si la valeur est inférieure à la vitesse de balayage minimale, la valeur minimale est renvoyée. La résolution du réglage de balayage est la même que la valeur minimale. Il est possible d'effectuer une recherche en utilisant **CURRent:SLEW? MIN**. La valeur exacte varie sensiblement selon l'étalonnage.

**[SOURce:]CURRent:SLEW:MAXimum 0|OFF|1|ON**  
**[SOURce:]CURRent:SLEW:MAXimum?**

Active ou désactive le remplacement de la vitesse de balayage maximale. Lorsqu'elle est activée, la vitesse de balayage est définie à sa valeur maximale. Lorsqu'elle est désactivée, la vitesse de balayage est définie à la valeur immédiate par la commande CURRent:SLEW. Utilisez CURRent:SLEW? MAX pour rechercher la vitesse de balayage maximale qui a été définie.

Paramètre	Renvoitype
0 OFF 1 ON, *RST ON	0 ou 1
Activer la vitesse de balayage maximale : <b>CURR:SLEW:MAX ON</b>	

- La commande CURRent:SLEW:MAX est associée à la commande CURRent:SLEW. Si CURRent:SLEW définit la vitesse sur MAX ou INFinity, la commande CURRent:SLEW:MAX est activée. Si la vitesse de balayage est définie sur une autre valeur, la commande CURRent:SLEW:MAX est désactivée.

## Sous-système DIGital

Les commandes Digital permettent de programmer le port de commande numérique situé sur le panneau arrière de l'instrument.

### [SOURce:]DIGital:INPut:DATA?

Lit l'état du port de commande numérique. Renvoie la valeur binaire pondérée de l'état des broches 1 à 7 des bits 0 à 6, respectivement.

Paramètre	Renvoi type
(aucun)	<valeur de bit>
Lit l'état du port de commande numérique : <code>DIG:INP:DATA?</code>	

### [SOURce:]DIGital:OUTPut:DATA <valeur>

### [SOURce:]DIGital:OUTPut:DATA?

Définit l'état du port de commande numérique. Cette commande ne concerne que les broches dont la fonction a été définie pour une utilisation de la fonction E/S numérique. Le port comporte sept broches de signal et une broche de terre numérique. Dans la valeur binaire pondérée qui est écrite dans le port, les broches sont contrôlées conformément aux affectations de bit suivantes :

Broche	1	2	3	4	5	6	7
Numéro de bit	0	1	2	3	4	5	6
Valeur décimale	1	2	4	8	16	32	64

Les valeurs de bit correspondant aux broches du port numérique qui ne sont pas configurées comme E/S num. sont ignorées.

Paramètre	Renvoi type
0 - 127, *RST 0	<valeur de bit>
Programme les broches 1, 3 et 5 : <code>DIG:OUTP:DATA?</code>	

### [SOURce:]DIGital:PIN<1-7>:FUNction <fonction>

### [SOURce:]DIGital:PIN<1-7>:FUNction?

Définit la fonction de la broche. Les fonctions sont enregistrées dans la mémoire non volatile.

DIO	Fonction d'entrée/sortie numérique polyvalente référencée à la masse.
DINPut	Mode d'entrée numérique uniquement.
FAULt	La broche 1 fonctionne comme une sortie d'erreur isolée. La broche 2 est commune à la broche 1.
INHibit	La broche 3 fonctionne comme une entrée d'inhibition.
ONCouple	Les broches 4 -7 synchronisent l'état d'activation de la sortie.

<b>OFFCouple</b>	Les broches 4 -7 synchronisent l'état de désactivation de la sortie.
<b>TINPut</b>	Fonction d'entrée de déclenchement.
<b>TOUTput</b>	Fonction de sortie de déclenchement.

Paramètre	Renvoi type
DIO DINPut FAULt INHibit ONCouple OFFCouple TINPut TOUTput	DIO, DINP, FAUL, INH, ONC, OFFC, TINP, ou TOUT
Définit la broche 1 en mode FAULt : <b>DIG:PIN1:FUNC FAUL</b>	

### **[SOURce:]DIGital:PIN<1-7>:POLarity POSitive|NEGative** **[SOURce:]DIGital:PIN<1-7>:POLarity?**

Définit la polarité de la broche.

**POSitive** signifie qu'un signal vrai logique est une tension haute sur la broche. Pour les entrées et les sorties de déclenchement, POSitive équivaut à un front montant.

Définir la polarité d'une broche sur **NEGative** signifie qu'un signal vrai logique est une tension faible sur la broche. Pour les entrées et les sorties de déclenchement, NEGative équivaut à un front descendant. Les polarités de la broche sont enregistrées dans la mémoire non volatile.

Paramètre	Renvoi type
POSitive NEGative	POS ou NEG
Définit la broche 1 sur la polarité POSitive : <b>DIG:PIN1:POL POS</b>	

### **[SOURce:]DIGital:TOUTput:BUS[:ENABLE] 0|OFF|1|ON** **[SOURce:]DIGital:TOUTput:BUS[:ENABLE]?**

Active ou désactive les déclencheurs BUS sur les broches du port numérique. Cette commande permet d'envoyer un signal de déclenchement par BUS à une broche de port numérique qui a été configurée comme sortie de déclenchement. Une impulsion de sortie de déclenchement est générée lorsque l'état est activé et qu'une commande de déclenchement de bus est reçue. Un signal de déclenchement par BUS est généré à l'aide de la commande \*TRG.

Paramètre	Renvoi type
0 OFF 1 ON, *RST OFF	0 ou 1
Activer des signaux déclenchés par BUS sur les broches numériques : <b>DIG:TOUT:BUS ON</b>	

- La requête renvoie la valeur 0 (OFF) si le signal de déclenchement n'est pas généré à l'aide d'une commande de déclenchement BUS et la valeur 1 (ON) si un signal de déclenchement est généré à l'aide d'une commande de déclenchement BUS.

## Sous-système DISPlay

Les commandes Display permettent de contrôler l'écran du panneau avant.

**DISPlay[:WINDow][:STATe] 0|OFF|1|ON**  
**DISPlay[:WINDow][:STATe]?**

Allume ou éteint l'écran du panneau avant.

Paramètre	Renvoi type
0 OFF 1 ON, *RST ON	0 ou 1
Éteint l'écran du panneau avant : <b>DISP OFF</b>	

**DISPlay[:WINDow]:VIEW METER\_VI|METER\_VP|METER\_VIP**  
**DISPlay[:WINDow]:VIEW?**

Sélectionne les paramètres à afficher sur le panneau avant.

METER\_VI affiche la tension et le courant de sortie.

METER\_VP affiche la tension et la puissance de sortie.

METER\_VIP affiche la tension, le courant et la puissance de sortie.

Paramètre	Renvoi type
METER_VI METER_VP METER_VIP, *RST METER_VI	METER_VI, METER_VP, ou METER_VIP
Afficher la tension et la puissance : <b>DISP:VIEW METER_VP</b>	

**DISPlay:SAVer[:STATe] 0|OFF|1|ON**  
**DISPlay:SAVer[:STATe]?**

Allume ou éteint l'écran de veille du panneau avant.

Paramètre	Renvoi type
0 OFF 1 ON, *RST OFF	0 ou 1
Allume l'écran de veille du panneau avant : <b>DISP:SAV ON</b>	

## Sous-système FETCh

Les commandes Fetch permettent de renvoyer les données de mesure qui ont été précédemment acquises. Les requêtes FETCh ne génèrent pas de nouvelles mesures. Cependant, elles permettent de réaliser des calculs de mesure supplémentaires à partir des mêmes données acquises. Les données sont valides jusqu'au déclenchement de la commande MEASure ou INITiate suivante.

**FETCh[:SCALar]:CURRent[:DC]? [<start\_index>, <points>]**

**FETCh[:SCALar]:POWer[:DC]?**

**FETCh[:SCALar]:VOLTage[:DC]? [<start\_index>, <points>]**

Renvoie la mesure moyenne. Les valeurs renvoyées sont exprimées en volts ou en watts.

Les paramètres facultatifs indiquent un sous-ensemble commençant à <startindex> et la longueur de <points>.

Paramètre	Renvoitype
[<startindex>] l'index de départ [<points>] le nombre de points	<valeur CC>
Renvoie le courant CC mesuré : FETC:CURR?	

**FETCh[:SCALar]:CURRent:ACDC?**

**FETCh[:SCALar]:VOLTage:ACDC?**

Renvoie la mesure de valeur efficace vraie (CA + CC). Les valeurs renvoyées sont exprimées en ampères ou en volts.

Paramètre	Renvoitype
(aucun)	<valeur CACC>
Renvoie la tension efficace mesurée : FETC:VOLT:ACDC?	

**FETCh[:SCALar]:CURRent:HIGH?**

**FETCh[:SCALar]:VOLTage:HIGH?**

Renvoie le niveau élevé d'un signal d'impulsion. Les valeurs renvoyées sont exprimées en ampères ou en volts. Voir **Types de mesure**.

Paramètre	Renvoitype
(aucun)	<valeur HIGH>
Renvoie le courant de niveau élevé mesuré : FETC:CURR:HIGH?	

**FETCh[:SCALar]:CURRent:LOW?**  
**FETCh[:SCALar]:VOLTage:LOW?**

Renvoie le niveau faible d'un signal d'impulsion. Les valeurs renvoyées sont exprimées en ampères ou en volts. Voir **Types de mesure**.

Paramètre	Renvoi type
(aucun)	<valeur LOW>
Renvoie la tension de niveau faible mesurée : FETC:VOLT:LOW?	

**FETCh[:SCALar]:CURRent:MAXimum?**  
**FETCh[:SCALar]:CURRent:MINimum?**  
**FETCh[:SCALar]:POWer:MAXimum]?**  
**FETCh[:SCALar]:POWer:MINimum]?**  
**FETCh[:SCALar]:VOLTage:MAXimum?**  
**FETCh[:SCALar]:VOLTage:MINimum?**

Renvoie la valeur maximale ou minimale. Les valeurs renvoyées sont exprimées en volts ou en watts.

Paramètre	Renvoi type
(aucun)	<valeur MIN> <valeur MAX>
Renvoie le courant maximal mesuré : FETC:CURR:MAX?	
Renvoie la tension minimale mesurée : FETC:VOLT:MIN?	
Renvoie la puissance maximale mesurée : FETC:POW:MAX?	

**FETCh:AHOuR? [IGNORE\_OVLD]**  
**FETCh:WHOUr? [IGNORE\_OVLD]**

FETCh:AHOuR? - Renvoie les ampères-heures cumulés.

FETCh:WHOUr? - Renvoie les watts-heures cumulés.

Pour de plus amples informations, reportez-vous à la section **Mesures en ampères-heures et en watts-heures**.

Si un échantillon de mesure est supérieur à la plage, la requête renvoie le message « SCPI Not a Number (9.91E37) » (SCPI - N'est pas un nombre (9,91E37)). Si le paramètre facultatif IGNORE\_OVLD est envoyé, la mesure cumulée est renvoyée, même si certains échantillons étaient hors de la plage de mesure.

Paramètre	Renvoi type
IGNORE_OVLD ignore les mesures de surcharge	<amp-heures> <watts-heures>

Paramètre	Renvoi type
Renvoie la mesure en ampères-heures : <code>FETC:AHO?</code>	
Renvoie la mesure en watts-heures : <code>FETC:WHO?</code>	

**`FETCh:ARRay:CURRent[:DC]? [<start_index>, <points>]`**

**`FETCh:ARRay:POWer[:DC]? [<start_index>, <points>]`**

**`FETCh:ARRay:VOLTage[:DC]? [<start_index>, <points>]`**

Renvoie la mesure instantanée. Les valeurs renvoyées sont exprimées en volts ou en watts.

Les paramètres facultatifs indiquent un sous-ensemble commençant à <startindex> et la longueur de <points>.

Le format de retour varie selon les paramètres des commandes `FORMat:BORDER` et `FORMat[:DATA]`. Si le format de données est défini sur ASCII, les valeurs renvoyées sont séparées par des virgules. Si le format de données est défini sur REAL, les données sont renvoyées sous forme de valeurs à virgule flottante simple précision au format de réponse de bloc arbitraire de taille définie.

Paramètre	Renvoi type
[<startindex>] l'index de départ	<valeur> [, <valeur>]
[<points>] le nombre de points	ou <Bloc>

Renvoie le tableau de courant mesuré : `FETC:ARR:CURR?`

**`FETCh:ELOG? <nbre max d'enregistrements>`**

Renvoie les enregistrements de données externes les plus récents. Les données doivent être lues régulièrement à partir de la mémoire tampon pour éviter toute saturation de la mémoire tampon. Chaque fois que les données sont lues à l'aide de la commande `FETCh:ELOG?`, cet espace tampon est mis à la disposition de l'instrument pour stocker une plus grande quantité de données acquises.

Nbre max d'enregistrements correspond au nombre maximal d'enregistrements de données d'enregistrement renvoyés par le contrôleur.

Le format de retour varie selon les paramètres des commandes `FORMat:BORDER` et `FORMat[:DATA]`. Si le format de données est défini sur ASCII, les valeurs renvoyées sont séparées par des virgules. Si le format de données est défini sur REAL, les données sont renvoyées sous forme de valeurs à virgule flottante simple précision au format de réponse de bloc arbitraire de taille définie.

Paramètre	Renvoi type
[<nbre max d'enregistrements>] nombre d'enregistrements renvoyés (1 à 16 384)	<valeur> [, <valeur>] ou <Bloc>

Renvoie jusqu'à 100 enregistrements de données `FETC:ELOG? 100`



## Sous-système FORMat

Les commandes FORMat permettent de spécifier le format de transfert des données de mesure.

### FORMat[:DATA] ASCII|REAL FORMat[:DATA]?

Indique le format des données renvoyées. Ces commandes sont utilisées par des requêtes capables de renvoyer un bloc de données. **ASCII** renvoie des données sous forme d'octets ASCII dans un format numérique, le cas échéant. Les nombres sont séparés par des virgules. **REAL** renvoie les données dans un bloc de longueur définie sous forme de valeurs à virgule flottante simple précision IEEE. Dans ce cas, les 4 octets de chaque valeur peuvent être renvoyés avec un ordre d'octets de poids fort (Big Endian) ou de poids faible (Little Endian), déterminé par le paramètre FORMat:BORDER.

Paramètre	Renvoi type
ASCII REAL, *RST ASCII	ASCII ou REAL
Définit le format de données sur ASCII : FORMat ASCII	

- Le format de données est utilisé par un petit sous-ensemble de requêtes pouvant renvoyer des quantités importantes de données.

### FORMat:BORDER NORMal|SWAPped FORMat:BORDER?

Indique comment les données binaires sont transférées. Cette commande ne s'applique que si FORMat:DATA est défini sur REAL. **NORMal** transfère les données dans un ordre normal. L'octet le plus significatif est renvoyé en premier, et l'octet le moins significatif en dernier (gros-boutiste). **SWAPped** transfère les données dans un ordre d'octets inversés. L'octet le moins significatif est renvoyé en premier, et l'octet le plus significatif en dernier (petit-boutiste).

Paramètre	Renvoi type
NORMal SWAPped, *RST NORMal	NORM ou SWAP
Définit le transfert de données sur Swapped (Inversé) : FORM:BORDER SWAP	

- L'ordre des octets est utilisé lors de la récupération des données réelles à partir des mesures SCPI.

## Commande FUNCTION

**[SOURce:]FUNCTION CURRent|VOLTage**  
**[SOURce:]FUNCTION?**

Définit la régulation de sortie : priorité de tension ou priorité de courant. En mode de priorité de tension, la sortie est contrôlée par une boucle de rétroaction à tension constante, qui maintient la tension de sortie à sa valeur programmée. En mode de priorité de courant, la sortie est contrôlée par une boucle de rétroaction à courant constant, qui maintient le courant de sortie à sa valeur programmée positive ou négative.

Pour de plus amples informations, reportez-vous à la section [Didacticiel du mode de priorité](#).

Paramètre	Renvoi type
CURRent VOLTage, *RST VOLTage	CURR ou VOLT
Définit la régulation de sortie en mode de priorité de courant: <code>FUNC CURR</code>	

## Sous-système HCOPy

Les commandes HCOPy permettent de renvoyer une image de l'écran.

### HCOPy:SDUMp:DATA? [BMP|GIF|PNG]

Renvoie une image de l'écran du panneau avant. Le format peut être spécifié par le paramètre facultatif. Si aucun format n'est spécifié, le format est déterminé par la commande HCOPy:SDUMp:DATA:FORMat.

La réponse est un bloc binaire de taille définie SCPI 488.2 au format suivant : #<chiffre différent de zéro><chiffres><octets de données 8 bits>, où :

<chiffre différent de zéro> indique le nombre de chiffres à suivre,  
<chiffres> indiquent le nombre d'octets de données 8 bits à suivre et  
<octets de données 8 bits> contient les données à transférer.

Paramètre	Renvoitype
[BMP GIF PNG]	<Bloc>
Renvoie l'image au format GIF : HCOP:SDUM:DATA? GIF	

### HCOPy:SDUMp:DATA:FORMat BMP|GIF|PNG

#### HCOPy:SDUMp:DATA:FORMat?

Spécifie le format des images du panneau avant renvoyées.

Paramètre	Renvoitype
BMP GIF PNG, *RST PNG	BMP, GIF ou PNG
Indique le format d'image GIF : HCOP:SDUM:DATA:FORM GIF	

## Commandes courantes IEEE-488

Les commandes courantes IEEE-488 contrôlent généralement les fonctions globales de l'instrument, telles que la réinitialisation, l'état et la synchronisation. Toutes les commandes courantes comprennent un code mnémonique composé de trois lettres et précédé d'un astérisque : \*RST \*IDN? \*SRE 8.

### \*CLS

Commande d'effacement de l'état. Commande d'effacement de l'état. Efface les **registres d'événements** de tous les groupes de registres. Efface également l'octet d'état et la file d'attente d'erreurs. Si la commande \*CLS suit immédiatement un caractère de fin de message de programme (<NL>), la file de sortie et le bit MAV sont également effacés. Pour de plus amples informations, reportez-vous à la section **Didacticiel d'état**.

Paramètre	Renvoi type
(aucun)	(aucun)
Effacer les registres d'événements, l'octet d'état et la file d'attente d'erreurs : *CLS	

### \*ESE <valeur>

#### \*ESE?

Commande et requête d'activation de l'état des événements. Définit la valeur du **registre d'activation** pour le groupe **État des événements standard**. Chaque bit activé du registre active un événement correspondant. Tous les événements activés sont conditionnés par l'opérateur OR (OU) de façon logique dans le bit ESB de l'octet d'état. La requête lit le registre d'activation. Pour de plus amples informations, reportez-vous à la section **Didacticiel d'état**.

Paramètre	Renvoi type
Valeur décimale correspondant à la somme binaire pondérée des bits du registre.	<valeur de bit>
Activer les bits 3 et 4 dans le registre d'activation : *ESE 24	

- La valeur renvoyée correspond à la somme binaire pondérée de tous les bits activés du registre. Par exemple, lorsque le bit 2 (valeur 4) et le bit 4 (valeur 16) sont définis, la requête renvoie +20.
- Une ou toutes les conditions peuvent être reportées dans le bit ESB au moyen du registre d'activation. Pour activer le masque du registre d'activation, écrivez une valeur décimale dans le registre avec la commande \*ESE.
- La commande \*CLS n'efface que le **registre des événements**, pas le registre d'activation.

### \*ESR?

Requête d'événement de l'état des événements. Lit et efface le **registre des événements** du groupe **État des événements standard**. Le registre des événements est un registre en lecture seule qui

verrouille tous les événements standard. Pour de plus amples informations, reportez-vous à la section **Didacticiel d'état**.

Paramètre	Renvoi type
(aucun)	<valeur de bit>

Lire le registre d'activation de l'état des événements : **\*ESR?**

- La valeur renvoyée correspond à la somme binaire pondérée de tous les bits activés du registre.
- Une ou toutes les conditions peuvent être reportées dans le bit ESB au moyen du registre d'activation. Pour activer le masque du registre d'activation, écrivez une valeur décimale dans le registre avec la commande \*ESE.
- Lorsqu'un bit est activé, il ne change pas jusqu'à son effacement par cette requête ou la commande \*CLS.

### \*IDN?

Requête d'identification. Renvoie la chaîne d'identification de l'instrument, qui contient quatre champs séparés par des virgules. Le premier champ est le nom du fabricant, le deuxième champ est le numéro de modèle de l'instrument, le troisième champ est le numéro de série et le quatrième champ est la version du microprogramme.

Paramètre	Renvoi type
(aucun)	Keysight Technologies,RP7972A,MY12345678,A.01.01

Renvoyer la chaîne d'identification de l'instrument : **\*IDN?**

### \*OPC

Active le bit OPC (opération terminée) dans le registre des événements standard. Cela se produit à la fin de l'opération en attente. Pour de plus amples informations, reportez-vous à la section **Didacticiel d'état**.

Paramètre	Renvoi type
(aucun)	(aucun)

Régler le bit d'opération terminée : **\*OPC**

- Cette commande vise à synchroniser votre application avec l'appareil.
- Utilisée en combinaison avec les acquisitions initialisées, les transitoires, les modifications de l'état de sortie et le temps de stabilisation de la sortie pour fournir un moyen d'interroger ou d'interrompre l'ordinateur une fois ces opérations en attente terminées.
- Les autres commandes peuvent être exécutées avant que le bit d'opération terminée ne soit positionné.

- La différence entre les commandes \*OPC et \*OPC? est que \*OPC? renvoie « 1 » dans la mémoire tampon de sortie lorsque l'opération est terminée.

### \*OPC?

Renvoie la valeur 1 dans le tampon de sortie une fois toutes les opérations en attente terminées. La réponse est différée jusqu'à ce que toutes les opérations en attente soient terminées.

Paramètre	Renvoi type
(aucun)	1
Renvoyer la valeur 1 une fois les commandes terminées : *OPC?	

- Cette commande vise à synchroniser votre application avec l'appareil.
- Les autres commandes ne peuvent être exécutées tant que cette commande n'est pas terminée.

### \*OPT?

Renvoie une chaîne identifiant toutes les options installées. La valeur 0 (zéro) indique qu'aucune option n'est installée.

Paramètre	Renvoi type
(aucun)	OPT 760
Renvoie les options installées : *OPT?	

### \*RCL <0-9>

Rappelle un état d'instrument enregistré. Cette commande permet de réinitialiser l'instrument à un état qui a été précédemment enregistré aux emplacements 0 à 9 à l'aide de la commande \*SAV. Tous les états de l'instrument sont rappelés à l'exception des états suivants : (1) l'état de la sortie est réglé sur OFF (DÉSACTIVÉ), (2) les systèmes de déclenchement sont définis à l'état Idle (Inactif), (3) l'étalonnage est désactivé, (4) toutes les listes sont définies à leurs valeurs \*RST et (5) les réglages non volatiles ne sont pas affectés.

Paramètre	Renvoi type
0 - 9	(aucun)
Rappeler l'état à partir de l'emplacement 1 : *RCL 1	

- L'emplacement 0 est automatiquement rappelé à la mise sous tension lorsque l'état d'activation de la sortie est défini sur RCL 0.
- Les états de l'instrument enregistrés ne sont pas affectés par la commande \*RST.

**\*RST**

Rétablit les valeurs prédéfinies de l'instrument qui sont des valeurs types ou sûres. Ces réglages sont décrits dans la section **État de réinitialisation**.

Paramètre	Renvoi type
(aucun)	(aucun)
Réinitialiser l'instrument : *RST	

- \*RST force l'exécution des commandes ABORt. Toute action de mesure ou de transitoire actuellement en cours est alors annulée. Elle réinitialise les bits WTG-mes, MES-active, WTG-tran et TRAN-actif dans les registres d'état de fonctionnement.

**\*SAV <0-9>**

Enregistre l'état de l'instrument à l'un des dix emplacements de mémoire non volatile. Pour des raisons de sécurité, lorsqu'un état enregistré est rappelé, l'état de sortie sera réglé sur OFF (DÉSACTIVÉ).

Paramètre	Renvoi type
0 - 9	(aucun)
Enregistrer l'état à l'emplacement 1 : *SAV 1	

- Si un état particulier est souhaité lors de la mise sous tension, il doit être stocké à l'emplacement 0. L'emplacement 0 est automatiquement rappelé à la mise sous tension lorsque l'état d'activation de la sortie est défini sur RCL 0.
- L'état de sortie, les données de liste et l'état d'étalonnage ne sont PAS enregistrés dans le cadre de l'opération \*SAV.
- Les données enregistrées dans la mémoire non volatile, décrites dans la section **Réglages non volatiles**, ne sont pas affectées par la commande \*SAV.
- Par défaut, les emplacements 0 à 9 sont vides.

**\*SRE <valeur>****\*SRE?**

Commande et requête d'activation des demandes de service. Cette commande permet de définir la valeur du registre d'activation de demande de service. Elle détermine les bits du **registre de l'octet d'état** qui sont récapitulés pour activer le bit récapitulatif MMS (Master Status Summary, récapitulatif d'état général) et RQS (Request for Service, demande de service). La position 1 dans un bit du registre d'activation de demande de service permet d'activer le bit de registre d'octet d'état correspondant. Tous les bits activés sont ensuite conditionnés par l'opérateur OR de façon logique pour provoquer l'activation du bit MSS du registre de l'octet d'état. Pour de plus amples informations, reportez-vous à la section **Didacticiel d'état**.

Paramètre	Renvoi type
Valeur décimale correspondant à la somme binaire pondérée des bits du registre.	<valeur de bit>
Activer les bits 3 et 4 dans le registre d'activation : *SRE 24	

- Si une interrogation série est effectuée en réponse à SRQ, le bit RQS est effacé, mais le bit MSS est conservé. Si la commande \*SRE est effacée (en la programmant avec la valeur 0), l'alimentation ne peut pas générer de SQR.

### \*STB?

Requête de l'octet d'état. Lit le **registre de l'octet d'état**, qui contient les bits récapitulatifs d'état et le bit MAV de la file de sortie. L'octet d'état est un registre en lecture seule et les bits ne sont pas effacés lorsqu'ils sont lus. Pour de plus amples informations, reportez-vous à la section **Didacticiel d'état**.

Paramètre	Renvoi type
(aucun)	<valeur de bit>
Lire l'octet d'état : *STB?	

### \*TRG

Commande de déclenchement. Génère un événement de déclenchement lorsque le sous-système de déclenchement a sélectionné la source BUS. La commande produit le même résultat que la commande <GET> (Group Execute Trigger) de déclenchement d'exécution de groupe.

Paramètre	Renvoi type
(aucun)	(aucun)
Génère un déclenchement immédiat : *TRG	

### \*TST?

Requête d'autotest. Effectue un autotest de l'instrument. Si l'autotest échoue, un ou plusieurs messages d'erreur fournissent des informations complémentaires. Utilisez SYSTEM:ERRor? pour lire la file d'erreurs. Pour de plus amples informations, reportez-vous à la section **Messages d'erreur SCPI**.

Paramètre	Renvoi type
(aucun)	0 (réussi) ou +1 (échoué)
Effectuer un autotest : *TST?	



## 5 Aide-mémoire de la programmation SCPI

- L'autotest de mise sous tension est le même autotest exécuté par la commande \*TST.
- \*TST? force également l'exécution d'une commande \*RST.

### **\*WAI**

Interrompt momentanément le traitement des commandes supplémentaires jusqu'à ce que toutes les opérations en attente soient terminées. Pour de plus amples informations, voir **OPC**.

Paramètre	Renvoi type
(aucun)	(aucun)
Patienter jusqu'à la fin de toutes les opérations en attente. *WAI	

- La commande \*WAI ne peut être annulée qu'en envoyant une commande Device Clear à l'instrument.

## Sous-système INITiate

Les commandes Initiate initialisent le système de déclenchement. Elles font basculer le système de déclenchement de l'état « idle » à l'état « wait-for-trigger », permettant ainsi à l'instrument de recevoir des signaux de déclenchement. Un événement sur la source de déclenchement sélectionnée provoque un déclenchement.

### INITiate[:IMMEDIATE]:ACQUIRE

### INITiate[:IMMEDIATE]:ELOG

### INITiate[:IMMEDIATE]:TRANSIENT

INITiate:ACQUIRE - Démarre le système de déclenchement de mesure.

INITiate:ELOG - Démarre l'enregistrement de données externe.

INITiate:TRANSIENT - Démarre le système de déclenchement de transitoire.

Paramètre	Renvoitype
(aucun)	(aucun)
Démarrer le système de déclenchement de mesure : <code>INIT:ACQ</code>	

- Il suffit de quelques secondes à l'instrument pour se préparer à recevoir un signal de déclenchement après avoir reçu la commande INITiate.
- Si un déclenchement se produit avant que le système de déclenchement soit prêt, le déclenchement est ignoré. Vérifiez l'octet WTG\_mes dans le registre d'état de fonctionnement pour savoir quand l'instrument est prêt.
- Les commandes ABORT permettent de renvoyer l'instrument à l'état inactif.

### INITiate:CONTInuous:TRANSient 0|OFF|1|ON

### INITiate:CONTInuous:TRANSient?

Démarre continuellement le système de déclenchement de transitoire. Cette commande permet à plusieurs déclenchements de générer plusieurs transitoires de sortie.

Paramètre	Renvoitype
0 OFF 1 ON, *RST ON	0 ou 1
Démarre continuellement le système de déclenchement de sortie : <code>INIT:CONT:TRAN ON</code>	

- Lorsque la fonction de démarrage continu est désactivée, le système de déclenchement de sortie doit être démarré pour chaque déclenchement à l'aide de la commande INITiate:TRANSient.
- ABORT:TRANSient ne désactive pas les déclenchements continus si la commande INITiate:CONTInuous:TRANSient ON a été programmée. Dans ce cas, désactivez d'abord les déclenchements continus avant d'envoyer la commande ABORT.

## Sous-système INSTRument

Les commandes de l'instrument programment la fonction principale/secondaire de l'instrument. Le fonctionnement en mode principal/secondaire est utilisé lors de la connexion d'un certain nombre d'instruments en parallèle pour créer un système avec un courant total plus élevé et, par conséquent, une puissance supérieure.

**REMARQUE** Dans ce document, les termes « maître » et « esclave » ont été remplacés par les termes « principal » et « secondaire ». La syntaxe de commande du sous-système INSTRument de la version précédente du microprogramme est toujours prise en charge dans cette version et dans les versions ultérieures.

### INSTRument:GROup:FUNCTion PRIMary|SECondary|NONE INSTRument:GROup:FUNCTion?

Définissez la fonction d'un instrument dans une configuration principale/secondaire. Ce réglage est enregistré dans la mémoire non volatile.

**PRIMary** : configure l'instrument comme appareil principal dans un groupe principal/secondaire.

**SECondary** : configure l'instrument comme appareil secondaire dans un groupe principal/secondaire.

**NONE** : désactive la fonction principale/secondaire. L'appareil fonctionne de manière indépendante.

Paramètre	Renvoi type
PRIMary SECondary NONE	PRIM, SEC ou NONE
Configure l'instrument en tant que principal <b>INST:GRO:FUNC:PRIM</b>	

### INSTRument:GROup:PRIMary:CONNect[:STATe] [,0|OFF|1|ON]

Indique à l'appareil principal de se connecter à tous les appareils secondaires précédemment découverts. Si la configuration du secondaire sur le bus correspond à celle qui est découverte, le principal démarrera en fonctionnement normal. Sinon, la commande échouera avec une erreur, et tous les appareils fonctionneront de manière indépendante.

Paramètre	Renvoi type
0 OFF 1 ON en option	0 ou 1
Connectez le principal aux appareils secondaires <b>INST:GRO:PRIM:CONN</b>	

### INSTRument:GROup:PRIMary:CONNect:DELay <valeur>|MIN|MAX INSTRument:GROup:PRIMary:CONNect:DELay? [{MIN|MAX}]

Réglez le délai après la mise sous tension avant que les appareils principaux ne tentent de se connecter aux appareils secondaires. Cette opération ne s'applique que si le mode de connexion est réglé sur AUTO. Ce réglage est enregistré dans la mémoire volatile.

Paramètre	Renvoi type
0 à 120 secondes	0
Configure le délai de connexion pendant 10 secondes <code>INST:GRO:PRIM:CONN:DEL 10</code>	

### **INSTrument:GROup:PRIMary:CONNect:MODE AUTO|MANual INSTrument:GROup:PRIMary:CONNect:MODE?**

Spécifie le mode de connexion de l'appareil principal. Ce réglage est enregistré dans la mémoire non volatile.

**AUTO** : l'appareil principal essaie de se connecter aux appareils précédemment découverts lors de la mise sous tension.

**MANual** : le principal se connecte aux esclaves précédemment découverts quand il reçoit une commande de connexion du panneau avant ou de `INST:GROUP:PRIM:CONN`.

Paramètre	Renvoi type
AUTO MANual	AUTO ou MAN
Spécifie le mode de connexion automatique <code>INST:GRO:PRIM:CONN:MODE AUTO</code>	

### **INSTrument:GROup:PRIMary:DISCover**

Indique à l'appareil principal de découvrir tous les appareils secondaires connectés au bus principal/secondaire.

Paramètre	Renvoi type
(aucun)	(aucun)
Découvrez tous les appareils secondaires <code>INST:GRO:PRIM:DISC</code>	

### **INSTrument:GROup:PRIMary:RESet**

Réinitialise la configuration du secondaire découvert par le principal. Cela déconnecte les appareils connectés par le secondaire et les remet en fonctionnement indépendant.

Paramètre	Renvoi type
(aucun)	(aucun)
Réinitialise tous les appareils secondaires <code>INST:GRO:PRIM:RES</code>	

### **INSTrument:GROup:SECondary:ADDRess <valeur>**

Définit l'adresse du bus de l'appareil secondaire. Chaque appareil secondaire un groupe principal/secondaire doit avoir une adresse de bus unique ou la communication du bus échoue. Ce réglage est enregistré dans la mémoire non volatile.

## 5 Aide-mémoire de la programmation SCPI

Paramètre	Renvoi type
1 - 19	1
Définit l'adresse de l'appareil secondaire sur 1 INST:GRO:SEC:ADDR 1	

## Sous-système LIST

Les commandes List permettent de programmer une séquence de plusieurs réglages de tension ou de courant en sortie. Vous pouvez programmer une liste délimitée par des virgules et contenant jusqu'à 512 paliers. Notez que ces commandes s'appliquent uniquement au mode de priorité actuellement actif, priorité de tension ou priorité de courant.

**[SOURce:]LIST:COUNT <valeur>|MIN|MAX|INFinity**  
**[SOURce:]LIST:COUNT? [{MIN|MAX}]**

Définit le nombre de répétitions de la liste. Cette commande permet de définir le nombre de fois qu'une liste est exécutée avant de se terminer. La plage de nombres est comprise entre 1 et 4096. Infinity exécute la liste en permanence.

Paramètre	Renvoi type
1 – 4096, *RST 1	<nombre>
Définit le comptage de liste à 10 : LIST:COUN 10	

**[SOURce:]LIST:CURREnt[:LEVel] <valeur>{,<valeur>}**  
**[SOURce:]LIST:CURREnt[:LEVel]?**  
**[SOURce:]LIST:VOLTage[:LEVel] <valeur>{,<valeur>}**  
**[SOURce:]LIST:VOLTage[:LEVel]?**

Indique le réglage de chaque palier de liste. Les valeurs sont exprimées en ampères ou en volts.

Paramètre	Renvoi type
Voltage (Tension) : 0 à 102 % de la valeur nominale Current (Courant) : -102 à 102 % de la valeur nominale	<valeur de liste 1>,<valeur de liste 2>,<valeur de liste 3>
Programme une liste de courant. Cette liste contient 3 paliers : LIST:CURR 3,2,1 Programme une liste de tension. Cette liste contient 3 paliers : LIST:VOLT 20,10,5	

**[SOURce:]LIST:DWELL <valeur>{,<valeur>}**  
**[SOURce:]LIST:DWELL?**

Indique la durée de chaque palier de liste. La durée de palier correspond à la durée pendant laquelle la sortie demeure sur un palier spécifique. Les durées de palier peuvent être programmées entre 0 et 262,144 secondes avec la résolution suivante :

Plage en secondes	Résolution
0 - 0,262144	1 microseconde
0,262144 - 2,62144	10 microsecondes

## 5 Aide-mémoire de la programmation SCPI

Plage en secondes	Résolution
2,62144 - 26,2144	100 microsecondes
26,2144 - 262,144	1 milliseconde

Paramètre	Renvoi type
0 à 262.144, *RST 1 ms	<valeur de liste 1>, <valeur de liste 2>, <valeur de liste 3>
Programme une liste de paliers. Cette liste contient 3 paliers : LIST:DWEL 0.2,0.8,1.6	

**[SOURCE:]LIST:CURRENT:POINTS?**

**[SOURCE:]LIST:DWELL:POINTS?**

**[SOURCE:]LIST:VOLTAGE:POINTS?**

**[SOURCE:]LIST:TOUTput:BOStep:POINTS?**

**[SOURCE:]LIST:TOUTput:EOStep:POINTS?**

Renvoie le nombre de points dans la liste spécifiée. Les points sont identiques à des paliers. Les requêtes ne renvoient pas les valeurs de point.

Paramètre	Renvoi type
(aucun)	<points>
Renvoie le nombre de points dans la liste de paliers : LIST:DWEL:POIN?	

**[SOURCE:]LIST:STEP ONCE|AUTO**

**[SOURCE:]LIST:STEP?**

Précise le rythme de déclenchement ou d'arrêt de la liste.

**ONCE** permet de maintenir la sortie sur le palier actuel jusqu'à ce qu'un événement de déclenchement passe au palier suivant. Les déclenchements qui surviennent pendant la durée de palier sont ignorés.

**AUTO** permet de faire passer automatiquement la sortie à chaque palier, une fois l'événement de déclenchement de démarrage initial reçu. Les paliers sont cadencés par la liste de paliers. À l'expiration de chaque durée de palier, le palier suivant est immédiatement généré.

Paramètre	Renvoi type
ONCE AUTO, *RST AUTO	ONCE ou AUTO
Indique que les paliers de liste doivent être cadencés par des signaux de déclenchement : LIST:STEP ONCE	

**[SOURCE:]LIST:TERMinate:LAST 0|OFF|1|ON**

**[SOURCE:]LIST:TERMinate:LAST?**

Détermine la valeur de sortie lorsque la liste s'arrête. Si cette commande est activée (1), la tension ou le courant de sortie est maintenu sur le dernier palier de liste. La valeur du dernier palier de liste de

tension ou de courant devient la valeur IMMEDIATE une fois la liste terminée. Si elle est désactivée (0) ou que la liste est interrompue, les réglages de la sortie qui étaient appliqués avant le démarrage de la liste sortie sont rétablis.

Paramètre	Renvoitype
0 OFF 1 ON, *RST OFF	0 ou 1
Interrompt avec la sortie sur la dernière valeur de palier : LIST:TERM:LAST ON	

**[SOURce:]LIST:TOUTput:BOSTep[:DATA] 0|OFF|1|ON {,0|OFF|1|ON}**

**[SOURce:]LIST:TOUTput:BOSTep[:DATA]?**

**[SOURce:]LIST:TOUTput:EOSTep[:DATA] 0|OFF|1|ON {,0|OFF|1|ON}**

**[SOURce:]LIST:TOUTput:EOSTep[:DATA]?**

Spécifie les paliers de liste qui génèrent un signal de déclenchement au début du palier (BOSTep) ou à la fin du palier (EOSTep). Un événement de déclenchement n'est généré que si l'état est défini sur ON. Le signal de déclenchement peut être utilisé comme source de déclenchement pour les mesures et les transitoires d'autres appareils et pour les broches de port numérique configurées comme sorties de déclenchement.

Paramètre	Renvoitype
0 OFF 1 ON	0 ou 1
Générer des événements de déclenchement au début du deuxième palier d'une liste à 3 paliers : LIST:TOUT:BOST OFF,ON,OFF	



**Sous-système LXI****LXI:IDENTify[:STATe] 0|OFF|1|ON****LXI:IDENTify[:STATe]?**

Allume ou éteint le voyant d'identification LXI du panneau avant. Lorsque cette commande est activée, le voyant d'état « LAN » situé sur le panneau avant clignote pour identifier l'instrument en cours de traitement.

Paramètre	Renvoitype
0 OFF 1 ON, *RST OFF	0 ou 1
Pour faire clignoter le voyant LXI du panneau avant : LXI:IDENT ON	

**LXI:MDNS[:STATe] 0|OFF|1|ON****LXI:MDNS[:STATe]?**

Définit l'état activé ou désactivé MDNS.

Paramètre	Renvoitype
0 OFF 1 ON, *RST OFF	0 ou 1
Définit l'état activé MDNS : LXI:MDNS ON	

## Sous-système MEASure

Les commandes Measure permettent de mesurer la tension ou le courant de sortie. Elles déclenchent l'acquisition de nouvelles données avant de renvoyer la lecture. Les mesures sont effectuées en numérisant la tension ou le courant de sortie instantané pendant une période de mesure spécifiée, en enregistrant les résultats dans une mémoire tampon et en calculant la valeur du type de mesure spécifié.

### MEASure[:SCALar]:CURRent[:DC]?

### MEASure[:SCALar]:POWer[:DC]?

### MEASure[:SCALar]:VOLTage[:DC]?

Initialise, déclenche et renvoie la moyenne de la mesure de sortie. Les valeurs renvoyées sont exprimées en volts ou en watts.

Paramètre	Renvoi type
(aucun)	<valeur CC>
Renvoie le courant CC mesuré : MEAS:CURR?	

### MEASure[:SCALar]:CURRent:ACDC?

### MEASure[:SCALar]:VOLTage:ACDC?

Initialise, déclenche et renvoie la mesure de valeur efficace vraie totale (CA + CC). Les valeurs renvoyées sont exprimées en ampères ou en volts.

Paramètre	Renvoi type
(aucun)	<valeur CACC>
Renvoie la tension efficace mesurée : MEAS:VOLT:ACDC?	

### MEASure[:SCALar]:CURRent:HIGH?

### MEASure[:SCALar]:VOLTage:HIGH?

Initialise, déclenche et renvoie le niveau High (Élevé) d'un signal d'impulsion. Les valeurs renvoyées sont exprimées en ampères ou en volts. Voir [Types de mesure](#).

Paramètre	Renvoi type
(aucun)	<valeur HIGH>
Renvoie le courant de niveau élevé mesuré : MEAS:CURR:HIGH?	

**MEASure[:SCALar]:CURRent:LOW?**  
**MEASure[:SCALar]:VOLTage:LOW?**

Initialise, déclenche et renvoie le niveau Low (Faible) d'un signal d'impulsion. Les valeurs renvoyées sont exprimées en ampères ou en volts. Voir **Types de mesure**.

Paramètre	Renvoi type
(aucun)	<valeur LOW>
Renvoie la tension de niveau faible mesurée : MEAS:VOLT:LOW?	

**MEASure[:SCALar]:CURRent:MAXimum?**  
**MEASure[:SCALar]:CURRent:MINimum?**  
**MEASure[:SCALar]:POWer:MAXimum?**  
**MEASure[:SCALar]:POWer:MINimum?**  
**MEASure[:SCALar]:VOLTage:MAXimum?**  
**MEASure[:SCALar]:VOLTage:MINimum?**

Initialise, déclenche et renvoie les valeurs maximale ou minimale d'une mesure. Les valeurs renvoyées sont exprimées en volts ou en watts.

Paramètre	Renvoi type
(aucun)	<valeur MIN>, <valeur MAX>
Renvoie le courant maximal mesuré : MEAS:CURR:MAX?	
Renvoie la tension minimale mesurée : MEAS:VOLT:MIN?	
Renvoie la puissance maximale mesurée : MEAS:POW:MAX?	

**MEASure:ARRay:CURRent[:DC]?**  
**MEASure:ARRay:POWer[:DC]?**  
**MEASure:ARRay:VOLTage[:DC]?**

Initialise et déclenche une mesure ; renvoie une liste des échantillons de mesure de sortie numérisés. Les valeurs renvoyées sont exprimées en volts ou en watts.

Le format de retour varie selon les paramètres des commandes FORMat:BORDER et FORMat[:DATA]. Si le format de données est défini sur ASCII, les valeurs renvoyées sont séparées par des virgules. Si le format de données est défini sur REAL, les données sont renvoyées sous forme de valeurs à virgule flottante simple précision au format de réponse de bloc arbitraire de taille définie.

Paramètre	Renvoi type
(aucun)	<valeur> [, <valeur>] ou <Bloc>
Renvoie le tableau de courant mesuré : MEAS:ARR:CURR?	

## Sous-système OUTPut

Le sous-système Output contrôle l'état, la mise sous tension, la protection et les fonctions de relais des sorties.

### OUTPut [:STATe] 0|OFF|1|ON OUTPut[STATe]?

#### AVERTISSEMENT

**RISQUE D'ÉLECTROCUTION, TENSION LÉTALES** De nombreux modèles génèrent des tensions allant jusqu'à 2 000 V CC ! Assurez-vous que toutes les connexions des instruments, le câblage de charge ainsi que les connexions de charge et de mesure sont isolés à l'aide de fils haute tension. Fixez toujours le capot de sécurité fourni, de sorte qu'aucun contact accidentel avec des tensions mortelles ne puisse se produire.

Active ou désactive la sortie. L'état d'une sortie désactivée est une condition de tension de sortie et de courant source zéro.

Paramètre	Renvoi type
0 OFF 1 ON, *RST OFF	0 ou 1
Désactive la sortie : <code>OUTP OFF</code>	

- Lorsque la sortie est activée, le voyant d'état du panneau avant quitte l'état **OFF** pour indiquer l'état de fonctionnement de l'instrument (**CV**, **CC**, etc.).
- Des délais séparés peuvent être programmés pour la transition désactivé-activé et activé-désactivé à l'aide des commandes `OUTPut:DELay:RISE` et `OUTput:DELay:FALL`.
- En raison des procédures de démarrage de circuit internes, la commande `OUTPut ON` peut mettre 8 millisecondes à s'exécuter en mode de priorité de tension, et 7 millisecondes en mode de priorité de courant.

### OUTPut[:STATe]:COUPlé[:STATe] 0|OFF|1|ON OUTPut[:STATe]:COUPlé[:STATe]?

Active ou désactive la fonction de couplage des sorties. La fonction de couplage des sorties permet d'activer et de désactiver de façon séquentielle les sorties de plusieurs instruments sur leurs relais de programmation `OUTPut:DELay:RISE` et `OUTput:DELay:FALL` spécifiés. Ces paramètres sont enregistrés dans la mémoire non volatile.

Paramètre	Renvoi type
0 OFF 1 ON	0 ou 1
Active l'état de couplage des sorties : <code>OUTP:COUP ON</code>	

- Vous devez connecter et configurer les broches du connecteur numérique `ONCouple` et `OFFCouple` de tous les instruments synchronisés comme décrit à la section **Commande de couplage des sorties**.

- En raison des différents décalages de délai minimum de certains modules d'alimentation, vous devez également spécifier un décalage de délai commun pour tous les appareils synchronisés. Cette valeur doit être le décalage de délai le plus important du groupe synchronisé. Utilisez la commande `OUTPut:COUPle:MAX:DOFFset?` pour obtenir le décalage de délai de chaque appareil. La valeur la plus élevée renvoyée doit être spécifiée comme décalage de délai commun pour chaque appareil.

### **OUTPut[:STATe]:COUPle:DOFFset <valeur>|MIN|MAX** **OUTPut[:STATe]:COUPle:DOFFset? [{MIN|MAX}]**

Définit un décalage de délai pour synchroniser les modifications de l'état de sortie couplé. Les unités sont exprimées en secondes. Le réglage de ce temps sur le décalage de délai maximum spécifié pour un instrument couplé provoque la synchronisation de toutes les sorties couplées avec les délais d'activation spécifiés par la commande `OUTPut:DElay:RISE`. Ces paramètres sont enregistrés dans la mémoire non volatile.

Paramètre	Renvoi type
0 à 1.023	<valeur de délai>
Indique un délai de 60 millisecondes : <code>OUTP:COUP:DOFF 0.06</code>	

### **OUTPut[:STATe]:COUPle:MAX:DOFFset?**

Renvoie le décalage de délai requis pour cet instrument. La valeur de `OUTPut:COUPle:DElay:OFFSet` doit au moins être définie sur le décalage de délai maximal renvoyé pour une sortie couplée.

Paramètre	Renvoi type
(aucun)	<valeur de décalage>
Renvoie le décalage de délai maximal : <code>OUTP:COUP:MAX:DOFF?</code>	

### **OUTPut[:STATe]:DElay:FALL <valeur>|MIN|MAX** **OUTPut[:STATe]:DElay:FALL? [{MIN|MAX}]** **OUTPut[:STATe]:DElay:RISE <valeur>|MIN|MAX** **OUTPut[:STATe]:DElay:RISE? [{MIN|MAX}]**

Indique le temps d'attente, en secondes, avant que l'instrument n'active (montée) ou ne désactive (descente) la sortie. Cela permet d'activer ou de désactiver de façon séquentielle plusieurs instruments. La sortie n'est activée ou désactivée qu'une fois son délai écoulé. Cette commande concerne les transitions d'état activé-désactivé, et NON les transitions vers l'état désactivé provoquées par les fonctions de protection. Les délais peuvent être programmés avec la résolution suivante :

Plage en secondes	Résolution	Plage en secondes	Résolution
0 à 1,023E-4	100 nanosecondes	1,03E-1 à 1,023E+0	1 milliseconde
1,03E-4 à 1,023E-3	1 microseconde	1,03E+0 à 1,023E+1	10 millisecondes

Plage en secondes	Résolution	Plage en secondes	Résolution
1,03E-3 à 1,023E-2	10 microsecondes	1,03E+1 à 1,023E+2	100 millisecondes
1,03E-2 à 1,023E-1	100 microsecondes	1,03E+2 à 1,023E+3	1 seconde

Notez que les commandes de montée et de descente utilisent la même résolution, déterminée par le délai (montée ou descente) le plus long.

Paramètre	Renvoi type
0 - 1023, *RST0	<valeur de délai>
Définit un délai de 0,5 s avant l'activation de la sortie : <code>OUTP:DEL:RISE 0.5</code>	

- Chaque instrument présente un décalage de délai minimal qui s'applique entre le moment où la commande d'activation de la sortie est reçue et celui où elle est réellement activée. Si vous indiquez un délai d'activation, ce dernier est ajouté au décalage de délai minimal, ce qui engendre un délai d'activation plus long que celui que vous avez programmé.
- Utilisez la commande `OUTput:COUPle:MAX:DOFFset?` pour obtenir le décalage de délai requis pour chaque instrument.

### **OUTPut[:STATe]:TMODe:COUPle 0|OFF|1|ON** **OUTPut[:STATe]TMODe:COUPle?**

Lorsque le couplage est activé, la modification du réglage d'activation change également le réglage de désactivation et vice-versa. Si les réglages d'activation et de désactivation ne sont pas les mêmes et que le couplage est activé, le réglage de désactivation sera modifié afin de correspondre au réglage d'activation.

Paramètre	Renvoi type
0 OFF 1 ON	0 ou 1
Associe les modes d'activation et de désactivation : <code>OUTP:REL:LOCK ON</code>	

### **OUTPut[:STATe]:TMODe[:OFF] HIGHZ | LOWZ** **OUTPut:TMODe[:OFF]?** **OUTPut[:STATe]:TMODe:ON HIGHZ | LOWZ** **OUTPut:TMODe:ON?**

Ces commandes définissent le comportement d'activation et de désactivation de la sortie sur Faible impédance ou Impédance élevée.

**Low Impedance (Faible impédance)** : permet de programmer la tension de sortie à zéro, puis de déconnecter la sortie. L'absorption maximale de courant négatif se produit durant 250 ms lors de la transition de désactivation.

**High Impedance (Impédance élevée)** : permet de déconnecter la sortie sans absorption active de courant.

Paramètre	Renvoi type
HIGHZ LOWZ	HIGHZ ou LOWZ
Définit l'état d'activation sur une impédance élevée : <code>OUTP:TMOD:ON HIGHZ</code> Règle l'état de désactivation sur une faible impédance : <code>OUTP:TMOD:OFF LOWZ</code>	

- Le réglage de l'activation ou de la désactivation ne s'applique que lorsque l'instrument fonctionne en mode de priorité de tension. En mode de priorité de courant, le comportement d'activation ou de désactivation est toujours l'impédance.

### **OUTPut:INHibit:MODE LATChing|LIVE|OFF** **OUTPut:INHibit:MODE?**

Définit le mode de fonctionnement de la broche numérique d'inhibition à distance. La fonction d'inhibition permet d'interrompre la sortie en réponse à un signal de déclenchement sur la broche d'entrée d'inhibition. Le mode Inhibition est enregistré dans la mémoire non volatile. Voir [Programmation du port numérique](#).

**LATChing** : un signal vrai logique sur l'entrée d'inhibition entraîne le déverrouillage de l'état de sortie. La sortie demeure désactivée jusqu'à ce que l'entrée d'inhibition soit renvoyée à l'état faux logique et que le bit d'état INH verrouillé soit effacé en envoyant la commande `OUTPut:PROTection:CLear` ou une commande de désactivation de la protection depuis le panneau avant.

**LIVE** : permet à la sortie activée de suivre l'état de l'entrée d'inhibition. Lorsque l'entrée d'inhibition est à l'état vrai, la sortie est désactivée. Lorsque l'entrée d'inhibition est à l'état faux, la sortie est réactivée.

**OFF** : l'entrée d'inhibition est ignorée.

Paramètre	Renvoi type
LATChing LIVE OFF	LATC, LIVE ou OFF
Définit l'entrée d'inhibition en mode Live (Actif) : <code>OUTP:INH:MODE LIVE</code>	

### **OUTPut:PON:STATe RST|RCL0** **OUTPut:PON:STATe?**

Définit la configuration de mise sous tension de la sortie. Cette commande détermine si l'état de mise sous tension est défini à l'état \*RST (RST) ou l'état stocké à l'emplacement de mémoire 0 (RCL0). Les configurations de l'instrument peuvent être enregistrées à l'aide de la commande \*SAV. Ces paramètres sont enregistrés dans la mémoire non volatile.

Paramètre	Renvoi type
RST RCL0	RST ou RCL0
Définit l'état de mise sous tension sur l'état *RST : <code>OUTP:PON:STAT RST</code>	

- Si l'état de mise sous tension est défini à zéro sans aucun état enregistré, l'erreur d'autotest "file not found; 0 state" (fichier introuvable ; 0 état) est générée et l'instrument passe à l'état \*RST.
- En cas d'échec d'une commande principale **connexion automatique**, l'état de la mise sous tension est réglé sur \*RST.

### OUTPut:PROTection:CLEar

Réinitialise la protection verrouillée. Cette commande efface l'état de protection verrouillé qui désactive la sortie lorsqu'une condition de protection se produit (voir **Programmation de la protection des sorties**).

Paramètre	Renvoi type
(aucun)	(aucun)
Efface l'état de protection verrouillé : <code>OUTP:PROT:CLE</code>	

- Toutes les conditions qui génèrent l'erreur doivent être supprimées avant de pouvoir effacer l'état verrouillé. La sortie revient à son état précédant la condition d'erreur.
- Si un arrêt de la protection se produit pendant une liste de sortie, la liste continue de s'exécuter, même si la sortie est désactivée. Lorsque l'état de protection est effacé et la sortie réactivée, cette dernière est réglée sur les valeurs du palier auquel la liste se trouve actuellement.

### OUTPut:PROTection:TEMPerature:MARGin?

Renvoie la différence minimale entre les capteurs de température interne et le niveau de déclenchement en surchauffe. La marge est indiquée en degrés Celsius.

Paramètre	Renvoi type
(aucun)	<valeur de marge>
Renvoie la marge de température : <code>OUTP:PROT:TEMP:MARG?</code>	

### OUTPut:PROTection:WDOG[:STATe] 0|OFF|1|ON OUTPut:PROTection:WDOG[:STATe]?

Active ou désactive le temporisateur de surveillance des E/S. Lorsqu'elle est activée, la sortie est désactivée en l'absence d'activité d'E/S sur une interface de commande à distance durant la période spécifiée par la commande `OUTPut:PROTection:WDOG:DElay`. La sortie est déverrouillée, mais l'état de sortie programmé ne change pas.

Paramètre	Renvoi type
0 OFF 1 ON, *RST OFF	0 ou 1
Active la protection du temporisateur de surveillance : <code>OUTP:PROT:WDOG ON</code>	



**OUTPut:PROTection:WDOG:DELaY <valeur>|MIN|MAX**  
**OUTPut:PROTection:WDOG:DELaY? [{MIN|MAX}]**

Définit le délai de surveillance. Lorsque le temporisateur de surveillance est activé, la sortie est désactivée en l'absence d'activité d'E/S sur une interface de commande à distance (USB, LAN, GPIB) durant le délai de temporisation. La fonction de temporisateur de surveillance n'est PAS réinitialisée par une activité sur le panneau avant : la sortie est interrompue une fois le délai écoulé. Les valeurs programmées peuvent être comprises entre 1 et 3 600 secondes par incréments de 1 seconde.

Paramètre	Renvoitype
0 - 3 600, *RST 60 secondes	<valeur de délai>
Définit un délai de surveillance de 600 secondes : <code>OUTP:PROT:WDOG:DEL 600</code>	

**Requête POWer****[SOURce:]POWer:LIMit?**

Renvoie la limite de puissance de l'instrument en watts, 20 kW, ou 30 kW.

Paramètre	Renvoitype
Aucun	20 000 ou 30 000
Renvoyer la limite de puissance : <b>POWer:LIMit?</b>	

## Sous-système SASimulator

Les commandes du SASimulator ne s'appliquent que lorsque l'instrument fonctionne comme un simulateur de groupe de cellules solaires. Les commandes SAS programment les fonctions du simulateur de groupe de cellules solaires. Elles ne sont pas disponibles lorsque le SAS:MODE est réglé sur FIXed. Erreur -315, le conflit de réglages est généré lorsque les commandes ne sont pas prises en charge dans le mode de fonctionnement actuel. Pour de plus amples informations, reportez-vous à la section **Fonctionnement du simulateur photovoltaïque**.

**[SOURce:]SASimulator:ACTive:MPP:CURRent?**

**[SOURce:]SASimulator:ACTive:MPP:POWer?**

**[SOURce:]SASimulator:ACTive:MPP:VOLTage?**

Ces commandes renvoient le courant, la puissance ou la tension du point de puissance maximum réelle (MPP) de la courbe en cours, la courbe active. Notez qu'en mode Courbe, cette valeur peut être légèrement différente du MPP programmé par l'utilisateur en raison de l'algorithme utilisé pour calculer la courbe. De même, en mode Tableau, le véritable MPP peut ne correspondre à aucun des paramètres du tableau I-V que l'utilisateur a programmé. Les valeurs renvoyées sont exprimées en ampères, en volts ou en watts.

Paramètre	Renvoi type
(aucun)	<valeur maximale du point de puissance>
Renvoie le courant au point de puissance maximum : SAS:ACT:MPP:CURR?	

**[SOURce:]SASimulator:BWIDth:RANGe <plage>**

**[SOURce:]SASimulator:BWIDth:RANGe?**

Cette commande permet de régler la plage de bande passante du SAS dans les modes Courbe et Tableau.

0 : la plage de bande passante lente est stable lors de l'essai d'une grande variété d'onduleurs.

1 : la plage de bande passante rapide est optimisée pour les onduleurs avec des algorithmes MPPT plus rapides.

Paramètre	Renvoi type
0 1; *RST: 0	0 1
Règle la bande passante SAS sur la plage rapide : SAS:BWID:RANG:1	

**[SOURce:]SASimulator:CURVe:IMP <courant>|MIN|MAX**

**[SOURce:]SASimulator:CURVe:IMP? [{MIN|MAX}]**

Cette commande définit le courant au point de puissance maximale de la courbe SAS lors d'un fonctionnement en mode Courbe. La valeur est en ampères.

Paramètre	Renvoi type
0 à 102 % de la valeur nominale   MIN   MAX; *RST: 0,8% de la valeur nominale	<Réglage Imp>
Règle le courant au point de puissance maximum : SAS:CURV:IMP 10	
Ceci règle les quatre paramètres en même temps : SAS:CURV:IMP 10; ISC 12; VMP 100; VOC 120	

**[SOURce:]SASimulator:CURVe:ISC <courant>|MIN|MAX**  
**[SOURce:]SASimulator:CURVe:ISC? [{MIN|MAX}]**

Cette commande règle le courant de court-circuit lors du fonctionnement en mode Courbe. La valeur est en ampères.

Paramètre	Renvoi type
0 à 102 % de la valeur nominale   MIN   MAX; *RST: 1% de la valeur nominale	<Réglage Isc>
Règle le courant de court-circuit : SAS:CURV:ISC 12	
Ceci règle les quatre paramètres en même temps : SAS:CURV:IMP 10; ISC 12; VMP 100; VOC 120	

**[SOURce:]SASimulator:CURVe:SHAPE <forme>**  
**[SOURce:]SASimulator:CURVe:SHAPE?**

Cette commande règle la forme de la courbe lors du fonctionnement en mode Courbe.

SPACE définit la forme de la courbe en fonction des **équations spatiales**.

TERRestrial définit la forme de la courbe en fonction des **équations terrestres**.

Paramètre	Renvoi type
SPACE TERRestrial, *RST: SPACE	SPAC ou TERR
Définit la forme de la courbe à TERRestrial : SAS:CURV:SHAP TERR	

**[SOURce:]SASimulator:CURVe:VMP <tension>|MIN|MAX**  
**[SOURce:]SASimulator:CURVe:VMP? [{MIN|MAX}]**

Cette commande définit la tension au point de puissance maximale de la courbe SAS lors d'un fonctionnement en mode Courbe. La valeur est en volts.

Paramètre	Renvoi type
0 à 102 % de la valeur nominale   MIN   MAX; *RST: 0,8% de la valeur nominale	<Réglage Vmp>
Règle la tension au point de puissance maximum : SAS:CURV:VMP 100	
Ceci règle les quatre paramètres en même temps : SAS:CURV:IMP 10; ISC 12; VMP 100; VOC 120	

**[SOURCE:]SASimulator:CURVe:VOC <tension>|MIN|MAX**  
**[SOURCE:]SASimulator:CURVe:VOC? [{MIN|MAX}]**

Cette commande règle la tension en circuit ouvert lors du fonctionnement en mode Courbe. La valeur est en volts.

Paramètre	Renvoi type
0 à 102 % de la valeur nominale MIN MAX; *RST: 1% de la valeur nominale	<Réglage Voc>
Règle la tension en circuit ouvert : SAS:CURV:VOC 120	
Ceci règle les quatre paramètres en même temps : SAS:CURV:IMP 10; ISC 12; VMP 100; VOC 120	

**[SOURCE:]SASimulator:MODE <mode>**  
**[SOURCE:]SASimulator:MODE?**

Cette commande permet de définir le fonctionnement de l'appareil comme système d'alimentation standard ou comme simulateur de groupe de cellules solaires.

**FIXed** : fait fonctionner l'appareil comme un système d'alimentation CV/CC standard.

**CURVe** : fait fonctionner l'appareil comme simulateur de groupe de cellules solaires. La caractéristique de sortie est déterminée par les paramètres Isc, Imp, Voc, Vmp et Shape.

**TABLE** : fait fonctionner l'appareil comme un simulateur de groupe de cellules solaires. La caractéristique de sortie est déterminée par jusqu'à 1024 points de tableau définis par l'utilisateur. Les points sont validés en utilisant SAS:TABLE:ACT or SAS:TABLE:UPD. Si les points ne représentent pas un ensemble valide, une erreur sera générée.

Paramètre	Renvoi type
FIXed CURVe TABLE; *RST: FIXed	FIX, CURV, ou TABL
Réglez l'appareil pour qu'il fonctionne comme un simulateur de groupe de cellules solaires en utilisant des points de tableau définis par l'utilisateur : SAS:MODE:TABLE	

**[SOURCE:]SASimulator:SCALE:CURRent <pourcentage>|MIN|MAX**  
**[SOURCE:]SASimulator:SCALE:CURRent? [{MIN|MAX}]**  
**[SOURCE:]SASimulator:SCALE:VOLTage <pourcentage>|MIN|MAX**  
**[SOURCE:]SASimulator:SCALE:VOLTage? [{MIN|MAX}]**

Ces commandes définissent un facteur d'échelle pour la courbe dans les modes Courbe et Tableau. La tension et le courant peuvent être mis à l'échelle en même temps.

Le courant de sortie sera égal à ce pourcentage multiplié par le courant calculé à partir du tableau ou de la courbe SAS. Ceci est souvent utilisé pour simuler les variations d'éclairement énergétique des cellules solaires. La tension de sortie sera égale à ce pourcentage multiplié par la tension calculée à partir du tableau ou de la courbe SAS. Ceci est souvent utilisé pour simuler les variations de température des cellules solaires.

Paramètre	Renvoi type
1 à 100 (%); *RST: 100	<% valeur>
Définit le facteur d'échelle du courant à 90 % : SAS:SCAL:CURR 90 Définit le facteur d'échelle de la tension à 90 % : SAS:SCAL:VOLT 90	

- Une fois activé, la sortie réagit immédiatement à tout changement de réglage.

### [SOURCE:]SASimulator:TABLE:ACTivate 1|2

Cette commande active les points de tableau saisis en utilisant SAS:TABL:CURR et SAS:TABL:VOLT.

Paramètre	Renvoi type
1 2	1 ou 2
Active le tableau 1 : SAS:TABL:ACT 1	

- Cette commande n'est active qu'en mode Tableau. Sinon l'erreur -315 est générée.
- Cette commande est équivalente à l'envoi de SAS:TABL:UPD, puis de SAS:TABL:SEL.
- Si les commandes SAS:TABL:CURR et SAS:TABL:VOLT sont envoyées après l'activation du tableau, la commande SAS:TABL:ACT doit être renvoyée pour activer les nouvelles valeurs du tableau.

### [SOURCE:]SASimulator:TABLE:SElect 1|2

#### [SOURCE:]SASimulator:TABLE:SElect?

Sélectionne le tableau actif à exécuter à partir des deux tableaux entrés dans l'emplacement du système SAS. Vous ne pouvez exécuter qu'un tableau actif à la fois. L'utilisation de cette commande vous permet de basculer entre deux tableaux actifs sans désactiver la sortie de l'appareil.

Paramètre	Renvoi type
1 2	1 ou 2
Sélectionne le tableau 2 : SAS:TABL:SEL 2	

- Cette commande n'est active qu'en mode Tableau.

### [SOURCE:]SASimulator:TABLE:UPDate 1|2

Valide l'ensemble des données et met à jour le tableau spécifié dans le système SAS. Cette commande déplace les données du tableau de l'emplacement de la mémoire à l'emplacement du système SAS mais ne sélectionne pas le tableau à utiliser. Pour utiliser cette commande, vous devez avoir préalablement chargé un tableau dans l'emplacement de la mémoire de l'appareil en utilisant SAS:TABL:CURR et SAS:TABL:VOLT.

Paramètre	Renvoi type
(aucun)	(aucun)
Met à jour le tableau 2 : SAS:TABL:UPD 2	

- Cette commande n'est active qu'en mode Tableau.

**[SOURce:]SASimulator:TABLE[1|2]:CURRENT[:AMPLitude] <courant>{,<courant>}**  
**[SOURce:]SASimulator:TABLE[1|2]:VOLTage[:AMPLitude] <tension>{,<tension>}**

Ces commandes définissent les tableaux de tension et de courant qui définissent la caractéristique SAS lorsque le mode Tableau est sélectionné. Chacune de ces commandes doit contenir une liste de points de tension ou de courant, séparés par des virgules (,). Les listes de tableaux doivent satisfaire aux exigences suivantes :

- Pour chaque tableau, le nombre de points peut varier de 3 à 1024. Toutefois, les deux tableaux doivent contenir le même nombre de points.
- Les valeurs des points de courant doivent être décroissantes et monotones. Les valeurs adjacentes peuvent être égales. La dernière valeur doit être zéro (une plage de  $\pm 0,3$  mA est autorisée).
- Les valeurs des points de tension doivent être strictement croissantes et monotones. Les valeurs adjacentes ne peuvent PAS être égales. La première valeur doit être zéro (une plage de  $\pm 15$  mV est autorisée).

Paramètre	Renvoi type
Current (Courant) : La <b>dernière</b> valeur doit être 0. Toutes les valeurs précédentes doivent être comprises entre 0 et 102 % du courant nominal de l'appareil. Valeurs *RST : 1 % de la valeur nominale, 0,8 % de la valeur nominale, 0,0	<valeur 1>, <valeur 2>, <valeur 3>...
Voltage (Tension) : La <b>première</b> valeur doit être 0. Toutes les valeurs suivantes doivent être comprises entre 0 et 102 % de la tension nominale de l'appareil. Valeurs *RST : 0,0, 0,8 % de la valeur nominale, 1 % de la valeur nominale	<valeur 1>, <valeur 2>, <valeur 3>...
Programmer un simple tableau de courant : SAS:TABL1:CURR 20,15,0 Programmer un simple tableau de tension : SAS:TABL1:VOLT 0,100,120	

- Les points sont validés en utilisant SAS:TABL:ACT or SAS:TABL:UPD. Si les points ne représentent pas un ensemble valide, une erreur sera générée.
- Les valeurs du tableau ne sont **pas** enregistrées avec la configuration enregistrée de l'instrument avec la commande \*SAV.
- Si aucun numéro de tableau n'est spécifié [1 ou 2], les commandes se réfèrent par défaut à TABLE 1.

**[SOURce:]SASimulator:TABLE[1|2]:CURRENT:POINTs?**  
**[SOURce:]SASimulator:TABLE[1|2]:VOLTage:POINTs?**

Ces commandes retournent le nombre de points de données assignés aux tableaux de tension et de courant qui définissent la caractéristique SAS lorsque le mode Tableau est sélectionné.

Paramètre	Renvoitype
(aucun)	1024
Renvoie le nombre de points de données dans le tableau de courant : SAS:TABL1:CURR:POIN?	
Renvoie le nombre de points de données dans le tableau de tension : SAS:TABL1:VOLT:POIN?	

- Si aucun numéro de tableau n'est spécifié [1 ou 2], les commandes se réfèrent par défaut à TABLE 1.



## Sous-système SENSE

Les commandes Sense contrôlent les plages et la fenêtre de mesure du courant ainsi que la séquence d'acquisition des données.

### SENSe:AHOu:RESet

### SENSe:WHOu:RESet

Réinitialise la mesure en ampères-heures ou en watts-heures à zéro.

Paramètre	Renvoi type
(aucun)	(aucun)
Réinitialise la mesure en ampères-heures : SENS:AHO:RES	
Réinitialise la mesure en watts-heures : SENS:WHO:RES	

### SENSe:ELOG:FUNCTion:CURRent 0|OFF|1|ON

### SENSe:ELOG:FUNCTion:CURRent?

### SENSe:ELOG:FUNCTion:VOLTage 0|OFF|1|ON

### SENSe:ELOG:FUNCTion:VOLTage?

Active ou désactive la fonction de mesure de courant ou de tension Elog.

Paramètre	Renvoi type
0 OFF 1 ON, *RST OFF	0 ou 1
Active les mesures de courant de l'enregistrement : SENS:ELOG:FUNC:CURR ON	
Active les mesures de tension de l'enregistrement de données : SENS:ELOG:FUNC:VOLT ON	

### SENSe:ELOG:FUNCTion:CURRent:MINMax 0|OFF|1|ON

### SENSe:ELOG:FUNCTion:CURRent:MINMax?

### SENSe:ELOG:FUNCTion:VOLTage:MINMax 0|OFF|1|ON

### SENSe:ELOG:FUNCTion:VOLTage:MINMax?

Active ou désactive l'enregistrement des valeurs de courant ou de tension minimales et maximales.

Paramètre	Renvoi type
0 OFF 1 ON, *RST OFF	0 ou 1
Active les valeurs d'enregistrement MIN/MAX de courant : SENS:ELOG:FUNC:CURR:MINM ON	
Active les valeurs d'enregistrement MIN/MAX de tension : SENS:ELOG:FUNC:VOLT:MINM ON	

### SENSe:ELOG:PERiod <valeur>|MIN|MAX

### SENSe:ELOG:PERiod? [{MIN|MAX}]

Définit le temps d'intégration d'une mesure de données externes (Elog).

Même si la période d'enregistrement minimale absolue est de 102,4 microsecondes, la valeur minimale réelle varie en fonction du nombre de lectures qui sont actuellement enregistrées (voir **Période d'intégration**).

Paramètre	Renvoi type
0,0001024 à 60, *RST MAX	<période>
Indique une période d'enregistrement de 0,01 seconde : <code>SENS:ELOG:PER 0.01</code>	

**SENSe:FUNCTion:CURRent 0|OFF|1|ON**

**SENSe:FUNCTion:CURRent?**

**SENSe:FUNCTion:VOLTage 0|OFF|1|ON**

**SENSe:FUNCTion:VOLTage?**

Active ou désactive les mesures de courant ou de tension.

Paramètre	Renvoi type
0 OFF 1 ON, *RST ON	0 ou 1
Active les mesures de courant : <code>SENS:FUNC:CURR ON</code> Désactive les mesures de tension : <code>SENS:FUNC:VOLT OFF</code>	

**SENSe:SWEep:NPLCycles <valeur>|MIN|MAX**

**SENSe:SWEep:NPLCycles? [{MIN|MAX}]**

Définit le temps de mesure en nombre de cycles de tension d'alimentation. L'augmentation du nombre de cycles de tension d'alimentation entraîne la réduction du bruit de mesure sur les mesures de courant et de tension. La modification du NPLC entraîne celle du nombre de points et le paramètre d'intervalle.

Paramètre	Renvoi type
0,0003072 à 1,258,290,000,000, *RST 1	<valeur NPLC>
Indique 100 cycles de tension d'alimentation : <code>SENS:SWE:NPLC 100</code>	

**SENSe:SWEep:OFFSet:POINts <valeur>|MIN|MAX**

**SENSe:SWEep:OFFSet:POINts? [{MIN|MAX}]**

Définit le décalage d'un balayage de données pour les mesures déclenchées. Les valeurs positives représentent le délai au-delà duquel le déclenchement se produit avant l'acquisition des échantillons. Les valeurs négatives représentent les échantillons de données prélevés avant le déclenchement.

Paramètre	Renvoi type
-524,287 à 2,000,000,000, *RST 0	<points de décalage>

Paramètre	Renvoi type
Indique -2048 points de décalage : <code>SENS:SWE:OFFS:POIN -2048</code>	

### **SENSe:SWEep:POINTs <valeur>|MIN|MAX** **SENSe:SWEep:POINTs? [{MIN|MAX}]**

Définit le nombre de points d'une mesure. Notez que les points, TINTerval et NPLC sont liés entre eux. Le fait de définir des points ou TINTerval modifie le NPLC. Le fait de définir un NPLC peut modifier à la fois les points et TINTerval. Le nombre de points par défaut engendre une mesure de 1 NPLC.

Paramètre	Renvoi type
1 à 524,288 MIN MAX, *RST 3255 (60 Hz) ; 3906 (50 Hz)	<points>
Indique 2048 points : <code>SENS:SWE:POIN 2048</code>	

### **SENSe:SWEep:TINTerval <valeur>|MIN|MAX** **SENSe:SWEep:TINTerval? [{MIN|MAX}]**

Définit la période qui s'écoule entre les échantillons de mesure. Les unités sont exprimées en secondes. Les valeurs sont arrondies à l'incrément de 20,48 microsecondes le plus proche. En dessous de 20,48 microsecondes, les valeurs sont arrondies à l'incrément de 10,24 ou de 5,12 microsecondes le plus proche, respectivement.

Paramètre	Renvoi type
0,00000512 à 40,000, *RST 0,00000512	<intervalle>
Indique un intervalle de 1 ms entre les points : <code>SENS:SWE:TINT 0.001</code>	

### **SENSe:WINDow[:TYPE] HANNing|RECTangular** **SENSe:WINDow[:TYPE]?**

Sélectionne la fenêtre de mesure. Cette commande permet de configurer une fonction de conditionnement de signal utilisée dans les calculs de mesure CC scalaires. Aucune des fonctions de fenêtrage n'altère les données de tension ou de courant instantanées renvoyées dans le tableau de mesure.

La fenêtre **Hanning** est une fonction de « cosinus surélevé ». Il s'agit d'une fonction de conditionnement de signal qui réduit les erreurs dans les calculs de mesure CC en présence de signaux périodiques, tels qu'une ondulation de la tension secteur. Cette fenêtre ne traite que jusqu'à 4 883 points de mesure. L'instrument retourne à une fenêtre rectangulaire lorsque le nombre de points dépasse 4883.

La fenêtre **Rectangular (Rectangulaire)** renvoie des calculs de mesure sans aucun conditionnement de signal.

Paramètre	Renvoitype
HANNing RECTangular, *RST RECTangular	RECT ou HANN
<b>Indique une fonction de fenêtre Hanning : SENS:WIND HANN</b>	

## **Sous-système [SOURce]**

Le mot-clé SOURce est facultatif dans de nombreuses commandes qui définissent des paramètres d'une source ou sortie, telles que [SOURce:]CURRent <valeur>.

Parce que les commandes du sous-système SOURce sont souvent utilisées sans le mot-clé SOURce facultatif, ces commandes sont répertoriées ci-dessous par leurs sous-systèmes :

### **Sous-systèmes et commandes utilisant le mot-clé [SOURce:] Mot-clé**

**ARB**

**CURRent**

**DIGital**

**FUNcTion**

**LIST**

**POWer:LIMit**

**SASimulator** (photovoltaïque)

**STEP:TOUTput**

**VOLTage**

## Sous-système STATus

La programmation du registre d'état vous permet de déterminer à tout moment les conditions de fonctionnement de l'instrument. L'instrument comporte trois groupes de registres d'état : Fonctionnement, Suspect et Événement standard. Les groupes d'état Fonctionnement et Suspect sont chacun composés des registres de conditions, d'activation et d'événements, ainsi que des filtres NTR et PTR.

Le sous-système d'état est également programmé à l'aide de commandes courantes. Les commandes courantes contrôlent des fonctions d'état supplémentaires, telles que les registres d'activation de demande de service et d'octet d'état. Pour de plus amples informations, reportez-vous à la section [Didacticiel d'état](#).

### STATus:OPERation[:EVENT]

Effectue une requête dans le [registre des événements](#) du groupe [État de fonctionnement](#). C'est un registre en lecture seule qui enregistre (verrouille) tous les événements qui sont transmis par le filtre NTR et/ou PTR de fonctionnement. Une fois lu, le registre des événements d'état de fonctionnement est effacé.

Paramètre	Renvoitype
(aucun)	<valeur de bit>

---

Lire le registre des événements d'état de fonctionnement : `STAT:OPER?`

- La valeur renvoyée correspond à la somme binaire pondérée de tous les bits activés du registre. Par exemple, lorsque le bit 3 (valeur 8) et le bit 5 (valeur 32) sont définis et activés, la requête renvoie +40.
- La commande \*RST n'a pas d'effet sur ce registre.

### STATus:OPERation:CONDition?

Effectue une requête dans le [registre de conditions](#) du groupe [État de fonctionnement](#). Il s'agit d'un registre en lecture seule qui contient l'état opérationnel (non verrouillé) actif de l'instrument. La lecture du registre des événements d'état d'activation n'entraîne pas son effacement.

Paramètre	Renvoitype
(aucun)	<valeur de bit>

---

Lire le registre des conditions d'état de fonctionnement : `STAT:OPER:COND?`

- La valeur renvoyée correspond à la somme binaire pondérée de tous les bits activés du registre. Par exemple, lorsque le bit 3 (valeur 8) et le bit 5 (valeur 32) sont définis et activés, la requête renvoie +40.
- Les bits du registre de conditions reflètent l'état actuel. Si une condition n'est pas remplie, le bit correspondant est effacé.

- La commande \*RST efface ce registre, sauf les bits où la condition existe toujours après la commande \*RST.

**STATus:OPERation:ENABLE <valeur>****STATus:OPERation:ENABLE?**

Définit la valeur du **registre d'activation** du groupe **État de fonctionnement**. Le registre d'activation est un masque qui permet d'activer des bits spécifiques du registre des événements de fonctionnement pour activer le bit OPER (récapitulatif de l'exécution) du registre d'octet d'état. STATus:PRESet efface tous les bits du registre d'activation.

Paramètre	Renvoi type
Valeur décimale correspondant à la somme binaire pondérée des bits du registre.	<valeur de bit>
Activer les bits 3 et 4 dans le registre d'activation : STAT:OPER:ENAB 24	

- Par exemple, lorsque le bit 3 (valeur 8) et le bit 5 (valeur 32) sont définis et activés, la requête renvoie +40.
- La commande \*CLS n'efface que le **registre des événements**, pas le registre d'activation.

**STATus:OPERation:NTRansition <valeur>****STATus:OPERation:NTRansition?****STATus:OPERation:PTRansition <valeur>****STATus:OPERation:PTRansition?**

Définit et recherche la valeur des registres **NTR** (Transition négative) et **PTR** (Transition positive). Ces registres servent de filtre de polarité entre les registres des conditions de fonctionnement et des événements de fonctionnement.

Lorsqu'un bit du registre NTR est défini sur 1, une transition de 1 vers 0 du bit correspondant dans le registre des conditions de fonctionnement entraîne l'activation du bit du registre des événements de fonctionnement.

Lorsqu'un bit du registre PTR est défini sur 1, une transition de 0 vers 1 du bit correspondant dans le registre des conditions de fonctionnement entraîne l'activation du bit dans le registre des événements de fonctionnement.

STATus:PRESet active tous les bits des registres PTR et efface tous les bits des registres NTR.

Paramètre	Renvoi type
Valeur décimale correspondant à la somme binaire pondérée des bits du registre.	<valeur de bit>
Activer les bits 3 et 4 dans le registre NTR : STAT:OPER:NTR 24	
Activer les bits 3 et 4 dans le registre PTR : STAT:OPER:PTR 24	

- Si les mêmes bits des registres NTR et PTR sont définis sur 1, toute transition de ce bit dans le registre des conditions de fonctionnement provoque l'activation du bit correspondant dans le registre des événements de fonctionnement.
- Si les mêmes bits des registres NTR et PTR sont définis à 0, aucune transition de ce bit dans le registre des conditions de fonctionnement ne peut aboutir à l'activation du bit correspondant dans le registre des événements de fonctionnement.
- La valeur renvoyée correspond à la somme binaire pondérée de tous les bits activés du registre.

## STATus:PRESet

Prédéfini tous les registres d'activation, PTR et NTR.

Registre de fonctionnement	Registre suspect	Réglage prédéfini
STAT:OPER:ENAB	STAT:QUES<1 2>:ENAB	tous les bits définis sont désactivés
STAT:OPER:NTR	STAT:QUES<1 2>:NTR	tous les bits définis sont désactivés
STAT:OPER:PTR	STAT:QUES<1 2>:PTR	tous les bits définis sont activés

Paramètre	Renvoitype
(aucun)	(aucun)

Prédéfinir les registres de fonctionnement et d'état suspect : STAT:PRES

## STATus:QUESTionable<1|2>[:EVENT]?

Effectue une requête dans le **registre des événements** du groupe **État suspect**. C'est un registre en lecture seule qui enregistre (verrouille) tous les événements qui sont transmis par le filtre NTR et/ou PTR de fonctionnement. Une fois lu, le registre des événements d'état suspect est effacé.

Paramètre	Renvoitype
(aucun)	<valeur de bit>

Lire le registre des événements d'état suspect n° 1 : STAT:QUES1?

- La valeur renvoyée correspond à la somme binaire pondérée de tous les bits activés du registre. Par exemple, lorsque le bit 2 (valeur 4) et le bit 4 (valeur 16) sont définis, la requête renvoie +20.
- La commande \*RST n'a pas d'effet sur ce registre.

## STATus:QUESTionable<1|2>:CONDition?

Effectue une requête dans le **registre des conditions** du groupe **État suspect**. Il s'agit d'un registre en lecture seule qui contient l'état opérationnel (non verrouillé) actif de l'instrument. La lecture du registre des événements d'état suspect n'entraîne pas son effacement.



Paramètre	Renvoi type
(aucun)	<valeur de bit>
Lire le registre de conditions d'état suspect n° 1 : STAT:QUES1:COND?	

- La valeur renvoyée correspond à la somme binaire pondérée de tous les bits activés du registre. Par exemple, lorsque le bit 2 (valeur 4) et le bit 4 (valeur 16) sont définis, la requête renvoie +20.
- Les bits du registre de conditions reflètent l'état actuel. Si une condition n'est pas remplie, le bit correspondant est effacé.
- La commande \*RST efface ce registre, sauf les bits où la condition existe toujours après la commande \*RST.

**STATus:QUESTionable<1|2>:ENABLE <valeur>**

**STATus:QUESTionable<1|2>:ENABLE?**

Définit la valeur du **registre d'activation** du groupe **État suspect**. Le registre d'activation est un masque qui permet d'activer des bits spécifiques du registre des événements de fonctionnement pour activer le bit QUES (récapitulatif d'état suspect) du registre d'octet d'état. STATus:PRESet efface tous les bits du registre d'activation.

Paramètre	Renvoi type
Valeur décimale correspondant à la somme binaire pondérée des bits du registre.	<valeur de bit>
Activer les bits 2 et 4 dans le registre d'activation suspect n° 1 : STAT:QUES1:ENAB 24	

- Par exemple, lorsque le bit 2 (valeur 4) et le bit 4 (valeur 16) sont définis, la requête renvoie +20.
- La commande \*CLS n'efface que le **registre des événements**, pas le registre d'activation.

**STATus:QUESTionable<1|2>:NTRansition <valeur>**

**STATus:QUESTionable<1|2>:NTRansition?**

**STATus:QUESTionable<1|2>:PTRansition <valeur>**

**STATus:QUESTionable<1|2>:PTRansition?**

Définit et recherche la valeur des registres **NTR** (Transition négative) et **PTR** (Transition positive). Ces registres servent de filtre de polarité entre les registres des conditions suspectes et des événements suspects.

Lorsqu'un bit du registre NTR est défini sur 1, une transition de 1 vers 0 du bit correspondant dans le registre des conditions suspectes entraîne l'activation du bit du registre des événements suspects.

Lorsqu'un bit du registre PTR est défini sur 1, une transition de 0 vers 1 du bit correspondant dans le registre des conditions suspectes entraîne l'activation du bit du registre des événements suspects.

STATus:PRESet active tous les bits des registres PTR et efface tous les bits des registres NTR.

Paramètre	Renvoitype
Valeur décimale correspondant à la somme binaire pondérée des bits du registre.	<valeur de bit>
<b>Activer les bits 3 et 4 dans le registre NTR suspect n° 1 : STAT:QUES1:NTR 24</b>	
<b>Activer les bits 3 et 4 dans le registre PTR suspect n° 1 : STAT:QUES1:PTR 24</b>	

- Si les mêmes bits des registres NTR et PTR sont définis sur 1, toute transition de ce bit dans le registre des conditions suspectes provoque l'activation du bit correspondant dans le registre des événements suspects.
- Si les mêmes bits des registres NTR et PTR sont définis à 0, aucune transition de ce bit dans le registre des conditions suspectes ne peut aboutir à l'activation du bit correspondant dans le registre des événements suspects.
- La valeur renvoyée correspond à la somme binaire pondérée de tous les bits activés du registre.

**Commande STEP****[SOURce:]STEP:TOUTput 0|OFF|1|ON****[SOURce:]STEP:TOUTput?**

Indique si une sortie de déclenchement est générée lorsqu'un palier de transitoire se produit. Un signal de déclenchement est généré lorsque l'état est activé (vrai).

Paramètre	Renvoi type
0 OFF 1 ON, *RST OFF	0 ou 1
Définit le signal de déclenchement du palier sur ON (ACTIVÉ) : <b>STEP:TOUT ON</b>	

## Sous-système SYSTEM

Les commandes System permettent de contrôler les fonctions du système qui ne sont pas directement liées aux fonctions de contrôle, de mesure ou d'état de la sortie. Notez que les commandes courantes IEEE-488 permettent également de contrôler des fonctions système, telles que l'autotest, l'enregistrement et le rappel des configurations, et bien d'autres.

### SYSTEM:COMMunicate:LAN:CONTrol? SYSTEM:COMMunicate:TCPIP:CONTrol?

Renvoie le numéro de port de connexion par socket de contrôle initial. Cette connexion permet d'envoyer et de recevoir des commandes et des requêtes. Contrairement au socket de données, qui utilise un numéro de port fixe, le numéro de port du socket de contrôle varie et doit être obtenu à l'aide de ces requêtes.

Paramètre	Renvoi type
(aucun)	<n° de port> (0 si les sockets ne sont pas pris en charge)

Connaître le numéro de port de connexion de contrôle :  
 SYST:COMM:LAN:CONT? ou SYST:COMM:TCP:CONT?

### SYSTEM:COMMunicate:RLState LOCAL|REMote|RWLock SYSTEM:COMMunicate:RLState?

Configure la configuration distante/locale de l'instrument. Les commandes à distance ou locale produisent le même résultat et sont incluses pour assurer la compatibilité avec d'autres produits. **LOCAL** configure l'instrument pour un contrôle sur le panneau avant. **REMote** configure l'instrument pour un contrôle sur le panneau avant. **RWLock** désactive les touches du panneau avant. L'instrument peut être uniquement contrôlé via l'interface de commande à distance. Ce paramètre programmable est entièrement indépendant de la fonction de verrouillage/déverrouillage du panneau avant.

Paramètre	Renvoi type
LOCAL REMote RWLock, *RST LOCAL	LOC, REM ou RWL

Définit la configuration distante/locale sur Remote (distante) : SYST:COMM:RLST REM

- La configuration distante/locale n'est pas affectée par la commande \*RST ni par aucune commande SCPI autre que SYSTEM:COMMunicate:RLState.
- La configuration distante/locale de l'instrument peut également être définie par d'autres commandes d'interface sur l'interface GPIB et quelques autres interfaces d'E/S.
- Si plusieurs interfaces de programmation à distance sont activées, l'interface dont la configuration distante/locale a le plus récemment changé détermine la configuration distante/locale de l'instrument.

**SYSTem:DATE <aaaa>, <mm>, <jj>****SYSTem:DATE?**

Règle la date de l'horloge système. Spécifier l'année (2000 à 2099), le mois (1 à 12) et le jour (1 à 31). L'horloge système n'est utilisée qu'avec le logiciel de contrôle et d'analyse d'alimentation BenchVue.

Paramètre	Renvoi type
<aaaa>, <mm>, <jj>	+2018,+04,+30
Régler la date au samedi 30 juin 2018 : SYST:DATE 2018,06,30	

- L'horloge système ne se règle pas d'elle-même pour les modifications du fuseau horaire ou l'heure d'été/hiver.

**SYSTem:ERRor?**

Lit et efface une erreur dans la file d'erreurs.

Paramètre	Renvoi type
(aucun)	<+0,"No error">
Lit et efface la première erreur de la file d'erreurs : SYST:ERR?	

- Le voyant ERR du panneau avant s'allume lorsqu'au moins une erreur est en cours d'enregistrement dans la file d'erreurs. Erreur de récupération « premier entré/premier sorti » (FIFO) ; ces erreurs sont effacées à la lecture. Après avoir lu toutes les erreurs de la file d'erreurs, le voyant ERR s'éteint.
- Si plus de 20 erreurs se produisent, la dernière erreur enregistrée (la plus récente) est remplacée par -350, « Error queue overflow » (Dépassement de la capacité de la file d'erreurs). Aucune erreur supplémentaire n'est enregistrée tant que vous ne supprimez pas des erreurs de la file. Si aucune erreur ne s'est produite depuis la dernière consultation de la file d'erreurs, l'instrument indique +0,"No error" (Aucune erreur).
- La file d'erreurs est effacée par la commande \*CLS et lorsque l'alimentation est coupée puis rétablie. Elle n'est pas effacée par la commande \*RST.
- Les erreurs ont le format suivant : <code d'erreur>, <chaîne d'erreur>. La chaîne d'erreur comprend 255 caractères au maximum. Pour une liste des codes d'erreur et des chaînes de messages, reportez-vous à la section **Messages d'erreur SCPI**.

**SYSTem:PASSword:FPANel:RESet**

Réinitialise le mot de passe de verrouillage du panneau avant à zéro. Cette commande ne permet pas de réinitialiser le mot de passe d'étalonnage.

Paramètre	Renvoi type
(aucun)	<+0,"No error">

Paramètre	Renvoi type
Réinitialise le mot de passe du panneau avant : SYST:PASS:FPAN:RES	

**SYSTem:REBoot**

Redémarre l'instrument à son état de mise sous tension.

Paramètre	Renvoi type
(aucun)	(aucun)
Redémarre l'instrument : SYST:REB	

**SYSTem:SECurity:IMMediate**

Efface toute la mémoire utilisateur et redémarre l'instrument. Cette commande sert généralement à préparer l'instrument pour son retrait d'une zone sécurisée. Cela nettoie toutes les données utilisateur. Elle écrit tous les zéros dans la mémoire Flash et procède à un effacement de la mémoire du processeur conformément à la fiche technique du fabricant. Les données d'identification (microprogramme de l'instrument, numéro du modèle, numéro de série, adresse MAC et données d'étalonnage) ne sont pas effacées. Une fois les données effacées, l'instrument est redémarré.

Cette procédure est déconseillée dans les applications de routine en raison des risques de perte involontaire de données.

Paramètre	Renvoi type
(aucun)	(aucun)
Nettoie la mémoire de l'instrument : SYST:SEC:IMM	

**SYSTem:SET <données de bloc>****SYSTem:SET?**

Obtenir et définir l'état de l'instrument. Le formulaire de requête de la commande renvoie un bloc de longueur définie qui contient l'état de l'instrument. Ces données de bloc peuvent être renvoyées à l'instrument pour le restaurer à l'état du bloc.

Paramètre	Renvoi type
<données de bloc>	<données de bloc>
Renvoie l'état du bloc à l'instrument : SYST:SET <données de bloc>	

**SYSTem:TIME <hh>, <mm>, <ss>****SYSTem:TIME?**

Règle l'heure de l'horloge système. Spécifier les heures (0 à 23), les minutes (0 à 59) et les secondes (0 à 59). L'horloge en temps réel n'est utilisée qu'avec le logiciel de contrôle et d'analyse d'alimentation BenchVue.

Paramètre	Renvoitype
<hh>,<mm>,<ss>	<hh,mm,ss>
Régler l'horloge sur 20h30 : SYST:TIME20,30,00	

### SYSTem:VERSion?

Renvoie la version SCPI à laquelle l'instrument est conforme. Impossible à déterminer à partir du panneau avant.

Paramètre	Renvoitype
(aucun)	<"version">
Renvoyer la version SCPI : SYST:VERS?	

- La commande renvoie une chaîne de caractères sous la forme "AAA.V", où AAA représente l'année de la version et V une version pour cette année.



## Sous-système TRIGger

Les commandes de déclenchement permettent de contrôler les sous-systèmes de transitoire et d'acquisition. Pour de plus amples informations, reportez-vous à la section **Présentation des déclenchements**.

**TRIGger:ACQuire[:IMMEDIATE]**

**TRIGger:ELOG[:IMMEDIATE]**

**TRIGger:TRANSient[:IMMEDIATE]**

Génère un événement de déclenchement immédiat. Cette commande permet de remplacer toute source de déclenchement sélectionnée.

La commande TRIGger:ACQuire déclenche le système d'acquisition.

TRIGger:ELOG déclenche l'enregistreur de données externe.

TRIGger:TRANSient déclenche le système de transitoire.

Paramètre	Renvoi type
(aucun)	(aucun)
Générer un déclenchement de mesure : TRIG:ACQ	

**TRIGger:ACQuire:CURRent[:LEVel] <valeur>|MIN|MAX**

**TRIGger:ACQuire:CURRent[:LEVel]? [{MIN|MAX}]**

**TRIGger:ACQuire:VOLTage[:LEVel] <valeur>|MIN|MAX**

**TRIGger:ACQuire:VOLTage[:LEVel]? [{MIN|MAX}]**

Définit le niveau déclenché de la sortie. S'applique lorsque la source de déclenchement de la mesure est définie sur un niveau. Les valeurs sont exprimées en ampères ou en volts. Les valeurs minimale et maximale varient selon les valeurs nominales de l'appareil.

Paramètre	Renvoi type
Voltage (Tension) : 0 à 102 % de la valeur nominale, *RST 0 Current (Courant) : -102 à 102 % de la valeur nominale	<valeur de niveau>
Régler le niveau de courant déclenché sur 3 A : TRIG:ACQ:CURR 3 Régler le niveau de tension déclenché sur 50 V : TRIG:ACQ:VOLT 50	

**TRIGger:ACQuire:CURRent:SLOPe POSitive|NEGative**  
**TRIGger:ACQuire:CURRent:SLOPe?**  
**TRIGger:ACQuire:VOLTage:SLOPe POSitive|NEGative**  
**TRIGger:ACQuire:VOLTage:SLOPe?**

Définit la pente du signal. S'applique lorsque la source de déclenchement de la mesure est définie sur un niveau. **POSitive** indique une pente ascendante du signal de sortie. **NEGative** indique une pente descendante du signal de sortie.

Paramètre	Renvoi type
POSitive NEGative, *RST POSitive	POS ou NEG
Définir une pente de courant négative (front descendant) : TRIG:ACQ:CURR:SLOP NEG	
Définir une pente de tension négative (front descendant) : TRIG:ACQ:VOLT:SLOP NEG	

**TRIGger:ACQuire:INDices[:DATA]?**

Renvoie les indices dans les données acquises où les déclenchements ont été capturés pendant l'acquisition. Le nombre d'indices renvoyés est identique à la valeur renvoyée par la commande TRIGger:ACQuire:INDices:COUNT?

Paramètre	Renvoi type
(aucun)	<temps>
Renvoie le nombre d'indices : TRIG:ACQ:IND?	

**TRIGger:ACQuire:INDices:COUNT?**

Renvoie le nombre de déclenchements capturés pendant l'acquisition.

Paramètre	Renvoi type
(aucun)	<temps>
Renvoyer le nombre de déclenchements : TRIG:ACQ:IND:COUN?	

**TRIGger:ACQuire:SOURce <source>**  
**TRIGger:ACQuire:SOURce?**

Sélectionne la source de déclenchement du système d'acquisition :

<b>BUS</b>	Sélectionne une commande de déclenchement de l'interface de commande à distance.
<b>CURRent1</b>	Sélectionne un niveau de courant de sortie.
<b>EXternal</b>	Sélectionne TOUTES les broches du port numérique qui ont été configurées comme sources de déclenchement.
<b>PIN&lt;1-7&gt;</b>	Sélectionne une broche de port numérique configurée comme entrée de déclenchement.
<b>TRANSient1</b>	Sélectionne le système de transitoire comme source de déclenchement.
<b>VOLTage1</b>	Sélectionne un niveau de tension de sortie.

Paramètre	Renvoi type
BUS CURRent1   EXTernal   PIN<1-7>   TRANsient1   VOLTage1, *RST BUS	BUS, CURR1, EXT, PIN<n>, TRAN1 ou VOLT1
Sélectionner la broche 1 du port numérique comme source de déclenchement de mesure : TRIG:ACQ:SOUR PIN1	

### TRIGger:ACQuire:TOUTput[:ENABLE] 0|OFF|1|ON TRIGger:ACQuire:TOUTput[:ENABLE]?

Active les déclencheurs de mesure à envoyer à une broche de port numérique. La broche du port numérique doit être configurée comme sortie de déclenchement avant de pouvoir être utilisée comme source de déclenchement (voir **E/S de déclenchement externe**).

Paramètre	Renvoi type
0 OFF 1 ON, *RST OFF	0 ou 1
Activer l'envoi de déclencheurs de mesure aux broches numériques : TRIG:ACQ:TOUT ON	

### TRIGger:ARB:SOURce <source> TRIGger:ARB:SOURce? TRIGger:ELOG:SOURce <source> TRIGger:ELOG:SOURce? TRIGger:TRANsient:SOURce <source> TRIGger:TRANsient:SOURce?

TRIG:ARB:SOURce - Sélectionne la source de déclenchement des signaux arbitraires :

TRIG:ELOG:SOURce - Sélectionne la source de déclenchement de l'enregistrement de données externe :

TRIG:TRANsient:SOURce - Sélectionne la source de déclenchement du système de transitoire :

- BUS** Sélectionne une commande de déclenchement de l'interface de commande à distance.
- EXTernal** Sélectionne TOUTES les broches du port numérique qui ont été configurées comme sources de déclenchement.
- IMMediate** Déclenche le transitoire dès que la commande INITiated est exécutée.
- PIN<1-7>** Sélectionne une broche de port numérique configurée comme entrée de déclenchement.

Paramètre	Renvoi type
BUS   EXTernal   IMMediate   PIN<1-7> *RST BUS	BUS, EXT, IMM, PIN<n>
Sélectionner la broche 1 du port numérique comme source de déclenchement du signal arbitraire : TRIG:ARB:SOUR PIN1	
Sélectionner la broche 1 du port numérique comme source de déclenchement du transitoire : TRIG:TRAN:SOUR PIN1	

## Sous-système VOLTage

Les commandes Voltage permettent de programmer la tension de sortie de l'instrument.

**[SOURce:]VOLTage[:LEVel][:IMMediate][:AMPLitude] <valeur>|MIN|MAX**  
**[SOURce:]VOLTage[:LEVel][:IMMediate][:AMPLitude]? [{MIN|MAX}]**  
**[SOURce:]VOLTage[:LEVel]:TRIGgered[:AMPLitude] <valeur>|MIN|MAX**  
**[SOURce:]VOLTage[:LEVel]:TRIGgered[:AMPLitude]? [{MIN|MAX}]**

Définit le niveau de tension immédiat ou déclenché lorsque la sortie fonctionne en mode de priorité de tension. Le niveau déclenché est la valeur qui est transférée vers la sortie lors du déclenchement d'un palier de sortie. Les unités sont exprimées en volts. La valeur maximale varie selon la tension nominale de l'appareil.

Paramètre	Renvoi type
0.1 à 102 % de la valeur nominale, *RST 0.1 % de la valeur nominale	<niveau de tension>
Définit la tension de sortie à 20 V : <code>VOLT 20</code> Définit la tension déclenchée à 10 V : <code>VOLT:TRIG 10</code>	

**[SOURce:]VOLTage:BWIDth:LEVel 0 | 1 | 2, <valeur>|MIN|MAX**  
**[SOURce:]VOLTage:BWIDth:LEVel? 0 | 1 | 2, [{MIN|MAX}]**

Définit la fréquence polaire d'angle de programmation associée à chaque plage de compensation. La valeur est en Hertz. La fréquence par défaut est optimisée pour une vitesse de programmation amont maximale, ainsi que pour le temps de réponse transitoire le plus rapide. Il est possible de la réduire pour compenser les dépassements de sortie.

Paramètre	Renvoi type
0   1   2 (plage de bande passante)	0, 1 ou 2
10 à 100 000 pour toutes les plages, *RST : 5 000 (comp0), 450 (comp1), 12 (comp2)	<Fréquence d'angle>
Définit la plage de bande passante de tension à 1, fréquence 10 kHz : <code>VOLT:BWID:LEV 1, 10,000</code>	

**[SOURce:]VOLTage:BWIDth:RANGe 0 | 1 | 2**  
**[SOURce:]VOLTage:BWIDth:RANGe?**

Définit la plage de compensation de tension. Cette commande vous permet d'optimiser le temps de réponse de la sortie avec des charges capacitives. Ces modes de compensation ne s'appliquent que lorsque l'appareil fonctionne en tension constante (CV), à la fois en priorité de tension et en priorité de courant (lorsqu'elle est en limite de tension). Reportez-vous à la section **Configurer la bande passante de sortie** pour plus d'informations sur l'effet des réglages de la compensation sur les caractéristiques de la vitesse de programmation.

## 5 Aide-mémoire de la programmation SCPI

0 (haute vitesse/charge capacitive faible) : indique la vitesse de programmation la plus rapide et le temps de réponse transitoire.

1 (vitesse moyenne/charge capacitive moyenne) : indique une vitesse de programmation intermédiaire et un temps de réponse transitoire. Le réglage est optimisé pour la stabilité avec une large gamme de condensateurs de sortie.

2 (vitesse faible/charge capacitive élevée) : convient mieux aux appareils testés à haute capacité/faible ESR avec compromis entre la vitesse de programmation plus lente et la réponse transitoire.

Paramètre	Renvoi type
0 1 2, *RST0	0, 1 ou 2

Définit la bande passante de tension sur comp 1 : `VOLT:BWID:RANG 1`

**[SOURce:]VOLTage:LIMit[:POSitive][:IMMEDIATE][:AMPLitude] <valeur>|MIN|MAX[SOURce:]VOLTage:LIMit[:POSitive][:IMMEDIATE][:AMPLitude]? [{MIN|MAX}]**

Définit la limite de tension en mode de priorité de courant. Les unités sont exprimées en volts.

Paramètre	Renvoi type
0.1 à 102 % de la valeur nominale, *RST 1 % de la valeur nominale	<limite de tension>

Définit la limite de tension à 20 V : `VOLT:LIM 20`

**[SOURce:]VOLTage:LIMit:LOW <valeur>|MIN|MAX  
[SOURce:]VOLTage:LIMit:LOW? [{MIN|MAX}]**

Définit la limite de sous-tension en mode de priorité de courant. Ceci permet d'éviter que la tension ne descende en dessous de la limite de sous-tension lors du déchargement d'une batterie. Lorsque la tension chute à la valeur limite inférieure spécifiée, la sortie passe de la priorité de courant à la limite de tension négative et le déchargement s'arrête. Ceci active le bit LIM- dans le registre d'état suspect.

Paramètre	Renvoi type
0 à 102 % de la valeur nominale, *RST 0	<limite de sous-tension>

Définit la limite de sous-tension à 2 V : `VOLT:LIM:LOW 2`

- Cette commande est couplée à la commande `VOLTage:LIMit`. La limite de tension doit toujours être programmée à une valeur supérieure à la limite de sous-tension.
- La limite de sous-tension empêche également la sortie de se mettre en marche lorsque la tension de sortie est inférieure à la limite de sous-tension programmée. Reportez-vous à `VOLTage:PROTECTION:LOW:DELAY`.

**[SOURce:]VOLTage:LIMit:LOW:STATe 0|OFF|1|ON**  
**[SOURce:]VOLTage:LIMit:LOW:STATe?**

Active ou désactive la limite de sous-tensions.

Paramètre	Renvoi type
0 OFF 1 ON, *RST OFF	0 ou 1
Activer l'état de limite de sous-tensions : <code>VOLT:LIM:LOW:STAT ON</code>	

**[SOURce:]VOLTage:MODE FIXed|STEP|LIST|ARB**  
**[SOURce:]VOLTage:MODE?**

Définit le mode de transitoire. Cette commande détermine ce qu'il advient de la tension de sortie lorsque le système de transitoire est démarré et déclenché.

**FIXed** maintient la tension de sortie définie à sa valeur immédiate.

**STEP** (palier) fait passer la sortie au niveau déclenché lorsqu'un déclenchement se produit.

**ARB** entraîne la mise en conformité de la sortie aux valeurs de liste lorsqu'un déclenchement se produit.

**ARB** provoque la conformité de la sortie aux valeurs du signal arbitraire lorsqu'un déclenchement se produit.

Paramètre	Renvoi type
FIXed STEP LIST ARB, *RST FIXed	FIX, STEP, LIST ou ARB
Définit le mode de tension sur Step : <code>VOLT:MODE STEP</code>	

**[SOURce:]VOLTage:PROTection[:LEVel] <valeur>|MIN|MAX**  
**[SOURce:]VOLTage:PROTection[:LEVel]? [{MIN|MAX}]**

Règle le niveau de protection contre les surtensions. Les unités sont exprimées en volts. Si la tension de sortie dépasse le niveau OVP, la sortie est désactivée et le bit OV du registre d'état des conditions suspectes est activé.

Paramètre	Renvoi type
0 à 120% de la valeur nominale, *RST 120% de la valeur nominale	<niveau de protection>
Règle la protection contre les surtensions à 24 V : <code>VOLT:PROT 24</code>	

- Une condition de surtension peut être annulée à l'aide de la commande `OUT-put:PROTection:CLEar` une fois la cause du problème isolée.

**[SOURce:]VOLTage:PROTection:LOW[:LEVel] <valeur>|MIN|MAX**  
**[SOURce:]VOLTage:PROTection:LOW[:LEVel] ? [{MIN|MAX}]**

Évite l'activation de la sortie si la tension de sortie est inférieure au niveau de protection contre les sous-tensions. Lorsque la condition de sous-tension est vraie, le bit UV du registre d'état suspect est défini.

Paramètre	Renvoi type
0 à 102 % de la valeur nominale, *RST 0	<réglage de la protection contre les sous-tensions>
Règle le niveau de protection à 2 V : VOLT:PROT:LOW 2	

**[SOURce:]VOLTage:PROTection:LOW:DELaY <valeur>|MIN|MAX**  
**[SOURce:]VOLTage:PROTection:LOW:DELaY? [{MIN|MAX}]**

Définit le délai de protection contre les sous-tensions en secondes. La fonction de protection contre les sous-tensions n'est pas déclenchée pendant le délai de temporisation. Une fois le délai expiré, la fonction de protection contre les sous-tensions est activée. Cette fonction peut être utilisée pour supprimer un déclenchement intempestif lorsque la protection contre les sous-tensions a été activée et que la sortie est activée, ou lorsque la tension est programmée de 0 à une valeur supérieure au niveau de protection contre les sous-tensions.

Notez que si vous activez la protection contre les sous-tensions et que vous activez ensuite la sortie sans utiliser le délai, la protection se déclenchera immédiatement lorsque la tension de sortie commencera à augmenter à partir de zéro, ce qui est inférieur au niveau de protection contre les sous-tensions.

Paramètre	Renvoi type
0,00002048 - 2 611 secondes *RST 20,48 µs	<valeur de délai>
Définit le délai de protection à 0,2 seconde : VOLT:PROT:LOW:DEL 0.2	

**[SOURce:]VOLTage:PROTection:LOW:STATe 0|OFF|1|ON**  
**[SOURce:]VOLTage:PROTection:LOW:STATe?**

Active ou désactive la protection contre les surtensions.

Paramètre	Renvoi type
0 OFF 1 ON, *RST OFF	0 ou 1
Activer l'état de protection contre les sous-tensions : VOLT:PROT:LOW:STAT ON	

- Une condition de sous-tension peut être annulée à l'aide de la commande OUTPut:PROTection:CLEar, une fois la cause du problème éliminée.

**[SOURce:]VOLTage:RESistance[:LEVel][:IMMediate][:AMPLitude] <valeur>|MIN|MAX**  
**[SOURce:]VOLTage:RESistance[:LEVel][:IMMediate][:AMPLitude]? [{MIN|MAX}]**

Définit le niveau de résistance de sortie. Ne s'applique qu'en mode de priorité de tension. Les unités sont exprimées en ohms. Pour connaître les plages de programmation de résistance spécifiques à un modèle, reportez-vous aux tableaux des **Caractéristiques**.

Paramètre	Renvoi type
0 à maximum (selon le modèle)   MIN   MAX, *RST 0	0
Indique une résistance de sortie de 0,5 ohm : <code>VOLT:RES 0.5</code>	

- Lorsque les appareils sont connectés en parallèle, la résistance de sortie maximale est réduite. La résistance programmable pour un seul appareil doit être divisée par le nombre total d'appareils connectés en parallèle.

**[SOURce:]VOLTage:RESistance:STATe 0|OFF|1|ON**  
**[SOURce:]VOLTage:RESistance:STATe?**

Active ou désactive la programmation de résistance de sortie. Ne s'applique qu'en mode de priorité de tension.

Paramètre	Renvoi type
0 OFF 1 ON, *RST OFF	0 ou 1
Active la programmation de la résistance : <code>VOLT:RES:STAT ON</code>	

**[SOURce:]VOLTage:SLEW[:IMMediate] <valeur>|MIN|MAX|INFinity**  
**[SOURce:]VOLTage:SLEW[:IMMediate]? [{MIN|MAX}]**

Définit la vitesse de balayage de tension. La vitesse de balayage est définie en volts par seconde et concerne toutes les variations de tension programmées, notamment celles dues à l'activation ou la désactivation de l'état de sortie. La vitesse de balayage peut être réglée sur n'importe quelle valeur comprise entre 0 et  $9,9E + 37$ . Pour les valeurs très élevées, la vitesse de balayage est limitée par la vitesse de programmation et la bande passante indiquées de l'appareil. Les mots-clés MAX ou INFinity définissent la vitesse de balayage à la valeur maximale.

Paramètre	Renvoi type
0 à $9,9E+37$ , *RST MAX	<valeur max.>
Définit la vitesse de balayage de sortie à 5 V par seconde : <code>VOLT:SLEW 5</code>	

- La requête renvoie la valeur qui a été envoyée. Si la valeur est inférieure à la vitesse de balayage minimale, la valeur minimale est renvoyée. La résolution du réglage de balayage est la même que la valeur minimale. Il est possible d'effectuer une recherche en utilisant `VOLTage:SLEW? MIN`. La valeur exacte varie sensiblement selon l'étalonnage.



**[SOURce:]VOLTage:SLEW:MAXimum 0|OFF|1|ON**  
**[SOURce:]VOLTage:SLEW:MAXimum?**

Active ou désactive le remplacement de la vitesse de balayage maximale. Lorsqu'elle est activée, la vitesse de balayage est définie à sa valeur maximale. Lorsqu'elle est désactivée, la vitesse de balayage est définie à la valeur immédiate par la commande VOLTage:SLEW. Utilisez VOLTage:SLEW? MAX pour rechercher la vitesse de balayage maximale qui a été définie.

Paramètre	Renvoi type
0 OFF 1 ON, *RST ON	0 ou 1
Activer le remplacement de la vitesse de balayage maximale : VOLT:SLEW:MAX ON	

- La commande VOLTage:SLEW:MAX est associée à la commande VOLTage:SLEW. Si VOLTage:SLEW définit la vitesse sur MAX ou INFINITY, la commande VOLTage:SLEW:MAX est activée. Si la vitesse de balayage est définie sur une autre valeur, la commande VOLTage:SLEW:MAX est désactivée.

## Didacticiel d'état

Cette section contient une description détaillée des registres et des groupes de registres. Le schéma d'état fournit une représentation graphique de la manière dont les registres d'état et les groupes sont interconnectés.

### Registres d'état

#### Groupe d'état de fonctionnement

#### Groupes d'état suspects

#### Groupe d'états d'événement standard

#### Registre d'octet d'état

#### Files d'erreurs et de sortie

#### Schéma d'état

## Registres d'état

Les groupes d'état de fonctionnement et suspect utilisent quatre types de registres différents pour suivre les événements de qualification, de repérage et d'activation de l'instrument. Le groupe d'événements standard n'utilise que les registres des événements et d'activation.

- Un registre de conditions surveille continuellement l'état de l'instrument. Les bits du registre de conditions sont mis à jour en temps réel et ne sont pas verrouillés.
- Un registre PTR/NTR qualifie le signal qui est transmis au registre des événements. Lorsqu'un bit PTR est activé, les signaux à transition de front positive sont transmis au registre des événements. Lorsqu'un bit NTR est activé, les signaux à transition de front négative sont transmis au registre des événements. Lorsque les deux bits sont activés, tous les signaux sont transmis. Si aucun bit n'est activé, aucun signal n'est transmis.
- Un registre d'événements verrouille les transitions qui traversent les registres PTR et NTR. Lorsqu'un bit d'événement est activé, il maintient cet état jusqu'à ce la lecture du registre des événements. Une fois lu, le registre des événements est effacé.
- Un registre d'activation définit les bits du registre des événements qui seront signalés au registre de l'octet d'état. Vous pouvez écrire ou lire à partir d'un registre d'activation.

## Groupe d'état de fonctionnement

Ces registres enregistrent les signaux qui se produisent dans des conditions de fonctionnement normales. Les groupes comprennent un registre des conditions, PTR/NTR, des événements et d'activation. Les sorties de groupe de registres d'état de fonctionnement sont conditionnées par

l'opérateur OU de façon logique dans le bit récapitulatif OPERation (7) du registre de l'octet d'état. Voir **Schéma d'état**.

Le tableau suivant décrit les affectations de bits du registre d'état de fonctionnement.

Bit	Nom du bit	Valeur décimale	Définition
0	CV	1	La sortie est en mode de tension constante
1	CC	2	La sortie est en mode de courant constant
2	OFF	4	La sortie est programmée hors tension ou est en état de protection
3	WTG-meas	8	Le système de mesure attend un événement de déclenchement
4	WTG-tran	16	Le système de transitoire attend un événement de déclenchement
5	MEAS-active	32	La mesure est initialisée ou en cours
6	TRAN-active	64	Le transitoire est démarré ou en cours
7-15	non utilisé	non utilisé	La valeur 0 est renvoyée

### Groupes d'état suspects

Ces registres enregistrent des signaux qui indiquent un fonctionnement anormal. Les groupes comprennent un registre des conditions, PTR/NTR, des événements et d'activation. Les sorties des groupes d'état suspect sont conditionnées par l'opérateur OU de façon logique dans le bit récapitulatif QUEStionable (3) du registre de l'octet d'état. Voir **Schéma d'état**.

Le tableau suivant décrit les affectations de bits du registre d'état suspect 1.

Bit	Nom du bit	Valeur décimale	Définition
0	OV	1	La sortie est désactivée par la protection contre les surtensions
1	OC	2	La sortie est désactivée par la protection contre les surintensités
2	PF	4	La sortie est désactivée par une panne d'alimentation secteur (alimentation secteur faible ou coupure de courant de l'alimentation secteur)
3	OP+	8	La sortie est désactivée par la limite de surpuissance positive
4	OT	16	La sortie est désactivée par la protection contre les surchauffes
5	OP-	32	La sortie est désactivée par la limite de surpuissance négative
6	OV-	64	La sortie est désactivée par la protection contre les surtensions négatives

7	LIM+	128	La sortie est en mode de limitation de tension positive ou de courant positif
8	LIM-	256	La sortie est en mode de limitation de tension négative ou de courant négatif
9	INH	512	La sortie est désactivée par un signal INHibit externe
10	UNR	1024	La sortie n'est pas régulée
11	PROT	2048	La sortie est désactivée par une protection du temporisateur de surveillance
12	EDP	4096	La sortie est désactivée par une protection contre les dynamiques de sortie excessives
13-15	non utilisé	non utilisé	La valeur 0 est renvoyée

Le tableau suivant décrit les affectations de bits du registre d'état suspect 2.

Bit	Nom du bit	Valeur décimale	Définition
0	non utilisé	non utilisé	La valeur 0 est renvoyée
1	IPK+	2	La sortie est en mode de limitation de courant de crête positive
2	IPK-	4	La sortie est en mode de limitation de courant de crête négative
3	CSF	8	Une erreur de partage de courant s'est produite
4	PSP	16	La sortie est désactivée par une protection principale/secondaire
5	non utilisé	non utilisé	La valeur 0 est renvoyée
5	non utilisé	non utilisé	La valeur 0 est renvoyée
6	UV	64	Une protection contre les sous-tensions s'est déclenchée
7	OCF	128	Une protection contre les erreurs de surintensité interne s'est déclenchée
8	LOV	256	Une protection contre les erreurs de surtension interne s'est déclenchée
9	DOV	512	Une protection contre les erreurs de surtension appliquée par le DUT s'est déclenchée
10-15	non utilisé	non utilisé	La valeur 0 est renvoyée

### Groupe d'états d'événement standard

Ces registres sont programmés par les commandes courantes. Le groupe comprend un registre des événements et d'activation. Le registre des événements standard verrouille les événements relatifs à l'état de communication. Il s'agit d'un registre en lecture seule qui est effacé après lecture. Le registre d'activation des événements standard fonctionne de la même manière que les registres d'activation des groupes d'état de fonctionnement et suspect. Voir [Schéma d'état](#).

Le tableau suivant décrit les affectations de bits du registre d'état des événements standard.

Bit	Nom du bit	Valeur décimale	Définition
0	Opération terminée	1	Toutes les commandes précédant et incluant *OPC ont été exécutées.
1	non utilisé	non utilisé	La valeur 0 est renvoyée
2	Erreur de requête	4	L'appareil a tenté de lire le tampon de sortie, mais celui-ci était vide, une nouvelle commande a été passée avant de lire une requête précédente ou les deux tampons d'entrée et de sortie sont saturés.
3	Erreur spécifique à l'appareil	8	Une erreur de l'appareil, notamment une erreur d'autotest, une erreur d'étalonnage ou une autre erreur spécifique à l'appareil, s'est produite. <b>Messages d'erreur</b>
4	Erreur d'exécution	16	Une erreur d'exécution s'est produite. <b>Messages d'erreur</b>
5	Commande	32	Une erreur de syntaxe de commande s'est produite. <b>Messages d'erreur</b>
6	non utilisé	non utilisé	La valeur 0 est renvoyée
7	Mise sous tension	128	L'alimentation a été coupée et rétablie depuis la dernière lecture ou le dernier effacement du registre des événements.

### Registre d'octet d'état

Ce registre récapitule les informations provenant de tous les autres groupes d'état définis dans l'interface numérique standard IEEE 488.2 pour l'instrumentation programmable. Voir **Schéma d'état**.

Le tableau suivant décrit les affectations de bits du registre de l'octet d'état.

Bit	Nom du bit	Valeur décimale	Définition
0	non utilisé	non utilisé	La valeur 0 est renvoyée
1	non utilisé	non utilisé	La valeur 0 est renvoyée
2	File d'erreurs	4	Une ou plusieurs erreurs dans la file des erreurs. Utilisez la commande SYSTem:ERRor? pour lire et supprimer les erreurs.
3	Récapitulatif d'état suspect	8	Un ou plusieurs bits sont activés dans le registre de données suspectes. Les bits doivent être activés. Voir STATus:QUES-tionable:ENABLE.
4	Message disponible	16	Des données sont disponibles dans la mémoire tampon de sortie de l'instrument.
5	Récapitulatif de l'état des événements	32	Un ou plusieurs bits sont activés dans le registre des événements standard. Les bits doivent être activés. Voir <b>*ESE</b> .
6	Récapitulatif d'état général	64	Un ou plusieurs bits sont définis dans le registre d'octet d'état et peuvent générer une demande de service. Les bits doivent être activés. Voir <b>*SRE</b> .

---

7	Récapitulatif d'état de fonctionnement	128	Un ou plusieurs bits sont activés dans le registre d'état de fonctionnement. Les bits doivent être activés. Voir <b>STATus:OPERation:ENABle</b> .
---	----------------------------------------	-----	---------------------------------------------------------------------------------------------------------------------------------------------------

---

### Bits du récapitulatif d'état général et de demande de service

MSS est un récapitulatif (verrouillé) en temps réel de tous les bits du registre de l'octet d'état qui sont activés par le registre d'activation de demande de service. MSS est activé chaque fois que l'instrument a une ou plusieurs raisons de demander un service. \*STB? lit le MSS dans la position de bit 6 de la réponse, mais n'efface aucun bit du registre de l'octet d'état.

Le bit RQS est une version verrouillée du bit MSS. Chaque fois que l'instrument demande un service, il définit la ligne d'interruption sur SRQ comme vraie et verrouille RQS dans le bit 6 du registre de l'octet d'état. Lorsque le contrôleur effectue une interrogation série, RQS est effacé dans le registre et revient à la position de bit 6 de la réponse. Les autres bits du registre de l'octet d'état ne sont pas perturbés.

### Files d'erreurs et de sortie

La file d'erreurs est un registre de données FIFO (premier entré/premier sorti) qui enregistre une description numérique et textuelle d'une erreur ou d'un événement. Les messages d'erreur sont stockés jusqu'à leur lecture avec la commande **SYSTem:ERRor?** En cas de dépassement de la file, la dernière erreur ou le dernier événement de la file est remplacé par l'erreur -350, "Queue overflow" (Dépassement de la capacité de la file d'attente).

La file de sortie est un registre de données FIFO (premier entré/premier sorti) qui enregistre les messages jusqu'à leur lecture par le contrôleur. Chaque fois que la file contient des messages, elle active le bit MAV (4) du registre de l'octet d'état.

### Schéma d'état

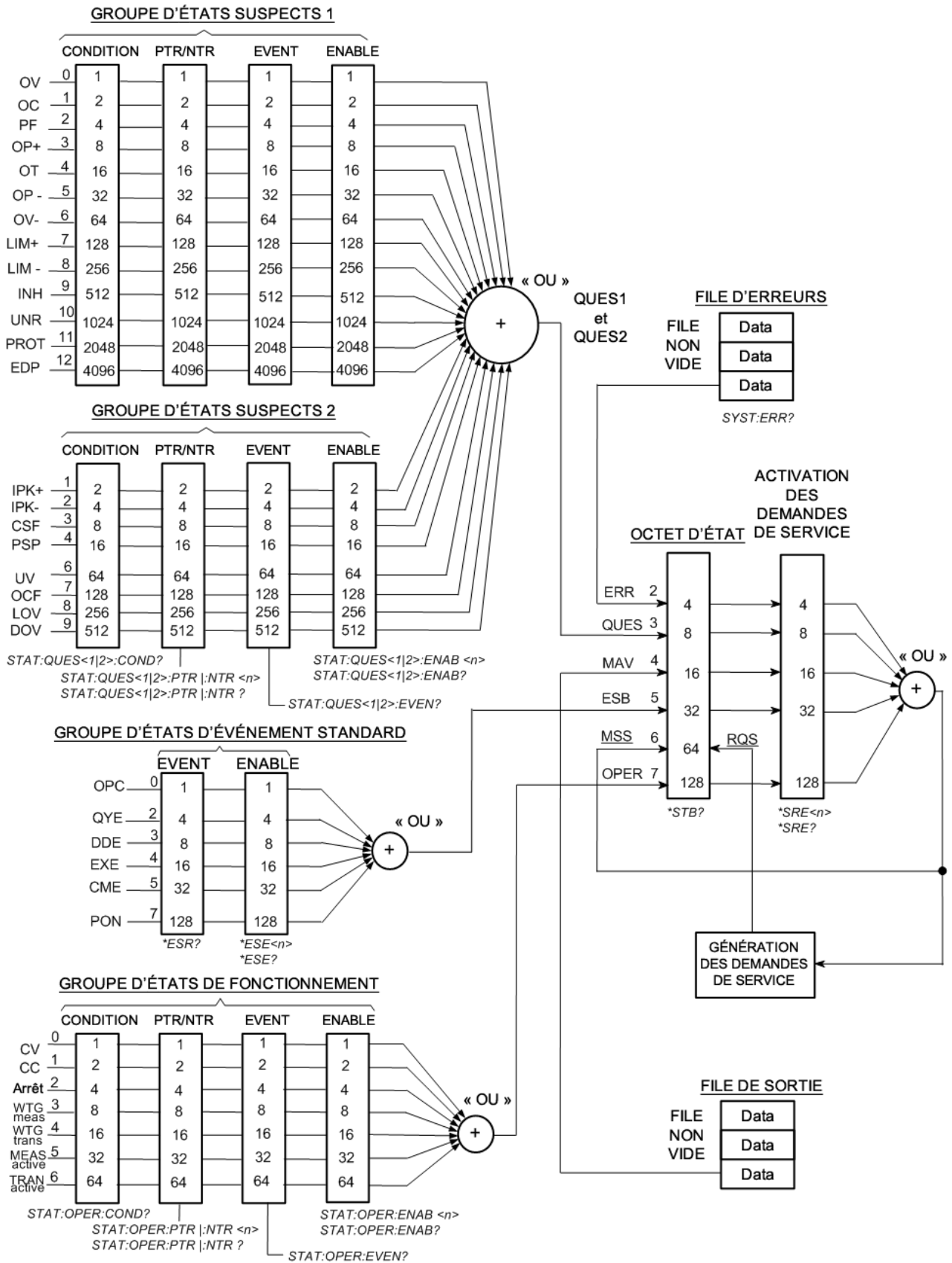

## Didacticiel de déclenchement

Le système de déclenchement est un système à usage universel et flexible qui contrôle l'utilisation de l'instrument afin de l'adapter à un large éventail d'applications définies par l'utilisateur. Le schéma de déclenchement ci-dessous fournit une représentation graphique de la façon dont les sources et les destinations de déclenchement sont interconnectées.

### Sources de déclenchement

### Destinations de déclenchement

### Schéma de déclenchement

## Sources de déclenchement

Le tableau suivant décrit les sources de déclenchement disponibles, indiquées sur la gauche du schéma de déclenchement. Toutes les sources de déclenchement ne peuvent pas être appliquées à chaque sous-système de déclenchement.

Source	Description
BUS	Active les déclenchements du périphérique GPIB, *TRG ou <GET> (Group Execute Trigger).
CURR1	Sélectionne un niveau de courant de sortie.
IMMEDIATE	Déclenche le transitoire dès que la commande INITiated est exécutée.
PIN<n> EXTERNAL	Sélectionne une broche de port numérique configurée comme entrée de déclenchement. <n> indique le numéro de la broche. EXTERNAL permet de sélectionner TOUTES les broches du connecteur qui ont été configurées comme entrées de déclenchement.
TRAN1	Sélectionne le système de transitoire comme source de déclenchement.
TRIG:ACQ:IMM	Déclenche immédiatement l'acquisition.
TRIG:TRAN:IMM	Déclenche immédiatement le transitoire.
VOLT1	Sélectionne un niveau de tension de sortie.

## Destinations de déclenchement

Le tableau suivant décrit les destinations du système de déclenchement.

Destination	Description
Broche numérique	Envoie le déclenchement à la broche numérique désignée. Voir <a href="#">Programmation du port numérique</a> .
Système transitoire	Envoie le déclenchement au transitoire désigné (STEP, BOST, EOST)
Système d'acquisition	Envoie le déclenchement au système d'acquisition (TOUT)



## Schéma de déclenchement

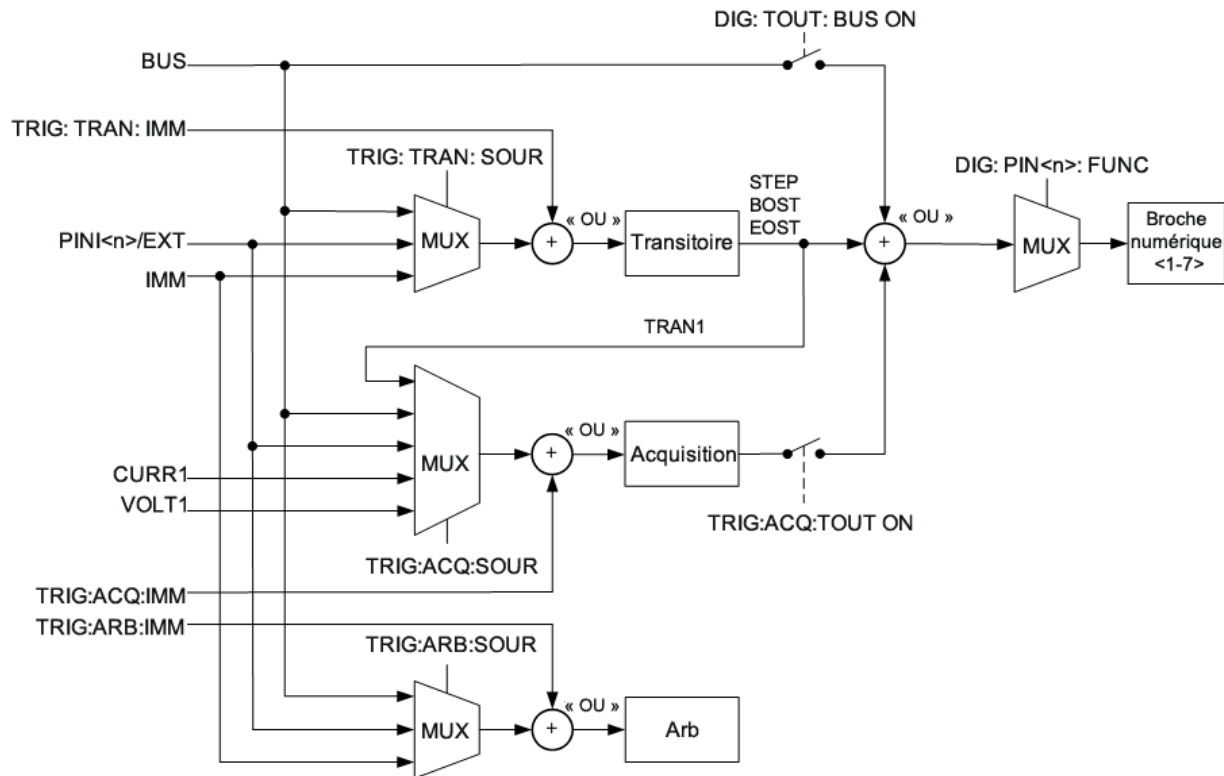

## État de réinitialisation (\*RST)

**REMARQUE** La configuration à la mise sous tension ou après une réinitialisation peut être différente de celle indiquée ci-dessous si vous avez activé le mode de rappel de la configuration à la mise sous tension dans le menu **States** (voir **Stockage des configurations de l'instrument**).

### Paramètres de réinitialisation

Le tableau suivant illustre l'état de réinitialisation. Ces paramètres sont réinitialisés avec les valeurs indiquées à la mise sous tension ou après la commande \*RST.

Commande SCPI	Paramètres *RST
ARB:COUNT	1
ARB:CURRENT:CDWell:DWELL	0,001
ARB:FUNCTION:SHAPE	CDW
ARB:FUNCTION:TYPE	VOLTage
ARB:TERMINate:LAST	OFF
ARB:VOLTage:CDWell:DWELL	0,001
CALibrate:STATE	OFF
CURRENT	0
CURRENT:LIMit	1,02% de la valeur nominale
CURRENT:LIMit:NEGative	-1,02% de la valeur nominale
CURRENT:MODE	FIXed
CURRENT:PROTection:DELay	20 ms
CURRENT:PROTection:DELay:START	SCHange
CURRENT:PROTection:STATE	OFF
CURRENT:SLEW	MAX
CURRENT:SLEW:MAXimum	ON
CURRENT:TRIGgered	0
DIGital:OUTPut:DATA	0
DIGital:TOUTput:BUS	OFF
DISPlay	ON

## 5 Aide-mémoire de la programmation SCPI

Commande SCPI	Paramètres *RST
DIGital:OUTPut:DATA	0
DIGital:TOUTPut:BUS	OFF
FORMat:DATA	ASCII
FORMat:BORDER	NORMAL
FUNCTion	VOLTage
INITialize:CONTInuous:TRANsient	OFF
LIST:COUNT	1
LIST:CURREnt	1 palier réglé sur 0
LIST:DWELL	1 palier réglé sur 0,001
LIST:STEP	AUTO
LIST:TERMinate:LAST	OFF
LIST:TOUTput:BOStep	1 palier réglé sur OFF (DÉSACTIVÉ)
LIST:TOUTput:EOStep	1 palier réglé sur OFF (DÉSACTIVÉ)
LIST:VOLTage	1 palier réglé sur 0,1 % de la valeur nominale
LXI:IDENtify	OFF
LXI:MDNS	ON
OUTPut	OFF
OUTPut:DELay:FALL	0
OUTPut:DELay:RISE	0
OUTPut:PROTEction:WDOG	OFF
OUTPut:PROTEction:WDOG:DELay	60
RESistance	0
RESistance:STATe	0
SASimulator:BWIDth:RANGe	0
SASimulator:CURVe:IMP	± 0,8 % de la valeur nominale
SASimulator:CURVe:ISC	± 1 % de la valeur nominale
SASimulator:CURVe:VMP	± 0,8 % de la valeur nominale
SASimulator:CURVe:VOC	± 1 % de la valeur nominale
SASimulator:CURVe:SHAPE	SPACE

Commande SCPI	Paramètres *RST
SASimulator:SCALe:CURRent	100%
SASimulator:SCALe:VOLTage	100%
SASimulator:MODE	FIXed
SENSe:CURRent:RANGe:AUTO	0
SENSe:FUNCTion:CURRent	1
SENSe:FUNCTion:VOLTage	1
SENSe:SWEep:NPLCycles	1
SENSe:SWEep:OFFSet:POINts	0
SENSe:SWEep:POINts	3255 (60 Hz) ; 3906 (50 Hz)
SENSe:SWEep:TINTerval	5.12E-6
SENSe:WINDow	RECTangular
STEP:TOUTput	OFF
TRIGger:ACQuire:CURRent	0
TRIGger:ACQuire:CURRent:SLOPe	POSitive
TRIGger:ACQuire:SOURce	BUS
TRIGger:ACQuire:TOUTput	OFF
TRIGger:ACQuire:VOLTage	0
TRIGger:ACQuire:VOLTage:SLOPe	POSitive
TRIGger:ARB:SOURce	BUS
TRIGger:TRANSient:SOURce	BUS
VOLTage	0,1% de la valeur nominale
VOLTage:LIMit	1,02% de la valeur nominale
VOLTage:LIMit:LOW:STATe	0
VOLTage:MODE	FIXed
VOLTage:PROTection	120% de la valeur nominale
VOLTage:PROTection:LOW:STATe	0
VOLTage:RESistance	0
VOLTage:RESistance:STATe	OFF
VOLTage:SLEW	MAX

## 5 Aide-mémoire de la programmation SCPI

Commande SCPI	Paramètres *RST
VOLTage:SLEW:MAXimum	ON
VOLTage:TRIGgered	0,1% de la valeur nominale

### Paramètres non volatiles

Le tableau suivant décrit les réglages d'usine des paramètres **non volatiles**. Ces derniers ne sont pas affectés par une remise sous tension ou la commande \*RST.

Commande SCPI	Paramètres tels qu'expédiés
CALibrate:DATE	chaîne vide
CALibrate:PASSword	0
DIGital:PIN<toutes>:FUNCtion	DINPut
DIGital:PIN<toutes>:POLarity	POSitive
DISPlay:VIEW	METER_VI
INSTrument:GROup:FUNCtion	NONE
INSTrument:GROup:SECondary:ADDRess	1
OUTPut:COUPle	OFF
OUTPut:COUPle:DOFFset	0
OUTPut:INHibit:MODE	OFF
OUTPut:PON:STATE	RST
OUTPut:RELay:LOCK	OFF
SYSTem:LFRequency:MODE	AUTO
<b>Paramètres d'usine du panneau avant</b>	
Mot de passe de verrouillage du panneau avant	Désactivé
Mise à jour du microprogramme protégée par mot de passe	Désactivé
Adresse GPIB	5
Interface GPIB	Activé
Interface LAN	Activé
Interface USB	Activé
Écran de veille	Activé
Délai d'activation de l'écran de veille	60 minutes

Commande SCPI	Paramètres tels qu'expédiés
Réveil par l'E/S	Activé
<b>Paramètres d'usine de l'interface</b>	
Obtenir l'adresse GPIB	Automatique
Masque de sous-réseau	255.255.0.0
Passerelle par défaut	0.0.0.0
Nom d'hôte	K- <nom du modèle> - <5 derniers chiffres du numéro de série>
Nom du service mDNS	Keysight Système d'alimentations régénératrices RP79xxx <numéro de série>
Service LAN - VXI-11	Activé
Service LAN - Telnet	Activé
Service LAN - mDNS	Activé
Service LAN - serveur Web	Activé
Service LAN - sockets	Activé
Mot de passe Web	Vide (le mot de passe web est désactivé)

## Messages d'erreur SCPI

L'instrument Keysight renvoie des messages d'erreur conformes à la norme SCPI.

- Il est possible d'enregistrer jusqu'à 20 erreurs dans chaque liste des erreurs des interfaces (une pour chaque erreur GPIB, USB, VXI-11 et Telnet/Sockets). Les erreurs sont affichées dans la file d'erreurs de la session d'E/S ayant provoqué l'erreur.
- Le voyant d'erreur ERR du panneau avant s'allume lorsqu'une ou plusieurs erreurs se trouvent dans la file d'erreurs.
- Une liste globale spéciale des erreurs contient toutes les erreurs matérielles et à la mise sous tension (ex. température excessive).
- Erreur de récupération « premier entré/premier sorti » (FIFO) ; ces erreurs sont effacées à la lecture. Après la lecture de toutes les erreurs spécifiques à l'interface, les erreurs dans liste globale sont récupérées. Après avoir lu toutes les erreurs de la file d'erreurs, le voyant ERR s'éteint.
- Si plus de 20 erreurs se produisent, la dernière erreur enregistrée (la plus récente) est remplacée par -350, « Error queue overflow » (Dépassement de la capacité de la file d'erreurs). Aucune erreur supplémentaire n'est enregistrée tant que vous ne supprimez pas des erreurs de la file. Si aucune erreur ne s'est produite depuis la dernière consultation de la file d'erreurs, l'instrument indique +0, "No error" (Aucune erreur).
- Le panneau avant signale les erreurs de toutes les sessions d'E/S et de la file d'erreurs globales. Pour afficher la file d'erreurs sur le panneau avant, appuyez sur la touche ERROR. L'affichage des erreurs efface la file d'attente des erreurs.
- Les conditions d'erreur sont également récapitulées dans le registre de l'octet d'état. Pour de plus amples informations, reportez-vous à la section **Présentation du sous-système Status**
- Les files d'erreurs d'interfaces sont effacées lors des cycles d'alimentation et du \*CLS. La commande \*RST n'efface pas la file d'erreurs.
- **SCPI : SYSTem:ERRor?** *Lire et effacer une erreur de la file*

Les erreurs présentent le format suivant (la chaîne d'erreur peut contenir jusqu'à 255 caractères) :  
-113 "Undefined header" (en-tête indéfini).

### **Erreurs dépendantes de l'appareil (activent le bit 3 du registre d'état des événements standard)**

0 No error

Réponse à la requête ERR? en l'absence d'erreur.

101 Calibration state is off

L'étalonnage n'est pas activé. L'instrument n'accepte pas les commandes d'étalonnage.

102 Calibration password is incorrect

Le mot de passe d'étalonnage est incorrect.

103 Calibration is inhibited by switch setting

Le mode d'étalonnage est verrouillé par le commutateur d'étalonnage.

104 Bad sequence of calibration commands

Les commandes d'étalonnage n'ont pas été saisies dans l'ordre approprié.

105 Unexpected output current

Le courant de sortie mesuré se trouve en dehors de la plage admissible.

106 Zero measurement out of range error

La valeur de mesure "zéro" se trouve en dehors de la plage admissible.

107 Programming cal constants out of range

Les constantes d'étalonnage programmées se trouvent en dehors de la plage admissible.

108 Measurement cal constants out of range

La constante d'étalonnage de mesure se trouve en dehors de la plage admissible.

109 Over voltage cal constants out of range

La constante d'étalonnage de surtension se trouve en dehors de la plage admissible.

110 Wrong V+I

L'instrument n'a pas pu régler la valeur de tension ou de courant appropriée.

114 Wrong status

Une fonction d'état incorrecte a été signalée.

116 Locked out by internal switch setting

Cette fonction a été verrouillée par un commutateur interne.

117 Calibration error

Une erreur d'étalonnage s'est produite. N'enregistrez pas les constantes d'étalonnage. Essayez de réétalonner l'appareil.

200 Hardware error channel <1>

Une erreur matérielle s'est produite sur la sortie.

201 Invalid configuration

Une configuration en parallèle non valide n'est pas autorisée.

202 Selftest Fail

Un échec d'autotest s'est produit. Consultez la liste des échecs d'autotest pour plus de détails.

203 Compatibility function not implemented



## 5 Aide-mémoire de la programmation SCPI

La fonction de compatibilité demandée n'est pas disponible.

### 204 NVRAM checksum error

Une erreur de somme de contrôle s'est produite dans la RAM non volatile de l'instrument.

### 205 NVRAM full

La mémoire RAM non volatile de l'instrument est pleine.

### 206 File not found

Le fichier d'étalonnage interne ou le fichier d'attribut de voie interne est introuvable dans la NVRAM.

### 207 Cal file version error

Le fichier d'étalonnage a été écrit ou lu à l'aide d'une ancienne version du microprogramme. Le microprogramme doit être mis à jour.

### 208 Running backup firmware

L'instrument exécute actuellement la version (précédente) de sauvegarde du microprogramme.

### 210 Frame NVRAM error

Une erreur de mémoire non volatile s'est produite dans l'instrument.

### 212 State file not loaded

Le chargement d'un fichier de configuration de sortie précédemment enregistré a échoué.

### 214 Line frequency error

Une incohérence a été détectée entre la fréquence réseau et le réglage correspondant.

### 215 Hardware failure

Une défaillance matérielle s'est produite sur le bloc d'alimentation

### 302 Option not installed

L'option qui est programmée par cette commande n'est pas installée.

### 303 There is not a valid acquisition to fetch from

Le tampon de mesure ne contient aucune donnée valide.

### 304 Volt and curr in incompatible transient modes

La tension et le courant ne peuvent pas être simultanément en mode Palier et Liste.

### 305 A triggered value is on a different range

Une valeur déclenchée se situe dans une plage différente de celle actuellement définie.

### 306 Too many list points

Vous avez saisi un nombre excessif de points de liste.

307 List lengths are not equivalent

Une ou plusieurs listes n'ont pas la même longueur.

308 This setting cannot be changed while transient trigger is initiated

Vous ne pouvez pas modifier ce paramètre lorsque l'instrument attend ou exécute une séquence de déclenchement.

309 Cannot initiate, voltage and current in fixed mode

Impossible de démarrer le générateur de transitoire. La fonction de tension ou de courant est définie en mode fixe.

310 The command is not supported by this model

Cet instrument n'inclut pas le matériel ou les options nécessaires pour prendre en charge cette commande.

315 Settings conflict error

Un élément de donnée n'a pas pu être programmé en raison de la configuration actuelle de l'instrument.

316 Mass storage error

La mémoire de stockage de masse a été dépassée.

317 Invalid format

Un format de données non valide a été trouvé dans la chaîne de commande.

320 Firmware update error

Cela peut être dû à l'incapacité du matériel de l'instrument à prendre en charge la version du microprogramme.

324 Inconsistent arb settings

Les paramètres du signal arbitraire sont incohérents ; très probablement une différence dans les longueurs de signal arbitraire.

327 Initiated with no sense function enabled

Une mesure a été lancée sans spécifier la fonction de mesure (sense).

328 Too many measurement points

Vous avez saisi un nombre excessif de points de mesure.

331 Illegal parameter value

La valeur du paramètre est en dehors de la plage ou n'existe pas.

332 Erreur principale/secondaire

Une erreur s'est produite dans la configuration principale/secondaire

## 5 Aide-mémoire de la programmation SCPI

334 Table number is invalid

Le numéro de tableau doit être 1 ou 2.

335 VMP must be less than VOC; VMP setting is <setting>, VOC setting is <setting>

Le paramètre de la courbe VMP est égal ou supérieur au paramètre VOC lorsque forme = spatial (shape = space)

336 VMP must be less than 0.99 \* VOC; VMP setting is <setting>, VOC setting is <setting>

Le paramètre de la courbe VMP est égal ou supérieur au paramètre VOC lorsque forme = terrestre (shape = terrestrial)

337 IMP must be less than or equal to ISC

Le paramètre de la courbe IMP est supérieur au paramètre ISC lorsque forme = spatial (shape = space)

338 IMP must be less than 0.99 \* ISC

Le paramètre de la courbe IMP est supérieur au paramètre ISC lorsque forme = terrestre (shape = terrestrial)

339 VMP and/or IMP too small

Le VMP et/ou l'IMP sont inférieurs à la fourchette de valeurs autorisée

340 Computed VOC exceeds max voltage setting; computed VOC is <setting>, max voltage is <setting>

Le VOC calculé (ou vrai) dépasse la tension maximale de l'instrument lorsque forme = terrestre (shape = terrestrial)

### **Erreurs de commande (activent le bit 5 du registre d'état des événements standard)**

-100 Command error

Erreur de syntaxe générique.

-101 Invalid character

Un caractère non valide a été trouvé dans la chaîne de commande.

-102 Syntax error

Une syntaxe non valide a été trouvée dans la chaîne de commande. Vérifiez la présence éventuelle d'espaces blancs.

-103 Invalid separator

Un séparateur non valide a été trouvé dans la chaîne de commande. Vérifiez si , ; : sont correctement utilisés.

-104 Data type error

La chaîne de commande comporte un type de donnée différent de celui qui est autorisé.

-105 GET not allowed

Les déclencheurs d'exécution de groupe ne sont pas autorisés dans les chaînes de commande.

-108 Parameter not allowed

Le nombre de paramètres reçus est plus élevé que le nombre prévu.

-109 Missing parameter

Le nombre de paramètres reçus est moins élevé que le nombre prévu.

-110 Command header error

Une erreur a été détectée dans l'en-tête.

-111 Header separator error

La chaîne de commande comporte un caractère qui n'est pas un séparateur d'en-tête valide.

-112 Program mnemonic too long

L'en-tête contient plus de 12 caractères.

-113 Undefined header

Une commande qui n'était pas valide pour cet instrument a été reçue.

-114 Header suffix out of range

La valeur du suffixe numérique n'est pas valide.

-120 Numeric data error

Erreur de donnée numérique générique.

-121 Invalid character in number

La chaîne de commande comporte un caractère non valide pour le type de donnée.

-123 Exponent too large

La puissance de l'exposant était supérieure à 32 000.

-124 Too many digits

La mantisse d'un paramètre numérique contenait plus de 255 chiffres, exception faite des zéros non significatifs.

-128 Numeric data not allowed

Un paramètre numérique a été reçu alors qu'une chaîne de caractères était attendue.

-130 Suffix error

Erreur de suffixe générique.

## 5 Aide-mémoire de la programmation SCPI

### -131 Invalid suffix

Un suffixe a été mentionné incorrectement pour un paramètre numérique.

### -134 Suffix too long

Le suffixe contient plus de 12 caractères.

### -138 Suffix not allowed

Cette commande ne prend pas en charge les suffixes.

### -140 Character data error

Erreur de donnée de caractère générique.

### -141 Invalid character data

L'élément des données de caractère contient un caractère non valide ou l'élément n'est pas valide.

### -144 Character data too long

L'élément de donnée de caractère contient plus de 12 caractères.

### -148 Character data not allowed

Un paramètre discret a été reçu alors qu'une chaîne ou un paramètre numérique était attendu(e).

### -150 String data error

Erreur de donnée de chaîne générique.

### -151 Invalid string data

Une chaîne de caractères non valide a été reçue. Vérifiez que cette chaîne se trouve entre guillemets.

### -158 String data not allowed

Une chaîne de caractères a été reçue alors qu'elle n'est pas autorisée pour cette commande.

### -160 Block data error

Erreur de donnée de bloc générique

### -161 Invalid block data

Le nombre d'octets de données envoyé ne correspond pas au nombre d'octets indiqués dans l'en-tête.

### -168 Block data not allowed

Des données ont été envoyées dans un format de bloc arbitraire mais cette commande ne l'autorise pas.

## **Erreurs d'exécution (activent le bit 4 du registre d'état des événements standard)**

### -200 Execution error

**Erreur de syntaxe générique****-220 Parameter error**

Une erreur associée à l'élément de donnée s'est produite.

**-221 Settings conflict**

Un élément de donnée n'a pas pu être exécuté en raison de la configuration actuelle de l'instrument.

**-222 Data out of range**

Un élément de donnée n'a pas pu être exécuté, car la valeur se trouvait en dehors de la plage valide.

**-223 Too much data**

Un élément de donnée reçu contient plus de données que l'instrument ne peut en gérer.

**-224 Illegal parameter value**

Une valeur exacte était attendue, mais n'a pas été reçue.

**-225 Out of memory**

La mémoire de l'appareil ne suffit pas pour effectuer l'opération demandée.

**-226 Lists not same length (Listes de longueur différente)**

Une ou plusieurs listes n'ont pas la même longueur.

**-230 Data corrupt or stale**

Il est possible que des données ne soient pas valides. Une nouvelle mesure a commencé, mais n'a pas été terminée.

**-231 Data questionable**

L'exactitude de la mesure est suspecte.

**-232 Invalid format**

Le format ou la structure des données est inapproprié(e).

**-233 Invalid version**

La version du format de données est incorrecte pour l'instrument.

**-240 Hardware error**

La commande n'a pas pu être exécutée en raison d'un problème matériel de l'instrument.

**-241 Hardware missing**

La commande n'a pas pu être exécutée en raison d'un matériel manquant (par exemple, une option).

**Erreurs de requête (activent le bit 2 du registre d'état des événements standard)****-400 Query Error**

## 5 Aide-mémoire de la programmation SCPI

Erreur de requête générique.

-410 Query INTERRUPTED

Une condition provoquant une erreur de requête interrompue s'est produite.

-420 Query UNTERMINATED

Une condition provoquant une erreur de requête non terminée s'est produite.

-430 Query DEADLOCKED

Une condition provoquant une erreur d'impasse de la requête s'est produite.

-440 Query UNTERMINATED after indefinite response

Une requête a été reçue dans le même message de programme à la suite d'une requête indiquant une réponse indéfinie.

## Commandes de compatibilité

Cette section décrit les commandes de compatibilité du système d'alimentation régénératif Keysight Série RP7900, mode PV avec les modèles RPS antérieurs.

### **Keysight RP793xA, RP794xA, RP795xA, RP796xA**

[SOURce]

:RESistance

:STATe <Booléen>

Active ou désactive la programmation de résistance de sortie.

VOLTage

:BWIDth LOW|HIGH1

Définit la compensation de la tension (RP795xA, RP796xA)





# 6

## Vérification et étalonnage

**Équipement et configurations de test**

**Vérification du fonctionnement**

**Étalonnage de l'instrument**

**Formulaires de relevé de test**

## Équipement et configurations de test

### Équipement de test

### Configurations de mesure

### Équipement de test

L'équipement nécessaire aux tests de fonctionnement et aux procédures de réglage est répertorié ci-dessous. Si l'appareil recommandé est indisponible, vous pouvez le remplacer par un autre de précision équivalente.

Instrument	Conditions requises	Modèle recommandé	Usage <sup>1</sup>
Multimètre numérique	Résolution : 10 nV à 1 V ; Résultat : 8 1/2 chiffres Précision : 20 ppm	Keysight 3458A	V, E
Shunt de courant <sup>2</sup>	50 A (0,05 $\Omega$ ) 0,01 %, TC = 4 ppm/ $\Omega$ C 100 A (0,01 $\Omega$ ) 0,01 %, TC = 4 ppm/ $\Omega$ C	Guildline 9230A/50 Guildline 9230A/100	V, E
Source/charge électronique <sup>2</sup>	1000 V, 90 A, 30 kW 2000 V, 30 A, 30 kW 1500 V, 60 A, 30 kW	Keysight RP7982A Keysight RP7983A Keysight RP7984A	V
Contrôleur GPIB	Fonctionnalités GPIB complètes	Keysight 82350B ou équivalent	V, E
Oscilloscope	Sensibilité : 1 mV Bande passante : 20 MHz Sonde : 100:1 avec pointe RF	Keysight DSO6054A ou équivalent Keysight 10076C	V
Voltmètre efficace	Bande passante : 10 MHz	Rhode et Schwartz URE3, Keysight 3458A ou équivalent	V
Diviseur de tension	5kV:5V (1000:1) Précision <0,01 %	Ohms-Lab KVB-5-5 ou équivalent	V, E
Amplificateur différentiel	Bande passante : 20 MHz	LeCroy 1855A, DA1850A, ou équivalent	V
Sonde différentielle	100:1	LeCroy DXC100A, ou équivalent	V
Terminaisons	Terminaison de 50 $\Omega$ BNC		V

<sup>1</sup>V=Vérification ; E=Étalonnage

<sup>2</sup>En fonction de la valeur nominale du modèle testé

## Configurations de mesure

### Voltmètre

Pour vous assurer que les valeurs relevées par le voltmètre pendant les procédures de vérification et d'étalonnage ne sont pas affectées par la mesure instantanée des crêtes CA de l'ondulation de courant de sortie, effectuez plusieurs mesures CC et calculez leur moyenne.

Si vous utilisez un multimètre numérique Keysight 3458A, vous pouvez configurer le voltmètre pour effectuer cette opération automatiquement. À partir du panneau avant de l'instrument, programmez 100 cycles de tension d'alimentation par mesure. Appuyez sur NPLC 100 ENTER. En outre, activez la fonction d'étalonnage automatique (ACAL) et de commutation automatique de plage (ARANGE).

### Shunt de courant

Le shunt de courant de 4 bornes permet d'éliminer les erreurs de mesure du courant de sortie provoquées par les chutes de tension dans les fils et les connexions de charge. Il inclut des bornes de contrôle de courant spéciales dans les bornes de connexion de charge. Branchez le voltmètre directement à ces bornes de contrôle du courant.

### Charge électronique

La plupart des procédures de test exigent que vous utilisiez une charge variable capable de dissiper la puissance requise. Pour tous les tests, un appareil Keysight RP79xxA peut être utilisé comme charge. L'appareil de charge RP79xxA est bien plus facile à utiliser que les résistances de charge.

Les résistances de charge fixes peuvent être utilisées à la place d'une charge variable, en adaptant sensiblement les procédures de test. Pour éviter tout contact avec des tensions élevées au cours du fonctionnement, utilisez des commutateurs pour connecter, déconnecter ou court-circuiter les résistances de charge.

Aussi, si vous utilisez des configurations de test assistées par ordinateur, les temps de stabilisation relativement courts (par rapport aux voltmètres des ordinateurs et du système) et les vitesses de balayage de l'appareil testé devront éventuellement être pris en compte. Vous pouvez utiliser des instructions d'attente dans le programme de test si le système de test est plus rapide que l'appareil testé.

## Vérification du fonctionnement

### Introduction

### Configurations de vérification

### Considérations relatives aux tests

### Précision de programmation et de relecture de la tension

### Effet de charge de tension constante

### Ondulation et bruit de tension constante

### Temps de récupération au transitoire

### Précision de programmation et de relecture du courant

### Effet de charge de courant constant

### Vérification de la capacité d'absorption de courant

### Formulaires de relevé de test

## Introduction

### AVERTISSEMENT

**RISQUE D'ÉLECTROCUTION, TENSION LÉTALES** De nombreux modèles génèrent des tensions allant jusqu'à 2 000 V CC ! Assurez-vous que toutes les connexions des instruments, le câblage de charge ainsi que les connexions de charge et de mesure sont isolés à l'aide de fils haute tension. Fixez toujours le capot de sécurité fourni, de sorte qu'aucun contact accidentel avec des tensions mortelles ne puisse se produire.

---

Les tests de vérification du fonctionnement permettent de vérifier que l'appareil testé (UUT) fonctionne normalement et qu'il est conforme aux spécifications publiées. Il existe deux niveaux différents de tests de vérification du fonctionnement :

- **Tests de vérification du fonctionnement** Un ensemble complet de tests recommandés comme tests de recette technique lorsque vous recevez l'instrument ou après des réglages.
- **Tests d'étalonnage** Ces tests vérifient que l'instrument fonctionne dans ses limites d'étalonnage.

Les tests de vérification du fonctionnement sont recommandés comme tests de recette lorsque vous recevez l'instrument. Les résultats des tests de recette doivent être comparés aux spécifications de l'instrument.

Keysight Technologies vous conseille de refaire les tests de vérification du fonctionnement à chaque intervention d'étalonnage. Cela garantit que l'instrument conservera ses caractéristiques jusqu'à l'étalonnage suivant ainsi que sa stabilité à long terme. Les caractéristiques fonctionnelles mesurées avec cette méthode sont utilisables pour prolonger la fréquence d'étalonnage.

Effectuez les tests de vérification avant d'étalonner votre système d'alimentation. Si l'instrument réussit les tests de vérification, l'appareil fonctionne dans ses limites d'étalonnage et n'a pas besoin d'être réétalonné.

Si l'instrument échoue à l'un des tests ou si les résultats de test sont anormaux, essayez d'étalonner l'appareil. En cas d'échec de l'étalonnage, retournez l'appareil à un centre de service après-vente Keysight Technologies.

Pour obtenir une liste des configurations d'équipement et de test nécessaires à la vérification, reportez-vous à la section **Équipement et configurations de test recommandés**. Pour de plus amples informations sur la connexion du voltmètre, le shunt de courant et la charge, reportez-vous également à la section **Configurations de mesure**.

**AVERTISSEMENT**

**RISQUE D'ÉLECTROCUTION, TENSION LÉTALES** De nombreux modèles génèrent des tensions allant jusqu'à 2 000 V CC ! Assurez-vous que toutes les connexions des instruments, le câblage de charge ainsi que les connexions de charge et de mesure sont isolés à l'aide de fils haute tension. Fixez toujours le capot de sécurité fourni, de sorte qu'aucun contact accidentel avec des tensions mortelles ne puisse se produire.

Désactivez toujours la sortie lors de la connexion ou de la déconnexion d'un équipement sur les bornes de mesure ou de sortie de l'appareil.

---

**ATTENTION**

**Endommagement de l'équipement** Il est conseillé de régler la fonction de protection contre les surtensions de l'instrument de manière à ce qu'elle soit légèrement plus élevée que son point de fonctionnement pendant la procédure de vérification. Vous éviterez ainsi d'endommager des équipements externes (charge électronique, amplificateur différentiel) en cas de programmation de la tension de sortie accidentellement supérieure au réglage de tension prescrit.

---

**REMARQUE**

Mettez l'appareil hors tension ou envoyez une demande de réinitialisation (Reset) après avoir terminé la procédure de vérification pour rétablir les réglages par défaut de l'instrument.

---

### Configurations de vérification

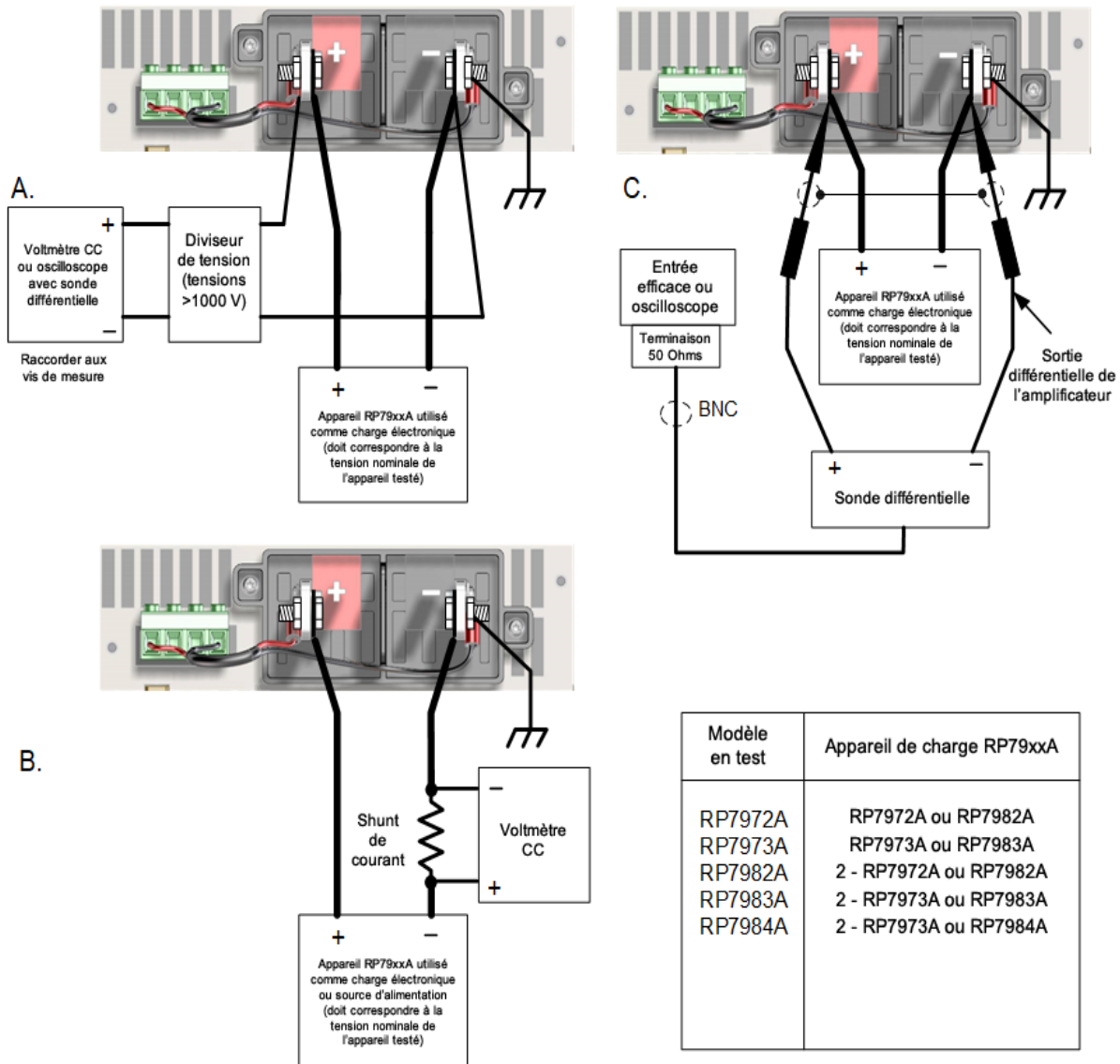

### Considérations relatives aux tests

Pour des performances optimales, toutes les procédures de vérification et d'étalonnage doivent respecter ce qui suit :

- Température ambiante stable (de 23 °C, ± 2 °C).
- Humidité relative ambiante inférieure à 80 %.
- Période de préchauffage de 30 minutes avant la vérification ou le réglage.
- Câbles aussi courts que possible, torsadés ou blindés pour réduire le bruit.

## Procédure de vérification

### Précision de programmation et de relecture de la tension

Ce test vérifie que les fonctions de programmation et de mesure de la tension sont conformes aux spécifications.

Étape 1. Éteignez l'appareil testé. Connectez uniquement le multimètre numérique aux vis de mesure (voir **Configuration de test A**). Ne connectez **PAS** l'appareil de charge RP79xxA.

Étape 2. Mettez l'appareil testé sous tension et programmez les réglages de l'instrument comme décrit dans le formulaire de relevé de test, sous « Programmation et relecture de la tension, tension minimale ». Activez la sortie. L'état de la sortie doit être « CV » (tension constante) et le courant de sortie proche de zéro.

Étape 3. Enregistrez la tension de sortie relevée sur le multimètre numérique (Vout) et la tension mesurée par l'instrument sur l'interface. Les mesures doivent être comprises dans les limites spécifiées dans le formulaire de relevé de test pour le modèle souhaité, sous « Programmation et relecture de la tension, tension minimale ».

**AVERTISSEMENT** **Le prochain palier applique la tension de sortie totale de l'appareil testé à la sortie.**

---

Étape 4. Programmez les réglages de l'instrument comme décrit dans le formulaire de relevé de test, sous « Programmation et relecture de la tension, haute tension ».

Étape 5. Enregistrez la tension de sortie relevée sur le multimètre numérique (Vout) et la tension mesurée par l'instrument sur l'interface. Les mesures doivent être comprises dans les limites spécifiées dans le formulaire de relevé de test pour le modèle souhaité, sous « Programmation et relecture de la tension, haute tension ».

### Effet de charge de tension constante

Ce test mesure la variation de la tension résultant d'une modification du courant d'une charge pleine à une charge nulle.

Étape 1. Éteignez l'appareil testé. Connectez un multimètre numérique aux vis de mesure et branchez l'appareil de charge RP79xxA (voir **Configuration de test A**).

Étape 2. Mettez l'appareil testé sous tension et programmez les réglages de l'instrument comme décrit dans le formulaire de relevé de test, sous « Effet de charge de tension constante ». Activez la sortie.

Étape 3. Réglez la charge de l'appareil RP79xxA au courant de sortie nominal de l'appareil testé comme décrit dans le formulaire de relevé de test, sous « Effet de charge de tension constante ». Activez la sortie. L'état de sortie de l'appareil testé doit être « CV » (tension constante). Si tel n'est pas le cas, réglez la charge afin que le courant de sortie diminue sensiblement.

Étape 4. Relevez la mesure de tension de sortie sur le multimètre numérique.



## 6 Vérification et étalonnage

Étape 5. Désactivez la sortie de la charge RP79xxA. Relevez à nouveau la valeur de tension sur le multimètre numérique. La différence entre les mesures du multimètre aux étapes 4 et 5 est l'effet de charge, qui ne doit pas dépasser la valeur indiquée dans le formulaire de relevé de test du modèle souhaité, sous « Effet de charge de tension constante ».

### Ondulation et bruit de tension constante

Les variations périodiques et aléatoires de la sortie sont combinées pour produire une tension CA résiduelle superposée à la tension de sortie CC. Cette tension résiduelle est spécifiée en tant que bruit efficace vrai ou crête à crête dans la plage de fréquence indiquée (voir la section **Spécifications**).

Étape 1. Éteignez l'appareil testé. Connectez l'appareil de charge RP79xx, l'amplificateur différentiel et un oscilloscope (couplé en courant alternatif) à la sortie (voir **Configuration de test C**).

Étape 2. Comme illustré dans le schéma, utilisez les sondes différentielles pour brancher l'amplificateur différentiel aux bornes de sortie + et -. Reliez les blindages des deux sondes ensemble. Branchez la sortie à l'amplificateur différentiel à l'oscilloscope à l'aide d'une terminaison de 50  $\Omega$  à l'entrée de l'oscilloscope.

Étape 3. Réglez la sonde sur 1:100 et réglez les entrées de l'amplificateur différentiel en fonction du réglage de la sonde. Réglez les entrées sur le couplage CA. Réglez la résistance d'entrée sur 1 M $\Omega$ . Réglez la base de temps de l'oscilloscope à 5 ms/div, et l'échelle verticale à la sensibilité maximale sans couper le signal. Activez la limite de bande passante (habituellement 20 MHz) et réglez le mode d'échantillonnage sur la détection de crête.

Étape 4. Mettez le système d'alimentation sous tension et programmez les réglages de l'instrument comme décrit dans le formulaire de relevé de test, sous « Ondulation et bruit de tension constante ». Activez la sortie. Programmez la charge RP79xxA comme indiquée sur la carte de relevé de test et activez la sortie. Laissez l'oscilloscope fonctionner pendant quelques secondes pour générer une quantité suffisante de points de mesure. Sur l'oscilloscope Keysight Infiniium, la mesure de tension crête à crête maximale est indiquée dans la partie inférieure droite de l'écran. Le résultat ne doit pas dépasser les limites crête à crête dans le formulaire de relevé de test, sous « Ondulation et bruit de tension constante, crête à crête ».

**REMARQUE** Si la mesure contient des points d'interrogation, effacez-la et réessayez. Cela signifie que certaines données d'oscilloscope reçues étaient suspectes.

---

Étape 5. Débranchez l'oscilloscope et branchez à la place un voltmètre efficace. Ne déconnectez pas la terminaison de 50 ohms. Divisez la mesure du voltmètre efficace en fonction du réglage de l'amplificateur différentiel. Le résultat ne devrait pas dépasser les limites efficaces dans le formulaire de relevé de test du modèle souhaité, sous « Ondulation et bruit de tension constante, valeur efficace vraie ».

### Temps de récupération au transitoire

Ce test mesure le temps nécessaire à la récupération de la tension de sortie conformément à la valeur spécifiée suite à une variation de 50 % du courant de charge nominal de l'instrument.

Étape 1. Éteignez l'appareil testé. Branchez un oscilloscope équipé de la sonde indiquée aux bornes de mesure (voir **Configuration de test A**). Branchez un appareil de charge RP79xxA aux bornes de sortie.

Étape 2. Mettez le système d'alimentation sous tension et programmez les réglages de l'instrument comme décrit dans le formulaire de relevé de test, sous « Réponse transitoire ».

Étape 3. Réglez le générateur de liste des charges RP79xxA pour générer un signal de courant de 100 Hz avec un rapport cyclique de 50 %. Si vous utilisez 2 appareils RP797xA comme charge, réglez une unité en CC pour tirer un courant constant, et utilisez le deuxième appareil pour créer l'étape de courant. Les commandes suivantes permettent de programmer la liste :

FUNC:CURR : indique la priorité de courant

VOLT:LIM MAX : indique la limite de tension

DIAG:OF:CURR:BWID:LEV 3 : indique le niveau de bande passante 3, qui génère un palier de temps mesuré de 40  $\mu$ s dans la liste de charge.

CURR:MODE LIST : indique la priorité de courant

LIST:CURR, <valeur\_basse>, <valeur\_haute> : se rapporte à la carte de relevé de test pour les valeurs de courant basse et haute.

LIST:DWEL 0.005, 0.005 : indique un signal de courant de 100 Hz avec un rapport cyclique de 50 %.

LIST:COUN INF : règle le nombre de listes sur infini.

INIT:TRAN : initie le système transitoire

TRIG:TRAN : déclenche le système transitoire

OUTP:ON : active la charge

Étape 4. Réglez l'oscilloscope pour un signal similaire à celui qui est illustré dans la figure suivante.

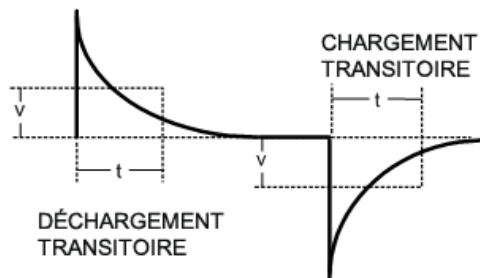

Étape 5. La tension de sortie doit retourner aux limites de tension spécifiées au moment indiqué après la variation de charge. Vérifiez le chargement et le déchargement des transitoires en les déclenchant sur la pente positive et négative. Enregistrez la tension au temps « t » dans le formulaire de relevé de test des performances, sous « Réponse transitoire ».

### Précision de programmation et de relecture du courant

Ce test vérifie que les fonctions de programmation et de mesure du courant sont conformes aux spécifications.

Étape 1. Éteignez l'appareil testé. Connectez le shunt de courant directement aux bornes de sortie. Branchez le multimètre numérique directement au shunt de courant (voir **Configuration de test B**). Notez que la charge RP79xxA n'est pas utilisée dans cette partie du test.

Étape 2. Mettez le système d'alimentation sous tension et programmez les réglages de l'instrument comme décrit dans le formulaire de relevé de test, sous « Programmation et relecture du courant,

## 6 Vérification et étalonnage

courant minimal ». L'état de la sortie doit être « CC » et la tension de sortie doit être proche de zéro. Patientez 5 minutes jusqu'à la stabilisation de la température.

Étape 3. Divisez la chute de tension (mesure du multimètre numérique) au shunt de courant par la résistance de shunt pour convertir la mesure en ampères et enregistrez cette valeur. (Iout). Enregistrez également le courant mesuré par l'instrument sur l'interface. Les mesures doivent être comprises dans les limites spécifiées dans le formulaire de relevé de test, sous « Programmation et relecture du courant, courant minimal ».

Étape 4. Programmez les réglages de l'instrument comme décrit dans le formulaire de relevé de test, sous « Programmation et relecture du courant, courant élevé ». Patientez 5 minutes jusqu'à la stabilisation de la température.

Étape 5. Divisez la chute de tension (mesure du multimètre numérique) au shunt de courant par la résistance de shunt pour convertir la mesure en ampères et enregistrez cette valeur. (Iout). Enregistrez également la valeur de courant mesurée par l'instrument sur l'interface. Les mesures doivent être comprises dans les limites spécifiées dans le formulaire de relevé de test, sous « Programmation et relecture du courant, courant élevé ».

### Effet de charge de courant constant

Ce test mesure la variation du courant résultant d'une modification de la tension d'un court-circuit à une pleine échelle.

Étape 1. Éteignez l'appareil testé. Connectez le shunt de courant directement aux bornes de sortie. Branchez le multimètre numérique directement au shunt de courant (voir **Configuration de test B**). Notez que la charge RP79xxA n'est pas utilisée dans cette partie du test.

Étape 2. Mettez l'appareil testé sous tension et programmez les réglages de l'instrument comme décrit dans le relevé de test, sous « Effet de charge de courant constant ». L'état de la sortie doit être « CC » (courant constant) et la tension de sortie doit être proche de zéro. Patientez 5 minutes jusqu'à la stabilisation de la température.

Étape 3. Divisez la chute de tension (mesure du multimètre numérique) au shunt de courant par la résistance de shunt pour convertir la mesure en ampères et enregistrez cette valeur.

Étape 4. Éteignez l'appareil testé et connectez l'appareil de charge RP79xxA entre le shunt de courant et les bornes de sortie (voir **Configuration de test B**).

Étape 5. Réglez la charge de l'appareil RP79xxA en mode de priorité de tension et programmez les limites de tension et de courant comme décrit dans le formulaire de relevé de test, sous « Effet de charge de courant constant ». Activez la sortie de la charge.

Étape 6. Programmez l'appareil testé avec les réglages comme décrit dans le relevé de test, sous « Effet de charge de courant constant ». Activez la sortie de l'appareil testé. L'état de la sortie doit être « CC » (courant constant). Si tel n'est pas le cas, réglez la charge afin que la tension de sortie diminue sensiblement.

Étape 7. Divisez la chute de tension (mesure du multimètre numérique) au shunt de courant par la résistance de shunt pour convertir la mesure en ampères et enregistrez cette valeur. La différence entre cette lecture de courant et la lecture à l'étape 3 est l'effet de charge, qui ne doit pas dépasser la

valeur indiquée dans le formulaire de relevé de test du modèle souhaité, sous « Effet de charge de courant constant ».

### Vérification de la capacité d'absorption de courant

Ce test vérifie la capacité d'absorption de l'alimentation jusqu'à 100 % de son courant de sortie nominal.

Étape 1. Éteignez l'appareil testé et connectez l'appareil RP79xxA comme source externe aux bornes de sortie + et - (voir **Configuration de test B**). Assurez-vous que la tension nominale de la source externe de l'appareil RP79xxA est au moins égale à la moitié de la tension nominale de l'appareil testé.

Étape 2. Réglez la source externe de l'appareil RP79xxA en mode de priorité de tension et programmez-la sur la tension comme décrit dans le formulaire de relevé de test, sous « 100 % de son courant nominal (Isink) ».

Étape 3. Mettez l'appareil testé sous tension. Réglez le mode de fonctionnement sur la priorité de courant. Programmez les réglages de l'instrument comme décrit dans le formulaire de relevé de test, sous « 100 % de son courant nominal (Isink) ».

Étape 4. Vérifiez l'affichage du panneau avant de l'appareil testé et assurez-vous qu'il baisse de 100 % de son courant nominal et a un état CL. Divisez la chute de tension (mesure du multimètre numérique) au shunt de courant par la résistance de shunt pour convertir la mesure en ampères et enregistrez cette valeur. Les mesures doivent être comprises dans les limites spécifiées dans le formulaire de relevé de test, sous « Tests d'absorption du courant ».

## Étalonnage de l'instrument

### Introduction

### Fréquence de l'étalonnage

### Configurations d'étalonnage

### Considérations relatives aux tests

### Accéder au mode d'étalonnage

### Étalonnage de programmation et de mesure de la tension

### Étalonnage du coefficient de température de courant

### Étalonnage de programmation et de mesure du courant

### Saisir une date d'étalonnage

### Enregistrer l'étalonnage et se déconnecter

## Introduction

#### AVERTISSEMENT

**RISQUE D'ÉLECTROCUTION, TENSION LÉTALES** De nombreux modèles génèrent des tensions allant jusqu'à 2 000 V CC ! Assurez-vous que toutes les connexions des instruments, le câblage de charge ainsi que les connexions de charge et de mesure sont isolés à l'aide de fils haute tension. Fixez toujours le capot de sécurité fourni, de sorte qu'aucun contact accidentel avec des tensions mortelles ne puisse se produire.

---

L'instrument utilise une méthode d'étalonnage électronique en boîtier fermé ; aucun réglage mécanique interne n'est nécessaire. L'instrument calcule les facteurs de correction selon les valeurs de référence en entrée que vous configurez et enregistre ces facteurs en mémoire non volatile jusqu'à l'étalonnage suivant. L'extinction de l'instrument ou la fonction \*RST ne modifie pas cette mémoire d'étalonnage EEPROM.

Pour une liste des configurations d'équipement et de test nécessaires à l'étalonnage, reportez-vous à la section **Équipement et configurations de test recommandés**. Pour de plus amples informations sur la connexion du voltmètre, le shunt de courant et la charge, reportez-vous également à la section **Configurations de mesure**. Vous trouverez ci-dessous de plus amples informations sur la procédure d'étalonnage.

- Le mot de passe approprié est nécessaire pour accéder au menu Admin, qui contient la fonction d'étalonnage. Ce mot de passe est prédéfini à 0 (zéro). Vous pouvez modifier le mot de passe une fois le mode d'étalonnage activé pour empêcher tout accès non autorisé au mode d'étalonnage. Pour de plus amples informations, reportez-vous à la section **Protection par mot de passe**.

- Lors de l'étalonnage de l'appareil à l'aide des commandes SCPI, la plupart des étapes impliquent l'envoi d'une requête \*OPC? afin de le synchroniser avec l'exécution de la commande du bloc d'alimentation avant de continuer. La réponse de l'instrument doit être lue chaque fois que la commande \*OPC? est donnée. À certaines étapes, la commande \*OPC? peut mettre jusqu'à 30 secondes à répondre.
- Une fois la procédure d'étalonnage lancée, vous devez effectuer l'étalonnage dans son intégralité. Lorsqu'une section d'étalonnage est terminée, l'instrument calcule les nouvelles constantes d'étalonnage et commence à les utiliser. Ces constantes ne sont pas enregistrées dans la mémoire non volatile tant qu'une commande SAVE n'est pas explicitement donnée.
- Quittez le mode d'étalonnage en vous déconnectant du menu Admin ou en envoyant la commande CAL:STAT OFF. Notez que toute section d'étalonnage ayant été étalonnée sans avoir été enregistrée retourne à ses constantes d'étalonnage précédentes.

## Fréquence de l'étalonnage

### Intervalle d'étalonnage d'un an

L'instrument doit être étalonné à intervalles réguliers, qui varient selon la précision nécessaire à votre application. Un intervalle d'un an convient à la plupart des applications. Les spécifications de précision sont garanties uniquement si l'étalonnage est effectué régulièrement. Au-delà d'un an, les spécifications de précision publiées ne sont plus garanties.

### Intervalle d'étalonnage de trois ans

Les spécifications de précision de programmation et de mesure de la tension et du courant peuvent être étendues à un intervalle d'étalonnage d'une période de trois ans en multipliant (ou en augmentant) par trois les spécifications de précision d'étalonnage d'un an présentées dans les Formulaires de relevé de test de vérification.

## Configurations d'étalonnage

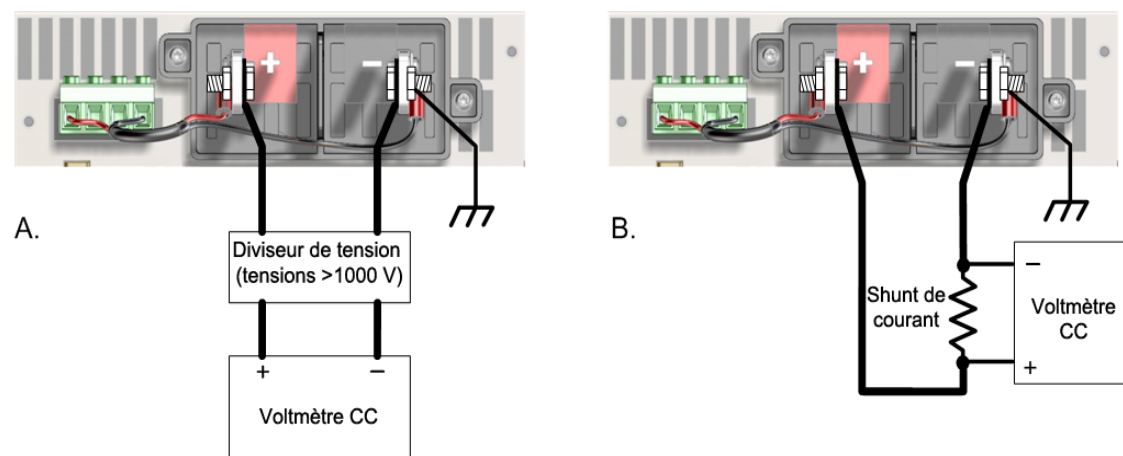

## Considérations relatives aux tests

Pour des performances optimales, toutes les procédures de vérification et d'étalonnage doivent respecter ce qui suit :

- Température ambiante stable (de 23 °C,  $\pm$  2 °C).
- Humidité relative ambiante inférieure à 80 %.
- Période de préchauffage de 30 minutes avant la vérification ou le réglage.
- Câbles aussi courts que possible, torsadés ou blindés pour réduire le bruit.

## Procédure d'étalonnage

### Accéder au mode d'étalonnage

Aide-mémoire des menus du panneau avant	Commande SCPI
Sélectionnez <b>System\Admin&gt;Login</b> . Saisissez votre mot de passe dans le champ Password (Mot de passe). Appuyez ensuite sur <b>Select</b> .	<b>CAL:STAT ON &lt; motdepasse &gt;</b>

### Étalonnage de programmation et de mesure de la tension

Étape 1. Connectez l'entrée de tension du multimètre numérique Keysight 3458A à la sortie (voir [Configuration d'étalonnage A](#)).

Étape 2. Sélectionnez l'étalonnage de programmation et de mesure de la tension.

Aide-mémoire des menus du panneau avant	Commande SCPI
Sélectionnez <b>System\Admin\CAL\prog</b> . Vérifiez que le voltmètre est branché, puis sélectionnez Next.	Spécifiez la plage de tension à pleine échelle. Les plages de pleine échelle varient en fonction du modèle. La plage de 1000 V est alors sélectionnée : <b>CAL:VOLT 1000</b>

Étape 3. Sélectionnez le premier point d'étalonnage de tension. Mesurez la tension de sortie à l'aide du multimètre numérique et saisissez les données.

Aide-mémoire des menus du panneau avant	Commande SCPI
Le message suivant s'affiche à l'écran : "Enter P1 measured data" (« Saisir les données mesurées P1 »). Saisissez les données du multimètre numérique externe. Appuyez sur Enter une fois l'opération terminée.	<b>CAL:LEV P1</b> <b>*OPC?</b> <b>CAL:DATA &lt; données &gt;</b>

#### AVERTISSEMENT

Le prochain palier applique la tension de sortie nominale à 70 % de l'appareil testé à la sortie.

Étape 4. Sélectionnez le deuxième point d'étalonnage de tension. Patientez 5 minutes jusqu'à la stabilisation de la température. Mesurez la tension de sortie à l'aide du multimètre numérique et saisissez les données.

Aide-mémoire des menus du panneau avant	Commande SCPI
Le message suivant s'affiche à l'écran : "Enter P2 measured data" (« Saisir les données mesurées P2 »). Saisissez les données du multimètre numérique externe. Appuyez sur Enter une fois l'opération terminée. Appuyez sur Back pour terminer.	CAL:LEV P2 *OPC? CAL:DATA <données>

## Étalonnage du coefficient de température de courant

**REMARQUE** La procédure d'étalonnage du coefficient de température doit être effectuée **avant** toute autre procédure d'étalonnage du courant.

Étape 1. Branchez une résistance de shunt de précision à la sortie. La résistance de shunt doit pouvoir mesurer le courant à **pleine échelle** (voir **Configuration d'étalonnage B**). Branchez le multimètre numérique Keysight 3458A à la résistance de shunt.

Étape 2. Sélectionnez l'étalonnage du coefficient de température.

Aide-mémoire des menus du panneau avant	Commande SCPI
Sélectionnez <b>System\Admin\Cal\Misc\CurrTC</b> . Vérifiez que le shunt est raccordé, puis sélectionnez Next.	CAL:CURR:TC

Étape 3. Sélectionnez le premier point d'étalonnage de courant. Patientez 5 minutes jusqu'à la stabilisation de la température. Calculez le courant de shunt ( $I=V/R$ ) et saisissez les données.

Aide-mémoire des menus du panneau avant	Commande SCPI
Le message suivant s'affiche à l'écran : "Enter P1 measured data" (« Saisir les données mesurées P1 »). Ce dernier doit correspondre à environ 50 % du courant nominal à pleine échelle. Appuyez sur Enter une fois l'opération terminée.	CAL:LEV P1 *OPC? CAL:DATA <données>

Étape 4. Sélectionnez le deuxième point d'étalonnage de courant. Patientez 5 minutes jusqu'à la stabilisation de la température. Calculez le courant de shunt ( $I=V/R$ ) et saisissez les données.

Aide-mémoire des menus du panneau avant	Commande SCPI
Le message suivant s'affiche à l'écran : "Enter P2 measured data" (« Saisir les données mesurées P2 »). Saisissez les données du multimètre numérique externe. Ce dernier doit correspondre à environ 80 % du courant nominal à pleine échelle. Appuyez sur Enter une fois l'opération terminée.	CAL:LEV P2 *OPC? CAL:DATA <données>

Étape 5. Sélectionnez le troisième point d'étalonnage du courant. Patientez 5 minutes jusqu'à la stabilisation de la température. Calculez le courant de shunt ( $I=V/R$ ) et saisissez les données.



## 6 Vérification et étalonnage

Aide-mémoire des menus du panneau avant	Commande SCPI
Le message suivant s'affiche à l'écran : « Enter P3 measured data » (« Saisir les données mesurées P3 »). Saisissez les données du multimètre numérique externe. Ce dernier doit correspondre à environ 100 % du courant nominal à pleine échelle. Appuyez sur Enter une fois l'opération terminée. Appuyez sur Back pour terminer.	CAL:LEV P3 *OPC? CAL:DATA <données>

### Étalonnage de programmation et de mesure du courant

Étape 1. Débranchez tous les équipements des bornes de sortie.

Étape 2. Sélectionnez l'étalonnage de programmation et de mesure du courant.

Aide-mémoire des menus du panneau avant	Commande SCPI
Sélectionnez <b>System Admin\Cal\Curr\Iprog.</b> Vérifiez qu'aucun élément n'est connecté à la sortie, puis sélectionnez Next.	Spécifiez la plage de courant à pleine échelle. Les plages de pleine échelle varient en fonction du modèle. La plage de 30 A est alors sélectionnée : CAL:CURR 30

Étape 3. Patientez 5 minutes jusqu'à la stabilisation de la température. Sélectionnez le premier point d'étalonnage de courant.

Aide-mémoire des menus du panneau avant	Commande SCPI
Patiencez 5 minutes, puis sélectionnez à nouveau sur Next.	CAL:LEV P1 *OPC?

Étape 4. Branchez une résistance de shunt de précision à la sortie. La résistance de shunt doit pouvoir mesurer au moins 70 % du courant à pleine échelle de la sortie (voir **Configuration d'étalonnage B**). Branchez le multimètre numérique Keysight 3458A à la résistance de shunt.

Aide-mémoire des menus du panneau avant	Commande SCPI
Vérifiez que le shunt est raccordé, puis sélectionnez Next.	Sans objet

Étape 5. Sélectionnez le deuxième point d'étalonnage de courant. Patientez 5 minutes jusqu'à la stabilisation de la température. Calculez le courant de shunt ( $I=V/R$ ) et saisissez les données.

Aide-mémoire des menus du panneau avant	Commande SCPI
Le message suivant s'affiche à l'écran : "Enter P2 measured data" (« Saisir les données mesurées P2 »). Saisissez les données du multimètre numérique externe. Ce dernier doit correspondre à environ 70 % du courant nominal à pleine échelle. Appuyez sur Enter une fois l'opération terminée. Appuyez sur Back pour terminer.	CAL:LEV P2 *OPC? CAL:DATA <données>

### Saisir une date d'étalonnage

Aide-mémoire des menus du panneau avant	Commande SCPI
-----------------------------------------	---------------

---

Sélectionnez **System\Admin\Cal\Date**.

**CAL:DATE "<date>"**

Saisissez la date d'étalonnage dans le champ Date. Si vous le souhaitez, vous pouvez saisir des données alphanumériques dans ce champ.

---

## Enregistrer l'étalonnage et se déconnecter

Aide-mémoire des menus du panneau avant	Commande SCPI
Sélectionnez <b>System\Admin\Cal\Save</b> .	Pour enregistrer les données d'étalonnage :
Sélectionnez Save pour enregistrer toutes les données d'étalonnage.	<b>CAL:SAVE</b>
Sélectionnez <b>System\Admin\Logout</b> .	Pour quitter le mode d'étalonnage :
pour quitter le mode d'étalonnage.	<b>CAL:STAT OFF</b>

---

## Formulaires de relevé de test – Gamme RPS

## Keysight RP7972A

RP7972A Relevé de test des performances		Numéro de rapport _____	Date _____
Description du test	Valeurs min. spécifiées	Résultats	Valeurs max. spécifiées
Programmation et relecture de la tension			
Tension minimale (Vout) :	0,9246	_____	1,0754
Tension mesurée sur l'interface :	Vout - 0,0754	_____	Vout + 0,0754
Haute tension (Vout) :	999,525	_____	1000,475
Tension mesurée sur l'interface :	Vout - 0,475	_____	Vout + 0,475
Effet de charge de tension constante :			
	- 0,05	_____	+ 0,05
Ondulation et bruit de tension constante			
Crête à crête :	S.O.	_____	1,5
Valeur efficace vraie :	S.O.	_____	0,2
Réponse transitoire à 300 µs :			
	- 10	_____	+ 10
Programmation et relecture du courant			
Courant minimal (Iout) :	- 0,006	_____	0,006
Courant mesuré sur l'interface :	Iout - 0,006	_____	Iout + 0,006
Courant élevé (Iout) :	59,976	_____	60,024
Courant mesuré sur l'interface :	Iout - 0,024	_____	Iout + 0,024
Effet de charge de courant constant :			
	- 0,008	_____	+ 0,008
Tests d'absorption de courant			
100% du courant nominal :	- 60,024	_____	- 59,974

	Réglages de l'appareil testé RP7972A	Réglages de la charge RP7972A ou RP7982A
Programmation et relecture de la tension min. :	Priorité de tension : 1 V, 5 A Priorité de tension : 1000 V, 5 A	non utilisé non utilisé
Programmation et relecture de la tension élevée :	Priorité de tension : 333 V, 61 A Priorité de tension : 333 V, 61 A	Priorité de courant : 335 V, -60 A Priorité de courant : 335 V, -60 A
Effet de charge de tension constante :	Priorité de tension : 333 V, 61 A, Comp 0	Priorité de courant : 550 V, -24 A à -54 A, vitesse=max, Comp 3**
Ondulation et bruit de tension constante :	Priorité de courant : 335 V, 0 A	Priorité de tension : 333 V, 0 A
Réponse transitoire :	Priorité de courant : 335 V, 60 A	Priorité de tension : 333 V, -61 A
Programmation et relecture du courant min. :	Priorité de courant : 1010 V, 20 A	Priorité de tension : 1000 V, -20,5 A
Programmation et relecture du courant élevé :	Priorité de courant : 335 V, -60 A	Priorité de tension : 333 V, 61 A
Effet de charge de courant constant :		
100 % du courant nominal (Isink) :		

\* **ATTENTION** Dégâts matériels. La sonde LeCroy DXC100A est limitée à 500 V. Ne la connectez que pour le test d'ondulation et de bruit de tension constante.

\*\* La comparaison de courant 3 génère un palier de temps mesuré de 40 µs dans la liste de charge, qui est nécessaire pour le test de réponse de transitoire.

## Keysight RP7973A

RP7973A Relevé de test des performances		Numéro de rapport _____		Date _____	
Description du test	Valeurs min. spécifiées	Résultats	Valeurs max. spécifiées		
Programmation et relecture de la tension					
Tension minimale (Vout) :	1,8492	_____	2,1508		
Tension mesurée sur l'interface :	Vout - 0,1508	_____	Vout + 0,1508		
Haute tension (Vout) :	1999,05	_____	2000,95		
Tension mesurée sur l'interface :	Vout - 0,95	_____	Vout + 0,95		
Effet de charge de tension constante :					
	- 0,1	_____	+ 0,1		
Ondulation et bruit de tension constante					
Crête à crête :	S.O.	_____	3		
Valeur efficace vraie :	S.O.	_____	0,4		
Réponse transitoire à 300 µs :					
	- 20	_____	+ 20		
Programmation et relecture du courant					
Courant minimal (Iout) :	- 0,003	_____	0,003		
Courant mesuré sur l'interface :	Iout - 0,003	_____	Iout + 0,003		
Courant élevé (Iout) :	29,988	_____	30,012		
Courant mesuré sur l'interface :	Iout - 0,012	_____	Iout + 0,012		
Effet de charge de courant constant :					
	- 0,004	_____	+ 0,004		
Tests d'absorption de courant					
100% du courant nominal :	- 30,012	_____	- 29,988		

	Réglages de l'appareil testé RP7973A	Réglages de la charge RP7973A ou RP7983A
Programmation et relecture de la tension min. :	Priorité de tension : 2 V, 5 A	non utilisé
	Priorité de tension : 2000 V, 5 A	non utilisé
Programmation et relecture de la tension élevée :	Priorité de tension : 666 V, 30,5 A	Priorité de courant : 670 V, -30 A
	Priorité de tension : 500 V, 30,5 A	Priorité de courant : 520 V, -30 A
Effet de charge de tension constante :	Priorité de tension : 666 V, 30,5 A, Comp 0	Priorité de courant : 1100 V, -12 A à -27 A, vitesse=max, Comp 3**
Ondulation et bruit de tension constante :	Priorité de courant : 670 V, 0 A	
Réponse transitoire :	Priorité de courant : 670 V, 30 A	Priorité de tension : 666 V, 0 A
Programmation et relecture du courant min. :	Priorité de courant : 2040 V, 10 A	Priorité de tension : 666 V, -30,5 A
Programmation et relecture du courant élevé :	Priorité de courant : 670 V, -30 A	Priorité de tension : 2000 V, -10,2 A
		Priorité de tension : 666 V, 30,5 A
Effet de charge de courant constant :		
100 % du courant nominal (Isink) :		

\* **ATTENTION** Dégâts matériels. La sonde LeCroy DXC100A est limitée à 500 V. Ne la connectez que pour le test d'ondulation et de bruit de tension constante.

\*\* La comparaison de courant 3 génère un palier de temps mesuré de 40 µs dans la liste de charge, qui est nécessaire pour le test de réponse de transitoire.

## Keysight RP7982A

RP7982A Relevé de test des performances		Numéro de rapport _____		Date _____	
Description du test	Valeurs min. spécifiées	Résultats	Valeurs max. spécifiées		
Programmation et relecture de la tension					
Tension minimale (Vout) :	0,9247	_____	1,0753		
Tension mesurée sur l'interface :	Vout - 0,0753	_____	Vout + 0,0753		
Haute tension (Vout) :	999,625	_____	1000,375		
Tension mesurée sur l'interface :	Vout - 0,375	_____	Vout + 0,375		
Effet de charge de tension constante :					
	- 0,05	_____	+ 0,05		
Ondulation et bruit de tension constante					
Crête à crête :	S.O.	_____	1,5		
Valeur efficace vraie :	S.O.	_____	0,2		
Réponse transitoire à 300 µs :					
	- 10	_____	+ 10		
Programmation et relecture du courant					
Courant minimal (Iout) :	- 0,009	_____	0,009		
Courant mesuré sur l'interface :	Iout - 0,009	_____	Iout + 0,009		
Courant élevé (Iout) :	89,964	_____	90,036		
Courant mesuré sur l'interface :	Iout - 0,036	_____	Iout + 0,036		
Effet de charge de courant constant :					
	- 0,012	_____	+ 0,012		
Tests d'absorption de courant					
100% du courant nominal :	- 90,03	_____	- 89,97		

	Réglages de l'appareil testé RP7982A	2 - Réglages de la charge RP7972A ou RP7982A
Programmation et relecture de la tension min. :	Priorité de tension : 1 V, 5 A	non utilisé
Programmation et relecture de la tension élevée :	Priorité de tension : 1000 V, 5 A	non utilisé
Effet de charge de tension constante, ondulation et bruit de tension constante* :	Priorité de tension : 333 V, 91 A	Priorité de courant : 505 V, -90 A
Réponse transitoire :	Priorité de tension : 333 V, 91 A, Comp 0	Priorité de courant : 550 V, -36 A à -81 A, vitesse=max, Comp 3**
Programmation et relecture du courant min. :	Priorité de courant : 505 V, 0 A	Priorité de tension : 500 V, 0 A
Programmation et relecture du courant élevé :	Priorité de courant : 505 V, 90 A	Priorité de tension : 333 V, -91 A
Effet de charge de courant constant :	Priorité de courant : 1020 V, 30 A	Priorité de tension : 1000 V, -30,5 A
100 % du courant nominal (Isink) :	Priorité de courant : 505 V, -90 A	Priorité de tension : 333 V, 91 A

\* **ATTENTION** Dégâts matériels. La sonde LeCroy DXC100A est limitée à 500 V. Ne la connectez que pour le test d'ondulation et de bruit de tension constante.

\*\* La comparaison de courant 3 génère un palier de temps mesuré de 40 µs dans la liste de charge, qui est nécessaire pour le test de réponse de transitoire.

Lorsque vous utilisez deux appareils RP7973A comme charge, réglez le premier RP7973A en CC à -36 A, et le second RP7973A pour créer une impulsion de 0 à -45 A.

## Keysight RP7983A

RP7983A Relevé de test des performances		Numéro de rapport _____	Date _____
Description du test	Valeurs min. spécifiées	Résultats	Valeurs max. spécifiées
Programmation et relecture de la tension			
Tension minimale (Vout) :	1,8494	_____	2,1506
Tension mesurée sur l'interface :	Vout - 0,1506	_____	Vout + 0,1506
Haute tension (Vout) :	1999,25	_____	2000,75
Tension mesurée sur l'interface :	Vout - 0,75	_____	Vout + 0,75
Effet de charge de tension constante :			
	- 0,1	_____	+ 0,1
Ondulation et bruit de tension constante			
Crête à crête :	S.O.	_____	3,0
Valeur efficace vraie :	S.O.	_____	0,4
Réponse transitoire à 300 µs :			
	- 20	_____	+ 20
Programmation et relecture du courant			
Courant minimal (Iout) :	- 0,003	_____	0,003
Courant mesuré sur l'interface :	Iout - 0,003	_____	Iout + 0,003
Courant élevé (Iout) :	29,988	_____	30,012
Courant mesuré sur l'interface :	Iout - 0,12	_____	Iout + 0,12
Effet de charge de courant constant :			
	- 0,004	_____	+ 0,004
Tests d'absorption de courant			
100% du courant nominal :	- 30,012	_____	- 29,988

	Réglages de l'appareil testé RP7983A	2 - Réglages de la charge RP7973A ou RP7983A
Programmation et relecture de la tension min. :	Priorité de tension : 2 V, 5 A Priorité de tension : 2000 V, 5 A	non utilisé non utilisé
Programmation et relecture de la tension élevée :	Priorité de tension : 500 V, 30,5 A Priorité de tension : 1000 V, 30,5 A, Comp 0	Priorité de courant : 1010 V, -30 A Priorité de courant : 1500 V, -12 A à -27 A, vitesse=max, Comp 3**
Effet de charge de tension constante, ondulation et bruit de tension constante* :	Priorité de courant : 1010 V, 0 A Priorité de courant : 1010 V, 30 A	Priorité de tension : 1000 V, 0 A
Réponse transitoire :	Priorité de courant : 2040 V, 15 A	Priorité de tension : 1000 V, -30,5 A
Programmation et relecture du courant min. :	Priorité de courant : 1010 V, -30 A	Priorité de tension : 2000 V, -15,2 A
Programmation et relecture du courant élevé :		Priorité de tension : 1000 V, 30,5 A
Effet de charge de courant constant :		
100 % du courant nominal (Isink) :		

\* **ATTENTION** Dégâts matériels. La sonde LeCroy DXC100A est limitée à 500 V. Ne la connectez que pour le test d'ondulation et de bruit de tension constante.

\*\* La comparaison de courant 3 génère un palier de temps mesuré de 40 µs dans la liste de charge, qui est nécessaire pour le test de réponse de transitoire.

Lorsque vous utilisez deux appareils RP7973A comme charge, réglez le premier RP7973A en CC à -12 A, et le second RP7973A pour créer une impulsion de 0 à -15 A.

## Keysight RP7984A

RP7984A Relevé de test des performances		Numéro de rapport _____	Date _____
Description du test	Valeurs min. spécifiées	Résultats	Valeurs max. spécifiées
Programmation et relecture de la tension			
Tension minimale (Vout) :	1,39955	_____	1,60045
Tension mesurée sur l'interface :	Vout - 0,10045	_____	Vout + 0,10045
Haute tension (Vout) :	1499,45	_____	1500,55
Tension mesurée sur l'interface :	Vout - 0,55	_____	Vout + 0,55
Effet de charge de tension constante :			
	- 0,075	_____	+ 0,075
Ondulation et bruit de tension constante			
Crête à crête :	S.O.	_____	2,25
Valeur efficace vraie :	S.O.	_____	0,3
Réponse transitoire à 300 µs :			
	- 15	_____	+ 15
Programmation et relecture du courant			
Courant minimal (Iout) :	- 0,006	_____	0,006
Courant mesuré sur l'interface :	Iout - 0,006	_____	Iout + 0,006
Courant élevé (Iout) :	59,976	_____	60,024
Courant mesuré sur l'interface :	Iout - 0,024	_____	Iout + 0,024
Effet de charge de courant constant :			
	- 0,008	_____	+ 0,008
Tests d'absorption de courant			
100% du courant nominal :	-60,024	_____	-59,976

	Réglages de l'appareil testé RP7984A	2 - Réglages de la charge RP7973A
Programmation et relecture de la tension min. :	Priorité de tension : 1,5 V, 5 A	non utilisé
	Priorité de tension : 1500 V, 5 A	non utilisé
Programmation et relecture de la tension élevée :	Priorité de tension : 500 V, 61,2 A	Priorité de courant : 550 V, -60 A
	Priorité de tension : 500 V, 61,2 A	Priorité de courant : 520 V, -60 A
Effet de charge de tension constante :	Priorité de tension : 500 V, 61,2 A, Comp 0	Priorité de courant : 1100 V, -24 A à -54 A, vitesse=max, Comp 3
Ondulation et bruit de tension constante :	Priorité de courant : 1010 V, 0 A	Priorité de tension : 1000 V, 0 A
Réponse transitoire :	Priorité de courant : 510 V, 60 A	Priorité de tension : 500 V, -61,2 A
Programmation et relecture du courant min. :	Priorité de courant : 1515 V, 20 A	Priorité de tension : 1500 V, -20,5 A
Programmation et relecture du courant élevé :	Priorité de courant : 760 V, -60 A	Priorité de tension : 500 V, 61,2 A
Effet de charge de courant constant :		
100 % du courant nominal (Isink) :		

\* **ATTENTION** Dégâts matériels. La sonde LeCroy DXC100A est limitée à 500 V. Ne la connectez que pour le test d'ondulation et de bruit de tension constante.

\*\* La comparaison de courant 3 génère un palier de temps mesuré de 40 µs dans la liste de charge, qui est nécessaire pour le test de réponse de transitoire.

Lorsque vous utilisez deux appareils RP7973A comme charge, réglez le premier RP7973A en CC à -24 A, et le second RP7973A pour créer une impulsion de 0 à -30 A.

# 7

## Maintenance et réparation

**Introduction**

**Procédure d'autotest**

**Mise à jour du microprogramme**

**Nettoyage de la mémoire de l'instrument**

**Commutateurs d'étalonnage**

**Remplacement de la pile**

**Démontage**



## Introduction

### Service de réparation disponible

Si votre instrument tombe en panne pendant la période de garantie, Keysight Technologies s'engage à le réparer ou le remplacer selon les conditions de votre garantie. Après l'expiration de la garantie, Keysight propose des services de réparation économiques.

De nombreux produits Keysight peuvent faire l'objet de contrats de maintenance en option après l'expiration de la garantie.

### Trouver un service de réparation (international)

Pour faire réparer votre instrument, contactez votre **Centre de maintenance Keysight Technologies** le plus proche. Ce dernier organisera la maintenance ou le remplacement, et vous fournira des informations sur la garantie ou le coût des réparations selon le cas. Demandez au Centre de maintenance Keysight Technologies les consignes d'expédition, y compris les composants à envoyer. Nous recommandons de conserver le carton d'emballage pour les expéditions de retour.

### Avant de retourner l'appareil

Avant de retourner l'appareil, vérifiez que la panne provient de l'instrument et non de connexions externes. Vérifiez également que l'instrument a été étalonné avec précision au cours de l'année précédente (voir la section **Intervalle d'étalonnage**).

Si l'appareil ne fonctionne pas, vérifiez que :

- le cordon d'alimentation secteur est correctement branché à l'instrument ;
- le cordon d'alimentation secteur est branché dans une prise secteur sous tension ;
- l'interrupteur d'alimentation Power On/Standby du panneau avant est enfoncé.

Si l'autotest échoue, vérifiez que :

tous les raccords (avant et arrière) sont retirés pendant l'exécution de l'autotest. Pendant l'autotest, des erreurs peuvent se produire en raison des signaux présents sur les câbles externes (ex. longs cordons de test qui provoquent un effet d'antenne).

### Remballage pour l'expédition

Pour expédier l'instrument à des fins de maintenance ou de réparation, procédez comme suit :

- Apposez sur l'appareil une étiquette d'identification du propriétaire et indiquant l'intervention nécessaire (maintenance ou réparation). Incluez les numéros de modèle et de série complets de l'appareil.
- Placez l'appareil dans son emballage d'origine avec des matériaux d'emballage adéquats.

- Protégez le colis avec des bandes adhésives ou métalliques résistantes.
- Si le conteneur d'expédition d'origine n'est pas disponible, Keysight recommande fortement de se procurer l'un des kits d'emballage suivants pour veiller à ce que l'appareil ne soit pas endommagé pendant l'expédition :  
RÉF. 5188-9520 - Kit d'emballage pour modèles RP7972A/RP7973A.

Keysight recommande d'assurer systématiquement vos expéditions.

## Nettoyage

**AVERTISSEMENT**

**RISQUE D'ÉLECTROCUTION** Pour éviter tout risque, débranchez l'alimentation secteur avant le nettoyage.

---

Nettoyez l'extérieur de l'instrument avec un chiffon doux non pelucheux et légèrement humide. N'utilisez pas de détergent. Le démontage n'est pas nécessaire ni recommandé pour le nettoyage.

## Procédure d'autotest

### Autotest à la mise sous tension

À chaque mise sous tension de l'instrument, un autotest est réalisé. Il certifie que l'instrument est opérationnel.

L'autotest vérifie que l'ensemble minimum du système d'alimentation et d'analyse logique fonctionnent correctement. Il n'active pas la sortie et ne soumet la sortie à aucune tension. Il laisse l'instrument à l'**état de réinitialisation**.

### Autotest initié par l'utilisateur

L'autotest initié par l'utilisateur est identique à l'autotest à la mise sous tension.

Aide-mémoire des menus du panneau avant	Commande SCPI
Mettez l'instrument hors tension, puis rallumez-le.	<b>*TST?</b>
Si l'autotest échoue, le voyant EER du panneau avant s'allume. Appuyez sur la touche Error pour afficher la liste des erreurs.	Si la valeur 0 est renvoyée, l'autotest est réussi. Si la valeur 1 est renvoyée, l'autotest échoue.  Si l'autotest échoue, utilisez la commande <b>SYSTem:ERRor?</b> pour afficher l'erreur d'autotest.

Pour une liste des erreurs, reportez-vous à la section **Messages d'erreur SCPI**.

## Mise à jour du microprogramme

### REMARQUE

Pour déterminer la version de microprogramme installée sur votre instrument, reportez-vous à la section **Identification de l'instrument**. Tous les appareils dans une configuration principale/secondaire doivent avoir un microprogramme identique.

---

### Logiciel requis

Pour mettre à jour le microprogramme, vous devez télécharger les deux éléments suivants sur votre ordinateur depuis la page de téléchargement du microprogramme

[www.keysight.com/find/RPSfirmware](http://www.keysight.com/find/RPSfirmware).

- L'utilitaire de mise à jour de programmes universel
- La dernière version du microprogramme

### Procédure de mise à jour

Une fois que vous avez copié les deux éléments sur votre ordinateur, procédez comme suit :

1. Exécutez l'utilitaire de mise à jour de microprogrammes universel
2. Accédez au dossier où vous avez enregistré le microprogramme que vous venez de télécharger. Appuyez sur Next.
3. Sélectionnez l'interface que vous utilisez pour communiquer avec votre instrument et entrez la chaîne d'adresse ou de connexions. Appuyez sur Next.
4. Vérifiez que les informations correspondent bien à l'instrument que vous mettez à jour. Appuyez sur Lancer la mise à jour.

L'utilitaire de mise à jour va maintenant mettre à jour le microprogramme et redémarrer votre instrument.

### Restriction de l'accès

Notez que vous pouvez restreindre l'accès à l'instrument à l'aide de l'utilitaire de mise à jour de microprogrammes. Cela empêche les utilisateurs non autorisés de mettre le microprogramme à jour.

Aide-mémoire des menus du panneau avant

Commande SCPI

## 7 Maintenance et réparation

---

Sélectionnez **System\Admin\Update**

Non disponible

Cochez la case **Must log in as admin** (Doit se connecter en tant qu'administrateur).

Cette option requiert qu'un utilisateur se connecte au menu Admin avant que l'utilitaire de mise à jour de microprogrammes ne mette à jour le microprogramme.

---

## Nettoyage de la mémoire de l'instrument

**REMARQUE** Cette procédure est déconseillée dans les applications de routine en raison des risques de perte involontaire de données.

Cette procédure nettoie toutes les données utilisateur. Elle écrit uniquement des zéros dans la mémoire Flash, puis effectue un effacement complet de la mémoire du processeur conformément à la fiche technique du fabricant. Les données d'identification, telles que le microprogramme de l'instrument, le numéro du modèle, le numéro de série, l'adresse MAC et les données d'étalonnage ne sont pas effacées. Une fois les données effacées, l'instrument est redémarré.

Si le menu Admin est inaccessible, il est probablement protégé par un mot de passe.

Aide-mémoire des menus du panneau avant	Commande SCPI
Sélectionnez <b>System\Admin\Sanitize</b>	<b>SYST:SEC:IMM</b>
Sélectionnez Sanitize.	
Cette option permet de supprimer toutes les données utilisateurs de l'instrument et de remettre ce dernier sous tension.	

Pour plus d'informations, consultez la page <http://rfmw.em.keysight.com/aerospace/index.aspx>.

### Activation après le nettoyage

La première fois que l'appareil est allumé après avoir été nettoyé, plusieurs erreurs de somme de contrôle NVRAM seront générées. Ces erreurs annoncent le fait que deux fichiers manquaient et ont été recréés avec des valeurs par défaut. Redémarrez l'appareil une nouvelle fois pour supprimer les erreurs.

### Nettoyage d'un instrument inopérant

Si l'instrument ne fonctionne plus et que vous ne pouvez pas utiliser la procédure de nettoyage décrite ci-dessus, vous devez retirer physiquement la carte P600 de l'instrument et la détruire. Reportez-vous à la section **Démontage**.

## Commutateurs d'étalonnage

**AVERTISSEMENT**

**RISQUE D'ÉLECTROCUTION** Seules des personnes qualifiées, formées à la maintenance et conscientes des risques d'électrocution encourus peuvent démonter les capots de l'instrument. Débranchez toujours le cordon d'alimentation secteur et tous les circuits externes avant de démonter le capot de l'instrument. Certains circuits sont activés et brièvement alimentés, même lorsque l'interrupteur d'alimentation est en position d'arrêt.

---

L'accès aux commandes d'étalonnage est contrôlé au moyen de deux commutateurs. Situés sur la carte d'interface, ces commutateurs sont accessibles en retirant le capot supérieur.

### Accès au commutateur d'étalonnage

1. Retirez le capot de l'instrument comme décrit dans la section **Démontage**.
2. Le commutateur d'étalonnage est situé sur la carte d'interface sur l'angle arrière de l'appareil. Pour modifier les réglages des commutateurs d'étalonnage, déplacez les commutateurs à l'aide d'un petit tournevis. Par défaut, tous les commutateurs sont réglés en position ON (ACTIVÉ) (voir ci-dessous).
3. Reposez le capot supérieur une fois l'opération terminée.

**ATTENTION**

N'utilisez pas de pinceau pour déplacer les commutateurs. Toute poussière de graphite déposée sur les commutateurs est conductrice.

---

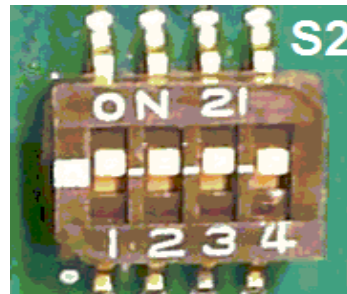
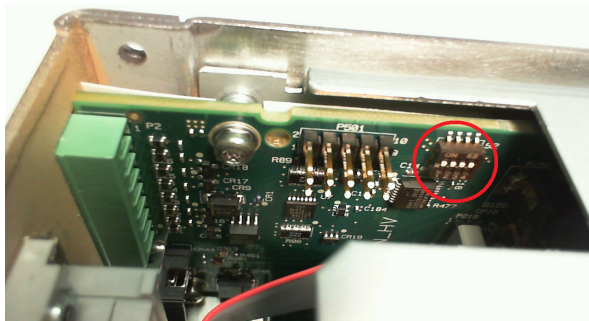

### Fonctions de commutation

Les commutateurs 1 et 2 définissent la configuration de l'étalonnage comme suit. Les commutateurs 3 et 4 ne sont pas utilisés.

	Commutateur 1	Commutateur 2	Description
Normal	ON	ON	Réglage par défaut du commutateur. Les fonctions d'étalonnage sont accessibles après la saisie d'un mot de passe numérique. Le mot de passe par défaut est 0 (zéro).
Clear Password	OFF	ON	Le mot de passe d'administration/étalonnage est réinitialisé à 0 lorsque l'instrument est mis sous tension pour la première fois. Utilisez ce réglage si vous avez oublié le mot de passe.
Inhibit Calibration	ON	OFF	Toutes les commandes d'étalonnage sont désactivées. Cela est utile lorsque l'accès est protégé par les joints de l'instrument.

## Remplacement de la batterie

### AVERTISSEMENT

**RISQUE D'ÉLECTROCUTION** Seules des personnes qualifiées, formées à la maintenance et conscientes des risques d'électrocution encourus peuvent démonter les capots de l'instrument. Débranchez toujours le cordon d'alimentation secteur et tous les circuits externes avant de démonter le capot de l'instrument. Certains circuits sont activés et brièvement alimentés, même lorsque l'interrupteur d'alimentation est en position d'arrêt.

La pile interne commande l'horloge système. La fonction principale de l'horloge est de fournir des informations d'horodatage pour le logiciel de contrôle et d'analyse d'alimentation BenchVue. Si la pile tombe en panne, le logiciel n'aura plus d'heure. Aucune autre fonction de l'instrument n'est affectée.

Dans des conditions normales de fonctionnement à température ambiante, la durée de vie de la batterie de lithium est comprise entre sept et dix ans. Notez que la durée de vie de la batterie sera réduite si l'instrument est stocké pendant une longue période à des températures supérieures à 40 degrés C.

La référence de la batterie est Panasonic CR 2032.

### Procédure de remplacement

1. Retirez le capot de l'instrument comme décrit dans la section **Démontage**.
2. Retirez la carte de commande comme décrit dans la section **Démontage**.



## 7 Maintenance et réparation

3. La batterie est située sur la carte Constellation, sous le câble-ruban.

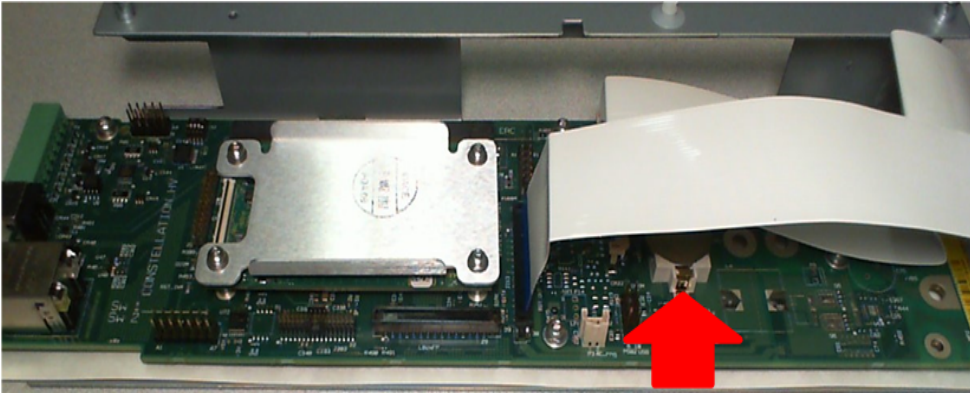

4. Pour accéder à la batterie, libérez les câbles-ruban en tirant sur la languette de verrouillage.

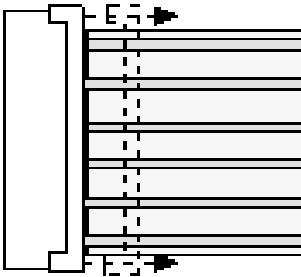

5. À l'aide d'un petit tournevis à lame plate, soulevez délicatement le côté de la batterie indiqué par une flèche.

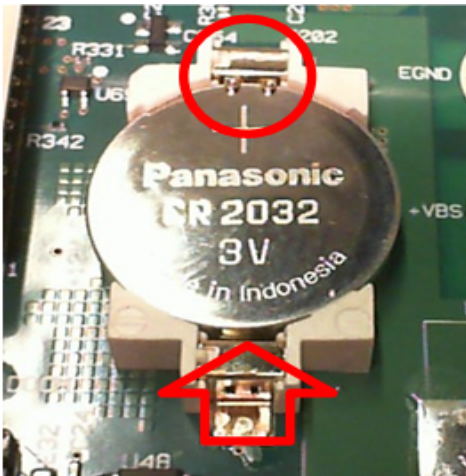

6. Installez la batterie neuve. Assurez-vous que le côté positif (+) est orienté vers le haut. Placez la batterie sous les petites agrafes à ressort indiquées par le cercle, puis enfoncez le côté opposé de la batterie indiqué par la flèche rouge. La partie supérieure des agrafes à ressort doit être visibles une fois la batterie en place (voir le cercle rouge).
7. Reposez les rubans-câbles en introduisant complètement les câbles dans le connecteur, puis fixez les câbles en appuyant sur la languette de verrouillage.

8. Remplacez la carte de commande et le capot supérieur lorsque vous avez terminé. Lors du remontage, serrez toutes les vis à 1,016 Nm.
9. Réinitialisez la date et l'heure (voir **Réglage de l'horloge**).

## Démontage

**AVERTISSEMENT**

**RISQUE D'ÉLECTROCUTION** Seules des personnes qualifiées, formées à la maintenance et conscientes des risques d'électrocution encourus peuvent démonter les capots de l'instrument. Débranchez toujours le cordon d'alimentation secteur et tous les circuits externes avant de démonter le capot de l'instrument. Certains circuits sont activés et brièvement alimentés, même lorsque l'interrupteur d'alimentation est en position d'arrêt.

---

### Précautions contre les décharges électrostatiques (ESD)

Pendant les manipulations, même des décharges électrostatiques inférieures à 50 V peuvent endommager la plupart des composants électriques.

Les recommandations suivantes permettent d'éviter les dommages dus aux décharges électrostatiques (ESD) pendant les interventions de maintenance :

- Démontez les instruments uniquement dans une zone antistatique.
- Utilisez un plan de travail conducteur pour réduire les décharges.
- Utilisez un bracelet antistatique pour réduire les décharges.
- Manipulez l'instrument au minimum.
- Conservez les pièces détachées dans un emballage d'origine antistatique.
- Enlevez de l'environnement immédiat du poste de travail les matières plastiques, la mousse, le vinyle, le papier et les autres matériaux à fort potentiel électrostatique.

### Outils nécessaires

- Tournevis Torx T10 pour le démontage du capot et de la carte
- Tournevis Torx T8 pour le démontage de la P600
- Petit tournevis à lame plate pour retirer la batterie

### Démontage du capot

1. Coupez l'alimentation. Débranchez tous les câbles de l'instrument.
2. Retirez les 7 (ou 3) vis à tête plate situées en haut de l'instrument, les 10 vis à tête plate situées sur les côtés et les 2 vis à tête cylindrique situées à l'arrière (voir la figure ci-dessous). Placez les vis dans un récipient afin de ne pas les perdre.
3. Retirez le capot de l'instrument.

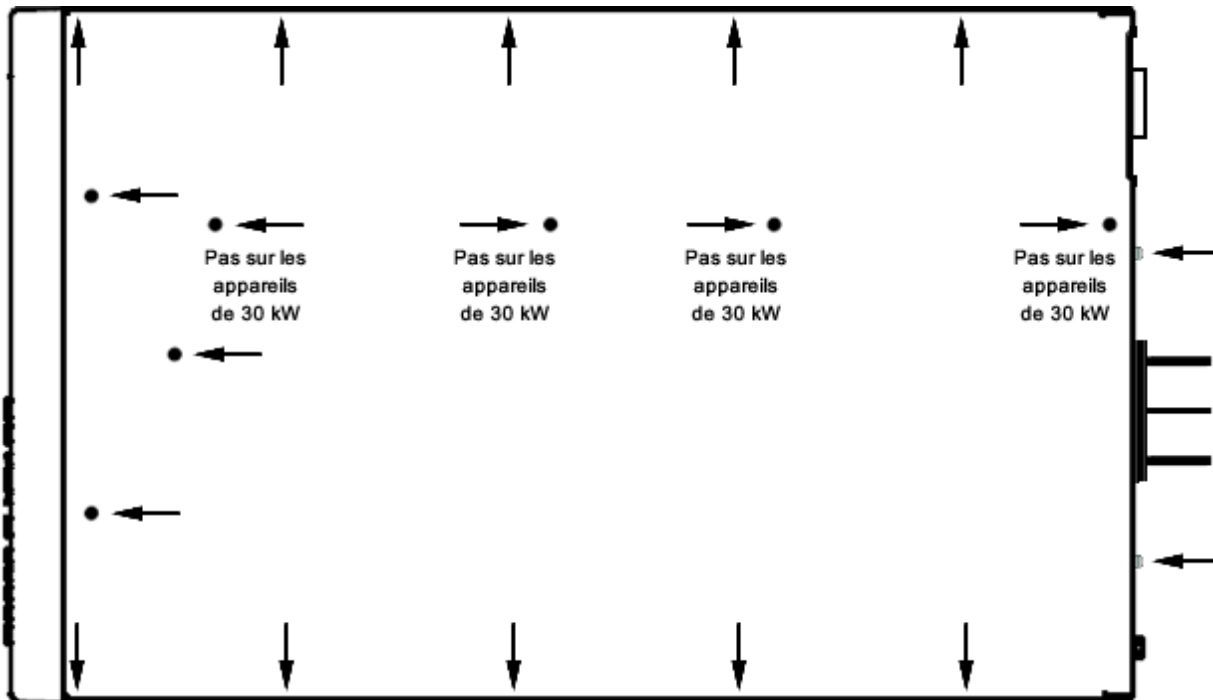

### Démontage de la carte de commande

La carte de commande est située à l'extérieur de la carte Constellation. Il faut la retirer pour pouvoir accéder à la batterie et à la carte P600, qui sont toutes deux situées sur la carte Constellation.

1. Comme indiqué ci-dessous, retirez d'abord les deux vis situées sur la partie supérieure du panneau de commande. Placez les vis dans un récipient afin de ne pas les perdre.

Retirez  
les vis



2. Vous pouvez maintenant soulever la carte de son socket et la déplacer sur le côté.  
(Lors du remontage de la carte de commande, n'oubliez pas de remplacer l'isolant derrière celle-ci.)

### Démontage de la carte Constellation

Si vous avez du mal à accéder à la carte Constellation après avoir déplacé la carte de commande, vous pouvez retirer l'ensemble de la carte Constellation.

1. Retirez les trois vis sur le côté du châssis qui maintiennent la carte Constellation. Placez les vis dans un récipient afin de ne pas les perdre.

## 7 Maintenance et réparation

Retirez  
les vis

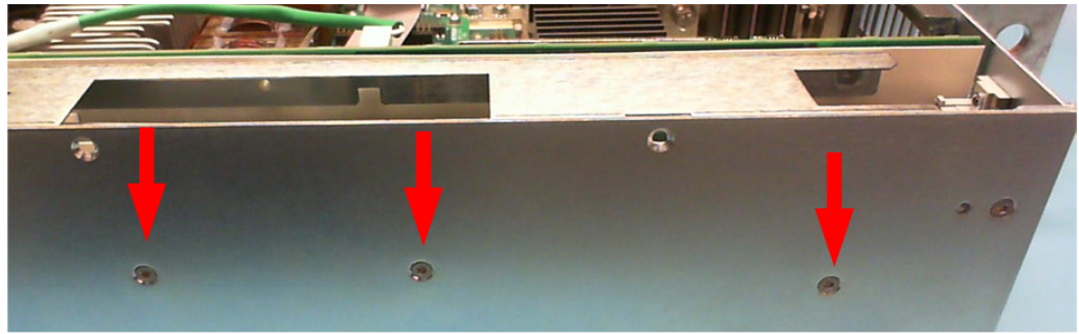

2. Vous pouvez maintenant soulever l'ensemble Constellation de l'appareil pour accéder à la carte P600 et à la batterie.
3. Pour accéder à la carte P600, utilisez un tournevis Torx T8 pour retirer les quatre vis du dissipateur thermique. Vous pouvez maintenant retirer la carte P600 de son socket.

Retirez les 4  
vis du  
dissipateur  
thermique pour  
déposer la  
carte P600

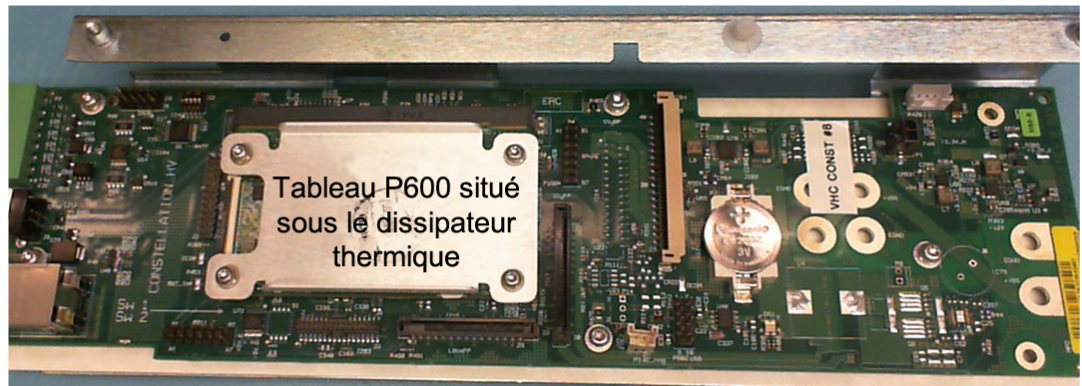

4. Lors du remontage, serrez toutes les vis à 1,016 Nm.

# Index

\*  
\*CLS 215  
\*ESE 215  
\*ESR? 215  
\*IDN? 216  
\*OPC 216  
\*OPC? 217  
\*OPT? 217  
\*RCL 217  
\*RST 218  
\*SAV 218  
\*SRE 218  
\*STB? 219  
\*TRG 219  
\*TST? 219  
\*WAI 220

## A

Accessoires 38  
Aide 98  
Aide-mémoire des commandes 27  
Alimentation secteur  
    caractéristiques communes 67  
Attente de déclenchement 219  
Autotest 219

## B

Balayage  
    mesure 150

## C

Capacité de charge 80  
Caractéristiques 41  
    communes 42  
Charge capacitive  
    limite 54  
Charge inductive  
    limite 52  
Circulation d'air 63  
Clock Setup (Réglage de l'horloge) 174  
CLS 215, 282  
Commande  
    aide-mémoire 27  
    caractères de fin 190  
    séparateurs 190  
    sous-systèmes 195  
    temps de traitement des commandes 194  
Commande FUNCtion 213  
Commande LXI 228  
Commande STEP 254  
Commandes courantes IEEE-488 215  
Commandes de compatibilité 291

Commandes de sous-système 195

communication  
    GPIB 100  
    interface web 105  
    LAN 101  
    sockets 106  
    telnet 106  
    USB 100  
    verrouillage 107

Compensation 113, 115

Connexions

    alimentation secteur 67  
    appareil unique 72  
    barre conductrice 72  
    interface 87  
    mesure 72, 76  
    parallèles 83  
    principale/secondaire 85  
    série 86

Contacter

    Keysight 15

Conventions

    syntaxiques 191

Cordon d'alimentation 68

Coupure secteur 116

Courant 96

    absorption 123

    compensation 115

## D

Décalage  
tension CC 98  
Décalage CC 98  
Déclenchement  
didacticiel 275  
schéma 276  
Demande de service  
activation 218  
Démontage 326  
Désactivation  
protection 131  
Didacticiel d'état 269

## E

E/S 282  
file d'attente 282  
Écran  
veille 172  
verrouillage 173  
EDP  
graphique 58  
protection 126  
Effacer l'état 282  
Empilage 64  
En parallèle  
connexions 83  
fonctionnement 117

End-Or-Identify 191  
Enregistrement de  
données 160  
Enregistrement des confi-  
gurations 171  
Enregistrement des don-  
nées  
déclenchement 161  
récupération 163  
Entrée CA  
détails 45  
Environnement 63  
Équations de la courbe spa-  
tiale 181  
Équations de la courbe ter-  
restre 182  
Équations SAS 181  
Erreur  
messages 282  
ESE 215  
ESR? 215  
Étalonnage 304  
commutateurs 322  
équipement de test 294  
fréquence 305  
État  
état de  
fonctionnement  
269  
état suspect 270

événement  
standard 271  
octet d'état 219, 272  
schéma 274  
État de réinitialisation  
paramètres 277

## F

Factory reset 218  
FIFO (PEPS) 282  
File d'attente 282  
E/S 282  
Fonctionnalités 16  
Fonctionnement en paral-  
lèle 117  
Formulaires de relevé de  
test 310

## G

GPIB 282

## H

Horloge de  
surveillance 129

## I

Identification de  
l'instrument 171  
IDN? 216  
Impéd 175  
Inductance de charge  
limites 79

Inductance des fils 81  
Informations légales 9  
Inspection 62  
Interface à distance 100  
interface de commande à distance de communication 100  
Introduction 189  
Langage SCPI 189  
Isc 175

**L**

Langage SCPI 189  
Introduction 189

**M**

menus 24  
menus du panneau avant 24  
Message disponible 218-219  
Mesure  
déclenchement 154  
fenêtrage 151  
précision avec NPLC 58  
Mesures en ampères-heures 151  
Mesures en watts-heures 151  
Mesures moyennes 150  
Mesures numérisées 152

Mise à jour du micro-programme 319  
Mode de priorité  
courant 184  
réglage 110  
tension 183  
Modèles 37  
Montage en baie 64  
Mot de passe  
définition 173  
Mots-clés 190

**N**

Nettoyage 14, 317  
Nettoyage de la mémoire de l'instrument 321

**O**

OPC 216  
OPC? 217  
OPT? 217  
Options 38

**P**

panneau arrière 19  
panneau avant 18, 21-22, 24  
Paramètres de courbe 176  
Paramètres de tableau 177  
Paramètres non volatiles 280

Partage de courant 117  
Photovoltaïque 175  
paramètres de courbe 176  
paramètres de tableau 177  
Port numérique  
bidirectionnel 165  
couple de sortie 169  
déclencheur externe 166  
entrée 166  
inhibition de l'entrée 167  
sortie de défaut 167  
Premier entré / premier sorti 282  
Principal/secondaire  
dépannage 122  
fonctionnement 117  
Principale/secondaire  
programmation 120  
Procédure d'autotest 318  
Programmation  
absorption du courant 123  
ARB 141  
bande passante 113  
courant 112  
port numérique 164  
priorité 110  
protection 125



- résistance 113
- tension 111
- transitoires 132
- vitesse de balayage 112
- Protection
  - contre les surchauffes 126
  - contre les surintensités 125
  - contre les surtensions 125
  - désactivation 131

## R

- RCL 217
- Réalisation de mesures 150
- Récapitulatif des données suspects 218-219
- Récapitulatif des opérations standard 218-219
- REFerence 27
- Régénératif
  - fonctionnement 17, 67, 124
- Registre des opérations standard 218-219
- Régler
  - courant de sortie 96
  - surtension 97
  - tension de sortie 95
  - tension décalage CC 98

- Réinitialisation de la configuration d'usine 277
- Remballage pour l'expédition 316
- Remplacement de la batterie 323
- Réponse de la programmation
  - petit signal 57
- Représentation graphique des impédances 48
- Requête
  - Registre de l'octet d'état 219
- Requête POWer 237
- Requêtes 190
- RST 218

## S

- SAS
  - bande passante 179
  - dépannage 180
  - facteurs d'échelle 179
- SAV 218
- SCPI 189
  - aide-mémoire 27
- Section des fils 73
- Sécurité 62
  - capot 74
  - consignes 12
- Service de réparation 316

- Signal arbitraire 141
- sortie
  - activation 116
- Sortie
  - bande passante 113
  - comportement
    - d'activation ou de désactivation 147
  - courant 96
  - délai d'activation/de désactivation 144
  - liste 137
  - mode d'activation/de désactivation 115
  - organigramme
    - d'activation ou de désactivation 148
  - palier 136
  - tension 95
  - transitoire 132
- Sorties
  - séquencement 144
- Sous-système ABORt 196
- Sous-système ARB 197
- Sous-système CALibrate 199
- Sous-système CURRent 202
- Sous-système DIGital 206
- Sous-système DISPlay 208
- Sous-système FETCh 209

Sous-système FORMat 212  
Sous-système HCOPy 214  
Sous-système INITiate 221  
Sous-système  
  INSTrument 222  
Sous-système LIST 225  
Sous-système  
  MEASure 229  
Sous-système OUTPut 231  
Sous-système  
  SASimulator 238  
Sous-système SENSE 244  
Sous-système SOURce 248  
Sous-système STATus 249  
Sous-système SYSTem 255  
Sous-système TRIGger 260  
Sous-système  
  VOLTage 263  
Sous-tension  
  protection 130  
Spécifications 39  
SRE 218  
STB? 219  
Surintensité  
  protection 128  
Surtension 97  
  protection 127  
Système d'aide 98  
Système d'état SCPI 282

## T

Tension 95  
  compensation 113  
  limite basse 111  
Tension flottante 79  
TRG 219  
TST? 219  
Types de paramètres 192

## U

Utilisation de Device  
  Clear 193

## V

Variation de tension tran-  
  sitoire 81  
Vérification 296  
  équipement de test 294  
Vmp 175  
Voc 175

## W

WAI 220