

Keysight Technologies Series E4360 Modular Solar Array Simulator

User's Guide

Legal Notices

© Keysight Technologies 2008 – 2018

No part of this document may be photocopied, reproduced, or translated to another language without the prior agreement and written consent of Keysight Technologies as governed by United States and international copyright laws.

Manual Part Number

E4360-90001

Edition

Edition 8, December 2018

Printed in

Available in electronic format only

Published by

Keysight Technologies, Inc.
550 Clark Drive, Suite 101
Budd Lake, NJ 07828 USA

Technologies Licenses

The hardware and or software described in this document are furnished under a license and may be used or copied only in accordance with the terms of such license.

Waste Electrical and Electronic Equipment (WEEE) Directive 2002/96/EC

This product complies with the WEEE Directive 2002/96/EC marketing requirement. The affixed product label (see below) indicates that you must not discard this electrical/electronic product in domestic household waste.

Product Category: With reference to the equipment types in the WEEE directive Annex 1, this product is classified as “Monitoring and Control instrumentation” product.

Do not dispose in domestic household waste.

To return unwanted products, contact our local Keysight office, or see www.keysight.com/environment/product for more information.



U.S. Government Rights

The Software is “commercial computer software,” as defined by Federal Acquisition Regulation (“FAR”) 2.101. Pursuant to FAR 12.212 and 27.405-3 and Department of Defense FAR Supplement (“DFARS”) 227.7202, the U.S. government acquires commercial computer software under the same terms by which the software is customarily provided to the public. Accordingly, Keysight provides the Software to U.S. government customers under its standard commercial license, which is embodied in its End User License Agreement (EULA), a copy of which can be found at www.keysight.com/find/sweula. The license set forth in the EULA represents the exclusive authority by which the U.S. government may use, modify, distribute, or disclose the Software. The EULA and the license set forth therein, does not require or permit, among other things, that Keysight: (1) Furnish technical information related to commercial computer software or commercial computer software documentation that is not customarily provided to the public; or (2) Relinquish to, or otherwise provide, the government rights in excess of these rights customarily provided to the public to use, modify, reproduce, release, perform, display, or disclose commercial computer software or commercial computer software documentation. No additional government requirements beyond those set forth in the EULA shall apply, except to the extent that those terms, rights, or licenses are explicitly required from all providers of commercial computer software pursuant to the FAR and the DFARS and are set forth specifically in writing elsewhere in the EULA. Keysight shall be under no obligation to update, revise or otherwise modify the Software. With respect to any technical data as defined by FAR 2.101, pursuant to FAR 12.211 and 27.404.2 and DFARS 227.7102, the U.S. government acquires no greater than Limited Rights as defined in FAR 27.401 or DFAR 227.7103-5 (c), as applicable in any technical data.

Warranty

THE MATERIAL CONTAINED IN THIS DOCUMENT IS PROVIDED “AS IS,” AND IS SUBJECT TO BEING CHANGED, WITHOUT NOTICE, IN FUTURE EDITIONS. FURTHER, TO THE MAXIMUM EXTENT PERMITTED BY APPLICABLE LAW, KEYSIGHT DISCLAIMS ALL WARRANTIES, EITHER EXPRESS OR IMPLIED, WITH REGARD TO THIS MANUAL AND ANY INFORMATION CONTAINED HEREIN, INCLUDING BUT NOT LIMITED TO THE IMPLIED WARRANTIES OF MERCHANTABILITY AND FITNESS FOR A PARTICULAR PURPOSE. KEYSIGHT SHALL NOT BE LIABLE FOR ERRORS OR FOR INCIDENTAL OR CONSEQUENTIAL DAMAGES IN CONNECTION WITH THE FURNISHING, USE, OR PERFORMANCE OF THIS DOCUMENT OR OF ANY INFORMATION CONTAINED HEREIN. SHOULD KEYSIGHT AND THE USER HAVE A SEPARATE WRITTEN AGREEMENT WITH WARRANTY TERMS COVERING THE MATERIAL IN THIS DOCUMENT THAT CONFLICT WITH THESE TERMS, THE WARRANTY TERMS IN THE SEPARATE AGREEMENT SHALL CONTROL.

Safety Information

WARNING

A **WARNING** notice denotes a hazard. It calls attention to an operating procedure, practice, or the like that, if not correctly performed or adhered to, could result in personal injury or death. Do not proceed beyond a **WARNING** notice until the indicated conditions are fully understood and met.

CAUTION

A **CAUTION** notice denotes a hazard. It calls attention to an operating procedure, practice, or the like that, if not correctly performed or adhered to, could result in damage to the product or loss of important data. Do not proceed beyond a **CAUTION** notice until the indicated conditions are fully understood and met.

Safety Notices

The following general safety precautions must be observed during all phases of operation of this instrument. Failure to comply with these precautions or with specific warnings or instructions elsewhere in this manual violates safety standards of design, manufacture, and intended use of the instrument. Keysight Technologies assumes no liability for the customer's failure to comply with these requirements.

General

Do not use this product in any manner not specified by the manufacturer. The protective features of this product may be impaired if it is used in a manner not specified in the operation instructions.

Before Applying Power

Verify that all safety precautions are taken. Make all connections to the unit before applying power. Note the instrument's external markings described under "Safety Symbols"

Ground the Instrument

This product is a Safety Class 1 instrument (provided with a protective earth terminal). To minimize shock hazard, the instrument chassis and cover must be connected to an electrical ground. The instrument must be connected to the AC power mains through a grounded power cable, with the ground wire firmly connected to an electrical ground (safety ground) at the power outlet. Any interruption of the protective (grounding) conductor or disconnection of the protective earth terminal will cause a potential shock hazard that could result in personal injury.

Fuses

Only fuses with required rated current, voltage, and specified type (normal blow, time delay, etc.) should be used. Do not use repaired fuses or short-circuited fuseholders. To do so could cause a shock or fire hazard.

Do Not Operate in an Explosive Atmosphere

Do not operate the instrument in the presence of flammable gases or fumes.

Do Not Remove the Instrument Cover

Only qualified, service-trained personnel who are aware of the hazards involved should remove instrument covers. Always disconnect the power cable and any external circuits before removing the instrument cover.

Do Not Modify the Instrument

Do not install substitute parts or perform any unauthorized modification to the product. Return the product to a Keysight Sales and Service Office for service and repair to ensure that safety features are maintained.

In Case of Damage

Instruments that appear damaged or defective should be made inoperative and secured against unintended operation until they can be repaired by qualified service personnel.



















CAUTION

A **CAUTION** notice denotes a hazard. It calls attention to an operating procedure, practice, or the like that, if not correctly performed or adhered to, could result in damage to the product or loss of important data. Do not proceed beyond a **CAUTION** notice until the indicated conditions are fully understood and met.

WARNING

A **WARNING** notice denotes a hazard. It calls attention to an operating procedure, practice, or the like that, if not correctly performed or adhered to, could result in personal injury or death. Do not proceed beyond a **WARNING** notice until the indicated conditions are fully understood and met.

Safety Symbols

	Direct current
	Alternating current
	Both direct and alternating current
	Three phase alternating current
	Earth (ground) terminal
	Protective earth ground terminal.
	Frame or chassis terminal
	Terminal is at earth potential.
	Neutral conductor on permanently installed equipment
	Line conductor on permanently installed equipment.
	On supply
	Off supply
	Standby supply. Unit is not completely disconnected from AC mains when switch is off
	In position of a bi-stable push switch
	Out position of a bi-stable push switch
	Caution, risk of electric shock
	Caution, hot surface
	Caution, refer to accompanying description

In this Book

Specific chapters in this manual contain the following information:

- Quick Reference – Chapter 1 is a quick reference section that helps you quickly become familiar with your Keysight E4360 Modular Solar Array Simulator (SAS).
- Installation – Chapter 2 describes how to install your SAS. It describes how to connect various loads to the output. It discusses remote sensing as well as parallel and series operation.
- Getting Started – Chapter 3 describes how to quickly get started using the instrument in Fixed mode. This chapter also describes how to configure the remote interface.
- Using the SAS – Chapter 4 describes how to use the advanced features of the instrument using the front panel menus and the corresponding SCPI commands.
- Specifications – Appendix A describes the SAS mainframe characteristics and contains application information.
- Using the Digital Port – Appendix B describes how to configure and use the digital port on the back of the instrument.
- SCPI Commands – Appendix C lists the SCPI programming commands along with a short description of each.
- Grouping/Compatibility – Appendix D describes output grouping and compares the Keysight E4360 SAS and earlier Keysight SAS instruments.

For complete details on the SCPI (Standard Commands for Programmable Instruments) commands, refer to the Keysight 14360A Programmer's Reference Guide available at <http://www.keysight.com/find/E4360> under Technical Support

NOTE

You can contact Keysight Technologies at one of the following telephone numbers for warranty, service, or technical support information.

In the United States: (800) 829-4444

In Europe: 31 20 547 2111

In Japan: 0120-421-345

Or use our Web link for information on contacting Keysight in your country or specific location: www.keysight.com/find/assist

Or contact your Keysight Technologies Representative.

The web contains the most up to date version of the manual. Go to <http://www.keysight.com/find/E4360> under Technical Support to get the latest version of the manual.

Contents

1 - Quick Reference Information	9
The Keysight E4360 SAS – At a Glance.....	10
The Front Panel – At a Glance.....	12
The Rear Panel – At a Glance.....	12
Front Panel Display – At a Glance.....	13
Front Panel Keys – At a Glance.....	15
Front Panel Menu Reference.....	16
2 - Installation.....	19
General Information.....	20
Inspecting the Unit.....	21
 Installing the Unit.....	21
AC Line Connection.....	26
Rear Panel Connectors.....	26
Load Connections.....	28
Remote Voltage Sensing.....	31
Connecting Outputs in Parallel	33
Connecting Outputs in Series.....	37
Analog Current Control	38
3 - Getting Started.....	39
Using the Front Panel Controls	40
Using the Front Panel Menu.....	42
In Case of Trouble.....	43
Connecting to the Interfaces.....	44
4 - Using the Solar Array Simulator.....	55
Operating in Fixed Mode	56
Making Measurements.....	57
Using the Protection Functions.....	61
Configuring Paralleled Outputs.....	63
Operating in SAS Mode.....	64
Programming Curve Lists.....	67
Operating in Table Mode.....	72
Data Logging Measurements	76
System-Related Operations	80
A - Specifications and Application Information.....	87
Keysight E4360A SAS Mainframe.....	88
Outline Diagram	90

Peak Power Tracker Application.....	91
Exponential Model Equations*.....	92
Series Switching Regulation	93
Shunt Switching Regulation.....	93
B - Digital Port Functions.....	95
Digital Control Port.....	96
C - SCPI Commands.....	103
SCPI Command Summary.....	104
D - Grouping/Compatibility	109
Output Grouping.....	110
Compatibility	112

1

Quick Reference Information

The Keysight E4360 SAS – At a Glance.....	10
The Front Panel – At a Glance.....	12
The Rear Panel – At a Glance.....	12
Front Panel Display – At a Glance.....	13
Front Panel Keys – At a Glance.....	15
Front Panel Menu Reference.....	16

This chapter concisely describes the operation of the Keysight E4360 Modular Solar Array Simulator (SAS).

This chapter does not describe every operating feature in detail. It is simply a quick reference guide to quickly become familiar with the essential operating features of the instrument.

For complete details on the SCPI (Standard Commands for Programmable Instruments) commands, refer to the Keysight 14360A Programmer's Reference Guide available at <http://www.keysight.com/find/E4360> under Technical Support

NOTE

Unless otherwise noted, the Keysight E4360 Modular Solar Array Simulator will also be referred to as “solar array simulator” and “SAS” throughout this manual.

The Keysight E4360 SAS – At a Glance

The Keysight E4360 Modular Solar Array Simulator (SAS) is a DC current source with very low output capacitance that simulates the output characteristics of a solar array. It is capable of simulating the I-V curve of a solar array under different conditions such as temperature and age. The I-V curve is programmable over the GPIB, LAN, and USB interface as well as from the front panel. The following paragraphs describe the SAS operating modes:

Fixed Mode

This is the default mode that occurs when the unit is first powered up. The I-V output has the rectangular characteristics of a standard power supply, but with excellent high speed constant current characteristics and low output capacitance. Fixed mode is convenient when, in certain applications, the I-V curve is not needed, and when calibrating or verifying the instrument.

SAS Mode

In SAS mode, the output has an I-V characteristic that follows an exponential model of a solar array. The exponential model is specified using four model parameters: open circuit voltage (V_{oc}), short circuit current (I_{sc}), current at the approximate maximum power point on the curve (I_{mp}), and voltage at the approximate maximum power point on the curve (V_{mp}). When operating in immediate mode, the model characteristic is changed by modifying any of the V_{oc} , I_{sc} , I_{mp} , or V_{mp} settings. When operating in list mode, the four model parameters are stored in a curve list, and the exponential model changes when a trigger signal steps the list through its programmed curves. Lists are best used when the application requires multiple output channels to be synchronized.

Table Mode

The SAS provides a Table mode for a fast and accurate I-V simulation of solar arrays. In this mode, a table of I-V points specifies the curve. The SAS provides up to 60 tables with a maximum of 4,000 I-V points per table. Tables are easily stored and recalled. A portion of table storage is allocated in non-volatile memory, which may contain up to 30 tables with a maximum of 4,000 I-V points per table. These are retained when power is turned off. In Table mode, current and voltage offsets can be applied to the selected table to simulate a change in the operating conditions of the solar array.

Output Features

Low output capacitance	Low output capacitance allows faster output response time in constant current operation.
Fast up/down voltage programming	Less than 8 millisecond response time from 10% to 90% of the output rating.
Fast I-V curve change	Fast I-V curve change in both SAS mode and Table mode.
Fast switching recovery	Switching recovery is less than 5 microseconds.
Programmable voltage and current	Full programming capability is provided for the entire range of output voltage and current. Outputs can operate as either constant voltage (CV) or constant current (CC) sources.
Output paralleling for higher power	Two outputs can be configured to act as a single output with higher current and power capability. Up to four outputs can be paralleled.
Remote voltage sensing	Two remote sensing terminals are provided for each output. See chapter 2 for details.
Voltage and current measurements	All output modules can measure their own output voltage and current.
Voltage, current, and temperature protection	Each output has over-voltage, over-current, over-temperature, and over-switching protection. Over-voltage and over-current protection are programmable. When activated, the protection circuits cause the voltage to go to zero, the output to be disabled, and the protection status to be reported.

System Features

SCPI language	The instrument is compatible with the Standard Commands for Programmable Instruments (SCPI).
Fast command processing	Command processing time of less than 1 millisecond per command.
Choice of three interfaces	GPIB (IEEE-488), LAN, and USB remote programming interfaces are built in.
Front panel I/O setup	Menus let you set up GPIB and LAN parameters from the front panel. See chapter 3 for details.
Built-in Web server	A built-in Web server lets you control the instrument directly from an internet browser on your computer. See chapter 3 for details.
Internal table memory	Up to 30 tables can be stored in volatile memory; up to 30 in non-volatile memory
Real-time status information	The front panel indicates the status of each output. It also indicates when a protection shut-down has occurred.
Module identification	Each module has identifying data stored in non-volatile memory. Information includes model number, serial number, and options. This information can be displayed on the front panel.
Fan speed control	Fan speed control circuits minimize acoustic noise.

1 General Information

The Front Panel - At a Glance

Display

Turns off after 1 hour of inactivity.
Press any key to restore the display.

Navigation keys

Move the cursor to a menu item.
Select the highlighted menu item.

Output keys

Turn the outputs on or off.
Enter voltage or current.

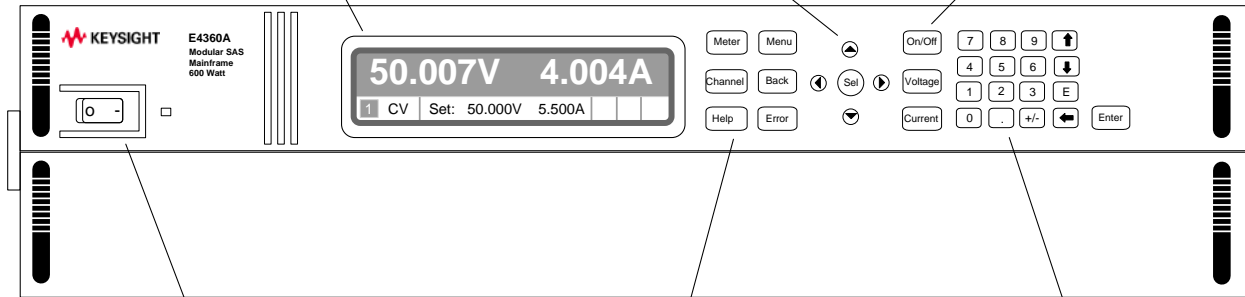

On/Off switch and LED

LED indicates power is on.
Green = normal operation.
Amber = display is screen-saver mode.

System keys

Toggle between single-channel and multiple-channel view.
Access front panel command menu.
Select an output channel to control.

Numeric entry keys

Enter values.
Increment or decrement values.

Keysight E4360J01

Display

Turns off after 1 hour of inactivity.
Press any key to restore the display.

Navigation keys

Move the cursor to a menu item.
Select the highlighted menu item.

Output keys

Turn the outputs on or off.
Enter voltage or current.

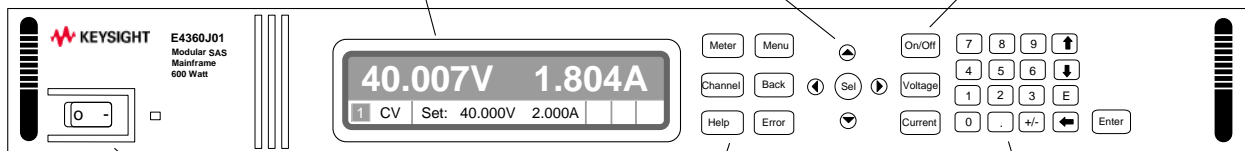

On/Off switch and LED

LED indicates power is on.
Green = normal operation.
Amber = display is screen-saver mode.

System keys

Toggle between single-channel and multiple-channel view.
Access front panel command menu.
Select an output channel to control.

Numeric entry keys

Enter values.
Arrow keys increment or decrement voltage and current settings.

The Rear Panel – At a Glance

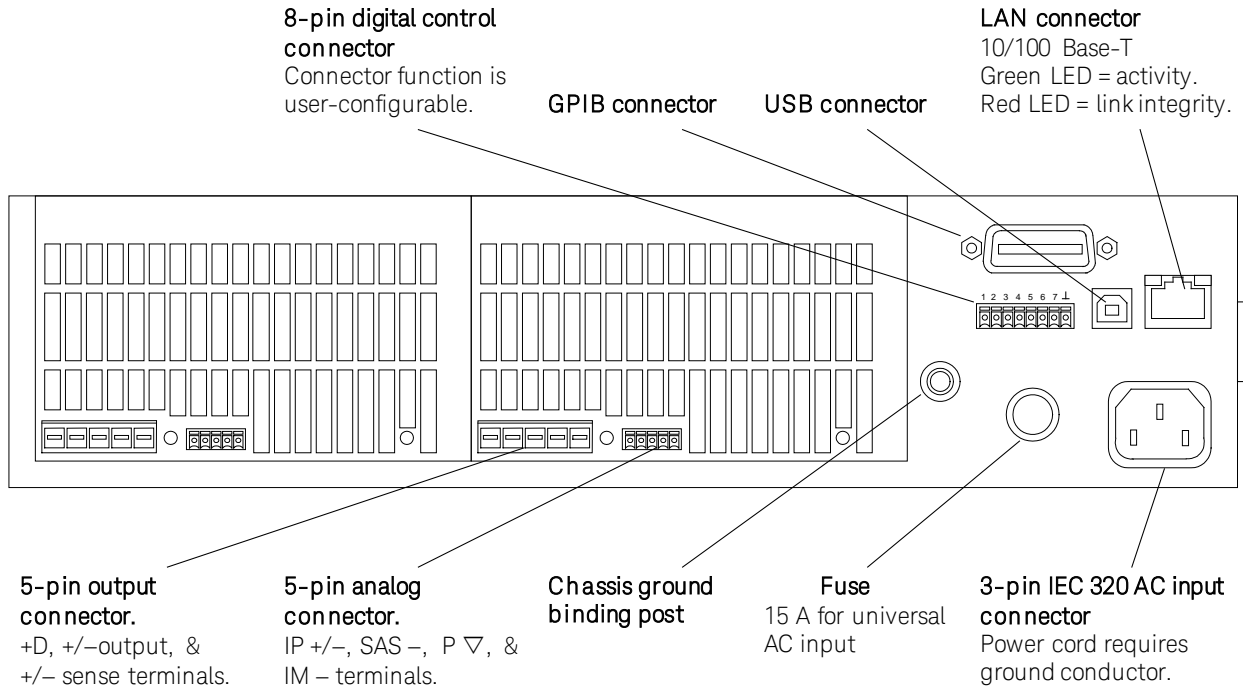

WARNING SHOCK HAZARD The power cord provides a chassis ground through a third conductor. Be certain that your power outlet is of the three-conductor type with the correct pin connected to earth ground.

Keysight E4360J01

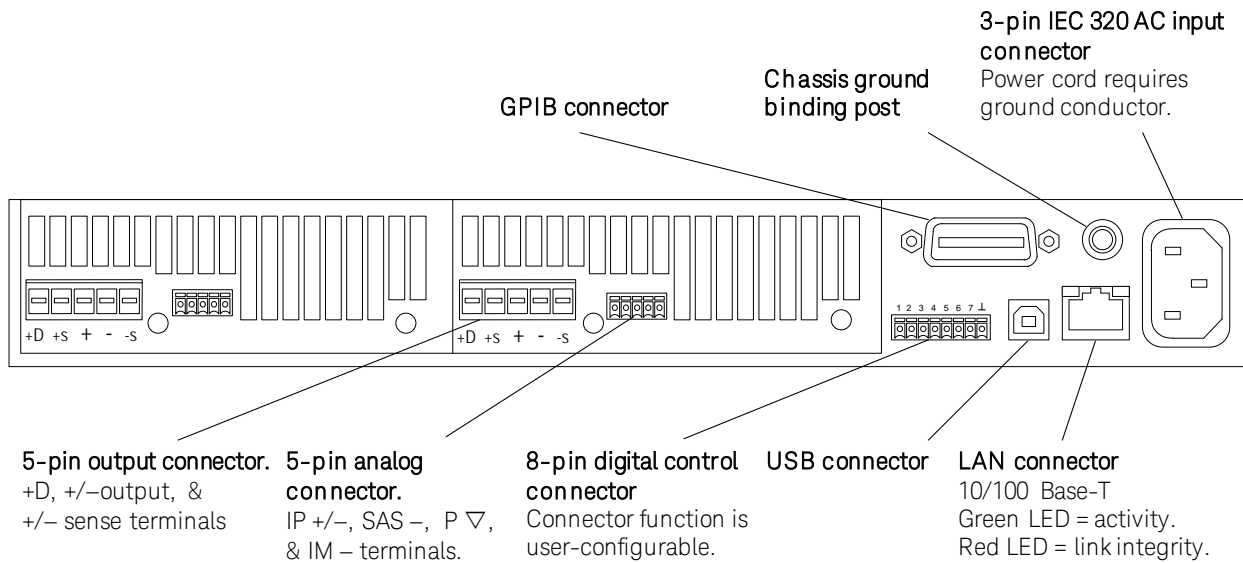

Front Panel Display – At a Glance

Single-channel view

Press the **Meter** key to toggle between views

Voltage measurement		Current measurement	
52.5230V		0.1789A	
1	CV	Set: 52.523V	2.000A
Operating status (CV = constant voltage)		Voltage and current settings	Interface status (IO = activity on interface)

Multiple-channel view

Press the **Meter** key to toggle between views

Voltage and Current measurements			
52.523V 0.179A		10.234V 2.391A	
Set: 52.523V 2.0000A		Set: 10.234V 3.0000A	
1	CV	2	CV

The highlighted channel is the active channel

Grouped-channel view

Channels 1 and 2 are connected in parallel and have been configured or grouped to act as a single, higher-power channel

Refer to chapter 4, under “System-Related Operations” for more information

52.523V 0.179A		
Set: 52.523V 2.0000A		
1	CV	GROUPED

Grouped channel are addressed using channel 1.

Operating status indicators

OFF = the output is off
 CV = the output is in constant voltage mode
 CC = the output is in constant current mode
 OV = the output is disabled by the over-voltage protection
 OC = the output is disabled by the over-current protection
 PF = the output is disabled by a power-fail condition
 OT = the over-temperature protection has tripped
 OS = the over-switching protection has tripped
 INH = the output is disabled by an external inhibit signal
 UNR = the output is unregulated
 PROT = the output is disabled by a condition from a coupled channel*
 * see Appendix B

Interface status indicators

All = the On/Off key is active on all channels
 Err = an error has occurred (press Error key to display error message)
 Lan = the LAN is connected and has been configured
 IO = there is activity on one of the remote interfaces

Front Panel Keys – At a Glance

System keys

Meter

Menu

Meter returns the display to metering mode.

Menu accesses the command menu.

Channel

Back

Channel selects or highlights a channel to control.

Back backs out of a menu without activating any changes.

Help

Error

Help accesses information about the displayed menu control.

Error displays any error messages in the error queue.

Navigation keys



The Arrow keys let you move around in the command menus.



The Select key lets you make a selection in the command menus.

It also lets you enter edit mode for numeric parameters.



Output keys

On/Off

On/Off controls the selected output (or all outputs when **All** is lit).

This key is only active in Single- channel or Multiple- channel view.

Voltage

Voltage lets you change the voltage setting of the selected channel.

This key is active in Fixed mode only.

Current

Current lets you change the current setting of the selected channel.

This key is active in Fixed mode only.

Number keys

7 8 9 ↑

4 5 6 ↓

1 2 3 E

0 . +/- ←

Enter

The 0 through 9 keys enter numbers from 0 to 9.

The (.) key enters a decimal point.

The +/- key is only used to enter a minus sign.

The E key enters an exponent. Add the value to the right of the E.

The ← backspace key deletes digits as it backspaces over them.

The ↑ ↓ arrow keys increment or decrement the value in certain fields.

They are also used to select letters in alphabetic entry fields.

The Enter key enters a value. If you exit a field without pressing the

Enter key, the value is ignored.

Front Panel Menu Reference

NOTE

Menu commands that are grayed-out are password protected.

Menu Command			Control Description		
Output	Fixed	Voltage	Programs the output voltage in Fixed mode		
		Current	Programs the output current in Fixed mode		
	SAS	Curve	Programs the SAS curve parameters (Vmp, Voc, Imp, Isc).		
		Source	Selects the source of the curve parameters (Immediate, List)		
	Table	Select table	Programs the SAS curve parameters from the selected table.		
	Mode		Selects the operating mode (Fixed, SAS, Table).		
	Resolution		Specifies curve resolution in SAS & Table mode: Low or High.		
	Couple		Couples output channels for output on/off synchronization.		
Acquisition	Control		Displays trigger delay, source, and state. Aborts measurements.		
Transient	List	Pace	Specifies Dwell or Trigger paced list.		
		Count	Specifies number of list repetitions, or specifies continuous list.		
		Terminate	Specifies list settings when the list terminates.		
		Config	Configures a list of Vmp, Voc, Imp, Isc, and Dwell signals.		
		Reset	Aborts the list and resets all list parameters.		
	TrigSource	Specify the trigger source: Bus, Pin 1-7, Tran or Dwell output.			
Control		Initiates, triggers, or aborts a transient. Displays trigger state.			
Protect	OVP		Configures over-voltage protection function.		
	OCP		Configures over-current protection function.		
	SoftLimits	Voltage	Specifies the high limit for the output voltage setting		
		Current	Specifies the high limit for the output current setting		
	Inhibit		Configures the external inhibit signal: Off, Latching.		
	Coupling		Disables ALL output channels when a protection fault occurs.		
Clear		Clears output protection. Displays output state.			
System	IO	LAN	ActiveSettings	Displays the LAN interface settings that are presently active.	
			Config	IP	Configures the IP addressing of the instrument.
				Name	Configures the Dynamic DNS and NetBIOS naming service.
				Domain	Configures the Domain Name.
				DNS	Configures the DNS server.
				TCP	Configures the TCP keepalive function.
				Reset	Resets the LAN interface settings to the factory-shipped state.
			USB	Status	Displays status, speed, packets received, and packets sent.
		Identification		USB connect string - the instrument's unique USB identifier.	
		GPIB		Selects the GPIB address.	
		DigPort	Pin1	Function	Specifies pin function: DigIn, DigIO, FaultOut
				Polarity	Specifies pin polarity: Positive, Negative
		Pin2	Function	Specifies pin function: DigIn, DigIO,	
	Polarity		Specifies pin polarity: Positive, Negative		

Menu Command				Control Description	
System	IO	DigPort	Pin3	Function Polarity Trig Out	Specifies pin function: DigIn, DigIO, TrigIn, TrigOut, InhibitIn. Specifies pin polarity: Positive, Negative Specifies the output trigger source. Acq, Tran, Dwel, Dlog
			Pin4	Function Polarity Trig Out	Specifies pin function: DigIn, DigIO, TrigIn, TrigOut, OnC, OffC. Specifies pin polarity: Positive, Negative Specifies the output trigger source. Acq, Tran, Dwel, Dlog
			Pin5	Function Polarity Trig Out	Specifies pin function: DigIn, DigIO, TrigIn, TrigOut, OnC, OffC. Specifies pin polarity: Positive, Negative Specifies the output trigger source. Acq, Tran, Dwel, Dlog
			Pin6	Function Polarity Trig Out	Specifies pin function: DigIn, DigIO, TrigIn, TrigOut, OnC, OffC. Specifies pin polarity: Positive, Negative Specifies the output trigger source. Acq, Tran, Dwel, Dlog
			Pin7	Function Polarity Trig Out	Specifies pin function: DigIn, DigIO, TrigIn, TrigOut, OnC, OffC. Specifies pin polarity: Positive, Negative Specifies the output trigger source. Acq, Tran, Dwel, Dlog
			Data		Sends/reads data from the digital I/O port
			States	Reset	
SaveRecall				Saves or recalls an instrument state.	
PowerOn				Selects the power-on state: *RST, RCL0.	
Groups	Groups			Defines groups of output channels that are paralleled.	
	Parallel			Defines the parallel connections: Direct or Auto-parallel.	
	Programming			Defines the parallel control: Internal or External via analog port.	
Preferences	Display	Contrast		Configures the display contrast.	
		Saver		Configures the screen saver and wake-on I/O timer.	
		View		Selects 1-channel or 4-channel view at turn-on	
	Keys		Enables/disables key clicks and configures the On/Off key.		
	Lock		Locks front panel keys. Enter a password to unlock the keys.		
Admin	Login/Logout			Enter a password to access the admin functions.	
	Cal	Function	Voltage	P1 Enters measured data for the first calibration point. P2 Enters measured data for the second calibration point.	
			Current	P1 Enters measured data for the first calibration point. P2 Enters measured data for the second calibration point.	
		OVP	Calibrates the over-voltage protection.		
		OCP	Calibrates the over-current protection.		
		Date	Saves the calibration date for each channel.		
	Save	Saves the calibration data.			
	LAN		Enables/disables the LAN interface and the built-in Web server.		
	USB		Enables/disables the USB interface.		
	Nvram		Resets all non-volatile RAM settings to their factory defaults.		
Password		Changes the password for the admin functions.			
Memory	Initialize		Initializes the table memory to the factory defaults.		
	Erase		Erases and sanitizes the instrument's table memory		
About	Frame			Displays model, serial number, and firmware revisions.	
	Module			Displays model, serial number, options, voltage, current, power.	

2

Installation



General Information.....	20
Inspecting the Unit.....	21
Installing the Unit.....	21
AC Line Connection.....	26
Rear Panel Connectors.....	26
Load Connections.....	28
Remote Voltage Sensing.....	31
Connecting Outputs in Parallel	33
Connecting Outputs in Series.....	37
Analog Current Control	38

This chapter describes how to install your SAS. It discusses rack mounting and line cord connections.

This chapter also discusses how to connect your load to the output terminals. It discusses what you need to know about wire sizes and how to compensate for voltage drops in the load leads. It describes various loads configurations and how to connect the output terminals in series and parallel.

Before installing the instrument, check the list under “Items Supplied” and verify that you have received these items with your instrument. If anything is missing, please contact your nearest Keysight Sales and Support Office.

General Information

Models

Model	Description
E4360A	SAS mainframe – without output modules
E4361A	65 V, 8.5 A, 510 W module
E4362A	130 V, 5 A, 600 W module
E4367A	E4360A + 2 – E4361A
E4368A	E4360A + 2 – E4362A
E4369A	Filler module – required if only one output module is installed in a mainframe

Items Supplied

Item	Description	Part Number
Shipped with mainframe		
Power Cord	A power cord suitable for your location. Shipped with the mainframe. Caution: The E4360A SAS mainframe cannot use a standard power cord. The supplied power cords have heavier gauge wire.	Call your local Keysight Sales and Support Office
Line Fuse	A 15 A / 250 VAC line fuse for the universal AC input	Keysight 2110-0054
Digital Connector	One 8-pin connector for connecting signal lines to the digital port. Shipped with the mainframe. Described in appendix B.	Keysight 1253-6408 Phoenix Contact MC 1,5/8-ST-3,5
Automation-Ready CD-ROM	Contains Keysight IO Libraries Suite. Shipped with mainframe.	Keysight E2094N
Shipped with output modules		
20 A Output Connector	One 20A, 5-pin connector for connecting power and sense leads. Described in chapter 2. Also available as a kit with sense jumpers included.	Keysight 0360-3039 Phoenix Contact PC 4/5-ST-7,62 Keysight Kit 5185-8878
Analog Connector	One 5-pin connector plug for making analog connections to the output modules. Described in chapter 2.	Keysight 1253-7683 Phoenix Contact MC 1,5/5-ST-3,5
Sense Jumpers	Two sense jumpers for local sensing at the output connector.	Keysight 0360-2935 Phoenix Contact 3118151
Module Calibration Certificate	A certificate of calibration referenced to the serial number.	N/A

Options

Option	Description
E4360J01	1U SAS mainframe
E4360A-908	Rack Mount Kit. For mounting in a 19-inch EIA rack cabinet. Available as part number E4360-60009.
E4360A-FLR	Filler module. For mainframes with only one output module. Also available as part number 5002-2881 for 2U mainframes, and 5003-2526 for 1U mainframes..
Output module options	
E4361A-J01	58 V, 9.3 A, 497.6 W module
E4361A-J02	75 V, 8 A, 553.6 W module
E4361A-J03	85 V, 7 A, 549.2 W module
E4361A-J11	40 V, 2 A, 73.8 W module
E4362A-J01	117 V, 5.5 A, 594 W module
E4362A-J02	120 V, 5.4 A, 594 W module
E4362A-J03	108 V, 6 A, 600 W module
E4362A-J04	170 V, 3.8 A, 596.6 W module
E4362A-J05	95 V, 6.3 A, 552.5 W module
E4362A-J06	180 V, 3.4 A, 564.9 W module
E4362A-J18	150 V, 4 A, 560 W module
E4362A-J21	114 V, 6.75 A, 708.8 W module

Inspecting the Unit

When you receive your Keysight E4360 SAS, inspect it for any obvious damage that may have occurred during shipment. If there is damage, notify the shipping carrier and the nearest Keysight Sales and Support Office immediately. Refer to www.keysight.com/find/assist.

Until you have checked out the instrument, save the shipping carton and packing materials in case the unit has to be returned.

Installing the Unit



Safety Considerations

The SAS is a Safety Class 1 instrument, which means it has a protective earth terminal. That terminal must be connected to earth ground through a power source equipped with a ground receptacle. Refer to the Safety Summary page at the beginning of this guide for general safety information. Before installation or operation, check the SAS and review this guide for safety warnings and instructions. Safety warnings for specific procedures are located at appropriate places in the guide.

Environment

WARNING Do not operate the instrument in the presence of flammable gasses or fumes

The environmental conditions, dimensions, and an outline diagram of your instrument are provided in Appendix A. Basically, the instrument should only be operated indoors in a controlled environment.

Fans cool the unit by drawing air through the sides and exhausting it out the side and back. The installation location must allow sufficient space at the sides and back of the unit for adequate air circulation. For bench use, 2 inches along the sides and 4 inches in the back are recommended. Note that the unit operates with a derated output current at temperatures above 40° C.

Cleaning

WARNING SHOCK HAZARD To prevent electric shock, unplug the unit before cleaning.

Use a dry cloth or one slightly dampened with water to clean the external case parts. Do not attempt to clean internally.

Channel Number

The channel number of an output module is determined by the location of that module in the mainframe. When viewed from the rear, the module next to the GPIB connector is always channel one. The module next to channel one is always channel two.

If there is only one module, it must be installed next to the GPIB connector with a filler module installed in the remaining open space to ensure proper airflow for cooling.

Output modules that are paralleled and have been configured to act as a single, higher-power channel are addressed using channel number 1.

Output Module Installation

NOTE

The information in this section applies if you have purchased an SAS mainframe without the output modules installed, or if you are adding an output module to the mainframe.

CAUTION

Turn the mainframe off and disconnect its power cord before attempting any of the following procedures. Observe all standard electrostatic discharge precautions before handling electronic components.

If you are only installing a single output module, it must be installed in slot 1, otherwise the SAS will not operate. The unused slot must have a filler module installed to ensure proper cooling.

Installation tool required: T10Torx driver.

Step 1. Remove the blower cover. Remove three screws from the top of the cover and four screws on the sides. Tilt the cover up and slide it out.

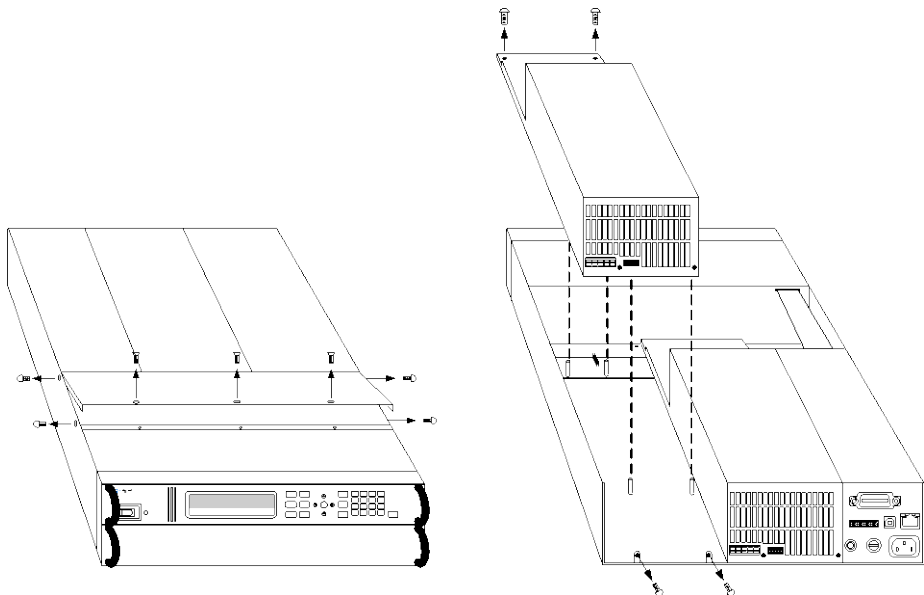

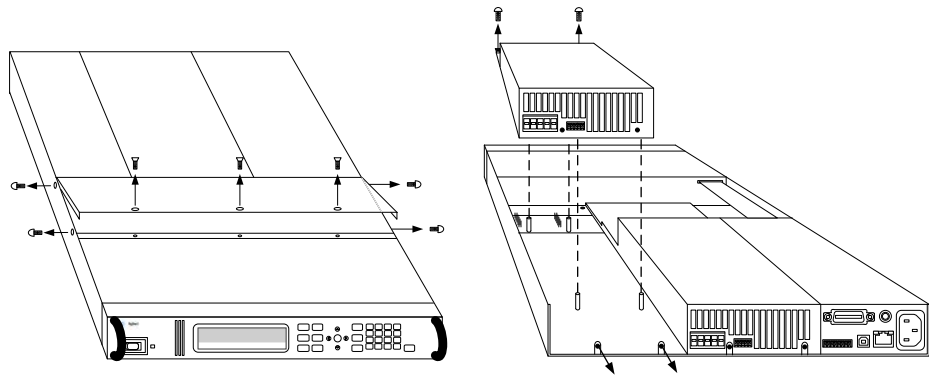

- Step 2.** If a filler module is installed in the mainframe, first remove the filler module. Remove the two fastening screws at either end of the module.
- Step 3.** To install an output module, align the module over the alignment pins, and push it down onto the mainframe connector.
- Step 4.** Fasten the output module or filler module to the mainframe. Use the screws provided with the module and install them at both ends.
- Step 5.** Replace the blower cover when finished. Be careful not to bend the spring clips on the edge of the cover when sliding it under the lip of the output modules.

Rack Mounting

CAUTION

You cannot use standard support rails for rack mounting your SAS. Standard support rails block the airflow needed for cooling. Use Rack Mount kit (Option 908) to rack mount your instrument. The Rack Mount Kit is also available by ordering p/n E4360-60009.

The SAS can be mounted in a standard 19-inch rack panel or cabinet. It is designed to fit in two rack-units (2U) of space. Model E4360J01 is designed to fit in one rack-unit (1U) of space. Do not block the air vents at the sides and rear of the unit.

Tools required: Phillips driver, T22 Torx driver, T10 Torx driver

- Step 1.** Install the clip-nuts (1) on each corner of the rack frame where your instrument will be located.
- Step 2.** Install the four front ears and the two rear extender supports on the instrument as shown in the figure. Use the M3 x 8mm screws (2a) for the front ears and for the extender supports (2b). If the standard extender supports are either too short or too long, use the longer supports (2c). Cut the supports if required (2d).
- Step 3.** Install the two rear ears on the back of the instrument rack as shown in the figure. Use the plain 10-32 screws (3) to install the rear ears.
- Step 4.** Slide the instrument into the rack, making sure that the rear extender supports are aligned inside the rear ears (4).

2 Installation

Step 5. Attach the front ears to the front of the instrument rack using the dress 10-32 screws (5) provided.

Step 6. This is optional. Insert a plain 10-32 screw (6) through the slot of the rear ear and extender support. Attach it with a clip-nut. Note that this will prevent the unit from being slid out of the front of the rack.

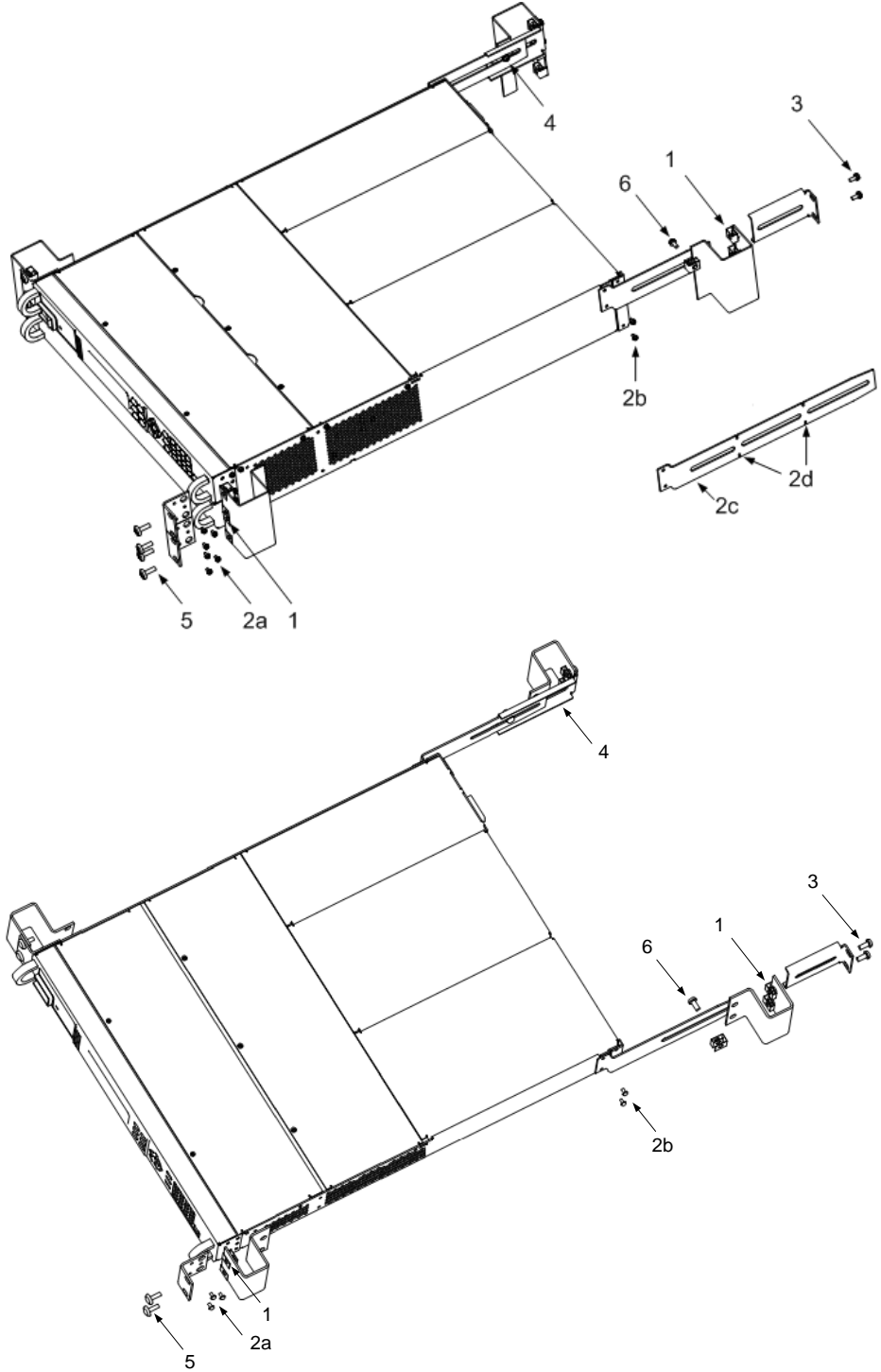

Bench Installation

CAUTION

Do not block the air intake and exhaust at the sides, or the exhaust at the rear of the unit. Refer to the outline diagram in Appendix A.

Minimum clearances for bench operation are 2 inches (51 mm) along the sides and back.

400 Hz Operation

Redundant Ground Requirement

At 400 Hz AC input operation, the leakage current of the unit exceeds 3.5 mA. This requires the installation of a permanent, redundant ground from the instrument chassis to earth ground. This ensures that ground will always be connected and that any leakage current will be diverted to ground. Refer to the Service Guide for installation instructions.

Power Factor

Refer to Appendix A for power factor statistics at 400 Hz operation.

AC Line Connection

WARNING

FIRE HAZARD Use only the power cord that was supplied with your instrument. Using other types of power cords may cause overheating of the power cord, resulting in fire.

SHOCK HAZARD The power cord provides a chassis ground through a third conductor. Be certain that your power outlet is of the three-conductor type with the correct pin connected to earth ground.

Connect the power cord to the IEC 320 connector on the rear of the unit. If the wrong power cord was shipped with your unit, contact your nearest Keysight Sales and Support Office.

Note that the detachable power cord may be used as an emergency disconnecting device. Removing the power cord will disconnect AC input power to the unit.

The AC input on the back of your unit is a universal AC input. It accepts nominal line voltages at 100, 120, 220, 230, and 240 VAC. The frequency can be 50, 60, or 400 Hz.

NOTE

100-120 VAC input current restriction - AC mains circuits rated at nominal 100-120 VAC cannot supply enough current to power the SAS when **two** output modules are installed. In this case, internal circuits will limit the output current of the modules to one-half of their rating. As a result of this current limiting, the current drawn from the AC mains will be < 15 A, so that standard 100-120 VAC AC mains circuits will not be overloaded. For a **single** installed module, full output current will be available at nominal 100-120 VAC.

This restriction does not apply to mainframe Model E4360J01.

The line fuse is located in a fuse holder on the rear panel. The rear panel label shows the fuse value used in the unit. See "Items Supplied" in this chapter for replacement fuse information.

Rear Panel Connections

Output Connector

This connector, which is on the rear panel, is for load and sense connections. The connector accepts wires sizes from AWG 8 to AWG 24. Connect the load wires to the + and - terminals. Connect the sense wires to the +s and -s terminals. Sense jumpers are provided for local sensing. An internal, reverse-current blocking diode in series with the + output is available at the +D terminal.

Securely fasten all wires by tightening the screw terminals. Insert the connector plug into the back of the unit.

It is good engineering practice to twist the sense wire pairs as well as the load wire pairs.

- 1 Insert wires
- 2 Tighten screws
- +D Diode terminal adds diode in series with + output
- +s + sense connection
- + + output terminal
- - output terminal
- s - sense connections

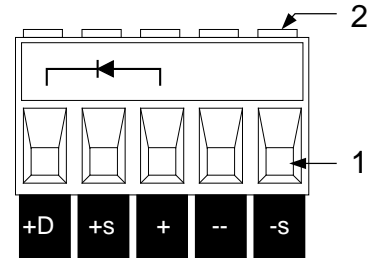

The output connector was shipped with two local sense jumpers. With these sense jumpers installed (from +s to +; from -s to -), the unit senses and regulates its output voltage directly at the output terminals. This causes the voltage at the load to be somewhat lower due to the voltage drop in the load leads. In applications where voltage regulation at the load is critical, remote sensing may be required as explained later in this chapter.

CAUTION The positive output terminal should NOT be connected to ground in applications where the output voltage is repeatedly and rapidly changing as is the case in a *series or shunt regulator application*. This can result in overheating and damaging the resistors of internal RC networks that are connected to ground.

Analog Connector

WARNING The P common terminal on the analog connector is a low-noise signal ground for convenience only. IT IS NOT A SAFETY GROUND!

This connector, which is on the rear panel, is for connecting external current monitors and external current programming sources. The connector accepts wires sizes from AWG 16 to AWG 28.

It is good engineering practice to twist or shield all signal wires to and from the analog connector. To minimize spurious operation, make sure that all analog wiring does not exceed 3 meters in length.

- 1 Insert wires
- 2 Tighten screws
- IP+ Differential current programming input (+)
- IP- Differential current programming input (-)
- SAS- Auto-parallel connection (SAS mode only)
- P▽ Common for IM- and SAS- signals
- IM- Current monitor output (referenced to P▽)

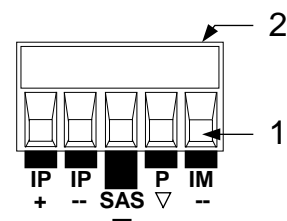

NOTE If you are not using the Analog Connector, it is recommended that you connect (or jumper) the +IP and -IP terminals together to reduce EMC susceptibility.

Digital Connector

This connector, which is on the rear panel, is for connecting digital I/O, fault/inhibit, trigger, or output couple signals. The connector accepts wires sizes from AWG 16 to AWG 28. Refer to Appendix B for more information about digital connections.

It is good engineering practice to twist or shield all signal wires to and from the digital connector.

- 1 Insert wires
- 2 Tighten screws
3. Signal common (pin 8)
4. Input/output signals (pins 1-7)

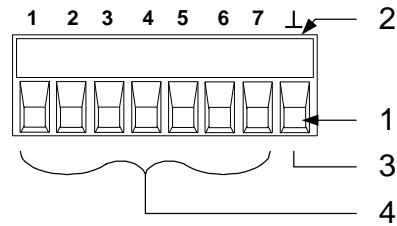

WARNING The signal common terminal on the digital connector is a low-noise signal ground for convenience only. IT IS NOT A SAFETY GROUND!

Load Connections

Wire Selection

WARNING Fire Hazard. Select a wire size large enough to carry short-circuit current without overheating. To satisfy safety requirements, load wires must be large enough not to overheat when carrying the maximum short-circuit current of the unit. If there is more than one load, then any pair of load wires must be capable of safely carrying the full-rated current of the output.

The following table lists the characteristics of some common American Wire Gauge (AWG) sizes of copper wire >

AWG No.	Ampacity (in free air)	Resistance (at 20 deg. C)	
		Ω/m	Ω/ft
20	8.33	0.0345	0.01054
18	15.4	0.0217	0.00663
16	19.4	0.0137	0.00417
14	31.2	0.0086	0.00262
12	40	0.0054	0.00165

Multiple Outputs

If you are using local sensing and are connecting multiple outputs to one load, connect each output to the load using separate connecting wires. Keep each pair of wires as short as possible and twist or bundle them to reduce lead inductance and noise pickup.

If load considerations require the use of distribution terminals that are located away from the instrument, connect the output terminals to the remote distribution terminals by a pair of twisted or bundled wires. Connect each output to the distribution terminals separately. Remote voltage sensing is recommended under these circumstances. Sense either at the remote distribution terminals or, if one load is more sensitive than the others, directly at the sensitive load.

- 1 Jumpers installed for remote sensing
- 2 Twist or bundle wire pairs

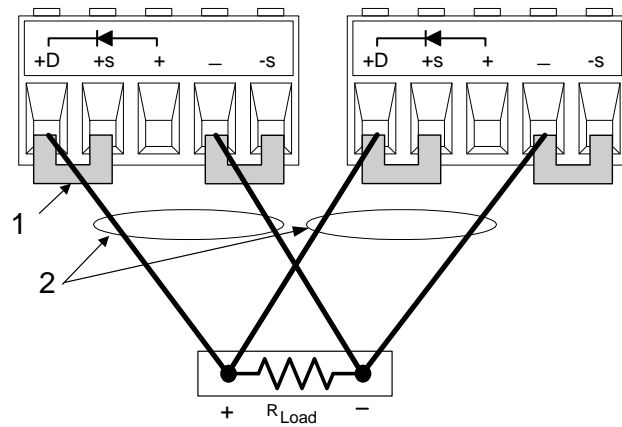

Reverse-Current Blocking Diode (+D terminal)

The SAS has a built-in reverse-current blocking diode. The cathode connects to +D; the anode connects to + out. When using this diode, connect the load to the +D terminal, not to the + output terminal.

In Fixed mode, this diode protects the instrument from reverse currents that can be generated if a paralleled output or a battery is connected to an output and its over-voltage protection trips.

Output Isolation and Grounding

CAUTION

The positive output terminal should NOT be connected to ground in applications where the output voltage is repeatedly and rapidly changing as is the case in a *series or shunt regulator application*. This can result in overheating and damaging the resistors of internal RC networks that are connected to ground.

The output terminals are isolated from earth ground. An earth ground terminal is provided on the rear panel. Either output terminal may be grounded, or an external voltage source may be connected between either output terminal and ground. However, both output terminals must be kept within ± 240 VDC of ground. An earth ground terminal is provided on the rear panel.

Capacitive Loads

In Fixed mode operation, the maximum external capacitance that may be added to the output without causing instability is 2,000 μF . This is also the maximum capacitance value that can be safely discharged by the OVP (over-voltage protection) circuit.

CAUTION

Because of its high output voltage, the Keysight E4362A output module generates high currents when discharging the load capacitor under over-voltage conditions. Excessive currents can damage the unit. The peak discharge current is limited by the sum of the external capacitor's ESR (equivalent series resistance) and the series resistance of the external circuit. For the Keysight E4362A's external capacitance limit of 2,000 μF , the total resistance must not be less than 56 milliohms. For smaller values of external capacitance, the total resistance may be derated linearly.

Inductive Loads

When operating in SAS mode, load inductance should be kept under 200 μH . For twisted pair wires or zipcord, allow approximately 0.25 μH per foot of load lead wire.

Shunt Switching Frequency

Output over-switching protects the unit against shunt-switching frequencies above 50 kHz. If you need to shunt-switch at frequencies above 50 kHz, contact your local Keysight Sales and Support Office.

Remote Voltage Sensing

Remote sensing improves the voltage regulation at the load by monitoring the voltage there instead of at the output terminals. This allows the unit to automatically compensate for the voltage drop in the load leads as well as accurately read back the voltage directly at the load. The maximum allowable load lead voltage drops are:

SAS and Table modes	$2\text{ V} + (V_{oc} - V_{mp})$.
Fixed mode	2 V

Connect the unit for remote sensing by first removing the local sense jumpers. Connect the positive side of the load to the +S connector pin and the negative side of the load to the -S connector pin. Connect the sense leads carefully so that they do not become open-circuited.

NOTE

If the sense terminals are left unconnected, the voltage at the output will increase approximately 3 to 5 % over the programmed value. Since the front panel meter measures the output voltage at the sense terminals, the voltage reading will not reflect this increase.

Any noise picked up on the sense leads will appear at the output of the SAS and may adversely affect the load voltage regulation. Be sure to twist the sense leads to minimize external noise pickup and route them parallel and close to the load leads. In noisy environments, it may be necessary to shield the sense leads. Ground the shield only at the SAS. Do not use the shield as one of the sense conductors.

- 1 Twist or shield sense wire pair
- 2 Twist or bundle load wire pair

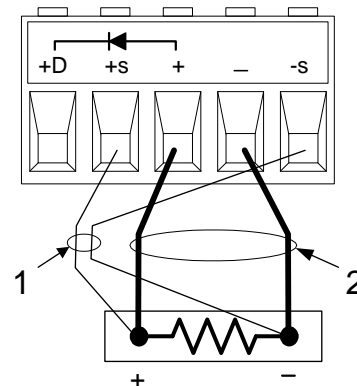

CV Regulation

The Fixed mode voltage load regulation specifications documented in the Keysight E4360 Modular Solar Array Simulator Specifications Guide apply at the output terminals of the SAS. When remote sensing, this specification must be adjusted by adding 3 mV to the voltage load regulation specification for each 1-volt change in the load leads due to a change in load current.

2 Installation

Because the sense leads are also part of the unit's feedback path, keep the resistance of the sense leads low to obtain the best performance. The additional load regulation due to resistance in the sense leads is given by the formula:

$$\text{Regulation in millivolts} = \frac{(\text{total load lead drop}) * (\text{total sense lead resistance})}{K}$$

where $K = 3$ for E4361A; 7 for E4362A

Over-voltage Protection

Because the over-voltage protection (OVP) circuit senses the voltage at the output terminals and not at the sense terminals, the voltage sensed by the OVP circuit will be **higher** than the voltage being maintained at the load when remote sensing. Therefore, you must program the OVP high enough to compensate for the expected voltage drop between the output and the load.

Output Rating

With remote sensing, any voltage dropped in the load leads causes the unit to increase the voltage at the output terminals so it can maintain the proper voltage at the load. If you attempt to operate at the full-rated output at the load, this may force the voltage at the output terminals to exceed the unit's rated output.

This will not damage the unit, but may trip the OVP circuit, which senses the voltage at the output. When operated beyond its rated output, the unit's performance specifications are not guaranteed, although typical performance may be good. If the excessive demand on the unit forces it to lose regulation, the **Unr** annunciator will indicate that the output is unregulated.

Always check that the voltage at the load when added to the voltage drop in the load leads does not exceed the voltage rating of the SAS.

Stability

In **SAS** and **Table** modes, the unit is stable with constant current, constant resistance, constant voltage, and any capacitive loads. Inductive loads should be kept less than $200\mu\text{H}$.

In **Fixed** mode, the unit is stable if the output capacitance is less than $2000\mu\text{F}$.

Connecting Outputs in Parallel

WARNING Only connect output modules in parallel that have identical model numbers and options

Output channels can be paralleled to obtain increased output current. There are two ways to implement this: direct-parallel and auto-parallel.

Parallel Method	Description	Connections
Direct-Parallel Recommended for SAS and Table modes. Provides simple, direct connections	Up to four output channels (modules) connected in parallel. Each output channel must be programmed individually to source or query its share of output current.	Parallel output terminals together. Parallel sense terminals together when remote sensing.
Auto-Parallel Recommended for Fixed mode operation. Ensures that the output current of the paralleled modules is accurately matched	Up to four output channels (modules) connected in parallel. The programmed current value is directed only to the output referred to as the “master” output. This output must be channel 1 in one of the mainframes. All other paralleled outputs, referred to as “follower” outputs, track the output current of the master output.	Parallel output terminals together. Parallel sense terminals together when remote sensing. Connect the current programming analog connector pins for auto parallel operation.

Direct-Parallel Connections

NOTE For the firmware to correctly control the paralleled output channels, you must specify that the output channels are connected in direct-parallel. Refer to chapter 4 under “Configuring Paralleled Outputs”.

Direct-Parallel in SAS and Table mode

This is the simplest way to implement parallel connections. In most cases, outputs can be connected in direct-parallel mode as shown in the following figures without any master/follower distinction, and without any wiring to the analog connectors. This is possible because of the relatively *high* output impedance of each output channel when operating in SAS and Table modes. This method also provides better current programming accuracy with paralleled outputs.

In SAS and Table mode, each output must be programmed with identical I-V curve or table data. With Lists, each output must receive the same list. The trigger signals used to change list steps must be received at the same time. Remote sensing may be employed on all outputs if desired, but in many cases will have only a minimal effect on performance due to the high output impedance of each output.

The following figure shows four outputs connected directly to the load.

2 Installation

- 1 Twist or bundle wire pair
- 2 Jumpers installed on all outputs for local sensing

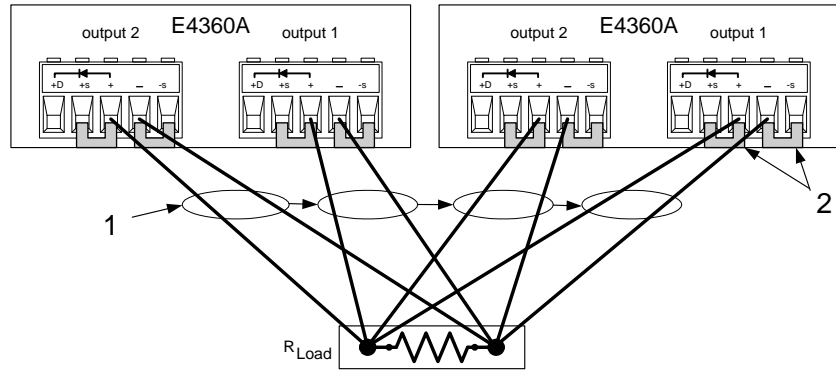

As a convenience, you can group the two channels that are paralleled in a single mainframe to make them look, from a programming point of view, like a single channel. The channel number of the resulting group will be channel 1. There is no need to send commands to the second channel. This grouping function cannot be extended beyond a single mainframe. Refer to Appendix D for more information.

You can use the +D connection if you wish to protect the output from reverse currents as well as isolate the output from the circuit when an output is shorted.

Direct-Parallel in Fixed mode

In Fixed mode, outputs can also be connected in direct-parallel as shown the previous figure. Each output must be programmed to provide its share of the output current. However, because of the relatively *low* output impedance of each output channel when operating in Fixed mode, the total output current may not be equally divided among all output channels.

If your application requires equal current sharing as well as better current programming accuracy, then you must use auto-parallel connections as described in the following section.

If remote voltage sensing is required to compensate for any voltage drop in the load leads, remove the local sense jumpers and connect the sense terminals of each output directly to the load.

You can also use the +D connection if you wish to protect the output in the event that reverse currents that exceed the output rating are generated by your application and are applied to the output terminals.

Auto-Parallel Connections

NOTE

For the firmware to correctly control the paralleled output channels, you must specify that the output channels are connected in auto-parallel, *and* which channel is configured as the master and which channels are configured as followers. Refer to chapter 4 under “Configuring Paralleled Outputs”.

Auto-Parallel in Fixed mode

Auto-parallel connections are used to ensure equal current sharing when the outputs of up to four mainframes are paralleled. In this configuration, a “master” channel provides an analog current programming signal on its “IM-” analog output pin, which programs the output current of all “follower” channels that are connected to it. However, this method requires additional analog connections to be made between the output channels and the mainframes.

The following figure illustrates Fixed mode connections. If remote sensing is required, connect the remote sense terminals of *all outputs* to the load as shown by the dashed lines in the figure. To avoid output ringing, you can either connect an output capacitor across the load as shown in (5a), or you can connect a filter across the current monitoring connections as shown in (5b). This network consists of two 200 ohm resistors in series with the current monitor lines going to the master output, and an RC paralleled across the current monitor lines. Chose only one method (5a or 5b).

- 1 Master output
- 2 Follower outputs
- 3 Twist or bundle wire pair
- 4 Analog connectors (one for each output)
- 5 Optional components to reduce output ringing. Select only ONE of the two methods shown: (5a or 5b).
- 6 Sense jumpers installed.
For remote sensing, remove the sense jumpers and connect sense wires (7) for ALL outputs. (Only one output is illustrated to simplify the figure.)

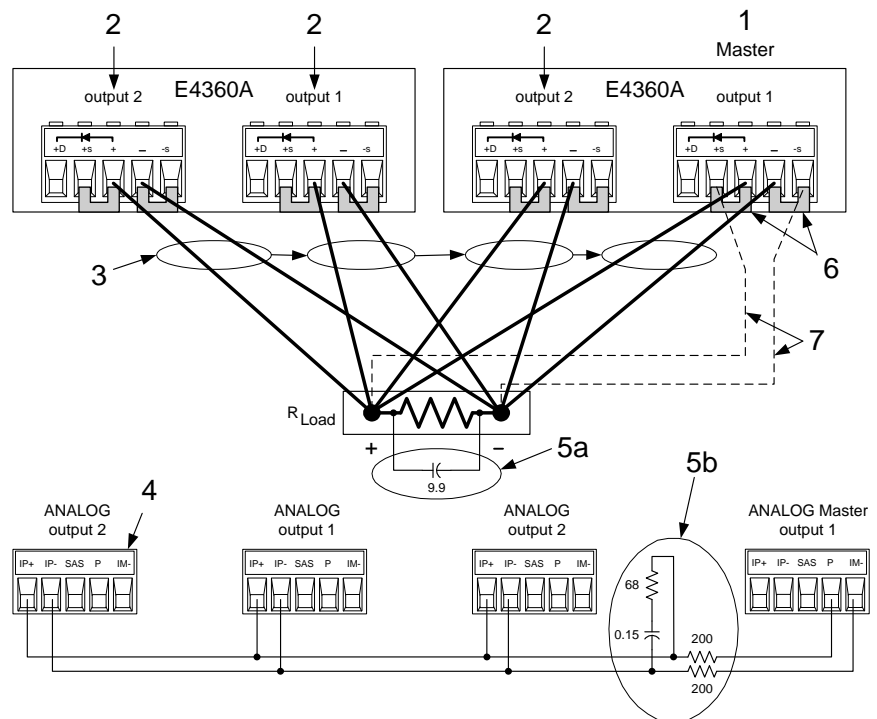

2 Installation

As shown in the following table, the capacitor values required for the two compensation methods depend on the number of follower outputs that are paralleled.

# of Follower outputs	Output capacitor (5a)	RC values (5b)
1	3.3 μF min. ($< 6\Omega$ ESR)	0.47 $\mu\text{F}/68\Omega$
2	6.6 μF min. ($< 3\Omega$ ESR)	0.1 $\mu\text{F}/68\Omega$
3	9.9 μF min. ($< 2\Omega$ ESR)	0.15 $\mu\text{F}/68\Omega$

When programming the output current, program only the master output channel with 1/nth of the desired current, where n is the number of output channels paralleled. The follower outputs will generate the same current as the master. Set the current protection of the follower outputs to the same value as the master output. Set the output voltage of the follower outputs slightly higher than the output voltage of the master output. Output status, voltage readback, and current readback must be returned individually for each output.

If the outputs are grouped in auto-parallel mode as explained in Appendix D, the master output channel must be channel 1 in one of the frames. All other output channels must be connected as followers.

Auto-Parallel in SAS and Table modes

NOTE

Auto-parallel operation is available in SAS and Table modes; however, better current programming accuracy is obtained for individual outputs in direct-parallel operation.

Auto-parallel operation in SAS and Table mode is similar to Fixed mode except that the compensation circuits shown in 5a and 5b in the previous figure are not required. Also, the SAS pin is connected on the Analog master port as shown below. Note however, because the analog control signal from the “master” is not calibrated, better current programming accuracy is obtained when output are connected in direct parallel.

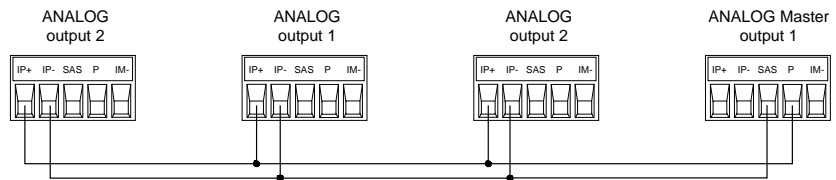

As in Fixed mode, you must specify which output channel is the master and which outputs are followers. Refer to chapter 4 under “Configuring Paralleled Outputs”. In SAS mode, the same model parameters or list step must be in effect for each output channel. If lists are used, each output must get the same list steps and triggering to cause the outputs to change steps at the same time. In Table mode, the same user-table must be activated for all outputs.

Parallel Programming Cautions

CAUTION

To avoid possible tripping of the crowbar SCR, do not turn parallel outputs off while they are operating in SAS or Table mode. Program all outputs to *Fixed* mode and set the voltage to zero before turning them off.

If a follower output experiences a shutdown condition such as over-temperature or over-current, it will not automatically shut down the master output unless you have coupled output protection on the mainframe as explained in chapter 3. Outputs on paralleled mainframes will not shut down unless you have connected and enabled the Fault/Inhibit system protection as explained in Appendix B.

Note that if the OVP circuit of an output trips, its crowbar circuit will draw current from all of the other units. Depending on the number of outputs, the additional current may damage the internal SCR of the tripped unit. Use one of the following methods to avoid problems.

1. **Program the OVP of all follower outputs to maximum.** This minimizes the chance that the follower OVP circuits will trip. Then program the OVP level of the master output to the desired protection level (below the maximum programmable level).
2. **Use the built-in protection diodes.** If you connect all outputs to the load through the series diodes (as previously illustrated) and a crowbar SCR trips, it will not draw current from other outputs.

Connecting Outputs in Series

WARNING

Only connect output modules in series that have identical model numbers and options. Floating voltages must not exceed ± 240 Vdc. No output terminal may be more than 240V from chassis ground.

CAUTION

Series connections should NOT be used in applications where the output voltage is repeatedly and rapidly changing as is the case in a *series or shunt regulator application*. This can result in overheating and damaging the resistors of internal RC networks that are connected to ground.

Each output has a reverse voltage protection diode. If a reverse voltage is applied, the unit cannot control the current conducted through this diode. To avoid damaging the unit, never connect it in such a way that a reverse voltage can force it to conduct current in excess of the unit's output current rating.

The following figure shows how outputs can be connected in series for higher voltage output. Series connections are straightforward in this case. Program each output independently. Program each output for 50% of the total output voltage. Set the current limit of each output to the maximum that the load can handle without damage.

2 Installation

If you have questions about connecting outputs in series, contact your local Keysight Sales and Support Office for details.

- 1 Jumpers installed for local sensing

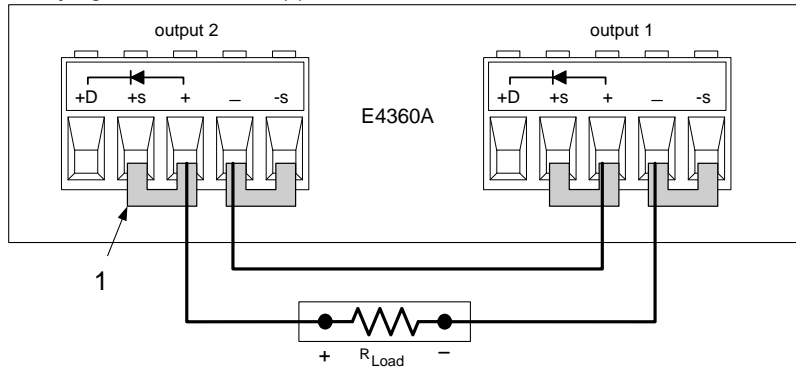

Analog Current Control

CAUTION

Analog Current Control only applies in Fixed mode operation, and can program a single output. It cannot be used to program paralleled outputs.

The setup shown below allows an external dc voltage to program the output channel's current in Fixed mode. A voltage applied to the differential current programming input programs the output current. Note that depending on the polarity of the external source, the external signal is either added to or subtracted from the programmed current setting. Output current is internally limited to a maximum of $\approx 112\%$ of the output current rating. If you want to fully control the output current through the analog input, you must first set the output current to zero. A voltage of 0 - 4 volts programs the output current from zero to the rated output current.

For proper operation, the maximum common-mode voltage between either the +IP or -IP inputs and the +OUT terminal should be kept to less than ± 18 volts. Note also that the input impedance of the analog input is $20\text{ k}\Omega$. If the output impedance of your programming source is not negligible compared to $20\text{ k}\Omega$, the programmed current will be less than expected.

Be careful of capacitive coupling from the programming inputs to other lines wired to the analog connector. Such coupling can cause output oscillations and noise. You can minimize coupling by bundling the +IP and -IP lines and keeping them separated from other wires. Twisting these lines together is also recommended.

- 1 Twist or bundle wire pairs.
- 2 A 0 to 4 volt voltage source programs from zero to the rated output current

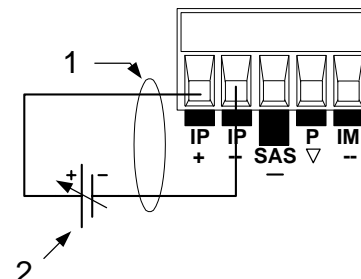

3

Getting Started

Using the Front Panel Controls	40
Using the Front Panel Menu.....	42
In Case of Trouble.....	43
Connecting to the Interfaces.....	44

This chapter describes how to get started using your SAS. It discusses turning the unit on, using the front panel controls, and navigating the front panel command menu. A map of the front panel menu structure is found in chapter 1.

This chapter also contains information on how to configure the three remote interfaces that are provided on the back of the instrument.

Using the Front Panel Controls

Turning the Unit On

After you have connected the line cord, turn the unit on with the front panel LINE switch. The front panel display will light up after a few seconds.

When the front panel display appears, you can use the front panel controls to enter voltage and current values.

Selecting an Output Channel

Channel

Press the **Channel** key to select the output channel that you wish to program.

Entering an Output Voltage Setting

Method 1 – Use the Navigation and Arrow Keys

Navigation Keys

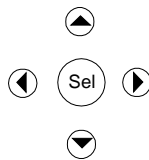

Use the left and right navigation keys to navigate to the setting that you wish to change. In the display below, channel 1's voltage setting is selected. Enter a value using the numeric keypad. Then press Enter.



Arrow Keys



You can also use the arrow keys to adjust the value up or down. When the output is on and the unit is operating in CV mode, the output voltage changes immediately. Otherwise, the value will become effective when the output is turned on.

Method 2 - Use the Voltage key to enter a value

Voltage

Use the **Voltage** key to select the voltage entry field. In the display below, channel 1's voltage setting is selected. Enter the desired setting using the numeric keypad. Then press Enter.

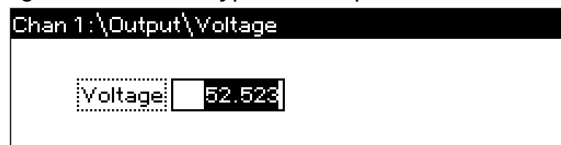

NOTE

If you make a mistake, either use the **←** backspace key to delete the number, press **Back** to back out of the menu, or press **Meter** to return to meter mode.

Entering a Current Setting

Method 1 – Use the Navigation and Arrow Keys

Navigation Keys

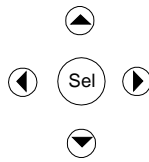

Use the left and right navigation keys to navigate to the setting that you wish to change. In the display below, channel 1's current setting is selected. Enter a value using the numeric keypad. Then press Enter.



Arrow Keys



You can also use the arrow keys to adjust the value up or down. When the output is on and the unit is operating in CC mode, the output current changes immediately. Otherwise, the value will become effective when the output is turned on.

Method 2 - Use the Current key to enter a value

Current

Use the **Current** key to select the current entry field. In the display below, channel 1's current setting is selected. Enter the desired setting using the numeric keypad. Then press Enter.

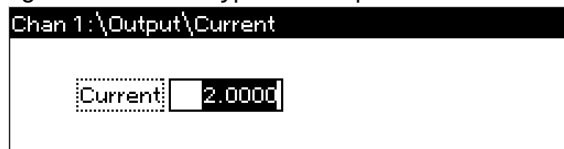

NOTE

If you make a mistake, either use the ◀ backspace key to delete the number, press **Back** to back out of the menu, or press **Meter** to return to meter mode.

Enabling the Output

Use the On/Off key to enable the output

On/Off

If a load is connected to the output, the front panel display will indicate that it is drawing current. Otherwise, the current reading will be zero. The status indicator next to the channel number indicates the output's status. In this case, the output channel is in constant voltage mode.



NOTE

For a description of the status indicators, refer to chapter 1, under "Front Panel Display – At a Glance".

Using the Front Panel Menu

The front panel command menu lets you access most of the SAS functions. The actual function controls are located at the lowest menu level. Briefly:

- Press the **Menu** key to access the command menu.
- Press the navigation keys to move across the menu commands.
- Press the center (**Sel**) key to select a command and move down to the next level in the menu.
- Press the **Help** key at the lowest menu level to display help information about the function controls.

A map of the front panel command structure is found in chapter 1. The following example shows you how to navigate the front panel command menu to program the over-voltage protection function.

Set the Over-Voltage Protection

The over-voltage protection function turns off the affected output if the output voltage reaches the programmed over-voltage limit.

Menu

Press the **Menu** key to access the front panel command menu.

The first line identifies the output channel that is being controlled followed by the menu path. Since the top level is displayed, the path is empty.

The second line indicates the commands that are available at the present menu level. In this case, the top-level menu commands are shown, with the Output command highlighted.

The third line indicates which commands are available under the Output command. Selecting the highlighted command accesses this lower level.

```
Chan 1:\
Output Acquisition Transient Protect System
Fixed, SAS, Table, Mode, Couple, Curve Resolution
```

Press the right arrow ► navigation key to traverse the menu until the Protect command is highlighted. Press the **Sel** key to select the Protect command.

```
Chan 1:\
Output Acquisition Transient Protect System
OVP, OCP, Inhibit, Coupling, Clear
```

The menu path now shows that the commands shown on the second line are located under the Protect command. The OVP command is highlighted. The third line indicates which functions are located under the OVP command. Press the **Sel** key to select the OVP command.

```
Chan 1:\Protect
OVP OCP Inhibit Coupling Clear
Overvoltage protection settings.
```

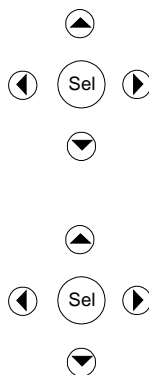

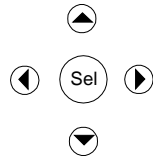

The command menu is now at the function control level. This is the lowest level in this path.

Use the navigation keys to highlight the OVP Level control as shown below. Enter the desired over-voltage level using the numeric keypad. Then press Enter.

4 4 Enter

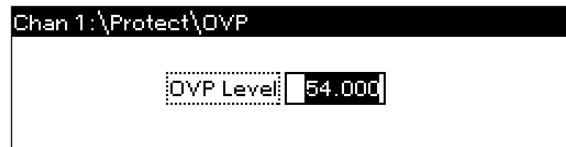

Channel

Press the **Channel** key at any time to select a different output channel. This can save time because you can directly access the OVP control of each channel without having to navigate through the menu levels.



NOTE

If you program an over-voltage protection level that is lower than the present output voltage, the over-voltage protection circuit will trip and turn the output channel off. The front panel status indicator will show OV.

Exit the Command Menu

There are two ways to exit the command menu.

Meter

Press the **Meter** key to immediately return to the metering screen. This is the quickest way to return to metering mode.

Back

Press the **Back** key to back up one level at a time in the command menu. This method may be more convenient if there are other menu commands to be given.

Detailed instructions on how to use the SAS functions and capabilities are found in the next chapter. Detailed information about the SCPI programming commands are found in the Programmer's Reference Help file on your Keysight 14360 System Control Tools CD.

In Case of Trouble

Press the Help key to obtain additional help about any function control menu level. Press the Back key to exit the Help menu.

The front panel **Err** indicator comes on operating problems occur with your instrument. Press the Error key to display the list of errors. Refer to the Keysight E4360 Service Guide for further information.

The E4360 Service Guide is included as part of the optional Manual Set (Option 0L1). An electronic copy of the E4360 Service Guide is also included on the Keysight 14360 System Control Tools CD.

Connecting to the Interfaces

CAUTION

Electrostatic discharges greater than 1 kV near the interface connectors may cause the unit to reset and require operator intervention.

The Keysight E4360A SAS supports GPIB, LAN, and USB interfaces. All three interfaces are live at power-on. The front panel IO indicator comes on whenever there is activity on the remote interfaces.

GPIB Interface

NOTE

For detailed information about GPIB interface connections, refer to the Keysight Technologies *USB/LAN/GPIB Interfaces Connectivity Guide*, located on the Automation-Ready CD that is shipped with your product.

The following steps will help you quickly get started connecting your instrument to the General Purpose Interface Bus (GPIB). The following figure illustrates a typical GPIB interface system.

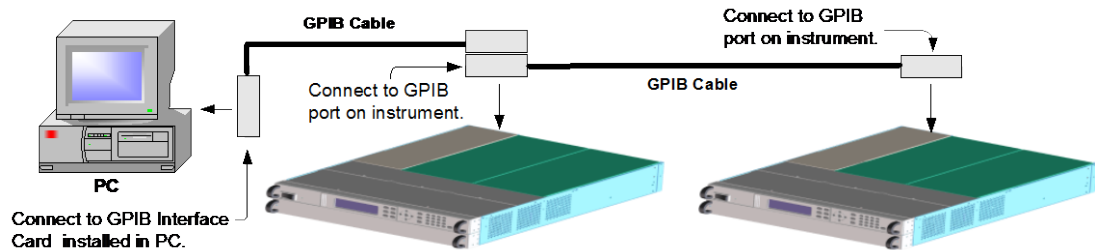

- 1 If you have not already done so, install the Keysight IO Libraries Suite from the Automation-Ready CD shipped with your product.
- 2 If you do not have a GPIB interface card installed on your computer, turn off your computer and install the GPIB card.
- 3 Connect your instrument to the GPIB interface card using a GPIB interface cable. You can connect up to 15 mainframes to one GPIB card.
- 4 Use the Connection Expert utility of the Keysight IO Libraries Suite to configure the installed GPIB interface card's parameters.
- 5 The SAS is shipped with its GPIB address set to 5. Use the front panel menu if you need to change the GPIB address.
 - a Press the Menu key, then use the navigation keys to select **System\IO\GPIB**.
 - b Use the numeric keys to enter a new value. Valid addresses are from 0 to 30. Press the Enter key to enter the value. Press the Meter key to exit the menu.
- 6 You can now use Interactive IO within the Connection Expert to communicate with your instrument, or you can program your instrument using the various programming environments.

USB Interface

NOTE

For detailed information about USB interface connections, refer to the Keysight Technologies *USB/LAN/GPIB Interfaces Connectivity Guide*, located on the Automation-Ready CD that is shipped with your product.

The following steps will help you quickly get started connecting your USB-enabled instrument to the Universal Serial Bus (USB). The following figure illustrates a typical USB interface system.

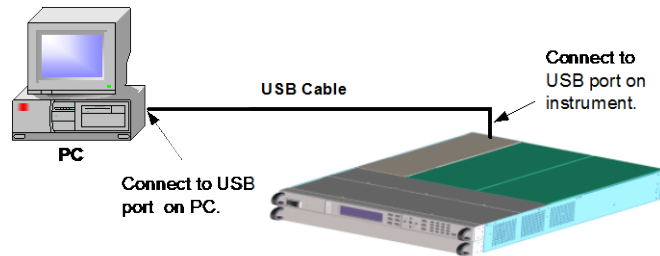

- 1 If you have not already done so, install the Keysight IO Libraries Suite from the Automation-Ready CD that is shipped with your product.
- 2 Connect your instrument to the USB port on your computer.
- 3 With the Connection Expert utility of the Keysight IO Libraries Suite running, the computer will automatically recognize the instrument. This may take several seconds. When the instrument is recognized, your computer will display the VISA alias, IDN string, and VISA address. This information is located in the USB folder.
- 4 Note that you can also view the instrument's VISA address from the front panel. Press the Menu key, then use the navigation keys to select **System\IO\USB\Identification**.
- 5 You can now use Interactive IO within the Connection Expert to communicate with your instrument, or you can program your instrument using the various programming environments.

LAN Interface

NOTE

For detailed information about LAN interface connections, refer to the Keysight Technologies *USB/LAN/GPIB Interfaces Connectivity Guide*, located on the Automation-Ready CD that is shipped with your product.

The following steps will help you quickly get started connecting and configuring your instrument on a local area network. The two types of local area networks connections that are discussed in this section are site networks and private networks.

Connecting to a Site LAN

A site LAN is a local area network in which LAN-enabled instruments and computers are connected to the network through routers, hubs, and/or switches. They are typically large, centrally-managed networks with services such as DHCP and DNS servers.

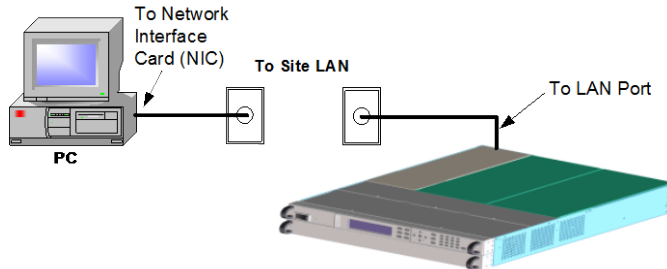

- 1 If you have not already done so, install the Keysight IO Libraries Suite from the Automation-Ready CD that is shipped with your product.
- 2 Connect the instrument to the site LAN. The factory-shipped instrument LAN settings are configured to automatically obtain an IP address from the network using a DHCP server (DHCP is set On). Note that this may take up to one minute. The DHCP server will register the instrument's hostname with the dynamic DNS server. The hostname as well as the IP address can then be used to communicate with the instrument. The front panel **lan** indicator will come on when the LAN port has been configured.

NOTE

If you need to manually configure any instrument LAN settings, refer to “Configuring the LAN Parameters” later in this chapter for information about configuring the LAN settings from the front panel of the instrument.

- 3 Use the Connection Expert utility of the Keysight IO Libraries Suite to add the E4360 SAS and verify a connection. To add the instrument, you can request the Connection Expert to discover the instrument. If the instrument cannot be found, add the instrument using the instrument's hostname or IP address.

NOTE

If this does not work, refer to the chapter on “Troubleshooting Guidelines” in the Keysight Technologies *USB/LAN/GPIB Interfaces Connectivity Guide*.

- 4 You can now use Interactive IO within the Connection Expert to communicate with your instrument, or you can program your instrument using the various programming environments. You can also use the Web browser on your computer to communicate with the instrument as described under “Using the Web Server” later in this chapter.

Connecting to a Private LAN

A private LAN is a network in which LAN-enabled instruments and computers are directly connected, and not connected to a site LAN. They are typically small, with no centrally-managed resources.

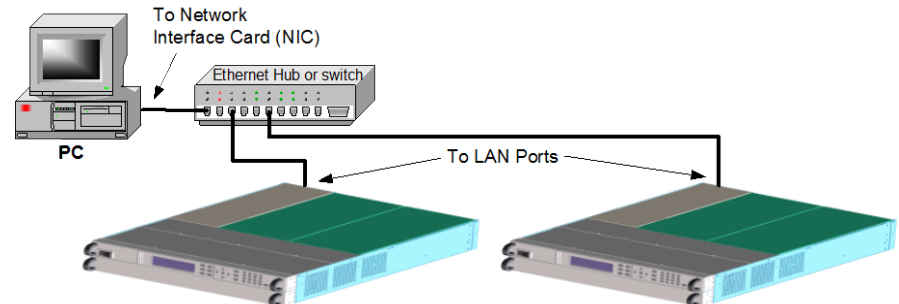

- 1 If you have not already done so, install the Keysight IO Libraries Suite from the Automation-Ready CD that is shipped with your product.
- 2 Connect the instrument to the computer using a LAN crossover cable. Alternatively, connect the computer and the instrument to a standalone hub or switch using regular LAN cables.

NOTE

Make sure your computer is configured to obtain its address from DHCP and that NetBIOS over TCP/IP is enabled. Note that if the computer had been connected to a site LAN, it may still retain previous network settings from the site LAN. Wait one minute after disconnecting it from the site LAN before connecting it to the private LAN. This allows Windows to sense that it is on a different network and restart the network configuration.

- 3 The factory-shipped instrument LAN settings are configured to automatically obtain an IP address from a site network using a DHCP server. You can leave these settings as they are. Most Keysight products and most computers will automatically choose an IP address using auto-IP if a DHCP server is not present. Each assigns itself an IP address from the block 169.254.nnn. Note that this may take up to one minute. The front panel **Lan** indicator will come on when the LAN port has been configured.

NOTE

Turning off DHCP reduces the time required to fully configure a network connection when the SAS is turned on. To manually configure the instrument LAN settings, refer to “Configuring the LAN Parameters” later in this chapter.

- 4 Use the Connection Expert utility of the Keysight IO Libraries Suite to add the E4360 SAS and verify a connection. To add the instrument, you can request the Connection Expert to discover the instrument. If the instrument cannot be found, add the instrument using the instrument’s hostname or IP address.

NOTE

If this does not work, refer to the chapter on “Troubleshooting Guidelines” in the Keysight Technologies *USB/LAN/GPIB Interfaces Connectivity Guide*.

- 5 You can now use Interactive IO within the Connection Expert to communicate with your instrument, or you can program your instrument using the various programming environments. You can also use the Web browser on your computer to communicate with the instrument as described under “Using the Web Server” later in this chapter.

LAN Parameters

Viewing the Currently Active LAN Settings

To view the currently active LAN settings, press the Menu key, then use the navigation keys to select: **System\IO\LAN\ActiveSettings**.

The currently active settings for the IP Address, Subnet Mask, and Default Gateway may be different from the front panel configuration menu settings - depending on the configuration of the network. If the settings are different, it is because the network has automatically assigned its own settings.

The SAS provides Ethernet connection monitoring. With Ethernet connection monitoring, the instrument’s LAN port is continually monitored, and automatically reconfigured when the instrument is unplugged for a minimum of 20 seconds and then reconnected to a network. The front panel **LAN** indicator will come on when the LAN port is connected and configured.

Configuring the LAN Parameters

NOTE

Reboot the SAS for any LAN parameter modifications to take effect.

The SAS’s factory-configured settings should work in most LAN environments. To manually configure these settings, press the Menu key, then use the navigation keys to select: **System\IO\LAN\Config**.

In the **Config** menu you can then select from the following items: IP, Name, Domain, DNS, TCP, and Reset. Note that the **Reset** command resets the LAN settings to the factory-shipped state.

IP

Select **IP** to configure the addressing of the instrument.

Automatic This parameter automatically configures the addressing of the instrument. When selected, the instrument will first try to obtain an IP address from a DHCP server. If a DHCP server is found, the DHCP server will assign an IP address, Subnet Mask, and Default Gateway to the instrument. If a DHCP server is unavailable, the instrument will try to obtain an IP address using AutoIP. AutoIP automatically assigns an IP address, Subnet Mask, and Default Gateway addresses on networks that do not have a DHCP server.

Manual This parameter allows you to manually configure the addressing of the instrument by entering values in the following three fields. These fields only appear when Manual is selected.

IP Address This value is the Internet Protocol (IP) address of the instrument. An IP address is required for all IP and TCP/IP communications with the instrument. An IP Address consists of 4 decimal numbers separated by periods. Each decimal number ranges from 0 through 255.

Subnet Mask This value is used to enable the instrument to determine if a client IP address is on the same local subnet. When a client IP address is on a different subnet, all packets must be sent to the Default Gateway.

Default Gateway This value is the IP Address of the default gateway that allows the instrument to communicate with systems that are not on the local subnet, as determined by the subnet mask setting. A value of 0.0.0.0 indicates that no default gateway is defined.

Name

Select **Name** to configure the hostname of the instrument. If you want to change the hostname, you should do so before you connect the instrument to the network. Otherwise, the original hostname may be cached in the network for up to several hours.

Host name This field registers the supplied name with the selected naming service. If the field is left blank, no name is registered. A hostname may contain upper and lower case letters, numbers and dashes(-). The maximum length is 15 characters. Use the navigation keys to enter an alpha character. Use the up/down navigation or arrow keys to select a letter from the alphabetic choices as you scroll through the selections. Use the number keys to enter a number.

Each SAS is shipped with a default hostname with the format: A-modelnumber-serialnumber, where *modelnumber* is the mainframe's 6-character model number (e.g. E4360A), and *serialnumber* is the last five characters of the 10-character mainframe serial number located on the label on the top of the unit (e.g. 45678 if the serial number is MY12345678). A-E4360A-45678 is an example of a hostname.

Use Dynamic DNS naming service Registers the hostname using the Dynamic DNS naming system.

Use NetBIOS naming service Registers the hostname using the RFC NetBIOS naming protocol.

Domain

Select **Domain** if your DNS server requires an instrument to register not only the hostname, but also the domain name.

Domain name Registers the Internet domain for the instrument. The Domain must start with a letter and may contain upper and lower case letters, numbers, dashes(-) and dots(.). Use the navigation keys to enter an alpha character. Use the up/down navigation or arrow keys to select a letter from the alphabetic choices as you scroll through the selections. Use the number keys to enter a number.

DNS

Select **DNS** to configure the Domain Name System (DNS) setup of the instrument. DNS is an internet service that translates domain names into IP addresses. It is also needed for the instrument to find and display its hostname assigned by the network.

- | | |
|-------------------------------------|---|
| Obtain DNS server from DHCP | Select this item to obtain the DNS server address from DHCP. You must have enabled DHCP in the IP menu. |
| Use the following DNS server | Select this item if you are not using DHCP or need to connect to a specific DNS server. |
| DNS Server | This value is the address of the DNS server. It is used if you are not using DHCP or if you need to connect to a specific DNS server. |

NOTE

For improved performance when connected to an isolated subnet, select **Use the following DNS server**. However, leave the **DNS server** address field blank.

TCP

Select **TCP** to configure the TCP keepalive settings of the instrument.

- | | |
|------------------------------|---|
| Enable TCP Keepalive | Check the Enable box to enable the TCP keepalive function. The instrument uses the TCP keepalive timer to determine if a client is still reachable. If there has been no activity on the connection after the specified time, the instrument will send keepalive probes to the client to determine if it is still alive. If not, the connection will be marked as down or "dropped." The instrument will release any resources that were allocated to that client. |
| TCP keepalive timeout | This is the delay in seconds before TCP keepalive probes will be sent to the client. It is recommended that the largest value be used that still meets the application's need for unreachable client detection. Smaller keepalive time-out values will generate more keepalive probes (network traffic), using more of the available network bandwidth. Allowed values: 720 - 99999 seconds. |

Reset

Resets the LAN settings to the factory-shipped state. These settings are listed at the end of chapter 4.

LAN Communication

The Keysight IO Libraries Suite along with instrument drivers for specific programming environments can be used to communicate with your SAS. You can also communicate with your SAS using its built-in Web server, the Telnet utility, or sockets. These latter methods are a convenient way to communicate with the SAS without using I/O libraries or drivers. In all cases, you must first establish a LAN connection from your computer to the SAS as previously discussed.

Using the Web Server

Your SAS has a built-in Web server that lets you control it directly from an internet browser on your computer. With the Web server, you can access the front panel control functions including the LAN configuration parameters. Up to **two** simultaneous connections are allowed. With additional connections, performance will be reduced.

NOTE

The built-in Web server only operates over the LAN interface. It requires Internet Explorer 5+ or Netscape 6.2+ or Firefox2+. You also need the Java (Sun) plug-in. This is included in the Java Runtime Environment. Refer to Sun Microsystem's website. If you are using Internet Explorer 7, the tab functionality does not work with multiple connections. Open a separate browser window for each connection.

The Web server is enabled when shipped. To launch the Web server:

- 1 Open the internet browser on your computer.
- 2 Enter the instrument's hostname or IP address into the browser's Address field to launch the Web server. The following home page will appear:

KEYSIGHT TECHNOLOGIES Modular Solar Array Simulator

Welcome to your

Modular Solar Array Simulator

Instrument:	E4360A
Serial Number:	US43600005
Description:	Keysight E4360A (US43600005)
Hostname:	A-E4360A-00005.local
IP Address:	141.121.202.151
VISA TCPIP Connect String:	TCPIP0::A-E4360A-00005::INST0

[Turn On Front Panel Identification Indicator](#)

[Advanced Information](#)

Use the navigation bar on the left to access your Modular Solar Array Simulator and related information.

Click the "Web Control" button in the navigation bar on the left to start the application.

© Keysight Technologies 2013

LXI LAN eXtensions for Instrumentation

3 Getting Started

- 3 Click on the Browser Web Control button in the navigation bar on the left to begin controlling your instrument. All of the Browser Web controls are located in the drop-down menus that appear on the top of the page. These controls are very similar to the front panel menus of the instrument. Note however, that the Browser Web Control gives you the additional capability of viewing and editing the SAS curve that you programmed in SAS or Table mode.

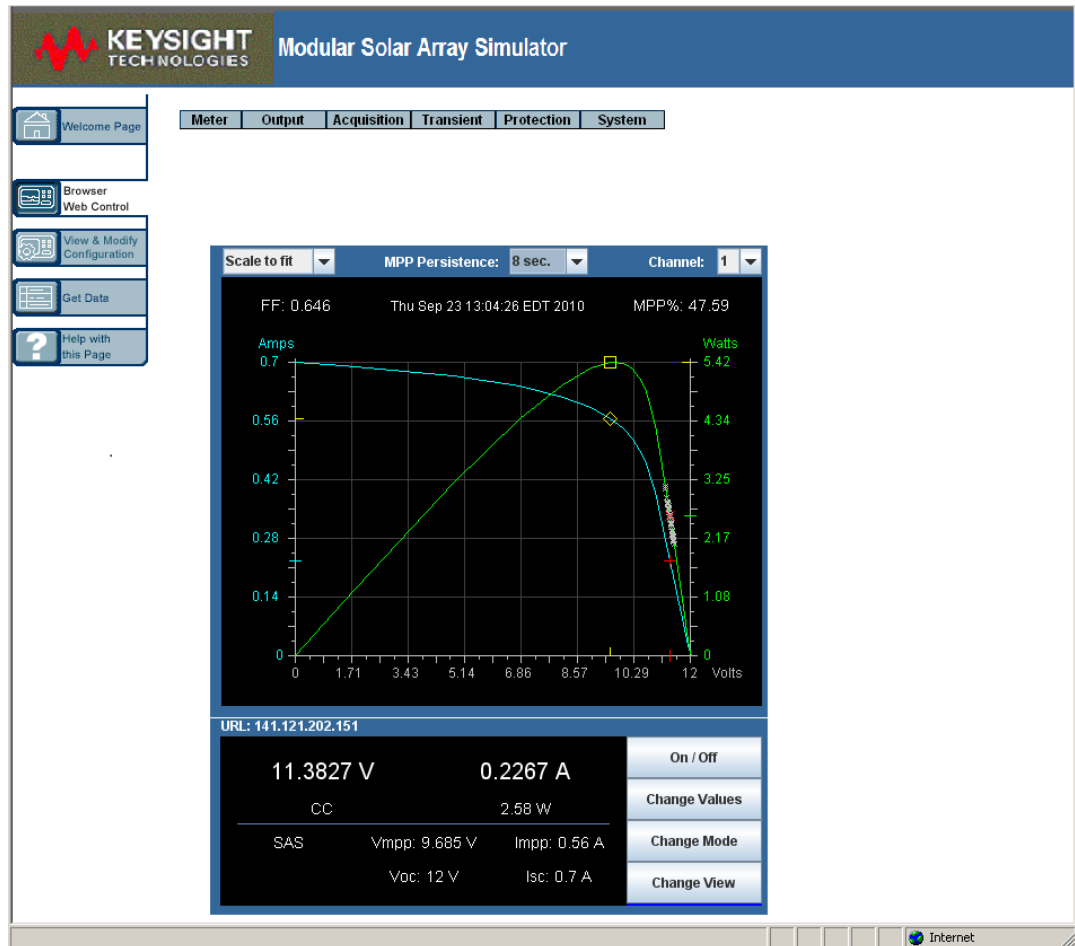

Click on the Help with this Page button for additional information about this page or any of the Web server pages.

- 4 Click on the Get Data button to view the configuration and settings of the instrument to which you are presently connected.
- 5 If desired, you can control access to the Web server using password protection. As shipped from the factory, no password is set. To set a password, click on the View & Modify Configuration button. Click on the Help with this Page button for additional information about setting a password.

Using Telnet

In an MS-DOS Command Prompt box type: *telnet hostname 5024* where *hostname* is the E4360 hostname or IP address, and 5024 is the instrument's telnet port.

You should get a Telnet session box with a title indicating that you are connected to the SAS. Type the SCPI commands at the prompt.

Using Sockets

NOTE

SAS mainframes allow any combination of up to **four simultaneous data socket, control socket, and telnet connections to be made.**

Keysight instruments have standardized on using port 5025 for SCPI socket services. A **data socket** on this port can be used to send and receive ASCII/SCPI commands, queries, and query responses. All commands must be terminated with a newline for the message to be parsed. All query responses will also be terminated with a newline.

The socket programming interface also allows a **control socket** connection. The control socket can be used by a client to send device clear and to receive service requests. Unlike the data socket, which uses a fixed port number, the port number for a control socket varies and must be obtained by sending the following SCPI query to the data socket: **SYSTem:COMMunicate:TCPIP:CONTRol?**

After the port number is obtained, a control socket connection can be opened. As with the data socket, all commands to the control socket must be terminated with a newline, and all query responses returned on the control socket will be terminated with a newline.

To send a device clear, send the string "DCL" to the control socket. When the SAS has finished performing the device clear it echoes the string "DCL" back to the control socket.

Service requests are enabled for control sockets using the Service Request Enable register. Once service requests have been enabled, the client program listens on the control connection. When SRQ goes true the instrument will send the string "SRQ +nn" to the client. The "nn" is the status byte value, which the client can use to determine the source of the service request.

4

Using the Solar Array Simulator

Operating in Fixed Mode	56
Making Measurements	57
Using the Protection Functions	61
Configuring Paralleled Outputs	63
Operating in SAS Mode	64
Programming Curve Lists	67
Operating in Table Mode	72
Data Logging Measurements	76
System-Related Operations	80

This chapter contains examples on how to operate your SAS from the front panel and over the remote interface using SCPI commands.

For complete details on the SCPI (Standard Commands for Programmable Instruments) commands, refer to the Keysight 14360A Programmer's Reference Guide available at <http://www.keysight.com/find/E4360> under Technical Support.

The simple examples discussed in this chapter show you how to program:

- Fixed mode functions
- Protection functions
- SAS functions
- Table functions
- System functions

Refer to Appendix B for information about using the Digital Port on the back of your instrument.

Operating in Fixed Mode

At power turn on, with *RST, or when executing a Device Clear, the operating state of the SAS is set to Fixed mode. As shown in the following figure, the Fixed mode output characteristic is similar to that of a standard power supply, except that the output capacitance is <100 nF on the Keysight E4361A, and <50 nF on the Keysight E4362A. This low output capacitance is ideal when using the unit as a constant current source. To use the unit as a low-impedance constant voltage source however, you can add an external output capacitor if so desired. The value of this capacitor should not exceed 2,000 μ F.

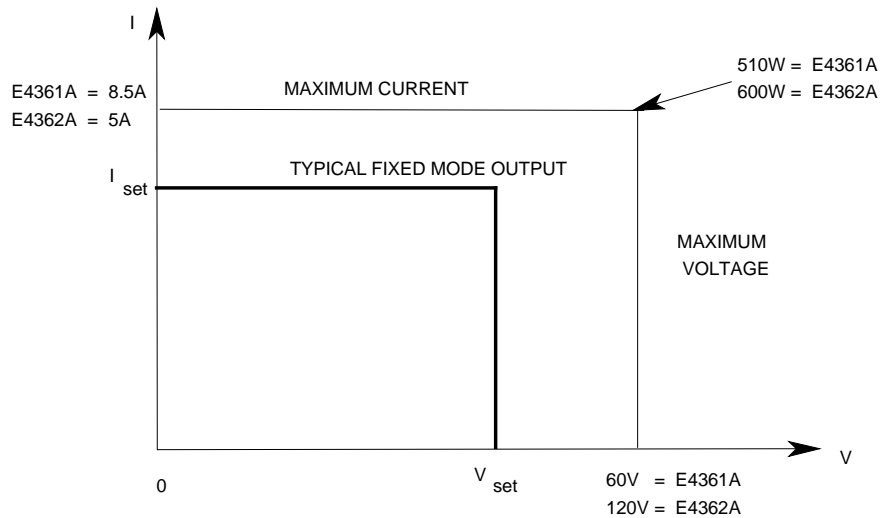

NOTE

If the programmed values exceed the maximum current and voltage boundaries by more than 2 or 3 percent, an OUT OF RANGE error will be indicated.

Enable Fixed mode

To enable Fixed mode:

Front Panel:	SCPI Command:
Select Output\Mode . Check that Fixed is selected.	To check the mode setting send: CURR:MODE? (@1) To set the mode to Fixed send: CURR:MODE FIX, (@1)

Select an Output Channel

Front Panel:	SCPI Command:
Press the Channel key to select an output channel.	Enter the selected channel(s) in the command's parameter list. (@1, 2)

Set the Output Voltage

Front Panel:	SCPI Command:
Press the Voltage key. Enter a value and press Select.	To set output 1 to 50 V: VOLT 50, (@1) To set all outputs to 60 V: VOLT 60, (@1, 2)

Set the Output Current

Front Panel:	SCPI Command:
Press the Current key. Enter a value and press Select.	To set output 1 to 1 A: CURR 1, (@1) To set all outputs to 2 A: CURR 2, (@1, 2)

Enable the Output

Front Panel:	SCPI Command:
Press the On/Off key. To enable/disable both outputs using the front panel On/Off key, select System\Preferences\Keys . Check On/Off affects all channels. The All indicator will be on.	To enable only output 1: OUTP ON, (@1) To enable all outputs: OUTP ON, (@1, 2)

Because of internal circuit start-up procedures, Output On may take up to 75 milliseconds to complete its function. Conversely, Output Off may take up to 75 milliseconds to complete its function.

To mitigate these built-in delays, you can program the output to zero volts rather than using the output on/off function.

Making Measurements

Each output channel has its own measurement capability. The output voltage and current are measured simultaneously by acquiring a number of samples at the selected time interval, applying a window function to the samples, and *averaging* the samples.

The power-on and *RST time interval and number of samples settings yield a measurement time of 1.7 milliseconds per reading (166 data points at 10.24 μ s intervals). The output windowing function is Rectangular. Use the following commands to make a measurement:

Front Panel:	SCPI Command:
Select the Meter key.	Measure the output voltage or current: MEAS:VOLT? (@1, 2) MEAS:CURR? (@1, 2)

4 Using the Solar Array Simulator

To return both values of either a voltage or current measurement:

Front Panel:	SCPI Command:
Select the Meter key.	Measure the output voltage or current: MEAS:VOLT? (@1, 2)
	Then Fetch the other parameter: FETC:CURR? (@1, 2)

You can use the measurement trigger system to synchronize the acquisition of measurements with a bus trigger, a transient trigger from another channel, or an external trigger signal. Then use FETCh commands to return voltage or current information from the acquired data. Briefly, to make a triggered measurement:

1. Select the trigger source.
2. Initiate the trigger system.
3. Trigger the measurement.
4. Delay the measurement if desired.
5. Fetch the measurement.

The following figure illustrates the measurement trigger model.

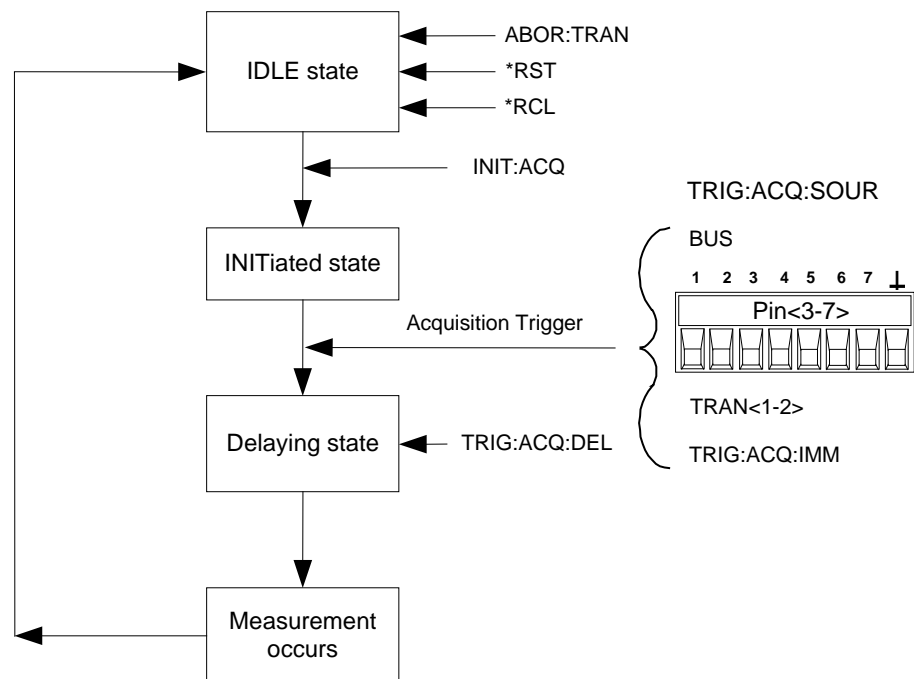

Select the Measurement Trigger Source

NOTE

An immediate trigger command over the bus will generate an immediate trigger regardless of the trigger source.

Unless you are using the TRIG:ACQ:IMM command to trigger the measurement, select a trigger source from the following:

Bus	Selects GPIB device trigger, *TRG, or <GET> (Group Execute Trigger).
Pin<number>	Selects a pin on the external port connector as the trigger source. The selected pin must be configured as a Trigger Input to be used as a trigger source (see Appendix B)
Transient <channel>	Selects the output channel's transient system as the trigger source. <channel> specifies the channel.

The trigger source can only be selected using the following SCPI commands. The front panel only displays the trigger source that is presently selected.

Front Panel:	SCPI Command:
Select Acquisition\Control . Displays the trigger source.	To select bus as the trigger source for output 1: TRIG:ACQ:SOUR BUS, (@1) To select a pin as the trigger source: TRIG:ACQ:SOUR PIN<n>, (@1) To select a transient channel as the trigger source: TRIG:ACQ:SOUR TRAN<n>, (@1)

Initiate the Measurement Trigger System

When the SAS is turned on, the trigger system is in the Idle state. In this state, the trigger system is disabled, ignoring all triggers. The INITiate commands enable the measurement system to receive triggers. To initiate the measurement system, use the following SCPI command. The front panel only displays the trigger state.

Front Panel:	SCPI Command:
Select Acquisition\Control . Displays the trigger state.	To initiate the measurement trigger system for all outputs: INIT:ACQ (@1, 2)

After a trigger is received and the measurement completes, the trigger system returns to the Idle state. Thus, it will be necessary to initiate the measurement system for the next triggered measurement.

Trigger the Measurement

You can immediately trigger the measurement as follows:

Front Panel:	SCPI Command:
Not available	To trigger a measurement on output 1: TRIG:ACQ (@1) If the trigger source is BUS, you can send *TRG or an IEEE-488 <get>.

As previously discussed, a trigger can also be generated by another output channel or an input pin on the digital port connector. If any of these systems are configured as the trigger source, the instrument will wait indefinitely for the trigger signal. If the trigger does not occur, you must manually return the trigger system to the Idle state.

The following commands return the trigger system to the Idle state:

Front Panel:	SCPI Command:
Select Acquisition\Control . Then select the Abort button.	ABOR:ACQ (@1)

Delaying the Measurement

If you are using the measurement function in conjunction with a triggered SAS list (described later in this chapter), you may need to program a delay before the measurement occurs to allow for any output settling in response to the list change. To delay the triggered measurement, use the following SCPI command. The front panel only displays the trigger delay setting.

Front Panel:	SCPI Command:
Select Acquisition\Control . Displays the trigger delay.	To generate a measurement trigger delay of 1 second on output 1: TRIG:ACQ:DEL 1, (@1)

Fetch the Measurement

To return the triggered voltage or current measurement:

Front Panel:	SCPI Command:
Not available	Fetch the voltage parameter: FETC:VOLT? (@1, 2) Fetch the current parameter: FETC:CURR? (@1, 2)

Using the Protection Functions

Each output has independent protection functions. A front panel status indicator will turn on when a protection function has been set. Protection functions are latching, which means that they must be cleared once they have been set. As explained under “Couple Output Protection” you can configure the instrument so that when a protection fault occurs on one output, ALL outputs will be turned off.

Of the listed protection functions, OT, OS, and PF not programmable.

- OV** Over-voltage protection is a hardware OVP whose trip level is a programmable value. The OVP is always enabled.
- OC** Over-current protection is a hardware OCP whose trip level is a programmable value. The OCP is always enabled.
- OT** Over-temperature protection monitors the temperature of each output and shuts down the output if any temperature exceeds the maximum factory-defined limits.
- OS** Over-switching protection monitors the shunt switching frequency of each output and shuts down the output if the switching frequency exceeds the 50 kHz limit.
- PF** PF indicates that a power fail condition on the AC mains has disabled the output.
- PROT** Prot indicates that the output is disabled because of a coupled protection signal from another output.
- INH** The **Inhibit** input (pin 3) on the rear panel digital connector can be programmed to act as an external shutdown signal. Refer to Appendix B for further information.

Set the Over-Voltage and Over-Current Protection

The SAS has hardware over-voltage and over-current circuits that protect the unit if the output voltage or output current exceed a preset value. When tripped, the protection circuit shuts off the output and fires the internal crowbar SCR in approximately 50 to 100 microseconds. To set the protection circuits:

Front Panel:	SCPI Command:
Select Protect\OVP . Enter a value in the OVP level box and press Select.	To set the OVP for outputs 1 and 2: VOLT:PROT:LEV 10, (@1, 2)
Select Protect\OCP . Enter a value in the OCP level box and press Select.	To set the OCP for outputs 1 and 2: CURR:PROT:LEV 1, (@1, 2)

Couple Output Protection

Protection coupling lets you disable all output channels when a protection condition occurs on a single output channel. To couple output protection:

Front Panel:	SCPI Command:
Select Protect\Coupling . Check the Enable Coupling box and press Select.	To enable protection Coupling: OUTP:PROT:COUP ON

Clear Output Protection Functions

If an over-voltage, over-current, over-temperature, over-switching, power-fail condition, protection condition, or inhibit signal occurs, the SAS turns off the affected output channel. The appropriate operating status indicator on the front panel will be on (e.g. OV, OC, OT, PF, PROT, INH). To clear the protection function and restore normal operation, first remove that condition that caused the protection fault. Then, clear the protection function as follows:

Front Panel:	SCPI Command:
Select Protect\Clear . Select the Clear button.	To clear a protection fault on output 1: OUTP:PROT:CLE (@1)

Using Voltage and Current Soft Limits

Inadvertent shutdown of the output through hardware protection is undesirable in many applications. Soft limits provide protection against programming the output to undesirable values without tripping the hardware protection circuits. The benefit of soft limit protection is that the output settings and the output state are not changed when an undesirable value is programmed.

Soft limits are available for both voltage and current parameters. Only the maximum programmable values can be limited; there are no limits for minimum programmable values. Soft limits are non-volatile and are automatically restored on power-up. The soft limits are not affected by a reset (*RST); they can only be changed by reprogramming. Soft limits apply to all modes of operation as follows.

Fixed mode	Voltage and current programming values are checked against the soft limits.
SAS mode	In IMMEDIATE mode, the Voc and the Isc parameters are checked against the soft limits. In LIST mode, the Voc and the Isc list is checked against the soft limits when the list system is initiated.
Table mode	Each I-V point including the offset setting is checked against the soft limits when the table is activated; an error is generated if it exceeds the soft limits.

Front Panel:	SCPI Command:
Select Protect\SoftLimits \Voltage. Enter a value in the Limit box and press Select.	To set a soft voltage limit for output 1: VOLT:SLIM:HIGH 10, (@1)
Select Protect\SoftLimits \Current. Enter a value in the Limit box and press Select.	To set a soft current limit for output 1: CURR:SLIM:HIGH 1, (@1)

Configuring Paralleled Outputs

Direct-Parallel or Auto-Parallel

Specify whether an output channel is connected in direct-parallel or auto-parallel. Refer to chapter 2 for connection information.

Front Panel:	SCPI Command:
Select System\Groups\Parallel.	To specify auto-parallel: SYST:GRO:PAR AUTO, (@1)
Select either Direct or Auto.	To specify direct-parallel: SYST:GRO:PAR DIR, (@1)

Master or Follower

If the output channels are connected in auto-parallel configuration, you must also specify the source of the control signal used for current programming. This determines if the channel is a "master" or "follower" channel. Note that this step is not required with outputs that are direct-paralleled..

Internal	The control signal for current programming is sourced from the internal circuits of the channel. This designates the "master" channel in auto-parallel operation. This control signal is available on the SAS pin of the master channel's analog connector for controlling the follower channels.
External	The control signal for current programming is sourced from the IP+ pin on the analog connector of the channel in auto-parallel operation. This designates a "follower" channel in auto-parallel operation.

To specify the current control source:

Front Panel:	SCPI Command:
Select System\Groups\Programming.	To specify a master output: CURR:MODE:PROG INT, (@1)
Select either Internal or External.	To specify a follower output: CURR:MODE:PROG EXT, (@2)

NOTE

This command can only be programmed when the instrument is operating in Fixed mode. An error will be generated if this command is sent when the instrument is operating in SAS or in Table mode.

Operating in SAS Mode

SAS mode uses an exponential model to approximate the I-V curve as illustrated in the following figure. It is programmed in terms of its open circuit voltage (V_{oc}), short circuit current (I_{sc}), maximum voltage point (V_{mp}), and maximum current point (I_{mp}) at the approximate peak power point (see Appendix A for model equations). SAS operation is achieved by sampling the output voltage, applying a low-pass filter, and continually adjusting the constant current loop by using the filtered voltage as an index into the exponential model.

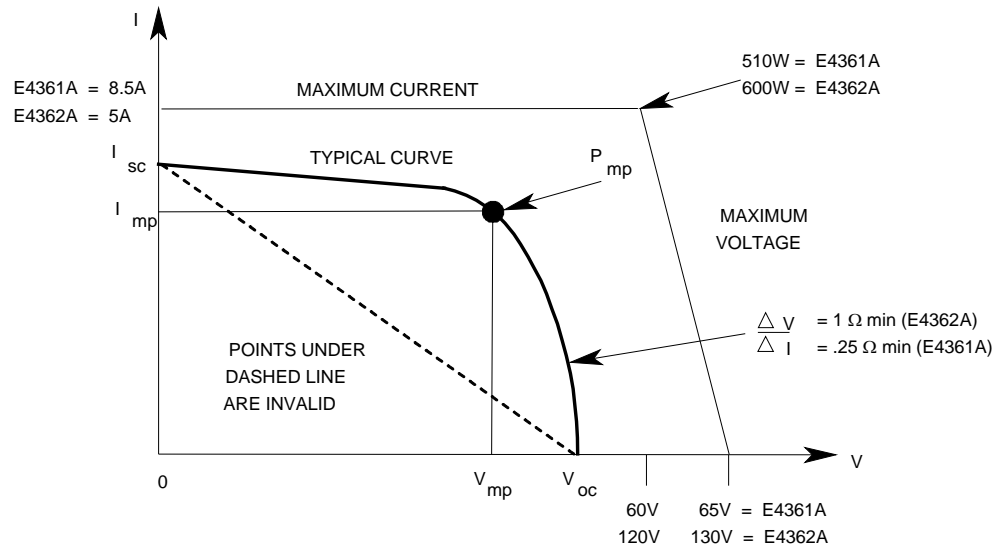

Curve Resolution

When operating in SAS mode, the four curve parameters are converted into a DAC table consisting of a monotonic collection of I-V points, which are used by the instrument to control the output. You have a choice in the size of this DAC table to optimize your application for either better table resolution or faster update speed. (Update speed is defined as the time it takes to generate and activate a new DAC table.) Specify the table resolution as follows:

Front Panel:	SCPI Command:
Select Output\Resolution . Select either Low or High.	To specify low resolution send: <code>CURR:MODE:DTAB 256, (@1)</code> To specify high resolution send: <code>CURR:MODE:DTAB 4096, (@1)</code>

NOTE

This command can only be programmed when the instrument is operating in Fixed mode. An error will be generated if this command is sent when the instrument is operating in SAS or in Table mode.

The resolution setting applies to this channel whenever a curve is programmed in SAS mode or a Table is loaded in Table mode. The large table (4096 points) will give a smoother I-V curve but takes much longer to update. The small table (256 points) is faster to update. This mode selection applies to both SAS and Table modes, and also when using curve lists.

The smaller 256-point table mode is particularly useful for curve lists, since it allows for a faster dwell to be specified (tens of milliseconds instead of hundreds of milliseconds). However, the current resolution of a 256-point table is much coarser (16x) than a 4096-point table. The 256-point table may not be suitable in low short-circuit current applications. Due to the coarseness of the 256-point table, a low Isc application may result in a DAC table that may not have enough points to approximate the shape of the typical I-V curve illustrated earlier.

It should be noted that not all of the points in the DAC table are available for approximating the I-V curve. Because of circuit requirements, portions of the DAC table are reserved for internal use. The number of points available for curve approximation is about 3600 points for high resolution mode and 230 points for low resolution mode. For all practical purposes however, the entire DAC table at its respective resolution is used in SAS mode.

The following table describes the performance characteristics of the two resolution settings:

High Resolution/large DAC table:	Low Resolution/small DAC table:
<ul style="list-style-type: none"> • 3600 points typical. • 12-bit current programming. • 350ms table update rate. 	<ul style="list-style-type: none"> • 230 points typical. • 8-bit current programming. • 30ms table update rate.

Enable SAS mode

To enable SAS mode:

Front Panel:	SCPI Command:
Select Output\Mode . Check that SAS is selected.	To check the mode setting send: <code>CURR:MODE? (@1)</code> To set the mode to SAS send: <code>CURR:MODE SAS,@1)</code>

The front panel display will indicate that SAS mode is in effect.



Program the Curve

Program the SAS curve parameters as follows:

Front Panel:	SCPI Command:
Select Output\SAS\Curve . Enter the curve parameters in the Vmp, Voc, Imp, and Isc boxes. Press Set Curve to verify and enter the parameter values.	To program Vmp, Voc, Imp, and Isc on the same program line: CURR:SAS:ISC 5, (@1); IMP 4.5, (@1);: VOLT:SAS:VOC 100, (@1); VMP 90, (@1)

If you are programming an entirely new SAS curve, it is best to send all four curve parameters on the same program line as shown above. The instrument checks whether all four parameters are within acceptable limits. If a parameter is outside the limits, an execution error occurs and no new curve is programmed.

When a *single* curve parameter is sent with a program line, it is checked along with the three unchanged parameters to determine whether the parameters and resulting curve are within acceptable limits. A curve is then programmed using the new parameter.

Output the Curve

To output the curve that was previously programmed:

Front Panel:	SCPI Command:
Select the correct channel. Press the On/Off key.	To run the curve on output 1: OUTP ON, (@1)

NOTE

When the unit detects invalid equation parameters, it will generate an error, light the ERR annunciator on the front panel, and will not use the new parameters. Instead, it will operate with the last valid settings. Therefore, although it may seem that the unit is operating correctly, it will **NOT** be using the values that you have programmed for SAS mode.

Curve Restrictions

Under certain conditions, such as if Imp is significantly less than Isc, the model equations described in Appendix A will exhibit a certain degree of inaccuracy in that the actual maximum power point (Pmp) and value may be somewhat different from the expected value of Pmp (Imp x Vmp). Thus the actual Pmp point may not occur at exactly the Imp x Vmp. This can be corrected by entering new values for Imp and Vmp (see Figure A-1 in Appendix A).

Note that the accuracy specifications in SAS mode are relative to the values given in the exponential equations, and not necessarily to the input parameters Imp and Vmp. However, the Isc and Voc values are always accurately given by the exponential equations.

Parameter	E4361A Output Module	E4362A Output Module
Pmp (maximum power)	≤ 510 W	≤ 600 W
Voc (voltage, open-circuit)	≤ 65 V	≤ 130 V
Isc (current, short circuit)	8.5 A	5 A
Vmp (voltage, maximum power)	< Voc	< Voc
Imp (current, maximum power)	≤ Isc	≤ Isc
$\Delta V/\Delta I$ (delta V/delta I)	≥ 0.25 Ω	≥ 1 Ω

Front Panel Restrictions

You can use the front panel when the unit is operating in SAS mode. However, any Fixed-mode voltage and current values that you enter from the front panel will have no effect on the unit while it is in SAS mode. The front panel values will take effect when the unit is placed in Fixed mode. All other functions such as output On/Off, Menu, Meter, Channel, and Error are active while the unit is operating in SAS mode.

Programming Curve Lists

I-V curves may be list-controlled. List mode lets you generate a sequence or list of I-V curves with rapidly changing curve characteristics. A separate list must be programmed for each curve parameter: ISC, IMP, VOC, and VMP. The lists can contain up to 512 individually programmed curves and can be programmed to repeat themselves. Curve lists can either be dwell-paced or trigger-paced. To generate an I-V curve list you must:

1. Program the I-V curve lists.
2. If dwell-paced, program the dwell-time list.
3. If trigger-paced, select the trigger source.
4. Initiate the trigger system and provide a trigger signal.

The following figure illustrates the transient trigger model used in List mode.

The curve lists are paced by a separate dwell list that defines the duration or dwell time of each curve. Each of the up to 512 curves can be set to an individual dwell time (in seconds) that specifies how long the list will remain at that curve before moving on to the next curve. Dwell times can be programmed from 0 to 33,554 seconds. The default dwell time is 0.03 seconds.

Dwell-paced lists can generate trigger signals at the transition points between curves in the list. To use these trigger signals you must select the dwell channel as the trigger source for the specified Trigger Output pin. Refer to Appendix B for further information. This trigger signal can be used to synchronize other events with the list.

4 Using the Solar Array Simulator

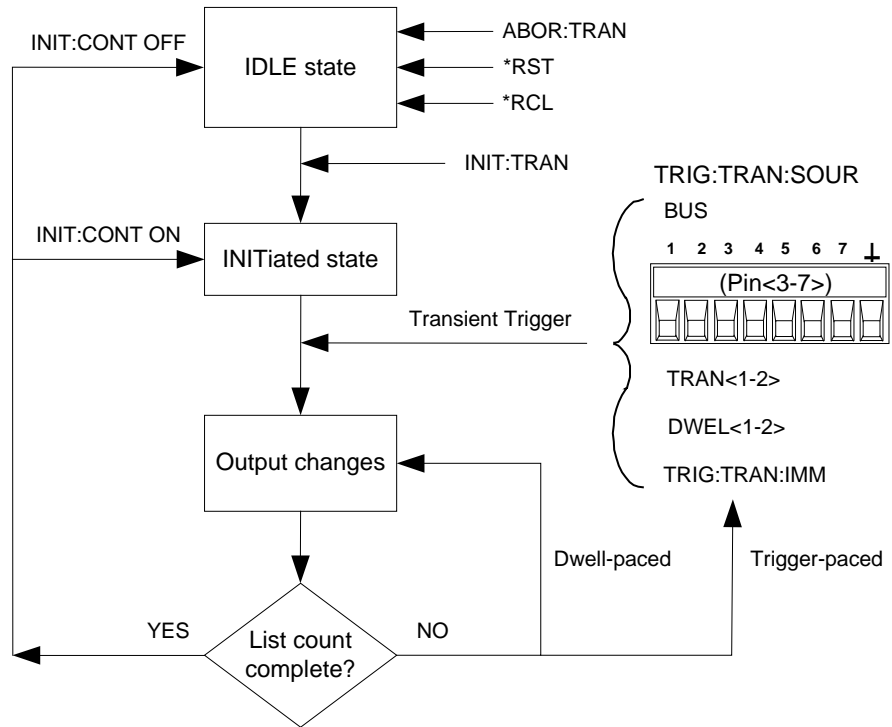

If you need the curve lists to closely follow external events, the lists can be paced by external trigger signals. With trigger-pacing, the lists advance one curve for each trigger received. Select a trigger source from the available trigger sources. With a trigger-paced list, you do not need to program a dwell time for each curve.

All lists must have the same number of parameter values, otherwise an error will occur when the lists are run. For convenience, a parameter list may be programmed with only one value. In this case, the single-value list is treated as if it had the same number of values as the other lists, with all parameters in the list set to the same value.

The following table illustrates the differences between programming the list data from the front panel or using SCPI commands. The rows illustrate how five curves are programmed using the SCPI parameter commands. The columns illustrate how five curves are programmed using the front panel list steps.

SCPI parameter	Front panel list steps				
	# 0	# 1	# 2	# 3	# 4
Vmp	85	90	90	88	85
Voc	90	95	95	90	90
Imp	4	3	3	3	2
Isc	5	4	4	4	3
Dwell	2	3	5	5	4

NOTE

List data is not stored in non-volatile memory. This means that any list data that is sent to the SAS will be lost when the unit is powered off.

Program the List

The following procedure shows how to program a list of I-V curves.

Step 1. Set the SAS mode to List.

Front Panel:	SCPI Command:
Select Output\SAS\Source . Set the SAS mode to List. Press Select.	To program output 1, use <code>CURR:SAS:MODE LIST, (@1)</code>

Step 2. Program the list of values for the List function. Each parameter must have the same number of values. The order in which the values are entered determines the order in which they are output.

Front Panel:	SCPI Command:
Select Transient\List\Config . Select the List Step number and enter values into the Vmp, Voc, Imp, and Isc boxes and press Enter. Repeat for each step. Use the ↑ ↓ keys to select the next step.	To program Vmp, Voc, Imp, and Isc: <code>LIST:SAS:VMP 85,90,90,88,85, (@1)</code> <code>LIST:SAS:VOC 90,95,95,90,90, (@1)</code> <code>LIST:SAS:IMP 4,3,3,3,2, (@1)</code> <code>LIST:SAS:ISC 5,4,4,4,3, (@1)</code>

Step 3. Determine the time interval, in seconds, that the output remains at each step in a list before it advances to the next step.

Front Panel:	SCPI Command:
Select Transient\List\Config . Select the List Step number and enter a dwell value. Press Enter. Repeat for each step. Use the ↑ ↓ keys to select the next step.	To program dwell values: <code>LIST:DWEL 2,3,5,5,4, (@1)</code>

The number of dwell values must equal the number of curve values. If a dwell list has only one value, that value will be applied to all curves in the list.

Step 4. Specify how the lists are paced: by dwell times, or external triggers.

Front Panel:	SCPI Command:
Select Transient\List\Pace . Select Dwell or Trigger-paced. Press Select.	To select dwell-paced: <code>LIST:STEP AUTO, (@1)</code> To select trigger-paced: <code>LIST:STEP ONCE, (@1)</code>

With dwell-pacing, the dwell values entered in step 3 pace the list. The dwell time determines the minimum time that the output remains at each curve. As each dwell time elapses, the next curve is immediately output. With trigger-pacing, the list advances one curve for each trigger received.

Step 5. Specify how you want the list to terminate. You can either return to the settings in effect before the list started, or remain at the settings of the last list curve (step).

Front Panel:	SCPI Command:
Select Transient\List\Terminate.	To return to the pre-list settings: LIST:TERM:LAST 0, (@1)
Select Return to start settings, or Stop at last settings. Press Select.	To remain at the last list settings: LIST:TERM:LAST 1, (@1)

Step 6. If applicable, specify how many times you want the list to run. Sending the INFINITY parameter in the SCPI command makes the list repeat indefinitely. The default list count is 1.

Front Panel:	SCPI Command:
Select Transient\List\Count. Enter the number of list counts and Press Select.	To program the list to run twice, use LIST:COUN 2, (@1)

Select the Trigger Source

NOTE

An immediate trigger command over the bus will generate an immediate trigger regardless of the trigger source.

Unless you are using the TRIG:TRAN:IMM command to trigger the output, select a trigger source from the following:

- Bus** Selects GPIB device trigger, *TRG, or <GET> (Group Execute Trigger).
- Pin<number>** Selects a pin on the external port connector as the trigger source. <n> specifies the pin number. The selected pin must be configured as a Trigger Input to be used as a trigger source (see Appendix B).
- Transient <channel>** Selects the output channel's transient system as the trigger source. <channel> specifies the channel.
- Dwell <channel>** Selects the output channel's dwell timer as the trigger source. <channel> specifies the channel.

Use the following commands to select a trigger source:

Front Panel:	SCPI Command:
Select Transient\TrigSource. Then select a digital pin, transient channel, dwell channel, or bus.	To select bus as the trigger source: TRIG:TRAN:SOUR BUS, (@1) To select a channel's dwell output: TRIG:TRAN:SOUR DWEL<n>, (@1) To select a pin as the trigger source: TRIG:TRAN:SOUR PIN<n>, (@1) To select a transient channel: TRIG:TRAN:SOUR TRAN<n>, (@1)

Initiate the Trigger System and Provide a Trigger

First, make sure that the selected output is enabled.

Front Panel:	SCPI Command:
Select the correct channel. Press the On/Off key.	To enable output 1: OUTP ON, (@1)

At turn-on, the trigger system is in the Idle state, in which all triggers are ignored. Initiating the trigger system moves it from the Idle state to the Initiated state, which enables the SAS to receive triggers.

Front Panel:	SCPI Command:
Select the Transient\Control . Select Initiate to initiate the trigger system.	To initiate the trigger system for all outputs: INIT:TRAN (@1, 2)

NOTE

The largest lists can take up to one minute to initialize. When the tran-WTG status bit is set, initialization is complete and the list is ready to be triggered.

The trigger system is waiting for a trigger signal in the Initiated state. You can immediately trigger the output as follows:

Front Panel:	SCPI Command:
Select Transient\Control . Select Trigger to generate an immediate trigger. This generates a trigger on both output channels.	To generate an immediate trigger: TRIG:TRAN (@1, 2) If the trigger source is BUS, you can send *TRG or an IEEE-488 <get>.

When a trigger is received, the list is started and advances to the first curve. Subsequent triggers will continue to pace the list. If the list is dwell-paced, the dwell times will continue to pace the list.

If the list count is greater than one, you will need to initiate the transient system again to trigger the next round. To keep the transient system initiated, set the trigger action to Continuous mode.

Front Panel:	SCPI Command:
Select Transient\Control . Check the Init Continuous box.	INIT:CONT 1, (@1, 2)

If a digital pin is configured as the trigger source, the instrument will wait for the trigger signal. If the trigger does not occur, you can manually return the trigger system to the Idle state.

Front Panel:	SCPI Command:
Select Transient\Control . Press Abort.	ABOR:TRAN (@1)

Operating in Table Mode

NOTE

Output synchronization is NOT provided in Table mode; this means that the output will activate a table as soon as the command is received. You cannot synchronize table changes between outputs or mainframes. There is also no list support for table changes.

In Table mode, the output characteristic is determined by a user-defined table of I-V points as illustrated in the following figure. Table mode operation is achieved by sampling the output voltage, applying a low-pass filter, and continually adjusting the constant current loop by using the filtered voltage as an index into the stored table of points.

Linear interpolation is used to set the current when the filtered voltage does not have an exactly matching table entry. What this means is that the I-V curve is generated by connecting the points in the table by straight lines. The more points that you provide, the more accurate the curve will be when the points are connected.

Each point is defined by an I-V coordinate-pair that define the location of the point on the curve. The first value is the voltage; the second value is the current. If no $V=0$ value is provided, the current associated with the lowest voltage value is defined as I_{sc} and the curve will be extended horizontally to the current axis. If no $I=0$ value is provided, the slope that was determined by the last two current values will be extended to the voltage axis.

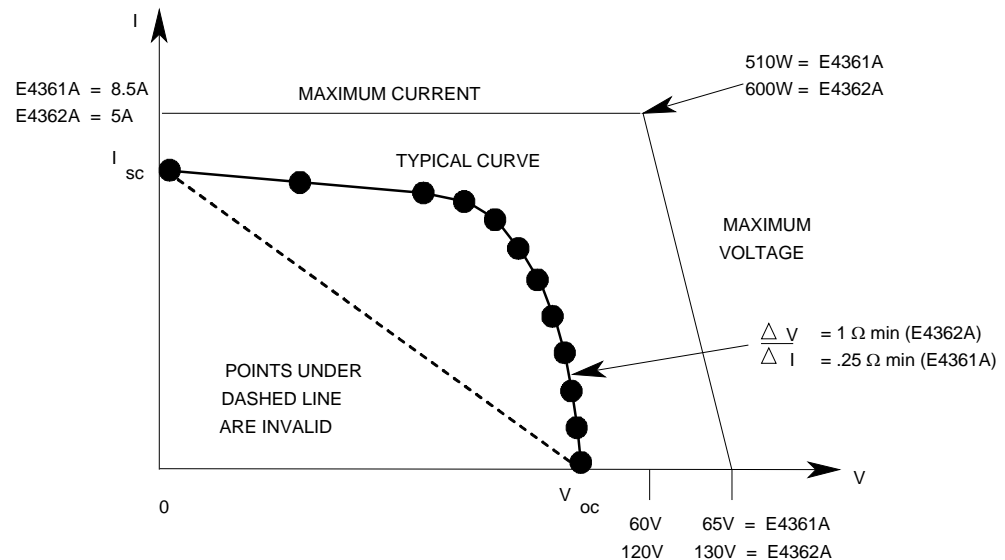

Tables are initially created using the MEM:TABL:SEL command. Up to 30 tables can be created and stored in volatile memory per mainframe. To save the tables when the instrument is turned off, copy them to non-volatile memory using MEM:TABL:COPY. Up to 30 tables can be stored in non-volatile memory per mainframe.

Select the Table

Select a table as follows:

Front Panel:	SCPI Command:
Select Output\Table>Select Table. Select a table from the list on the left and press Select.	To select a table on output 1: CURR:TABLE:NAME name, (@1)

Enable Table Mode

To enable Table mode:

Front Panel:	SCPI Command:
Select Output\Mode. Check that Table is selected.	To check the mode setting send: CURR:MODE? (@1) To enable Table mode send: CURR:MODE TABLE, (@1)

The front panel display will indicate that Table mode is in effect and indicate which table has been selected.



Output the Table

To output the table that was previously selected:

Front Panel:	SCPI Command:
Select the correct channel. Press the On/Off key.	To run the table on output 1: OUTP ON, (@1)

NOTE

When the unit detects an invalid I-V point, it will generate an error, light the ERR annunciator on the front panel, and will not use the new parameters. Instead, it will operate with the last valid table settings. Therefore, although it may seem that the unit is operating correctly, it will **NOT** be using the values that you have programmed for Table mode.

Program the Table

If a table does not exist, you must program a new table. Programming a table consists of entering voltage data and current data to create the desired number of I-V coordinate-pairs. The number of voltage values must match the number of current values.

Front Panel:	SCPI Command:
Not Available	To create a new a table for output 1: MEM:TABL:SEL name, (@1)
	To enter voltage data for the table: MEM:TABL:VOLT 0, 5, 10, 50, 55, (@1)
	To enter current data for the table: MEM:TABL:CURR 4, 4, 3.5, 3, 2.5, (@1)

Table Restrictions

A table must have a minimum of three I-V points and can have up to 4000 I-V points, but an equal number of voltage and current values must be sent. Otherwise an error will occur when the table is selected with CURR:TABL:NAME. Use MEM:TABL:CURR:POIN? and MEM:TABL:VOLT:POIN? to find the length of an existing table.

Points must be above dashed line shown in the previous figure. There is no restriction on the spacing or gap between the voltage or current values, but the values must be monotonic. Voltage values must be sent in increasing order of magnitude; current values must be sent in equal or decreasing order of magnitude. For a Keysight E4361A for example: (1,8) (50,7.8) (55,7.5) (56,7) (57,6) (58,4) (59,1).

Each I-V point, when combined with the table offset, cannot exceed the unit's maximum voltage, current, or power.

A table cannot be deleted or redefined while it is selected.

The following table lists the maximum parameter restrictions by output module.

Parameter	E4361A Output Module	E4362A Output Module
Pmp (maximum power)	≤ 510 W	≤ 600 W
Voc (voltage, open-circuit)	≤ 65 V	≤ 130 V
Isc (current, short circuit)	8.5 A	5 A
Vmp & Imp	calculated internally	calculated internally
$\Delta V/\Delta I$ (delta V/delta I)	≥ .25 Ω	≥ 1 Ω

Table Offsets

A new table can be generated by applying a limited voltage or current offset to an existing table. This can be helpful in simulating temperature, angular, rotational, or aging changes. Offset values are non-cumulative, they can be either positive or negative, and can be applied to any table. Each time a voltage or current offset is programmed, a new I-V curve is calculated based on the user-defined table that is presently active and the supplied offset values. Program the offset using the following SCPI commands:

Front Panel:	SCPI Command:
Not Available.	To enter a current offset for output 1: CURR:TABL:OFFS 1.5, (@1)
	To enter a voltage offset for output 1: VOLT:TABL:OFFS 10, (@1)

Offset values affect the original I-V curve as follows:

Positive Voltage offsets

The original curve is shifted to the right (→) along the positive voltage axis, and the first point on the curve is extended horizontally at I_{sc} until it intersects the current axis. Thus, the new V_{oc} equals the original V_{oc} plus the offset value. An error will be generated if the offset causes the maximum allowed V_{oc} or the power limit to be exceeded.

Negative Voltage offsets

The original curve is offset to the left (←) along the positive voltage axis, and terminated at the current axis. The curve points that are not used because they extended beyond the current axis are not deleted; they will be valid again if the negative voltage offset is reduced or eliminated.

Positive Current offsets

The original curve is offset up (↑) along the positive current axis, and the last point on the curve will be extended (at the same slope that was present in the original table curve at V_{oc}) until it intersects the voltage axis at a new, slightly higher V_{oc} value. The new I_{sc} equals the original I_{sc} plus the offset value. An error will be generated if the offset causes the maximum allowed I_{sc} , V_{oc} , or the power limit to be exceeded.

Negative Current offsets

The original curve is offset down (↓) along the positive current axis, and terminated at the voltage axis at a new, lower V_{oc} value. The curve points that are not used because they are extended beyond the voltage axis are not deleted; they will be valid again if the negative current offset is reduced or eliminated.

Table Resolution

When operating in Table mode, the voltage/current values are converted into a DAC table used by the instrument to control the output. You have a choice in the size of this DAC table to optimize your application for either better table resolution or faster update speed. Refer to Curve Resolution as previously described in this chapter for more information.

Front Panel Restrictions

You can use the front panel when the unit is operating in Table mode. However, any Fixed-mode voltage and current values that you enter from the front panel will have no effect on the unit while it is in Table mode. The front panel values will take effect when the unit is placed in Fixed mode. All other functions such as output On/Off, Menu, Meter, Channel, and Error are active while the unit is in Table mode.

Data Logging Measurements

The measurement examples discussed earlier in this chapter are suitable for low data rate applications. Data logging should be used in applications requiring higher data rate from multiple instruments. Data logging commands are not available from the front panel.

Data logging lets the SAS capture and buffer multiple measurements and return the data as a group. Since multiple data is returned in one transaction, this will dramatically increase the data bandwidth of the system. Briefly, to make data logging measurements:

1. Select the pacing mechanism and time interval.
2. Select the trigger source.
3. Initiate the data logger.
4. Trigger the data logger.
5. Format and Fetch the measurements.

Data logging measurements are captured from the free-running data stream (the same as the front-panel). The captured data are the instantaneous voltage and current measurements.

Each data logging measurement consists of a voltage and current. The fastest data logging rate is 50 measurements per second with a minimum time interval of 20 ms. The slowest data logging rate is 1 measurement per 65.535 seconds with a maximum time interval of 65.535 seconds. The buffer size is 65,534 records. Each record has a voltage and a current value. At the minimum time interval, the single-shot logging time will be about 21 minutes. At the maximum time interval, the logging time will be about 1192 hours.

Since data logging is de-coupled from the measurement system, explicit triggered measurements and fetches can occur while the data logger is running. However, since the free-running data stream is interrupted by the triggered measurement request, the logged data may have a jitter of 1 measurement sample (about 1.7 ms).

Select the Pacing and Time Interval

Data capture can be trigger-paced or a time-paced. Specify TRIGger to select trigger-paced data capture, or TIMer to select time-paced data capture. With time-paced data capture, you must also specify the time interval. The minimum time interval is 20 milliseconds. The maximum interval is 65.535 seconds.

Front Panel:	SCPI Command:
Not available.	To select trigger-paced data capture: SENS:DLOG:CLOC TRIG, (@1) To select time-paced data capture: SENS:DLOG:CLOC TIM, (@1) To specify a time interval of 1 second: SENS:DLOG:TINT 1, (@1)

Select the Trigger Source

NOTE

An immediate trigger command over the bus will generate an immediate trigger regardless of the trigger source.

Unless you are using the TRIG:DLOG command to trigger the output, select a trigger source from the following:

Bus	Selects GPIB device trigger, *TRG, or <GET> (Group Execute Trigger).
Dlog <channel>	Selects an output channel's datalog timer as the trigger source. <channel> specifies the channel.
Pin<number>	Selects a pin on the external port connector as the trigger source. <n> specifies the pin number. The selected pin must also be configured as a Trigger Input to be used as a trigger source (see Appendix B).
Transient <channel>	Selects an output channel's transient system as the trigger source. <channel> specifies the channel.

Use the following commands to select a trigger source:

Front Panel:	SCPI Command:
Not available.	To select bus as the trigger source: TRIG:DLOG:SOUR BUS, (@1) To select a channel's dwell output: TRIG:DLOG:SOUR DWEL<n>, (@1) To select a pin as the trigger source: TRIG:DLOG:SOUR PIN<n>, (@1) To select a transient channel: TRIG:DLOG:SOUR TRAN<n>, (@1)

Because data logging happens at event triggers, it is recommended to use hardwire triggers on the external digital port connector to synchronize data logging on multiple units.

Initiate the Data Logger

When the SAS is turned on, the data logger is in the Idle state. In this state, the data logger is disabled, ignoring all triggers. The INITiate command enables the data logger to receive triggers. This resets the datalog buffer and enables data logging on subsequent triggers. To initiate the data logger, use:

Front Panel:	SCPI Command:
Not available	To initiate a datalog on all outputs: INIT:DLOG (@1,2)

In time-paced data logging, this enables the datalog timer to receive the start trigger. Once the timer is started, data is captured at every TINTerval until data logging is stopped.

In trigger-paced data logging, this enables the datalog to continuously receive triggers and capture data until data logging is stopped.

After the datalog completes, the data logger returns to the Idle state. It will be necessary to initiate the data logger for the next datalog.

The DLOG-WTG status bit indicates the data logger has been INITiated and is ready for a trigger to start data logging. In trigger-paced data logging, DLOG-WTG is reset after the first trigger is received. In time-paced data logging, the trigger event starts the timer, data is captured, and DLOG-WTG is reset.

Trigger the Data Logger

You can immediately trigger the data logger as follows:

Front Panel:	SCPI Command:
Not available	To trigger the data logger on output 1: TRIG:DLOG (@1) If the trigger source is BUS, you can send *TRG or an IEEE-488 <get>.

Once the data logger is triggered, data logging continues until the measurement buffer is filled or an ABORt :DLOG is sent. The DLOG-BUSY status bit indicates the data logger has started and is logging normally. DLOG-BUSY is set after DLOG-WTG gets reset.

As previously discussed, a trigger can also be generated by another output channel or an input pin on the digital port connector. If any of these systems are configured as the trigger source, the instrument will wait indefinitely for the trigger signal. If the trigger does not occur, you must manually return the trigger system to the Idle state.

To stop the data logger and returns it to the Idle state, use:

Front Panel:	SCPI Command:
Not available.	ABOR :DLOG (@1)

Format and Fetch the Measurements

Data transferring can be accomplished in the following formats:

ASCII - Numeric data is transferred as ASCII bytes in <NR1>, <NR2>, or <NR3> format as appropriate. The numbers are separated by commas.

REAL - Data is transferred in a definite-length block as floating point numbers of 32 bits.

For binary data format, you can also specify how this data is transferred.

NORMAL - normal order (little-endian) or SWAPped - swapped-byte order (big-endian).

Use the following commands to select the transferred data format:

Front Panel:	SCPI Command:
Not available.	To specify ASCII data format on output 1: FORM ASCII, (@1)
	To specify real data format on output 1: FORM REAL, (@1)
	To specify normal binary transfer on output 1: FORM:BORD NORM, (@1)
	To specify swapped binary transfer on output 1: FORM:BORD SWAP, (@1)

Use the following command to retrieve the data. Specify the desired number of measurement records to return.

Front Panel:	SCPI Command:
Not available.	To return 12 records from output 1: FETC:DLOG? 12, (@1)

Data is returned in the following order:

<meas_volt>,<meas_curr>[,<meas_volt>,<meas_curr>]

The data type for <meas_volt> and <meas_curr> are float32 and the ASCII response is in NR3 format.

Multi-channel queries are not supported in ASCII mode. A separate transaction must be used to get data from each channel.

If there are fewer than n records available, all available records will be returned. Reading buffered measurements can occur while new measurements are being buffered. Doing this clears up buffer space for new measurements. This allows continuous acquisition to be implemented.

System-Related Operations

Grouped Channels

Output channels can be configured or “grouped” to create a single output with higher current and power capability. Refer to Appendix D for more information.

Instrument State Storage

The SAS has two storage locations in non-volatile memory to store instrument states. The locations are numbered 0 and 1. Any state previously stored in the same location will be overwritten.

Front Panel:	SCPI Command:
Select States\SaveRecall . In the SaveRecall field, enter a location from 0 to 1, and press Select. Select Save to save the state or Recall to recall a state.	To save a state: *SAV <n> To recall a state: *RCL <n>

When shipped from the factory, the SAS is set to automatically recall the reset (*RST) settings at power-on. However, you can configure the SAS to use the settings stored in memory location 0 at power-on.

Front Panel:	SCPI Command:
Select States\PowerOn . Select Recall State 0, then press Select.	OUTP: PON: STAT RCL0

Instrument Identification

For Keysight E4360 mainframes, you can return the model number, serial number, firmware revision, backup and active firmware. For output modules, you can return the model number, serial number, installed options, voltage, current and power rating.

Front Panel:	SCPI Command:
Select System\About\Frame . or Select System\About\Module .	*IDN? SYST: CHAN: MOD? (@1) SYST: CHAN: OPT? (@1) SYST: CHAN: SER? (@1)

Front Panel Keys

Lockout

You can lock the front panel keys to prevent unwanted control of the instrument from the front panel. This is the most secure way of locking the front panel keys because you need a password to unlock the front panel. The lockout setting is saved in non-volatile memory so that the front panel remains locked even after AC power is cycled.

Front Panel:	SCPI Command:
Select System\Preferences\Lock In the dialog box, enter the password to unlock the front panel. Then select Lock. The menu to unlock the front panel appears every time a key is pressed. Enter the password to unlock the front panel.	Not Available

If the password is lost, the `SYSTEM:PASSword:FPANel:RESet` command can reset the front panel lockout password to 0 (zero). It does not reset the administration/calibration password. Refer to the Programmer's Reference Help file on your Keysight 14360 System Control Tools CD for more information.

NOTE

The `SYSTEM:COMMunicate:RLState RWLock` command can also lock and unlock the front panel. This command is completely independent of the front panel lockout function. If you use this command to lock the front panel, the front panel will be unlocked when AC power is cycled.

Keys

You can enable or disable the front panel key clicks.

Front Panel:	SCPI Command:
Select System\Preferences\Keys Check Enable key clicks to enable key clicks. Un-check to disable key clicks.	Not Available

You can configure the On/Off key to enable or disable ALL outputs.

Front Panel:	SCPI Command:
Select System\Preferences\Keys . Check On/Off key affects all channels. The ON/Off key will now be active on ALL channels. The All indicator will be on.	Not Available

Front Panel Display

Screen Saver

The SAS has a front panel screen saver that significantly increases the life of the LCD display by turning it off during periods of inactivity. As shipped from the factory, the screen saver comes on one hour after activity on the front panel or interface has ceased.

When the screen saver is active, the front panel display turns off, and the LED next to the Line switch changes from green to amber.

To restore the front panel display, simply press one of the front panel keys. The first action of the key turns the display on. Subsequently, the key will revert to its normal function.

If the Wake on I/O function is selected, the display is restored whenever there is activity on the remote interface. This also resets the timer on the screen saver. As shipped, Wake on I/O is active.

Front Panel:	SCPI Command:
Select System\Preferences\Display\Saver Enable or disable the screen saver by checking or un-checking the Screen Saver checkbox. Then Press Select. Enter a value in minutes in the Saver Delay field to specify when the screen saver turns on. Check Wake on I/O to activate the display with I/O bus activity.	Not Available.

Contrast

You can set the contrast of the front panel display to compensate for ambient lighting conditions. The contrast can be set from 0% to 100% in increments of 1%. As-shipped, the contrast is set to 50%.

Front Panel:	SCPI Command:
Select System\Preferences\Display\Contrast Enter a contrast value in the Contrast box. Then Press Select.	Not Available.

View

You can specify how the output channels are displayed at turn on.

Front Panel:	SCPI Command:
Select System\Preferences\Display\View Check 1-channel to display channel one. Check 2-channel to display all channels.	To display all channels: DISP:VIEW METER2

Administration Functions

Accessing the Administration Functions

The Administration menu is password-protected. To log into the Administration menu:

Front Panel:	SCPI Command:
Select System\Admin>Login	Not Available.
If a password is required, enter it in the Password field and press Enter.	
If the Password field shows 0, simply press Enter. Zero is the factory default password.	

Changing the Password

To enter a password or change the password:

Front Panel:	SCPI Command:
Log into the Admin menu as previously described. Then select Password	Not Available.
Select a password that is numeric and up to 15 digits long. Enter it into the Password field and press Enter.	
Select Logout to log out of the Admin menu. This activates the password. You can now only enter the Admin menu by providing the new password	

If the password is lost or forgotten, access to the Admin menu can be restored by setting an internal switch to reset the password to 0. If the message “Locked out by internal switch setting” or “Calibration is inhibited by switch setting” appears, the switch is set to prevent the password from being changed (Refer to the E4360 Service Guide).

Securing the LAN, Web Server, and USB

The USB interface, LAN interface, and the Web server are enabled when shipped from the factory. To enable or disable access to the LAN and USB interfaces:

Front Panel:	SCPI Command:
Log into the Admin menu as previously described. Then select LAN .	Not Available.
Check Enable LAN to enable the LAN. Un-check this box to disable the LAN.	
Check Enable web server to enable the web server. Un-check this box to disable the web server. Note that the LAN must be enabled to enable the Web server.	

Front Panel:	SCPI Command:
Log into the Admin menu as previously described. Then select USB . Check Enable USB to enable the USB interface. Un-check this box to disable the USB.	Not Available.

Restoring the Non-volatile Factory Settings

Remote interface and certain front panel control settings are stored in non-volatile memory (refer to the following table). Changes to any non-volatile settings will be remembered and applied the next time the instrument is turned on.

To restore all nonvolatile settings to their factory defaults:

Front Panel:	SCPI Command:
Log into the Admin menu as previously described. Then select Nvram . Press Reset to restore the factory-shipped non-volatile settings.	Not Available.

The factory-shipped non-volatile LAN interface settings documented in the following table are optimized for connecting your SAS to a site network. They should also work well for other network configurations. To restore only the non-volatile LAN settings to their factory defaults, select the **System\IO\LAN\Config\Reset** menu.

Factory-shipped non-volatile LAN settings			
DHCP	Enabled	Host name	A-E4360-xxxxx
AutoIP	Enabled	Use DNS naming service	Enabled
IP Address	169.254.67.0	Use NetBIOS naming service	Enabled
Subnet Mask	255.255.0.0	Domain name	Blank
Default Gateway	0.0.0.0	TCP keepalive	Enabled
Obtain DNS server from DHCP	Enabled	TCP keepalive seconds	1800
DNS server	Blank		

Other factory-shipped non-volatile settings			
Admin/Calibration password	0 (zero)	On/Off key affects all channels	Disabled
Calibration date	March 5, 2008	Output Inhibit mode	Off
Channel grouping	No groups	Saved states	*RST command
Digital port function (all pins)	Digital In	Screen contrast	50%
Digital port polarity (all pins)	Positive	Screen saver	Enabled
Front panel lockout	Disabled	Screen saver delay	60 minutes
Front panel meter view	1-channel	USB interface	Enabled
GPIB Address	5	Wake on I/O	Enabled
Key clicks	Enabled	Web server	Enabled
LAN interface	Enabled		

Sanitizing Table Memory

The sanitize operation only affects the instrument's table memory. Sanitizing first writes a 0, then a 1, and then random values to all memory locations. It then performs a full chip erase on the instrument's flash memory device.

To sanitize the instrument's table memory:

Front Panel:	SCPI Command:
Log into the Admin menu as previously described. Then select Memory\Erase . Press Sanitize to sanitize table memory	SYST:MMEM:SAN

A self-test error is generated if the instrument is turned on and table memory has been sanitized but has not been restored (initialized). The instrument will be functional in Fixed and SAS modes, but not in Table mode. To restore the instrument's table memory after it has been sanitized:

Front Panel:	SCPI Command:
Log into the Admin menu as previously described. Then select Memory\Initialize . Press Initialize.	SYST:MMEM:INIT

Instrument Calibration

The calibration functions are also located in the Admin menu, and are password-protected from unauthorized use.

Front Panel:	SCPI Command:
Log into the Admin menu as previously described. Then select Cal .	CAL:PASS <NRf> where <NRf> is the numeric password

For complete information about calibrating the instrument, refer to the calibration section in the E4360 Service Guide. An electronic copy is included on the Keysight 14360 System Control Tools CD.

Appendix A

Specifications and Application Information

Keysight E4360A SAS Mainframe.....	88
Outline Diagram	90
Peak Power Tracker Application.....	91
Exponential Model Equations*.....	92
Series Switching Regulation	93
Shunt Switching Regulation.....	93

Supplemental Characteristics are not warranted but are descriptions of performance determined either by design or type testing.

NOTE

Complete specifications and supplemental characteristics information for all SAS output modules are included in the Keysight E4360 Modular Solar Array Simulator Specifications Guide. This document is available on the Keysight 14360A System Control Tools CD that is shipped along with your instrument as well as on the web at www.keysight.com/find/E4360.

Keysight E4360A SAS Mainframe

Supplemental Characteristics

Parameter	E4360A
Command Processing Time	
	≤ 1 ms from receipt of command to start of output change
Savable States	
Memory locations:	2 (0 and 1)
Pre-stored state:	0
Protection Response Characteristics	
INH input:	5 μs from receipt of inhibit to start of shutdown
Fault on coupled outputs:	< 10 μs from receipt of fault to start of shutdown
Digital Control Characteristics	
Maximum voltage ratings:	+16.5 VDC/– 5 VDC between pins (pin 8 is internally connected to chassis ground).
Pins 1 and 2 as FLT output:	Maximum low-level output voltage = 0.5 V @ 4 mA Maximum low-level sink current = 4 mA Typical System-level leakage current = 1 mA @ 16.5 VDC
Pins 3 - 7 as digital/trigger outputs: (pin 8 = common)	Maximum low-level output voltage = 0.5 V @ 4 mA; 1 V @ 50 mA; 1.75 V @ 100 mA Maximum low-level sink current = 100 mA Typical System-level leakage current = 0.8 mA @ 16.5 VDC
Pins 1 - 7 as digital/trigger inputs and pin 3 as INH input: (pin 8 = common)	Maximum low-level input voltage = 0.8 V Minimum System-level input voltage = 2 V Typical low-level current = 2 mA @ 0 V (internal 2.2k pull-up) Typical System-level leakage current = 0.12 mA @ 16.5 VDC
Interface Capabilities	
GPIB:	SCPI - 1993, IEEE 488.2 compliant interface
LXI compliance:	Class C (only applies to units with LXI label on front panel)
USB 2.0:	Requires Keysight IO Library version M.01.01 or 14.0 and up
10/100 LAN:	Requires Keysight IO Library version L.01.01 or 14.0 and up
Built-in Web server:	Requires Internet Explorer 5+ or Netscape 6.2+
Environmental Conditions	
Operating environment:	Indoor use, installation category II (for AC input), pollution degree 2
Temperature range:	0°C to 55°C (output current is derated above 40°C ambient temperature)
Relative humidity:	Up to 95%
Altitude:	Up to 2000 meters
Storage temperature:	-30°C to 70°C
Acoustic Noise Declaration	
This statement is provided to comply with the requirements of the German Sound Emission Directive, from 18 January 1991.	Sound Pressure Lp <70 dB(A), At Operator Position, Normal Operation, According to EN 27779 (Type Test). Schalldruckpegel Lp <70 dB(A), Am Arbeitsplatz, Normaler Betrieb, Nach EN 27779 (Typprüfung).

Supplemental Characteristics (continued)

Parameter	E4360A
Regulatory Compliance	
EMC:	<p>Complies with European EMC Directive for test and measurement products.</p> <ul style="list-style-type: none"> • IEC/EN 61326-1 • CISPR 11, Group 1, class A • AS/NZS CISPR 11 • ICES/NMB-001 <p>Complies with Australian standard and carries C-Tick mark. This ISM device complies with Canadian ICES-001. Cet appareil ISM est conforme à la norme NMB-001 du Canada.</p>
Safety:	<p>Complies with European Low Voltage Directive and carries the CE-marking. Conforms to UL 61010-1 and CSA C22.2 61010-1.</p> <p>Declarations of Conformity for this product and for other Keysight products may be downloaded from the Web. Go to http://www.keysight.com/go/conformity and click on “Declarations of Conformity.” You can then search by product number to find the latest Declaration of Conformity</p>
AC Mains	
Input ratings:	~ 100 VAC – 240 VAC; 50/60/400Hz
Power consumption:	<p>1440 VA (@ <, 180 VAC input for E4360A) 2500 VA (@ >, 180 VAC input for E4360A) 1440 VA (@100 VAC – 240 VAC input for E4360J01)</p>
Power factor: ^{NOTE 1}	0.99 @ nominal input and rated power
AC line spike rating:	1 kV typical
Fuse:	15A / 250 VAC non-time delay (Keysight p/n 2110-0054)
<p>100-180 VAC Note: AC mains circuits rated at nominal 100-180 VAC cannot supply enough current to power the E4360A mainframe when two output modules are installed. In this case, internal circuits will limit the output current of the modules to one half of their rating. For a single installed module, full output current will be available at nominal 100-180 VAC. This restriction does not apply to mainframe Model E4360J01.</p>	
Dimensions	
Height:	88.1 mm / 3.5 in. for E4360A 44.75 mm / 1.75 in for E4360J01
Width:	432.5 mm / 17.03 in.
Depth including handles:	633.9 mm / 24.96 in.
Net Weight	
E4360A with 2 output modules:	17.6 kg / 38.4 lbs.
E4360J01 with 2 output modules:	11.82 kg / 26 lbs
Single output module:	3.3 kg / 7.2 lbs.

¹ Under full load at 400 Hz, power factor drops from 0.99 @ 120 VAC to as low as 0.76 @ 265 VAC. Power factor degrades further under no load conditions.

Outline Diagram

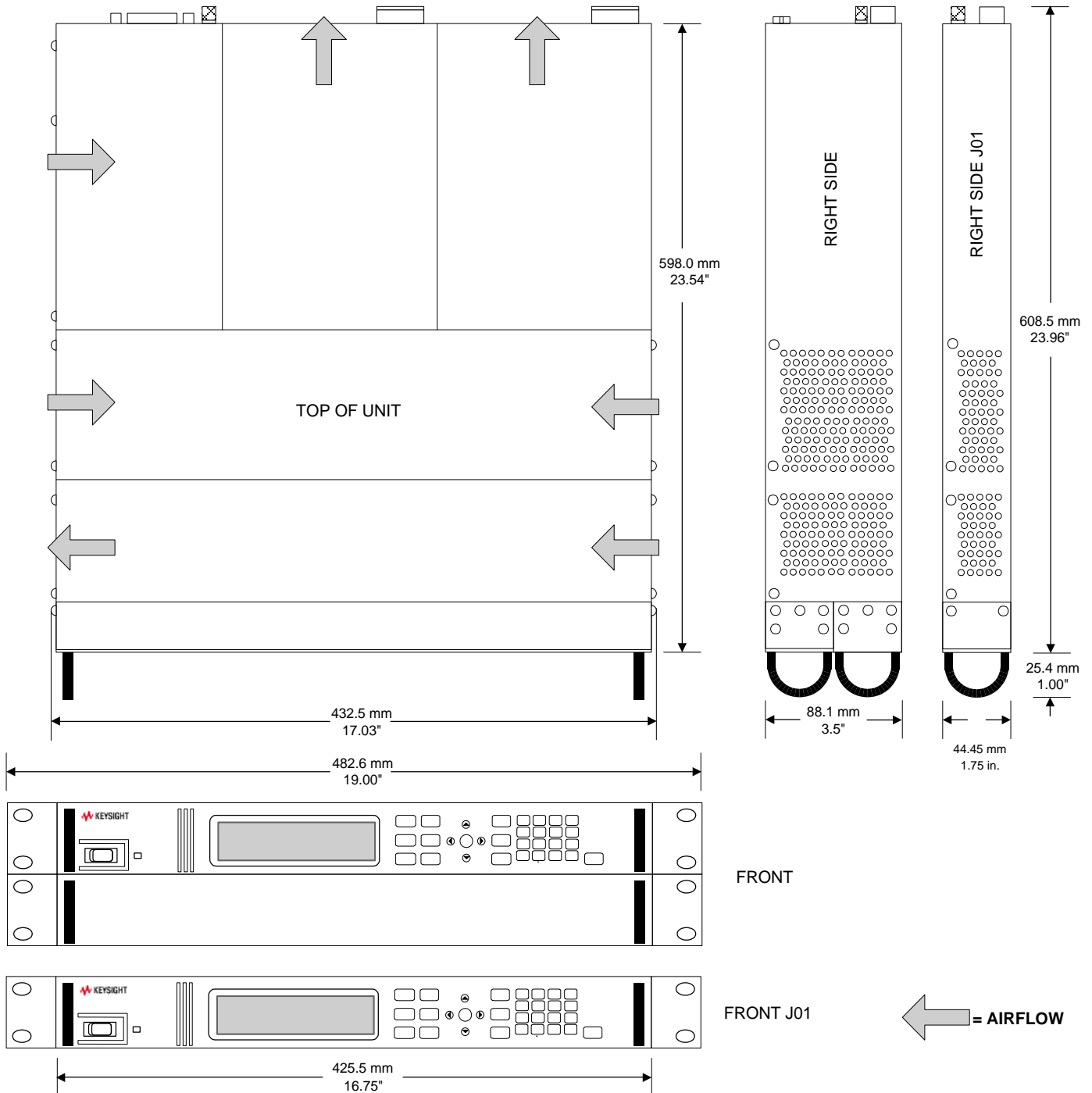

Peak Power Tracker Application

The peak power tracker is a customer-provided application. In this application, the load is constantly searching for the maximum power point of the I-V curve. To achieve this, the peak power tracker sweeps around the peak power point. The SAS can be used in this application in either SAS mode or in Table mode. Note that the ability of the SAS to track the I-V curve depends on both the excursion from the peak power point and the modulation frequency.

The following graph depicts the SAS peak power tracking error for both models. The load is sinusoidally swept from -5%, -10%, or -15% on one side of Pmp to -5%, -10% or -15% on the other side of Pmp. As the frequency of the sweep is increased, the tracking error will increase as indicated by the graph

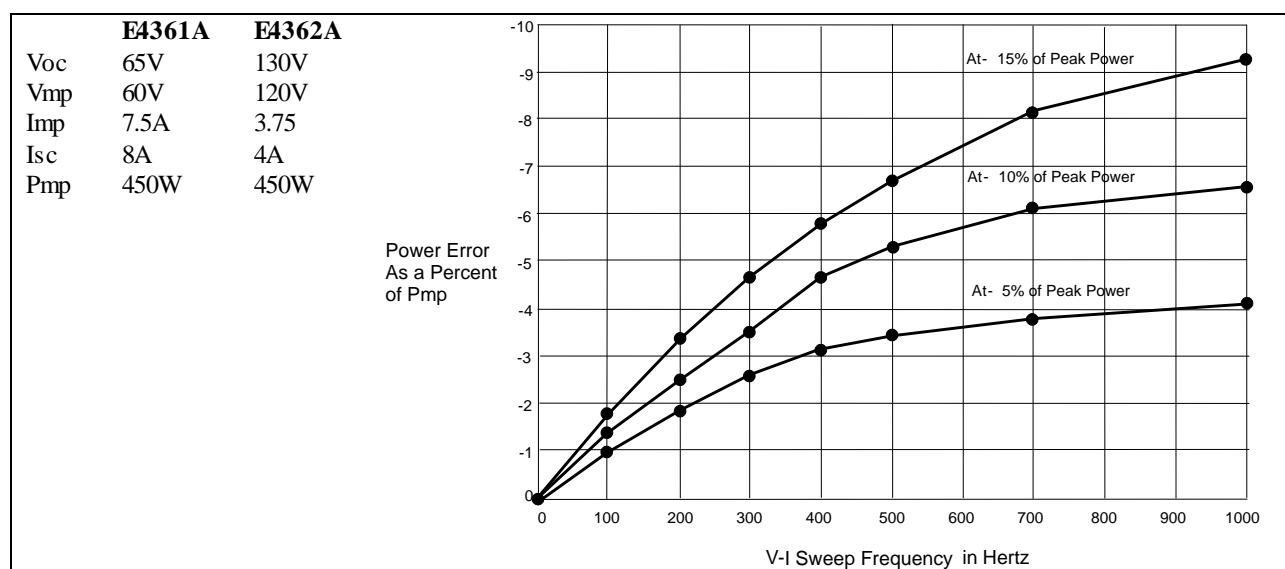

Figure A- 1. Percent Power Error in SAS Mode

Exponential Model Equations*

The following equations describe the solar array simulator exponential model using the parameters R_s , N , and a , which are defined as functions of the four input parameters.

$$R_s = \frac{V_{oc} - V_{mp}}{I_{mp}}$$

$$N = \frac{\ln(2 - 2^a)}{\ln\left(\frac{I_{mp}}{I_{sc}}\right)}$$

$$a = \frac{V_{mp}\left(1 + \frac{R_s I_{sc}}{V_{oc}}\right) + R_s(I_{mp} - I_{sc})}{V_{oc}}$$

$$V = \frac{V_{oc} \ln\left(2 - \left(\frac{I}{I_{sc}}\right)^N\right)}{\ln(2)} - R_s(I - I_{sc})$$

$$V = \frac{V_{oc} \ln\left(2 - \left(\frac{I}{I_{sc}}\right)^N\right)}{1 + \frac{R_s I_{sc}}{V_{oc}}} - R_s(I - I_{sc})$$

Note that these equations tend to be most accurate for curves that are somewhat rectangular.** Figure A-2 indicates the potential range of Pmp error percent due to the modeling equation. The x-axis parameter is $(V_{oc}/V_{mp}) * (I_{sc}/I_{mp})$, which is a measure of the rectangularity of the simulator curve, with values near 1 being highly rectangular. The y-axis is a measure of the possible error of the curve algorithm equation at the peak power point as defined by the following equation:

$$\% Pmp_{error} = \left(\frac{Equation_{Pmp}}{(I_{mp})(V_{mp})} - 1 \right) * 100\%$$

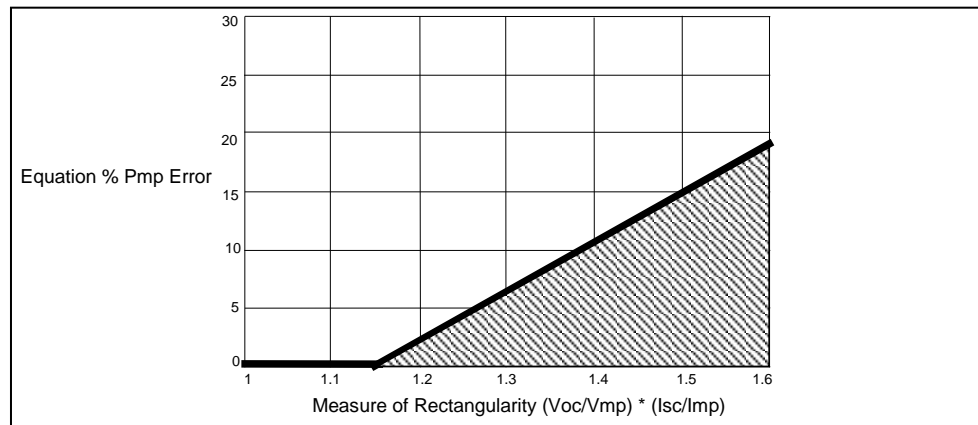

Figure A-2. Range of Pmp Error Due to Modeling Equation

*The exponential model is described in the paper: Britton, Lunscher, and Tanju, "A 9 KW High-Performance Solar Array Simulator", Proceedings of the European Space Power Conference, August 1993 (ESA WPP-054, August 1993).

**The potential error between the equation's actual peak power and the expected peak power ($V_{mp} * I_{mp}$) will increase as the curves become less rectangular.

Series Switching Regulation

Outputs must be connected in direct or in auto-parallel as explained in chapter 2. In this application, regulation is achieved by controlling the duty cycle of a series FET, which can be operated at frequencies up to 50kHz. An internal clamp circuit minimizes output voltage overshoots when the output of the SAS is quickly unloaded.

Reference settings for Keysight E4362A:

Voc: 130V
 Vmp: 120v
 Imp: 4.75A
 Isc: 5.00A

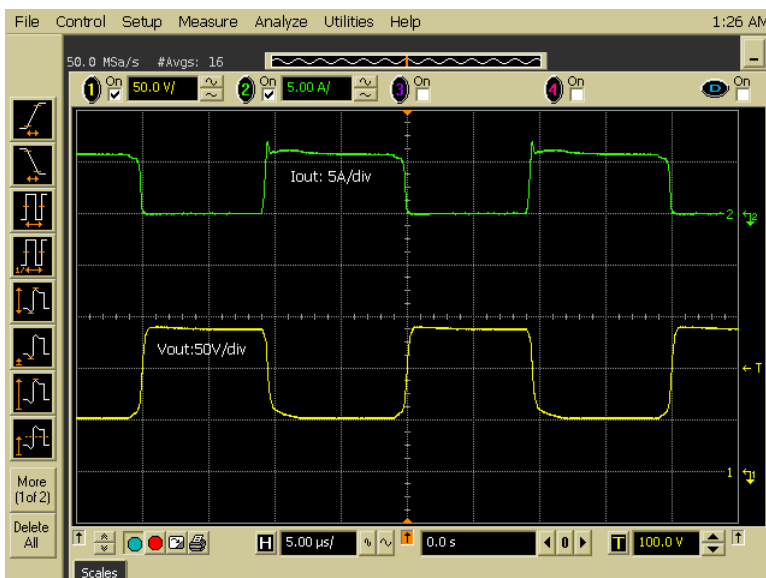
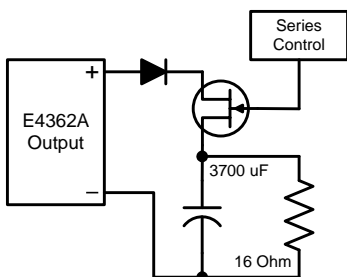

Shunt Switching Regulation

Outputs must be connected in direct or in auto-parallel as explained in chapter 2. In this application, regulation is achieved by controlling the duty cycle of a shunt FET, which can be operated at frequencies up to 50kHz. The relatively clean output current waveform is due to the fast dynamic response and low output capacitance of the SAS.

Reference settings for Keysight E4362A:

Voc: 130V
 Vmp: 120v
 Imp: 4.75A
 Isc: 5.00A

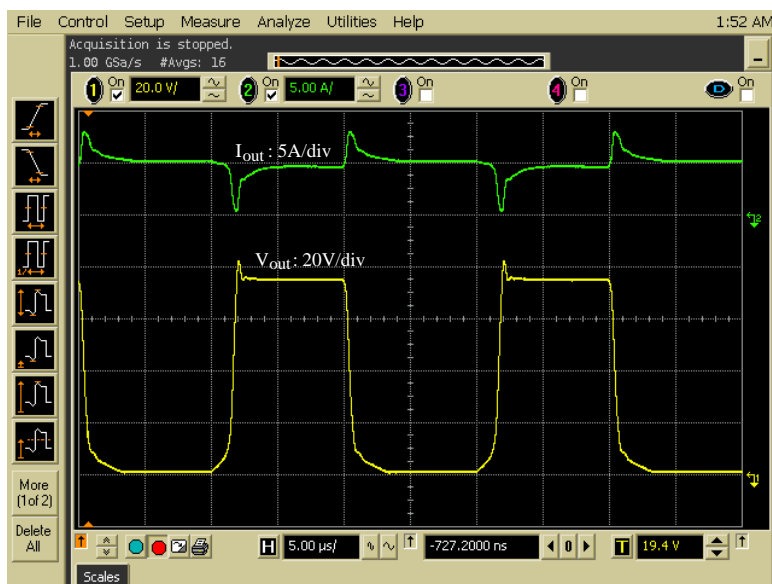
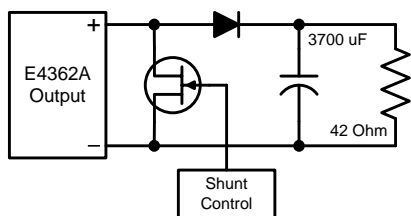

Appendix B

Digital Port Functions

Digital Control Port.....	96
---------------------------	----

A Digital Control Port consisting of seven I/O pins is provided to access various control functions. Each pin is user-configurable. The following control functions are available for the I/O pins:

- Bi-directional Digital I/O
- Digital Input only
- External Trigger In/Out
- Fault Output
- Inhibit Input
- Output On/Off Couple

Digital Control Port

An 8-pin connector and a quick-disconnect connector plug are provided on each instrument for accessing the digital control port functions.

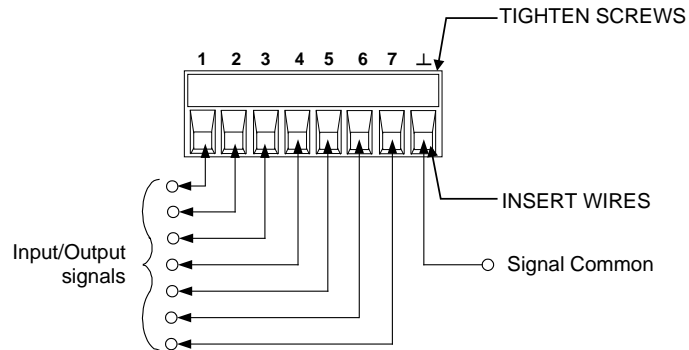

The digital control connector accepts wires sizes from AWG 14 to AWG 30. Note that wire sizes smaller than AWG 24 are not recommended. Disconnect the connector plug to make your wire connections.

NOTE

It is good engineering practice to twist and shield all signal wires to and from the digital connectors. If shielded wire is used, connect only one end of the shield to chassis ground to prevent ground loops.

The following chart describes the possible pin configuration for the available pin functions. For a complete description of the electrical characteristics of the digital I/O port, refer to Appendix A.

Pin Function	Available configurable pins
Digital I/O and Digital In	Pins 1 through 7
External Trigger In/Out	Pins 3 through 7
Output Couple State	Pins 4 through 7
Fault Out	Pins 1 and 2
Inhibit In	Pin 3
Common (⊥)	Pin 8

In addition to the configurable pin functions, the active signal polarity for each pin is also configurable. When Positive polarity is selected, a logical true signal is a voltage high at the pin. When negative polarity is selected, a logical true signal is a voltage low at the pin.

For a complete description of the electrical characteristics of the digital I/O port, see Appendix A.

Bi-directional Digital I/O

Each of the seven pins can be configured as general-purpose bi-directional digital inputs and outputs. The polarity of the pins can also be configured. Pin 8 is the signal common for the digital I/O pins. Data is programmed according to the following bit assignments:

Pin	7	6	5	4	3	2	1
Bit	6	5	4	3	2	1	0
	(msb)						(lsb)

To configure the pins for digital I/O:

Front Panel:	SCPI Command:
Select System\IO\DigPort\Pin<n> , where <n> is the pin number. Select Function, then Digital I/O. Go back one level, select Polarity, then either Positive or Negative. To send data to the pins, select System\IO\DigPort\Data . Select the Data Out field and enter the binary word.	To configure the pin function: DIG:PIN<1-7>:FUNC DIO To configure pin polarity: DIG:PIN<1-7>:POL <pol> To send data to the pins: DIG:OUTP:DATA <data>

The digital I/O pin can be used to control both relay circuits as well as digital interface circuits. The following figure illustrates typical relay circuits as well as digital interface circuit connections using the digital I/O functions.

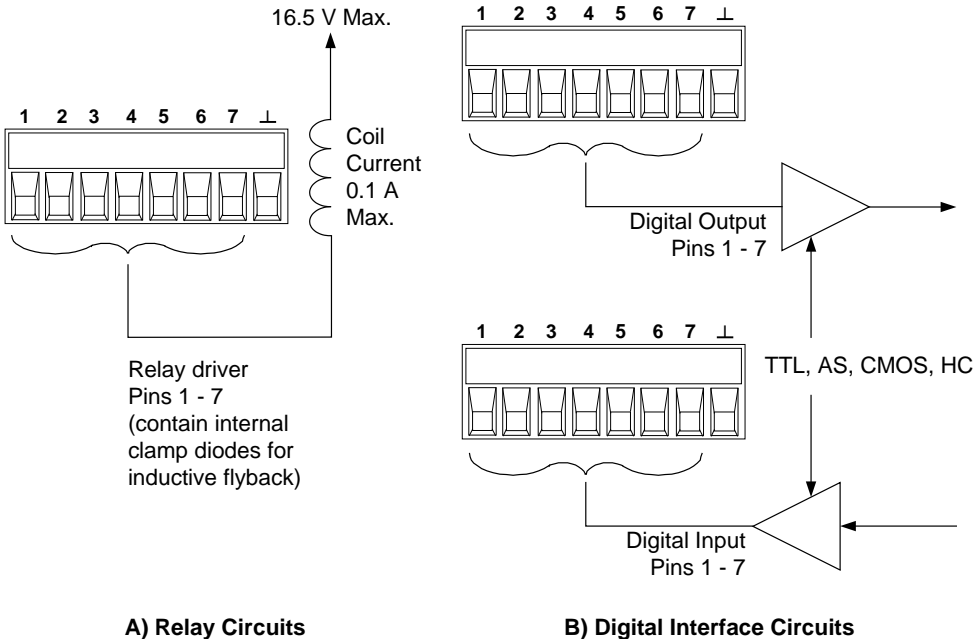

Digital Input

Each of the seven pins can be configured as digital input only. The polarity of the pins can also be configured. Pin 8 is the signal common for the digital input pins. The pin status reflects the true condition of the external signal that is applied to the pin. The pin state is not affected by the value of the binary output word.

To configure the pins for digital input only:

Front Panel:	SCPI Command:
Select	To configure the pin function:
System\IO\DigPort\Pin<n> , where <n> is the pin number.	DIG:PIN<1-7>:FUNC DINP
Select Function, then Digital In.	To configure pin polarity:
Go back one level, select Polarity, then either Positive or Negative.	DIG:PIN<1-7>:POL <pol>
To read the data from the pins, select System\IO\DigPort\Data .	To read the pin data:
The input data is displayed as a binary number in the Data In field.	DIG:INP:DATA?

External Trigger

Each of the seven pins can be configured as either trigger inputs or trigger outputs. The polarity of the pins can also be configured. When you program trigger polarity, POSitive means a rising edge and NEGative means a falling edge. Pin 8 is the signal common for the trigger pins.

When configured as a trigger input, you can apply either a negative-going or a positive-going pulse to the designated trigger input pin. The trigger latency is 5 microseconds. The minimum pulse width is 4 microseconds for positive-going signals, and 10 microseconds for negative-going signals. The pin's polarity setting determines which edge generates a trigger-in event.

When configured as a trigger output, the designated trigger pin will generate a 10 microsecond-wide trigger pulse in response to a trigger event. Depending on the polarity setting, it can be either positive-going or negative-going when referenced to common.

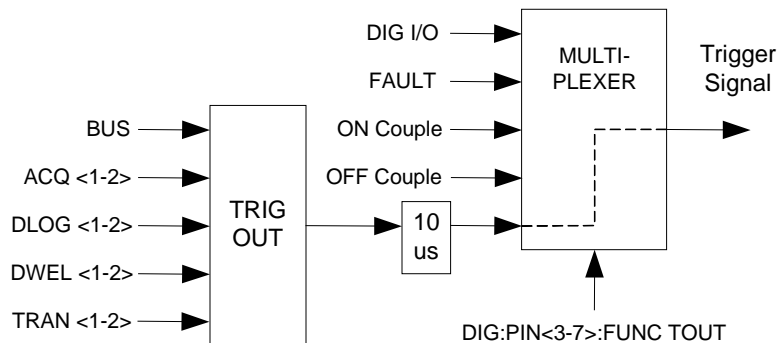

Front Panel:	SCPI Command:
Select System\IO\DigPort\Pin<n> , where <n> is the pin number.	To select the trigger output function for pin 1: DIG:PIN1:FUNC TOUT
Select Function, then either Trigger In or Trigger Out.	To select the trigger input function for pin 2: DIG:PIN2:FUNC TINP
Go back one level, select Polarity, then either Positive or Negative.	To select the trigger polarity: DIG:PIN<1-7>:POL <pol>

If you have configured the pin as a trigger output, select a trigger source from the following:

Bus	Selects GPIB device trigger, *TRG, or <GET> (Group Execute Trigger).
Acquisition <channel>	Selects a pin on the external port connector as the trigger source. <n> specifies the pin number. The selected pin must be configured as a Trigger Input to be used as a trigger source (see Appendix B).
Datalog <channel>	Selects the output channel's datalog timer as the trigger source. <channel> specifies the channel.
Dwell <channel>	Selects the output channel's dwell timer as the trigger source. <channel> specifies the channel.
Transient <channel>	Selects the output channel's transient system as the trigger source. <channel> specifies the channel.

Select a trigger source for the output trigger pin.

Front Panel:	SCPI Command:
Select System\IO\DigPort\Pin<n> , Select Function, then select a Trigger Source.	To select a trigger source for pin 1: TRIG:PIN1:SOUR BUS TRIG:PIN1:SOUR ACQ<n> TRIG:PIN1:SOUR TRAN<n> TRIG:PIN1:SOUR DLOG<n>

Fault Output

Pins 1 and 2 can be configured as a fault-output pair. The polarity of pin 1 can also be configured. Pin 1 is the Fault output; pin 2 is the common for pin 1. Note that pin 2 must also be connected to pin 8.

The Fault Output function enables a fault condition on any channel to generate a fault signal on the Digital Control port. The following conditions will generate a fault event: over-voltage, over-current, over-temperature, inhibit signal, power-fail condition, or on some models, a power-limit condition.

Both pins 1 and 2 are dedicated to this function. This provides for an optically-isolated output. Pin 2's function is ignored. Note that the Fault output signal remains latched until the fault condition is cleared. You must also clear the protection circuit.

Front Panel:	SCPI Command:
Select System\IO\DigPort\Pin1.	To configure the Fault function: DIG:PIN1:FUNC FAUL
Select Function, then Fault Out.	To select the fault output polarity: DIG:PIN1:POL <pol>
Go back one level, select Polarity, then either Positive or Negative.	

Inhibit Input

Pin 3 can be configured as a remote inhibit input. The polarity of pin 3 can also be configured. Pin 8 is the common for pin 3.

The Inhibit Input function lets an external input signal control the output state of all of the output channels in the mainframe. When the Inhibit input is true, the outputs are disabled. The signal latency is 5 microseconds. The Inhibit mode can be programmed Latching or Off.

Front Panel:	SCPI Command:
Select System\IO\DigPort\Pin3.	To configure the Inhibit function: DIG:PIN3:FUNC INH
Select Function, then Inhibit In.	To select the inhibit input polarity: DIG:PIN3:POL POS
Go back one level, select Polarity, then either Positive or Negative.	To latch the inhibit signal: OUTP:INH:MODE LATC
Select either Latching, or to disable the pin, select Off.	To disable the inhibit signal: OUTP:INH:MODE OFF

Output channels can only be disabled by the inhibit signal if they have previously been turned on by the OUTPut:STATe command or by the front panel On/Off switch. If an output channel is turned on while the Inhibit input is true, the output channel will remain off.

When the Inhibit signal turns off the outputs, the front panel INH indicator comes on and the INH bit is set in the Questionable Status Event register. Note that the Inhibit input signal remains latched until it is cleared.

Fault/Inhibit System Protection

The following figure illustrates how you can connect the FLT and INH pins to coordinate the Fault/Inhibit protection functions across multiple mainframes.

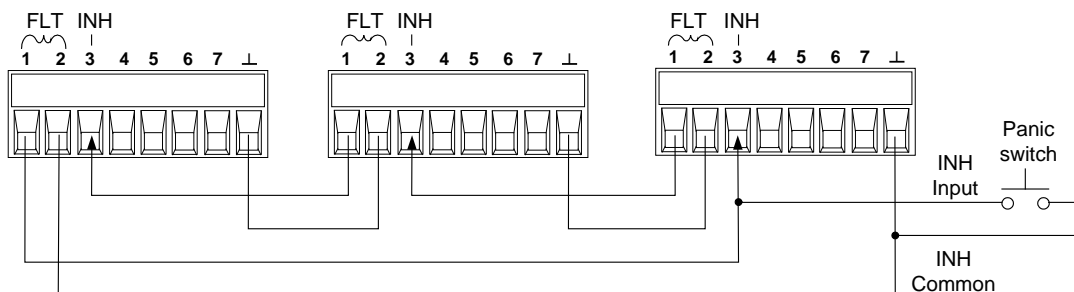

As shown in the previous figure, when the Fault outputs and Inhibit inputs of several mainframes are daisy-chained, an internal fault condition in one of the mainframes will disable all of them without intervention by either the controller or external circuitry. You must select the **same** polarity (either positive or negative) for all FLT and INH pins in the daisy chain.

You can also connect the Inhibit input to a manual switch or external control signal that will short the Inhibit pin to common whenever it is necessary to disable all output channels in the mainframe. **Negative** polarity must be programmed for all FLT and INH pins in this case. You can also use the Fault output to drive an external relay circuit or signal other devices whenever a user-definable fault occurs.

Clearing a System Protection Fault

To restore all instruments to a normal operating condition when a fault condition occurs, two fault conditions must be removed:

1. The initial protection fault or external inhibit signal.
2. The daisy-chained FLT signal that is sourced by the latched INH signal.

NOTE

Even when the fault condition or external signal is removed, the INH signal is still active and will continue to shut down the outputs of the mainframes.

To clear the daisy-chained fault signal when the Inhibit input is latched, turn off the Inhibit input on ALL mainframes individually. To re-enable the chain, the Inhibit input on each mainframe must be re-programmed to Latched mode.

Output On/Off Couple

This function lets you connect multiple Keysight E4360 mainframes together and have the output On/Off state coupled across mainframes. The following figure shows pins 6 and 7 configured as output couple pins.

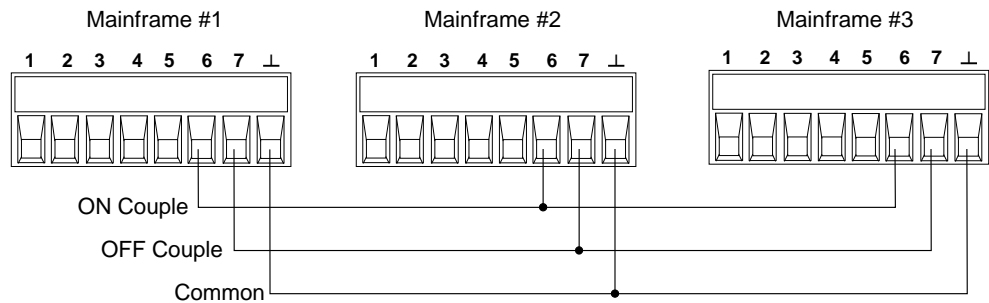

Output coupling must be enabled on all mainframes that will have one or more of their outputs coupled.

Front Panel:	SCPI Command:
In the front panel menu, select Output\Couple .	To enable, send: OUTP:COUP ON
Check the box labeled "Enable". To disable, un-check the box.	To disable, send: OUTP:COUP OFF
Check which channels will be coupled. To remove a channel, un-check the box.	To specify a channel or channels: OUTP:COUP:CHAN 1, 2

Only pins 4 through 7 can be configured as output state controls. Only two of the pins can be configured as "ONCouple" and "OFFCouple" on each mainframe. The designated pins will function as both an input and an output, with a negative transition on one pin providing the On/Off signal to the other pins. The polarity of the pins is not programmable.

Front Panel:	SCPI Command:
For mainframe #1, select System\IO\DigPort\Pin6 . Select Function, then ONCouple.	To configure pin 6 of mainframe #1 as the ON control: DIG:PIN6:FUNC ONC
Select Pin7 , then select Function, then OFFCouple.	To configure pin 7 of mainframe #1 as the OFF control: DIG:PIN7:FUNC OFFC
Repeat these steps for mainframes #2 and #3.	Repeat these commands for mainframes #2 and #3.

Connect the digital connector pins of the mainframes that contain the coupled outputs together as shown in the following figure. In this example, pin 6 is configured as the output On control. Pin 7 is configured as the output Off control. The ground or Common pins are also connected together.

Output Coupling Operation

Once configured and enabled, turning the output on or off on *any* coupled channel will cause *all* coupled channels on all configured mainframes to turn on or off. This applies to the front panel On/Off key, the Web server, and to SCPI commands.

If a mainframe has its ON/OFF key coupled (located in the **System\Preferences\Keys** menu), turning the output on or off on *any* coupled channel will cause all coupled channels as well as non-coupled channels *on that mainframe* to turn on or off.

Appendix C

SCPI Commands

SCPI Command Summary.....	104
---------------------------	-----

This appendix gives the list of SCPI commands that are used to program the Keysight E4360A Solar Array Simulator.

NOTE

For complete details on programming the instrument using SCPI commands, refer to the Keysight 14360A Programmer's Reference Guide available at <http://www.keysight.com/find/E4360> under Technical Support.

SCPI Command Summary

NOTE

Some [optional] commands have been included for clarity. All settings commands have a corresponding query. Not all commands apply to all models.

SCPI Command	Description
ABORt	
[:TRANsient] [(@chanlist)]	Resets the transient trigger system to the Idle state
:ACQuire [(@chanlist)]	Resets the measurement trigger system to the Idle state
:DLOG [(@chanlist)]	Stops the currently running datalog
CALibrate	
:CURRent	
[:DATA] <NRf>	Enters the calibration value
:LEVel P1 P2, (@channel)	Calibrates the output current programming
:PROTection (@channel)	Calibrates the over-current protection
:DATE <SPD>, (@channel)	Sets the calibration date
:PASSword <NRf>	Sets the numeric calibration password
:SAVE	Saves the new cal constants in non-volatile memory
:STATE <Bool> [, <NRf>]	Enables/disables calibration mode
:VOLTag	
[:DATA] <NRf>	Enters the calibration value
:LEVel P1 P2, (@channel)	Calibrates the output voltage programming
:PROTection (@channel)	Calibrates the over-voltage protection
DISPlay	
[:WINDow]	
:TEXT <SPD>	Sends the text to be displayed on the front panel
:VIEW CHAN1 CHAN2 ALL TEXT	Selects the channels displayed in meter view
:ENABle <Bool>	Enables/disables the front panel display
FETCh	
[:SCALar]	
:CURRent[:DC]? [(@chanlist)]	Returns the output current
:VOLTag[:DC]? [(@chanlist)]	Returns the output voltage
DLOG [(@chanlist)]	Returns measurements from the datalog buffer
FORMat	
[:DATA] ASCII REAL [, (@chanlist)]	Selects transferred data format
:BORder NORMal SWApped [, (@chanlist)]	Specifies how binary data is transferred
INITiate	
[:IMMEDIATE]	
[:TRANsient] [(@chanlist)]	Enables output triggers
:ACQuire [(@chanlist)]	Enables measurement triggers
:DLOG [(@chanlist)]	Enables the datalogger
:CONTinuous	
[:TRANsient] <Bool> [, (@chanlist)]	Enables/disables continuous transient triggers
MEASure	
[:SCALar]	
:CURRent[:DC]? [(@chanlist)]	Takes a measurement; returns the output current
:VOLTag[:DC]? [(@chanlist)]	Takes a measurement; returns the output voltage

SCPI Command	Description
MEMory	
:COPY:TABLE <CPD>	Copies the selected table to non-volatile memory
:DElete	
[:NAME] <CPD>	Deletes the specified table in volatile/non-volatile memory
:ALL	Deletes all tables in volatile and non-volatile memory
:TABLE	
:CATalog?	Returns all table names in volatile/non-volatile memory
:CURRent	
[:MAGnitude] <NRf>{,<NRf>}	Programs a list of current points for a new table
:POINts?	Returns the number of current points in the active table
:SElect [<CPD>]	Creates a new table in volatile memory
:VOLTage	
[:MAGnitude] <NRf>{,<NRf>}	Programs a list of voltage points for a new table
:POINts?	Returns the number of voltage points in the active table
OUTPut	
[:STATe] <Bool> [,(@chanlist)]	Enables/disables the specified output channel(s)
:COUple	
[:STATe] <Bool>	Enables/disables channel coupling for output sync
:CHANnel [<NR1> {,<NR1>}]	Selects which channels are coupled
:INHibit :MODE LATChing OFF	Sets the remote inhibit mode
:PON:STATe RST RCL0	Programs the power-on state
:PROTection	
:CLEar [(@chanlist)]	Resets latched protection
:COUple <Bool>	Enables/disables channel coupling for protection faults
:OT	
:AMBient:MARGin? [,(@chanlist)]	Returns the margin between ambient and OT trip temp
:TUNNel:MARGin? [,(@chanlist)]	Returns the margin between heat sink and OT trip temp
SENSe	
:DLOG	
:CLOCK TRIGger TIMer [,(@chanlist)]	Specifies the measurement capture trigger source
:TINTerval <NRf> [,(@chanlist)]	Sets the time interval for capturing measurements
[SOURce:]	
CURRent	
[:LEVel]	
[:IMMediate]::AMPLitude] <NRf+> [,(@chanlist)]	Sets the output current in Fixed mode
:DTABLE	
:SASimulator	
[:IMMediate]? [(@chanlist)]	Returns the calculated DAC table used for the SAS settings
[:IMMediate]:IMP? [(@chanlist)]	Returns the calculated DAC table Imp value
[:IMMediate]:ISC? [(@chanlist)]	Returns the calculated DAC table Isc value
:LIST? <NR1> [,(@chanlist)]	Returns the calculated DAC table used for the step
:LIST:IMP? <NR1> [,(@chanlist)]	Returns the calculated DAC table Imp value for the step
:LIST:ISC? <NR1> [,(@chanlist)]	Returns the calculated DAC table Isc value for the step
:TABLE	
[:IMMediate]? <CPD> [,(@chanlist)]	Returns the calculated DAC table used for the table
[:IMMediate]:IMP? <CPD> [,(@chanlist)]	Returns the calculated DAC table Imp value for the table
[:IMMediate]:ISC? <CPD> [,(@chanlist)]	Returns the calculated DAC table Isc value for the table
:MODE FIXed SAS TABLE [,(@chanlist)]	Sets the operating mode of the instrument
:DTABLE 256 4096 [,(@chanlist)]	Specifies the size of the table in points
:PROgramming INTernal EXTernal	Specifies the programming source in auto-parallel operation
[,(@<chanlist>)]	

SCPI Command	Description
:PROtection [:LEVel] <NRf+> [,@chanlist]	Sets the over-current protection level
:SAS :IMP <NRf> [,@chanlist] :ISC <NRf> [,@chanlist] :MODE IMMEDIATE LIST [,@chanlist]	Sets the current at the peak power point of the curve Sets the short-circuit current Selects the source of the curve parameters
:SLIMit :HIGH <NRf+> MAXimum [,@chanlist]	Sets the high soft limit for programming the output current
:TABLE :NAME <CPD> [,@<chanlist>] :OFFSet <NRf> [,@<chanlist>]	Activates a user-defined table in Table mode Adds a current offset when operating in Table mode
DIGital :INPut:DATA? :OUTPut:DATA <NRf> :PIN<1-7> :FUNction DIO DINPut TOUTput TINPut FAULt INHibit ONCOuple OFFCOuple :POLarity POSitive NEGative	Reads the state of the digital port pins Sets the digital port Sets the selected pin's function Sets the selected pin's polarity
LIST :COUNT <NRf+> INFinity [,@chanlist] :DWELL <NRf> {,<NRf>} [,@chanlist] :POINts? [(@chanlist)]	Sets the list repeat count Sets the list of dwell times Returns the number of dwell list points
:SAS :IMP [:LEVel] <NRf>{,<NRf>} [,@chanlist] :POINts? (@chanlist) :ISC [:LEVel] <NRf>{,<NRf>} [,@chanlist] :POINts? (@chanlist) :VMP [:LEVel] <NRf>{,<NRf>} [,@chanlist] :POINts? (@chanlist) :VOC [:LEVel] <NRf>{,<NRf>} [,@chanlist] :POINts? (@chanlist)	Sets the list of peak power current points Returns the number of peak power current points Sets the list of short-circuit current points Returns the number of short-circuit points Sets the list of peak power voltage points Returns the number of peak power voltage points Sets the list of open-circuit voltage points Returns the number of open-circuit points
:STEP ONCE AUTO [,@chanlist] :ACTive? [(@chanlist)]	Specifies how the list responds to triggers Returns the present list step
:TERMinate :LAST <Bool> [,@chanlist]	Sets the list termination mode
POWer :LIMit? [,@chanlist]	Returns the power limit of the module
VOLTage [:LEVel] [:IMMEDIATE][:AMPLitude] <NRf+> [,@chanlist]	Sets the output voltage in Fixed mode
:DTABLE :SASimulator [:IMMEDIATE]? [(@chanlist)] [:IMMEDIATE]:VMP? [(@chanlist)] [:IMMEDIATE]:VOC? [(@chanlist)] :LIST? <NR1> [,@chanlist] :LIST:VMP? <NR1> [,@chanlist] :LIST:VOC? <NR1> [,@chanlist]	Returns the calculated DAC table used for the SAS settings Returns the calculated DAC table Vmp value Returns the calculated DAC table Voc value Returns the calculated DAC table used for the step Returns the calculated DAC table Vmp value for the step Returns the calculated DAC table Voc value for the step
:TABLE [:IMMEDIATE]? <CPD> [,@chanlist] [:IMMEDIATE]:IMP? <CPD> [,@chanlist] [:IMMEDIATE]:ISC? <CPD> [,@chanlist]	Returns the calculated DAC table used for the table Returns the calculated DAC table Imp value for the table Returns the calculated DAC table Isc value for the table

SCPI Command	Description
:PROTection [:LEVel] <NRf>, (@chanlist)	Sets the over-voltage protection level
:SAS :VMP <NRf>, (@chanlist) :VOC <NRf>, (@chanlist)	Sets the voltage at the peak power point of the curve Sets the open-circuit voltage
:SLIMit :HIGH <NRf+> MAXimum [, (@chanlist)]	Sets the high soft limit for programming the output voltage
:TABle :OFFSet <NRf> [, (@<chanlist>)]	Adds a voltage offset when operating in Table mode
STATus	
:OPERation [:EVENT]? [(@chanlist)] :CONDition? [(@chanlist)] :ENABle <NRf> [, (@chanlist)] :NTRansition <NRf> [, (@chanlist)] :PTRansition <NRf> [, (@chanlist)]	Returns the value of the operation event register Returns the value of the operation condition register Enables specific bits in the Event register Sets the Negative transition filter Sets the Positive transition filter
:PRESet	Presets all enable and transition registers to power-on
:QUEStionable [:EVENT]? [(@chanlist)] :CONDition? [(@chanlist)] :ENABle <NRf> [, (@chanlist)] :NTRansition <NRf> [, (@chanlist)] :PTRansition <NRf> [, (@chanlist)]	Returns the value of the questionable event register Returns the value of the questionable condition register Enables specific bits in the Event register Sets the Negative transition filter Sets the Positive transition filter
SYSTEM	
:CHANnel [:COUNT]? :MODEl? [(@chanlist)] :OPTion? [(@chanlist)] :SERial? [(@chanlist)]	Returns the number of output channels in a mainframe Returns the model number of the selected channel Returns the option installed in the selected channel Returns the serial number of the selected channel
:COMMunicate :RLState LOCAL REMote RWLock	Specifies the Remote/Local state of the instrument
:ERRor?	Returns the error number and error string
:GROup :CATalog? :DEFine [(@chanlist)] :DELeTe <channel> :ALL :PARAllel AUTO DIRect [, (@chanlist)]	Returns the groups that have been defined Group multiple channels together to create a single output Removes the specified channel from a group Ungroups all channels Specifies how output modules are connected in parallel
:MMEMory :INITialize	Initializes the instrument's memory to the factory-default settings
:SANitize	Implements the sanitizing standard DoD 5220.22-M
:PASSword :FPANel :RESet	Resets the front panel lock password to zero
:REBoot	Returns the unit to its power-on state
:VERSion?	Returns the SCPI version number
TRIGger	
[:TRANsient] [:IMMEDIATE] [(@chanlist)] :SOURce	Triggers the output immediately Sets the output trigger source
BUS DWEL<n> PIN<n> TRAN<n>[, (@chanlist)]	

SCPI Command	Description
:ACQuire [:IMMEDIATE] [(@chanlist) :DElay <NRf> [,@chanlist) :SOURce BUS PIN<n> TRAN<n> [,@chanlist)]	Triggers the measurement immediately Specifies a time delay for the measurement trigger Sets the measurement trigger source
:DLOG [:IMMEDIATE] [(@chanlist) :SOURce	Triggers the datalog immediately Sets the datalog trigger source
BUS DLOG<n> PIN<n> TRAN<n> [,@chanlist] :PIN<3-7> :SOURce	Selects the trigger source for the digital I/O pin
BUS ACQ<n> DLOG<n> DWEL<n> TRAN<n>	

Common Commands

Command	Description	Command	Description
*CLS	Clear status	*RST	Reset
*ESE <NRf>	Standard event status enable	*SAV <NRf>	Saves an instrument state
*ESR?	Return event status register	*SRE <NRf>	Set service request enable register
*IDN?	Return instrument identification	*STB?	Return status byte
*OPC	Enable "operation complete" bit in ESR	*TRG	Trigger
*OPT?	Return option number	*TST?	Selftest
*RCL <NRf>	Recalls a saved instrument state	*WAI	Pauses additional command processing until all device commands are done
*RDT?	Return output channel descriptions		

*RST Settings

These settings are set by the *RST (Reset) command			
CAL:STAT	OFF	[SOUR:]LIST:SAS:VOC	65 E4361A; 130 E4362A
[SOUR:]CURR	0	[SOUR:]LIST:STEP	AUTO
[SOUR:]CURR:MODE	FIX	[SOUR:]LIST:TERM:LAST	OFF
[SOUR:]CURR:PROT:LEV	1.1 X MAX	MEM:TABL:CURR	0
[SOUR:]CURR:SAS:IMP	0.8 X MAX	MEM:TABL:VOLT	0
[SOUR:]CURR:SAS:ISC	MAX	OUTP	OFF
[SOUR:]CURR:SAS:MODE	IMM	OUTP:COUP	OFF
[SOUR:]CURR:TABL:OFFS	0	OUTP:PROT:COUP	OFF
[SOUR:]DIG:OUTP:DATA	0	TRIG:ACQ:DEL	0
DISP:ENAB	ON	TRIG:ACQ:SOUR	BUS
DISP:VIEW	METER1	TRIG:TRAN:SOUR	BUS
INIT:CONT:TRAN	OFF	TRIG:PIN:SOUR	NONE
[SOUR:]LIST:COUN	1	[SOUR:]VOLT	0
[SOUR:]LIST:DWEL	0.025	[SOUR:]VOLT:PROT	MAX
[SOUR:]LIST:SAS:IMP	6.528 E4361A; 3.264 E4362A	[SOUR:]VOLT:SAS:VMP	0.8 X MAX
[SOUR:]LIST:SAS:ISC	8.7 E4361A; 5.1 E4362A	[SOUR:]VOLT:SAS:VOC	MAX
[SOUR:]LIST:SAS:VMP	60 E4361A; 120 E4362A	[SOUR:]VOLT:TABL:OFFS	0

Appendix D

Grouping/Compatibility

Output Grouping.....	110
Compatibility	112

This appendix described output grouping and compares the Keysight E4360 Modular SAS and the earlier version Keysight E4350B/E4351B SAS instruments.

Output Grouping

Almost all instrument functionality is supported by grouped channels, including voltage and current programming, measurements, status, SAS and Table modes. The following conditions apply for grouped channels:

- When output channels have been grouped, a single programming command will control both channels. A channel parameter is optional; as all commands are automatically sent to channel 1. You cannot send commands to channel 2.
- Outputs can only be grouped on individual mainframes.
- Output channels that are grouped must also be connected in parallel as described in chapter 2.
- The maximum output current is the sum of the maximum of each channel in the group.

Connect the Outputs

NOTE

If the output grouping is being used in either direct-parallel mode or auto-parallel mode, you must connect the outputs together as described in chapter 2 under “Direct-Parallel” or “Auto-Parallel”

For the firmware to correctly control the grouped channels, it needs to know whether the outputs are direct- paralleled or auto-paralleled. In auto-parallel mode, the firmware must know which mainframe contains the master output channel, and which mainframe has the follower output channels. This is explained in the next section.

Configure the Groups

NOTE

For the grouping commands to take effect, you must reboot the unit after completing steps 1 through 3. Either cycle AC power or send the `SYSTEM;REBoot` command”.

Step 1. Select the output channels you wish to group.

Front Panel:	SCPI Command:
Select System\Groups\Groups .	To group of channels 1 and 2:
Check channel 2 in Group 1.	<code>SYST:GRO:DEF (@1,2)</code>
To ungroup the channels, check channel 2 in Group 2.	To ungroup channels 1 and 2: <code>SYST:GRO:DEL (@2)</code>

Step 2. Specify whether the grouped outputs in a mainframe are wired in direct-parallel or auto-parallel.

Front Panel:	SCPI Command:
Select System\Groups\Parallel.	To specify auto-parallel: SYST:GRO:PAR AUTO, (@1)
Select either Direct or Auto.	To specify direct-parallel: SYST:GRO:PAR DIR, (@1)

When grouped channels are wired by direct-parallel, each channel is programmed to control its own output current with its internal circuitry. There is no requirement to designate any master or follower channel. Commands sent to the grouped channel will normally be applied to both channels by the firmware automatically. Commands that control the output current will be divided by ½ and applied to both channels.

NOTE If you are grouping outputs, in direct parallel, in *Fixed* mode, you must set the over-current protection of each output to its maximum setting. Otherwise the over-current protection will shut the outputs down. This occurs because output currents are not shared equally when outputs are grouped in Fixed mode.

Step 3. Note that this step is not required with direct-paralleled outputs.

If the grouped outputs are connected in auto-parallel, specify which mainframe has the master output, and which mainframe has the follower outputs.

Front Panel:	SCPI Command:
Select System\Groups\Programming.	To specify the mainframe that contains with the master output: CURR:MODE:PROG INT, (@1)
Select Internal to specify the mainframe with the master output.	To specify the mainframe with the follower outputs: CURR:MODE:PROG EXT, (@1)
Select External to specify the mainframe with follower outputs.	To

NOTE This command can only be programmed when the instrument is operating in Fixed mode. An error will be generated if this command is sent when the instrument is operating in SAS or in Table mode.

When grouped channels are auto-paralleled, the firmware will automatically designate channel 1 as the master channel and channel 2 as a follower. The automatic designation is required since there is no programming access to channel 2 once the channels are grouped.

When channels on two mainframes are grouped and auto-paralleled, one channel on one of the mainframes must be programmed as a master with the above commands while all other channels must be programmed as followers.

To program the output current of the auto-paralleled grouped channels, the master group must be programmed with 1/nth of the desired current, where n is the number of *groups* paralleled. The follower groups will generate the same current as signaled by the master group.

Other parameters for each paralleled group will require the same settings to be programmed. In Fixed mode, the same voltage level must be programmed to all groups. In SAS mode, the same model parameters or list step must be in effect for each group. If lists are used, each group must get the same list steps and triggering to cause the channels to change steps at the same time. In Table mode, the same table must be activated for each group.

For analog connector wiring, when the mainframe group contains the master output, channel 1 must be configured as a master and channel 2 as a follower. When the mainframe group contains only follower outputs, both output channels must be configured as followers.

Step 4. Reboot the unit for the grouping or ungrouping changes to take effect.

Front Panel:	SCPI Command:
Cycle AC power.	SYST:REB

Compatibility



Instrument and Module Addressing

The Keysight E4360 Modular SAS is comprised of two modules installed in a mainframe while the Keysight E4350B/E4351B SAS instruments have one output per instrument. Due to the multiple modules used in the E4360 SAS, a channel list is used when a channel-specific command is sent to the mainframe. For example, to set the voltage of channel 2 of an E4360 to 5 V, the command “VOLT 5, (@2)” would be used where the “,@2” specifies channel 2. For the E4360, if the channel list is omitted in a channel specific command (for example, “VOLT 5”), the channel will be assumed channel 1 and no error will be generated.

Because the channel list was not used with the E4350B/51B instruments, you would not be able to program channel 2 if you used the same program code that was developed for the E4350B/51B instruments. As a convenience, on the E4360 Modular SAS, you can group two outputs in the same mainframe to make them act, from a programming point of view, like a single, higher-power output channel as previously described. This applies when programming from the front panel or using SCPI commands. Commands sent without a channel parameter will be sent to both grouped channels.

Differences in General

The following table describes additional differences between the Keysight E4360 Modular SAS and the Keysight E4350B/51B SAS instruments. The major differences are in the physical size of the units. Regarding performance, the E4360 SAS is at least equal to and in most cases superior to the E4350B/51B instruments.

Item	E4350B/E4351B	E4360A Modular SAS
Rack unit dimensions	3 U	2 U
Height, Width, Depth	132.6mm, 425.5mm, 497.8 mm	88.9mm, 432.5mm, 608.5 mm
Rack mounting	Standard support rails and ears	Custom rack mount kit
Weight	25 kg	18.6 kg with two modules installed
AC input	100, 120, 220, 240 VAC nominal Voltages set by internal jumpers	100, 120, 220, 240 VAC nominal Universal input; no switch settings At 100/120 VAC nominal, maximum current is derated to half its rating.
Interfaces	GPIB, serial link	GPIB, LAN, USB, built-in Web server
Front panel controls	 <p>Individual keys for all functions</p>	 <p>Individual keys for main functions; extensive menu controls</p>
Output ratings	1 output; 480 W per output;	2 outputs; up to 600 W per output
Max. short-circuit current	8 A or 4 A (model dependent)	8.5 A or 5 A (model dependent)
+/- Output connections	Bus bar terminals	Part of 5-pin connector including +s, -s, +D
Diode terminal	Not available	Connects internal diode in series with + output
Remote/local sensing	Remote local switch	Jumpers installed from sense to output terminals
Digital IO	4 pins, INH, FLT, and IO functions only	8 pins, extensive functionality
Auto-parallel	Up to 3 outputs (3 units)	Up to 4 outputs (in 2 mainframes)
Curve lists	Not available	Generates pre-defined I-V curves Can contain up to 512 sets of points
Measurement (data) logging	Not available	64K buffer size
Over-current protection	OC - independently set for SAS and Table modes OCP - tied to current setting in Fixed mode	OC - independently set for all modes
Savable states	5 in Fixed mode only	2 mainframe states
Command processing time	20 ms	1 ms
Drivers	VXI plug&play	IVI-COM 14360A System Driver

Index

	+
+D terminal	29
	A
AC line	
connection	26
current restriction	26
admin menu	
password	83
air clearance	21
airflow	90
All	14, 57
analog port	
characteristics	28
auto-parallel	
configure	63, 110
Fixed mode	35
SAS mode	36
Table mode	36
	B
bench location	25
	C
calibration	85
Caution	3
CC	14
channel	
groups	80
location	22
numbering	22
select	40, 56
characteristics	
E4360A	88
cleaning	21
compatibility	
differences	112
module addressing	112
connections	
analog control	38
auto-parallel	35
direct-parallel	33
series	38
connector	
analog	27
digital	28
output	26
contrast	
front panel	82

control port, connector	96
control socket	53
couple protection	61
current	
setting	41, 57
current offset	75
curve list	67
initiate trigger	71
programming	69
trigger source	70
CV	14

D

data logging	76
fetch data	79
initiate	78
pacing	77
trigger	78
trigger source	77
data socket	53
DCL	53
default gateway	49
digital I/O	
connections	97
digital input	
connections	98
direct-parallel	
configure	63, 110
Fixed mode	34
SAS mode	33
Table mode	33
disassembly	22

E

E4360J01	12, 13
earth ground	30
environmental conditions	21
Err	14, 43
exponential model equations	92
external trigger	
connections	98

F

fault output	
connections	99
Fault/Inhibit	
clearing	101
connections	100
fetch commands	57
Fixed mode	56

Index

description..... 10
follower
 configure63, 111
frequency
 400 Hz..... 25
front panel
 contrast..... 82
 display..... 14
 keys..... 15
 lockout..... 81
 menus 16
 screen saver..... 82
 view 82
front panel menu
 exiting 43
 using..... 42

G

GPIB interface..... 44
 address 44
ground
 redundant 25
grouping 110
groups
 view 14

H

Help..... 42, 43
Hostname 49

I

INH 14, 61
inhibit input
 clearing..... 100
 connections..... 100
installation
 rack mounting 23
installing
 modules 22
instrument
 identification 80
 storing states..... 80
IO 14, 44
IP address 49
items supplied 20

L

Lan..... 14, 46
LAN..... 47
LAN interface 45
 parameters..... 48

private..... 47
 site 46
 sockets..... 53
 Telnet 53
list programming 67
loads
 capacitive..... 30
 connections..... 28
 grounding 30
 inductive 30
 multiple 29
 output isolation..... 30
lockout
 front panel..... 81

M

master
 configure63, 111
measure commands 57
measurement trigger
 delay 60
 generate 60
 initiate..... 59
 source 59
Menu..... 42
model
 differences..... 20
model numbers 20

N

non-volatile RAM settings 84

O

OC..... 14, 61
OFF 14
options 20
OS..... 14, 61
OT 14, 61
outline diagram 90
output
 enable 41, 57
 groups 80
output couple
 clearing..... 102
 state..... 101
output groups 110
 configure 110
OV 14, 61
over-current 61
over-switching..... 30, 61
over-voltage 61

over-voltage protection		
setting.....	42	
		P
parallel		
programming cautions	37	
password		
calibration.....	85	
changing	83	
front panel.....	81	
peak power tracker.....	91	
PF.....	14, 61	
power factor		
400 Hz.....	25	
power factor 400 Hz.....	89	
PROT.....	14, 61	
protection		
clearing.....	62	
couple	61	
functions	61	
overvoltage.....	32	
		R
rack mounting		
tools required	23	
rear panel		
connectors.....	26	
remote interface		
factory settings.....	84	
securing.....	83	
remote sensing.....	31	
removing		
modules	22	
reset states.....	108	
		S
safety.....	4	
sanitizing	85	
SAS mode	64	
curve list.....	67	
curve resolution	64	
curve restrictions.....	66	
description.....	10	
enable	65	
SAS mode, curve parameters.....	66	
SCPI		
common commands.....	108	
subsystem commands	104	
screen saver	82	
sense		
connections.....	31	
series switching regulation	93	
shunt switching		
frequency.....	30	
shunt switching regulation	93	
sockets.....	53	
soft limits.....	62	
SRQ	53	
stability	32	
storing states	80	
subnet mask.....	49	
supplemental characteristics	87	
		T
table memory		
restoring.....	85	
sanitizing.....	85	
table mode		
enable	73	
offset	75	
open.....	73	
program.....	74	
resolution	76	
restrictions	74	
select.....	73	
Table mode	72	
description.....	10	
Telnet.....	53	
		U
UNR.....	14	
USB interface.....	45	
		V
voltage		
regulation.....	31	
sensing	31	
setting.....	40, 57	
voltage offset	75	
		W
Warning	3	
Web server	51	
Web URL's	5	
wire selection.....	28	



This information is subject to change without notice.
© Keysight Technologies 2008 - 2018
Edition 8, December 2018
E4360-90001
www.keysight.com