

# Keysight N2902B Rack Mount Kit for S-Series and 9000 Series Oscilloscopes

Installation  
Guide

# Notices

© Keysight Technologies, Inc. 2014

No part of this manual may be reproduced in any form or by any means (including electronic storage and retrieval or translation into a foreign language) without prior agreement and written consent from Keysight Technologies, Inc. as governed by United States and international copyright laws.

## Manual Part Number

N2902-97002

## Edition

Second edition, October 2014

Printed in Malaysia

Published by:  
Keysight Technologies, Inc.  
1900 Garden of the Gods Road  
Colorado Springs, CO 80907 USA

## Warranty

**The material contained in this document is provided “as is,” and is subject to being changed, without notice, in future editions. Further, to the maximum extent permitted by applicable law, Keysight disclaims all warranties, either express or implied, with regard to this manual and any information contained herein, including but not limited to the implied warranties of merchantability and fitness for a particular purpose. Keysight shall not be liable for errors or for incidental or consequential damages in connection with the furnishing, use, or performance of this document or of any information contained herein. Should Keysight and the user have a separate written agreement with warranty terms covering the material in this document that conflict with these terms, the warranty terms in the separate agreement shall control.**

## Technology Licenses

The hardware and/or software described in this document are furnished under a license and may be used or copied only in accordance with the terms of such license.

## Restricted Rights Legend

If software is for use in the performance of a U.S. Government prime contract or subcontract, Software is delivered and licensed as “Commercial computer software” as defined in DFAR 252.227-7014 (June 1995), or as a “commercial item” as defined in FAR 2.101(a) or as “Restricted computer software” as defined in FAR 52.227-19 (June 1987) or any equivalent agency regulation or contract clause. Use, duplication or disclosure of Software is subject to Keysight Technologies’ standard commercial license terms, and non-DOD Departments and Agencies of the U.S. Government will receive no greater than Restricted Rights as defined in FAR 52.227-19(c)(1-2) (June 1987). U.S. Government users will receive no greater than Limited Rights as defined in FAR 52.227-14

(June 1987) or DFAR 252.227-7015 (b)(2) (November 1995), as applicable in any technical data.

## Safety Notices

### CAUTION

A **CAUTION** notice denotes a hazard. It calls attention to an operating procedure, practice, or the like that, if not correctly performed or adhered to, could result in damage to the product or loss of important data. Do not proceed beyond a **CAUTION** notice until the indicated conditions are fully understood and met.

### WARNING

A **WARNING** notice denotes a hazard. It calls attention to an operating procedure, practice, or the like that, if not correctly performed or adhered to, could result in personal injury or death. Do not proceed beyond a **WARNING** notice until the indicated conditions are fully understood and met.

## In This Guide

This guide contains instructions for installing the Keysight N2902B Rack Mount Kit. The rack mount kit provides a support shelf and hardware for mounting Infiniium S-Series and 9000 Series oscilloscopes into Electronic Industries Association (EIA) standard 19-inch (487-mm) rack cabinets.

### Included Parts

The rack mount kit includes the following parts:

- Support tray
- Trim plate (consists of a bottom piece, top piece, and two side pieces)
- BNC connectors to be inserted into the bottom trim plate
- Black rubber stoppers to plug holes in bottom trim plate if the hole is not being used for a BNC connection
- Two track rails
- Two feet brackets
- Sheet metal nuts
- Four sets of screws: cream-colored pan head screws for attaching the trim plate pieces, metallic pan head screws for attaching the side rails to the rack, metallic M4 screws for attaching the feet brackets to the support tray, and another set of M4 screws for attaching the feet brackets to the oscilloscope.

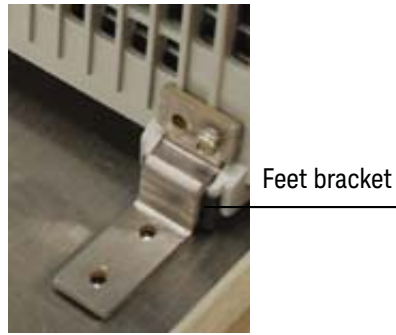
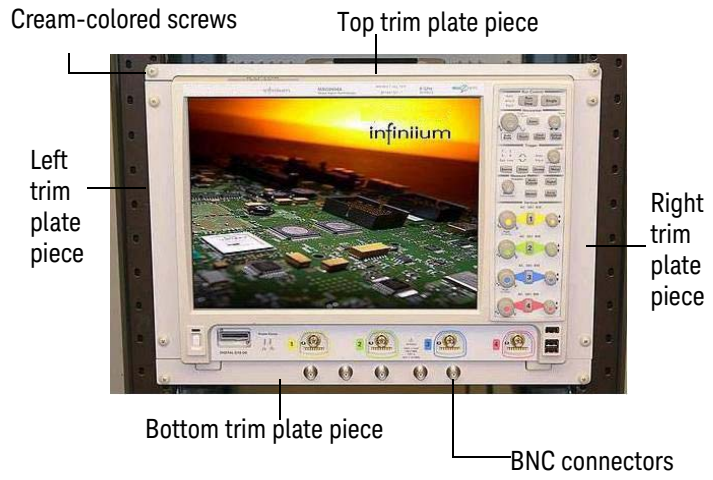

## Installation

The following tools are required for installing the rackmount kit:

- T20 Torx driver
- #2 Phillips screwdriver

### Preparing the Rack

- 1 To prepare the rack for sheet metal nut installation, eight rack mount units must be designated for use. The following diagram shows how to determine a rack unit.

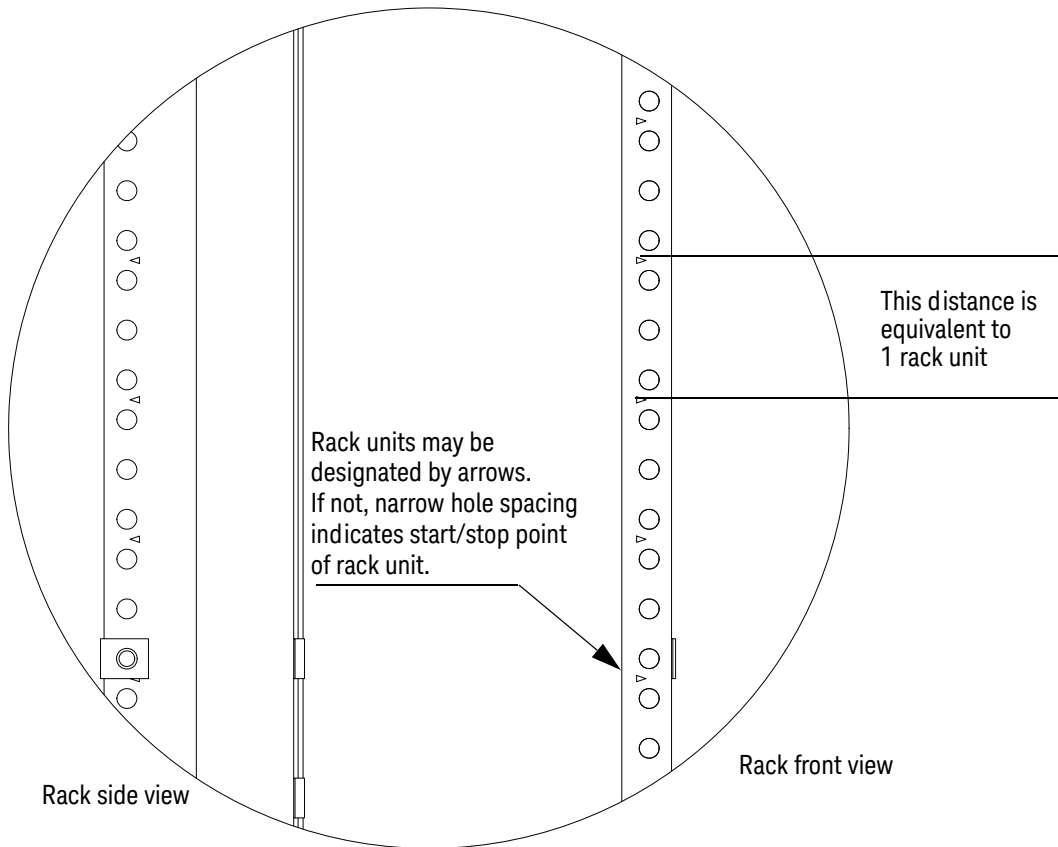

The following figure indicates proper locations for sheet metal nut locations. To ensure a level installation, the same eight rack unit locations are used on each vertical rack piece. NOTE: The picture shows only seven rack units.

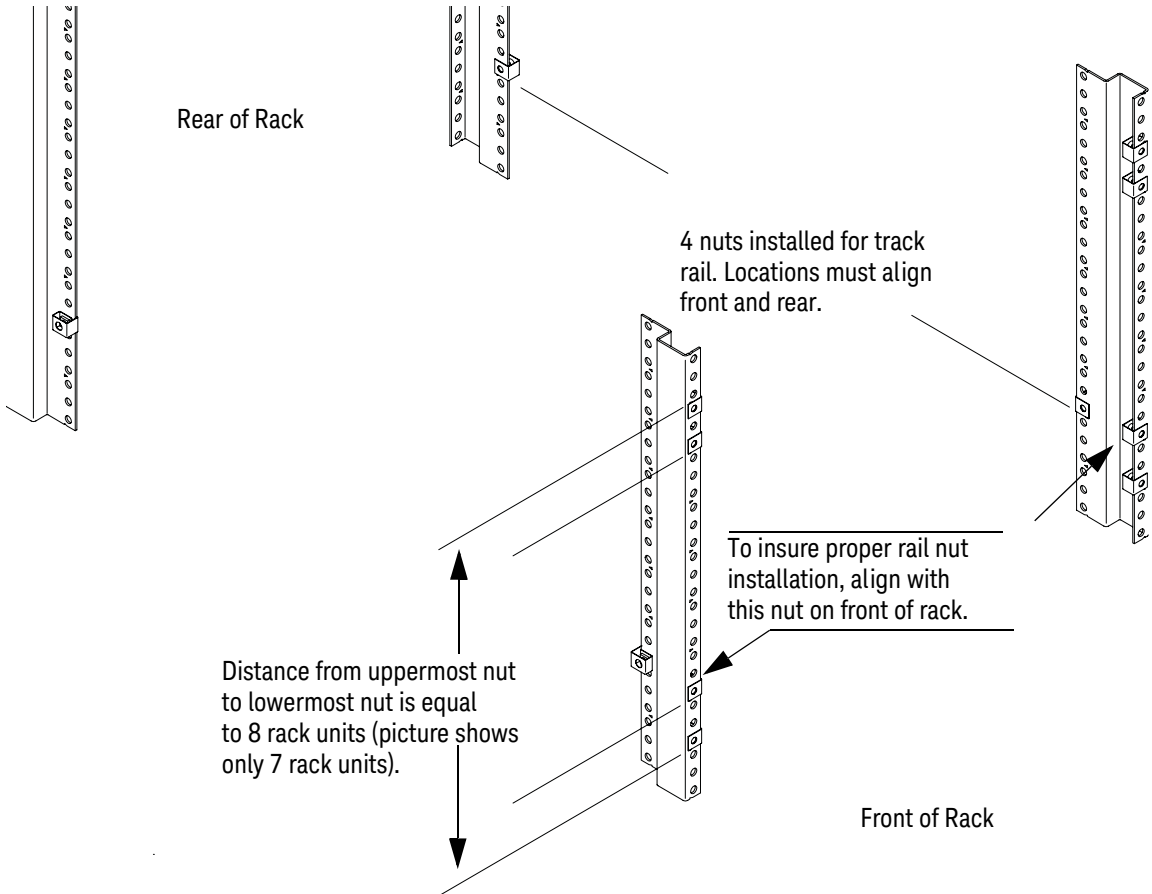

- 2 Attach the track rails to the rack using the four 10-32 pan head screws provided and a #2 Phillips screwdriver.

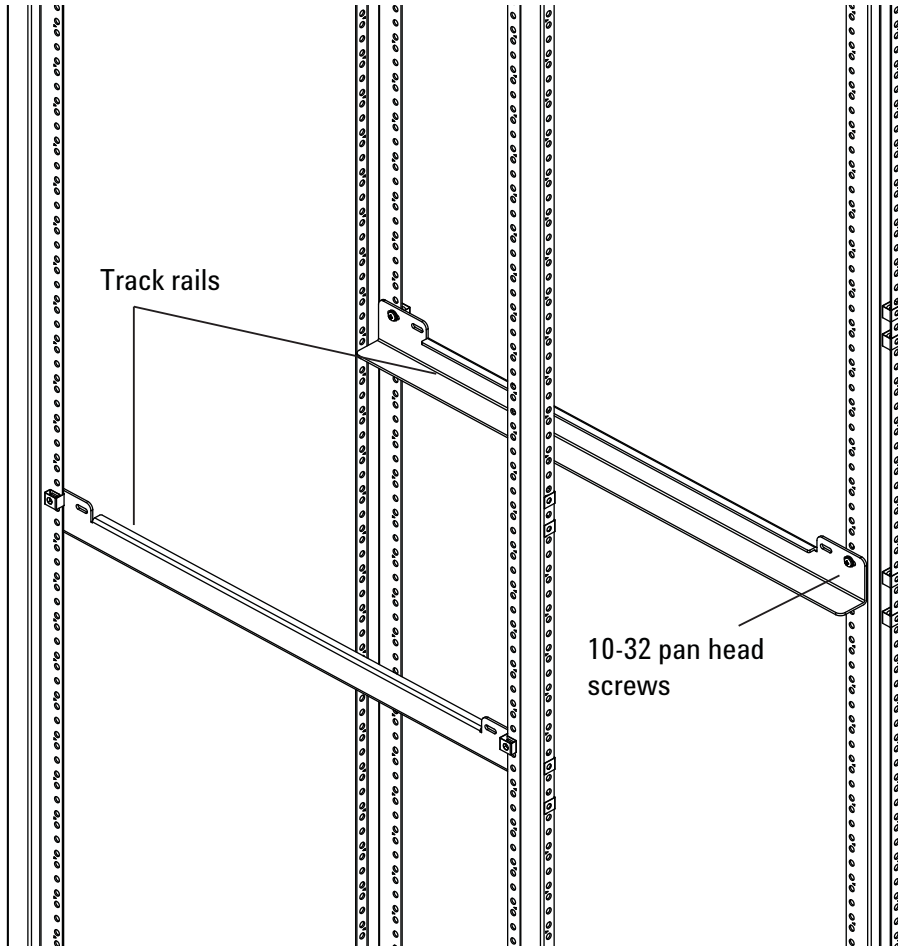

## Installing the Oscilloscope into the Rack

- 1 Remove the two M4 screws from the rear panel of the oscilloscope.

Remove screws



- 2 Attach the feet brackets to the oscilloscope using the two supplied M4 16mm screws.





- 3 Place the support tray onto a table, then place the oscilloscope onto the support tray. Line up the feet bracket screw holes with the holes in the support tray.



Line up screw holes

- 4 Attach cables to the side panel BNC connectors on the oscilloscope and route them under the oscilloscope through the indentation in the support tray. (Later, these cables will be connected to the bottom trim plate BNC connectors so you can have access to these BNCs once the oscilloscope is installed in the rack.) Let the end of the cables that pass under the oscilloscope just dangle for now. In a later step you will attach them to the bottom trim plate BNCs.
- 5 Plug the power cord into the oscilloscope and route it through the back so you can plug it into a power outlet after installation.

- 6 Use two M4 screws to secure each foot bracket to the support tray.



- 7 The oscilloscope and support tray should now look like the following picture except you may have cables connected to the side panel BNCs if you chose to attach them.



- 8 Move the oscilloscope and support tray over to the rack. Using the rails, slide the tray into the rack.
- 9 Connect the other end of each of the cables you routed under the oscilloscope to one of the BNC connectors in the bottom trim plate piece as shown below. If you do not want to install all five BNC connectors into the openings in the bottom face plate, you can fill the holes with the supplied rubber stoppers.



- 10 Attach the bottom trim plate piece to the rack using two cream-colored pan head screws. Then attach the side trim plate pieces using two cream-colored pan head screws on each side. NOTE: When attaching the side face plate pieces, be sure the screw holes are located toward the outside.
- 11 Attach the top trim plate piece to the rack with two cream-colored pan head screws, being sure that it slides into the notch on the top of the oscilloscope.

The top trim plate fits into this notch.

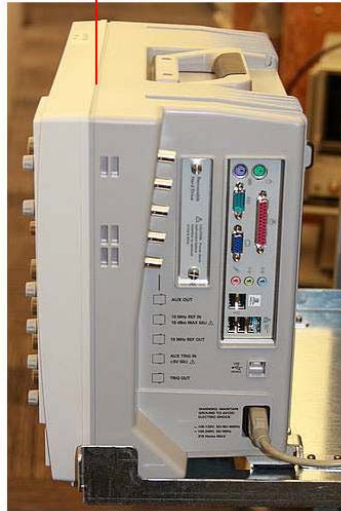

The oscilloscope is now fully installed and should look similar to the following picture.



## Dimensions

The following table shows the approximate dimensions for the rack mount trim plate pieces.

Side trim plate pieces	Bottom trim plate piece	Top trim plate pieces
▪ Height: 31.1 cm (12.24 in)	▪ Width: 48.3 cm (19 in)	▪ Width: 48.3 cm (19 in)
▪ Width: 2.5 cm (0.985 in)	▪ Height: 2.84 cm (1.12 in)	▪ Height: 1.57 cm (0.62 in)

The following diagrams show the dimensions of an Infiniium S-Series oscilloscope in an N2902B rack mount.

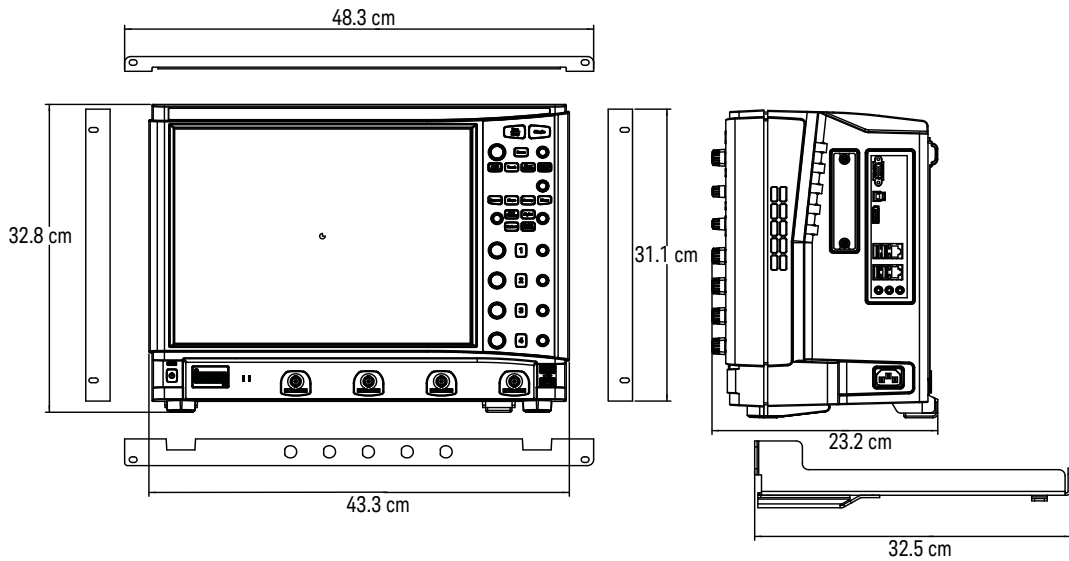

This information is subject to change  
without notice.

© Keysight Technologies, Inc. 2014

Printed in Malaysia  
Second edition, October 2014



N2902-97002  
[www.keysight.com](http://www.keysight.com)