

STATIC SOLUTIONS

Reliable performance even in a severe environment.





Contents

- Fan Type 240 - 241
- Gun Type / Nozzle Type 242 - 244
- Stat Buster 245
- Bar Type 246 - 249
- Ion Parts Cleaner 251 - 253
- EPA Systems 254 - 258
 - Conductive Rubber Mat 255
 - Electrostatic Field Meter / Surface Resistance Checker 256
 - EPA Floor Sheet 257 - 258
- Clean Walker 259 - 260

HAND TOOLS

BITS & SOCKETS

ELECTRIC TOOLS

AIR TOOLS

STATIC SOLUTIONS

GASOLINE ENGINE TOOLS

STATIC SOLUTIONS TECHNICAL

Butterfly louvers for dispersing ions toward different directions; straight or wide.



Fan type (electrostatic neutralization)

F-6R

Being compact, it is suitable for incorporation into a system. The F-6 with a clip can be clipped onto pipe of a cell production area and used for static elimination of part shelves or nearby working areas.

241P

F120R/S

This is the popular model of bench-top type, supporting a wide range of applications, from assembling into a unit, to at-hand work. The air flow direction through the louvers can be switched.

241P

CF300-E

This type supports static elimination from wide areas. It adopts a cross-flow fan. It can be installed in an area close to a conveyor or transfer system to remove static electricity from charged objects.

241P



Operation lamp enabling the status to be seen at a glance



Nozzle type (Electrostatic neutralization and dust removal)

This type enables a pinpoint elimination of static electricity and dust from charged objects.

It is suitable for installation in equipment or for transfer equipment, including transfer apparatus such as vibratory bowl feeders.

244P



Environmental measures

RoHS

Pb (lead) / Cd (cadmium) / Hg (mercury) / Hexavalent chromium / PBB (polybrominated biphenyl) / PBDE (polybrominated diphenyl ether) / DEHP, BBP, DBP, DIBP (phthalate esters)

The products with this mark in this catalogue are compliant with the RoHS directives (EU) (usage limit of the above 10 substances).

Note: For the updated information on RoHS compliant products, visit our homepage, because some products or sizes are under investigation or are not compliant at the time of publication of this catalogue.

Ion creation method

AC high frequency

Electrostatic eliminators adopting a high-frequency transformer of 20 kHz to 70 kHz have the features of stable ion balance.

Ion balance(F-120R)

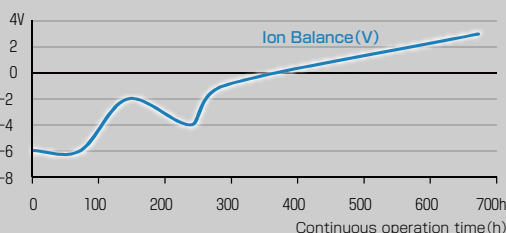

Decay Time(F-120R)

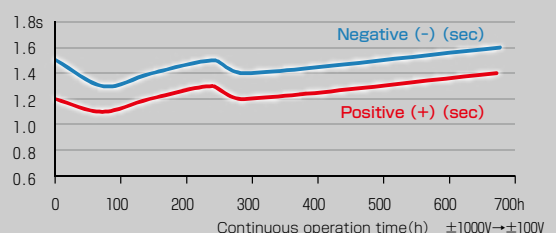

Cautions : Performance varies depending on various conditions such as temperature, humidity, and atmospheric pressure. These pieces of data are our measured values for reference and do not imply the guarantee of the same product performance.

HAND TOOLS

BITS & SOCKETS

ELECTRIC TOOLS

AIR TOOLS

STATIC SOLUTIONS

GASOLINE ENGINE TOOLS

LED light that makes dust visible.



Gun type (dust removal)

A hand-held static eliminator intended primarily for dust removal. It adopts a piezoelectric transformer that is lightweight, compact, and high safety.

243P

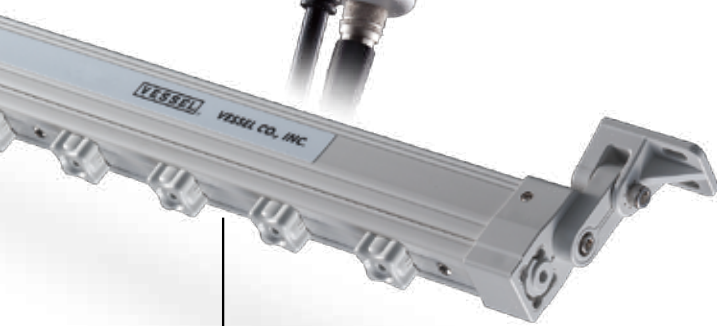

Bar type (Electrostatic neutralization, air assist ... dust removal)

This is a bar-type electrostatic eliminator provided with diverse width sizes. It adopts the AC pulse system, allowing you to select an optimal model according to the distance to a charged article.

247P
~249P

AC pulse

A pulse AC system that generates positive and negative ions alternatively from individual electrodes. It creates ions in maximum periodic widths of respective positive and negative electrodes; the amount of ions is large, enabling quick electrostatic elimination to be achieved.

AC pulse

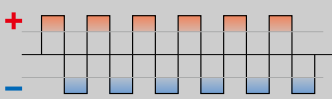

General alternating current

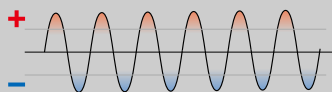

Ion parts cleaner (Electrostatic neutralization, dust removal)

This is a new method of cleaning parts known as ion cleaning. It is capable of performing ion air-based static elimination and dust collection + dust absorption simultaneously.

252P
253P

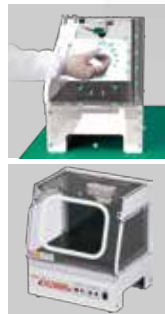

HAND TOOLS

BITS & SOCKETS

ELECTRIC TOOLS

AIR TOOLS

STATIC SOLUTIONS

GASOLINE ENGINE TOOLS

Ionizing Fan



This type adopts a piezoelectric transformer that is safe and superior in ion generation. In addition, VESSEL's specific capacitive coupling method in which a discharge needle is sandwiched with resin and stainless disc, enables unmatched good ion balance.

Convenient functions such as external output terminals, butterfly louver capable of switching the airflow directions, either straight or wide area.

Butterfly Louver

Press outer side to disperse air.
Press center to let air out straight.

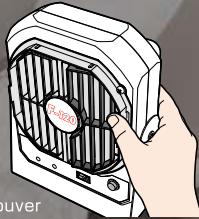

Butterfly Louver



No. F120R-E Ionizing Fan

Cell production in which compactness and easiness to install at setup are important; Integrated In-line process that outputs alarms while maintaining ion balance; VESSEL fan-type ionizers can remove static electricity in an efficient way.

No. F-6R Ionizing Mini Fan

Ionizing method: Piezoelectric high-frequency AC corona discharge Applied voltage: 3.5kVAC

- Compact and lightweight body
- Fan speed can be adjusted in two steps.
- Provided with a clip suitable for mounting (F6RCL-E)
- Provided with a general-purpose stand (F6RST-E)



CE

Model No.	Power supply	Current consumption (mA) typ.	Decay time	Ion balance	Noise level (dBA)	Fan speed (max) (m/min)	Weight (g)	EDP No.
F6RCL-E	24VDC±5%	210	within 3 sec	within ±10V	53	0.78	514	621663
F6RST-E	24VDC±5%	210	within 3 sec	within ±10V	53	0.78	460	621662

(Decay time and ion balance: 150mm from the front of a device and max. fan speed, Noise: 1m from the front of a device and max. air speed, Weight: including clip/stand)
 *Accessories: AC adapter AD24-ITF6E (100 to 240V AC), AC input cable (1.8m)

No. F120R/S Ionizing Fan

Ionizing method: Piezoelectric high-frequency AC corona discharge Applied voltage: 10kVAC (p-p)

- Newly developed piezoelectric transformer makes the slim and compact model.
- Butterfly louvers for changing the airflow directions.
- Fan speed can be adjusted in three steps.
- Improvement in maintenance by easy-replaceable electrode needle unit.
- Equipped with terminals for alarm signal output, convenient for incorporation into equipment.
- F120S-E is a silent type with mild airflow.



Model No.	Power supply	Current consumption (mA) max.	Decay time	Ion balance	Noise level (dBA)	Fan speed (max) (m/min)	Weight (g)	EDP No.
F120R-E	24VDC±5%	700	within 1.5 sec	within ±10V	55	3.66	900	621650
F120S-E	24VDC±5%	500	within 2.5 sec	within ±10V	51	2.21	900	621646

(Decay time and ion balance: 300mm from the front of a device and max. fan speed Noise: 1m from the front of a device and max. air speed)
 *Accessories: AC adapter AD24-ITE (100 to 240V AC) AC cable (1.8m)
 *Option: Filter set F-120FS, Filter F-12EF

No. CF300-E Cross-flow Ionizing Fan

Ionizing method: Piezoelectric high-frequency AC corona discharge Applied voltage: 9.2kVAC (p-p)

- Superior ionizing performance accomplished with the cross flow fan that sends out ions evenly and widely on the wind and the front cover design that takes the ion flow into consideration. Volume operation allows the non-step adjustment of airflow.
- Slide-type cleaning brush is mounted on the front cover to perform maintenance of needle electrodes at any time. On the bottom surface of the main body, a rough filter is used, which is easy to clean and replace.
- Monitoring functions of fan motor rotation monitoring function and high voltage output
- Shut-down function.



Model No.	Power supply	Current consumption (mA) max.	Decay time	Ion balance	Noise level (dBA)	Fan speed (max) (m/min)	Weight (g)	EDP No.
CF300-E	24VDC ±10%	500	within 1.5 sec	within ±10V	48	2.5	2.9	621657

(Decay time and ion balance: 300mm from the front of a device and max. fan speed, Noise: 1m from the front of a device and max. air speed)
 *Accessories: AC adapter AD24-ITE (100 to 240V AC) AC cable (1.8m) Cleaning brush

No. L-90-E Overhead Ionizing Triple-Fan

Ionizing method: Piezoelectric high-frequency AC corona discharge Applied voltage: 9.5kVAC (p-p)

- Butterfly louver for changing the angle of wind direction from the front cover. Each front cover can be set for a desired direction - high speed spot elimination and/or wide area elimination respectively, corresponding to various applications.
- Unique capacitive-coupled needle electrodes maintain superior ion balance and long term performance.
- Lightweight design.
- Front cover can be removed by one-touch operation. Easy maintenance.

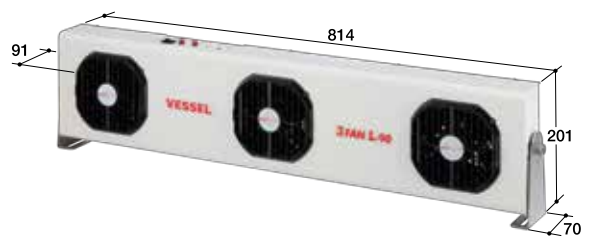

Model No.	Power supply	Current consumption (A) max.	Decay time	Ion balance	Noise level (dBA)	Fan speed (max) (m/min)	Weight (g)	EDP No.
L-90-E	24VDC±5%	3.0	within 1.5 sec	within ±10V	75.4	7.1	4.7	621628

(Decay time and ion balance: 300mm from the front of a device and max. fan speed, Noise: 1m from the front of a device and max. air speed)
 *Accessories: AC adapter AD24-IT37E (100 to 240V AC) AC cable (1.8m)

No. G-9

Pneu-Power Ion Gun



No More Power Cable!

Innovative ionizing gun working only with compressed air!

Air turbine rotates the motor, and this generates the power for ion generation.

Can start using the product only by connecting air hose as it does not require AC adapter or high voltage wiring.



No. G-9

Pneu-Power Ion Gun

- Power supply from external equipment is not required.
- Motor Cartridge (Replaceable) converts compressed air to the power. Rotor blades in the center generates power while rotating and supplies it to the high voltage power unit.

HAND TOOLS

BITS & SOCKETS

ELECTRIC TOOLS

AIR TOOLS

STATIC SOLUTIONS

GASOLINE ENGINE TOOLS

No. G-9 Pneu-Power Ion Gun NEW

Ionizing method:AC corona discharge Applied voltage:AC8kV p-p(±5%)/32kHz(Typ.)

- Innovative ionizing gun working only with a compressed air.
- Motor cartridge (replaceable) converts compressed air to the power. Rotor blades in the center of the motor generate power while rotating and supply it to the high voltage power unit.



CE

Model No.	Applied Voltage/ Frequency	Decay time	Ion balance	Noise level (dBA)	Air flow (ℓ/min)	Weight (g)	EDP No.
G-9	8kVAC p-p(±5%)/32kHz(Typ.)	within 1sec	within ±30V	83.1	200	470	621670

(Decay time and ion balance: 150mm from the front of a device and max. fan speed)
(Noise: 0.6m from the front of a device and max. air speed)
*Option: Silent Nozzle N-2WN, Urethane Tube Plug G-9UTP

No. G7R-E Ionizing Gun

Ionizing method:Piezoelectric high-frequency AC corona discharge Applied voltage:2kVAC

- Compact and lightweight.
- Ergonomically designed grip that fits your hand.
- Equipped with a bright LED light facilitating visual check of dust, and also with operating status and alarm lamps.
- Interchangeable nozzles for various applications (option)
- Needle electrode can be easily replaced with a dedicated tool.



CE

Model No.	Power supply	Current consumption (mA)typ.	Decay time	Ion balance	Noise level (dBA)	Air flow (ℓ/min)	Weight (g)	EDP No.
G7R-E	24VDC±5%	85	within 1sec	within ±10V	92	200	200	621621

(Decay time and ion balance: 150mm from the front of a device, at 0.3MPa, and when equipped with the standard nozzle)
(Noise: 1m from the front of a device and at 0.3MPa, Air flow: At 0.3MPa)
*Air supply pressure: 0.1MPa to 0.6MPa, Air supply hose diameter Φ6×Φ4mm
*Accessories: AC adapter AD24-ITC-E(100 to 240V AC), AC cable(1.8m), Standard Nozzle G-7SN
*Option: Joint Connection Needle G-7THN, Needle Electrode GNH, Needle Electrode Replacement Screwdriver G-7DR, Straight Silent Nozzle BB-ZSN, Silent Nozzle N-2WN, Tube-Fitting Nozzle N-2TN, Brush(60mm bristles) G-7B, Soft Burush(60mm bristles) G-7SB, Speed Controller G-7SC, Microfilter G-7F, Relay Cable(5m)G-7EC5, Relay Cable(10m) G-7EC10

No. G2-E Ionizing Gun

Ionizing method:Piezoelectric high-frequency AC corona discharge Applied voltage:2kVAV

- Compact and lightweight.
- Ergonomically designed grip that fits your hand.
- Equipped with a green LED light facilitating visual check of dust, and with operating status and alarm lamps.
- Interchangeable nozzles for various applications (option)
- Needle electrode can be easily replaced with a dedicated tool.



CE

Model No.	Power supply	Current consumption (mA)typ.	Decay time	Ion balance	Noise level (dBA)	Air flow (ℓ/min)	Weight (g)	EDP No.
G2-E	24VDC±5%	100	within 0.8sec	within ±10V	94	153	260	621659

(Decay time and ion balance: 300mm from the front of a device, at 0.3MPa, and when equipped with the standard nozzle)
(Noise: 1m from the front of a device and at 0.3MPa, Air flow: At 0.3MPa)
*Accessories: AC adapter AD24-ITCE(100 to 240V AC), AC cable(1.8m), Standard Nozzle N-15N

One point

Pipe arrangement and wiring can be changed depending on the work



HAND TOOLS

BITS & SOCKETS

ELECTRIC TOOLS

AIR TOOLS

STATIC SOLUTIONS

GASOLINE ENGINE TOOLS

No. N-1 Super Slim Ionizing Nozzle

Ionizing method: Piezoelectric high-frequency AC corona discharge Applied voltage: 5kVAC

- Compact design permitting placement anywhere and in any direction. Newly developed high-voltage transformer and control circuit enables unprecedented ease of use to be realized.
- Screw type nozzle is removed easily, making both nozzle replacement and cleaning of the needle electrode easy.
- Equipped with six-pole terminals enabling an abnormally high-voltage signal to emit or 24 V DC power to be daisy-chained.
- Blue lamp lights up during normal operations. When there occurs errors in high voltage, a red lamp flashes.



Model No.	Power supply	Current consumption (mA) typ.	Decay time	Ion balance	Noise level (dBA)	Air flow (l/min)	Weight (g)	EDP No.
N-1	24VDC±5%	58	within 1sec	within ±10V	96	219	80	621639

(Decay time and ion balance: 150mm from the front of a device, at 0.3MPa, and when equipped with the standard nozzle)
 (Noise: at a measurement distance of 1m and 0.3MPa, Air flow: when equipped with the standard nozzle and at 0.3MPa)
 • Accessories: Standard nozzle N-1SN
 • Options: Tube-fittig Nozzle N-2TN, Silent Straight Nozzle BB-ZSN, Silent Wide Nozzle N-2WN, Speed Controller G-7SC, Micro-Filter G-7F, Needle Replacement Screwdriver G-7DR, Needle Electrode GN-H

No. N-3 Pinpoint Ionizing Nozzle

Ionizing method: Piezoelectric high-frequency AC corona discharge Applied voltage: 5.6kVAC

- Compact and lightweight. Equipped with screw holes for a mounting to a system.
- Offers various nozzles as options that can be used in a variety of applications
- Screw type nozzle is removed easily, making both nozzle replacement and cleaning of the needle electrode easy.
- Automatically stops in the event of high voltage. Equipped with alarm output terminals.
- Equipped with six-pole terminals enabling an abnormally high-voltage signal to emit or 24 V DC power to be daisy-chained.
- Green lamp lights up during normal operations. When there occurs errors in high voltage, a red lamp flashes.

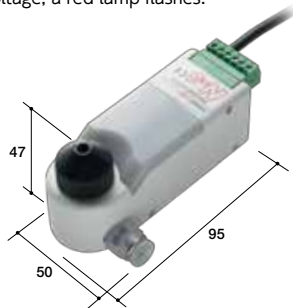

CE

Model No.	Power supply	Current consumption (mA) max.	Decay time	Ion balance	Noise level (dBA)	Air flow (l/min)	Weight (g)	EDP No.
N-3	24VDC±5%	90	within 1sec	within ±10V	99.4	210	104	621654

(Decay time and ion balance: 150mm from the front of a device, at 0.3MPa, and when equipped with the standard nozzle)
 (Noise: At a measurement distance of 1m and 0.3MPa, Air flow: When equipped with the standard nozzle and at 0.3MPa)
 • Air supply pressure 0.1MPa to 0.6MPa, Air supply hose diameter $\phi 6 \times \phi 4$ mm
 • Accessories: Standard Nozzle N-1SN
 • Option: Tube-Fitting Nozzle N-2TN, Shower Tube N-2C6B, Straight Silent Nozzle BB-ZSN, Silent Nozzle N-2WN, Speed Controller G-7SC, Microfilter G-7F, Electrode Needle Replacement Screwdriver G-7DR, Electrode Needle GN-H

One point

Interchangeable nozzles for various applications (option)



Shower Nozzle and Silent Nozzle are available as options.

Daisy-chain wiring. High voltage cables stay inside the product.

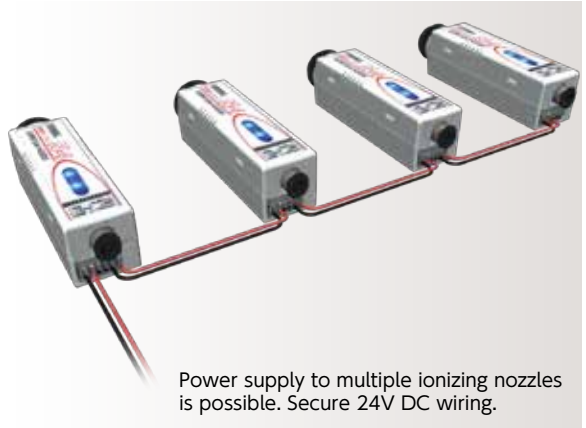

Power supply to multiple ionizing nozzles is possible. Secure 24V DC wiring.

HAND TOOLS

BITS & SOCKETS

ELECTRIC TOOLS

AIR TOOLS

STATIC SOLUTIONS

GASOLINE ENGINE TOOLS

No. HPG-1S-E High Power Ionizing Gun Unit **NEW**

Ionizing method : AC corona discharge Applied voltage : 3.5kVAC (50/60Hz)

- Titanium electrode needle (discharge electrode)
- Silicon shielded cable for high voltage. (3m)
- The body of the air gun is robust aluminum die-cast.
- The air gun is equipped with an easy-handling lever.
- Ion Balance Circuit (High Voltage Power Supply Unit GP-1 4kV)
- Safety circuit/Anomaly detection circuit (High Voltage Power Supply Unit GP-1 4kV)



Model No.	Decay time	Ion balance	Noise level (dBA)	Air flow (ℓ/min)	Weight (g)	EDP No.
HPG-1S-E	within 0.5sec	Adjustable on the GP-1 4kV	95	100	550	623045

(Decay time and ion balance: 150mm from the front of a device, at 0.3MPa)
 ·Air supply pressure 0.1MPa to 0.6MPa, Air supply hose diameter $\Phi 6 \times \Phi 4$ mm
 ·Contents: High Power Ionizing Gun No.HPG-1 including high voltage cable (3m) and high voltage connector.
 High Voltage Power Supply No.GP-1 4kV, Power Adapter No.AD24-GPE

No. HPN-1 High Power Ionizing Nozzle (Shielded cable included) **NEW**

Ionizing method : AC corona discharge Applied voltage : 3.5kVAC (50/60Hz)

- Less-wearing titan electrode needle enhances the ionizing performance for a long time and with stability.
- Replaceable.
- A high voltage shielded cable, less affected by the electrical noises.

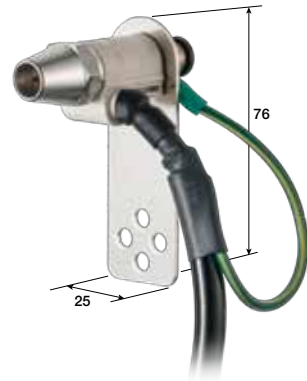

Model No.	Decay time	Ion balance	Noise level (dBA)	Air flow (ℓ/min)	Weight (g)	EDP No.
HPN-1	within 0.5sec	Adjustable on the GP-1 4kV	95	100	350	623043

(Decay time and ion balance: 150mm from the front of a device, at 0.3MPa)
 ·Air supply pressure 0.1MPa to 0.6MPa, Air supply hose diameter $\Phi 6 \times \Phi 4$ mm
 ·Contents: Including high voltage cable (3m), mounting hardware, and high voltage connector.
 ·Applicable: GP-1 4kV
 ·Relevant: High Voltage Power Supply No.GP-1 4kV, Power Adapter No.AD24-GPE

No. HPF-1 High Power Ionizing Flexible Nozzle **NEW**

Ionizing method : AC corona discharge Applied voltage : 3.5kVAC (50/60Hz)

- 300mm flexible tube useful to point the nozzle for effective neutralization.
- Pin-point static electricity removal even in a place difficult for installation.
- Powerful removal of dust and static electricity with compressed air.

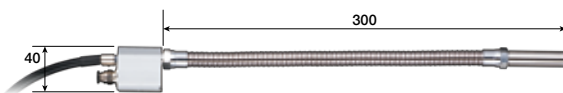

Model No.	Decay time	Ion balance	Noise level (dBA)	Air flow (ℓ/min)	Weight (g)	EDP No.
HPF-1	within 1sec	Adjustable on the GP-1 4kV	86	110	690	623048

(Decay time: 150mm from the front of a device, Air volume 30ℓ/min)
 (Noise level and Fan speed (max) : at 0.3MPa)
 ·Air supply pressure 0.1MPa to 0.4MPa, Air supply hose diameter $\Phi 6 \times \Phi 4$ mm
 ·Contents: Including high voltage cable (3m) and high voltage connector.
 ·Applicable: GP-1 4kV
 ·Relevant: High Voltage Power Supply No.GP-1 4kV, Power Adapter No.AD24-GPE

No. GP-1 4kV High Voltage Power Supply Unit **NEW**

Output voltage : 4kVAC (50/60Hz)

- Detects high voltage by an anomaly detection circuit.
- Can adjust ion balance with adjusting volumes.

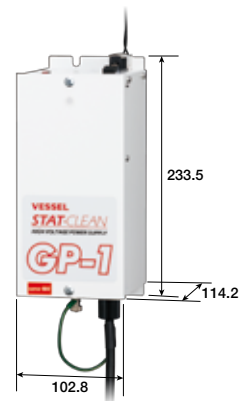

Model No.	Power supply	Size (mm)	Weight (g)	EDP No.
GP-1 4kV	24VDC±10%	233.5×114.2×102.8	4500	623044

·Applicable: HPN-1, HPG-1, HPF-1, SL-series
 ·Relevant: Power Adapter No.AD24-GPE

No. C-40

AC Pulse Ionizing Clean Bar

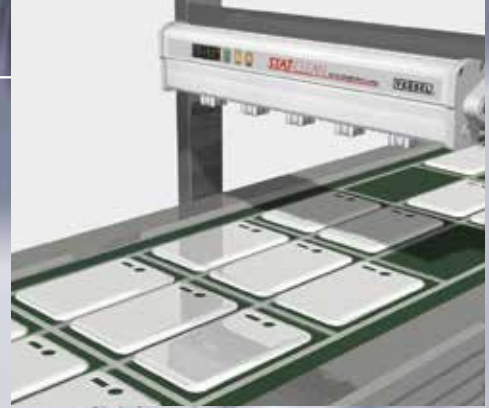

Aerodynamic body design of the thin cross sectional area enables quick static electricity elimination to be achieved without causing changes in air flow in a clean room or above in a clean bench. Being capable of setting frequency in 10 levels as well as being equipped with auto ion balance mode in which ion balance is automatically adjusted according to the polarity of a charged object, these ionizers can make adjustments according to the installation distance or the amount of charge.

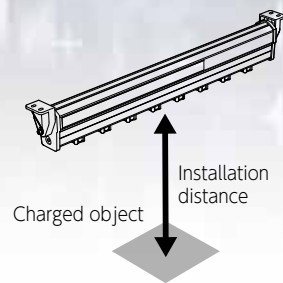
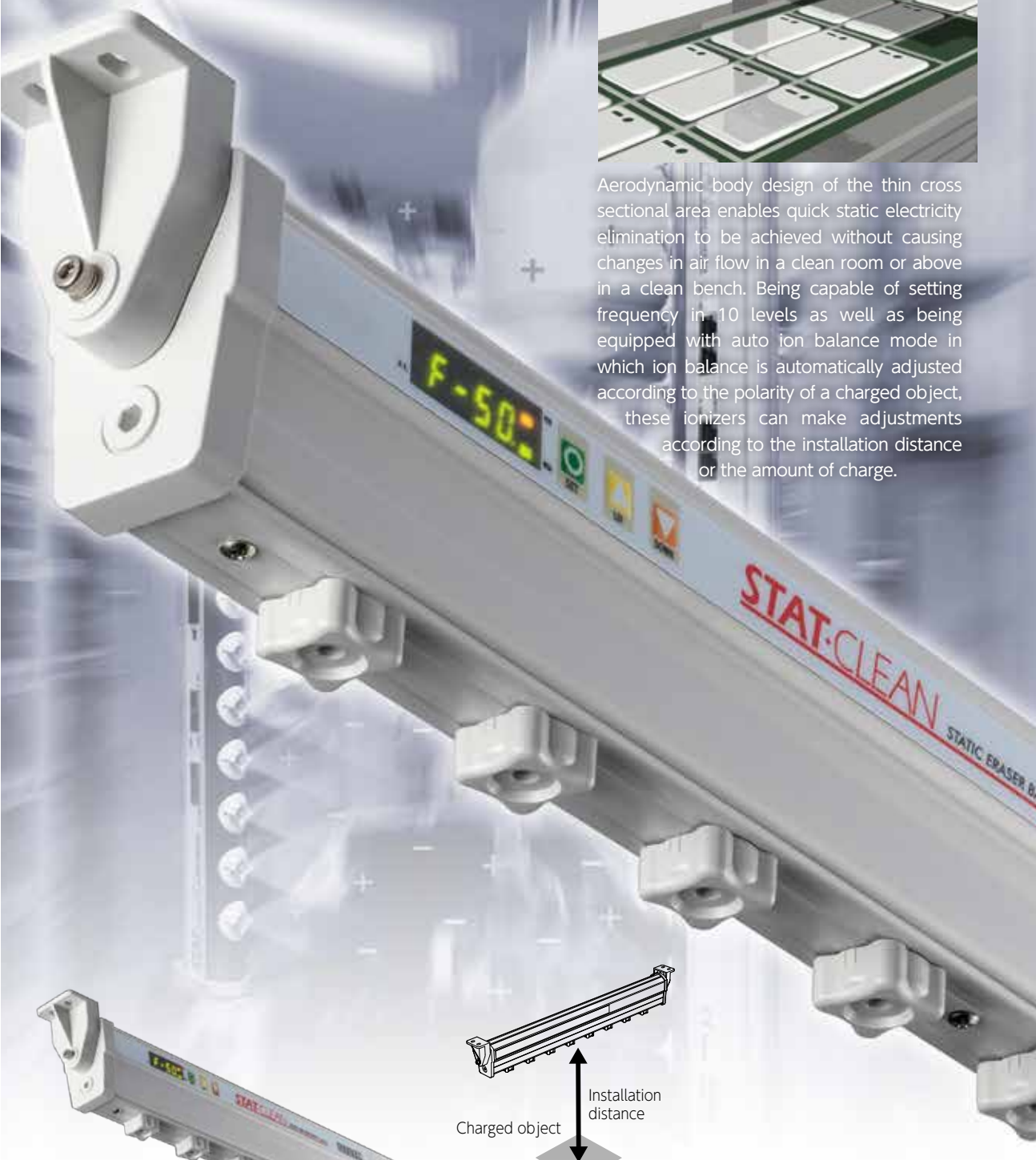

No. C-40

AC Pulse Ionizing Clean Bar

Bar-type ionizers best suited to mounting to a variety of equipment Air purge construction enables super-fast static electricity removal to be accomplished. With a line-up of abundant sizes, they respond to various applications.

Frequency setting

Installation place	Location	mm	Frequency, Hz
Film/conveyor	Close distance	50~300	20~50
Clean bench	Intermediate distance	600~750	8~10
Clean room ceiling	Long distance	900~1500	0.1~5

HAND TOOLS

BITS & SOCKETS

ELECTRIC TOOLS

AIR TOOLS

STATIC SOLUTIONS

GASOLINE ENGINE TOOLS

C-series

No. C-series AC Pulse Ionizing Clean Bar

Ionizing method:Pluse AC corona discharge Applied voltage:8~12.5kVAC(p-p)

- Super compact design in which a high-voltage power supply, control circuit, and air circuit have been incorporated.
- Terminals are collected on one side for easy daisy chain.
- Newly developed needle electrode socket is of air purge construction in which air purge outlets are provided around electrode needles. This does not only prevent contamination on the needle electrode tip but also helps super-fast static electricity removal.
- Opposing electrodes are incorporated in the body. This structure prevents particles from adhering to the body outside that is caused by induction voltage, and minimizes losses in applied voltage, enabling the ion generation efficiency to be improved.
- Adopts the needle electrode socket type in which a needle can be easily replaced by one-touch operation.
- Equipped with auto balance mode that optimally adjusts ion balance automatically according to the polarity of a charged object (target distance: 50 to 100 mm)



•Accessories :
AC cable (5m)
Remote Control RMC-01 (Except C-40/C-60)
End brackets 2pcs.
Middle bracket (Quantity See below)

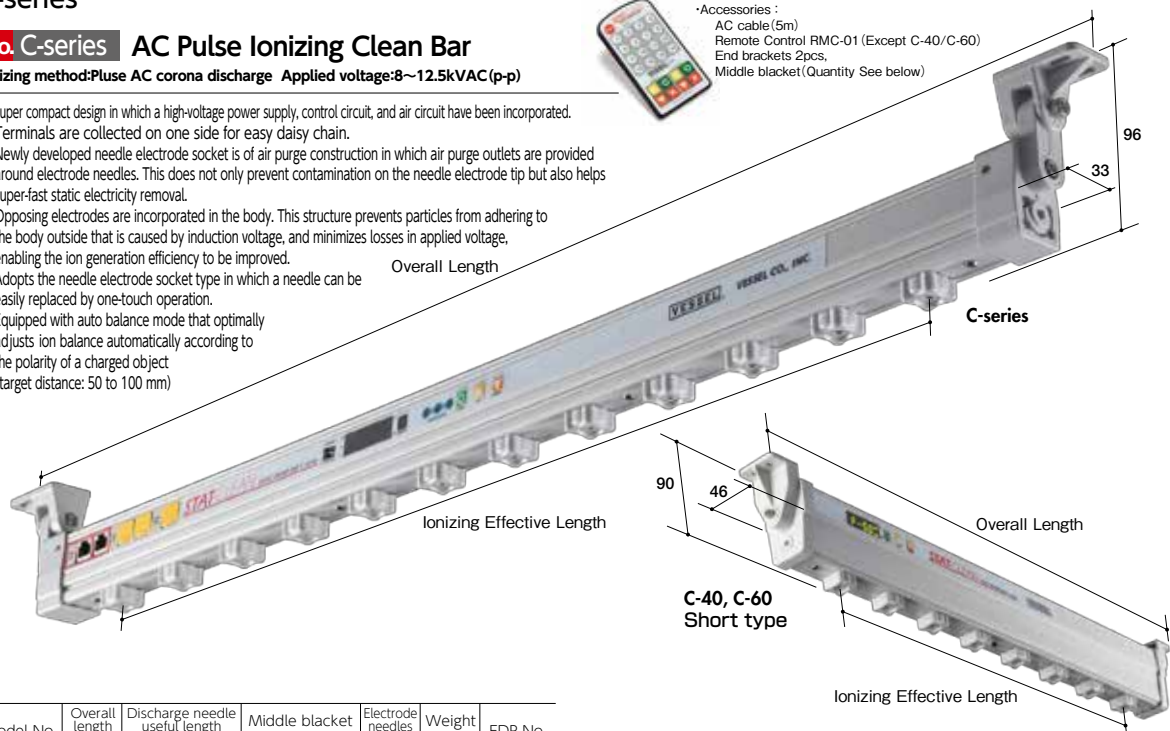

Model No.	Overall length (mm)	Discharge needle useful length (mm)	Middle bracket (pcs)	Electrode needles (pcs)	Weight (kg)	EDP No.
C-90	877	660	0	12	0.9	621851
C-100	1078	900	1	16	1	621852
C-120	1318	1140	1	20	1.2	621853
C-150	1558	1380	1	24	1.4	621854
C-170	1798	1620	2	28	1.6	621855
C-200	2038	1860	2	32	1.8	621856
C-220	2278	2100	2	36	2.3	621859
C-250	2518	2340	3	40	2.6	621860
C-270	2758	2580	3	44	2.8	621861
C-300	2998	2820	3	48	3.1	621862

Power supply	Current consumption (mA) max.	Decay time ※	Frequency	Pulse ratio	Voltage level
24VDC±5%	600	within 0.8sec	10steps (0.1~50Hz)	+ : 40~70% - : 60~30%	±10steps each

※Decay time :30Hz 10.5kVp-p 300mm directly below at 0.3MPa
 •Air supply pressure: 0 to 0.3MPa. Air supply hose diameter $\Phi 8 \times \Phi 6 \text{mm}$ (Air supply port: PT1/8)
 •Accessories: Remote controller, Power cable (10m), End brackets (included with device), Middle brackets (included with device) (except C-90)
 •Option: AC Adapter AD24-ITE, AD24-IT19E, Power Supply cable (5m)CT-5

No. C-40/C-60 AC Pulse Ionizing Clean Bar

Ionizing method:Pluse AC corona discharge Applied voltage:8~12.5kVAC(p-p)

- Short type optimal for installation on a conveyor or in equipment.
- Consolidated terminals on the back side. Power can be supplied by daisy chain wiring.

Model No.	Overall length (mm)	Discharge needle useful length (mm)	Electrode needles (pcs)	Weight (kg)	EDP No.
C-40	422	240	5	0.78	621857
C-60	602	420	8	1.08	621858

Power supply	Current consumption (mA) max.	Decay time ※	Frequency	Pulse ratio	Voltage level
24VDC±5%	600	within 0.8sec	10steps (0.1~50Hz)	+ : 40~70% - : 60~30%	±10steps each

※Decay time :30Hz 10.5kVp-p 300mm directly below at 0.3MPa
 •Air supply pressure: 0 to 0.3MPa. Air supply hose diameter $\Phi 8 \times \Phi 6 \text{mm}$ (Air supply port: PT1/8)
 •Accessories: Power cable (10m) ,End brackets (included with device) ,Interface cable (10m)
 •Option: AC Adapter AD24-ITE, AD24-IT19E, Power Supply cable (5m)CT-5

One point

AC Pulse Auto Balance Mode

The C series are equipped with a mode to optimally adjust the ion balance automatically according to the polarity of the charged object. (Target distance: 50 to 100 mm)

※C-series

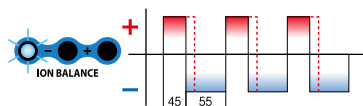
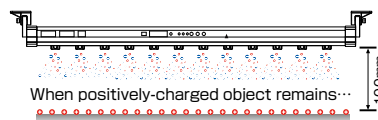

More negative ions are generated.

AC pulse method

Generating alternately positive ions and negative ions from each electrode. Since ions are generated at the maximum width of each positive and negative electrode cycle, the ion volume is high and static electricity can be removed quickly.

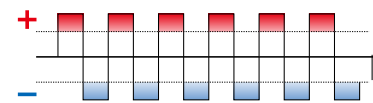

Typical alternating current

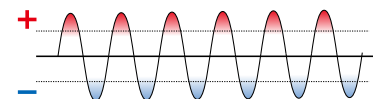

HAND TOOLS

BITS & SOCKETS

ELECTRIC TOOLS

AIR TOOLS

STATIC SOLUTIONS

GASOLINE ENGINE TOOLS

No. SL-series Ionizing Bar NEW

Ionizing method : AC high voltage applied type Applied voltage : 4kVAC

- Compact & slim body designed.
- Detachable discharge needle & high-voltage cable.
- Changing an angle after the installation is available by the bracket.
- High-voltage power supply (No.GP-1) as an option makes it possible to control the removal of electricity precisely.

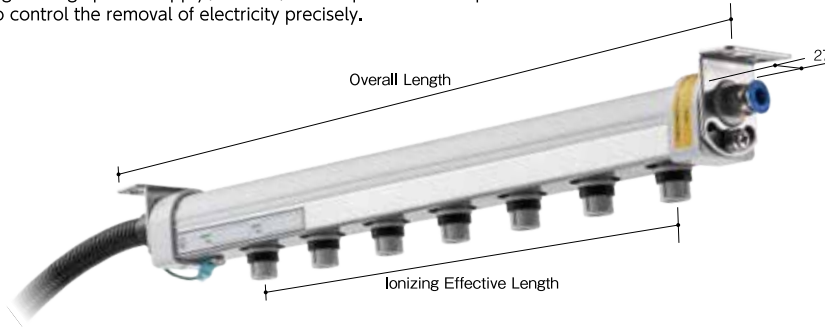

Discharge needles can be cleaned and replaced while the ionizing bar remains installed.



Power supply	Ion Balance	Decay Time	Operating range (mm)	Air flow (ℓ/min)
High Voltage Power Supply Unit No.GP-1 4kV(Option)	Adjustable on the GP-1 4kV	1 second or less	50~2000	135

•Air pressure:~0.3MPa •Decay time : Distance 300mm
 Accessory : Grounding wire
 Options : Connecting cable GP-EC25, GP-EC5, SJ-EC2.5, SJ-EC5. Needle electrode unit SJ-00HR

Model No.	Overall length (mm)	Discharge needle usefull length (mm)	Electrode needles (pcs)	Weight (g)	EDP No.
SL-20	211	138	3	200	621877
SL-30	371	298	7	300	621878
SL-50	531	458	11	700	621879
SL-80	851	778	19	900	621880
SL-120	1,171	1,098	27	1,100	621881
SL-150	1,491	1,418	35	2,000	621882
SL-180	1,811	1,738	43	2,200	621883

Ion balance: within 50V, Decay time: within 1.0sec, Airflow: 135ℓ/min
 Relevant : High Voltage Power Supply No.GP-1 4kV, Power Adapter No.AD24-GPE
 Connecting cable (2.5m) No.GP-EC25, Connecting cable (5m) No.GP-EC5
 Needle electrode unit No.SL-00HR, Branch box No.SH-5P2

No. GP-1 4kV High Voltage Power Supply Unit NEW

Output voltage : 4kVAC (50/60Hz)

- Detects high voltage by an anomaly detection circuit.
- Can adjust ion balance with adjusting volumes.

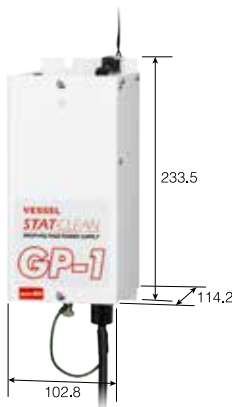

Model No.	Power supply	Size (mm)	Weight (g)	EDP No.
GP-1 4kV	24VDC±10%	233.5×114.2×102.8	4500	623044

•Applicable:HPN-1, HPG-1, HPF-1, SL-series
 •Relevant: Power Adapter No.AD24-GPE

No. SH-G3 Power supply units

Ionizing method : Plus AC corona discharge Applied voltage: 5kVAC p-p

- Equipped with two sockets for connecting the SL ionizing bars. They can be installed and wired easily.
- With the ion balance adjustment function (pulse ratio).
- Equipped with a safety circuit that shuts down the output if overcurrent or high-voltage error occurs.
- Lightest-weight body in the industry: 1.5kg.



Model No.	Input power supply	Power consumption (W)	Frequency (Hz)	Plus ratio	Weight (kg)	EDP No.
SH-G3	100~240V AC (50/60Hz)	10	30	±: 40~70% ~ 60~30%	1.5	621555

Accessories: AC Power cable 1.8m(for 100VAC and input) 2cables

HAND TOOLS

BITS & SOCKETS

ELECTRIC TOOLS

AIR TOOLS

STATIC SOLUTIONS

GASOLINE ENGINE TOOLS

No. HPB-series High Power Ionizing Bar NEW

Ionizing method : AC corona discharge Applied voltage : AC3.5kV (50/60Hz)

- Super slim model, optimum for installation in a cramped space of equipment.
- Titanium needle electrode, with less electric corrosion wear.
- Ion balance adjustment, Anomaly detection, Automatic stop, and Alarm output can be set with the high voltage power unit No. GP-1 4kV (option).
- Air Assist Bar is also available as option.

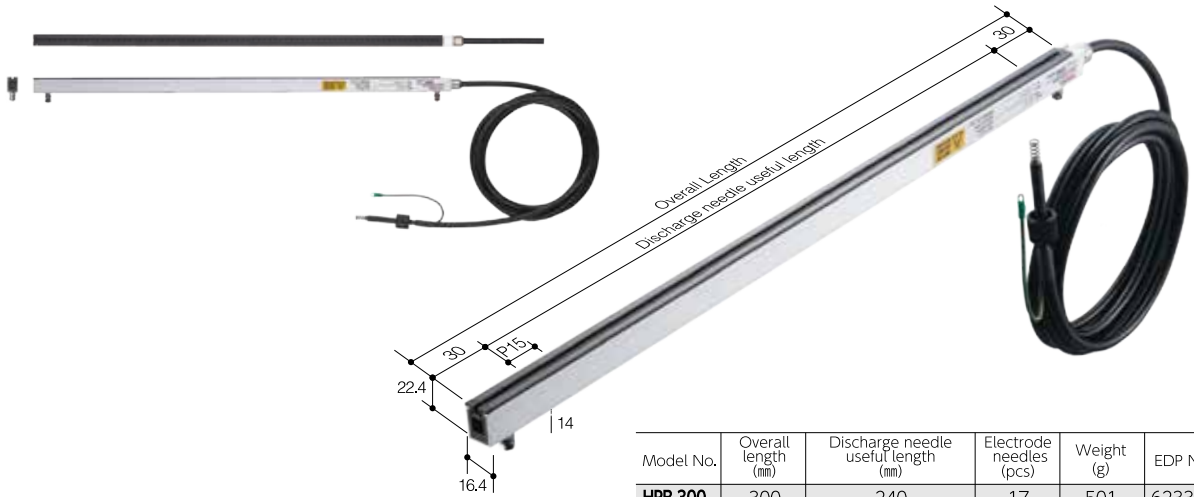

Model No.	Overall length (mm)	Discharge needle useful length (mm)	Electrode needles (pcs)	Weight (g)	EDP No.
HPB-300	300	240	17	501	623316
HPB-600	600	540	37	662	623336
HPB-810	810	750	51	774	623350
HPB-1005	1,005	945	64	879	623363
HPB-1200	1,200	1,140	77	988	623376
HPB-1500	1,500	1,440	97	1,148	623396
HPB-1800	1,800	1,740	117	1,309	623416

Power supply	Ion Balance	Decay Time	Operating range (mm)	Air flow (ℓ/min)
High Voltage Power Supply Unit No.GP-1 4kV(Optional)	Adjustable on the GP-1 4kV	1 second or less	50~2000	135

·Air pressure:~0.3MPa ·Decay time : Distance 300mm
 Accessory : Grounding wire
 Options : Connecting cable GP-EC25, GP-EC5, SJ-EC2.5, SJ-EC5, Needle electrode unit SJ-00HR

Contents: High voltage cable (3m) (already mounted), Mounting bolt M5 (already mounted)
 Applicable: GP-1 4kV
 Relevant : High Voltage Power Supply No.GP-1 4kV, Power Adapter No.AD24-GPE

One point

For highly charged or fast moving products

Titanium discharge needles

A titanium needle is more wear-resistant and have a longer lifetime than a regular stainless steel. The needles are located every 15mm on the bar, allowing to generate many ions effectively. This design is suitable for a high speed application.

Super Slim

The sectional dimensions: 16.4 x 22.4mm. Can be installed even in a cramped space.

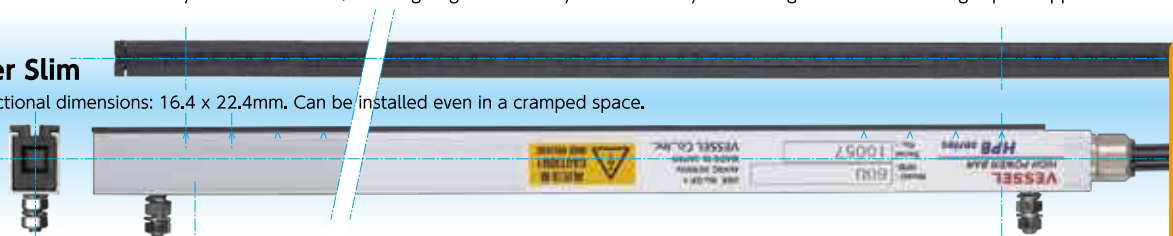

Mounting Bolts (M5)

2 pieces (standard accessory, included).
 1 more every time the total length exceeds 1 m.

Dedicated High Voltage Power Unit

Use No. GP-1 4kV.



High Voltage Shielded Cable

As the high voltage cable is shielded, there is no need for further ground.

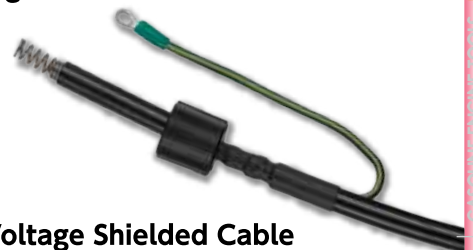

HAND TOOLS

BITS & SOCKETS

ELECTRIC TOOLS

AIR TOOLS

STATIC SOLUTIONS

GASOLINE ENGINE TOOLS



Dust prevention on molded parts



Cell production table



Static electricity removal in a bottle



Vibratory bowl feeder (joint nozzle + shower tube)

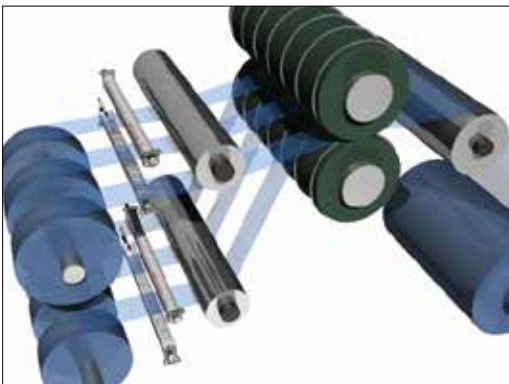

Film unwinding and widing

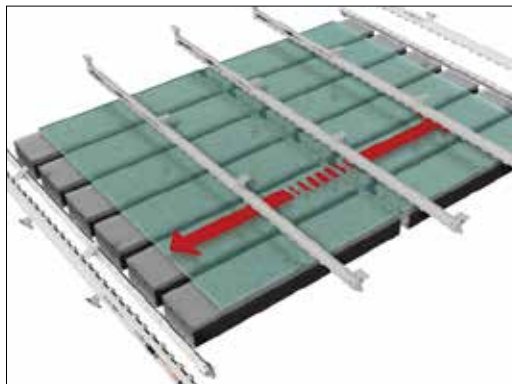

Glass substrate transfer

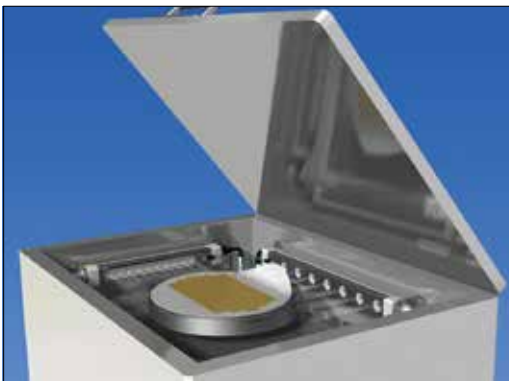

Production of the water film



Filling pills or capsules into a package

HAND TOOLS

BITS & SOCKETS

ELECTRIC TOOLS

AIR TOOLS

STATIC SOLUTIONS

GASOLINE ENGINE TOOLS

Ion Parts Cleaner



With the Ion parts cleaner applying a unique dust capturing method with an adhesive gel sheet, an installation space for a dust collector or a dust is no longer needed. This gel sheet can be repeatedly used after cleaning off dust.

We provide A4 and A3 sizes on the assumption of cell production work. This allows efficient dust removal work to be done according to line design.

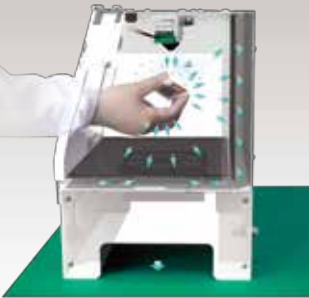

Static electricity elimination and dust removal in a hood. Dust adhered by static electricity is neutralized in the ionized hood and then removed by powerful automatic air blow.



No. IPC-A4

Ion Parts Cleaner

Ion parts cleaners playing an important role in line design of cell production. Assembled parts and devices can be cleaned on the spot and flowed to the next process, enabling line design to be smart.



No. IPC-A4 Ion Parts Cleaner

Ionizing method : Piezoelectric high-frequency AC corona discharge Applied voltage: 5.6kVAC(p-p)

- Compact bench-top type of 314 mm wide and 253 mm deep
- Eliminates static electricity and removes dust with air controlled by an infrared sensor.
- Time to stop ion blow after sensing a workpiece by a sensor is settable. (1, 3, 5, 10, or 30 sec)
- Adhesive gel collects blown-off dust assuredly.
- Dust on the adhesive gel mat can be washed off with water and the gel mat can be used repeatedly.
- Dust collector is not required; This reduces power consumption significantly and, in the end, the total running cost. Moreover, pulse blow also cuts the amount of air usage.
- In the pulse mode, air is blown intermittently, exerting force of blowing off dust by vibration. It allows low- and high-speed pulses to be selected according to workpiece.
- Incorporates an air regulator.



Model No.	Power supply	Power consumption (W)	Current consumption (mA)	Dust collection airflow (ml/min)	Airflow (l/min)	Weight (kg)	EDP No.
IPC-A4	24VDC±5%	17	700	3.5	147	6	621610

(Noise: 0.3MPa Airflow: 0.3MPa)
 Operating fluid: Clean dry air (0.1 to 0.5MPa), Air supply hose diameter Φ8mm
 Accessories: AC Adapter AD24-IT19(100~240VAC)(AD24-IT19E is available on request.), AC power cable 1.8m, Adhesive gel sheet/plate(attached on the product) (2pcs.)

No. IPC-A3 Ion Parts Cleaner

Ionizing method : Piezoelectric high-frequency AC corona discharge Applied voltage: 5.6kVAC(p-p)

- Equipped with two ionizing nozzles N-1, blowing air downward from the top side of the hood
- Eliminates static electricity and removes dust with air controlled by an infrared sensor.
- Time to stop ion blow after sensing a workpiece by a sensor is settable. (1, 3, 5, 10, or 30 sec)
- Adhesive gel collects blown-off dust assuredly.
- Dust on the adhesive gel mat can be washed off with water and the gel mat can be used repeatedly.
- Dust collector is not required; This reduces power consumption significantly and, in the end, the total running cost. Moreover, pulse blow also cuts the amount of air usage.
- In the pulse mode, air is blown intermittently, exerting force of blowing off dust by vibration. It allows low- and high-speed pulses to be selected according to workpiece.
- Incorporates an air regulator.



Model No.	Power supply	Power consumption (W)	Current consumption (mA)	Dust collection airflow (ml/min)	Airflow (l/min)	Weight (kg)	EDP No.
IPC-A3	24VDC±5%	22	900	1.13	270	9.5	621612

(Noise: 0.3MPa Airflow: 0.3MPa)
 Operating fluid: Clean dry air (0.1 to 0.7MPa), Air supply hose diameter Φ10mm
 Accessories: AC Adapter AD24-IT19(100~240VAC)(AD24-IT19E is available on request.), AC power cable 1.8m, Adhesive gel sheet/plate(attached on the product) (2pcs.), Duct flange(For Φ75mm),Paper pack filter (6pcs.)

One point

Features of IPC-A4 and -A3

Dust capturing gel sheet for IPC-A4 and -A3

Dust capturing using self-adhesive urethane gel
 Adhesiveness is restored by cleaning such as washing in water.

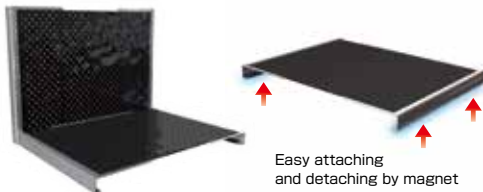

Paper-pack filter for IPC-A3

A paper-pack filter can be attached to the exhaust port in the back of the cleaner (Standard specifications). Replacement of a flange enables the cleaner to be connected to an exhaust duct of φ75 mm.



Air regulator equipped

The ion parts cleaners incorporate an air regulator, allowing you to adjust the flow rate of ion air.

No. IPC-250CR Ion Parts Cleaner **NEW**

Ionizing method : DC Corona discharge Applied voltage : +6kV, -3~-7kV

- Cleaned air blow with HEPA filter.
- DC ionizer incorporated, creating an ionized space.
- Adjustable air blow volume.
- No exhausted air by the air circulation system



Model No.	Power supply	Power consumption (W)	Current consumption (A)	Air flow (m ³ /min)	Max wind speed (m/s)	Noise level (dBA)	Weight (kg)	EDP No.
IPC-250CR	DC24V±5%	108	4.5	1.5	25	74	22	623201

(Air flow, Wind speed: No internal filter clogging, output value of the blower)
(Noise: Max air flow, No internal filter clogging, output value of the blower)
Accessory: Caution label sticker / Instruction manual

Replacement parts

Pre-filter	IPC-250CRPF	Power adapter	AD24-150-PD4
HEPA filter	IPC-250CRHF	EDP	806146
Needle electrode	SDJ-05RH	I/P	100V to 240 V AC, 50/60 Hz
		O/P	24V DC 5A

Option

One point

New concept of Ion Cleaning!



Air cleanliness (HEPA filters) <99.9% or more>

Particle	0.3μm	0.5μm	5μm	Total
Primary side	16,165,100	4,884,000	0	21,049,100
Secondary side	420	0	0	420

● Measured on April 13, 2018
Airflow: Max
Tested particle: PAO (Polyalphaolefin mist)
Particulate measured with KC-01DI (primary side, after air passing through the blower) and KC-03B (secondary side, after passing through the HEPA filter)

Dust removal test

Sample: Bakelite plate (150×90 mm, 3 mm thick)
Pseudo-contaminant: cotton linter
Static elimination time: 3 seconds (inclined at 45° with respect to the air outlet)

Before dust removal
charging voltage:
+1.25kV

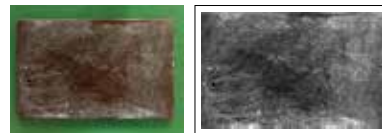

After dust removal
charging voltage:
0kV

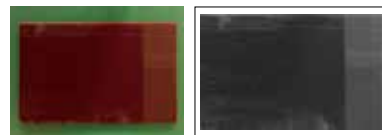

The white reflective cotton linters have been effectively removed.

● Measured on April 11, 2018 with Electrostatic Field Meter Eye-02, at Max Wind Speed at 26°C (temperature) and 45%RH (humidity)

Air circulation type, with no exhausted air.

- The air is vacuumed up from the pre-filter at the back of the booth passing through the inside blower and is filtered by the HEPA filter, then is blown back from the top of the booth.

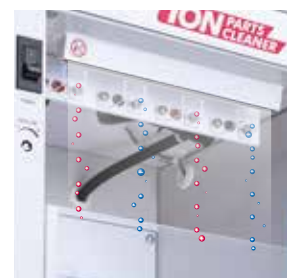
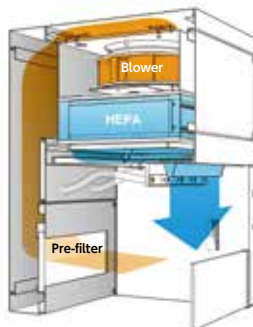

The generated ions are downflowed with the wide air blow.

No. LG-100/ SG-100

Conductive Rubber Mat



We provide IEC standards-compatible ESD protection items ranging from EPA working mats laid on workbenches, storage racks, and trolley surfaces, EPA flooring for PVC floors or floor coating, and to wrist straps for ESD countermeasures.

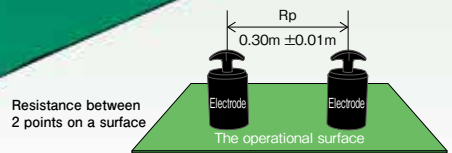
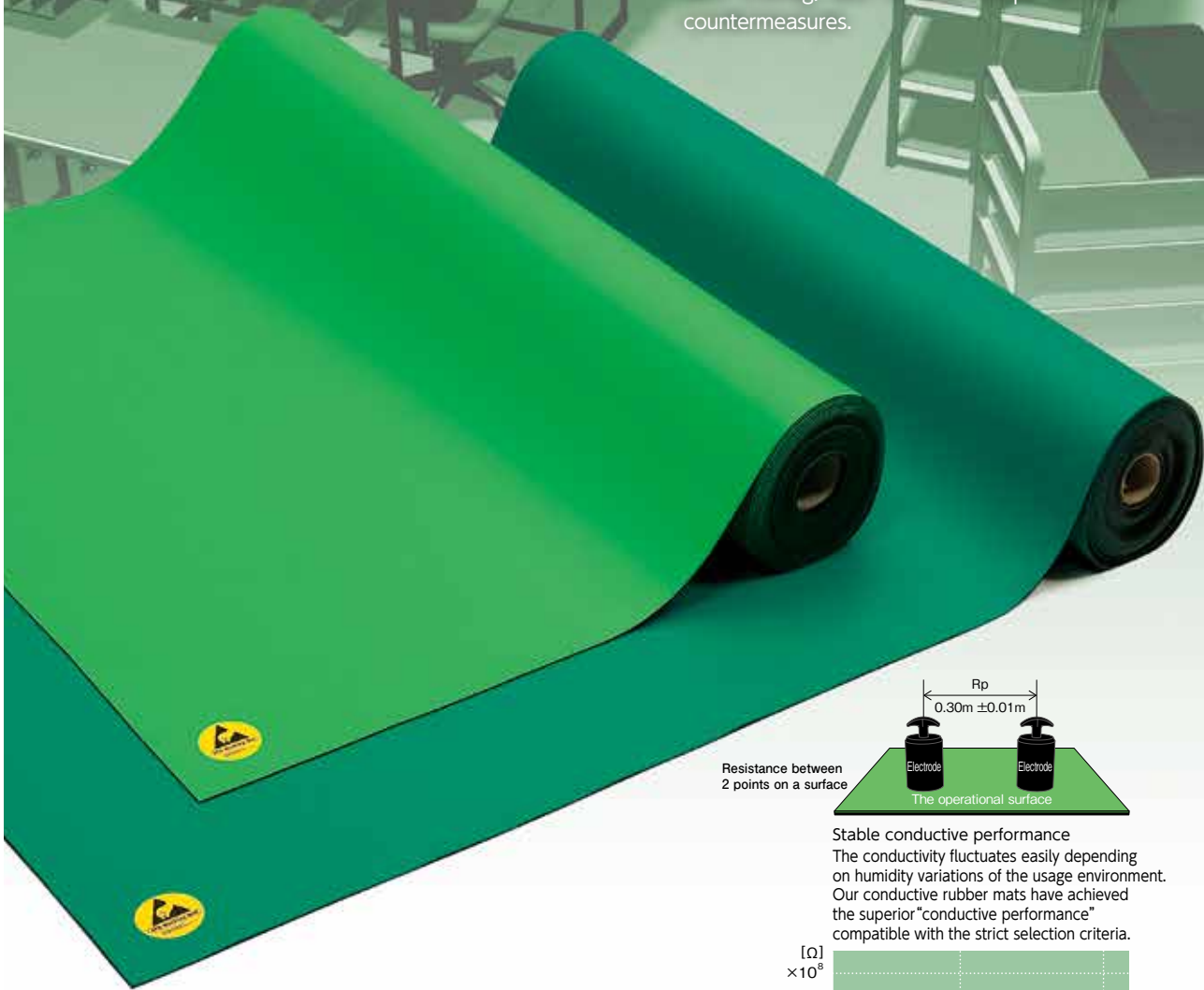

Stable conductive performance
The conductivity fluctuates easily depending on humidity variations of the usage environment. Our conductive rubber mats have achieved the superior "conductive performance" compatible with the strict selection criteria.

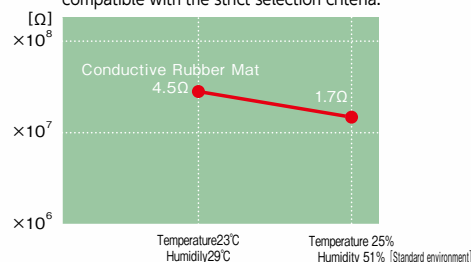

No. LG-100/ SG-100

Conductive Rubber Mat

Special mats through our unique and strict conductivity standards within 10⁷. They maintain stable conductivity even if humidity and temperature change. Available in two colors: light green and green. A wide choice of accessories such as mat connecting gel and ground taps is also available.

HAND TOOLS

BITS & SOCKETS

ELECTRIC TOOLS

AIR TOOLS

STATIC SOLUTIONS

GASOLINE ENGINE TOOLS

EPA Working Mat

Conductivity $10^6 \leq R \leq 10^7 \Omega$

No. LG-100/SG-100 Conductive Rubber Mat

Designed for workbenches that require anti-static measures, such as in the semi-conductors industry, electronic components assembly, and others. Heat-resistant, ideal for soldering work

- Uniform and consistent conductive performance.
- Matte surface finish, reducing reflections and helping prevent eye fatigue, for the aim at the satisfactory working performance.
- Soft surface that resists bending. (Hardness A type 64)

(Structure)

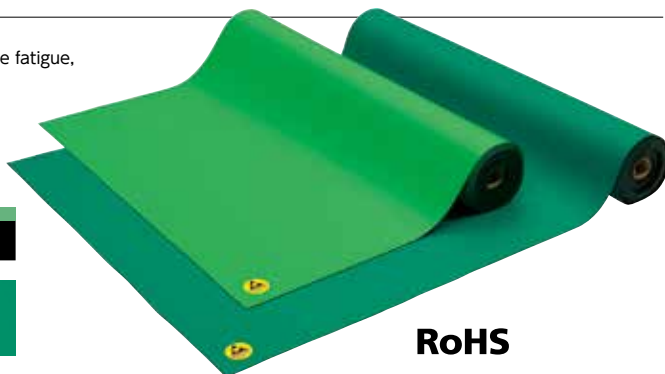
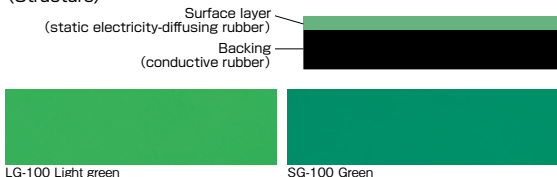

RoHS

Model No.	Color	Size (Length×Width×Thickness)	Weight	EDP No.
LG-100	Light green	10.0m×1.0m×2.0mm	27kg/roll	621464
SG-100	Green	10.0m×1.0m×2.0mm	27kg/roll	621461

Please contact VESSEL for availability of other colors. ※Resistance value may vary depending on the conditions of the measurement environment such as the temperature and humidity.

No. EPS-GT2 Ground Tap

- Provides ground connection points for anti-static wrist straps and conductive rubber mats.
- Attach the tap to the surface, the lateral or the back side of a workbench when using.

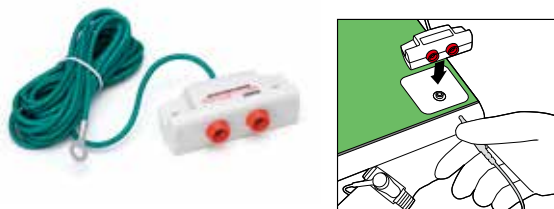

Model No.	Grounding cord (m)	Resistance value	Contents (quantity)	EDP No.
EPS-GT2	Approx. 3.0 (with round jack)	Approx. 1MΩ between device and grounding cord (round jack)	20	621402

Material: Core/ABS plastic /Conection hardware /Stainless steel

No. EPC-18 Ground Cord

- Designed to connect to a mat-connecting gel (includes a hook) or grounding tap.



Model No.	Resisutance value	Length (m)	Contents (quantity)	EDP No.
EPC-18	1MΩ	Max. length of 1.8m (when contracted 0.5m)	20	621393

Accessory: 1 alligator clip

No. EPG-01/EPG-02 Mat-connecting gel

- Made from medical-grade conductive gel.
- No need for grommet; easy to ground and connect multiple mats.

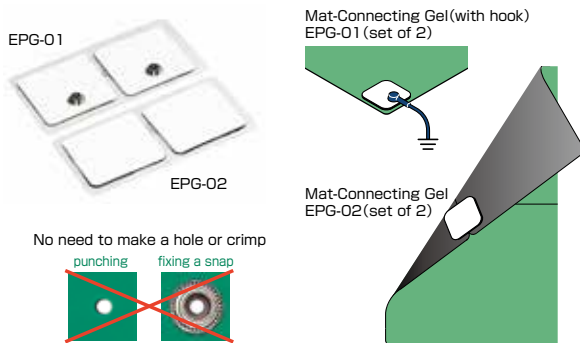

Model No.	Product name	Size (mm)	Contents (quantity)	EDP No.
EPG-01	Mat-connecting gel with hook (set of 2)	50×50	20	621481
EPG-02	Mat-connecting gel (set of 2)	50×50	20	621482

No. EPS-GK ESD Mat Gound Kit

- Grounding kit for a conductive rubber mat
- Snap, base plate, and screw are made from rust-resistant stainless steel
- Reusable when replacing mats because there is no adhesive part

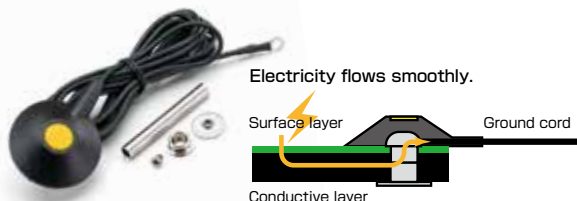

RoHS

* Usable mat thickness: The enclosed screw is for 2mm thickness mat. When using this kit with a mat of 3mm thickness or more, procure separately a small countersunk head screw M4.

Model No.	Grounding cord (m)	Resistance value	Contents (quantity)	EDP No.
EPS-GK	Approx. 2.4 (with round jack)	Approx. 1MΩ between device and grounding cord (round jack)	10	621484

Material: Snap, Base plate, Screw, Single-use punch /SUS Cord sheath /PU Snap cover /PVC Round terminal/ Brass

HAND TOOLS

BITS & SOCKETS

ELECTRIC TOOLS

AIR TOOLS

STATIC SOLUTIONS

GASOLINE ENGINE TOOLS

No. Eye-02 Electrostatic Field Meter

- A hand-held measuring instrument enabling you to measure an invisible electrostatic charge condition or ion balance of the ionizer easily.
- Maximum value (peak value) / pause can be displayed.
- LED cross mark as an index for correct measurement distance.
- Equipped with a female thread for camera screws; using with a tripod or jig enables measurements in stable state. Also provided with a plate for ion balance measurements.
- LCD has backlight and provides a bright, easy-to-see display in low light.
- Provided with a soft housing carrying case.
- Compatible with ISO 9000 traceability. A calibration table and certificate can be issued.



Measurement of charged potential



Ion balance measurement

Model No.	Measurement range		Measuring distance
	Static charge voltage measuring	Ion Balance voltage measuring	
Eye-02	±0~±1.50kV (LO range) ±1.0~±22.0kV (HI range)	0~±220V	25mm±0.5mm between charged object and the Eye-02)

Power source	Weight	EDP No.
9V DC (006 battery 1pce.)	170g; without Ion Balance plate 30g; Ion Balance plate	621603

Accessories: Ion Balance Plate×1, Ground Cord w/alligator clip×1, Carrying Case×1, Strap×1

No. EPS-05 Wrist Strap NEW

- Complies with RoHS controlling 10 substances
- Anti-static product, complying with JIS C 61340-4-6: 2016
- Contractile band with rubber woven, adjustable to the wrist
- Fine size adjustment with a buckle
- Safety in design; no conduction on the outer side of the band as conductive thread rubbers are woven on the inner side



RoHS

Model No.	Resistances value (Ω)	Length (m)	Contents (quantity)	EDP No.
EPS-05	1M	Max. length of 2.5 (when contracted 0.72)	10	621471

No. SRC-01 Surface Resistance Checker

- Surface resistance checker that facilitates the surface resistance measurement of floor, mat, desk and chair.
- Press and hold the measurement button switch, and the measurement value appears on the display. Automatic power off function is available.
- Voltage can be switched to measure a broad range of resistance values.
- Can measure temperature/humidity at the same time as the surface resistance value.
- Supplied with probes to measure "point-to-point resistance", "resistance to ground" and "volume resistance".
- Comes with a carrying case useful to carry all necessary items for measurement.

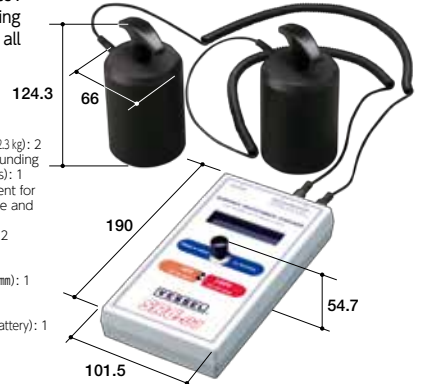

- Accessories:
- Probe (outer diameter: about 066mm, about 23 kg): 2
 - Curled cord for a body grounding (banana plug/mono plug): 1
 - Curled cord for measurement for the point-to-point resistance and resistance to ground (banana plug/mono plug): 2
 - Crocodile clip: 1
 - Large crocodile clip: 1
 - Stainless plate (185mm×100mm): 1
 - Carrying case: 1
 - 9V battery (006P type: manganese dry battery): 1
 - Manuals

With a carrying case

Useful to carry all necessary items for measurement

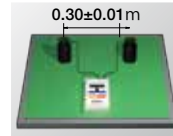

Resistance between 2 points on a surface.



Resistance between a ground and a connecting point by a probe on a surface



Surface resistivity



Volume resistance

Model No.	Measurement standard	Measurement range	Applied voltage
SRC-01	IEC61340-4-1 JIS-C2170	10 ³ ~10 ¹² Ω (Ω/sq)	10V (R<1.0×10 ⁶ Ω or Ω/sq) 100V (R≥1.0×10 ⁶ Ω or Ω/sq)

Power source	Weight	EDP No.
9V battery (006P type)	Main body: Approx. 340g (including battery) Total weight: Approx. 6.2kg (including carrying case)	621604

*The enclosed battery is a sample and may be out of use before the estimated number of use. Replace with a new one in this case.
*Calibration certificate can be issued as option (payable).

No. EPS-05C Wrist Strap Cord NEW

- Ground cord with 1M ohm current-limiting resistor
- Each product supplied in anti-static bag.



Model No.	Resistances value (Ω)	Length (m)	Contents (quantity)	EDP No.
EPS-05C	1M	Max. length of 2.5 (when contracted 0.72)	10	621472

HAND TOOLS

BITS & SOCKETS

ELECTRIC TOOLS

AIR TOOLS

STATIC SOLUTIONS

GASOLINE ENGINE TOOLS

EPA Floor Sheet

No. CD(R)-134/CD(R)-138/CD(R)-602 Conductive Vinyl Floor Sheet CD-leum/CD-leum R Conductivity $10^6 \sim 10^7 \Omega$

Vinyl floor sheet with uniform and consistent anti-static performance. Optimal for locations where static electricity is especially harmful, such as semi-conductor plants and clean rooms.



- Uniform and consistent conductive performance.
- Using a dedicated welding rod, the floor can be laid seamlessly.
- Dust-resistant surface facilitates cleaning and maintenance.
- High level of chemical resistance to acids, alkaline substances, disinfectants, etc.



Optimal for clean rooms in semi-conductor plants, electronics plants, assembly plants, and pharmaceutical plants, or hospitals, sterile rooms., etc.



Model No.	Color	Size (Length×Width×Thickness)	Weight	EDP No.
CD-134	Beige	9.0m×1.82m×2.0mm	3.1kg/m ² 51kg/roll	621492
CDR-134				621503
CD-138	Green			621493
CDR-138				621504
CD-602	Blue			621491
CDR-602				621505

Optional: earth plate/welding rod. If you would like to have colors other than the above, please contact us.

※Resistance value may vary depending on the conditions of the measurement environment such as the temperature and humidity.

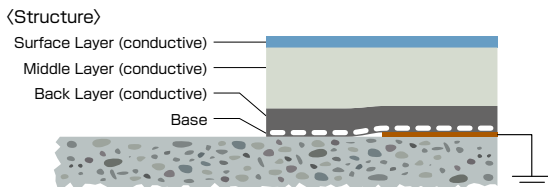

No. LS(R)-134/LS(R)-138/LS-5602 Anti-Static Vinyl Floor Sheet Lonstack/Lonstack R Conductivity $10^8 \Omega$

Vinyl floor sheet with uniform and consistent anti-static performance. This prevents static electricity from being generated, resulting in prevention of adhesion of dust and device malfunction.



- Uniform and consistent conductive performance.
- Using a dedicated welding wand, the floor can be laid seamlessly.
- Dust-resistant surface facilitates cleaning and maintenance.
- High level of chemical resistance to acids, alkaline substances, disinfectants, etc.

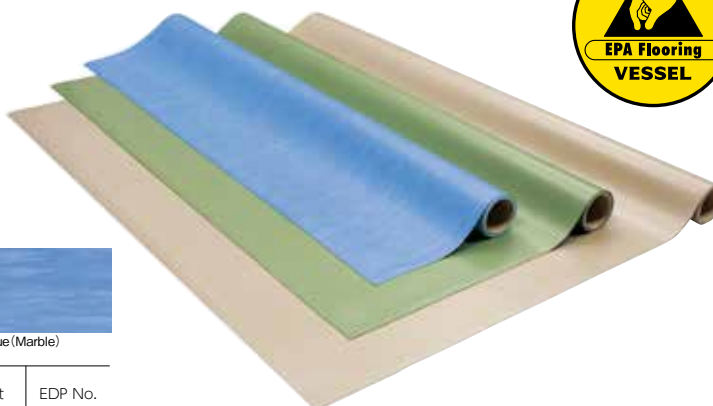

Model No.	Color	Size (Length×Width×Thickness)	Weight	EDP No.
LS-134	Beige	9.0m×1.82m×2.0mm	3.2kg/m ² 52kg/roll	621495
LSR-134				621501
LS-138	Green			621496
LSR-138				621502
LS-5602	Blue (Marble)			621494

Optional: earth plate/welding wand. If you would like to have colors other than the above, please contact us.

※Resistance value may vary depending on the conditions of the measurement environment such as the temperature and humidity.

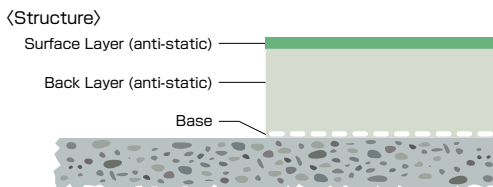

HAND TOOLS

BITS & SOCKETS

ELECTRIC TOOLS

AIR TOOLS

STATIC SOLUTIONS

GASOLINE ENGINE TOOLS

List of EPA Flooring Properties

※All data given in the following table are test values, not value of standard.

Item	CD-leum	Lonstack	Standard	[Standard value]
Indentation (mm)	23°C	0.73	0.70	JIS A5705 (0.3 or larger)
	45°C	1.18	0.96	(1.5 or smaller)
Remaining dent size (mm)	0.32	0.20	JIS A5705	(25 or smaller)
Dimensional stability after exposure to heat (%)	Vertical	-1.04	-0.70	JIS A5705 (2.0 or smaller)
	Horizontal	0.30	0.20	
Abrasion resistance (mm)	0.02	0.04	Weight 1.0kg, rotate 1000times	
Hardness	[A type]	83	80	ASTM D2240 value at 15seconds, 20°C
	[D type]	34	34	
Stain properties	Solution containing sodium hydroxide 2%	Gloss slightly changes.	Gloss changes.	JIS A1454, drop 2ml of reagent, leave for 24 hours (There must be no significant color or luster change and swelling)
	Hydrochloric acid 5%	No change	No change	
	Cement paste	No change	No change	

Construction [Please note that the construction should be performed by an authorized local constructor. Please consult us for more detail, before order.]

Investigation and analyses

Investigate the current floor conditions (material, cracks, smoothness, surface strength, area and earth connected terminal) and make an estimate. (To the basic price per square meter, expenses for extra work such as crack repair are added).



Construction

EPA flooring contractor performs the construction. (Please finish removal of equipment and cure application before construction starts)



Inspection

Within certain period after installation ends, the point-to-point resistance value and resistance value to ground are measured, and a floor installation completion certificate is issued.

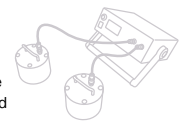

Conductivity $R \leq 1.0 \times 10^9 \Omega$

No. AF-45 Conductive Anti-Fatigue Mat

- Same characteristics as the AF-90.
- Space-saving 600x477mm good for one person.
- Inclined marginal area prevents workers from stumbling or falling.



Fall Prevention
The inclined marginal area prevents workers from stumbling or falling. (AF-45 only)

AF-45 sectional view



Air pockets on the back surface distributes the load, to alleviate fatigue.



RoHS

Model No.	Color	Size (mm) (Length×Width×Thickness)	Resistance value	Weight (kg)	EDP No.
AF-45	Gray	600×447×15	$R \leq 1.0 \times 10^9 \Omega$	2.0	621489

※Ground cord is not included.

Conductivity $R \leq 1.0 \times 10^9 \Omega$

No. AF-90 Conductive Anti-Fatigue Mat

- Conductive mat for fatigue alleviation from long standing work.
- Non-slip mat with embossments on the surface.
- Air pockets on the reverse side for spreading the body weight to alleviate fatigue.
- Light gray mat for easy detection of dirt, which may cause the conductive failure.
- 900mm×600mm convenient size for the working stand for cell production.

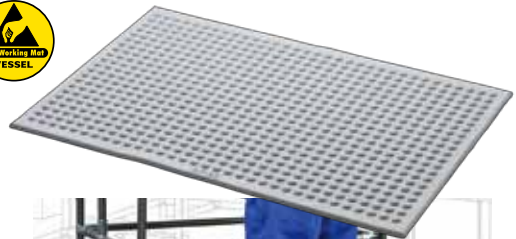

RoHS

Model No.	Color	Size (mm) (Length×Width×Thickness)	Resistance value	Weight (kg)	EDP No.
AF-90	Gray	900×600×15	$R \leq 1.0 \times 10^9 \Omega$	4.2	621488

※Ground cord is not included.

HAND TOOLS

BITS & SOCKETS

ELECTRIC TOOLS

AIR TOOLS

STATIC SOLUTIONS

GASOLINE ENGINE TOOLS

No. CW-900EZ

Clean Walker Easy



No more need to peel off films! This is a self-adhesive mat made of high quality urethane gel. Place this mat indoor such as entrance to a clean room, and the dust and dirt adhered to shoes soles or trolley wheels are easily captured. The adhesiveness is restored by washing and drying.

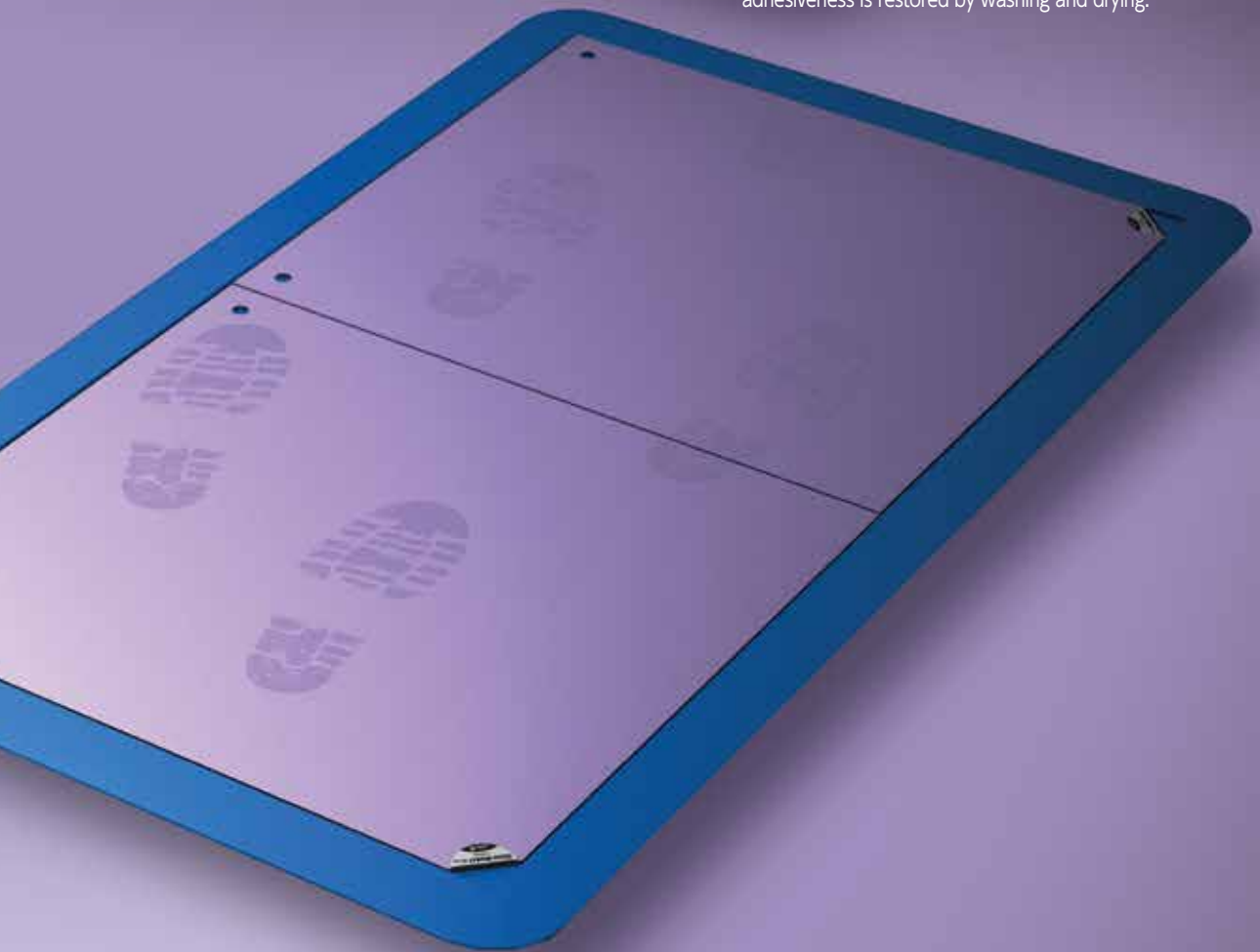

No. CW-900EZ

Clean Walker Easy

This product is a sticky mat that utilizes the self-adherence property of urethane gel. It flexibly changes its shape against dents and projections of shoe soles and wheels of carts, collecting grit and dust well. Dirt can be removed by washing with water.

HAND TOOLS

BITS & SOCKETS

ELECTRIC TOOLS

AIR TOOLS

STATIC SOLUTIONS

GASOLINE ENGINE TOOLS

No. CW-900B Clean Walker

For indoor use only (for example, entrance to a clean room).
Urethane gel adheres to shoe soles and catches dusts.

- High elasticity mat of 5 mm thick. Catches dust on shoes soles.
- Dust adhered on the CW-900B can be easily taken off by wiping with a damp cloth.
- Reversible (both sides can be used); running costs can be reduced.
- Indoor use only (most recommended to use at an entrance to a clean room)

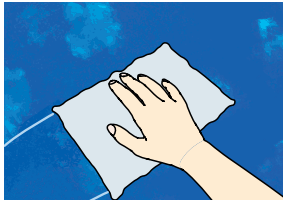

If the surface gets contaminated, simply wipe it with a damp cloth.

RoHS

Model No.	Color	Conductivity	Size (mm) (Length×Width×Thickness)	Weight (kg)	EDP No.
CW-900B	Blue	Insulator	500×900×5	2.4	621485

No. CW-900EZ Clean Walker Easy

For dust removal from shoes soles in cleanrooms, entrance to air shower booth, or in a factory. Also good for cleaning of trolley wheels.

- Non-woven textiles are sandwiched by the urethane gel layers. A 3mm thickness, providing high strength and resistant to tears under the pressure of trolleys. It can be stuck together like floor tiles.
- 2pcs of 450×500mm; Easy to take the mats off the floor and to clean with water.
- Provided with hook holes; hang and leave the mat dry, and the mat restores the adhesiveness.
- Indoor use only (most recommended to use at an entrance to a clean room)

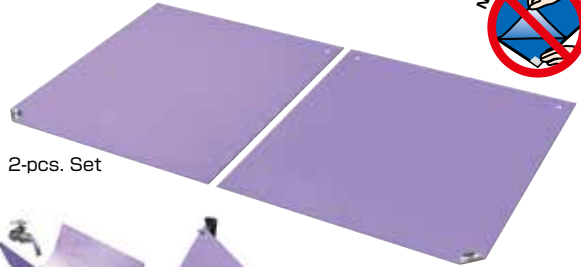

2-pcs. Set



Take the mat out of the floor and wash it with water

Hang from hook holes to dry off

(Structure)

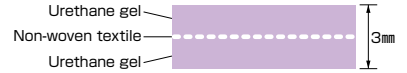

RoHS

Model No.	Color	Conductivity	Size (mm) (Length×Width×Thickness)	Weight (kg)	EDP No.
CW-900EZ	Light purple	Insulator	500×450×3	1.6(2pcs.)	621486

One point

Clean Walker

It is an adhesive mat that applies the self-adhesive properties of urethane gel. It deforms flexibly along with the unevenness of shoes soles or trolley wheels; dust is reliably captured. Dust and contamination can be washed off with water.



Applications

Ideal for removing dust off shoes soles or cleaning trolley wheels indoor

CW-900B

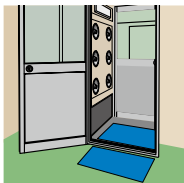

Air shower booths



Inside the plant

CW-900EZ



Entrance to clean rooms



For cleaning trolley wheels

HAND TOOLS

BITS & SOCKETS

ELECTRIC TOOLS

AIR TOOLS

STATIC SOLUTIONS

GASOLINE ENGINE TOOLS