

JBC

www.jbctools.com

INSTRUCTION MANUAL



TEQ

Precision Hot Air Station
without Extractor Desk

This manual corresponds to the following references:

TESE-1QA (100V / 120V)

TESE-2QA (230V)

Packing List

The following items are included:



JTU Hot Air Control Unit1 unit



TES Stand1 unit
Ref. TE-SE



TET Precision Heater Hose Set1 unit
Ref. TE-TB (100V / 120V / 230V)



Power Cable1 unit
Ref. 0023715 (100V / 120V)
0023714 (230V)



Nozzle 1 unit
Ref. TN9080 (Ø 5mm / 0.196in)



Nozzle 1 unit
Ref. TN9208 (Ø 4mm / 0.157in)



Nozzle 1 unit
Ref. TN9209 (Ø 3mm / 0.118in)



Kapton Tape 1 unit
Ref. PH217



Thermocouple Type K1 unit
Ref. PH218

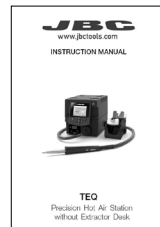

Manual 1 unit
Ref. 0027954

Features

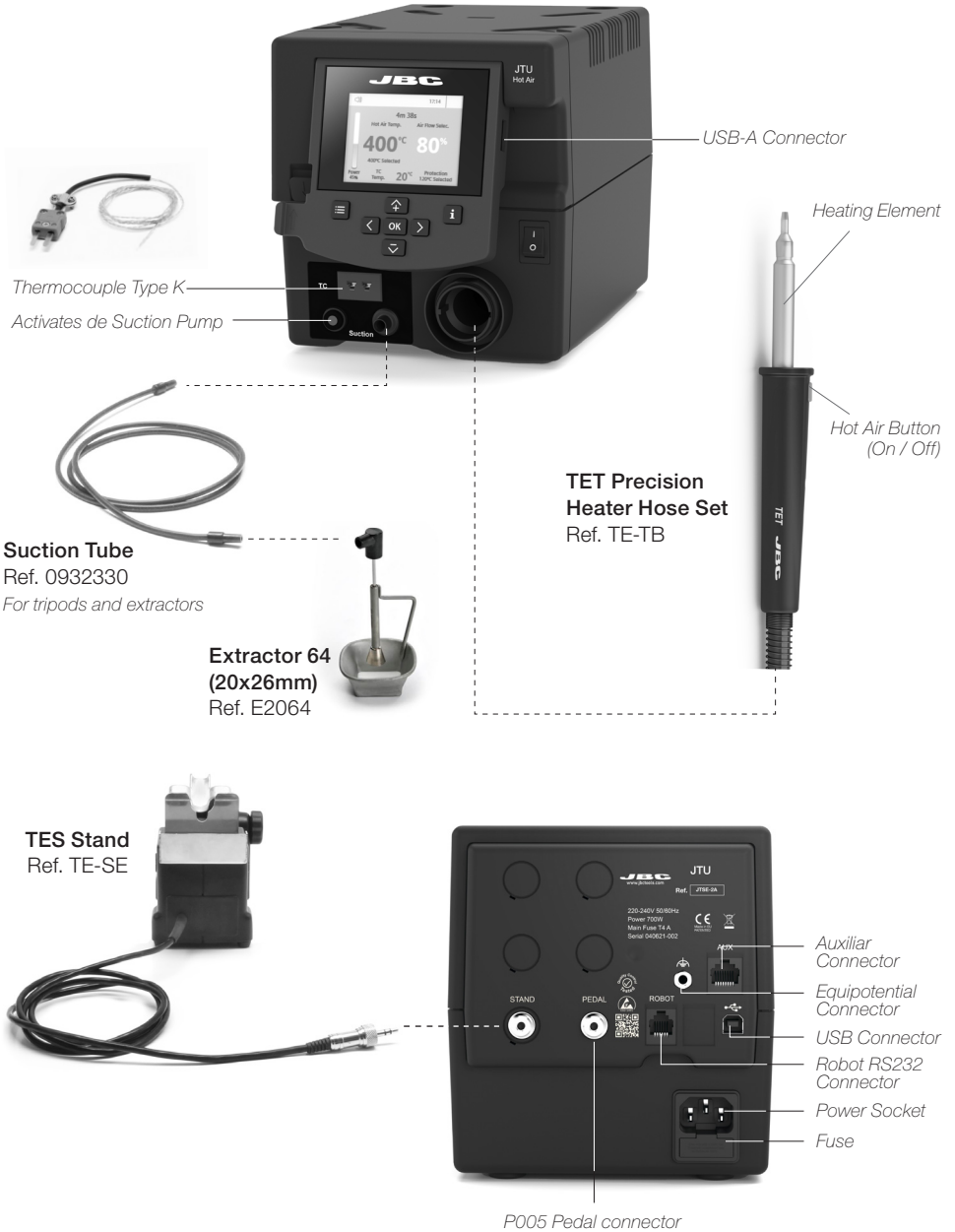

Suction Tube
Ref. 0932330
For tripods and extractors

Extractor 64 (20x26mm)
Ref. E2064

TES Stand
Ref. TE-SE

TET Precision Heater Hose Set
Ref. TE-TB

P005 Pedal connector

JT / TE Work Screen

JT/TE offers an **intuitive user interface** which provides **quick access** to station parameters.

Default PIN: 0105

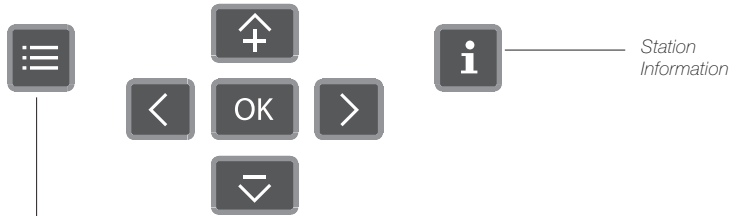
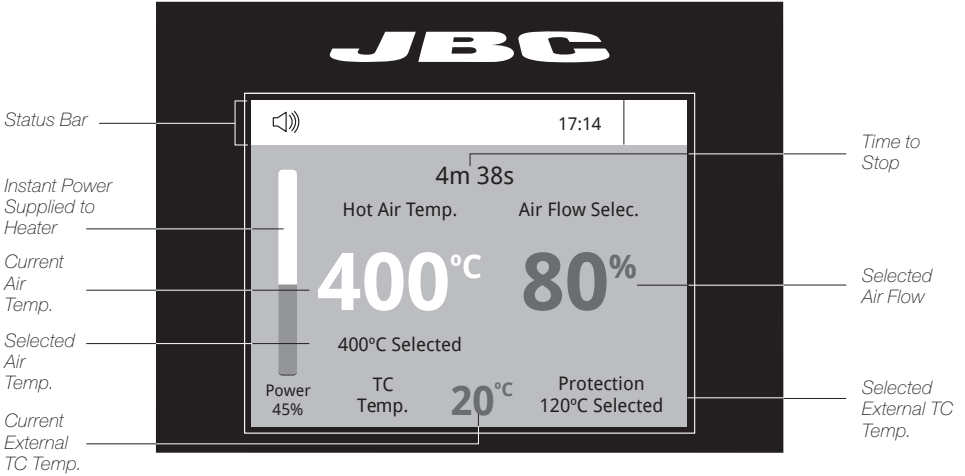

Menu Options



Set the station parameters

Station

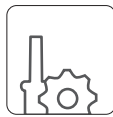

Set the tool parameters

Tools



Display the hours worked in each cycle

Counters



It is possible to choose the language from a list.

Language



Allows you to carry out an overall station reset restoring all the parameters to their default values.

Reset

Troubleshooting

Station troubleshooting available on the product page at www.jbctools.com

Advanced Functionalities



Profiles

To work with profiles it is essential to use RWB / RWS / RWT rework arms. The Rework Arms supports the Hot Air Heater maintaining the distance and position to the component.

In this mode you can **set up or edit** as many as 25 profiles of temperature and air flow.

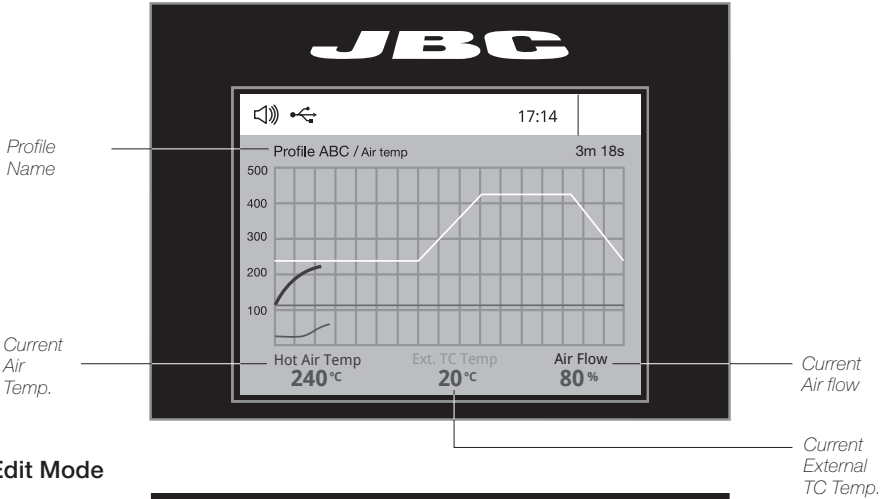

Edit Mode

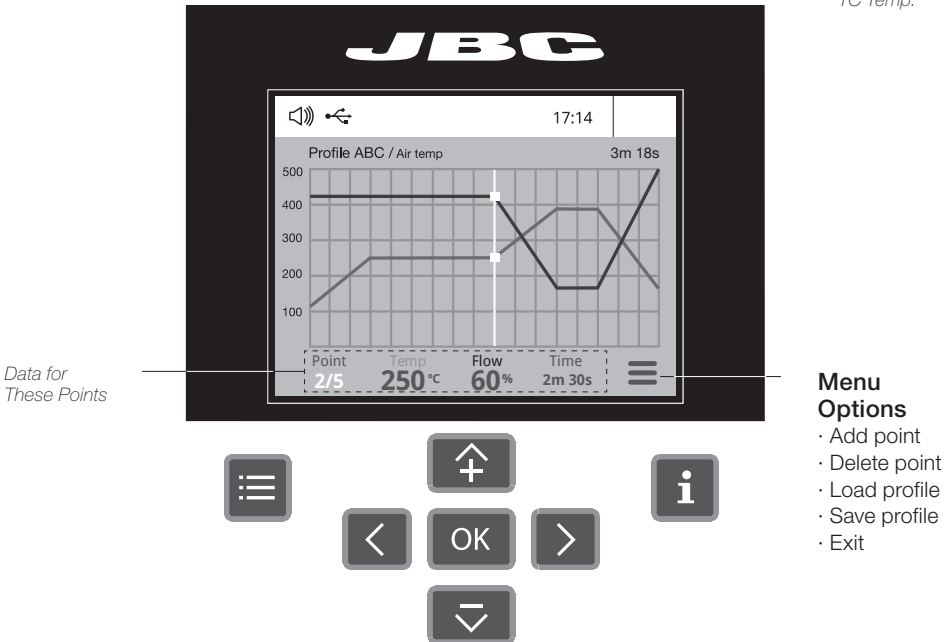



Graphics

By pressing **Graphics** in the main MENU, temperature and power figures in real time are displayed. This helps you decide which nozzle to use to obtain the best quality solder joints.

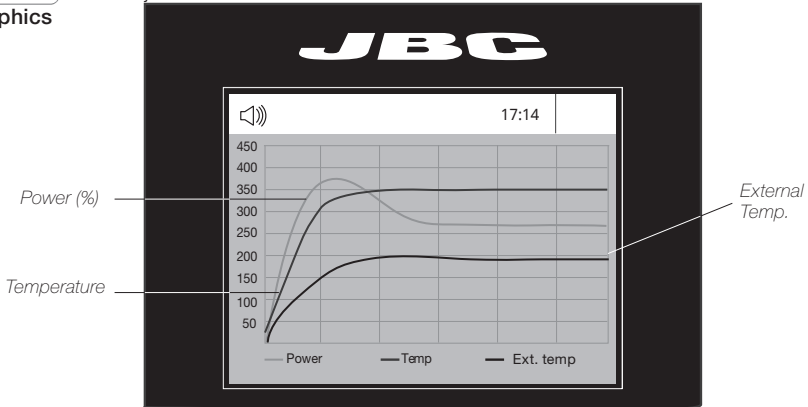

JBC Net

The first system to optimize traceability in soldering

- Get greater quality and control in your production
- Manage your whole soldering process remotely in real time



Files

Export Graphics

Insert a USB flash drive into the USB-A connector to save your soldering process in csv format.



Update

Station Update

Download the JBC Update File from www.jbctools.com/software.html Insert the USB flash drive with the file downloaded to the station.

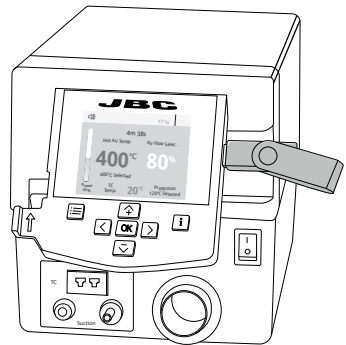

System Notifications

The following icons will be displayed on the screen's status bar.



USB flash drive is connected.



Station software update.
Press INFO to start the process.



Station is controlled by a PC.



Warning.
Press INFO for failure description.



Station is controlled by a robot.



Error.
Press INFO for failure description, the type of error and how to proceed.

Adjustable Stand

Adjust the tool holder angle to suit your work position.

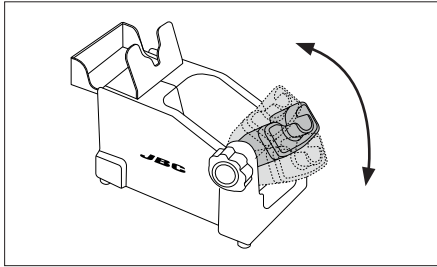

Operation Modes

1. From the Tool Settings Menu, select the mode to activate the tool depending on the task.

Tool button

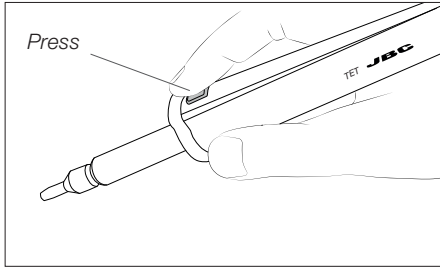

Press the start/stop button to blow hot air.

Pedal (not included)

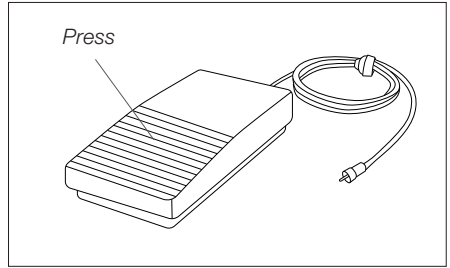

Press the Pedal (Ref. P-305) to blow hot air and release to stop.

2. The tool stops blowing when pressing the start/stop button.
If the stand is connected to the station and for safety it will also stop when returned to the stand.

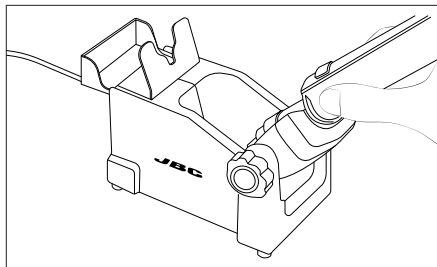

Operation

1. Placing

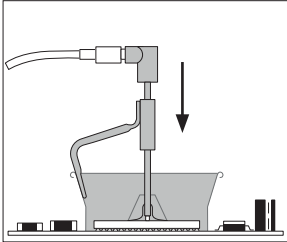

Position the extractor with the appropriate suction cup and press the suction button.

2. Heating

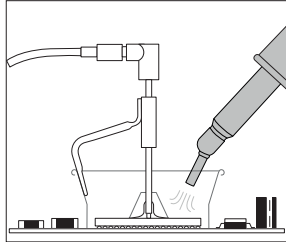

Heat the component.

3. Extracting

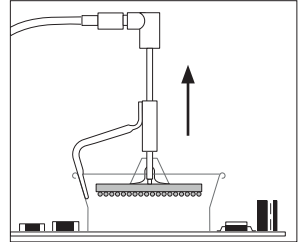

The component lifts off automatically when the solder melts.

Protectors & Extractors *(not included)*

For small components (fig. 1 and 2).

We recommend using the protector + tripod

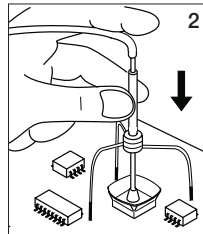
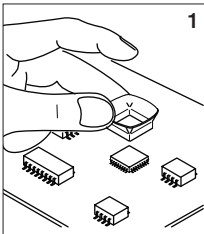

For large components (fig. 3 and 4).

We recommend using the manual extractors

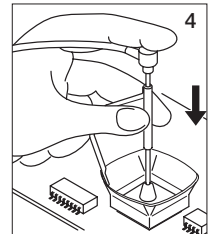
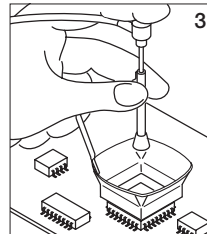

Pick & Place *(not included)*

This tool helps you place and remove SMDs of any size easily thanks to the suction pump.

Pick & Place
Ref. T260-A



Bent Needles Set
Ref. 0861660



Straight Needles Set
Ref. 0901546



Operation

Choose the needle and the suction cup that best fits the component and start as follows:

Suction Cup Set
Ref. 0930110



Press the button to start/stop the suction



1. Suction

2. Release

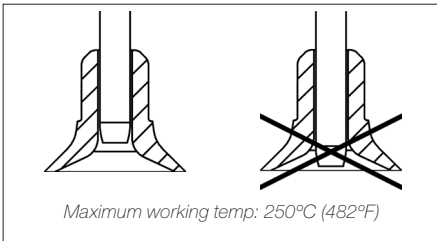

Insert the needle with the appropriate cup for a correct suction process.

Make sure the needle does not protrude from the cup.

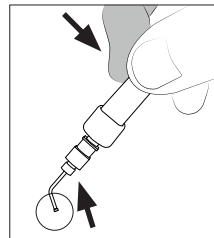

Once the suction is activated, cover the pen hole with your finger and lift off the component.

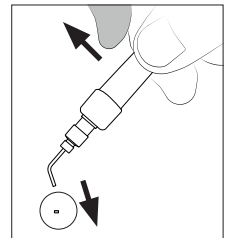

Lift your finger to release the component.

Accessories *(not included)*

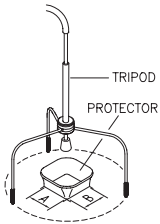

Protectors

No.*	Ref.	AxB (mm)	AxB (in)	No.*	Ref.	AxB (mm)	AxB (in)
	P3353	4,3 x 3	0.16 x 0.12		P1249	12 x 23	0.47 x 0.9
	P3786	5,2 x 5,2	0.20 x 0.20	44	P4000	12,5 x 12,5	0.49 x 0.49
	P3352	5,2 x 7,5	0.20 x 0.29		P3354	13,2 x 13,2	0.52 x 0.52
	P3355	5,2 x 9,5	0.20 x 0.37		P4025	13,5 x 21,5	0.53 x 0.85
	P3356	6,2 x 4,2	0.24 x 0.16	48	P2230	15 x 15	0.59 x 0.59
	P3785	7,2 x 7,2	0.28 x 0.28	60	P4010	17 x 17	0.67 x 0.67
	P3784	8,2 x 8,2	0.32 x 0.32		P4005	18 x 29	0.71 x 1.14
	P4035	9 x 13	0.35 x 0.51		P4030	18,5 x 18,5	0.73 x 0.73
	P4040	9,5 x 19	0.7 x 0.74		P1068	18,5 x 24	0.73 x 0.94
	P4080	9,5 x 21	9.5 x 0.83		P2685	28,5 x 28,5	1.12 x 1.12
32	P2220	10 x 10	0.39 x 0.39		P4085	31,5 x 31,5	1.24 x 1.24
	P4045	10,5 x 21	0.14 x 0.82		P2672	33 x 46	1.30 x 1.18
	P4090	11 x 16	0.43 x 0.63		P4002	50 x 50	1.97 x 1.97
24	P2235	12 x 17	0.47 x 0.67		P3357	52,5 x 14	2.06 x 0.55

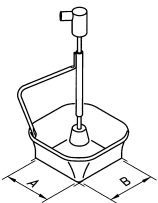

Extractors

No.*	Ref.	AxB (mm)	AxB (in)	No.*	Ref.	AxB (mm)	AxB (in)
52	E2052	20 X 20	0.79 x 0.79		E4015	31,5 X 31,5	1.24 x 1.24
64	E2064	20 X 26	0.79 x 1.02		E2084	33 X 33	1.30 x 1.30
80	E2184	24 X 24	0.94 x 0.94		E2100	38 X 38	1.50 x 1.50
	E2068	27 X 27	1.06 x 1.06		E2124	45 X 45	1.77 x 1.77
	E4020	28,5 X 28,5	1.12 x 1.12				

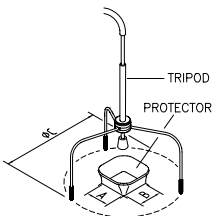

Tripods

Ref.	øC (mm)	øC (in)
T2050	39	1.53
T2250	85	3.35



Manual extractor

Ref.	øD (mm)	øD (in)
E2190	7	0.27

* Position in Extractor Stand

Using the Thermocouple type K

Connect a TC type K (PH218) to the station and use it as a protection or regulation sensor. You can define its use mode by means of the "Ext TC mode" option in the "Tool" menu.

You can choose from **two work modes**:

Regulation: the station regulates the air temperature automatically to maintain the External Thermocouple (TC) temperature.

Protection: the station cuts the air supply off when the External Thermocouple (TC) temperature is reached.

Fix the TC with Kapton Tape (Ref. PH217) as near as possible to the component being worked on. If Kapton tape is not ESD you must use an ionizer.

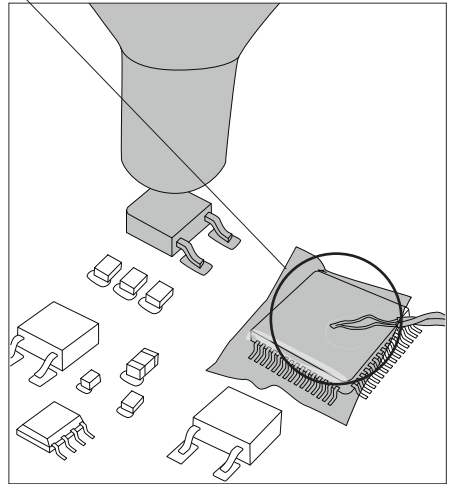
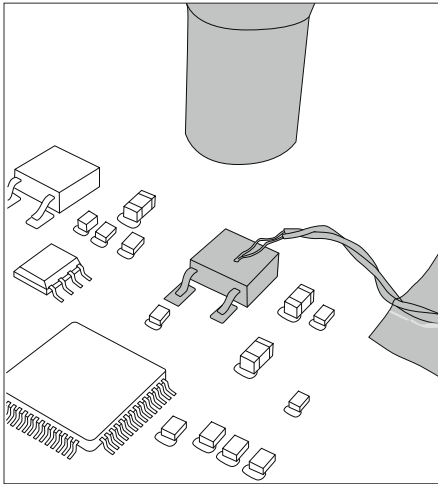

IPC* does not recommend exceeding ramp-up rates over 3-4°C / sec. (5-7°F / sec) so as to reduce the risk of thermal stress on the PCB.

* IPC was founded in the U.S. in 1957 as the Institute for Printed Circuits.

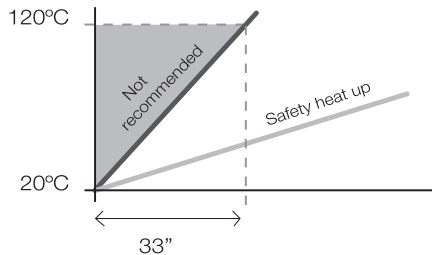

Quick Nozzle Changer

Changing nozzles quickly and safely.

 Turn the tool off and handle with care. The heating element and the nozzle are still hot.

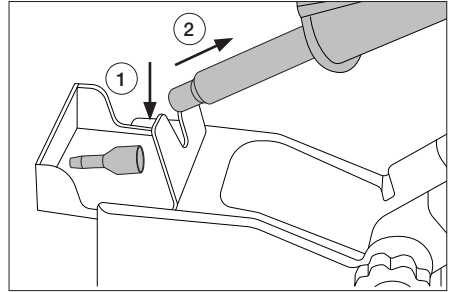

Compatible Nozzles

TET works with TE nozzles. Find the model that best suits your soldering needs in www.jbctools.com

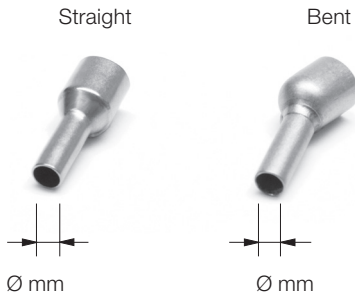

* Ref.	Shape	Size (mm)	Size (in)
* TN9209	Straight	Ø 3	Ø 0.12
* TN9208	Straight	Ø 4	Ø 0.16
* TN9080	Straight	Ø 5	Ø 0.20
TN9787	Bent	Ø 3	Ø 0.12
TN9785	Bent	Ø 4	Ø 0.16
TN9782	Bent	Ø 5	Ø 0.20
TN8851	Bent	Ø 3 / 45°	Ø 0.12 / 45°
TN8905	Bent	Ø 4 / 45°	Ø 0.16 / 45°
TN9561	Bent	Ø 5 / 45°	Ø 0.20 / 45°

* Supplied with TE.

Replacing the Heating Element

Only perform this operation when the element is cold and the unit is disconnected from the mains.

1. Loosen the screw.
2. Pull the heating element away from the handle.
3. Connect the new heating element, ensuring it is pushed all the way in.
4. Tighten the screw.

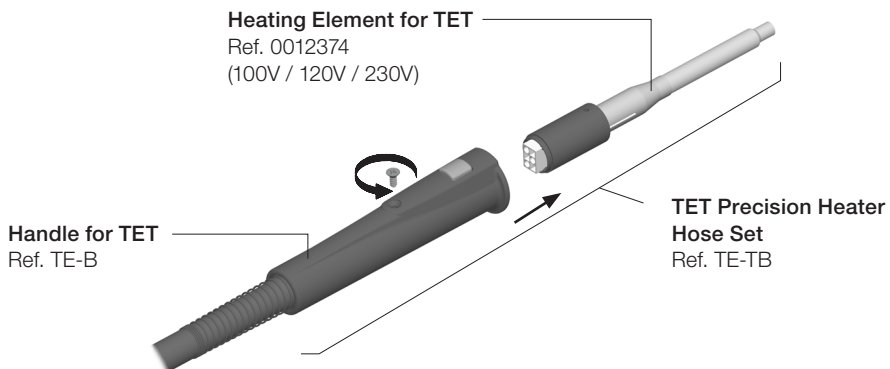

Changing the TET Heater Hose Set

1. Ensure that the tool is turned off.
2. Use a spanner to unscrew the nut.
3. Make sure that the new heater tube fits into the grooves in the socket.
4. Tighten the screw.

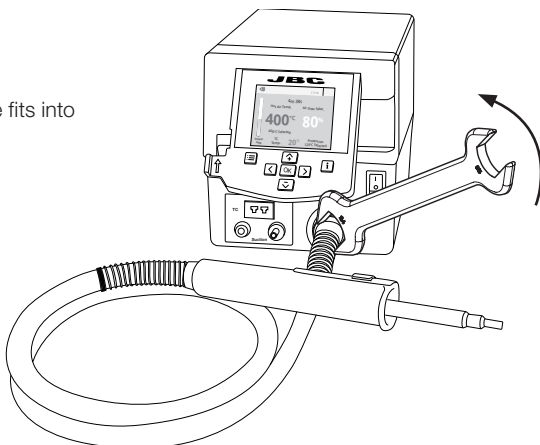

Maintenance

Before carrying out maintenance, always allow the equipment to cool down.

- Clean the station screen with a glass cleaner or a damp cloth.
- Use a damp cloth to clean the casing and the tool. Alcohol can only be used to clean the metal parts.
- Periodically check that the metal parts of the tool and stand are clean so that the station can detect the tool status.
- Periodically check all cables and tubes.
- Replace a blown fuse as follows:

Clean periodically



1. Pull off the fuse holder and remove the fuse. If necessary use a tool to lever it off.

2. Insert the new fuse into the fuse holder and return it to the station.

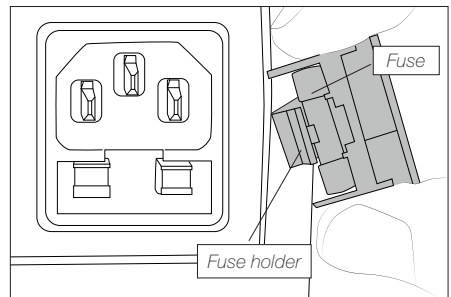
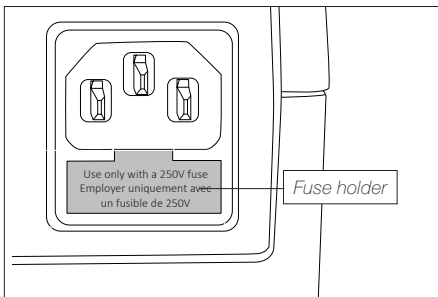

- Replace any defective or damaged pieces. Use original JBC spare parts only.
- Repairs should only be performed by a JBC authorized technical service.

Safety



It is imperative to follow safety guidelines to prevent electric shock, injury, fire or explosion.

- Do not use the units for any purpose other than soldering or rework. Incorrect use may cause fire.
- The power cord must be plugged into approved bases. Be sure that it is properly grounded before use. When unplugging it, hold the plug, not the wire.
- Do not work on electrically live parts.
- The tool should be placed in the stand when not in use in order to activate the sleep mode. The soldering tip or nozzle, the metal part of the tool and the stand may still be hot even when the station is turned off. Handle with care, including when adjusting the stand position.
- Do not leave the appliance unattended when it is on.
- Do not cover the ventilation grills. Heat can cause inflammable products to ignite.
- Avoid flux coming into contact with skin or eyes to prevent irritation.
- Be careful with the fumes produced when soldering.
- Keep your workplace clean and tidy. Wear appropriate protection glasses and gloves when working to avoid personal harm.
- Utmost care must be taken with liquid tin waste which can cause burns.
- This appliance can be used by children over the age of eight and also persons with reduced physical, sensory or mental capabilities or lack of experience provided that they have been given adequate supervision or instruction concerning use of the appliance and understand the hazards involved. Children must not play with the appliance.
- Maintenance must not be carried out by children unless supervised.

Specifications

TEQ

Precision Hot Air Station without Extractor Desk

Ref. **TESE-1QA** 100V-120V 50/60Hz. Input fuse: 8A. Rated current: 7A

Ref. **TESE-2QA** 230V 50/60Hz. Input fuse: 4A. Rated current: 3A

- Temperature selection: Room temp. 150 - 450 °C / 300 - 840 °F
- Nominal power: 300W
- Cool mode: T off. Used to blow air to room temperature
- Ambient operating temp.: 10 - 50 °C / 50 - 122 °F
- Air flow regulation: 2 - 17 SLPM
- Vacuum: 30% / 228 mmHg / 9 inHg
- Connectors: USB station-PC
Robot RS232
P-005 Pedal
- Control Unit Dimensions: 230 x 148 x 160 mm
(L x W x H) 9.06 x 5.83 x 6.30 in
- Total Net Weight: 3.44 kg / 7.58 lb
- Total Package Dimensions/Weight: 474 x 368 x 195 mm / 4.41 kg
(L x W x H) 18.66 x 14.49 x 7.68 in / 9.72 lb

Complies with CE standards.

ESD protected.

JBC

Warranty

JBC's 2 year warranty covers this equipment against all manufacturing defects, including the replacement of defective parts and labour.

Warranty does not cover product wear or misuse.

In order for the warranty to be valid, equipment must be returned, postage paid, to the dealer where it was purchased.

Get 1 extra year JBC warranty by registering here:
<https://www.jbctools.com/productregistration/>
within 30 days of purchase.



This product should not be thrown in the garbage.

In accordance with the European directive 2012/19/EU, electronic equipment at the end of its life must be collected and returned to an authorized recycling facility.



www.jbctools.com