

IT8211 Digital Control Electronic load

User 's Manual



WARNING

Safety Regulations

To avoid electrical shock, do not open the cabinet. Refer only to qualified personnel for service.

To avoid injuries, always disconnect power, discharge circuits, and remove external voltage sources before touching components.

KEEP AWAY FROM LIVE CIRCUITS.

We cannot accept responsibility for any direct or indirect financial damage or loss of profit that might occur when using the electronic load.

The instrument chassis and cover must be connected to an electrical ground.

Certification

We certify that this product met its published specifications at time of shipment from the factory.

Notice

The information contained in this document is subject to change without notice.

Warranty

This hardware product is warranted against defects in material and workmanship for a period of ONE year from date of delivery. IT8211 Electronic load for use with a hardware product and when properly installed on that hardware product, are warranted not to fail to execute their programming instructions due to defects in material and workmanship for a period of 90 days from date of delivery. During the warranty period our company will either repair or replace products which proved to be defective. Our company does not warranty that the operation for the software firmware or hardware shall be uninterrupted or error free. For warranty service, with the exception of warranty options, this product must be returned to a service facility designated by our company. Customer shall prepay shipping charges by (and shall pay all duty and taxes) for products returned to our place for warranty service. Our company shall pay for return of products to Customer.

Limitation of Warranty

The foregoing warranty shall not apply to defects resulting from improper or inadequate maintenance by the customer, customer-supplied software or interfacing, unauthorized modification or misuse, operation outside of the environmental specifications for the product, or improper site preparation and maintenance.

Compliance Statements

Disposal of Old Electrical & Electronic Equipment (Applicable in the European Union and other European countries with separate collection systems)



The ITECH products you have purchased is subject to Directive 2002/96/EC of the European Parliament and the Council of the European Union on waste electrical and electronic equipment (WEEE) , and in jurisdictions adopting that Directive, is marked as being put on the market after August 13, 2005, and should not be disposed of as unsorted municipal waste. Please utilize your local WEEE collection facilities in the disposition of this product and otherwise observe all applicable requirements.

Safety Symbols



Connect it to safety earth ground using the wire recommended in the user's manual.



High voltage danger



The symbol on an instrument indicates that the user should refer to the operating instructions located in the manual.

About IT8211

**IT8211 digital control electronic load (60V/30A/ 150W)
High resolution and accuracy: 10mV/1mA, CV / CC/ CR work mode, short-test function, friendly interface, storage for 4*100 sets preset value. All these help you to achieve different complex test purpose easily.**

CC work mode

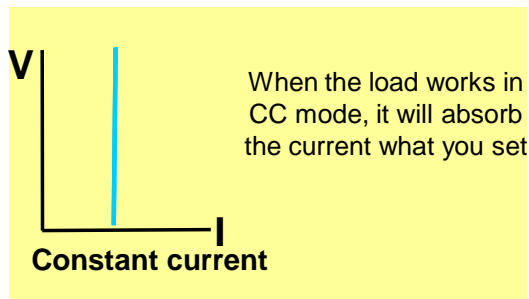

CV work mode

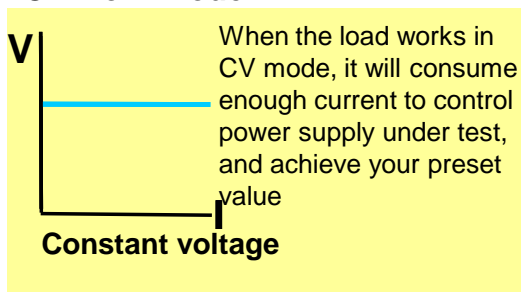

CR work mode

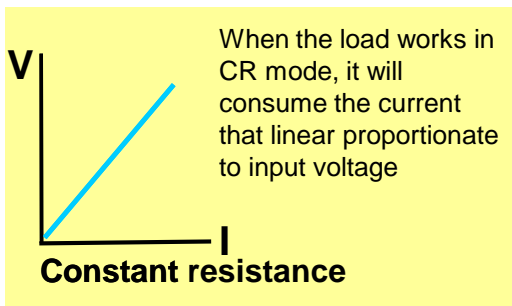

Attribute

- Digital control electronic load
- Full range 10mV /1mA resolution
- Very small size
- Highlight LED display
- Working mode: CC/CV/CR
- Very competitive price
- Input on/off control
- High reliability, OC/OV/OP/ protection
- Storage for 4*40 sets preset value
- Easily operated
- Programmable LIST mode: 25*4 sets

Panel layout

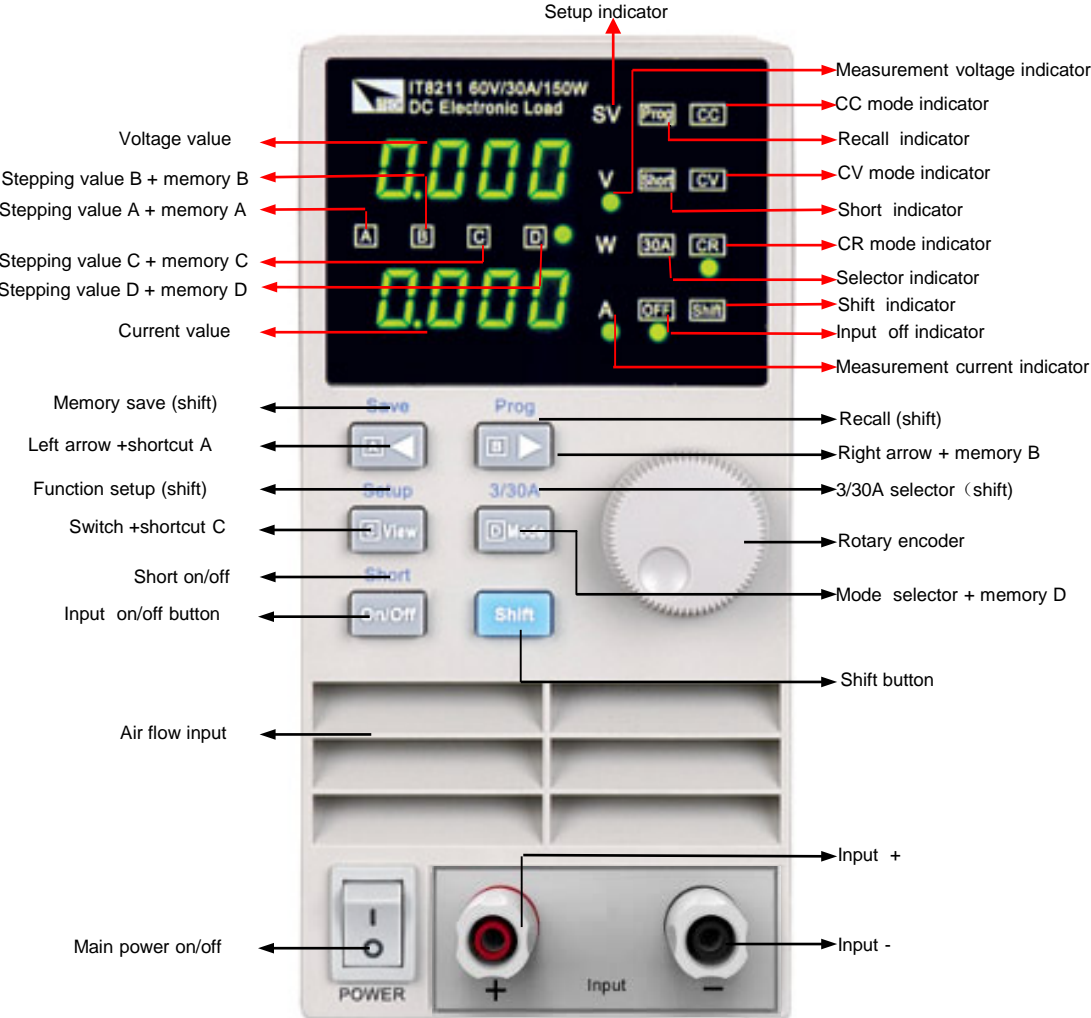

Quick Start

Check out

This instrument is carefully inspected before shipment. Upon receipt, please inspect the instrument for damage that might occurred in transit, if any sign of damage, please contact the vendor.

Work voltage of load has two type: 110V AC or 220V AC. Please switch the correct line voltage accordance to the voltage in you area by toggle the switch on the rear panel

If the above 2 points are right, please power on the electronic load.

current set

Press **[D Mode]** key to turn on the CC light, and now the load work in CC mode, you can set current value. For example, press **[A◀]** **[B▶]** key, move the cursor to the position **[A]**, screw the knob, the current value will rise or decline 1A. After setting value, press **[On/Off]** key to make load start to work.

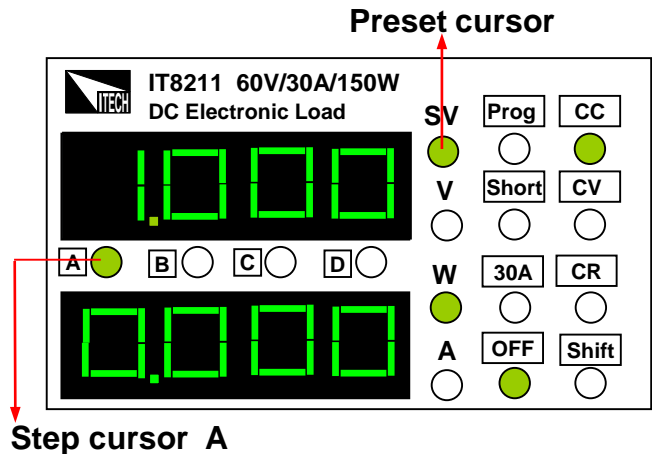

Voltage set

Press **[D Mode]** key to turn on the CV light, and now the load work in CV mode, you can set voltage value. For example, press **[A◀]** **[B▶]** key, move the cursor to the position **[B]**, screw the knob, the voltage value will rise or decline 1V. After setting value, press **[On/Off]** key to make load start to work.

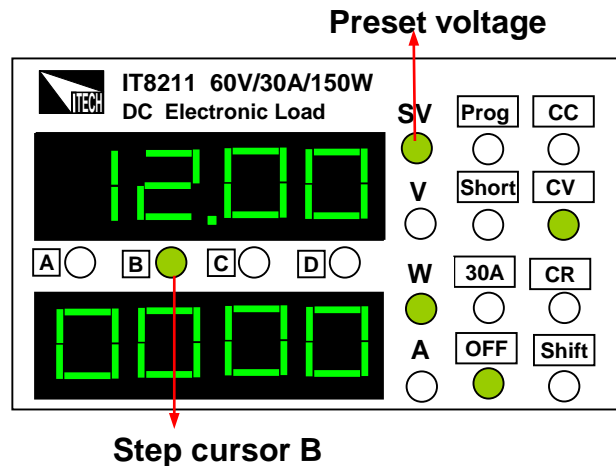

Resistance set

Press **[D Mode]** key to turn on the CR light, and now the load work in CR mode, you can set resistance value. For example, press **[A◀]** **[B▶]** key, move the cursor to the position, screw the knob, the resistance value will rise or decline. After setting value, press **[On/Off]** key to make the load start to work.

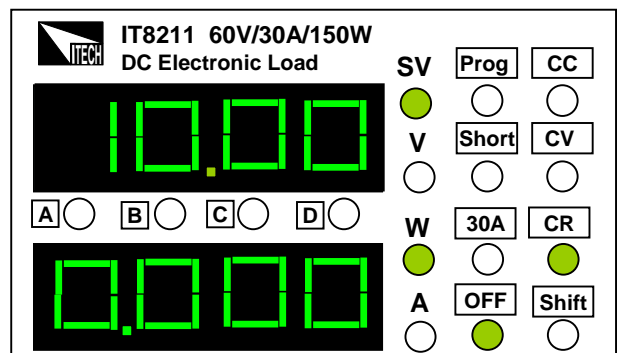

Input on/off

Press **On/Off** key at the front panel to toggle the input on/off. Disable the input (zero current) does not affect the programmed setting. The input will return to the previously programmed values when the input is enabled again.

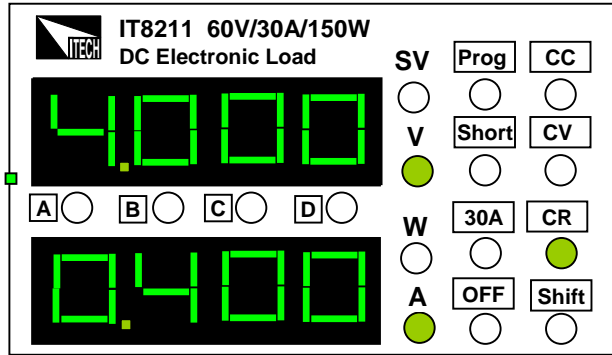

view function

The electronic load usually display the actual voltage and current value, and then press **C View** key, the light will change V to SV, the load display the preset voltage, current or resistance value and the actual power, and press **C View** key, it will be back to show an actual value.

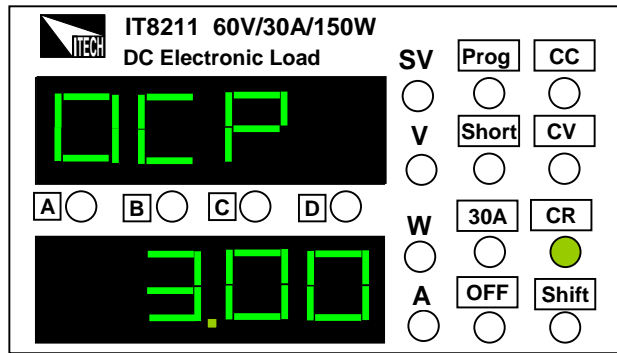

OCP function

Press **Shift** key, and then press **C View** (Setup) key, OCP LED will be lit.

Use **A** **B** key and knob to set OCP value.

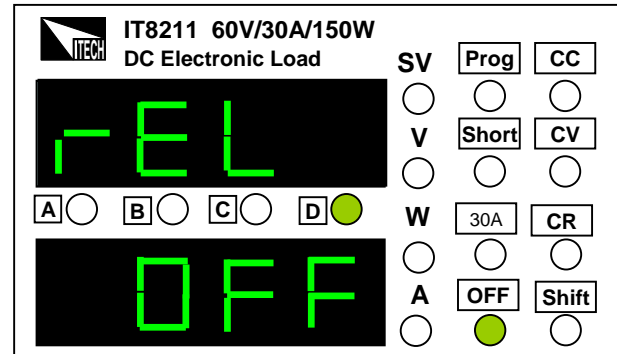

NOTE

The input of electronic load will be turned off automatically if the OCP value is less than the actual current value. Default OCP setting is 30A,

Real-time reveal (REL)

After setting OCP, press **C View** to enter the REL setting, use the knob to select ON/OFF. ON means the REL function is turn on; OFF means the REL function is turn off. Press **C View** to confirm.

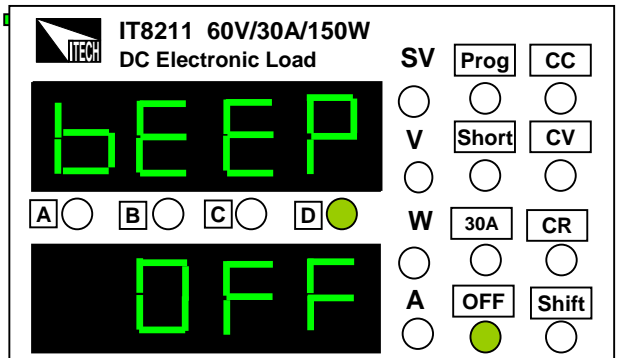

Key sound (BEEP)

After setting REL, Press **C View** to enter the BEEP setting. Use the knob to turn the knob sound ON or OFF.

Set address (ADD)

After setting BEEP, Press **C↵** to enter the ADD setting, use the cursor key **A◀** **B▶** and the knob to enter address to store settings. ADD range: 0~31, press **C↵** to confirm.

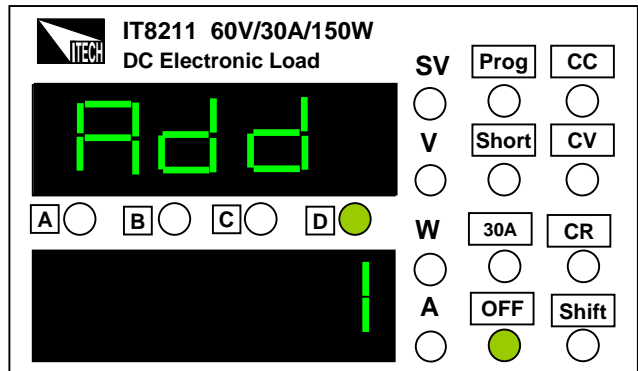

Set group (GRP)

After setting the OCP value, press **C View** to enter GRP setting, use the cursor key **A◀** **B▶** and the knob to select store group. There are 40 groups to be selected, each group can store 4 group current, voltage or resistance values. Press **C View** key to confirm and exit setup mode.

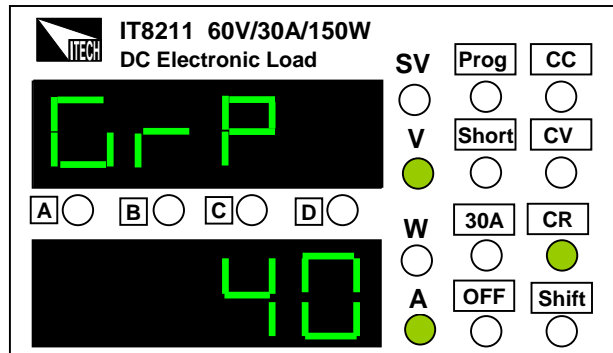

Store Operation

After the voltage or current value has been set, press **Shift** and **A◀** (**Save**) key, the cursor **A** **B** **C** **D** will wink together. Choose **A◀** or **B▶** or **C View** or **D Mode** key to save the preset value.

Recall Operation

Press **Shift** and **B▶** (**Prog**) key, **Prog** will be lighted up, that means you can recall the parameter from the store group. Chose **A◀** or **B▶** or **C View** or **D Mode** key to recall the parameter which has been saved.

When the electronic load is on recall operation, **A◀** **B▶** **C View** **D Mode** keys are disabled, they only can be used with **Shift** key. If you want to exit recall function, please press **Shift** and **B▶** (**Prog**) key.

Current range switch (3/30 A)

Press **Shift** key, then press **D Mode** key, **30A** light will be lit, that means current in high range:30A ,you can set the current from 0 to 30A.

Press **Shift** key, then press **D Mode** key, **30A** light will be turned off. You can set the current from 0 to 3A .

current resolution in high current range is 10mA, current resolution in low current range is 1mA.

Short-circuit operation

IT8211 loads can simulate a short circuit at its input by turning the load on with, full-scale current. The short circuit can be toggled on/off at the front panel using the **Shift** + **On/Off** . Short operation does not infect the operation setting current value, when short operation is in off state ,load back to the original setting state.

The actual value of the electronic short is dependent on the mode and current range that are active when the short is turned on. In CC,CW and CR mode, the max short-circuit current value is 1.2 time of the current range. In CV mode, short-circuit operation is same as the operation of setting CV to 0V.

Check and reset the voltage ,current and resistance value

The electronic load usually display the actual voltage and current value. If you want to check or reset the preset voltage, current and resistance value, screw Knob  or press **A◀** or **B▶** key, the bright will change V to SV . The preset on the LED will wink for 3 second. If not reset a value ,it will recover to show an actual value.

Trouble shooting hint

If the input is disabled

1. check if the voltage or current preset value is zero, if so, please set the voltage or current value once again.
2. check if the OCP indicator is lit, if so, set OCP value properly.

LIST function

The function helps you test the features of power supply to be measured when with different load easily.

Power on IT8211 with pressing the key  (Prog) at the same time. The normal function of all keys are forbidden, only list function are permitted.

Press  and  keys to enter the list edit menu:

STEP allow you to choose and edit the step you want, range: 0-99;

TYPE allow you to choose the working mode (1/2/3, which is corresponded to CC/CV/CR mode);

DATA allow you set the mode value, e.g. you set TYPE as 1(CC mode), so the value to be set here is current value;

DT is the delay time, range; 0.4S-25S;

HV set the up limit of the input voltage;

LV set the low limit of the input voltage;

HA set the up limit of the input current;

LA set the low limit of the input current.



The menu is set in cycle, enter the next step setting directly. Press  +  to exit (the present step won't be saved).

NOTE: the unit saves the list file in four group automatically: 0-24 steps in A key, 25-49 steps in B key, 50-74 steps in C key, 75-99 steps in D key. Set the last step CC/OA if the total steps is less than 25. if you press A key, it will run from step 0, if you press B key, it will run from step 25, if you press C key, it will run from 50, if you press D key, it will run from step 75.

Operation:

Press power on button +  key to power on the unit and enter the LIST mode.

Press  +  to enter list edit menu.

Use the cursor keys   and the Knob  to set the step.

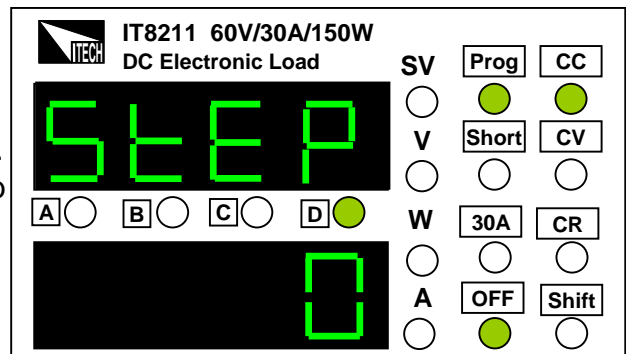

2) Press **[C View]** key to enter TYPE setting. Use the knob to switch the working mode, CC mode, CV mode, CR mode.

Right figure set TYPE as CC mode.

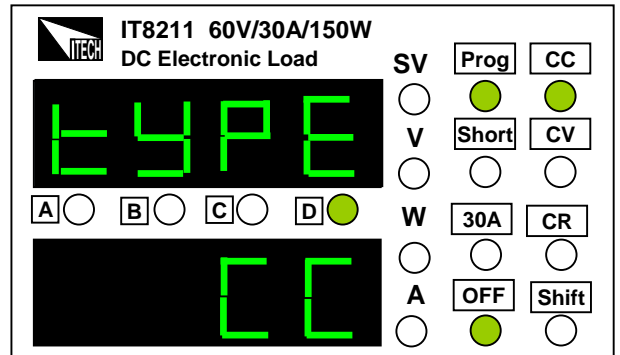

3) Press **[C View]** key to enter DATA setting. Use cursor keys **[A◀]** **[B▶]** and the knob to set the mode value. Right figure set DATA as 1.000A

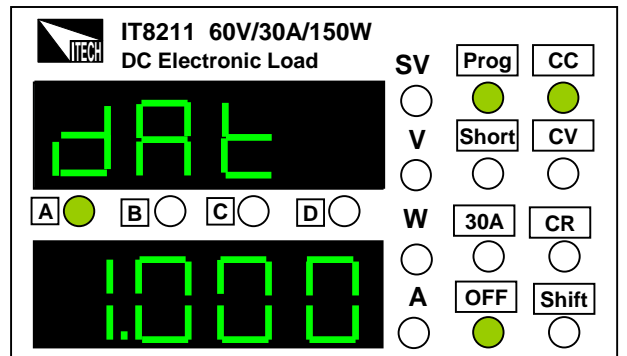

4) Press **[C View]** key to enter Delay Time setting, use cursor keys **[A◀]** **[B▶]** and the knob to set the delay time, the range of a single step is 0.4s to 25s. Right figure set the DT as 5s.

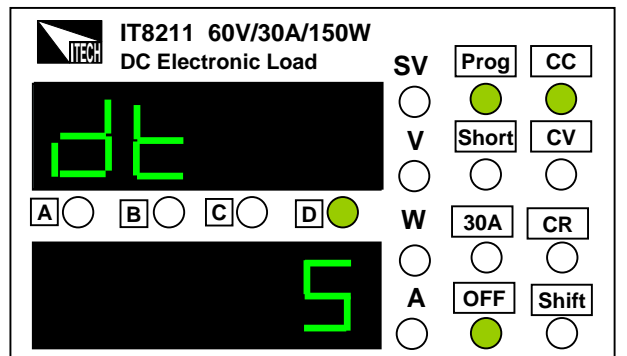

5) Press **[C View]** key to enter High Voltage setting, use cursor keys **[A◀]** **[B▶]** and the knob to set the high limit of the input voltage. Right figure set the HV as 60.00V.

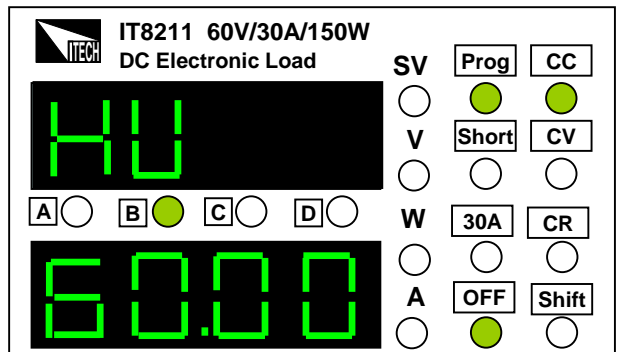

6) Press **C View** key to enter Low Voltage setting. use cursor keys **A◀** **B▶** and the knob  to set the low limit of the input voltage. Right figure set the Low Voltage as 0.00V.

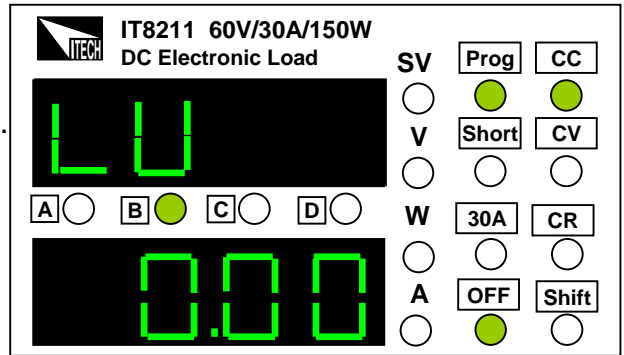

7) Press **C View** key to enter High Current setting, use cursor keys **A◀** **B▶** and the knob  to set the high limit of the input current. Right figure set the High Current as 30.00A.

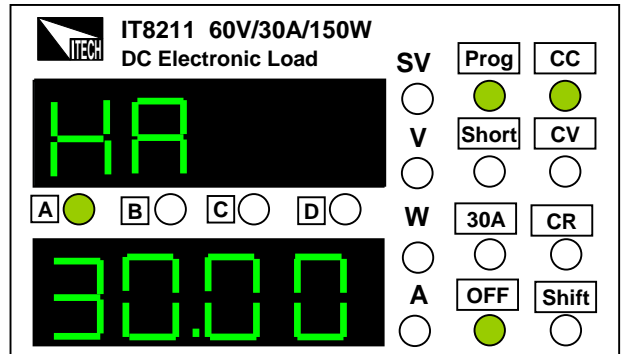

8) Press **C View** key to enter Low Current setting, use cursor keys **A◀** **B▶** and the knob  to set the low limit of the input current. Right figure set the Low Current as 0.00A.

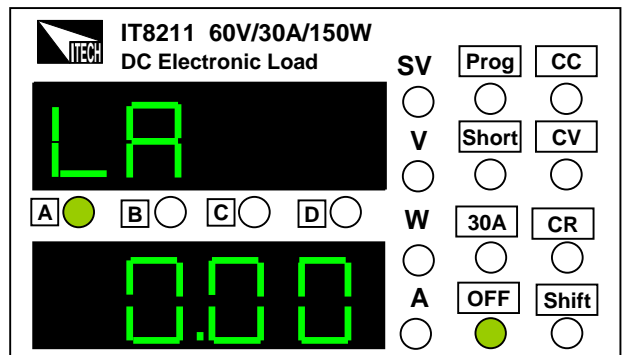

9) Repeat step 1 settings, in turn set 5 steps:
 1/2/2V/5S/60V/0V/30A/0A;
 2/3/10Ω/5S/60V/0V/30A/0A;
 3/1/2A/5S/60V/0V/30A/0A;
 4/1/0A/5S/60V/0V/30A/0A (because the total steps is less than 25 steps, so the last step should be CC/0A.)

10) Press **C View** key to finish the setting, and press **C View** and **Shift** keys to exit the edit menu, the instrument will save the setting automatically.

Press **A◀** key to run the list file.

NOTE: if the total steps is more than 25, e.g. 30 steps. press **A◀** key to run the previous 25 steps, press **B▶** key to run the last 5 steps.

11) When past the test successfully, the instrument display as normal; when fail to pass the test, the instrument will display as right figure, display wrong step, alarm 3 second and shut the input. Right figure show the condition the first step not pass.

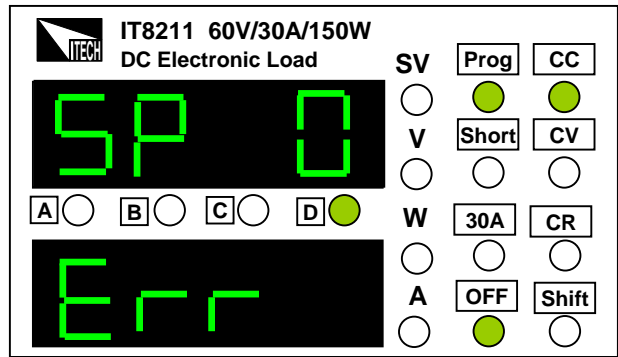

Step value for Cursor Position

Cursor position	Voltage Stepping values	Current Stepping values		Resistance stepping values	
		Area	Stepping values	Area	Stepping values
A	10V	0-3A	1A	0.1-10Ω	1Ω
				10-99Ω	10Ω
		0-30A	10A	100-999Ω	100Ω
				1000-4000Ω	1000Ω
B	1V	0-3A	0.1A	0.1-10Ω	0.1Ω
				10-99Ω	1Ω
		0-30A	1A	100-999Ω	10Ω
				1000-4000Ω	100Ω
C	0.1V	0-3A	0.01A	0.1-10Ω	0.01Ω
				10-99Ω	0.1Ω
		0-30A	0.1A	100-999Ω	1Ω
				1000-4000Ω	10Ω
D	0.01V	0-3A	0.001A	0.1-10Ω	0.001Ω
				10-99Ω	0.01Ω
		0-30A	0.01A	100-999Ω	0.1Ω
				1000-4000Ω	1Ω

Technique parameter

Parameter		IT8211	
Input ratings, (0 ~ 40 °C)	Voltage	0 ~ 60V	
	Current	1mA ~ 30A	
	Power	150W	
Load Regulation	Range	Accuracy	Resolution
	0~10V	$\pm(0.05\%+0.1\%FS)$	1mV
	0~60V	$\pm(0.05\%+0.1\%FS)$	10mV
	0~3A	$\pm(0.1\%+0.1\%FS)$	1mA
	0~30A	$\pm(0.1\%+0.15\%FS)$	10mA
CV Mode Regulation	0.1~60V	$\pm(0.05\%+0.1\%FS)$	10mV
CC Mode Regulation	0~3A	$\pm(0.1\%+0.1\%FS)$	1mA
	0~30A	$\pm(0.1\%+0.15\%FS)$	10mA
CR Mode Regulation (input voltage $\geq 10\%$ full range, input current $\geq 10\%$ full range)	0.1~10 Ω	$\pm(1\%+0.8\%FS)$	0.001 Ω
	10~99 Ω	$\pm(1\%+0.8\%FS)$	0.01 Ω
	100~999 Ω	$\pm(1\%+0.8\%FS)$	0.1 Ω
	1K~4K Ω	$\pm(1\%+0.8\%FS)$	1 Ω
Current Measurement	0~3A	$\pm(0.1\% + 0.1\%FS)$	1mA
	0~30A	$\pm(0.1\% + 0.15\%FS)$	10mA
Voltage Measurement	0~10V	$\pm(0.05\% + 0.1\%FS)$	1mV
	0~60V	$\pm(0.05\% + 0.1\%FS)$	10mV
Power Measurement (input voltage $\geq 10\%$ full range, input current $\geq 10\%$ full range)	0~10W	$\pm(1\%+0.5\%FS)$	1mW
	10~99W	$\pm(1\%+0.5\%FS)$	10mW
	100~150W	$\pm(1\%+0.5\%FS)$	100mW
Dimension (W*H*D)	88*175*282 (mm)		



YOUR POWER TESTING SOLUTION



Contact US

Thank you for purchasing ITECH products. If you have any doubt about this product, please contact us as follows.

1. Click www.itechate.com or scan the right two-dimensional code to visit the ITECH website.
3. Send E-mail to fae@itech.sh or dial the service hot-line in China: 4006025000
4. Select the most convenient contact method for further consultancy.

