

## Product

IT8700P Multi-channel Modular  
Programmable DC Electronic Load



# IT8700P Multi-channel Modular Programmable DC Electronic Load

## APPLICATIONS

- ATE Test System
- Civil Aviation
- Solar Cell
- Communication Test
- LED

*Your Power Testing Solution*

# IT8700P Multi-channel Modular Programmable DC Electronic Load



IT8700P series multi-channel modular programmable DC electronic load has been upgraded on the basis of IT8700, follow the original modular design. A single frame can reach 8 channels, and extended frame can reach 16 channels. It is equipped with both front and rear terminals, which can meet various testing requirements of users.

Same as IT8700, IT8700P also has the functions of slope adjustment and waveform editing. Besides, IT8700P has increased the functions including maximum current limit, PLC setting and CV loop adjustment. Users can set the automatic test function in the upgraded 8 operating modes, which is convenient for fast and accurate testing on R&D and production lines. At the same time, IT8700P series has full protection such as OVP,OCP,OPP,OTP, etc., which can prevent damage or injury caused by miss operation or environmental factors.

## FEATURE

- Removable modules for easy system configurability
- Dual-channel module can display each channel data simultaneously
- Single frame up to max.8 channels, extended frame up to max.16 channels
- Dynamic power distribution function for dual channels
- Arbitrary selection of front/rear terminal
- Users can customize the left and right modules
- 8 operation modes: CC/CV/CR/CW/CV+CC/CR+CC/CW+CC/CV+CR(CR-LED)
- CV loop speed is adjustable to match different power supplies
- High resolution and accuracy up to 0.1mV/0.01mA
- Measurement of short-circuit peak current and peak voltage
- Voltage and current measurement, up to 50kHz
- Adjustable current rise/fall slope
- Simulate various waveforms with load under List mode
- Up to 25kHz dynamic mode, 100kHz List mode setting
- Automatic test function can automatically determine whether the test results exceed the set specifications
- Simultaneously perform multiple sets of electronic load modules
- OVP/OCP/OPP/OTP/anti-reverse protection
- Standar Lan/RS232/USB communication interface

\*For any GPIB interface option request , check with ITECH for availability.

Modules	Specification
IT8731P	80V/40A/200W
IT8732P	80V/60A/400W
IT8732BP	500V/20A/300W
IT8733P	80V/120A/600W
IT8733BP	500V/30A/500W
IT8722P	80V/20A/250W*2CH
IT8722BP	500V/15A/250W*2CH
IT8723P	80V/45A/300W*2CH

Main Frame	
IT8701P	Two-load module main control unit (including three interfaces)
IT8702P	Four-load module main control unit (including three interfaces)
IT8703P	Four-load module expansion unit

\*1: The total power of dual channel for IT8722P/IT8722BP is 300W, namely  $PCH1+PCH2 \leq 300W$   
Two channels working range ( $0W \leq PCH1/PCH2 \leq 250W$ ); Upper limit of two channels setting range ( $50W \leq PCH1/PCH2 \leq 250W$ )

\*2: IT8700P modules need to be configured with IT8702P main frame.

\*3: Interfaces of main frame : RS232, USB, LAN

# Your Power Testing Solution

## IT8700P Multi-channel Modular Programmable DC Electronic Load

### Load Terminals On Front Read Panel

IT8700P is equipped with both front binding post terminals and rear terminals. Both of them can be connected for testing. It meets different test requirements and helps to avoid operational errors as well, which lead to higher test efficiency. At the same time, IT8700P is only 4U in height, making it easy to be rack mounted, which is good for system integration.

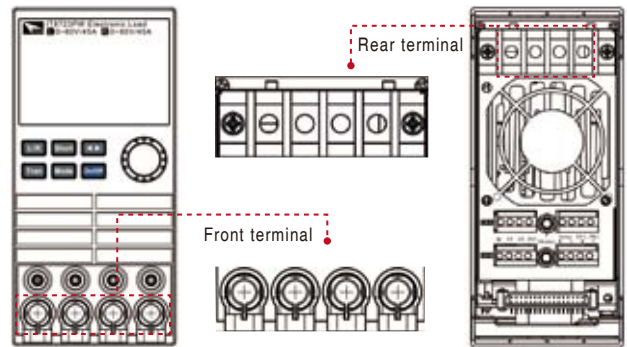

### Dynamic testing and control

The operation of dynamic load is periodically switched between the two levels. The power supply The adjustment rate and instantaneous response of the power supply monitor its output voltage waveform under the mixed changes of high and low current levels, continuous time and rise/fall rates.

The dynamic test function of IT8700P series can be divided into continuous mode, pulse mode and flip transfer mode.

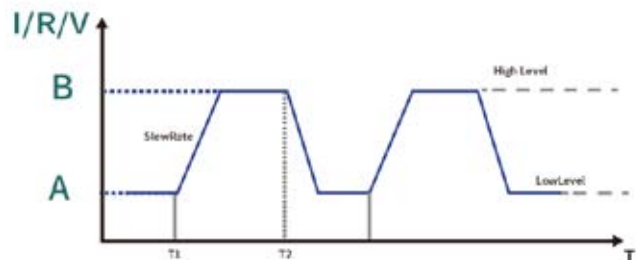

### 8 operation modes

Besides the four basic operation modes of CC /CV/CR/CW, there are additional 4 new compound operation modes included in IT 8700 P series : CV+CC/CR+CC/CW+CC/CV+CR(CR-LED). Under CV/CR/CW operation mode, the maximum current (I-Limit) is settable. This can effectively solve the problem of instantaneous surge current during testing and avoid the protection triggering, damage of the instrument or any other injury caused by possible miss operation or environmental factors.. So it can be used in various applications.

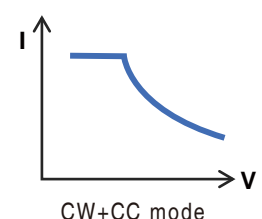
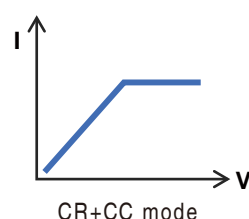
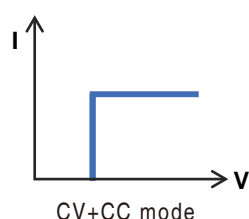
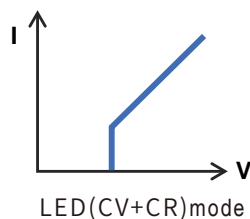
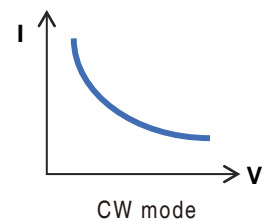
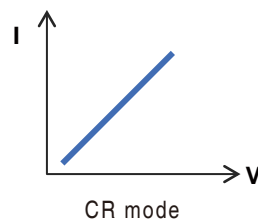
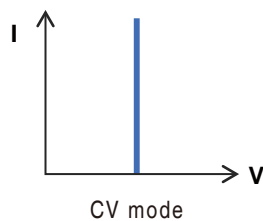
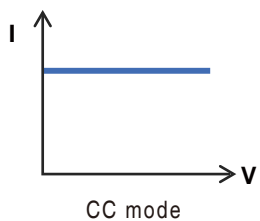

### Freely configurable modular system architecture

IT8700P adopts modular design, which has a high-performance microprocessor in every module and mainframe. It has high measurement speed because of parallel architecture. The mainframe controls each models synchronously and show the testing values in real time.

# Your Power Testing Solution

## IT8700P Multi-channel Modular Programmable DC Electronic Load

### Dynamic power distribution

The model of dual-channel IT8700P has dynamic power distribution function, which helps to save equipment purchasing cost. Different from traditional distribution mode, when the total power is not more than 300W and the single channel power is less than 250W, its power can be freely allocated to the two channels. The user can adjust the two-channel load power of IT8700P to the required power ratio according to the actual test requirements, so that the utilization can be optimized. For example, when you need 130W+170W or 50W+250W dual-channel load, only a single IT8700P module can fulfill the test.

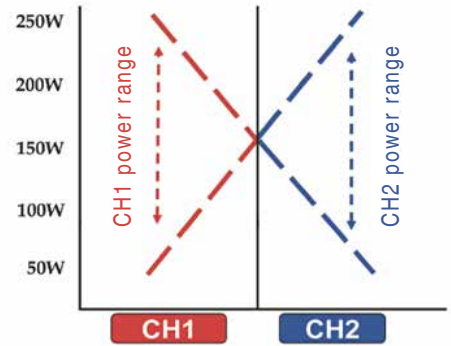

#### • Application

PC ATX 6-channel power supply test  
-Only 3 IT8700P modules needed

#### Recommended solution

- IT8722P module 1: +12V1DC (250W) / -12VDC (50W)
- IT8722P module 2: +12V2 DC (250W) / +5V SB (50W)
- IT8722P module 3: +5VDC (150W) / +3.3VDC (150W)

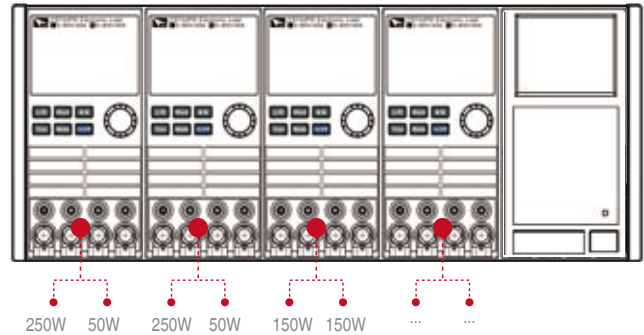

\* When the total power is not more than 300W and the single channel power is less than 250W, its power can be freely allocated to the two channels.

### Peak voltage measurement (Vpk)

When measuring the dynamic current of a switching power supply, an oscilloscope was usually necessary to capture the instantaneous voltage and current waveforms and obtain Vpk+ and Vpk- accordingly. But with digital data acquisition function, IT8700P can directly obtain the Vpk+ and Vpk- values without an oscilloscope.

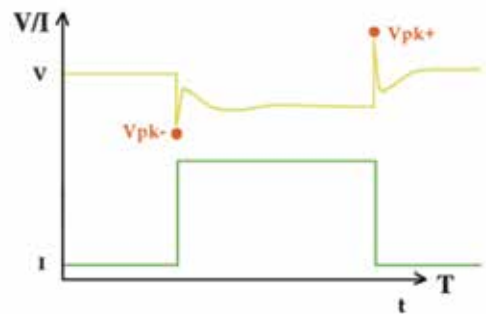

### Fast measurement of I-V characteristic curve

The voltage and current measurement of IT8700P is fast (up to 50kHz). It can be applied to various testing applications such as charging piles, automotive electronics; renewable energy and so on.



### List function, up to 100kHz

Compared with the dynamic mode, the LIST mode can complete more complex and arbitrary current modes at a high speed instead of the simple double-level changes, so IT8700P can realistically fulfill multi-level load precision tests than other loads. Its built-in waveform generator can simulate multiple waveforms under LIST mode. IT8700P can store 55X7 sets of files to simulate various real loading conditions. In addition, each module can operate independently or synchronously, which means that each module can execute its own timing independently and start working simultaneously.

#### • Application -Loading test

In the actual test, the product manufacturer tends to load at different current level, such as at 25%, 50%, 75%, 100% of the full-range current, to evaluate whether the value of the voltage fluctuation meets the design purpose. IT8700P can simulate the various complex states of the product in actual working conditions which helps to analyze the performance of the product and then improve it accordingly. IT8700P is especially suitable for complex application environments such as electronic product development, aging of production line, and quality inspection.

### Adjustable rise/fall slope

IT8700P has a built-in current slope adjustment loop, users can adjust current rise/fall speed according to different test requirements. Under CC mode, you can set the current rise/fall slope (0.0001-2.5A/7.5A/us)

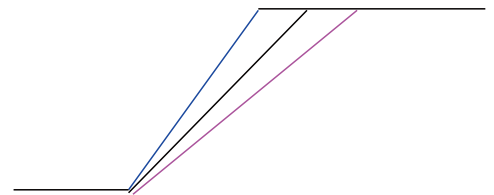

### Time measurement

IT8700P has powerful and accurate measurement function, the measurement range is 0.1ms -100,000s. This feature can be applied to battery discharge test, super capacitor discharge

Electrical time measurement, fuse and circuit breaker trip time measurement, ATX power supply voltage rise time measurement, etc.

#### • Application -Battery discharge test

IT8700P can display battery test mode, users can set the cut-off condition of battery discharge on the front panel easily. The user can complete the automatic battery charge and discharge test with a simple button operation. For example: when the battery voltage is lower than the first voltage value set by the user, the internal timer of the IT8700P will automatically count, and the timer will not stop counting until the battery voltage drops to the second set voltage.

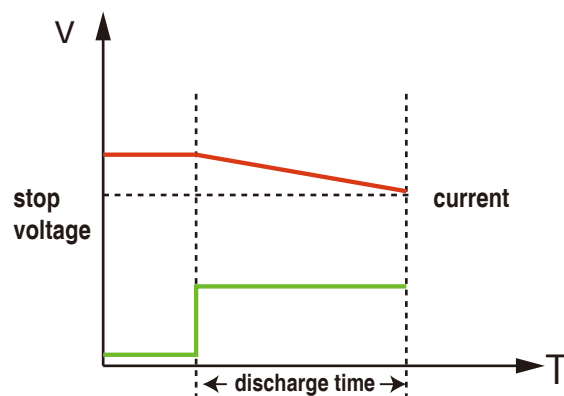

# Your Power Testing Solution

## IT8700P Multi-channel Modular Programmable DC Electronic Load

### IT8722P/22BP/23P Specification

		IT8722P <sup>18</sup>		IT8722BP <sup>18</sup>		IT8723P <sup>18</sup>	
Rated parameter (0~40 C)	Input voltage	0~80V		0~500V		0~80V	
	Input current	0~20A		0~15A		0~45A	
	Input power	250W <sup>*1</sup>		250W <sup>*1</sup>		300W	
	Channels	2		2		2	
	Min operating voltage	0.15V/3A	1.0V/20A	0.8V/3A	4.0V/15A	0.14V/4.5A	1.4V/45A
CV mode	Range	L: 0~18V; H: 0~80V		0.1~50V	0.1~500V		L: 0~18V; H: 0~80V
	Resolution	L: 1mV; H: 10mV		L: 1mV; H: 10mV		L: 1mV; H: 10mV	
	Accuracy	±(0.05%+0.025%FS)		±(0.05%+0.05%FS)		±(0.05%+0.025%FS)	
CC mode	Range	0~3A	0~20A	0~3A	0~15A	0~4.5A	0~45A
	Resolution	L: 0.1mA; H: 1mA		L: 0.1mA; H: 1mA		L: 0.1mA; H: 1mA	
	Accuracy	±(0.05%+0.05%FS)		±(0.05%+0.05%FS)		±(0.05%+0.05%FS)	
CR mode <sup>2</sup>	Range	L: 0.05Ω~10Ω; H: 10Ω~7.5KΩ		0.3Ω~10Ω	10Ω~7.5KΩ		L: 0.05Ω~10Ω; H: 10Ω~7.5KΩ
	Resolution	16bit		16bit		16bit	
	Accuracy	0.01%+0.08S <sup>*3</sup> ; H: 0.01%+0.0008S		0.01%+0.08S <sup>*3</sup> ; H: 0.01%+0.0008S		0.01%+0.08S <sup>*3</sup> ; H: 0.01%+0.0008S	
CP mode <sup>5</sup>	Range	250W <sup>*4</sup>		250W <sup>*4</sup>		300W	
	Resolution	10mW		10mW		10mW	
	Accuracy	±(0.2%+0.2%FS)		±(0.2%+0.2%FS)		±(0.2%+0.2%FS)	
CC mode							
Dynamic mode	T1&T2	20μS~3600S / Res: 1μS		20μS~3600S / Res: 1μS		20μS~3600S / Res: 1μS	
	Accuracy	5μS±100ppm		5μS±100ppm		5μS±100ppm	
	Rise / fall slope <sup>6</sup>	0.0001~0.2A/μS <sup>*3</sup>	0.001~1.6A/μS	0.0001~0.1A/μS	0.001~0.5A/μS	0.0001~0.25A/μS <sup>*3</sup>	0.001~2.5A/μS
	Min rise time <sup>*7</sup>	≐10μS		≐20μS		≐12μS	
Measuring range							
Voltage readback value	Range	0~18V	0~80V	0~50V	0~500V	0~18V	0~80V
	Resolution	L: 0.1 mV; H: 1mV		L: 1 mV; H: 10mV		L: 0.1 mV; H: 1mV	
	Accuracy	±(0.025%+0.025%FS)		±(0.025%+0.025%FS)		±(0.025%+0.025%FS)	
Current readback value	Range	0~3A	0~20A	0~3A	0~15A	0~4.5A	0~45A
	Resolution	L: 0.01mA; H: 0.1mA		L: 0.01mA; H: 0.1mA		L: 0.1mA; H: 1mA	
	Accuracy	±(0.05%+0.05%FS)		±(0.05%+0.05%FS)		±(0.05%+0.05%FS)	
Power readback value	Range	250W		250W		300W	
	Resolution	10mW		10mW		10mW	
	Accuracy	±(0.2%+0.2%FS)		±(0.2%+0.2%FS)		±(0.2%+0.2%FS)	
Protected range							
Over power protection	≐250W		≐260W		≐310W		
Overcurrent protection	≐3.3A	≐22A	≐3.3A	≐16.5A	≐5A	≐50A	
Over voltage protection	≐82V		≐530V		≐82V		
Over temperature protection	≐85°C		≐85°C		≐85°C		
Specification							
Short circuit	Current	≐3.3/3A	≐22/20A	≐3.3/3A	≐16.5/15A	≐5/4.5A	≐50/45A
	Voltage	0V		0V		0V	
	Resistance	≐50mΩ		≐260mΩ		≐30mΩ	
Input terminal impedance	300KΩ		≐1MΩ		300KΩ		
Size(mm)	82*183*573		82*183*573		82*183*573		
Weight	5KG		5KG		5KG		

\*1 Support dynamic distribution power, single channel, up to 300W total can reach max 250W.

\*2 Voltage/current input value is not less than 10% FS (FS is full scale).

\*3 Resistance read-back value range: ((1/(1/R+(1/R)\*0.01%+0.08),1/(1/R-(1/R)\*0.01%-0.08))

\*4 Support dynamic distribution power, single channel can reach max 250W.

\*5 Voltage/current input values are not less than 10% FS

\*6 Up/down slope: 10% ~ 90% current rising slope when from 0 to maximum current

\*7 The minimum rise time: 10% ~ 90% current rise time

\*8 IT8722P / IT8722BP are dual channel dynamic power allocation module, 2 channels' specification is the same.

\*This information is subject to change without notice notice

# Your Power Testing Solution

## IT8700P Multi-channel Modular Programmable DC Electronic Load

### IT8731P/32P/32BP/33BP/33P Specification

		IT8731P	IT8732P	IT8732BP	IT8733BP	IT8733P
Rated parameter (0-40°C)	Input voltage	0-80V	0-80V	0-500V	0-500V	0-80V
	Input current	0-40A	0-60A	0-20A	0-30A	0-120A
	Input power	200W	400W	300W	500W	600W
	Channels	2	2	2	2	2
CV mode	Min operating voltage	0.12V/4A   1.2V/40A	0.15V/6A   1.5V/60A	0.72V/3A   4.8V/20A	0.54V/3A   5.4V/30A	0.24V/12A   2.4V/120A
	Range	L: 0-18V; H: 0-80V	L: 0-18V; H: 0-80V	L: 0-18V; H: 0-500V	L: 0-18V; H: 0-500V	L: 0-18V; H: 0-80V
	Resolution	L: 1mV; H: 10mV	L: 1mV; H: 10mV	L: 1mV; H: 10mV	L: 1mV; H: 10mV	L: 1mV; H: 10mV
CC mode	Accuracy	±(0.05%+0.025%FS)	±(0.05%+0.025%FS)	±(0.05%+0.025%FS)	±(0.05%+0.025%FS)	±(0.05%+0.025%FS)
	Range	0-4A   0-40A	0-6A   0-60A	0-3A   0-20A	0-3A   0-30A	0-12A   0-120A
	Resolution	L: 0.1mA; H: 1mA	L: 0.1mA; H: 1mA	L: 0.1mA; H: 1mA	L: 0.1mA; H: 1mA	1mA   10mA
CR mode <sup>*1</sup>	Accuracy	±(0.05%+0.05%FS)	±(0.05%+0.05%FS)	±(0.05%+0.05%FS)	±(0.05%+0.05%FS)	±(0.05%+0.05%FS)   ±(0.1%+0.05%FS)
	Range	L: 0.05Ω-10Ω; H: 10Ω-7.5KΩ	L: 0.05Ω-10Ω; H: 10Ω-7.5KΩ	0.25Ω-10Ω   10Ω-7.5KΩ	0.2Ω-10Ω   10Ω-7.5KΩ	L: 0.05Ω-10Ω; H: 10Ω-7.5KΩ
	Resolution	16bit	16bit	16bit	16bit	16bit
CP mode <sup>*2</sup>	Accuracy	L: 0.01%+0.08S; H: 0.01%+0.0008S	L: 0.01%+0.08S; H: 0.01%+0.0008S	L: 0.01%+0.08S; H: 0.01%+0.0008S	L: 0.01%+0.08S; H: 0.01%+0.0008S	L: 0.01%+0.08S; H: 0.01%+0.0008S
	Range	200W	400W	300W	500W	600W
	Resolution	10mW	10mW	10mW	10mW	10mW
Dynamic mode	Accuracy	±(0.2%+0.2%FS)	±(0.2%+0.2%FS)	±(0.2%+0.2%FS)	±(0.2%+0.2%FS)	±(0.2%+0.2%FS)
	CC mode	CC mode				CC mode
	T1&T2	20μs-3600s / Res: 1μs	20μs-3600s / Res: 1μs	20μs-3600s / Res: 1μs	20μs-3600s / Res: 1μs	20μs-3600s / Res: 1μs
	Accuracy	5μs±100ppm	5μs±100ppm	5μs±100ppm	5μs±100ppm	5μs±100ppm
Voltage readback value	Rise / fall slope	0.0001   0.001 -0.2A/μs   -2A/μs	0.0001   0.001 -0.25A/μs   -2.5A/μs	0.0001   0.001 -0.1A/μs   -0.8A/μs	0.0001   0.001 -0.08A/μs   -0.8A/μs	0.001   0.01 -0.25A/μs   -2.5A/μs
	Min rise time	≈15μs	≈15μs	≈20μs	≈25μs	≈35μs
	Range	0-18V   0-80V	0-18V   0-80V	0-18V   0-500V	0-18V   0-500V	0-18V   0-80V
Current readback value	Resolution	L: 0.1 mV; H: 1mV	L: 0.1 mV; H: 1mV	L: 1 mV; H: 10mV	L: 1 mV; H: 10mV	L: 0.1 mV; H: 1mV
	Accuracy	±(0.025%+0.025%FS)	±(0.025%+0.025%FS)	±(0.025%+0.025%FS)	±(0.025%+0.025%FS)	±(0.025%+0.025%FS)
	Range	0-4A   0-40A	0-6A   0-60A	0-3A   0-20A	0-3A   0-30A	0-12A   0-120A
Power readback value	Resolution	L: 0.1mA; H: 1mA	L: 0.1mA; H: 1mA	L: 0.01mA; H: 0.1mA	L: 0.01mA; H: 0.1mA	L: 0.1mA; H: 1mA
	Accuracy	±(0.05%+0.05%FS)	±(0.05%+0.05%FS)	±(0.05%+0.05%FS)	±(0.05%+0.05%FS)	±(0.05%+0.05%FS)
	Range	200W	400W	300W	500W	600W
Protected range	Resolution	10mW	10mW	10mW	10mW	10mW
	Accuracy	±(0.2%+0.2%FS)	±(0.2%+0.2%FS)	±(0.2%+0.2%FS)	±(0.2%+0.2%FS)	±(0.2%+0.2%FS)
	Over power protection	≈210W	≈410W	≈310W	≈510W	≈610W
Specification	Overcurrent protection	≈4.4A   ≈44A	≈6.6A   ≈66A	≈3.3A   ≈22A	≈3.3A   ≈33A	≈13.2A   ≈132A
	Over voltage protection	≈82V	≈82V	≈530V	≈530V	≈82V
	Over temperature protection	≈85°C	≈85°C	≈85°C	≈85°C	≈85°C
Short circuit	Current	≈4.4/4A   ≈44/40A	≈6.6/6A   ≈66/60A	≈3.3/3A   ≈22/20A	≈3.3/3A   ≈33/30A	≈13.2/12A   ≈132/120A
	Voltage	0V	0V	0V	0V	0V
	Resistance	≈30mΩ	≈25mΩ	≈240mΩ	≈180mΩ	≈20mΩ
Input terminal impedance	300KΩ	300KΩ	1MΩ	1MΩ	300KΩ	
Size(mm)	82*183*573	82*183*573	82*183*573	82*183*573	82*183*573	
Weight	5KG	5KG	5KG	5KG	5KG	
AC Input	Voltage	220V ±10%/110V ±10%	220V ±10%/110V ±10%	220V ±10%/110V ±10%	220V ±10%/110V ±10%	220V ±10%/110V ±10%
	Frequency	50Hz/60Hz	50Hz/60Hz	50Hz/60Hz	50Hz/60Hz	50Hz/60Hz

\*1: Accuracy refers to specifications is %±n%FS (Full Scale) of set value

\*2: When input voltage and current value >= 10% of FS

\*This information is subject to change without notice

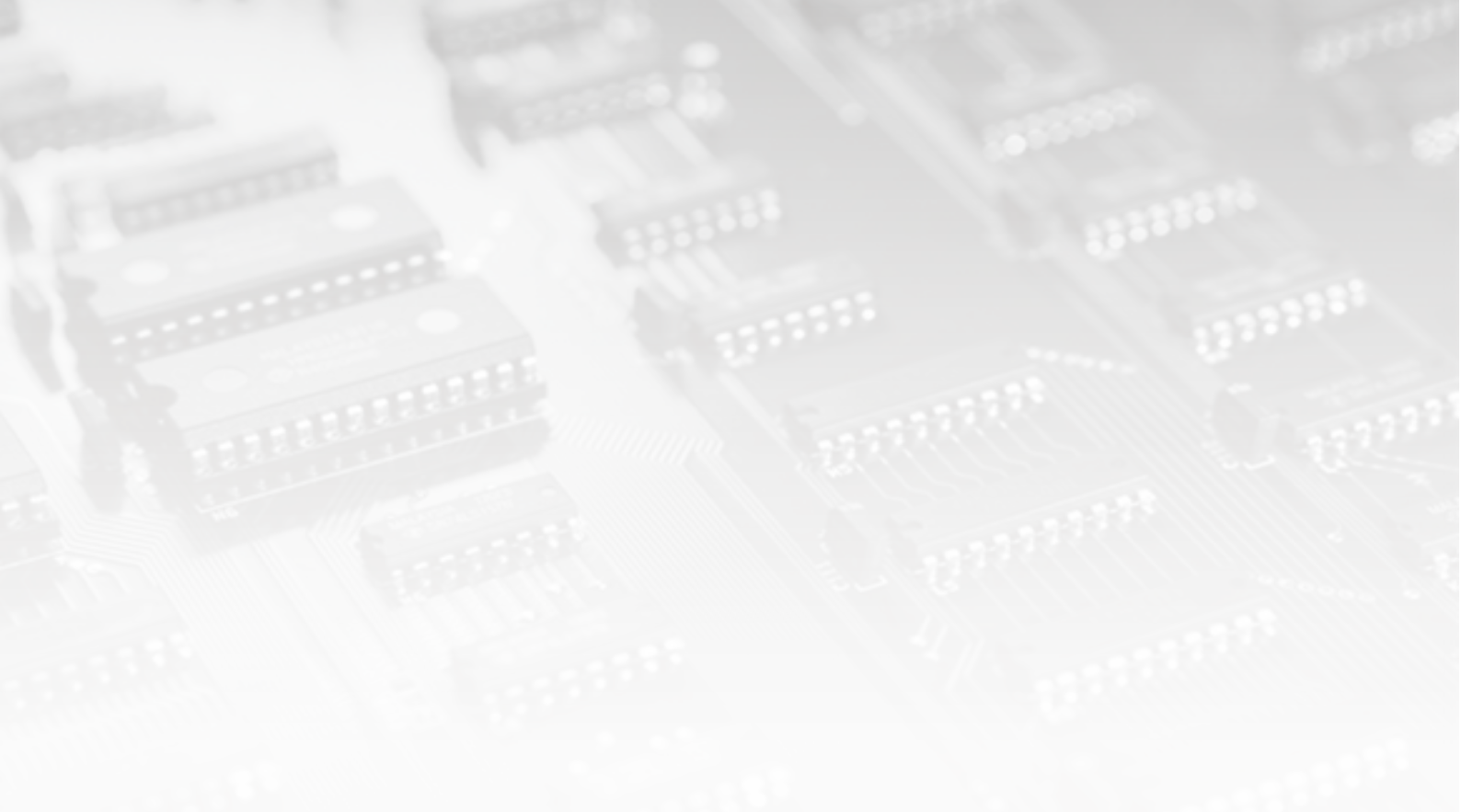

This information is subject to change without notice. For more information, please contact ITECH.

### Taipei

Add: No.918, Zhongzheng Rd., Zhonghe Dist., New Taipei City  
235, Taiwan  
Web: [www.itechate.com](http://www.itechate.com)  
TEL: +886-3-6684333  
E-mail: [info@itechate.com](mailto:info@itechate.com)

### Factory I

Add: No.108, XiShanqiao Nanlu, Nanjing city, 210039, China  
TEL: +86-25-52415098  
Web: [www.itechate.com](http://www.itechate.com)

### Factory II

Add: No.150, Yaonanlu, Meishan Cun, Nanjing city, 210039, China  
TEL: +86-25-52415099  
Web: [www.itechate.com](http://www.itechate.com)



ITECH Web



ITECH Facebook



ITECH LinkedIn